



ROYAL BOTANIC GARDENS,

KEW.

GARDEN LIBRARY.

Period.



0062624



ROYAL
BOTANIC
GARDENS
KEW

Digitized by the Internet Archive
in 2018 with funding from
BHL-SIL-FEDLINK

<https://archive.org/details/journalofhorticu3618hogg>

July 5, 1883.

THE

JOURNAL OF HORTICULTURE,

COTTAGE GARDENER,

AND

HOME FARMER.

A CHRONICLE OF COUNTRY PURSUITS AND COUNTRY LIFE, INCLUDING POULTRY, PIGEON,
AND BEE-KEEPING.

CONDUCTED BY

ROBERT HOGG, LL.D., F.L.S.

Established



in 1848.

VOLUME VI. THIRD SERIES.

JANUARY TO JULY, 1883.

LONDON

PUBLISHED FOR THE PROPRIETOR 171, FLEET STREET.

1883.

OFFICE

LONDON :
PRINTED AT THE JOURNAL OF HORTICULTURE OFFICE,
171, FLEET STREET.



TO OUR READERS.

WE have the pleasure of feeling that the volume of the *Journal of Horticulture* just completed has, as much as any of its predecessors, met with the approval of old and valued friends; many new and young readers have sought counsel in its pages, and new and able writers have joined us effectively in our work.

If we adduce testimony of this appreciation it will not be boastfully, but thankfully, inasmuch as our pages have been useful; and it enables us to acknowledge our obligations to those friends who have spontaneously expressed their goodwill.

The expressions of approval are voluminous, and we will transcribe at random, ceasing when our space is occupied.

Writing from Durham, a correspondent says:—

“I take this opportunity of thanking you for the many pieces of advice you have given me during the nineteen years I have subscribed to your Journal, and for the great assistance that advice has been to me.”

From Yorkshire we have the following:—

“I wish you to send me the Journal regularly. I am a new beginner as a head gardener, and there is much useful information to be had from its pages.”

Another young gardener in Kent observes:—

“I have got charge of a very pretty place, and my employer is a lover of all that is beautiful and curious in gardens. I shall be able to send you useful notes, and wish continued success to the dear old Journal.”

Yet another writes from Norfolk:—

“I took charge here in 1880, and found exhausted Vines and inferior fruit. By following the advice given in the Journal the old Vines have surprised me with fine bunches, and my employer tells me he has *black* Grapes for the first time for twenty years. With Mushrooms I failed; but the subject was made plain in your pages, and now I can grow them as well as I can grow Lettuces.”

One more young and rising man in Lincolnshire observes:—

“I beg to thank you and your staff for the information that has been given me. I consider the *Journal of Horticulture* the friend and counsellor of all who need assistance and are not above asking for it through its columns.”

From a lady we have this note:—

“I have so long profited by the study of your most interesting Journal, which has been my only teacher in the management of my garden, that I feel it ungrateful to add nothing for the use of others.”

This lady did add something, which we published, and we know it was of great use.

The next letter, and the last from which we can cite, is from one of the leading gardeners of Great Britain, who writes:—

“I hope you will not think I flatter you when I say that I like your paper better than any other gardenin periodical that I read. I had rather do without any of the others than the *Journal of Horticulture*.”

We do feel flattered by this testimony, and hope our friendly critic will not do without any of the gardening papers.

All who have aided us we thank cordially. *They* have the satisfaction of knowing they have not laboured in vain; *we* have reason to rejoice in the industry and ability of our excellent coadjutors: while to our readers we promise that our next volume shall be larger and, if possible, better than any we have had the privilege of issuing during a period of thirty-five years.

1872
1873
1874
1875
1876
1877
1878
1879
1880
1881
1882
1883
1884
1885
1886
1887
1888
1889
1890
1891
1892
1893
1894
1895
1896
1897
1898
1899
1900
1901
1902
1903
1904
1905
1906
1907
1908
1909
1910
1911
1912
1913
1914
1915
1916
1917
1918
1919
1920
1921
1922
1923
1924
1925
1926
1927
1928
1929
1930
1931
1932
1933
1934
1935
1936
1937
1938
1939
1940
1941
1942
1943
1944
1945
1946
1947
1948
1949
1950
1951
1952
1953
1954
1955
1956
1957
1958
1959
1960
1961
1962
1963
1964
1965
1966
1967
1968
1969
1970
1971
1972
1973
1974
1975
1976
1977
1978
1979
1980
1981
1982
1983
1984
1985
1986
1987
1988
1989
1990
1991
1992
1993
1994
1995
1996
1997
1998
1999
2000
2001
2002
2003
2004
2005
2006
2007
2008
2009
2010
2011
2012
2013
2014
2015
2016
2017
2018
2019
2020
2021
2022
2023
2024
2025

INDEX.

- ABIES ALBERTIANA**, 492
Abutilons, new varieties of, 46, 49
Abutilon and Hibiscus, cross between, bigener, 261
Acacia lophantha as standards, 364; *lineata*, 467
Acers polymorphum variegatum and *cratagifolium variegatum* (certificated), 437
Acids, making sulphuric and carbolic, 337
Aconites, planting Winter, 341
Adenandra fragrans, 447
Adiantum mundulum, 8; *novacaledonia*, 498
Agapetes buxifolia, 399
Allamanda Hendersonii, pruning, 59
Allium neapolitanum, 452, 512
Aloes, American, flowering at Oxford, 365
Alpine spoils, 387; plants, a prize collection of, 426
Amaryllis Acis and Achilles, 136; culture of, 171; at Chelsea, 219; George Gordon, A. F. Barron, and Dr. Ilogg, 220; Lady of the Lake, Wordsworth, Byron, and Teunyson, certificated, 261; Mr. Hibberd's lecture, 262; Adolphus Kent, 344
Amateur's holiday, 32, 177, 113; Aberdeen, 141
American Pomological Society, 363
Ammonia and phosphates, value of, 438
Amorphophallus campanulatus, 491
Anemone japonica, 46; in Covent Garden, 217
Angracum citratum at Dublin, 176; *A. articulatum* certificated, 261
Anisanthus splendens, 438
Annuals and border plants for cut flowers, 225; choice, raising, 285; selections of and sowing, 370
Anthurium ferriense certificated, 261; *splendidum*, 342
Ants and Rose buds, 526
Aphis, destroying black, 539
Apples—The Cobham, 83; in the north, 115; Warner's Seedling, certificated, 220; Australian, 375; cause of trees cankering, 444
Apricots, branches dying, 397, 423, 443; estimate of varieties, 397; preparing trees, 443; insects, 423; culture of under glass, 447; branches dying, 515
Aquatics, manure for, 54
Aralia gemma, 235
Arboriculture, revival of, parliamentary motions, 356
Arbour, a novel, 449
Arbutuses, propagating, 82
Ardisia crenulata, promoting flowering of, 101
Aroids, potting, 463
Articles, abstraction of, 216; manufactured, 235
Ashton Court, notes at, 324
Ash, the Mania, 503
Asparagus, sowing, 102; culture of under difficulties, 338; Kale, 359; early culture of, 445; special prizes for, 498; cutting and manuring, 523; fertilisers for, 549
Aubrietas, 33
Auriculas, treatment of, 24; notes on, 160; cross-breeding of, 169; top-dressing, select varieties, 194; "strains" of, 195; cross breeding and results, 200; "strains" of, Lovely Ann, 241; effects of frost on, 241; new varieties—Greenfinch, Monarch, Ajax, Miss Lodge, Adouls, and Carbuncle, 340; at South Kensington, 359, 379; Douglas's Conservative, 371; notes on culture, 388; showing and handicapping, 441; alpines, certificated—Homer, Dr. Denny, A. Lloyd, Rob Roy, Roysterer, Resplendens, delicata, 385; at Norwood Green and Manchester, 475; new varieties of, 488; proposed Scottish Society, 540
Australian Appies, 375
Azalea, Duchess of Albany, 34; renovating exhausted, 82; destroying thrips on, 209; potting and management of, 265; pruning, 288; *A. Antigonae*, 344; certificated—*Souvenir du Prince Napoleon*, 384; Baron N. de Rothschild, Princess Louise, Comte de Chambord, 385; Dr. Hermann Wiegel, 435; repotting, 436; hardy at Kew, 449; new at Ghent, 465; Nancy Waterer, 492; indica, hardy, 512
Azolla carolinensis, 224
- BALSAMS**, culture of, 119
Bause, Mr., 134
Beans, early for market, 61; forcing Kidney, 276; history of, bean-feasts, 520
Bedding plants, treatment in winter, 15; propagating, 134; propagating succulent, 184; planting and arranging, 456
Bedding-out, preparing for, 311
Bedford new public park, 217
Beeches, varieties of copper and purple, 448
Bees—feeding, 15; art of keeping, 59; separators a necessity, 60; feeding in spring, 80; last year's swarms, 83; influence of autumn feeding, introducing queens without cages, 110; standard frame, 103; art of keeping, sizes for hives, 121; autumn feeding, 122; feeding in autumn, spring, and summer, 143; remedy for foul brood, hives un-get-at-able, bees breeding in winter, 144; feeding effects of, Bee-keepers' Association's Annual Meeting, 163; small sections, best bees, 164; art of keeping, gathering, and extracting, 184; feeders for, 203; guides in purchasing and price of hives, 223; amongst snow, Mr. Edwards' feeder, 244; feeding, 246; unget-at-able hives, 266; Bee-keepers' Committee and Show fixture, 266; feeding, 306; premature swarming, 307; beer, brandy, and bees, 328; the straw Stewarton hive, 329; feeding and uniting, 350; art of supering, 370; autumn feeding, hives, uniting hives, straw Stewarton bees, beer, and rum, 392; notes on swarming, 415; moving, oil-cake pollen, 437; artificial swarming, appliance for driving, Show at Bridgwater, pleasure and profit, 457; book, review of "Plain and Practical Bee-keeping," swarming, reward of perseverance, 480; bees and fruit 481; removing stocks, 522; most profitable race of, 524;
- BEES—continued.**
 art of keeping, sections, dangers, uniting and feeding, 286
 Bees and horticulture, 548
Begonias, culture of Tuberosus, 516; propagating, 223, 303; Prince of Wales and Dr. Duke, 435; Orange Giant, certificated, 545
Bermuda, vegetable culture in, 471
Blackberries, American Kittatinny, 519
Blight in May, 466
Blossom, abundance of in Scotland, 514
Boiler, stopping leakage in, 165; Kinnell's horseshoe-shaped, 450
Bones, dissolving, 39
Books, reviews of, "Rosarian's Year Book," 51; Sach's "Text Book of Botany," 57; "Les Plantes Potageres," 74; "Vines and Vine Culture," 180; "Herefordshire Pomona," 263; Williams' "Greenhouse Flowering Plants," 283; Ville's "Artificial Manures," 348; "Mushrooms for the Million," 430; "Agriculture," 461; "Life on the Farm—Plant Life," 552
Books and reading, 211
Books, catalogue of, 448
Boronia tetrauda, 536
Bossetia tenuicaulis, 94
Botanic (Royal) Society, seaweeds in gardens of, 257
Botanic (Royal) Society's first Spring Show, 264; Second Spring Show, 346; First Summer Show, 412; Second Summer Show, 500
Bougainvillea glabra, 50; spectabilis culture, 441
Bouquets in Covent Garden, 383
Bouvardias, culture of, 502; repotting, 524
Brainea insignis, 368
Briza maxima, 224
Brococlis and Cauliflowers, differences between, 279
Brussels Sprouts, 71; Reading Exhibition, 4; The Aigburth, 24
Budding, the scallop method, 393
Bulbs, liquid manure for, 62; under trees, 280, 325
Bullfinches and fruit blossom, 444
Burghley, Peaches and Grapes at, 514
- CABBAGE LITTLE PIXIE**, 25; growing and cutting, 357; good varieties of, 432; McKewen's Early, 469
Cacti, Mr. Loder's lecture on hardy, 386
Caladium esculentum in Africa, 369
Calanthe Veitchii, treatment of, 39; Regnier, 136; culture of, 242; cultivation of, 355; watering, 547
Calceolarias at Reading, 426; in beds, 446; at Balham, 449; at Farnham Royal, 477
Calderhead, testimonial to Mr., 403
California, scenery in and colours of flowers, 449
Camellias, causes of buds falling, 102; culture of and varieties, 119; historical and cultural notes on, 200; destroying scale on, 288; not expanding, 307; effect of cutting
- CAMELLIAS—continued.**
 down, 361; cutting down, 416; Belgian, 466; renovating, 508
Cannaphor and seed germination, 303
Cannas, two good varieties, 245
Caper Spurge, 16
Capparis spinosa, 16
Carbolic acid v. insects, 66
Carbolic acid and glycerine as an insecticide, 113, 135; and methylated spirit, 66; and weeds, 330
Cardiff Castle Cucumber, 280
Carica, new hybrid, 221
Carnations and Picotees, treatment of, 25; culture in beds, varieties, 47; potting, 61; new varieties, 4; proposed show of at Slough, 176; in beds, old and new varieties, 276, 230; growing for winter, 245; Field Marshal, 435
Carpet beds, arrangement of, 502
Carriage drives, edgings for, 40
Caryota excelsa, 136, 137
Caterpillars and Cabbages, 398
Cattleya Percivilliana, 135; Gaskelliana, 344; nobilior, 435; Morgania, 491; management of, 547
Cauliflowers and Lettuces, early varieties and management, 46
Cauliflowers and Broccoli all the year, 212
Celery bulging, 61; fly, description and habits of, 83; Turner's Incomparable and Sandringham, 92; Turnip-rooted, culture and use of, 257; planting and earthing, 512
Centropogon Lucyanus, 510
Cephalanthera ensifolia, 526
Cerbera Thevetia, 351
Cereus, night flowering, at Leigham Court, 449; grandiflorus at Leigham, 513; at Pendryffryn, 538
Certificating plants, 404
Ceylon Botanic Gardens report and Cinchona cultivation, 470
Chestnut, double, 198
Chimonanthus fragrans, propagation of, 39
Chionodoxa Luciliae, 215
Chorozeina cordata, 245
Christmas Roses in the London markets, 113
Chrysanthemum—culture of, 5; yellow varieties, 17; for exhibition, 23; notes on, 29; Star of Whyke, 45; late-flowering varieties, 50; dressing, 52; at Christmas, 67; Mr. Bryant's at Kingston, 74; wood ripening, 76; as cut flowers, 89; notes on late, 94; at Kingston, 96, 112; election, the polling, 110; late varieties, 113; ripening wood of, 115; producing late flowers of, 134; too-much-alike varieties, 138; election, 151; notes on too-much-alike, 177, 237, 251; late, 179; early and late-flowering, 193; notes on election, 195; proposed conference on, 216, 280; C. segetum, 288; Crimson King, 308; for decoration, 366, 372; potting and stopping, 456; culture for decoration, 464; coronarium var. Aurora, 500; cutting down, 538
Cinchonas, Mr. Howard's lecture on, 427
Cineraria Victory, 136; culture of, 198; Captain Edwards and Colonel Clarke, certificated, 220; at Bristol, 234; Princess of Wales, Mr. Herrin, and Duke of Edinburgh certificated, 261; sowing, 459
- Clay, value of burnt, 112
Clematises as isolated specimens, 113; indivisa, 238; indivisa lobata, 342; C. John Brown, 344; C. cirrhosa, 308; Krao, 362; montana, 497
Clerodendrons Balfourianum and fallax, culture of, 59
Climbers for conservatory, 224; pruning, 306; for east aspect, wiring wall, 308
Clovenfords, Grapes at, 313; criticism, 491
Cocoa-nut fibre refuse and woodlice, 278
Cockscombs, culture of, 182
Cologyne cristata at Reading, 27; culture, 467; dividing, 512
Coix lachryma, 279
Coix jugosus punctatus, certificated, 385
Coleshill House Gardens, 389
Colombo, scenery near, 383
Corbularia alba, 72; citrina, 196, 217
Cordylone indivisa, hardness of, 8
Coronilla iberica, 33
Cotoneaster microphylla for edgings, 235
Cottage gardens in winter, 52
Cox, death of Mr., 427
Crinodendron Hookerianum, 97, 98
Crinum Kirkii, 428
Crops for shaded position, 185
Crossandra infundibuliformis, 76
Croton leaves in flower glasses, 112
Crotons, culture of, 146
Crystal Palace, a new French, 427
Cucumber disease, the, 4; fumigation as a remedy for, 28; preparing hotbeds for, 14; Pettigrew's Cardiff Castle, 27; in pots, 165; Cardiff Castle, 256; analysis of, 438; without ventilation, 594; Elliott's Yorkshireman and Sanders' Telephone, 550, 534; breakdown of the "Express" culture, 530
Cucumber and Melon disease, Mr. W. G. Smith's remedy for, 297
Currants, pruning Black, 39
Currant (black) x Gooseberry hybrid, 435
Currant Clearwing, 472
Cupressus Lawsoniana erecta viridis, fine specimen of, 492
Cyclobothra pulchella carnivorous, 498
Cyclamens, culture of, 80, 535
Cymbidium Devonianum—certificated, 384
Cypripedium insigne culture, 82; notes on, 115, 117; species, 116, 132; spectabile, 205; albobpurpureum, 473
Cyrtocilium stellatum, 491
- DAILLIAS**, NEW SINGLE VARIETIES, 46; propagating, varieties for exhibition, 61; growing in pots, 82; single, raising from seed, 190; show fixture, 279; select, classified colours, 358; D. Imperialis, 399; pegging-down single, 426; National Show schedule, 514; pegging down, 549
Darwin, memorial to late Mr., in Sweden, 73
Daphne indica, culture of, 123
Dead branches detrimental, 478
Decaisne's library, sale of, 403
Delphinium Dick Sand, 545

Dendrobium Lecchianum, 114; nobile var. nobilis and Wardianum var. Waddellianum, 220; Wardianum, culture of, 249; nobile var. nobilis, 378; Dearei, 435; nobile, removing pseudo-bulbs, 438; draconis, 491; summer treatment of, 547
 Deutzia crenata flore-pleno, 61
 Diplacis glutinosus, 482
 Dipladenia Brearleyana culture, 165
 Diplopappus chrysophylla, 8
 Domestic gardening, Mr. Burbridge's lecture on, 217
 Douglas, presentation to Mr., 114
 Dracenas, propagating, 121
 Draining, advantages of, 3; a lesson in, 49
 Drawing, value of for gardeners books and prizes for, 335
 Drumlanrig, notes on, 157
 Dundee, Dickson and Turnbull's nurseries, 177
 Dust storms in India, 257

EARTH TEMPERATURES, notes on, 291; natural and artificial, 368
 Echeveria retusa at Chiswick, 27
 Echinocactus Whipplei, stemms sensitive, 470
 Egyptian garlands, 383
 Elm, removal of memorable, goat moths attacking, 361
 Epidendrums, notes on species, 364, 410; nemorale, 365; coeleatum, 411; replicatum, 430
 Epping Forest, Committee report of, 73
 Eranthemum Andersoni, 9
 Ericas, culture of, 37; carnea, 174
 Erigerons, species of, 33
 Erythronium grandiflorum, 381, 412
 Eucharises, potting, 143
 Euonymuses, notes on varieties, 466
 Eupatorium Weinmannianum, 273
 Euphorbia splendens, 145; jacquiniflora, topping, 524
 Eurya latifolia variegata, 213
 Evolution, Prof. Meehan on, 36

FARM—retrospect, 18; maximum weight for age of cattle, 19; Goat farming, 40, 62, 103; the Angora Goat, 62, 164; feeding live stock, 103; analysis of Goat milk, 124; indications of fertility or barrenness of soils, 146, 166, 186; Wheat and Oats for spring sowing, bacon and hams, curing, 147; Drumhead Cabbages and Kale, cows calving prematurely, Colts-foot in pastures, 168; sowing barley with oats, selling sheep to advantage, formation of pastures, 187; the polled breeds of cattle, 206, 226, 246; manure for Potatoes, top-dressing for Wheat, 207; Ensilage, 268, 289; Dutch barn and silo, 266; bottled milk, 290; ensilage and hay, tabulated results, 309; Oats v. Barley, "Easy Lesson on Dairying," Mustard in fields, 310; ploughing-in or feeding green crops, 331, 352, 372, 394, 417; soil exhaustion, special wants of special crops, 353, 395; Cabbage for dairy cows, Alderney cow management, 354; tabular composition of various crops, 373; Lucerne, Rape cake, 374; cost of sheep feeding, 394; International Forestry Exhibition, 396; Committee of Agriculture, 396; hay-saving by machinery, 430, 450, 483, 505; cream cheese making, 462; food for cattle, 484; corn-saving by machinery, 505, 551
 Feeding ewes, 87
 Ferns, substitutes for, 196; re-potting, 203; dividing hardy, 222; fronds, substitutes for, 237; in bottles, 357
 Fertilisers—Clay's, quantity to use, 246; Sussex experiments with, 419
 Figs, forcing, 120, 285; at Chatsworth, 468; second crop, 523
 Filberts, pruning, 79, 200; pruning and blossoms, 255
 Filmy Ferns and frost, 53
 Fir-tree oil, 16
 Fisheries Exhibition, decorations at, 403
 Fish, Gold, killed by water beetles, 469
 Floriculture, tastes in, 66

Flower bed, a pretty, 513
 Flowers, colours of, 54, 90; early, 174; from France, 196; heat in relation to sexes of, 514; choice hardy, 518; preserving colours of, keeping in water, 562; exhausting plants, 532
 Flowerstand, combination, 405
 Forests, in Ireland, 115; in Italy, 114; in North Carolina, 319
 Francisceas, propagating, 162
 Fraxinus ornus, 449
 Frost, severity of and effects of, 217, 221; in March, effects of, 256
 Fruits, Beach's preserved, 298
 Fruit—forcing, 349; blossom, thinning, 361; thinning hardy, 376; varieties of, not cankering, 379; prospects, 407, 424; varieties cankered and not cankered, 428; proposed show of at South Kensington, 444; prospects of in the north, 445; proposed national show of, 472; prospects in Kent, 468; fruit seeds, cleansing, 481; prospects in Worcestershire, 513
 Fruit trees—syringing, budding, 17; growing on chalk soils, 29; planting, pruning, and training, 37; forcing, Peaches and Nectarines, 68; growing on chalk soils, 67; pruning and training, 79, 82; protecting, 101; planting, pruning, and protecting, 120; culture in Russia, 135; protecting blossoms of, 162; grubs attacking, 163; farming, extensive, 170; culture in New South Wales, 197; protecting blossoms, 202; blossom frozen, 267; protecting, 242; spring-pruning, 284; canker in, 337; mulching, 339; pinching and training, 344
 Fuchsias, wintering, 39; new varieties, 45; Mrs. Rudell, 241; certificated, 220; origin of, 251; Bella, 492
 Fungus in greenhouse, 267

GALANTHUS ELWESI AND other species, 215
 Galls and gall makers, 515
 Gardeners and Excise duties, 169
 Gardeners, conduct of young, 172, 234; law on taxing, 190; dismissal of, 482
 Gardeners' Benefit Society, 324
 Gardeners' (Royal) Benevolent Institution, appointment of Treasurer, 156
 Gardening and gardeners, 87; thoughts on, 134; Mr. Richardson's paper on, 346
 Garden, my suburban, 26, 48, 91, 349; thoughts on management of, 530
 Garden structures, 21, 88, 91, 150, 182
 Gardenias, culture of, 38; buds deformed, 267; planting out, 398; for the million, 442
 Gardiner, presentation to Mr., 218
 Garrya elliptica, grafted on Aucuba japonica, 221
 Gas lime for gardens, 61
 Gentianas, species of, bavarica, 274; acutis albus, 244; seeding and self-sowing, 301
 Gesneria cinnabarina, culture of, 88
 Ghent International Show, schedule of, 156
 Ghent, M. Van Houtte's nursery at, 465
 Gladioli for Scotland, 40; experiments with, 96; failures with, 157, 175, 178; notes on new varieties, 212; planting and disease of, 242; culture of early-flowering varieties, 251; in Scotland, 293; notes on, 312; raising from cornets, 341
 Gloxinias, culture of, 38; choice new varieties, 474; at Reading, 490
 Goat farming, 83; and mohair, 207
 Goat Show, 484
 Gold fish dying, 450
 Gooseberries, useful, 82; pruning, 109
 Gooseberry Sawfly, 481
 Grafting Plums and Cherries, 62
 Grafting, 118; cleft and notch, 130; crown, 155
 Grapes—Muscat of Alexandria, 3; Madresfield Court, 5; notes on, 6; Duke of Buccleuch, late keeping, 12; cool-system culture, 14; Black Alicante, 23; Mrs. Pinec, 23; culture, cool system of, 26; aspects for, 47;

GRAPES—continued.
 Golden Queen, 59; producing large bunches, 53; cracking and prevention, 61; bottled not keeping, 102; so-called large bunches, 201, 218, 239; thinning, twisting bunches, 230; temperatures for, 351; weights and sizes of bunches, 372; large v. small bunches, 399; Duke of Buccleuch, 401; express growing, packing, 402; footstalks decaying, 416; Duke of Buccleuch footstalks decaying, 420, 464; forcing and growing, temperature for, 452; packing at Clovenfolds, pruning Duke of Buccleuch, 458; at Duneevan, 513; Duchess of Buccleuch, 536; Madresfield Court, warm v. cool-house treatment, 533; thinning and scalding, 547
 Grasses and Everlasting Flowers, notes on, 108; raising ornamental, 224
 Greenhouse and its inmates—syringing and plunging, 532; an amateur's, 428; neat stage in, 459; the Citrus family, 535
 Ground levelling, 78
 Grubs, destroying in garden, 393, 550; destroying with sal ammoniac, 488
 Guernsey Lilies, 102
 Gutta percha, sources of, 453

ILABROTHAMNUS ELEGANS argentea, 283
 Iardenbergia Comptoniana, 280
 Heaths, repotting, 102, 306
 Hedges, formation and management of, 123, 131; Conifers for, 144
 Heliotrope, Swanley Giant—certificated, 385
 Hellebore tea, 394
 Hepaticas, 216; triloba, 241
 Heraclium giganteum, 538
 Herbaceous borders in June, 514
 Herbaceous plants, a prize collection of, 426
 Hippeastrum equestre var. semi-plenum, 311
 Hooker, Sir J., and Royal Geographical Society, 362; Society of Arts' award to, 537
 Hollyhocks, propagating select varieties, 215
 Hop mildew, destroying, 426
 Horn shavings and bone, constituents of, 525
 Horsefield, death of Mr., 115
 Horticultural buildings, 137; how to succeed, 277
 Horticulture, prospects of, 311
 Horticultural (Royal) Society's Meetings, 8, 33, 135, 220, 269, 334, 344, 384, 435, 497, 544; privileges of Fellows, 8; proposed officers, 50; Annual Meeting and Report, 139; arrangements for 1883, 157; resumption of provincial shows, 216; Spring Show, 260; proposed evening meetings, 341; Society's Summer Show, 433; meeting at Burlington House, 498
 Horticulture, review of in 1882, 56
 Horticulturists, proposed international meeting of, 236
 Hose, leather v. india-rubber, 358
 Hot water as an insecticide, 256
 Hot-water pipes, stopping leakage in, 371
 Hoya campanulata, 406
 Hyacinths and Tulips for exhibition, 58
 Hyacinths Pink Perfection and Souvenir de J. H. Veen certificated, 261
 Hyacinthus candicans, 98; raising from seed, 101
 Hydrangeas, culture of, 5; dis-budding flowers of, 68
 Hymenocallis macrostrophana, culture of, 102
 Hypericum, notes on, 12, 76

IBERIS GIBALTARICA HYBRIDA, 435
 Imantophyllum miniatum, 257; Mrs. Laing, 862; the best varieties of, 465
 Impatiens Sultan, 470; from seed, 547
 Indian muslin for shading, 216
 Insect enemies of garden crops, 70, 201, 345, 471
 Insects on fruit trees, modes of destroying, 149, 318, 476; Gooseberry moth, 345
 Insecticides—carbolic acid and methylated spirit, 66

Irises, difficulty of seeding, a hybrid, 386; Dr. Foster's lecture on, 386; notes on rare, 413; siberica, 498; choice varieties of, 491
 Ivy on houses, 380; severing stems of, 429
 Ixoras, propagation of, 162

JEW'S-EAR FUNGUS, 82

KALE, HEARTING CURLED, 362
 Kalosantes, culture of, 282; coccinea culture, 486
 Kew, report of condition and progress, 50; earlier opening of Gardens, 156
 Kitchen garden, raising early crops, 58; notes, 98, 349; lateness of crops, 265

LADDER FOR CONIFERS, 141
 Lambeth Palace Garden, 67
 Laminia maculatum aureum, 448
 Lathraea squamaria, 330
 Lawns, making and renovating, 47, 121, 155; moss on, 61; and their surroundings, 68; mixture of seeds for, 272; draining and levelling, 296; management of in hot weather, 490
 Lawn tennis ground, improving, 145
 Leaf soil, Belgian and English, 335; note on, 379
 Leaves, forms of, 363; facts about, 454
 Leucadendron argenteum, 330
 Leucojum vernum, 284
 Lewisia rediviva, 49
 Lilies, preparing and forcing, 438
 Lily, Bermuda Easter, 516
 Lilium longiflorum in winter, 12; longiflorum, 498; at Duneevan, 513; preparing for winter, 524
 Lilledend, plants and Grapes at, 532
 Lily of the Valley, 52; in America, 92; culture and forcing, 107; Mr. Roberts' pamphlet, 279; home-grown, 314, 257; preparing for forcing, 339; home-grown for forcing, 493
 Liming land, 167
 Linnaean Society, election of officers, 449
 London nurseries in April, 320
 Luculia gratissima at Glasnevin, 9; growing dwarf, 155
 Lupinus polyphyllus, 513, 539
 Lycaste flariflora alba, 344, 377
 Lyne, presentation to Mr., 92

MADEIRA, VEGETATION OF, 54
 Magnolia Campbelli at Lakelands, 73
 Maize and glucose sugar manufacture, 197
 Manchester Botanical Society's report, 92
 Mangiera indica, 404
 Mann, presentation to Mr., 235
 Manure, poultry, 39; economical, 44; the best, 487
 Marguerites in London, 490
 Marseilles, proposed International Show at, 196
 Masdevallia Schlimii, 304, 378; M. xanthocorys, certificated, 384; M. rosea, certificated, 385
 Melons, potting and topping, 80; stems splitting and remedy, 195; preserving, late keeping wanted, 234; culture after setting, 243; culture in pots, 271; culture of Water, in frames, 307; top-dressing, 308; culture of, Mr. Taylor's method, 336; culture in frames, 405; watering and mulching, 456; topping and training, 458; notes on, 501; gumming and canker, 504; not swelling, 549
 Menyanthes trifoliata, 330
 Meteorological observations in Notts, 297
 Meteorological Society, meeting of, 9, 78; exhibition of instruments, 176
 Methylated spirit v. mealy bug, 66
 Microcachrys tetragona, 35
 Mimuluses certificated—moschatus grandiflorus, n. rubra, hose-in-hose, 386; radicans, 497

Mistakes in gardening, 529
 Moles, banishing, 283
 Monifeth nurseries, 499
 Monstera deliciosa, 303
 Moss litter, German, 279
 Murucuja, fruits of in Covent Garden, 385
 Muscari Heldreichii, 215
 Mushroom culture at Liverpool, 9; culture outdoors, 49; beds, liquid manure for, 123; destroying insects in, 165, 216; preserving, 332; on ridges, 360; for the Million, 403; in vinery, 427; Mr. Wright's treatise on, 430; growing in moss, 442; Culture for Amateurs, 491; manure for, 526

NARCISSUS IN POTS, REFERENCE to lists, 225; dwarf early varieties of, 283; incomparabilis pallidus, Princess Marie, 344; bulbocodium in pots, 362, 382; Mr. Henslow's lecture on, 406; double Poet's, 458
 Nepenthes, culture of, 198; varieties for decoration, 209; at Chelsea, 474
 Nephrodium Rodigasianum, certificated, 384
 Newcastle Spring Show, 387
 Nicotiana affinis, 295
 Nightingales in Kent, 511
 Nitrogen, too much, 464; too much and too little, 492; use of, 514
 Nursery sick fund, 360; at Sawbridgeworth, 399
 Nymphaea stellata var. zanzibarensis, 491

ODONTOGLOSSUM MADRENSE var. giganteum, 34; Alexandra, 44; Scotti and crispum aureum magnificum, 163; Alexandra, culture of, 150; Alexandra at Drumlanrig, 176; gloriosum var. pictum, 321; polyxanthum grandiflorum, 344; Ruckermanum, 423; cordatum var. 377; vexillarium splendens, polyxanthum grandiflorum, 378; vexillarium albicans, certificated, 385
 Onocidiums, notes on, 23; Rogersii, 69
 Onions—winter and spring, designation of, 246; transplanting, 466
 Ophrys aranifera, 415
 Orange, Myrtle-leaved, 17; at Sawbridgeworth, 72; home culture of 108, 535; trees and Mytilopsis citriocola, 261
 Orchella weed, products of, 471
 Orchids—in flower at Fernside, 79; in Covent Garden, 114; at Kew, 114; at Davenham Bank, 133; at Chelsea, 175; sales, 225; Fern roots for potting, 234; cool temperatures for at Fernfield, 240; repotting and compost for, 243; at Walthamstow, 304; at Brentham Park, 323; at Clovenfolds, 402; sale of Lord Egerton's, 404; at Kew, 404, 448; Mr. Bull's exhibition of, 423; at Glasnevin, 427; Mr. Peacock's, 449; at Holloway, 454; potting, 463; sale of Brentham Park collection, at Tranby Court, 469; Mr. Williams' Album, 470; at Messrs. Veitch's, 472; at Bridgewater, 474; at Selborne, 477
 Orchis maculata for gardens, 338
 Oxlips from seed, 386, 401

PALMS, POTTING, 306
 Panicum plicatum, 174
 Pansies and insecticides, 381, 425
 Pansy (Scottish) Society and unnamed flowers at, 538; origin of, 539; Show, 542
 Paraffin oil in vineries, 512
 Parsnip, culture of, 29
 Past, present, and future of gardening, 1
 Pasture, barren, 440
 Paterson's (Dr.) garden, 240
 Peaches, glands of, 39; trees, protecting stems of, syringing blossoms of, 82; syringing, 123; dis-budding, temperature for, 162; a land of, 187; forcing, 243; dis-budding, thinning, and training, 250; dis-budding, 312; falling, 330; Alexandra, certificated, 384; dis-budding,

PEACHES—continued.

413; renovating trees, 416; ripening wood of, 523; repotting trees, 524; on walls at Hawkhurst, 538; sewage for, 546; leaves eaten, 550

Pears — *Passé Crasanne*, 5; *Easter Beurré* and *Beurré Rance*, 11, 24, 48, 50, 70; *Josephine de Malines*, 13; ripening and preserving, fungus germs, 43; renovating old trees, 17; *Easter Beurré* variable, 111; in the north, 114; on the Continent, winter *Bon Chrétien*, 197; fruitful varieties in Kent, 538

Pear caterpillar, *Hybenaria deliaria*, 458

Peas, sowing early, 14; Duke of Albany, 22; history of, 132; Admitt's protectors for, 134; value of protectors, 172; Hooper's prizes for, 175; American Wonder, 549

Pelargoniums, new varieties, 46; potting and culture, 163; culture and varieties for winter, 259; Zonal, for winter, 300; culture of Show decorative, 336; *Guillon Mangilli*, 342; cross between Showy and Fancy varieties, 491; Dr. Masters, Fanny Hayes, *Garibaldi*, *formosum*, certificated, 498; *Chelsea Gem*, 533

Pelargonium Society, 27

Peristeria elata, 185

Pesetorea Lehmannii certificated, 220

Persea volubilis, 404

Petroleum as an insecticide, 149

Petunias, culture of double, 62; for exhibition, 267; in pots, 456

Phalœnopsis Veitchiana, 11; *leucorrhoda*, 136; *leucorrhoda* var. *Esmeralda*, 218; *Sanderiana*, certificated, 384

Philadelphus mexicanus, 435

Phloxes for late flowering, 160; good varieties, 164

Photographs of flowers, Stevens' 92

Phylloxera and the French vineyards, 320

Picotees, new, 29

Pictures, Miss North's, 140

Pigeons, parasites on, 86

Pilea serpyllifolia, 444

Pimelea elegans, 531

Pines for fruiting, 17; culture, 89; fruit discoloured, 101

Pinguicula caudata, 279

Pinks, mule, 33; choice garden, 539, 550; propagating, 548

Pinus insignis in shallow soils, 4

Piptanthes nepalensis, 413

Pit, cheap span-roofed, 438, 526

Pitch Pines and enemy, *Retinia frustrana*, 471

Plant houses, cleansing, 15

Plants, climbing for a porch, 17; covering herbaceous, 30; new and certificated in 1882, 30; Messrs. Cannell's new and certificated, 45; Mr. Bull's new and certificated, 74; for a dark conservatory, 131; dividing herbaceous, 142; watering, 152; repotting fine-foliated, 203; choice hardy in flower, 215; and weather changes, 258; moisture-loving, 274; for shady positions, 320; insectivorous, 532; in New Zealand, 549

Pleroma elegans, 455

Plowman, presentation to Mr., 440

Plum gall mite, *Phytoptus Pruni*, 482

Polunettias, propagating, 501

Polyanthuses, degeneration of, 401

Polygonatum, 435

Polygonum sachalinense and *alpinum*, 539

Polystichum acrostichoides grandiceps, 498

Poplars destroyed by frost, 71

Potash, silicate of and its uses, 482

Potatoes, experiments with, 35; a trial of, 67; extent of American importation, 72; number and weight for planting an acre, 82; as a fixed crop, cost and profits of culture, 125; disease, 112; *Magnum Bonum* for market, 113; Foster's Seedling, 114; election of for table and market, 129; International Exhibition fixture, 134; for table and market, 153; disease and "sclerotia," 221, 251, 261; requirements of different varieties, 227; effects of manure on, 238; time to plant, 247; Californian species, 261; strong-growing and soil-exhaustion, 270; applying manures, 287; profitable grow-

POTATOES—continued.

ing, 295; planting on surface, 299; growing profitably, proposed prizes for and raising seedlings, 334; for table and market in Cheshire and Cornwall, 172; in Cumberland, Derbyshire, Devonshire, and Durham, 173; in Essex, 174; in Gloucestershire and Hampshire, 191; in Herefordshire, Hertfordshire, Huntingdonshire, and Kent, 192; in Kent, Lancashire, and Lincolnshire, 213; in Middlesex, Monmouthshire, and Norfolk, 214; in Nottinghamshire, 215; in Northamptonshire, 231; in Northumberland, Notts, Oxford, Rutlandshire, Shropshire, and Somersetshire, 232; in Staffordshire, Suffolk, and Surrey, 233; in Sussex, 253; in Warwickshire, Wiltshire, and Worcestershire, 254; in Yorkshire, 255; in Wales, 275; in Scotland, 302; in Ireland, 347, 367; at the Antipodes, 383; prospects of crop in Ireland, 533; disease in Wales, 537; and sclerotia, 545

Pothos aurea, 516

Potting sheds, notes on, 65

Poultry, challenge cups, 19; fowl crop-bound, 20; in 1882, 42; gapes in fowls, leg-weakness, 42; points of Silver-faced Bantams, 64; Dorking challenge cup, feeding chickens, 85; lime water for, suffering from cramp, 86; notes on Dorking challenge cup, 105; illustrations of birds, Aberdeen and Belfast Shows, 106; scaly legs and remedy, 106; Cuckoo fowls, 126; in France, effects of wet weather injurious, roup and a remedy, 148; eggs and the hatching season, 168; a new paper, English and French poultry-keepers, 188; the Dorking challenge cup, "Table Poultry," 208; the egg, 228; foreign egg supply, 290

Poultry Club meeting, election of officers, 86

Pratia angulata, 545

Primulas, *obconica*, 10; cross-breeding of, 169; raising seedlings, 243; packets of seed, 319; sinensis, varieties of, 328; *P. scotica*, 337, 412

Pritchardia grandis, 545

Pteris serrulata cristata lacinated, 31; *serrulata* Cowan, certificated, 253

Pyrethrums, propagating double, 504

PLANTS CERTIFICATED—
Acanthophippium Curtisii, 413; *Acer polymorphum variegatum*, *A. crataegifolium variegatum*, 497; *Adiantum novae-caledoniae*, 498; *Amaryllis Acis* and *Achilles*, 136; George Gordon, A. F. Barron, and Dr. Hogg, 220; *Lady of the Lake*, Wordsworth, Byron, and Tenyson, 261; *Adolphus Kent*, 344; *Angræcum articulatatum*, 261; *Anthurium ferrierense*, 261; *Auriculas*—Dr. Denny, A. Lloyd, Rob Roy, Roysterer, *resplendens*, Homer, 385; *delicata*, 386; William Coomber, Richard Gorton, Ouida, 413; *Azalca Antigua*, 344; Baron N. de Rothschild, 384; Duchess of Albany, 34; *Deutsche Perle*, 220; *Souvenir de Prince Napoleon*, 384; *Princess Louise*, Comte de Chambord, 385; *Madame Van Houtte*, 413; Dr. Hermann Wiegel, 435; *Begonia gogonensis*, 413; *Little Gem*, Canary Gem, Prince of Wales, Queen of Doubles, Sir Garnet, Clarinda, 413; Black Douglas, Mrs. Morgan, Queen of Scots, 425; Dr. Duke, 435; Orange Giant, Prince Albert, Zenobia, 545; *Caladium Luddemannianum*, C. *cardinale*, C. *Verdi*, 413; *C. ornatum*, 425; *Calanthe Regnierii*, 136; *Cattleya Gaskelliana*, 344; *C. tricolor*, 413; *C. nobilior*, 435; *Carnation Field Marshall*, 435; *Cinerarias* Captain Edwards and Colonel Clarke, 220; *Princess of Wales*, Mr. Herrin, and Duke of Edinburgh, 261; *Victory*, 136; *Clematis* John Brown, 344; *Colax jugosus punctata*, 385; *Coleus* Canary Bird, 413; *Columnea Kalbreyeri*, 384; *Cycas elegantissima*, 498; *Cymbidium Devonianum*, 334; *Cypripedium recurvipetalum*, 413; *Davallia brachycarpa*, 413;

PLANTS CERTIFICATED—con.

Delphinium Dick Sand, 545; *Dendrobium leucophyllum*, 413; D. *Dearei*, 435; D. *nobile nobiliss*, 220; *D. Wardianum* *Waddellianum*, 220; *Epidendrum Frederici Guilielmi*, 413; *Fuchsia Mrs. Rundell*, 220; *Heliotrope Swanley Giant*, 385; *Hyacinth Pink Perfection* and *Souvenir de J. H. Veen*, 261; *Hydrangea rosea*, 497; *Impatiens Sultanii*, 425; *Iberis gibraltaria hybrida*, 435; *Leucothoe Davisia*, 545; *Lilium longiflorum* of *Bermuda*, 498; *Lycaste Harrisoni alba*, 344; *Masdevallia Schlimi*, 304; *M. xanthocorys*, 384; *M. rosea*, 385; *Maxillaria luteoalba*, 413; *Mimulus moschatus grandiflorus*, *Hose-in-Hose*, *moschatus rubra*, 386; *radicans*, 497; *Nareissus incomparabilis pallidus* *Princess Mary*, 344; *Nephradium Rodigasianum*, 384; *Ochna multiflora*, 413; *Odontoglossum madrense* var. *giganteum*, 34; *O. Scottii* and *O. crispum aureum magnificum*, 136; *O. polyanthum grandiflorum*, 344; *O. vexillarium albicans*, 384; *O. elegans*, 385; *Pelargonium Dresden China*, 425; Dr. Masters, 497; *Garibaldi*, Fanny, *formosum*, 498; *Pescatorea Lehmannii*, 220; *Phalaenopsis leucorrhoda alba*, 136; *P. Sanderiana*, 384; *Polystichum acrostichoides grandiceps*, 498; *Pratia angulata*, 545; *Pritchardia grandis*, 545; *Prunus Pichardii*, 413; *Rhododendron Princess Christian* and *Baroness Schröder*, 136; triumphans, 261; *Scarlet Crown*, 384; *Greavesii*, 413; *Diadem*, 545; *Rose Mignonette* and W. Francis Bennett, 261; R. *Merveille de Lyon*, *White Baroness*, 344; *Princess of Wales*, 497; *Henry Schultheis*, Mrs. George Dickson, *Violette Bouyer*, 545; *Sarcopodium Dearii*, 497; *Scuticaria Dodgsonii*, 344; *Tropæolum Lustrous*, 498; *Verbena Delicata*, Mabel, Miss Maynard, *Fantastic*, 542; *Viola Queen of Whites*, 422; *Wormia Burbidgel*, 384; *Zycopetalum erinitum giganteum*, 220

QUASSIA WATER, MAKING, 164, 165

RABBITS, FENCING AGAINST, 305

Rainfall and sunshine, 481

Rainfall, returns of, 72; at Ecclefechan, 113; in Cheshire and Ireland, 134; heavy, record of at Glenlee, 157

Ranunculus aquatilis, 545

Raspberries, good varieties, 82; pruning, 330

Reading, an hour at, 77

Red spider, destroying, 245

Retinosporas, sporting, 221

Rhodochiton volubile, 258

Rhododendrons, cutting down, 123; *Princess Christian* and *Baroness Schröder*, 136; triumphans certificated, 261; Nuttall, 341; Nuttall at Croydon, 363; *Scarlet Crown*, certificated, 384; *Dalhousie*, 403; Sikkim at Regent's Park, 404; a trio of new, 465; at Kew, 470; *Diadem*, 545

Rhubarb, historical notes on, 282; *Buck's Scarlet*, 393; varieties of, 404

Rhynchospermum jasminoides culture, 80

Ribes speciosum, 89

Richardia aethiopia, culture of, 12; easy culture of, 57; summer culture of, 452

Rivulet, a pretty, 518

Roller, "universal" garden, 349

Rookery, undergrowth for, 72

Root-extension v. restriction, 252

Rose shows, 324

Roses and Camellias, pruning *Maréchal Niel*, 416

Roses—*Maréchal Niel*, 28; at Dunkeld, 32; for beds, list of, 15; *Maréchal Niel* on Briar stocks, 68; my box of twenty-four, 95; planting, 101; pruning climbing, 121; forcing, 121; notes on certificated varieties, 127; for house and garden, for smoky district, 145; show fixtures, 156; planting, 165; se-

ROSES—continued.

lect climbers, pruning, 203, 238, 256; calyx foliaceous, 225; *Lady Mary Fitzwilliam*, 256; *Mignonette* and W. F. Bennett certificated, 261; notes on pruning, 287; Charles Darwin, 280; William Allen Richardson, 284; failures of *Maréchal Niel*, 287; early or late pruning, 298, 318; effects of frost on, spring, v. autumn planting, 299; from cuttings, 301; oxide of iron for, 308; on stocks v. own roots, 338; *White Baroness*, *Merveille de Lyon*, 344; Messrs. W. Paul & Son's, at Regent's Park, 362; *Yellow Afghan*, 363; cuttings v. stocks, 379; *Souvenir d'un Ami*, 381; striking cuttings, 421; *Reine Marie Antoinette*, 426; too-much-alike, 430, 444; boxes for showing, 438; showing in trebles, 444; unpruned for early blooms, 445; special prizes for at Darlington, 450; on their own roots, 457; the outlook, 476; destroying orange fungus on, 481; raising stocks on budding, 493; *Princess of Wales*, (certificated), 497; prizes for bouquets, 504; from cuttings, 509; introduction of Moss, 526; from cuttings, results, 534; disbudding, 547; *Violette Bouyer*, *Henrich Schultheis*, and Mrs. George Dickson, certificated, 545

SADLER, MR., BOTANICAL

ramble with, 55; proposed memorial to late, 234; fund for family of late, 369

Salvias for winter, 371

Sawbridgeworth nursery sick fund, 52

Sawdust, uses of in gardens, 102

Saxifraga Stracheyi, 284; *cymbalaria*, 343

Scale, methods of destroying, 386

Schiumbergia Morreniana, 362

Science in cultivation, 487, 419

Scilla biflora and varieties, 215

Scott, Major-General, death of, 319

Seakale, historical notes on, 282; planting, 335

Seeds, collections of, 7, 110, 157; disappointment with, 114; report of, 167

Selaginella grandis, 431

Selborne Gardens, 477

Senecio pulcher, propagating, 109

Shade and shading, 507

Shading greenhouses, modes of, 287

Shallots, notes on, 128

Shetland, flower culture in, 50

SHOWS—Bath, 400; Bath and West of England Society's Show, 474; Bristol Spring, 236; National Society's Southern (Auricula), 339; Crystal Palace, 425; Dublin Spring, 341; Edinburgh Spring, 296; Ghent International, 314; Liverpool Spring, 252; Manchester (Auricula), 366; Manchester, 408; Manchester (Tulip), 478; Reading, 421; Rochdale (Auricula), 389; York Floral Fête, 520; Chertsey District, 536; Leeds, 543; Pelargonium Society, 545

Shrubberies, thinning and arranging, 58

Shrubs and Conifers, pruning, 183

Shrubs, moving large, 231

Sisyrinchium grandiflorum, 215

Snails, entrapping and evading, 307

Snelling, death of Mr., 156

Soils, aeration of, 238

Solanum — Hendersonii, 55; capsicastrum culture, 174; tuberous, in California, 261

Southampton Horticultural Society—report, 72; prosperity of, 298

Spinach *Monstruosa*, certificated, 384

Spyers, Mr. J. C., death of, 319

Staphylea colchica, 303

Stephanotis floribunda, culture of, 7; culture of, 52; propagation and culture of, 101

Stigmaphyllon ciliatum, 361

St. John's Worts, notes on, 76

Stirling, notes about, 239

Stonework, cleaning, 185

Stove plants, repotting, 162

St. Petersburg International Exhibition, postponement of, 278

Strawberry-eating beetle, catching, 511

Strawberries—banks, 32; culture in pots, 37, 99; *La Gros-e Sucrée* for forcing, 276; *Vicomtesse Héricart de Thury*, 323; *Stirling Castle*, 324; *La Grosse Sucrée*, 358; weight of *Vicomtesse Héricart de Thury*, 402; crystallising, 415; preparing for forcing, 492; King of Earlies, 497; watering and mulching, 515; gardens at Chertsey, novel method of selling fruit at, 537; layering, 545

Sulphate of ammonia and Potatoes, 351

Sulphate of ammonia for vegetables, 441

Sulphuric v. carbonic acid and weeds, 337

Sulphur water, 496; making, 513

Sunflowers, culture of in fields, 248

Sutton & Sons, prizes offered by, 72

Sweet Briars for hedges, 93

Sweet William, spiral torsion in, 545

Sycamore, the Golden, 468

TABERNEMONTANA, FLOWERS

falling, 101; propagating, 162

Table plants at Wimbledon, 366

Tacsonia manicata, 391; *exoniensis*, 351

Temperature, high in winter, 8; low at night beneficial, 492

Thysanacthus rutilans propagation, 351, 534

Tillandsia, miniature, at Glasnevin, 93

Tithes, extraordinary, project for abolition, 176

Toads, hibernation and uses of, 422

Tomatoes, varieties and culture, 222, 378, 422

Tree moving, light machine for, 174

Trees, planting on waste lands, 50; for the seaside, 145; for moist soil, 185; planting in Ireland, 197; growth of, 237; in wet weather, 197; "an angry," 319; protecting stems, 372

Trees and shrubs injured by rabbits, 326

Trichopilia lepidota, 322

Tropæolum Lustrous, 498; *Hermine Grashoff* at Lillesden, 532

Tudgay, Mr., and future exhibiting, 50

Tulbaghia violacea, 489

Tulipa Clusiana in Persia, 221

Turf cutting and laying, 13

Turf pots, 318

Turnip, Extra Early Milan (certificated), 497

Tussilago fragrans, 23

VALVE, MESSENGER'S, 164

new Reliance Rotary, 475

Vanda teres Andersoni, fine specimen of, 530

Vegetables, select varieties of, 25; historical notes on, 34, 133, 446, 520; importation of, 197; useful, 359; profits of new and costly, 532

Vegetation, early in Perthshire, 92

Veitch's, Messrs., novelties, 10; purchase of nursery, 51

Ventilation, notes on, 22, 83, 258, 318, 380, 510; growing plants without, 482

Verbenas, propagating and growing, 539; *Delicata*, Miss Maynard, Mabel, and *Fantastic*, certificated, 545

Villa gardens, Mr. Mawley's 516

Vinegar and yeast plants, 351

Vinery, growing Peaches and Figs in, 40

Vines and phylloxera in France, 135

Vines—planting, 9; inarching, 17; writers on, 56; renovating old, 62; raising in turf, young wood, 71; fertilising blossoms, starting cut-backs, 80; grafting, 82; on greenhouse wall, 102; fruiting in pots, pruning *Gros Guillaume*, 103; management of early, 120; pruning inarched, raising in turves, pigmy, 123; in lime rubbish, 161; too luxuriant, 165; grafting, 181; bleeding, disbudding, 185; planting, uncovering, 186; lifting in March, 189, 237, 253; stopping bleeding with alum, 195; temporary, 204; in pots, shift-

VINES—continued.

ing, abortive bunches on, 205; temperature for, disbudding, management after lifting, 224; manuring, fruiting in pots, air roots, 225; removing tendrils, 267; stopping laterals, modes of pruning, growing in pots, 268; tying laterals of, 274; bleeding, 278; cropping, 287; bleeding and cold water cure, 279; renovating, manuring, 307; tendrils, removing, 318; scorched by ammonia vapour, 330; mildew, destroying, 376; methods of pruning, 401; enervation and restoration of, 402; renovating, dead cells in

VINES—continued.

foliage, 416; inarching with young wood, 446; planting in summer, 482; striking young growth of, 488; mildew on, removing material from border, stopping laterals, grafting and inarching, 504; not growing, 526; common sense about borders, 535; enfeeblement and renovation of, 547
Vineyard at West Lynn, 533
Violets, culture of in frames, 17; odorata pendula of New York, 26; culture of, 445; Marie Louise, 376
Vitis gonyolodes, 405

WALLFLOWERS, SOWING AND growing, 341; from cuttings, 427; Cranford Beauty, 422
Walks, making gravel, 15
Walls, wiring for trees, 82
Ward, death of Mr. William, 73
Wasps on Cotoneaster, destroying nests, 458
Waste water, 518
Watering and drainage, 194
Watering and keeping soil moist, 485
Watering gardens, 481
Watering, notes about, 93
Watering vegetables, 504
Water supply for gardens, 221, 358
Weather and work, 299

Weather—effects of mild, 78; Mr. Mawley's work on, 175; coldness of and its effects on vegetation, 256, 257; favourable change in, 278; in Staffordshire, 279; sudden change in, 341; record of cold in March, 342; in April, 383; during May in Notts, 492
Weigela rosea at Margam, 490
West Brighton Nurseries, late Mr. Miles, 216
Willows, grafting Kilmarnock, 393
Wine harvest in Algeria, 114
Wireworms, extirpating, 459
Wormia Bubidgei, certificated, 384

Wrench, death of Mr. Robert, 72

YEW HEDGE, PLANTING AND pruning, 177
Yew, large, at Orniston, 468
Yucca gloriosa variegata, 543

ZYGOPETALUM MACKAYI, true, 178; Mackayi and varieties, 193; crinitum giganteum certificated, 229

WOODCUTS.

	PAGE		PAGE		PAGE
Abutilons, varieties	49	Erythronium grandiflorum	381	Pteroma elegans	455
Acacia lineata	467	Ferns in bottles	357	Pothos aurea	517
Adenandra fragrans	447	Filbert blossoms	255	Primula obconica	10
Agapetes buxifolia	399	Garden view in Maderia—Quinta St. Anna	541	„ scotica	337
Allium neapolitanum	451	Gentiana bavarica	274	Pteris serrulata cristata lacerata	31
Anthurium splendidum	343	Gooseberry sawfly	471	Rabbits, fencing against	305
Bees, appliance for driving	457	Grafting	118, 130, 131, 155	Ram, Angora	104
Blackberry, Kittatlnny	519	Grapes, cluster of	53	Rhodochiton volubile	259
Boronia tetrandra	536	„ Lady Downo's (Clovenfords)	318	Ribos stamineum	89
Bossia tenuicaulis	94	Habrothamnus elegans argentea	283	Roller, "Universal"	340
Briza maxima	224	Hardenborgia Comptoniana	281	Roses, budding	494, 495
Caryota excelsa	137	Hippeastrum equestre semiplenum	511	Sarracenia	550
Chrysanthemum coronarium Aurora	500	Horse Chestnut, double-flowering	199	Selaginella grandis	482
„ Star of Whyke	45	Hoya campanulata	407	Senecio pulcher, root-cutting of	109
Clematis cirrhosa	308	Iris iberica	335	Stigmaphyllon ciliatum	361
„ indivisa	239	Microcarys tetragona	35	Tacsonia manicata	301
Crinodendron Hookerianum	97	Nicotiana affinis	295	Tee-moving machine	174
Crinum Kirkii	429	Odontoglossum cordatum var.	377	Trichopilia lepida	325
Crossandra infundibuliformis	75	„ gloriosum pictum	321	Tulbaghia violacea	489
Currant clearwing	472	„ Ruckerianum	423	Turf pots	318
Cypripedium albo-purpureum	473	Oncidium macranthum	23	„ lifting	13
„ Lowii	153	„ Marshallianum	25	„ racer	13
„ species	116	„ Rogersii	69	Valve, Reliance Rotary	475
Drumlanrig, gardener's house at	159	Pears, Passe Crasanne	5	Vine-grafting	181
Dutch barn and silo	269	Phalaenopsis Esmeralda	219	Zygopetalum intermedium	195
Egg	227	„ leucorrhoda	219	„ Mackayi	179, 193
Epidendrum nemorale	365	„ Veitchiana	11		
„ replicatum	411	Pimelea elegans	531		



4th	TH	
5th	F	
6th	S	
7th	SUN	1ST SUNDAY AFTER EPIPHANY. [Covent Garden.
8th	M	Sale of Lilliums and other Bulbs at Messrs. Stevens's Rooms,
9th	TU	Royal Horticultural Society, Fruit and Floral Committees at
10th	W	[11 A.M.

THE PAST, PRESENT, AND FUTURE.

EACH one of these (past, present, and future) has a marvellous power over us, though it is sometimes said that the young live in the future, the old in the past; yet this, like all general expressions, is only partly true. The young have their past as well as the old. This was vividly brought before me by overhearing two little children at play—two quite little fellows, one six years old, the other only three.

Having wearied themselves with romping they both sat down hot and dishevelled, the thought being "What's to be the next game?" when the elder broke in with the words, "Willie, let's talk of the dear old times." "What are they, Harry?" said the lesser. "Why, when you were at Weymouth and rode on a donkey." And they talked of those dear old times—just a few months ago! Verily these tiny ones had their past. So have all, whether young or middle-aged or old, mixing with their present, while something ahead, usually, we will hope, something bright, is in the future of almost all.

But at no time of our lives are past, present, and future so much with us as at the beginning of another year. All three are with us. May they all be with us at this time for our good. The thoughtful gardener—and he alone is a good gardener—while he looks to immediate duty, yet naturally thinks of past successes or failures; and even his very preparations for next season compel him to think of the future. A garden itself points forwards and backwards too, as saith the poet:—

"Fruits are born of flowers;
Peach and roughest nut were blossoms in the spring."

To gardeners I would say, as their life is becoming more and more a struggle, when, as now, where one situation is vacant there are fifty applicants for it—The men to get on and hold on are those who are thoughtful as well as active. A notable result of thought I may mention in connection with this Journal. The past year has produced no papers of higher type in gardening than those entitled "Vines at Longleat, their History and Management," and what thought they reveal! How the writer is constantly referring to the past! Had he not noticed accurately, and perhaps "taken a note" of his Vines of 1870, he would not have written so well in 1880. An observant mind necessarily stores up observations for future use.

I had written thus far when the leading article of last week's Journal came into my hand, and with this paper of mine in my mind I read the old spade-man's

account of his experience of fifty years (a past, indeed, of no ordinary length) with unusual interest. With him I desire to sing no dirges over the past. The squire's gardens, owing to the reduced rents on land, may be going down; but think of those around every city and large town, from swarthy Birmingham to fair Bath. If Cowper nearly a hundred years ago could say or sing—

"The villas with which London stands begirt,
Like a dusk Indian with his belt of beads,"

what would he say now, where there are hundreds of upper-class villas and, of course, gardens, when in his day there were units? Like the letters now and then: now they are many and small, then they were the few and the large. So, of course, there are more places to fill, and may the best men always fill them.

The love of flowers is ever increasing, and this goes hand-in-hand with refinement and a nicer attention, not only to people's wants, but their wishes and cravings. If you take any popular history of England, say Knight's, you will there learn how sparsely houses were furnished two hundred years ago, not to go further back; how carpets were not, but floors covered with rushes or sand; how a bedroom had little more than a bed, a table—a small one—and one of those oak chests now eagerly bought up by the curious. Then in after years in another century there were those better, but sparsely, furnished rooms with which Mr. R. Caldecott's little books have made all familiar. The oak chest gave place to the chest of drawers, and the one chair to several of more convenient size; but now see what refinement and good taste have made bedrooms, to say nothing of drawing-rooms. And now I come to the special point. Flower vases of artistic shape are in all rooms. Refinement increases a sense of beauty in house and furniture, and with them a love of flowers and of their possession necessarily increase. Gardens are in themselves good things, pleasure-giving things, and the love of them goes hand-in-hand with better manners—in short, with increased civilisation. Never did man understand the comforts of life as now: better, more convenient, houses, and furnishing and adornments; and what adornments so cherished as flowers? and how many more receptacles for flowers one sees in shop windows! Yet even to descend to the kitchen garden, man's better understanding his own body makes him more value fruits and vegetables.

But in praising the present let none slight, still less despise, the past men. To the men with the poor mechanical appliances of old times be all the praise. We need not go back to those whom Tennyson calls—

"The grand old gardener and his wife,"

meaning Adam and Eve, but take those whose lives were only a few years since given in our Journal. Take only one, old Gerard: what a grand man he was of observation and knowledge—knowledge because of observation! This age with all its advantages does not give any giants in any walk of life, no second Shakespeares, or Bacons, or Newtons. Revere the past men, while you rejoice in the present means of carrying out great ideas. In olden days the men were often beyond the means, now the reverse full often.

I think we need a little more variety in gardens, they are too much alike. Victor Hugo has said that "Nothing stifles one like perpetual symmetry or sameness." "Symmetry," he goes on to say, "is

ennui, and *ennui* is the very essence of melancholy." Man's mind loves variety. How at our flower shows this year people crowded around to see and admire the many single Dahlias shown! I think there is room for the introduction of more variety in gardens. This is a hint which landscape gardeners may take. With our climate, taste and skill count for everything. It is not with us in England as with the people of California, of which country this year wrote Miss Gordon Cumming, "Gardening here must be a delight when I look at the almost spontaneous growth of everything; for here (California) as in Australia all manner of plants grow side by side, and make no difficulty about acclimatisation. The Loquat, the Grape Vine, and the Lemon grow beside English Ivy and Oak, while the ground is carpeted with Violets and Lilies." Then she makes one's mouth water with such descriptions as these:—"Imagine a Fuchsia which in less than three years completely covers a house 70 feet in length and three storeys high, climbing right to the roof, and loaded with blossom; or a Geranium bush 6 feet high and 18 feet round, with a thousand heads of blossom at the same moment." Then she tells us of "a Rose bush which produces 15,000 to 20,000 Roses yearly. There is a famous Rose tree at Santa Rosa—suitable name—which is 27 feet high and 22 in diameter; its stem measures 24 inches at the base, and rises 12 feet before throwing out a single branch. It is called La Marque," (a name well known to Rose-growers and lovers), "and is a pure white Rose," the centre not noticed perhaps by Miss C., "and has sometimes 5000 blossoms in full beauty at the same moment, and"—but I will not transcribe more pictures for fear of driving "D., Deal," Mr. Hinton, and the rest of the Rose fraternity stark-staring mad with jealousy.

But if we cannot have such flowers, still our little gardens are, what John Evelyn called them long ago, "places of sweet retirement," and never were such places of sweet retirement more, or so much, needed as now. With nerves worn by hard city work, when even the short railway journey from his villa to town each day wearies, and the whistle and scream of the engine almost madden, how precious to the man of business—he who is "something in the city," that something taking in all varieties of people from merchant to clerk—but how welcome to each and all are at evening, and on Sunday specially, such "places of sweet retirement" as their gardens, small or large, the former often quite as much prized as the latter. Andrew Marvel more than two hundred years ago wrote of his garden, I think at a time when he was much in London—

"Society is all but rude
To this delicious solitude."

Nor, though I am myself no farmer, are these thoughts and feelings foreign to him who enters with delight into the pleasures of his "Home Farm." Well here is a hint for our ideal farmer if he grows Clover seed. The late Mr. Darwin it is, I think, who quaintly remarked that the fertility of the Clover in any district depends upon the number of cats kept in the neighbourhood; for the Clover is fertilised by the bees, and the bees are greatly thinned by the harvest mice, and the harvest mice in turn are much devoured by cats. The more cats, therefore, the fewer harvest mice and the better Clover crop. Since I read that I pet my cat still more,

and consider myself through her a benefit to the farming interest. No house nor stable should be without its cat either for pleasure, or, as it seems, for national benefit if Clover fields be near. The thought of cats makes me think, by an odd twist of unreasoning, of their opposites—viz., birds. Pigeon literature rarely has any addition from a writer who is outside the world of fanciers, but one such addition I must note, a charming tale, causing laughter and tears, appeared in "Aunt Judy's Magazine" for November, 1881, entitled "Daddie Darwin's Dovecote," by Mrs. Ewing, a tale, as you may judge from the title, in which pigeons, and fancy pigeons too, figure charmingly. I should like to see it printed as an introduction to any future large work on pigeons. In regard to the more useful, though scarcely fancy pigeons, the homing birds, I notice now even in Wiltshire towns they are largely kept, and Flying Clubs have taken root, these imported from the north. Homing pigeons were at a time undervalued, or only used by fanciers when Dragoons were flown. Then when news became more eagerly sought for the faster-flying Antwerps came into fashion. But then came the telegraph, and it was believed the days of pigeon use were over; but it is not so. To say nothing of times of war, when telegraphs are destroyed, or, worse still, "tapped," it has been discovered, so I learn from a recent Indian paper, that the irregularity and delays of the telegraph in some parts of the world are so great, from various circumstances, that the pigeon post has been reconstituted, and it was found to be quicker and more certain than the telegraph. So Nature beats Art even in these most scientific days.

To speak of one other bird, which was, happily, common some years since, the goldfinch—birds which in their singular loveliness of colour, form, and sprightliness of movement attracted the eye of the least bird-loving. These, the handsomest of all English singing birds, have become increasingly scarce. I have only seen one pair wild during the last ten years, and a recent writer notices that this scarcity is owing to the better cultivation of land and the extirpation, or nearly so, of Thistles. But I would ask, Has the Bird Preservation Act been properly carried out? I beg my readers, each and all, to see to this in their neighbourhoods. Have the men with call birds and limed twigs been laid hold of by the police as they ought to be? If not, we shall utterly lose one of the best of living ornaments to our gardens and country lanes, and one of the sweetest songsters.

But I must cease or shorten my gossip on paper. We begin another year, and "our Journal" sails on smooth seas, and is welcomed in countless homes of English-speaking people at home and abroad. Many periodicals are read and done with; I do not find this to be the case with ours. I read and refer to its bound volumes constantly for various reasons. Sometimes for special information; and sometimes, on a dull day, I turn to read over again such a series of papers as "The Market Gardens of London," or the "Early Writers on English Gardening."

I have said that the past, the present, and the future have all their power over us. I would say, Act well in the present, and when it becomes a past you will not be pricked by conscience, but comforted by a pleasant and not painful retrospect. Then, as to the future, I hope, as I have said, there is something bright ahead for us all. Clouds move away sooner than we expect.

A way through darkness is unexpectedly made by us or for us, and so we go on. Do the right and things will always come right. It chiefly depends upon a man himself as to what he is—happy or unhappy, successful or unsuccessful.

I will close with a few words of advice to all those who write, or read, or work—advice not unsuitable to those who understand a garden, by the one who understood human nature better than any other man, I mean Shakespeare. He says:—" 'Tis in ourselves that we are thus or thus. Our bodies are our *gardens*, to the which our wills are *gardeners*. So that if we plant Nettles or sow Lettuce, set Hyssop and weed-up Thyme, supply it with one gender of herbs or distract it with many, either have it sterile with idleness or manured with industry—why, the power and corrigible authority of this lies in our *wills*."

So it ever is. Three hundred years about have passed since these words of sterling advice were written, but they are just as true now as they were then. Follow them, and the coming year will be a happy one in present and in retrospect. I wish all, now for the nineteenth time, a truly happy new year.—WILTSHIRE RECTOR.

DRAINING.

THIS may be called a seasonable subject, for not only is winter the most suitable time for the operation to be performed, but when heavy rains come on the already soddened earth we can more readily discover where drains are imperatively needed than in summer.

As the subject has been frequently treated of it will not be necessary to say anything about the mechanical operations of draining, as these are, or should be, understood by every gardener. It may be well, however, to note the advantages which accrue from the proper draining of wet soil.

The first is that it materially raises the temperature of the soil. Soddened soil is always colder than dry soil, because what heat is absorbed by the soil is not employed in warming it, but in evaporating the water. Hence a wet soil retains its winter temperature long in spring after a dry soil has become warm and favourable for the growth of vegetation. Nay, even the winter temperature of wet soil is much lower than that of dry soil. This is an important point, as anyone can see if a moment's thought is given to the subject.

Not only does water when thus stagnant actually keep soil cold because of the heat being utilised in evaporating it, but the rain of summer, which further warms well-drained land as it passes through, has exactly the opposite effect on wet undrained land, for in that case it does not pass through the soil, but only adds to the water requiring evaporation. Hence in wet seasons crops on wet undrained soil frequently fail to mature at all.

Then draining, especially when liming is also practised, sweetens soil. Wet land is almost always sour and contains much matter that is hurtful to vegetation, but when the surplus water is run off by properly laid drains it carries much of this away. Then, as every heavy rain passes through the soil, it carries off more and more, till what was once a sour, cold, poisonous soil becomes sweet, warm, and fertile.

Draining fertilises a wet soil. Whenever air is excluded from a soil by water, the decaying manure and other vegetation form compounds hurtful to vegetation; but when the water is run off air enters, and then very different compounds—compounds which nourish instead of destroying—are formed. Then, as every heavy rain displaces the air, so it is the cause of the air being renewed; for as the soil again rids itself of superfluous water fresh air fills the pores of the soil, and fresh oxygen finds out the matters only awaiting its presence to become plant-food. Then drainage makes soil easily worked. It is impossible to improve soils by cultivation while they remain soddened. To attempt it is to do mischief. But on

this point we will not enlarge, nor will we do more than point to the fact that drainage materially improves the climate as well as the soil.

These facts are well known, and need hardly have been repeated but for the fact that, though great pains are often taken to insure perfect drainage, no drainage results, and some of the benefits accruing from drainage, though very much needed, are never reaped. Drainage is only efficient when it is the means of carrying off water; but when it does not do so is evident that the good looked for cannot result. In ordinary cases the drains have only to be properly laid to secure all the good results named above, because under ordinary circumstances all the conditions necessary are present. In every garden, however, there are circumstances when all the conditions are not present. For instance, inside borders for Vines, Peach trees, Figs, &c., are invariably and rightly provided with drainage. It does not follow, however, that it serves its purpose, for it is doubtful if in any great number of instances water is applied in sufficient quantity to insure the draining.

Very much of the water which falls on the land evaporates either directly or indirectly from the leaves of plants. Evaporation inside fruit houses cannot be less than what takes place outside, and we should fancy it to be a good deal greater, while such broad-leaved plants as Vines are pump enormous amount of water from the soil. True, gardeners apply more water to inside borders than was usual only a few years ago, while the drying during the resting period usual once is no longer practised, still almost all are perfectly satisfied if they can make sure of their borders being fairly saturated. Thorough-going practitioners in some few instances, in order to "make assurance doubly sure," may give enough not only to secure all the benefits of plenty of moisture, but also the benefits of drainage.

Our inside borders are, in almost all cases, heavily manured, in fact over-manured. For a time no great harm results, but in time the soil becomes overloaded, and those who can afford to do so renew the soil partially or wholly. Soils outside do not require such renewing, and it is an expensive process that few can afford. Care in manuring will help to stave off the evil day; the periodical application of slight dressings of hot lime will do much to keep matters right; but in order to maintain the borders in their fertility drainage—in other words, abundant application of water—is also necessary. Undoubtedly the great purifier of the soil is water. Injurious acids and salts are by its agency carried out of the soil into the drains and away, and nowhere are such to be found in such quantity as in over-manured undrained soils. Indeed it is not necessary that the compounds formed should be in themselves hurtful. Nitrate of lime or potash are manures of the greatest value when applied in moderate quantities, but when they accumulate in over-manured soils that are not drained they become positively destructive. Outside the weather-clerk takes care that such shall not happen if we only lay the pipes. In fact, outside such manurings are not given as are applied inside, and our object should, in the former instance, be how to guard against their loss. Inside we should take care that they do not accumulate and destroy.—SINGLE-HANDED.

MUSCAT OF ALEXANDRIA GRAPES.

I THANK "Vitis" for his kindly criticism on my note about the Knowsley Muscats on page 494, last volume. I did not intend to convey the idea that the success of these Muscats was due to their roots being in the sand under the flags at the back of the house. It would have been better perhaps if I had made the sentence finishing on the second line from the top read thus, "The flags were resting upon sand which, with the exception of those found in the newly formed border, were crowded with nearly all the feeding roots the Vines possessed."

I may add the Vines in question were planted in the spring of 1873, and were what is commonly called small "planting canes." In order to get them in without loss of time a trench the length of the two houses, and about a yard wide, was excavated along the front of the old border. This trench was filled with the best loam Mr. Harrison could obtain at the time, the usual sprinkling of bones, lime rubbish, and some wood ashes. Afterwards the whole border, new and old, received annually a small mulching of

manure, and through this the roots travelled after they had occupied the portion of new border to the sand. The houses in which the Vines were planted were very old and in bad condition, of various widths, and of different levels. Their removal and the building of the present structures necessitated lifting the Vines and finishing the new borders.

The Vines looked rather unsatisfactory for a time after lifting, but soon rallied, and have done well since. As regards temperature, Mr. Harrison believes in giving tropical plants tropical treatment in order to bring them to perfection, and remarks, "All Vines must be in first-rate health before we can reasonably expect to see a highly finished crop on them. My own opinion is that the 'crack' of air, the damping down, the manipulation of the foliage, and other set rules are not of primary importance in the colouring of Grapes if only the Vines are in the best of health and fairly cropped."—WM. BARDNEY.

NEW CARNATIONS.

IN answer to inquiries as to what are the best varieties of Carnations and Picotees, I now take the opportunity of naming what are the best of those already sent out which I have seen during the last season. Of those sent out last spring, beginning with the scarlet bizarres, I find that Edward Adams (Dodwell) is the best. With me the flowers were large and good. It is a high-coloured flower of the largest size, large broad petals with good markings, and moderately full. It is better for a little shading, as, like most high-coloured flowers, it is liable to flush in the white: this, no doubt, will disappear with age. The next good variety I have seen is Fred, sent out in the autumn of 1880 and in 1881. It is a noble flower of fine proportions, possessing the best white ground of any S.B. sent out by Mr. Dodwell. The petals are large, with perfectly smooth edges and markings. A few more petals would greatly add to its value as an exhibition flower.

Of the new crimson bizarres the best I have seen is Master Fred (Hewitt), sent out in the autumn of 1881. It is a very large high-coloured flower with a fine white, and altogether one of best C.B.'s I have ever seen. It is a full flower with petals of the largest size, the colours well laid on. Another flower in the same class, and which will be invaluable to the seedling raiser, is Thomas Moore (Dodwell), a thin high-coloured flower of the finest properties; it was sent out in autumn, 1880. Another good flower is Harrison Weir (Dodwell), C.B., sent out in 1881; a pale flower, very near a pink and purple bizarre. This, no doubt, is a seedling from Rifleman, as it has the bold markings and fine petal of that handsome old sort.

In pink and purple bizarres I have only grown one new one. It is called Stanley Hudson (Dodwell), and was sent out in the autumn of 1880. It is a rather thin flower with bright clear markings, and seems to possess the same properties of sporting as some others of the pinks and purples do—notably Sarah Payne; it having sported to a purple flake with me this season, in which state it is a really handsome flower.

I have not seen any new purple flakes, only the sport above referred to. Amongst scarlet flakes there is a fine new variety which I have grown; it is called Thomas Tomes (Dodwell), a high-coloured flower with very broad petals. It will be a great addition to a scarce class.

Of rose flakes I have grown one—a pale rose, a sport from Lamp-lighter, C.B. It sported with the late Mr. John Fletcher about three years ago. He named it Sporting Lady. It is a rather late flower, which with it as a rose flake is a good property, many of them being too early. It is something in the style of Mrs. F. Burnaby with a better petal than that sort.

Notes on new varieties of Picotees must be reserved till a future issue.—G. RUDD.

THE CUCUMBER DISEASE.

I ENCLOSE sketches of three weeds found in the turves (grass sod) here. No. 1 I believe is the common Buttercup; it has a small bulbous root. Nos. 2 and 3 are somewhat similar in shape of leaf, but are rooted differently, one if not both having tree-like roots—hard and wiry. These roots I firmly believe are the cause of one form of Cucumber disease which has been troubling some of your readers. When carefully examined they have small lumps along them like beads. These beads I think each contain one or more of the insects which attack the Cucumber roots and eventually destroy them.

I have been thinking of building a kind of air-tight stove in which to place all turves and manure before using, and thoroughly fumigating with sulphur. Has it been tried? or do your readers

think it worth trying? An answer will oblige, also names of the weeds of which I give an outline of leaves, if the outline is sufficient for you to identify them.—HORTUS.

[No. 1 is *Ranunculus bulbosus*; No. 2, probably *R. acris*; and 3, *Potentilla Tormentilla*—all abundant in meadows.]

A FEW years ago, when I was foreman at Petworth Park, the Cucumbers were badly affected by a disease similar to that described by Mr. Harding. Mr. Jones, then head gardener, tried everything he could think of, but to no purpose, though they kept freest from it grown in a compost chiefly of peat. After Mr. Jones left his successor, Mr. Breese, turned all the Cucumbers and Melons out of the houses and grew them in pits and frames, some of which were a quarter of a mile away, but with the same result. He then tried them in the plant and Pine stoves. He tried strong dressings of lime, then painted the house and dug new soil from a great depth, and some was obtained from long distances, as were also the fresh plants; but the only way he could get them moderately free was by growing the plants in pots in the Pine stove.

Not long ago I paid a visit to Petworth Park. I was astonished to see the Cucumbers growing as clean as though the disease had never been there, and I was informed that it was destroyed by simply using all rain water, as the water that was laid on contained much lime and, I suppose, something else that did not suit them. I do not say this will banish all the disease in the country, but it is certainly worth a trial.—P. A. B.

PINUS INSIGNIS FOR A SHALLOW SOIL.

So far as I am aware there are only two reasons for the prejudice which has so long existed against the extensive planting of *Pinus insignis*, and these are its being "spring tender" and its liability to be blown over by high winds. May I add a third, and say that there is much difficulty in obtaining it in quantity from the nurseries? From my own experience, as well as from what I have seen of it in various parts of the country, I believe it only suffers from late frost in bleak exposed situations, or in a damp cold situation at the bottom of a valley. Great elevations are unnecessary; some of the finest specimens in the country are flourishing bravely upon the slopes of Lamorran only a few feet above the level of the sea. Well-drained slopes and shelter from high winds in infancy and youth, combined with careful planting and due exposure on all sides to air and light, being the only factors to success there; for the great range of temperature in the Cornish valleys is proverbial. It answers equally at an elevation of 500 feet above the sea in Sussex upon slopes facing east and others facing west, and it is the free healthy growth of these trees in a poor shallow soil that leads me now to draw especial attention to it. Whether it will eventually attain its full size in this soil is uncertain; but the Silver Fir (*Picea pectinata*) has done so, and *P. insignis* certainly bears favourable comparison with Silver Firs of the same age. As to its being blown over, that evil was, I believe, clearly traced to the careless planting of trees turned out of pots with roots uncoiled, and thrust into a hole quite in the "sticking-in" fashion that so often leads to failure.

The profuse habit of the tree, its handsome appearance, and the singularly lively green hue of its foliage at this dull season of the year renders it very desirable for ornamental purposes. Still more important is the fact that its timber is sound and durable. I am unable to say anything about fineness of grain; that may render it valuable for other purposes than building, but I may usefully repeat a former statement of boards sawn from an English-grown tree being perfectly sound after being left exposed upon a building for twelve years unpainted.

In a list of Coniferæ before me its height is given at from 40 to 80 feet. Is the higher number a correct maximum? I have seen it fully that height, and the trees showed no indications of a cessation of growth.—E. LUCKHURST.

SUTTONS' READING EXHIBITION BRUSSELS SPROUT.—Allow me to endorse Mr. Horsefield's good opinion of this (page 542), and to add that 18 inches is by no means its average height of growth, for we have here a plot of about four hundred plants that are at least double that height, and are covered with the most perfect "buttons" from top to bottom. Length of stem is a very necessary requirement in a Brussels Sprout—*i.e.*, if amount of produce be desired; and this height, being one of the chief characteristics of this variety, adds to its value immensely. If it has a fault at all, it is that the "buttons" grow too large, at least in regard to appearance at table. This, however, is but a little matter so long as the quality is right, and this is certainly of the first order. In appearance it is distinct from every other variety that I have yet seen, being of a pale green colour, and

has deeply corrugated foliage, more after the type of a Savoy. The Messrs. Sutton are to be congratulated on its acquisition.—W. L. H.

THE MADRESFIELD COURT GRAPE.

It is not because the rarer fruits are at all times the best fruits that they are the more appreciated. It is quite common for things to be appreciated simply because they are rare, but when we have something rare and good it is appreciated for its merit's sake. So it is with the Madresfield Court Grape. This Grape is one that only has to be tasted to be appreciated and sought after. Some time ago I had the honour of a visit from Mr. Ingram, gardener to the Duke of Rutland, when the merits of this Grape came under discussion. His advice was, "Don't risk too many of 'it.'" Some time after I was discussing its merits with one of our best Grape growers (Mr. Jowsey of Sedbury Park), when he related the following. Having sent a dish in the day previously of the Madresfield Court, one of the young gentlemen inquired of him the name of the Grape, which, on being given, the reply was volunteered, "If I were a gardener I would grow nothing but the Madresfield Court." This year, when Mr. Wescott, Mr. Hunter, and Mr. McIndoe visited me after my Grapes generally had been favourably commented on, the latter remarked concerning the Madresfield Court, "This is the best you have shown us." So much for the opinions of those well qualified to judge as to the merits of this Grape.

I believe that Madresfield Court well grown is the most delicious and the most magnificent Grape that can be placed on a gentleman's table. To succeed with it fully compensates for all the risk of failure. It is free-growing, a free setter, and very prolific. Its faults are that it cracks badly, and, worse, if a cracked berry escapes attention for a few days all the berries near it will quickly decay. It will stand more liquor than the Duke of Buccleuch, but otherwise the faults of these two Grapes are much alike. To succeed with them their roots ought to be completely under control. The gardener who succeeds in sending in good condition to his master's table those two magnificent Grapes is most surely is on the path that leads to a better position. This is the possible, nay, probable, prize obtainable; and, for encouragement, it is now known that these Grapes can be well grown.—JOSEPH WITHERSPOON, *Red Rose Vineries*.

CULTURE OF HYDRANGEAS.

HYDRANGEAS are very useful plants for house and conservatory decoration. It is generally the object of a gardener to have as much bloom as it is possible to have on plants grown in small pots, and if Hydrangeas are well treated they are very satisfactory in this respect. I have seen them with heads of bloom 18 inches in diameter in 48-size pots.

To have Hydrangeas in good condition the stock plants should be well exposed to the light in the spring, started in a greenhouse temperature so that the cuttings should not become weakly. When good cuttings can be procured they should be inserted singly in small pots, placing them in a close propagating box in an intermediate temperature. After the cuttings have rooted place them in a cool frame close to the glass, to be well ventilated. Repot them into 48-pots, pressing the soil firmly, which should consist of three parts loam and one part well-decayed manure. Place them out of doors well exposed to the sun and air. The growth they will make under this treatment by the autumn will be short and sturdy, not more than 3 or 4 inches long. Leave them in the open air until they lose their foliage, and winter them in a cold frame. About the end of February commence to introduce a few at intervals into an intermediate temperature, supply them with clear water until the flower truss appears, then supply liquid manure until the truss is fully expanded.—A. YOUNG.

PEAR PASSE CRASANNE.

THIS must rank as one of the most delicious late Pears known. The fruit, although not large, is very melting and rich, and must be classed with such Pears as Josephine de Malines and Bergamot Esperen, which are deserved favourites with connoisseurs. Passe Crasanne succeeds well on the Quince on a wall having a west

aspect; it also does well on the Pear stock, although the fruit does not come so large. Like others of the same size and race, when the fruits set thickly it is desirable to thin them, and those retained will become larger and be better both in appearance and flavour. The figure represents the size and form of this Pear. The skin is covered with russet, the yellow ground colour being only faintly visible on the shaded side. This excellent Pear was raised by M. Boisbunel of Rouen, and first fruited in 1855. Its season of use varies from January till March.

THE CULTIVATION OF THE CHRYSANTHEMUM.

DURING the past few years few plants have deservedly secured more favour or become more popular than the Chrysanthemum. As an instance in proof, the other day at a fashionable wedding in the west end of London I noticed the bridesmaids each carried a

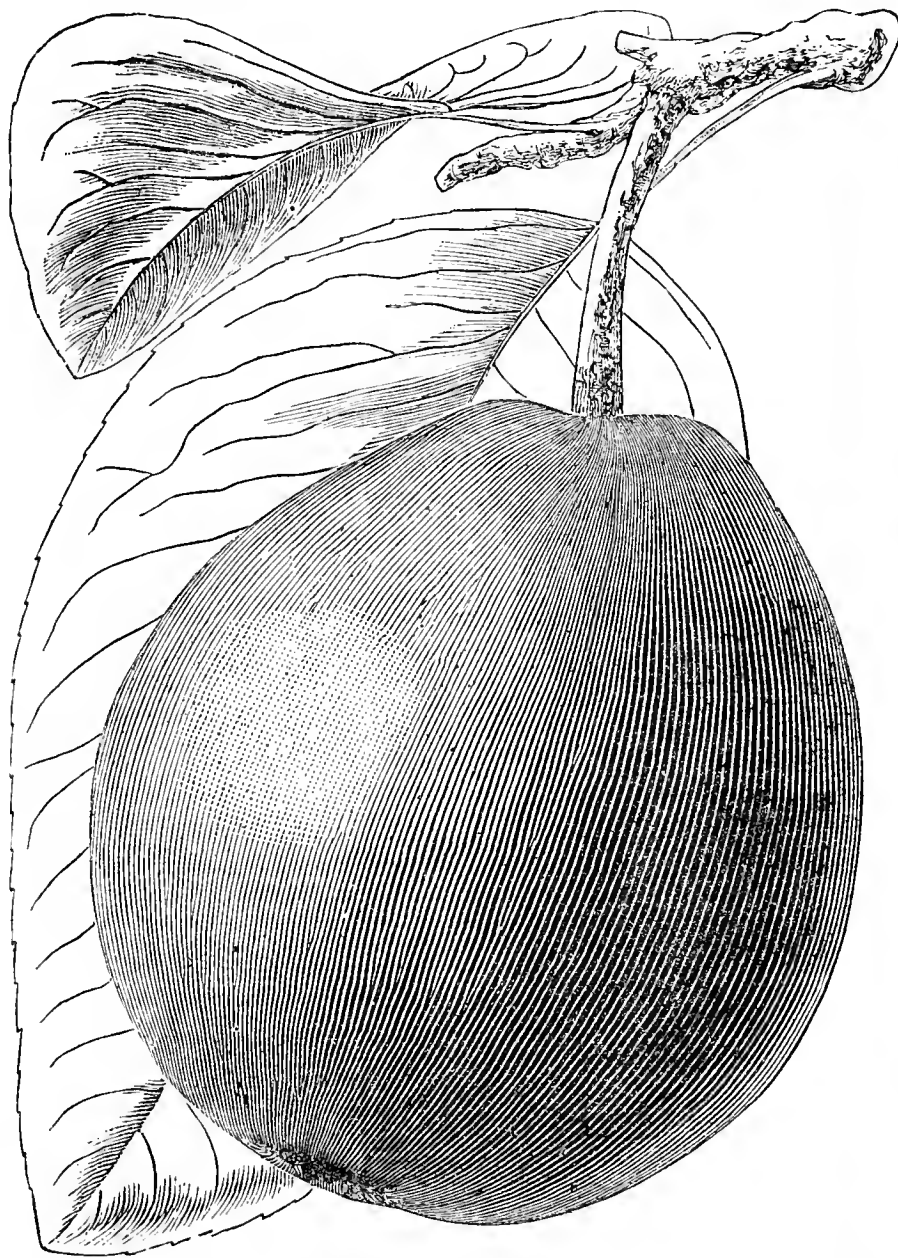

Fig. 1.—Pear Passe Crasanne.

bouquet of Chrysanthemums. Again, except in the neighbourhood of London, a few years ago Chrysanthemum societies were almost unheard of, but now such societies are in all parts of the country. I am also very pleased to hear that this year several new societies have been established with considerable success. Whether to the cottager and artisan, the amateur or the professional gardener, few plants will give more pleasure, greater results, or cause more enthusiasm than the one under notice. With a moderate number of varieties flowers may be had from the end of September to January, and yet how few people know to what perfection the Chrysanthemum may be grown. Even from gardeners I have often heard something like the following remarks:—"Oh! I don't grow them for fine flowers, I grow them for cutting." To me this is a paradox, for will not fine and perfect flowers answer that purpose? My idea is, whether it is a Chrysanthemum, a bunch of Grapes, or any other thing a gardener has to produce, one perfect well-grown specimen is worth fifty of indifferent quality. But my object in these notes is to describe the methods by which such splendid flowers may be produced as have lately been seen at exhibitions, and I will therefore as briefly as possible detail my experience.

PROPAGATION AND CULTURE.

The first thing to commence with is sturdy cuttings and offshoots taken from the base of the old plant at any time up to March. Insert the strongest singly in thumb pots, the weaker ones four or five round the edge of a large 60-size pot. Some writers have recommended autumn, others spring, as the best time to insert the cuttings; but I think that it matters little at what time this is done so long as they are well rooted by the end of March or early in April. It is the treatment and attention they receive after this time that is of the most importance. I have proved beyond dispute that as good plants with foliage to the rim of the pot, and producing as good flowers, may be grown from cuttings taken in March as from cuttings taken in November. I take all the cuttings I can about the first week in December for this reason, that it is not convenient to keep the old plants of, say, 150 varieties until March. I place the cuttings in a cold frame, keeping them moderately moist, and except giving air when the weather is favourable no further attention is required until the end of March, by which time all should be well rooted; they should then be potted in large 60-size pots, and again transferred to a cold frame, ventilating freely. About the first week in May they should be ready for a shift into 32-pots, after which they should be placed in an open airy position. The second week in June they will require their final shift into 8 or 9-inch pots (specimens into 10 or 12-inch pots), which are of ample size to suit all their requirements; they should again be placed in a similar position, a row on one or both sides of a path. A few stakes are driven into the ground about 30 feet apart, and a wire or cord passed from one to the other answers well to tie the plants to during the growing season. Here they may remain until the first week in October, when they should be transferred to an ordinary greenhouse, Peach or orchard house, or vinery, where they may obtain plenty of light and air to develop their flowers. A little heat in dull wet weather, so as to keep as dry an atmosphere as possible, is beneficial to them.

COMPOST.

The compost I use for the first potting is one-half loam, the other well-decayed manure and leaf soil, with a little sand added; a similar soil when shifting into 32's. When putting them into their flowering pots I have used and found two-thirds fibrous loam, one-third fresh horse droppings, with a few half-inch bones over the crocks, suit them admirably, but I do not place soil as a matter of first importance. It is the time the buds are taken and the feeding they afterwards get upon which results depend. When the bud is set the plants should be supplied regularly with liquid manure, not too strong at first, but gradually increasing it in strength until the flowers are well expanded, when the use of stimulants should cease. I believe plants, like human beings, are benefited by a change of food; therefore do not always water them with the same manure if a change can be procured. I have no faith in many of the artificial manures. Doubtless they are useful to many, but where cow, horse, sheep, or fowl manure can be procured, or the drainage of a manure yard, stables, &c., nothing else is required. Should green fly attack the plants in the spring dipping them into a pail of tobacco water will soon destroy the pest. With specimens it is a good plan to dust the under sides of the leaves with sulphur before housing to kill or prevent mildew.

DISBUDDING.

The foregoing remarks apply equally to the incurved, Japanese, Anemone, and reflexed varieties. I am pleased to see the latter two sections worthily becoming greater favourites every year. Early in April the question will arise, For what purpose are the plants required? whether for specimens or grown on what is termed the natural system, to produce fine flowers fit for exhibition. Having cultivated the Chrysanthemum for some years I do not know of any one system which you may lay down as a hard-and-fast line to follow, and guarantee results. What is termed the natural system is to let the plants grow as they will until they show the summer bud, which will generally be from the middle of June to the end of July. This bud is useless. Several shoots are produced below it, when as many may be left as the cultivator deems fit—from three to eight, variety and strength of plant to be considered. These shoots, being left to grow, will each show another bud, which is termed the crown bud, and that is the bud to produce fine flowers, providing it comes at the proper time. When first seen it is very small, and has three vigorous shoots around it. These should be at once pinched off, likewise all after growths, to direct the whole resources of the plant to the flower. The difficulty is to induce the plants to show this bud at the proper time, for upon this (providing the plants are healthy and vigorous) depend the future results. Take three plants of any one variety, treat them alike in every respect; the probabilities are one will show the crown bud in the middle of July, another in the middle of August, the third not until September. My opinion is, the time for them to show this bud is between the 10th of August and the 7th of September. Seasons vary, but from several years' experience I have no hesitation in saying a great percentage of buds taken between the above-named dates will prove satisfactory. If taken before, they are apt to become hard and not open properly. The incurved varieties will have narrow petals, and go more like a reflexed flower, whereas the Japanese will resemble a hen-and-chicken Daisy—that is, a number of small imperfect buds will form around the main one. This season I saw one bud of

Madame B. Rendatler with twenty-eight smaller ones around it, some of them having stalks 4 inches in length, but should the buds not come sufficiently early for them to develop fine flowers will never be produced.

To obtain this bud at the proper time much may be done by knowing which varieties are early and which late, and stopping them accordingly—that is, should one plant of any given variety show the summer bud early in June, which at times they will do, the crown bud would most likely show itself at the beginning of July, which is too early. Such a plant I should say cut down to about 9 inches or a foot from the pot; you thereby dwarf your plant, and will most probably get the crown bud between the dates I have mentioned. Again, should another plant show its first bud the end of June I should cut it down the same. I do not advise any one day or time to cut them down, neither do I say Serve a whole collection the same, but anyone knowing the varieties and the time required to develop the flower of each variety may by judiciously cutting back his plants get much better results than by leaving the plants to grow naturally. He will also have them much dwarfer, which is a great consideration where they are required for the decoration of a conservatory.

TRAINING

I have no great admiration for specimens, therefore have not practised the tortuous methods of training that may often be seen at exhibitions—that is, tying the plants to wires in all shapes varying from an umbrella or inverted saucer to the model of an Egyptian pyramid. Ordinary bushes, with no training except stopping, and sufficient stakes to support their blooms, are more ornamental and useful and produce much finer flowers than the monstrosities often seen. To obtain bushy specimens the plants should be stopped when about 6 inches high, and all after growths likewise stopped at the second joint until the second week in July, when they should be left to grow as they will until the bud appears. They will then require disbudding, so as to only leave the terminal bud on each shoot. Early in October they may be tied out as required. I much prefer Pompons as specimens to either of the large-flowered sections. The preceding remarks will equally apply to Pompons, only they may be stopped at least ten days later than I have advised for the other varieties, though it is an unnatural way. Pompons grown as standards if not overtrained are not to be despised for decorative purposes. I generally grow a few with stems about 2 feet high, having heads from 2 to 3 feet in diameter without any training whatever except after the stems are of sufficient height, stopping them as directed for bush specimens.

VARIETIES.

All the varieties of reflexed and Anemone are worthy of cultivation, also a great many of the Pompons. As there are so many varieties I shall only name the following incurred and Japanese varieties, which are amongst the best in cultivation.

Incurved.—John Salter, Empress of India, Golden Empress of India, Alfred Salter, Queen of England, Golden Queen of England, Lady Slade; Angelina, a light bronze sport from Lady Slade; Princess of Wales, Prince of Wales, Prince Alfred; Lord Wolseley, a bronze sport from Prince Alfred; Eve, Mabel Ward, Hero of Stoke Newington, Princess Teck, Mrs. Heales, Mr. Gladstone, Golden Eagle, Lord Derby, Incognita, Mr. Bunn, Nil Desperandum, Princess Beatrice, St. Patrick, Refulgence, Baron Beust, Jardin des Plantes, Beauty, Empress Eugénie, Isabella Bott, Mrs. Dixon, Mrs. G. Rundle, Mr. G. Glenny, Golden and White Beverley, Barbara, Lady Harding, Mrs. W. Shipman, Mr. Corbay, Venus, White Venus, Enamel, Novelty, Le Grand, Duchess of Manchester, Mr. Brunlees.

Japanese.—Meg Merrilees, Bouquet Fait, Elaine, Fair Maid of Guernsey, Baron de Prailly, Grandiflorum, Bronze Dragon, Garnet, The Danio, Fanny Boucharlet, Criterion, Lutea Striata, Alba Striata, Hiver Fleur, M. Ardene, M. Delaux, Mdle. Anna Delaux, Guillaume Delaux, M. C. Audiguier, L. Incomparable, Mdle. Moulise, Père Delaux, Thunberg, Comte de Germany, Boule d'Or, Flambeaux, Balmoreau, Triomphe de Chatalet, M. R. Larios, Cry Kang, Soliel Levant, James Salter, Lady Selborne, Sarnia, Dr. Macary, Peter the Great, Sultan, Oracle, Plantagenet, Alba Plena, Mons. Bertie Rendatler, Comtesse de Beauregard, Rubra Striata, Agrément de la Nature, Apollo, Fleur Parfait, and Arlequin.—J. LYNE, *Belvedere*. (Read at a meeting of the Wimbledon Gardeners' Society).

NOTES ON GRAPES—CRITICISM.

I WOULD trespass farther on your good nature to say that my reasons for thinking "Honi Soit qui Mal y Pense" excluded the Black Hamburgh from early vineries was, that in his "comparative estimate," not of new kinds only, but of such old sorts as the Muscat of Alexandria, Lady Downe's, and Cannon Hall Muscat, &c., he does not so much as mention it, but gives distinct general advice, that "For early work I would recommend everyone to have a house of the Duke of Buccleuch and a house of the Madresfield Court." With late Grapes till April and May now-a-days, I would really like to know what this means if it does not mean the exclusion of the Black Hamburgh, for in an ordinary way so many early Grapes could not be consumed, even in the largest places, let alone by "everyone," if we are to regard these

tried sorts as only auxiliaries to early Hamburgh houses. Your readers could, I submit, put no other construction on your correspondent's words than I have done, and everyone I have spoken to on the subject apprehended them in that sense and no other.—HEAD GARDENER.

IN reply to "Head Gardener," on page 577, while I decline to notice his personalities, I maintain every word I wrote about Madresfield Court and the Duke. I never said they were Grapes of easy culture, but pointed out defects that had to be overcome before they could be successfully grown. When these defects are combated no two finer early Grapes can be found. "Notes about Grapes" does not imply that all the kinds referred to are recommended for "general culture" to the exclusion of others. This was made plain on the page above quoted.—HONI SOIT QUI MAL Y PENSE.

AS the writer of the article in which the Muscat Hamburgh is favourably spoken of, I have to say that I never advised the "general culture" of this Grape, as is stated by "Head Gardener" on page 577. A correspondent, "J. E. R. I.," wrote asking about specified Grapes. I replied, and in so doing was careful to refer to the defects of certain of the Grapes mentioned. He asked to be advised if he might plant one Vine each of four varieties that he named. Can this be called "general culture?" Success with Muscat Hamburgh means something to be appreciated. I told "J. E. R. I." that when successfully grown Muscat Hamburgh is a grand Grape. Who will deny this? It can be grown, and if anyone wishes to try it why should they be advised not to do so, especially when its weaknesses are pointed out and are capable of being overcome? No one possessing the smallest amount of knowledge concerning Grapes would think of disparaging the Black Hamburgh. It is an old and trusty friend, but when something extra fine in regard to flavour is wanted this old favourite must yield to others.—VITIS.

"HEAD GARDENER'S" method of criticism will not commend itself to all readers. It was apparent on the face of the article which he criticised that it was not intended as a mere list of "Grapes for general culture." As to advising "everybody" to grow the Duke of Buccleuch, it would be obvious to most readers that the meaning of the phrase was that everybody should grow it who are able to do so, and useful hints were given on its requirements. If "Head Gardener" is not one of these he can scarcely be regarded as an impartial critic. If he can give an assurance that he grows it well, then his remarks will have some weight. That it can be grown well evidence has been adduced, and it is not usual for those who succeed to condemn this variety. In his allusion to the exclusion of the Black Hamburgh by "Vitis" your clever critic is quite out of court, for "Vitis" distinctly expressed his surprise that it was not included in the list of Grapes for September. How different in tone is Mr. Roberts's article last week. This is a model of criticism, as the merits or failings of the varieties alone are pointed out without any unpleasant allusions to any writer whose experience differs from his own. I can grow the Duke, but everybody cannot, neither can "everybody" grow the Black Hamburgh. Means and skill are necessary elements in Grape culture, and moderation in expression is an important element in effective criticism.—ANOTHER HEAD GARDENER.

[On this account we have modified some of the expressions of our correspondent, and prevented him giving an example of what he condemns. Matters, not men, are proper subjects for criticism.]

COLLECTIONS OF SEEDS.

WE must thank your correspondent, "C. T. H." (page 565, last volume), for an opportunity of explaining the object and advantages claimed for our collections of garden seeds. We thank your correspondent, because had we attempted an explanation without his suggestion having appeared our action might have been open to a charge of seeking to obtain a gratuitous advertisement for our goods.

Your correspondent is not quite correct in all his assumptions. One of the most important reasons for our offering these collections is that by so doing we are enabled to prepare a very large number, running into some thousands of these boxes of seeds before the high pressure of our busy season comes on. This, it will be seen, provides occupation for the large staff that we must at all times employ, and by the early preparation of the boxes the labour of some three hundred or four hundred men, women, and boys is released, and can then be devoted to the urgency of orders which come at a certain season of the year for immediate execu-

tion. There is again a saving in making up a large number of boxes at one time; but this to a great extent would be absorbed if purchasers were to send orders for *irregular quantities* such as your correspondent suggests, because each order would not only have to be executed on its own merits, but there would be a considerable addition to the labour and expenses of supervision.

There is no doubt that purchasers of these seeds save fully the amount "C. T. H." states, and it would be simply a repetition of the famous fable if we or any other house were to attempt to make up a box to please everybody. We claim, however, for our boxes that, in addition to the great saving in cost, the varieties contained comprise for all general table purposes the best standard sorts in cultivation.

We append herewith a copy of the average contents of our guinea box, and we respectfully challenge any gardener to suggest a better collection as an all-round one to produce quality both for exhibition and for table.

Peas.—One pint each of the following varieties:—Carters' First Crop, G. F. Wilson, Hundredfold, Essex Rival, Champion of England, Bishop's Longpod, Dickson's Favourite, Telegraph, Standard, Yorkshire Hero, Carters' Selected Tom Thumb, Ne Plus Ultra, Fortyfold.

Beans.—One pint each of Improved Windsor, Seville Longpod, and Giant Longpod; half pint each of Carters' Champion Runner, Early Prolific French, and Longpodded Negro French.

One packet each of Beet, Carters' Perfection; Borecole, Dwarf Green Curled; Brussels Sprouts, Carters' Perfection; Broccolis, Carters' Summer, Carters' Early Sprouting, and Adams' Early White; Cabbages, Carters' Early, Carters' Miniature Drumhead, and Enfield Market; Savoy, Dwarf Green Curled; Colewort, Hardy Green.

Carrot.—1 oz. each of Long Red Surrey, James' Intermediate, and a packet of Carters' Improved Horn.

A packet each of Cauliflower, Carters' Dwarf Mammoth; Celery, Carters' Incomparable Crimson and Sandringham White; Cucumber, Carters' Champion and Best of All Ridge; Endive, Best Green Curled; Leek, Musselburgh; Lettuces, Carters' Giant White Cos, Winter Cabbage, Winter Cos, and All the Year Round; Melon, mixed prize varieties; Onions, White Spanish, Giant White Tripoli, Long-keeping, and Blood Red; Parsley, Carters' Covent Garden Garnishing; Parsnip, Carters' Maltese. Radish, 2 ozs. of Long Particular Long Red; and a packet each of mixed Turnip and Scarlet Olive-shaped. Cress, 2 ozs. of Plain, 1 oz. of Curled, and a packet of Australian. Mustard, 4 ozs.; Spinach, 2 ozs. each of Round and Prickly-seeded; Turnips, 1 oz. each of Carters' Nimble Six Weeks, and Orange Jelly; and a packet each of Tomato; Vegetable Marrow, Moore's Cream; pot herbs, mixed.

We think it would have served the interests of the gardening world if your correspondent had been a little more explicit upon the following point. He says—"This looks very well, but I was obliged to buy certain sorts that were deficient, although there were enough of those valueless sorts to sow a large garden." We have no reason to think that your correspondent has purchased one of our boxes, but we should like him to state for the benefit of everybody what seeds were "deficient," and in addition give the names of those varieties that were "valueless."

In conclusion, we can only add that, great as the sale of these boxes of seeds is with us, our surprise is no less considerable that they are not more generally adopted; and if your correspondent "C. T. H." thinks he can make a selection which would lead to increased popularity of these boxes we would cheerfully adopt it if it were practicable, and we should thank him for the suggestion. We have, however, given many years of personal attention to this subject, collections of seeds having originated with our house upwards of fifty years ago.—JAMES CARTER & Co.

CULTURE OF STEPHANOTIS FLORIBUNDA.

FEW flowers are more prized than those of the Stephanotis, and there are not many gardens in which this favourite stove climber is not grown. Its liability to be infested with mealy bug appears to be the great drawback in its cultivation, but this pest can be kept down more easily than many suppose; in fact, keeping it clean is the chief point to be aimed at, for mealy bug spoils the blooms, rendering them deformed and unsightly. If the plant is clean there is no better way of keeping it so than by continuous syringing with rain water; but if infested, the best way is to pour a quarter of a pint of petroleum in three gallons of water and well syringe with that. To apply it properly two persons are required, one with his syringe continually disturbing the water so that the oil does not rise to the surface, while the other applies it to the plant. A porous loamy soil is the best suited for it, and, though often grown in pots, it thrives best when planted in a prepared border

where there is plenty of root-room, for liberal cultivation always gives the best results.—J. MACDONALD.



THE TEMPERATURE IN LONDON during the last week of the old and the opening days of the new year was unusually high. On Wednesday the 27th ult. the mean temperature was 53.9°, exceeding the average by 14.9°. The lowest night temperature was 29.8° on Sunday. On Tuesday in this week at noon 54° were registered, and a correspondent remarks that on the 12th of June last the temperature was 52°, and on the 13th of the same month 51°.

VISITORS to the principal London flower shows have no need to be told of the immense improvements that have been made so rapidly amongst TUBEROUS BEGONIAS. The large size, substance, brilliancy, and chasteness of the flowers are admitted by all who have seen the newer varieties; but as all our readers have not seen them, Messrs. John Laing & Co. of Forest Hill, who are raisers and cultivators of high repute, have provided coloured plates of the leading varieties, which well represent the flowers, and which can scarcely fail to command attention. These plates measure 23 by 17 inches, one including twenty double varieties and the other fifteen single forms, most of which are reproduced with great fidelity, and the effect of the groups is gorgeous.

IT will be in the recollection of our readers that the late Mr. William Hinds, whose death we announced last week, published two years ago a small work, entitled "STRAWBERRIES ALL THE YEAR ROUND." A few copies of this manual remain unsold, and with the object of disposing of them for the benefit of Mrs. Hinds we will readily supply copies to those of our readers who may desire them for 9d. each, post free; the manual was originally published at 1s. 6d. Mr. Hinds was an expert in Strawberry culture, hence the instructions he has given are sound. We are sorry to learn that his widow and child have been left quite unprovided for. Several friends having expressed their willingness to assist, Mr. Wynne will be glad to receive any contributions that may be sent to him at the *Gardener's Chronicle* office, 41, Wellington Street, Strand, W.C.

RELATIVE TO FUCHSIAS IN WINTER, "F. J. C." will "be obliged if any of our readers can inform him if there is any Fuchsia which would bloom freely during the winter months if planted in a border against the back wall of a greenhouse, or whether an intermediate house would be necessary for attaining the object in view." We shall be glad if any of our readers who may have Fuchsias in winter will name the varieties and state the conditions under which the plants are grown. So far as we know the distinct variety *Dominiana* is one of the best for winter, and flowers well in a suitable position in a warm greenhouse, but there may be others equally good.

A CORRESPONDENT sends the following:—"Though a comparative novelty among Maidenhair Ferns, *ADIANTUM MUNDULUM* is certain to become popular, more especially where button-hole bouquets are constantly in request. It somewhat resembles *A. cuneatum*, but the fronds are much smaller and the pinnae comparatively larger and of a rich green colour—altogether proving just the size and form for button-hole bouquets. It is as easily cultivated as *A. cuneatum*, and is said to be well adapted for greenhouse culture. Ours are in heat."

CONCERNING THE HARDINESS OF *CORDYLINA INDIVISA*, "G. L." writes:—"Bravely has a fine specimen of *Cordylina* full

8 feet high borne the first brief spell of winter weather; 14° of frost on one night and 12° on another have not hurt it. Its graceful leaves still retain a bright green hue, but some of them are no longer graceful, for the snow has crippled them. Fain would I erect some shelter to prevent this, but the plant is in a conspicuous position near the house, and it must be left to take its chance. What is the greatest degree of cold it has been known to bear with impunity? I know there are some very large plants at Torquay which must have been left undisturbed in the open air for several years, and hope to see others established in favourable situations along the south coast."

THE same correspondent also sends the following note on *DIPLOPAPPUS CHRYSOPHYLLUS*:—"Not for its flowers or summer guise do I value this dwarf shrub, but for the bright rich golden hue of its leaves and branches now. Its leaves are very small, its branches slender, and its general effect may not inaptly be termed Heath-like, and yet it is decidedly more elegant than any Heath. Its singularly beautiful appearance in winter will render it a favourite for the front of shrubby borders."

THE following are the dates of the Meetings of the ROYAL HORTICULTURAL SOCIETY'S Fruit and Floral Committees, Exhibitions, and Promenade Shows for 1883:—Fruit and Floral Committees: Tuesdays, January 9th, February 13th, March 13th and 27th, April 10th and 24th, May 8th and 22nd, June 12th and 26th, July 10th and 24th, August 14th and 28th, September 11th, October 9th, November 13th, December 11th. Promenade Shows: Tuesdays, March 27th, April 10th, May 8th, June 12th, and July 10th. National Auricula Society's Show, Tuesday, April 24th. Great Summer Show, Tuesday, May 22nd, and Wednesday, May 23rd. Implement Exhibition, Tuesday, May 22nd, to Thursday, June 21st. Pelargonium Society's Show, Tuesday, June 26th. National Rose Society's Show, Tuesday, July 3rd. National Carnation and Picotee Society's Show, Tuesday, July 24th.

WE may also remind our readers that the PRIVILEGES OF FELLOWS AND MEMBERS of the above Society for the year 1883 are as follows:—A Fellow paying four guineas a year is entitled, 1, To two tickets, both of which are transferable, and will admit the Fellow or the bearer without payment to the gardens and to the Great International Fisheries Exhibition to be held therein, and to all shows in connection therewith. Each ticket will also entitle the bearer to a season ticket-holder's place at the opening ceremony of the Fisheries Exhibition, to be held in the Royal Albert Hall, for the reduced payment of 5s. 2, To admit daily (Sundays excepted) eight friends by written order to the Garden at Chiswick. 3, To visit the shows at twelve o'clock, being an hour earlier than the general public. 4, To receive forty orders giving free admission on all occasions until the 15th of April, from which date till the 1st of May the Gardens will be closed, except to Fellows. These orders will be available on the payment of 6d. during the Fisheries Exhibition on all shilling days. 5, To a share of such seeds, plants, and cuttings of Vines and fruit trees as the Society may have in sufficient numbers for distribution by ballot or otherwise. 6, To purchase the flowers, fruit, and vegetables grown at Chiswick which may not be required for scientific purposes by the Scientific, Fruit, and Floral Committees. 7, To receive a copy of the publications of the Society. 8, To the right of voting at all meetings. 9, To be relieved (on giving previous notice in writing) from the payment of subscriptions while resident abroad. 10, To free admission to the reading-room and Lindley library. A Fellow paying two guineas a year is entitled to—11, One ticket, giving the same privileges of admission as in No. 1. 12, Half the privileges mentioned in Nos. 2, 4, and 5. 13, The same as Nos. 3, 6, 7, 8, 9, and 10. Present guinea members are entitled to one ticket, not transferable, giving the owner admission on all ordinary occasions, and to all shows at Chiswick

and South Kensington, but not to the annual or special general meetings or fêtes or conversazione of the Society, and which does not entitle the member to vote on any matters relating to the affairs of the Society. The Society being incorporated by Royal Charter the Fellows incur no personal liability beyond the payment of their annual subscriptions. Entrance fees of new Fellows joining are suspended for the present.

— "W. I." writes that "ERANTHEMUM ANDERSONII, a native of India, and introduced, if I remember rightly, by Mr. Bull, is not so generally grown as it deserves to be. Why I cannot imagine, as it is easily cultivated and produces handsome spikes of small Orchid-like and nearly pure white flowers, the lower lip only being mottled with purple, in great profusion during the dull late autumn and early winter months. The spikes produce a second display sometimes superior to the first blooming; and a group of well-grown plants, such, for instance, as can be seen at Ashton Court near Bristol, under the charge of Mr. Austin, cannot fail to be pleasing to the most fastidious. Nothing is required to 'show them off,' as well-grown plants are furnished with abundance of broad and smooth green foliage, and no other colour better agrees with white. The species is much liable to become infested with scale and other insect pests that are too plentiful in our stoves; but this ought to be no hindrance to the widespread culture of such a charming flower."

— "W. R.," writing in reference to MUSHROOM CULTURE, says, "It may be interesting to many readers of this Journal to know that the excellent practice detailed by Mr. Wright a short time ago is now being followed by Mr. Smith, Maiden Lane, Clubmore, Liverpool, with marked success. A fortnight ago he had already cut over 300 lbs., and 47 lbs. in one week. Mr. Smith has made slight mistakes in spawning the beds when too warm in some instances, and not affording sufficient covering in others. Less could scarcely have been anticipated, as he had not the slightest acquaintance with the system of Mushroom-growing described. Mr. Smith has, however, succeeded beyond his expectations, and at this early period of his practice considers Mushroom-growing more profitable than growing Cucumbers. He has Mushroom beds made up in his Cucumber houses in Orange boxes, flat hampers, and in almost every conceivable corner and manner. There can be but little doubt that in a very short time with experience and the guidance of the articles referred to, Mr. Smith will become an expert in the production of Mushrooms for market."

— AT the last meeting of the METEOROLOGICAL SOCIETY the following papers were read:—1, "Popular Weather Prognostics," by the Hon. R. Abercromby, F.M.S., and Mr. W. Marriott, F.M.S. The authors explain over one hundred prognostics by showing that they make their appearance in definite positions, relative to the areas of high and low atmospheric pressure shown in synoptic charts. The method adopted not only explains many which have not hitherto been accounted for, but enables the failure as well as the success of any prognostic to be traced by following the history of the weather of the day on a synoptic chart. The forms discussed are cyclones, anticyclones, wedge-shaped and straight isobars. The weather in the last two is now described for the first time. They also point out (1) that prognostics will never be superseded for use at sea and other solitary situations; and (2) that prognostics can be usefully combined with charts in synoptic forecasting, especially in certain classes of showers and thunderstorms which do not affect the reading of the barometer. 2, "Report on the Phenological Observations for the year 1882," by the Rev. T. A. Preston, M.A., F.M.S. The most important feature of the phenological year was the mild winter. The effect of this upon vegetation was decidedly favourable, and had it not been for the gales, especially that of April 28th, the

foliage would have been luxuriant, and therefore free from insect attacks; but the contrary effect has been produced on insect life, for the scarcity of insects, especially butterflies and moths, has been the general remark of entomologists. Mr. J. S. Dyason, F.R.G.S., exhibited a series of typical clouds in monochrome, and also a series of sketches of clouds in colour made in June, July, and August, 1882.

— THE large bush of the grand flowering and most deliciously fragrant greenhouse shrub LUCULIA GRATISSIMA, which is growing in the central portion of the cool conservatory range at Glasnevin, has been particularly floriferous, and the Hydrangea-like flower heads particularly large and fine this winter, from 150 to 200 being open at a time, and still plenty to succeed them. It is certainly a charming shrub, which no conservatory should want. Now that it has been demonstrated that dwarf plants with fine heads of flowers can be grown in 6-inch pots its popularity will be largely increased, and the appearance of such plants as familiar at Christmastide as are those of the gorgeously coloured but scentless Poinsettia.—(*Irish Farmer's Gazette.*)

PLANTING VINES.

THIS subject has been much discussed, and various opinions have been expressed regarding it. Notes of the experience of any who have been successful in the method pursued by them cannot fail to carry more weight than mere opinions stated without facts to support them.

My experience leads me to favour planting in March, April, and May. Young Vines struck from eyes, grown on turf, and root-pruned before being lifted for planting, have done splendidly with me, and grew rapidly without a symptom of a check from the transplanting. Compare this method with planting a Vine out of a pot, where the roots have to be torn and laid out in long strings and go rambling away in all directions. The young Vines planted out of the bed of turf had a mass of short fibry roots ready to begin and seize hold of the soil close round the stem, and so work their way gradually along the border.

The Vines planted made 30 feet of growth, and this was the length of many of the rods that came away from them. When cut down the stems were found to be as hard as oak, and some of them half an inch in diameter 20 feet from the base. By constant feeding on the surface of the borders young Vines may be induced to produce roots mostly near the surface, and can thus be kept more under control. I have seen Vines planted in July make splendid growth and ripen their wood remarkably well, but, other things being equal, I would prefer planting earlier.

Vines one year old, if they have been grown on the root-pruning system, plant very well out of pots, as they have plenty of short fibry roots ready to enter the border. I have also planted Vines two years old that had been grown on the old-fashioned system, and had only one or two long roots coiled round the outside of the ball. In early spring these were shaken out of the soil they were in and planted in some loam prepared for them, and which was placed in a position that enabled the Vines to have some bottom heat. They were kept in this situation for about a month, by the end of which time they had made some young fibry roots; being carefully lifted and planted in their permanent quarters these Vines progressed well, making wonderful growths and countless roots. I have often observed young Vines planted in an early vinery after the Grapes had been cut and the house was being kept cool, the consequence, of course, being that the young Vines made little or no progress that season.

Young Vines when planted in the way I have mentioned above—viz., from the turf, well repay their cultivator, and I would advise all who can prepare their Vines in this manner to do so.

When Vines have to be obtained from nurserymen for planting, a month's sojourn among turf and with some bottom heat to start them will be found a good preparation for planting, provided always that the house in which they are permanently planted is kept warm and moisture supplied in sufficient quantities both in the air and at the roots. When planted the Vines should have a good watering with tepid water, and it would be of much benefit to them if all subsequent waterings for the first year were with tepid water.

Planting Vines in cold soil and then watering with cold water cannot be too severely condemned. Warming soil enough to cover the roots when planted is another thing that conduces to the well-

being of the Vines. Attention to such details as the foregoing goes a long way to insure success. The difference between Vines treated in some such manner as I have described and others treated in the way I have often seen practised is so great, that the extra trouble incurred should never be grudged; and all who wish quick returns from their vineries should follow the system recommended, and which experience has led me to regard as the method best suited for the successful growth of the Vine when planted.—VITIS.

NEW AND CERTIFICATED PLANTS OF 1882.

MESSRS. J. VEITCH & SONS, CHELSEA.

FOR some years past the records of the Royal Horticultural Society's meetings, the exhibitions of the Royal Botanic Society, and the larger provincial shows have afforded substantial and remarkable evidence of the efforts made by nurserymen to meet the ever-increasing demands for novelties. Annually large numbers of plants are exhibited as candidates for certificates, and some hundreds are yearly deemed worthy of this honour. That the care exercised by the exhibitors in selection is considerable is manifested by the fact that the proportion of novelties for which recognition is claimed, and which fail to obtain it, is very small. As might be expected, however, really striking novelties are not extremely abundant, and in many genera of plants the improvement



Fig. 2.—*Primula obconica*.

is very gradual; indeed, among some classes of florists' flowers, such as Roses, Pelargoniums, Auriculas, Carnations, and Picotees, there is scarcely room for any great advance, though more or less meritorious and distinct varieties may be continually added to the lists. Newly introduced species of plants yield some remarkable and beautiful additions, whilst amongst Orchids improved varieties are being rapidly increased in numbers, and in most cases far surpass the original forms.

The year 1882 has been equally as prolific of novelties as its predecessors, about four hundred plants having been certificated at metropolitan and provincial shows, by far the greater majority being at the former. These were staged by sixty-five exhibitors, and amongst them Messrs. J. Veitch & Sons took the leading place with over seventy certificates—quite an imposing array of plants, and comprising many of great merit. Some of the best of these may be briefly noted to indicate the general features of the improvements effected.

RHODODENDRONS.—These deserve prominent notice amongst the Chelsea novelties, for some of these may be considered as

founding a distinct type of the greenhouse hybrid class. *R. balsamiflorum*, *R. balsamiflorum album*, and *R. balsamiflorum aureum* form a trio of remarkable plants with handsome double flowers, pink, white, and yellow respectively. These are borne in large heads, and a well-grown plant is exceedingly beautiful. The white variety is faithfully shown in our woodcut, page 83, last volume, and displays the characters of this new departure in an already beautiful and much-appreciated race of plants. Two others of the single greenhouse forms also deserve notice—viz., *R. Aurora*, which has pinkish salmon-coloured flowers of great size and fine form, the individual blooms much surpassing the others in size; and *R. Excelsior*, having buff flowers streaked with red, and forming a dense head. *R. Fosterianum*, of the *R. Veitchianum* type, with large, wavy, pure white flowers, is also a handsome addition to the genus.

AMARYLLISES.—Similarly to the Rhododendrons, the great attention paid to Amaryllises at Chelsea within recent years has resulted in the production of some magnificent forms, and early in the year a superb display of these at the nursery attracted scores of visitors. The size and form of the blooms having been wonderfully improved, considerable advances have been also made in increasing the richness and diversity of tints. For brilliancy these plants are unrivalled, and it may be confidently expected that they will continue to grow in popular favour. Of the varieties certificated the finest are *The Giant*, blooms of great size, crimson; *Shakespeare*, bright scarlet barred with white; *Indian Chief*, rich crimson, also barred with white; *Charles Dickens*, crimson-scarlet; *Baron Schröder*, dark crimson, large and of good form; *Duchess of Connaught*, white; *Duke of Albany*, very bright scarlet; and *Autumn Beauty*, a pretty hybrid between *A. reticulata* and one of the scarlet varieties, the leaves having a central band of white, the flowers pale pink, nearly white, veined with a darker hue.

ORCHIDS.—The vast stores of Orchids at Chelsea contain not only all the best of the varieties, species, and hybrids in general cultivation, but also numbers of rarities and new introductions which are from time to time brought before the public, to the great delight of all orchidists. As usual during the past year Messrs. J. Veitch have well maintained their credit in this department, and added to the fast-increasing numbers of Orchids. Half a dozen of these may be selected as uncommonly meritorious. First two *Odontoglossums*—viz., *O. Lceanum* and *O. Pescatorei Veitchii*, claim notice, the former having yellow flowers thickly spotted with rich chocolate, and the latter having flowers of considerable size, white, heavily spotted and barred with intense crimson. Both are superb Orchids, but the last is a magnificent variety, and surprisingly distinct from the species. *Cœlogyne cristata Lemoniana* is a charming variety of a most useful Orchid, the lip being pale yellow instead of orange as in the ordinary type. *Sobralia xantholeuca* is very distinct and attractive, with bright yellow flowers, the sepals, petals, and lip differing slightly in the depth of tint; it might be almost considered as a yellow *S. macrantha*.

Phalænopsis tetraspis is a neat dwarf species with racemes of small white flowers—a great contrast to the large-flowered *P. grandiflora*, but possessing a quiet beauty of its own. Another fine *Phalænopsis* merits a few words, not because it has been certificated this year, but from its rarity, beauty, and being named in honour of the firm whose productions are now very noted. *P. Veitchiana* is a native of the Phillipine Islands, and bears flowers somewhat resembling *P. Schilleriana*, but with smaller purple flowers, the lip whitish, spotted with dark purple. The woodcut (fig. 3), from a drawing by Mr. Burbidge, faithfully depicts the characters of the species.

FINE-FOLIAGE PLANTS.—*Dracænas* and *Crotons* are now so numerous that really distinct and handsome new varieties are every year becoming more scarce. In 1882, however, two fine *Crotons* were shown by Messrs. Veitch and duly honoured—viz., *Dayspring* and *Aureo-marginatus*, the former with elliptical leaves, yellow margined with green, and the older leaves suffused with red in the centre; the other has large leaves a foot long, rich yellow, spotted and blotched with green. *Dracæna Thompsoniana* is a noble form of bold habit, with broad tapering green leaves, something in the way of a *Cordyline*. Amongst fine-foliage plants, however, the most striking of the year is *Leea amabilis*, figured in this Journal, page 283, April 6th, 1882, which will doubtless quickly become a great favourite, as it is easily grown and develops its characters admirably in a young state. The leaves are glossy green and pinnate, each leaflet being striped down the centre with silvery white. In habit it is compact and vigorous, but appears to require a brisk stove temperature to insure its success.

Nepenthes at Chelsea are multitudinous, and two fine forms

have been certificated during the past season—*i.e.*, *N. Rajah*, the giant of its family, and *N. Mastersiana* (figured on page 275 last vol.), one of the richest and deepest-coloured in cultivation. With these the *Sarracenias* may be mentioned, a trio of handsome forms having been placed on the lists. *S. melanorrhoda* has very dark leaves. *S. porphyroneura* of a fine red hue, and *S. Courti*, a beautiful hybrid between *S. psittacina* and *S. purpurea*, and showing the characters of both. Under this head the Japanese Maples are noteworthy as really useful and graceful plants. *A. japonicum aureum*, *A. cratægifolium Veitchii*, *A. polymorphum*

linearilobum, *decompositum*, and *ribesifolium* differ greatly in the forms of their leaves, and have all been honoured with certificates.

In addition to the above many others could be noted, such as the Hyacinths, Begonias, Lilioms, &c.; but this review of the Veitchian novelties of 1882 may be fittingly concluded with a reference to the pretty little *Primula obconica*, represented in fig. 2. This has been certificated both at Kensington and Regent's Park, and it well deserves the attention it has received. It is a Japanese species, somewhat in the way of *P. cortusoides*, the flowers being of a pale purplish lavender or mauve colour—a very



Fig. 3.—PHALLENOPSIS VEITCHIANA.

delicate tint, and are borne in close trusses that are freely produced. It is dwarf in habit, and thrives well in a cool house, and probably will prove hardy in sheltered positions.

EASTER BEURRÉ AND BEURRÉ RANCE PEARS.

WITH your well-known kindness and readiness you favoured me, through "our Journal" of 26th of October last, with a list of the best and finest late Pears to be grown against a south wall for profit, but did not include in the list either Easter Beurré or Beurré Rance. Will you please state the objections to these two well-known and old Pears?

With regard to Easter Beurré, many reliable French and

Belgian authorities recommend this variety before all others for hot wall and warm soil, and Mr. Pearson of Chilwell, so far north as Nottingham, says it only ought to be grown on a wall; whilst many experienced advisers in this country say "often mealy and insipid from a wall, but excellent from trees in the open." This sounds as if the wall was too dry and warm, yet in the warm parts of France it is advised for warm aspects on walls and for warm soils. This seeming contradiction with regard to this Pear has no doubt perplexed many of your readers besides me, and no doubt you will be able to enlighten us on the matter.—S. S., *Oakleigh Park, London, N.*

[Concluding that the London clay is the staple soil in the district indicated, we did not think the varieties in question,

which are proverbially fickle, could be relied on for always producing fine fruit of superior quality. If our readers who grow these Pears will describe the conditions and circumstances under which they succeed or fail, the information will be of service to others besides our correspondent.]

LILIUM LONGIFLORUM IN WINTER.

LAST winter I received a number of bulbs of *Lilium longiflorum* from Holland. They flowered very well in a greenhouse, the stems being 3 feet in height. After the plants in one pot containing six bulbs had flowered I planted the mass out in the garden, and finding in September that a number of very stout stems were again appearing I repotted and placed it in the greenhouse. I have fourteen good buds on the plants now, and three expanded flowers looking grand in this dismal weather. Is this the ordinary *L. longiflorum* or the variety called *eximium*? Whichever it is, it seems to me that it must be very useful to gardeners who have to keep conservatories looking well during the winter. My greenhouse is only a small one, and during the severe frost has been down to 38° Fahr. several times, but the flowers do not seem to suffer.—JOHN PEARSON, *Radeliffe*.

ST. JOHN'S WORTS.

THIS is the family name given to the plants of the genus *Hypericum*. In spite of the wide difference of habit and habitat amongst these plants, there is a strong family resemblance between the flowers of all of them. The generic name is generally mispronounced, and I have seen most improbable and far-fetched derivations suggested for it. The word is Greek, and is found in the writings of Dioscorides, a Greek doctor, who wrote on medicinal plants. He spells it *Hyperikon*; and there can be little reasonable doubt that it is compounded of *Hypp* (in Latin *sub*) and *erike* (Latin *erica*), the diphthong being of course long by nature, as well as the *i* of the Latin name. Turned into English the name is "Under-Heath," and if it is asked why the St. John's Wort should have this name, we must give a few words of general explanation. Upon the revival of the study of ancient Greek and Latin, botanists and scholars did their best to identify the ancient names of shrubs and plants with those known to them. Though it was known that they had made many mistakes, more recent research has done little to correct them. The laborious attempts made at the beginning of this century by that distinguished scholar and botanist, Professor Sibthorpe, are well known. He spent several years in Greece with the special object of studying in their native country the plants mentioned by the ancients. He gave us in his "Flora Græca" one of the most splendid botanical works ever produced, but made very little progress in the identification of names; the subject is therefore almost exhausted, and little new light can ever be thrown upon it. We cannot, therefore, be sure that the *Hyperikon* of the Greeks was a St. John's Wort at all, so it is quite superfluous to inquire why it was called "Under-Heath." As for the English name, there is a general consent that it was given because the commonest of the wild kinds, *H. perforatum*, comes into flower about St. John's day; or more properly, bearing in mind that the name was given under the old style, about the beginning of July.

It is proposed in these notes to give an account of the mode of growing the kinds of St. John's Wort cultivated by me in my garden in Cheshire, about a dozen in number. The commonest of them is *H. calycinum*, generally and rightly called the Large-flowered St. John's Wort, a plant better suited for the shrubby border or the wild garden than for mixed flower beds. It spreads rapidly, and in cultivated ground or favourable wild spots soon forms a compact evergreen mass against which no weak plants can hold their ground, and it claims undisputed possession. It must not, however, be expected to compete successfully with the roots of Elm or Ash trees, or similar surface-feeders. I have seen it most ornamental and luxuriant amongst wild walks in pleasure grounds in Surrey, but on cold soils, like the clay of Cheshire, it is more difficult to establish in wild situations, and when established it is liable to be cut to the ground and afterwards smothered by weeds by such winters as that of 1880. Though naturalised in several places, and often admitted in lists of British plants, it belongs to the south-east of Europe, and is, therefore, hardly likely to be a native plant. It is the only St. John's Wort that is appreciated as it deserves to be, and there is hardly a garden of any extent in some part of which it is not to be found.

The same, however, cannot be said of that hardiest of St. John's Worts *H. olympicum*, a very neat and ornamental plant, but

neglected because it requires about as much cultivation as is generally given to a bedding Pansy. It is said to be a native of the Mysian Olympus; but Mr. G. Maw, who has searched that range for plants, told me that he had never seen it there; still, whatever its native country, it is a most desirable plant, growing about 18 inches high, and producing in summer a profusion of flowers nearly as large as those of *H. calycinum*. Its cultivation is important, as it is of shrubby habit, never spreading at the root, but breaking into new growth from the base of the flower stalks before they die, which they do at the end of summer. This young growth is never injured by frost, so that the plant is evergreen. It is, however, short-lived, generally dying in my garden at three years old. The only way of increasing the plant is by small cuttings, about an inch long, taken from the end of the young shoots at any time from spring to autumn, which strike easily under glass. Those taken in autumn are ready to plant out by April, and make late-flowering plants the first season. The second year they are at their best, and always attract attention at this stage. They cannot be safely transplanted if more than a year old, and I have more than once tried without success to divide them by cutting through the root. Established plants do well in any soil or situation; but from what has been said it will be understood that they must not be lost sight of or forgotten, but a fresh stock propagated every year. Those who grow it know it to be well worth the little trouble it gives.

I come now to three or four shrubs, to which I give the same treatment in propagation as to the last-mentioned, but for a different reason—that they are not quite hardy. Though they lived through the exceptional winter of 1881, they can be depended upon to survive bad winters unhurt only in the more favoured gardens of the south-west of England or of North Wales. The largest of them is *H. oblongifolium*, which in Devonshire grows into an upright shrub 3 or 4 feet high, bearing bunches of large wax-like flowers with petals as thick and as solid as those of a *Camellia*. Better known is the elegant dwarf bush generally sold as *H. patulum*, but which botanists say is not the true *H. patulum* of Eastern Asia, but a hybrid. However this may be, it is a most desirable plant. Cuttings of it may be preserved through winter in store pots like those of scarlet *Pelargoniums*; and these, planted out in May, grow as fast, but do not flower until August, from which time they continue to flower till checked by hard frost. A third shrub of similar habit, and doing well under similar treatment, but smaller both in its leaf and its flower, is named *H. uralum*. It is so like a dwarfed edition of *H. patulum* that I consider it hardly worth growing in addition to it; in fact, the so-called *H. patulum* is the best of the three, being more bushy and compact than *oblongifolium*, though the flowers are not quite so large. As there are at least seven or eight more St. John's Worts of which I wish to speak, it may be better to defer mention of them to another issue.—C. W. DOD.

DUKE OF BUCCLEUCH GRAPE.

IN reply to your correspondent who asks about the late-keeping qualities of the Duke, I beg to say that the Vine was planted in an inside border in a Muscat house, and was carefully attended to in regard to being kept drier at the root than is usual for most other varieties. Of course it was ripe much earlier than the Muscat, and was subjected to more heat than it ordinarily gets. It was fit for use on the 1st of August, and I cut the last bunches the last week of January, having left several just to try how long they would keep. The berries had shrunk a little, were of a deep golden colour and a delicious sugary flavour. I do not mean to say that the Duke is fitted for a late Grape, but the fact remains that it can be kept long after it is ripe.—NORTHERN.

CULTURE OF RICHARDIA ÆTHIOPICA.

THIS is now a valued plant in many gardens, and its cultivation is likely to extend as its good qualities become better known. The plant is useful for decoration, it stands room treatment well, the spathes are highly appreciated, few last longer fresh, and it is very easy to grow. Provided certain conditions are carried out no plant can be more accommodating. A plant may be brought into bloom at a given time at any season of the year, or the same plant may be flowering the whole year. It may be successfully cultivated and flowered in a 5 or 6-inch pot, or placed in clumps in the largest size pot made. As to soil it is less particular than any cultivated plant I know. It can be propagated successfully at any season. The old-fashioned way of growing the *Richardia* was to dry the plants during summer, repot in autumn, and flower them in spring. I do not think this is the best way. Drying the plants may do no harm, it certainly does no good.

When properly managed growth is continuous if water is liberally supplied and a moist warm temperature provided. When spathes are not wanted until spring, or until the Chrysanthemum season is past, keep the plants growing slowly until a month before being wanted, then give a temperature of 55° to 65°, and as long as such a temperature continues the plants will grow and flower. We have plants which were housed in October and which were brought into flower in the end of that month; they are still flowering, and will continue to do so until May, when their spathes will be no longer required.

The general culture of these plants, briefly stated, is to pot them from the open ground in September, one strong growth in an

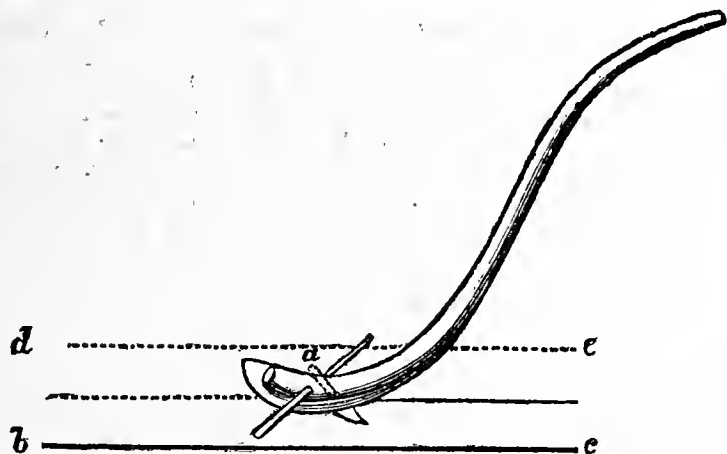

Fig. 4.—Turf Racer.

8 or 9-inch pot, those with two and three growths being placed in larger sizes and in boxes. They grow and flower in any soil provided they get plenty of water. A few years ago we accidentally found that placing each pot in a large saucer kept full of water was of great advantage, causing a more floriferous condition, and the blooms of a larger size. An occasional surface-dressing, with a mixture of manure and loam in equal proportions and a weekly application of sulphate of ammonia, are valuable aids to this plant. When the plants are placed in a temperature such as noted above a spathe will start from the sheath of one of the largest leaves. While this is growing upwards and opening other leaves are being formed from the main central growth. By-and-by a second spathe will appear behind the first. This will have developed before the central growth has produced another leaf; but provided the temperature is high enough to favour the full development of the foliage, spathes will follow from about the third leaf from the one which produced the first, and so the succession of leaves and spathes continues as long as the conditions are secured for the proper growth of the plant. Further side growths attain considerable strength throughout the winter months, and in spring some of these produce spathes. Occasionally they come merely as white flowers with a tinge of green at the point, occasionally the spathes are doubled.

In May the plants are placed out of doors, where they are protected from any late frosts (in autumn a few degrees of frost are not hurtful) which damage the tissue of the foliage if exposed. In June we divide the plants, planting the pieces out and tying the foliage to stout stakes. If the soil is dry a good watering is necessary. Last summer we used these as decorative flower-garden plants, and found them as useful in that position as they had been throughout the winter and spring; this year they will occupy a prominent position in the flower garden. To return to its culture in pots. The offsets produced are useful if taken off at the time the plants are divided and placed into 5 or 6-inch pots, in which they may be had to flower throughout the next winter and spring. To illustrate the ease these may be managed, last June about fifty of these offsets were thus potted in leaf soil; they were kept in a shady corner well watered. The strongest have flowered, and others are coming on in succession. Insects are easily washed off with a syringe.—B.

PEAR JOSEPHINE DE MALINES.—In answer to the query concerning this very delicious Pear as to the time of its ripening, I may state that at Holme Lacy it was generally quite fit for table by the first week in December. Those from the cordons on a south wall were a few

days earlier than those from a fan-trained tree on a west wall. The trees are on the Quince stock. I used to think it was the Quince stock that caused the earliness. A tree on the Pear stock on an east wall would not ripen its fruit at all.—A. YOUNG.

TURFING.

THE lifting and relaying a quantity of turf is generally looked upon as a very laborious operation, and it is so at best; but with proper appliances, and a little forethought in devising a regular plan and method of working, much may be done to expedite this operation, if but little to alleviate the real hard work that it involves. This sort of work may be done any time from September till March, but, like planting shrubs, the sooner it is done in the autumn the better it is for the turf. It should especially be avoided late in the spring, as it is so apt to be dried up and disfigured for half the season if there are a few weeks of dry weather before midsummer. Dull weather after a good rain is a suitable time to lift turf, as it works more freely when wet.

We often see lawns not satisfactory in the way of evenness. I do not mean that all lawns ought to be level, only that they should be free from hollows. In stiff adhesive soils the rain forms miniature lakes for days, and thus makes the lawn wetter than if no lodgment was found for it, as in the case of an even surface because it level or sloping. Lifting round patches and filling up hollows is never satisfactory; by far the best plan is to lift the whole. To anyone commencing such an undertaking I would commend to his notice the following mode of procedure.

Suppose, for instance, that a lawn has to be made suitable for lawn tennis without materially altering the level of it. In the first place let him proceed to make what in Sussex is called turf-racers—a very simple but useful tool. It is represented at fig. 4, and may be made of any similarly shaped piece of wood which may be found in the stick heap. The thick end of this may either be split with a saw, or a hole bored at a sharp angle to admit of a knife being fixed in the position shown. The latter may be made of the point of an old scythe blade, and should be fixed to project 2½ inches from the wood. Now obtain a piece of stout zinc—corrugated zinc roofing beaten out flat will do—about 2 feet long by 6 inches wide. Cut this into the shape of a canoe; but make one end taper to a sharp point about 9 inches from the broad end, and in the centre cut a very narrow opening, just sufficient to let the knife through, and with a few screws fasten this on as a sole-piece, bending it to fit the wood. Next bore a hole just in front of the knife, and fit into it a straight round rod

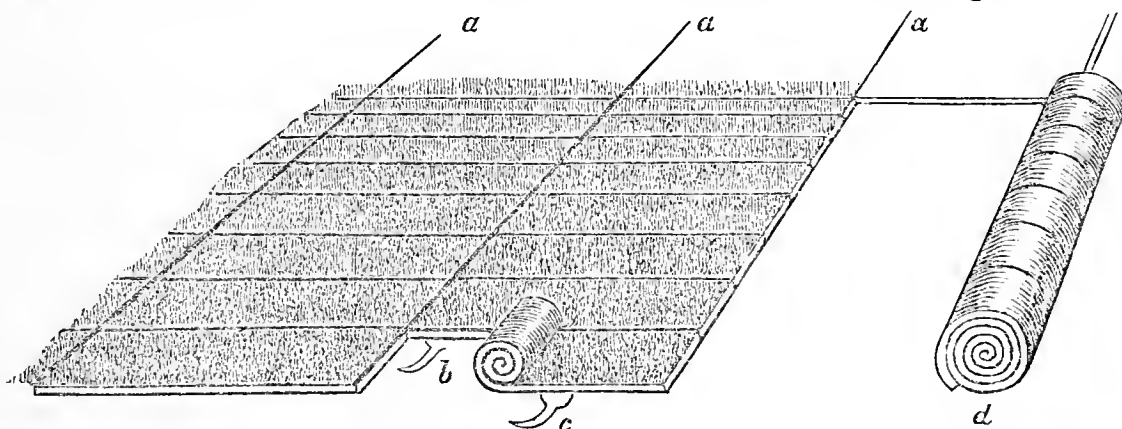

Fig. 5.—Turf Lifting.

or stout piece of wire 2 feet long, so that it project 1 foot on each side of the knife, as shown at *a*, fig. 4. This tool is used to cut the turf into the necessary widths. A line is used to cut the first width, as at *b*, *c*. Place the racer so that the end of the cross rod touches the line, and so guide the cutting of the first turf. The line is then dispensed with, as each cut made across the grass forms a guide to cutting of the next one. This simple tool saves many a weary hour's work with line and edging-iron. The turf has next to be cut into lengths of from 4 to 6 feet and at right angles to the other, as shown at *a*, *a*, *a*, fig. 5. This is best done by placing the line at the proper distances and running the racer along on the top of it, the knife being close to it.

The next point to be considered is the level. The best plan is to lift a single width of turf all along each end, and others across the lawn at distances of about 10 yards apart. By means of boring-rods insert level pegs in these bare spaces at every second length of turf. This will show where the ground has to be made up or reduced. If possible begin where it has to be reduced. The lifting should be done by two men and a boy. The men must each

be provided with a turf spade. At *b, c* (fig. 5) is shown what I think is the best and quickest way to cut the turf. The first man (*b*) cuts the turf half way, the other taking it up at that point and finishing it, while the boy, standing in front, rolls it up just behind the spade, having it in rows, as at *d*, ready for moving. Having lifted two widths carry the turves to the other side of the lawn and pack them neatly. This piece may then be levelled to the pegs previously inserted, treading it firmly when it has to be made up, then point lightly over, having a smooth surface. If there should be any soil to spare it should be laid on the unlifted turf near to, but on the opposite side of, some of the largest hollows where it will be required. The next two widths is then lifted, and one of them may be at once placed on the new levelled ground, and the other laid in position, but not unrolled. The second piece is then levelled, and the next turves laid upon it, and so on till all is done. Planks must always be used in carrying the turf, as the newly pointed ground must not be stepped upon till the turf is laid down. It should then be closely trodden over with the feet, smoothed with a turf-beater, and afterwards occasionally rolled during showery weather. If dry weather causes the edges of the turf to part fill them up by working some fine soil across the lawn with brooms.—R. INGLIS.

THE COOL SYSTEM OF GRAPE CULTURE.

AT page 550 your correspondent, "Vitis" condemns the cool system of Grape culture, and says it is "a penny wise and pound foolish" one; while, at page 547 he says it takes seven months to ripen such Grapes as the Duke of Buccleuch, Muscat Hamburg, and Madresfield Court!—in his own words from the middle of February till the middle of September, when, provided they are "generously treated in regard to heat," &c., they "should be in good condition for the table," Muscats to be "allowed a little longer time to ripen."

In reply, I have to say that treatment which requires such a long time to render such Grapes fit for the table can be no other than cool treatment, for seven months is far in excess of the period required by these Grapes to ripen, nor is such time allowed even by those who do practise cool temperatures. I have tried both systems, and I am certain that "Vitis's" system must be the cool one, and his success must be added to the many examples that have proved the cool system to be the right one.

All the three varieties named are early Grapes. Madresfield Court with me ripens every year in less than six months or thereabouts under the cool system, and the Muscat Hamburg in the same time as the Black Hamburg, which, at the most unfavourable season of the year can be matured in five months. I have done it within that period with Vines in pots, and six months is the outside period that Vine requires. And now mark, the Duke of Buccleuch Grape was sent out with the character of being earlier than even the Hamburg, which is the case. Mr. Barron, when visiting Clovenfords to report on that Grape, in his report said, "It was evidently some weeks earlier than the Black Hamburg" grown in the same house. "Few of the Hamburgs were ripe or fit to cut, whereas the Duke had been cut and sent to market a month previously." Further comment is needless, and I leave the reader to judge whether the treatment was cool or warm that took seven months to render such Grapes fit for the table, which is only another term for "ripe." There is only one general plan known to gardeners of keeping Grapes back, and that is to keep them cool, a plan which "Vitis" has furnished the best kind of evidence possible to prove he has followed with marked success.—VITIS SECUNDUS.



[By the most skilful Cultivators in the several Departments.]

KITCHEN GARDEN.

Forcing vegetables is now an easier matter than it has been during the last two months, and quantities of choice and useful kinds may be brought forward. From now onwards there is no better way of forcing Asparagus than in frames placed on hotbeds made up with leaves and stable manure. When the frame is placed on the bed a thin layer of soil is spread over the surface, on which the roots are packed closely, and the crowns and roots

are covered with more soil. When growth begins air and light are needed to impart high flavour.

Seakale and Rhubarb roots need not be lifted for forcing now, but may be covered with pots, old boxes, or casks, these in turn being covered with fermenting material. Growth will soon begin, and the roots will remain uninjured, which is not the case when they are lifted to be forced.

Kidney Beans should now be sown in quantity; six or eight seeds may be placed into a 3-inch pot, filled with a mixture of loam and half-decayed manure. They will grow readily in a temperature of 60°. Apply water sparingly at first. When the plants are about 4 inches high they may be shifted into 8-inch pots.

Planting early-frame Potatoes should now be general. A firm well-made hotbed is very suitable for them, but when only a dish or two is wanted they may be grown in 10-inch pots. The soil for all should be rich, and if on a hotbed should be a foot in depth. The sets should be placed 15 inches apart each way, and tubers with stout short growths are the best for planting. A little air should be admitted on all favourable occasions, and protection other than the glass lights should never be given unless in very severe weather. Turnip-rooted Radish, Mustard and Cress, Lettuce, Cauliflower, and Cabbage seed may be sown between the rows of Potatoes. The salads will be matured and used before the stems meet, and the other plants will have had a good start and be ready for planting in other frames or elsewhere. One or more frames of Carrots should also be sown on beds prepared as for Potatoes, but the soil should be light, free, and not very rich. A few Vegetable Marrow seeds may be sown as a first crop. They should be treated like Cucumbers both in sowing and afterwards.

Early Peas may be sown in various ways. Raising them in turves and old troughs are good methods, but of late years we have sown all ours in 3-inch pots, placing a dozen or more seeds in each, and at planting time we put the little clumps about a foot apart without breaking the mat of roots which they form. There is less check from this than any other way. A few rows of Broad Beans may be sown in the open; a deep rich soil suits them best. The rows may be 4 feet apart and 3 inches deep. Peas may also be sown on a warm sheltered border. They delight in a well-drained soil; in fact it is no use sowing Peas in a cold wet soil at this season, as the seed would decay. Thick sowing should be the rule now.

FRUIT-FORCING.

Melons.—If ripe Melons are required by the end of April or beginning of May the seed should be sown now. At this early season sow the seeds singly in 3-inch pots of light turfy loam, not more than half filling the pots with soil, which will leave space for top-dressing when the plants require it, plunging to the rim in a hotbed made of fermenting materials, and cover the pots with a piece of clean glass, which, however, should be removed as soon as the plants appear. Almost every grower has his favourite variety, but we may mention Davenham Early, Eastnor Castle, and William Tillery in green-fleshed varieties; Scarlet Gem and Hero of Bath in scarlet-fleshed varieties.

Cucumbers.—Every opportunity should be taken on bright days to make the most of the sun's rays by closing early in the afternoon, sprinkling the house at the same time with tepid water. The pathways and other available surfaces should be damped every morning, and the plants also, using a very fine-rose syringe for the latter. Let tepid liquid manure in a weak state be given to plants growing freely. A top-dressing of two parts turfy loam and one of horse droppings brought to the same temperature as the house will greatly invigorate the plants.

Some fermenting materials—two parts Oak or Beech leaves and one of stable litter—should be thrown together at once to make a hotbed, where no better means exist to raise young plants and subsequently to plant them in. The fermenting material, having been turned twice to allow the rank heat to escape, will then be in a fit state for making a hotbed, which should have a south aspect and have a wall, evergreen hedge, or other shelter from the north. The site should be higher than the ground surrounding it, so as to drain the water from the bed, or a few faggots placed underneath the hotbed will answer the same purpose. A bed about 6 feet high at the back and 5 feet high in the front will be necessary at this season to allow for shrinking, which will be fully one-third. When the bed is warmed through, as it will be in about a week with the frame and lights on, level any inequalities in the bed, placing sufficient fermenting material inside the frame to raise it to a uniform height; then 3 or 4 inches depth of short dung and 3 or 4 inches depth of sawdust for plunging the plants in, and when this is warmed through sow the seeds singly in 3-inch pots of light rich soil, leaving room for top-dressing the

plants when they require it. Plunge the pots to the rims, covering them with a clean piece of glass, which must be removed as soon as the plants appear. Telegraph is one of the best Cucumbers in cultivation.

Figs.—Trees started in November to give Figs fit for gathering early in May will be throwing out fresh rootlets plentifully, and, instead of allowing them to go direct into the leaves, good pieces of turf should be placed round the rims to keep the roots near home and encourage a sturdy growth. The bottom heat should be kept steady at 75° to 80° from the commencement of the swelling of the fruit until it begins to ripen. Take advantage of sunshine to raise the temperature with a little fire heat to 80°, but for the present the night temperature should be kept at 60°. As growth advances disbud and stop all gross shoots; but the finest Figs are borne on free healthy trees grown on the extension system.

The second house should be closed at once to give a supply of ripe fruit early in June, and as the trees in this structure will be planted out in inside borders good waterings with liquid manure at 85° must be given until the soil is thoroughly moist. Figs require quantities of water, hence the borders should be properly drained.

PLANT HOUSES.

Stove.—This house should now be gay with Euphorbias, Poinsettias, Plumbagos, Gesnerias, and other plants that flower freely at this season if properly prepared for the purpose. Nothing is gained now by maintaining a higher night temperature than 60° to 65°, according to the weather externally, with a rise of 5° during the day. After a moderate season's rest the plants will, with increased daylight and the temperature slightly raised, in a few weeks make much greater progress than would be the case if hurried on by hard firing from this date.

If bug, scale, or thrips exist upon the plants means should now be taken to destroy them, for with increased heat and moisture they will spread rapidly and be a source of trouble the whole season while the young foliage of the plants is tender. For the two former nothing is better than petroleum used at the rate of 4½ ozs. to 4 gallons of rain water. It is only by practice and experience that this valuable insecticide can be safely used; if left to the inexperienced injury is sure to result. Under these circumstances when such work has to be left to others it is the safest to use Fir-tree oil, tobacco water, and a little softsoap for thrips.

The structure in which the plants are grown should be thoroughly cleaned; this should be done even if no insects exist, either by painting the woodwork, which will be drier now in all probability than at any other time during the year. It is a good plan to wash the woodwork and glass previous to painting. Where painting is not required, then washing only will need attention, using a fair quantity of petroleum in the water. The walls should be limewashed, but before doing so wash them with muriatic acid and water. This is invaluable for destroying bug that may have become established in the walls, and will even remove the whole of the green if used strong enough from the flags of any stonework in the house. The pipes and staging (if iron) should be painted with lampblack and boiled oil mixed thinly and applied while the pipes are warm. This dries quickly and the smell is not offensive, and if the pipes are made hot directly after painting is done it will not injure the most tender foliage. The material upon the stages for retaining moisture, whether gravel, cocoa-nut fibre, or anything else, should be removed and fresh supplied.

FLOWER GARDEN AND PLEASURE GROUND.

Owing to the long-continued rainy weather operations in this department must be limited to sweeping and rolling the walks and turf where necessary, and otherwise preserving a neat appearance. Where, however, there is much work to be done all must not be postponed. For instance, walks may be formed or renovated, as the case may be, the fresh material if necessary being wheeled on planks. A walk to be permanent and fit for use at all times must be drained and well made. The bottom should be rounded, if it is intended to dispose 2-inch drain pipes on each side; or hollowed, if a single drain formed with 3-inch drain pipes is taken down the centre. A thick layer of rough stones, brick ends, or clinkers should then be disposed over the bottom, and this will form a good foundation for the finer surface gravel. Of the latter about 3 inches is required. If good binding gravel is scarce it should be reserved for surfacing, and this in some instances—notably near the metropolis—requires to be freely watered as it is being rolled. In all cases the walks should be well rounded; and where they are steep, to prevent the gravel being washed away paved gutters should be formed, while if only moderately steep it will only be necessary to build cesspools with

open gratings at intervals along the sides, these being in connection with the drain or drains under the walk.

Selecting and Ordering Roses.—It is not advisable to procure the majority of shrubs and deciduous trees early in this month, as there is the risk of the weather hindering planting, and those with balls of earth attached especially are injured by frequent removals. Those who have not ordered Roses should do so at once, as these can be packed so as to be uninjured by frost; besides, there is invariably a great demand for them early in the season. When received lay them in carefully by the roots where they can be covered with rough litter in the event of a severe frost being imminent. They may be planted during February. The preference should be given to dwarfs, as being the hardiest. No collection of Roses may be said to be complete that does not comprise such grand summer and autumn-flowering varieties as Maurice Bernardin, Marquise de Castellane, Boule de Neige, Cheshunt Hybrid, Marie Baumann, A. K. Williams, John Keynes, Charles Lefebvre, Alfred Colomb, Capitaine Christy, Countess of Oxford, Senateur Vaisse, Fisher Holmes, Duke of Edinburgh, John Hopper, La France, Madame Eugène Verdier, Madame Gabriel Luizet, Miss Hassard, Mons. E. Y. Teas, Général Jacqueminot, and Sultan of Zanzibar.

Treatment of Bedding Plants.—These this season, notably Pelargoniums of all kinds, are with difficulty prevented from damping off. A long period of dull weather, such as we are now experiencing, sometimes proves more disastrous than very severe weather, as there is no possibility of keeping the plants sufficiently dry. To counteract this the lights should be removed during the prevalence of sunshine, and during dull rainy weather should be blocked up at the back, and fire heat where available turned on. The plants ought frequently to be examined, and all decaying leaves removed. Pelargoniums require no water at the roots unless they are wintered in a dry and rather warm house, and even in this case it is not advisable to encourage growth so early in the season. Verbenas, Heliotropes, Ageratums, and Lobelias ought not to become dust-dry at the roots, but Iresines, Coleuses, Alternantheras, Mesembryanthemums, and succulents generally should not be heavily watered, especially where wintered in a comparatively low temperature. Give air freely on all favourable occasions to Calceolarias, Violas, Gazanias, or any half-hardy kinds of bedding plants being wintered in cold frames. If severe frost be anticipated cover all frames with mats, pieces of carpet, canvas, or other available material, and dispose over these and around the sides a heavy covering of rough dry litter.



FEEDING BEES.

It will be well now to consider some of the means to be employed whereby success may be insured for the coming season. Next to having dry well-ventilated hives, a proper knowledge of the science of bee-feeding is most useful. It may appear to those about to commence bee-keeping that there cannot be much science in feeding bees, but at the outset we will say that the knowledge of when, how, and why we feed them, points out the high road to that success we wish to insure. Unlike other creatures bees are not to be fed simply because they require food, but at certain times feeding, such as we shall recommend, must be carried on when an abundance of food may be in the hive; while, again, that feeding performed at an untoward season would bring about the destruction of those we wished to keep alive. It will be readily seen, therefore, of what paramount importance a proper acquaintance with this subject must be to the man about to keep bees. We may divide our subject into four heads—autumn feeding, spring feeding, feeding of swarms, and obligatory feeding either in summer or winter.

We commence with autumn feeding, because it is then that the stock is built up which is to do the principal work of the succeeding summer. Very few of the bees then fed will, indeed, live to help to fill the supers for the summer shows, but they are to be the nurses and feeders of the teeming multitudes of young bees upon whom the summer's burden will be cast. It cannot be too often impressed upon the readers of this Journal that the stocks which are strong in late autumn, strong in their numbers of *young* bees, are those which carry our hopes of profit in the ensuing year. How often the heaviest stock in autumn proves the weakest in the following May. The combs filled with honey during a glut which suddenly fails,

offer no receptacles into which the queen can deposit eggs, and by the time cells are emptied to satisfy hungry bees the impulse to lay eggs ceases, and the colony clusters to pass the winter with only old half-worn-out members. What is the result in the spring? The first few warm days tempt the bees to forage for pollen and honey; the queen, seeing a little food coming in, begins to lay; brood soon requires to be kept warm, and is reared; young bees begin to appear and require food. But by this time the ever-changing and treacherous spring weather has dealt death to the greater part of the enfeebled survivors of the winter. A sudden spell of bitter east winds with frost compels the few left to cluster closer together; perhaps brood has to be deserted and is chilled to death; the queen is disheartened and ceases to attempt the increase of her family; and if with the return of fine weather that hive pulls through at all, it is a weak profitless hive during the rest of the season. Yet by judicious feeding in autumn this evil might have been averted.

The food for autumn feeding should be made with less water than that given in the spring. A pint of water to 3 lbs. of best lump sugar, to which half a wineglass of vinegar is added just after removing it from the fire after gently boiling for ten minutes, at the same time stirring in a little salt, will make food of the proper consistency. As soon as the harvest from natural sources fails the hive should be examined, the space contracted to six or eight combs to secure warmth during the lengthening nights, all surplus honey extracted, or surplus combs removed and empty combs put into the centre of the hive, and then food given gently but continuously. Should the weather continue fine during the end of August and through September some little honey will still be brought in, and then if the syrup be given to the bees during evening it will cause what we aim at—the continual increase of the colony. Early in October bees cease to feed, the queen gradually ceases to lay. In three weeks most of the young bees are hatched out, and the colony goes into winter quarters, powerful not only in numbers but with unused energy stored up in a multitude of young bees, which will be proof against the trying ordeal of fickle spring weather, and, bearing the wear and tear of nursery cares, carry our stock safely on to the swarming season, either to give us new colonies or well-filled supers.

Spring feeding now claims our attention, and this is supplementary to autumn feeding. A very weak stock may sometimes—that is, when weather and honey supplies work with us—be fed up into a strong healthy stock by the time the bulk of the honey harvest is fit to gather. But the odds are against our success. On the other hand, where autumn feeding has been properly carried out, spring feeding rapidly tells on the well-peopled stock. The food should be thinner than that given during autumn. Our aim then was to have as little superfluous moisture as possible, to be driven out of the hive before winter; now the greater amount of water is required and used by the bees as the rapidly developing brood require it. Half a pint to each pound of sugar, and made into syrup as before, should now be given. Should the store of food be running short in the hive after the winter consumption we feed a few pounds rapidly at first, and then gently as in the autumn. The amount given is regulated by feeding through a greater or less number of holes in the zinc, and it can be fed either at the side or on the top as shown in the figures and description of our hives, pages 414 and 486 last volume.

This continuous gentle feeding has the same effect on the queen as in the autumn—she lays eggs, first a few, and ever increasing in numbers as newly hatched bees swell the nursing powers of the hive. This tendency to deposit more and more eggs is further excited by what is termed “spreading the brood.” After the first batch of eggs has begun to hatch out and the colony is gaining power we insert either sheets of foundation or empty comb between frames of brood. Constantly enlarging the brood nest as the increasing numbers warrant us in so doing, we in time have brood from end to end of the hive, and the happy state of affairs which we above pointed out is attained by the time Nature puts on her flowery garb and the bee-master puts on his supers.

But the greatest care must be taken never to neglect to continue feeding, once having begun. When we have so stimulated a stock that it has become perhaps full to overflowing with bees and brood, the result might be most disastrous should the supply of food be suddenly and permanently stopped. The greater the strength of the colony the greater the demand on its stores of honey; and a hive in the powerful condition we picture would in a very short time be on the verge of starvation. It is therefore necessary that we know what amount of food is stored, and should the quantity be growing small a certain amount should be rapidly supplied. We have done this without increasing the fixed daily allowance from the feeder, by pouring a pound or two of syrup into empty combs on the outer sides of the brood nest. The frame of comb laid flat can be easily filled with syrup by letting the latter fall in a thin

stream from a lipped jug held some distance above the comb, and this can be at once hung in its position in the hives. The bees will place the food just where they require it. We have now only to notice feeding of swarms, and what we have called obligatory feeding, which we hope to do in another letter.—P. H. P.

TRADE CATALOGUES RECEIVED.

Charles Sharpe & Co., Sleaford, Lincolnshire.—*Seed List for 1883 (Illustrated).*

Robert Veitch & Son, 54, High Street, Exeter.—*Catalogue of Vegetable and Flower Seeds.*

Ralph Crossling, Penarth Nurseries, South Wales.—*List of Vegetable and Flower Seeds.*

Edward Webb & Sons, Wordsley, Stourbridge.—*Spring Catalogue for 1883 (with coloured illustrations).*

Kent & Brydon, Darlington.—*Seed Guide for 1883 (Illustrated).*

Auguste Van Geert, Ghent, Belgium.—*List of Flower and Vegetable Seeds.*

Dickson, Brown, & Tait, Manchester.—*Spring Catalogue of Flower and Vegetable Seeds.*

George Bunyard & Co., Maidstone.—*Catalogue of Vegetable and Flower Seeds.*

John Laing & Co., Forest Hill.—*Catalogue of Vegetable and Flower Seeds.*



* * * All correspondence should be directed either to “The Editor” or to “The Publisher.” Letters addressed to Dr. Hogg or members of the staff often remain unopened unavoidably. We request that no one will write privately to any of our correspondents, as doing so subjects them to unjustifiable trouble and expense.

Correspondents should not mix up on the same sheet questions relating to Gardening and those on Poultry and Bee subjects, and should never send more than two or three questions at once. All articles intended for insertion should be written on one side of the paper only. We cannot reply to questions through the post, and we do not undertake to return rejected communications.

Carnations for Beds (Ayrshire).—We have notes in hand on growing Carnations in beds, with a selection of varieties most suitable for that method of culture, and these will be published in an early issue of the Journal.

Jasminum gracillimum (T. Griffiths).—This valuable plant was introduced by Messrs. James Veitch & Sons, Royal Exotic Nursery, King's Road, Chelsea, and if you write to this firm you can obtain the particulars you require.

Capparis spinosa—The Caper Plant (H. M.).—Capparis spinosa, from which the capers of commerce are obtained, grows abundantly in the south of Europe, along the shores and on the islands of the Mediterranean, and in Syria. It is generally found wild on walls and rocks; it is met with on the walls of Rome, Sienna, and Florence, and is extensively cultivated in the south of Europe, particularly between Marseilles and Toulon, and in many parts of Italy; but it is from Sicily that the greatest supply is brought. The flower buds form the capers so much used as a pickle and a sauce, but in some parts the fruit is also employed. In the early part of summer the plant begins to flower, and the flowers continue to appear successively till the beginning of winter. The young flower buds are picked every morning, and as they are gathered they are put into vinegar and salt; and this operation continues for six months, as long as the plants are in a flowering state. When the season closes, the buds are sorted according to their size and colour, the smallest and greenest being the best; these are again put into vinegar, and then packed up for sale and exportation. Capers are stimulant, antiscorbutic, and are much employed as a condiment, but the medicinal virtues of the plant reside in the root, which is slightly bitter, somewhat acrid and sour, and is diuretic.

The Caper Spurge (Idem).—Euphorbia lathyris is a native of several parts of Britain, and is called Caper Spurge, from its being used as capers; in America it is called Mole Plant, because moles are supposed to avoid the ground where it grows. Like other Euphorbias, its milky juice is of an acrid nature; its seeds yield an abundance of fine clear oil, called oil of Euphorbia. This is obtained by expression, or by the aid of alcohol or ether, and is colourless, inodorous, and almost insipid; it rapidly becomes rancid, and acquires a dangerous acrimony. The oil is a powerful purge, operating with much activity, in doses of five drops, and is said to be less acrid and irritating than Croton oil. It is necessary that it be always recently extracted, as it speedily becomes rancid, and has a disagreeable action. The seeds themselves, to the number of twelve or fifteen, are used by the country people in France as a purgative. The root of the plant is equally purgative, and particularly emetic.

Fir Tree Oil Injurious (Victim).—You have either exceeded the quantity advised, or the water was not suitable. We have seen the insecticide used with the best results—killing all insects and not injuring plants in the least, and we have also seen plants much damaged, even when the oil was used by a most careful man, and strictly in accordance with the instructions of the vendors as to the quantity advised. The difference we attribute solely to the water that was employed in mixing, and not to the oil, which we believe is of uniform quality. Rain water should be used; if that is not at hand (and there has been no particular scarcity of late) dissolve a lump of soda the size of a walnut in a

gallon of such water as you have before adding the oil, and if that does not answer try another insecticide, there are plenty in the market.

Violets in Frames (Cottage).—The method of culture in preparing Violets for flowering in frames in the winter is practically the same as that adopted in growing Strawberries, only rooted runners of Violets can be had in April, while Strawberries cannot be layered before June. In soil prepared as if preparing for Strawberries, and in an open position, plant rooted runners or offsets of Violets during showery weather in April. Compact growers, such as *Devoniensis*, a very useful single, and *Marie Louise*, a valuable double variety, may be inserted a foot apart in rows 18 inches asunder; but such strong growers and fine varieties as *Victoria Regina* and *Prince Consort* need more space, and the plants should be 18 inches apart in rows 2 feet asunder. Those named are excellent varieties, and if *Argenteaeflora* is added you may have abundance of flowers in different colours from September onwards throughout the winter, provided you can maintain a night temperature in the frames of 40° to 45°, not otherwise, as Violets must have a certain amount of heat for insuring a continuous supply of flowers. Plants well attended to during the summer will be in fine condition for planting in frames in September or early October. For further particulars read the articles on page 224, September 7th, 1882, and page 380, October 26th, 1882, which, if you do not happen to have preserved them, can be had from the publisher at the ordinary price, 3½d. each. Violets can be had in abundance in winter by taking stout runners and dibbing them an inch or two apart in boxes of good soil—loam and leaf mould—as if inserting cuttings, keeping them constantly moist, and placing the boxes in a light position in a warm greenhouse. Boxes thus filled at the present time and treated as directed will shortly afford quantities of flowers, and young plants of the best character will be provided for future plantations.

Pines for Fruiting (Irish Rector).—We think you have succeeded fairly well in your first attempt at Pine-growing. If the plant you describe as having a stem as thick as your wrist, has crowded the pot with roots, and the leaves are sturdy and stout in texture, there is a possibility of its fruiting next summer if it is afforded a decided rest now. The disposition of Pines to throw up is indicated by a more than ordinary number of rather small sharp-pointed leaves forming in the centre, and having a tendency to spread outwards. Plants that produce few, large, and upright leaves are not likely to fruit for some time. Give no more water for a month or more, and follow the instructions in the work you possess as to temperatures and general management. We should not start such plants as yours before February, and not then unless you can insure a bottom heat of 85° and a minimum temperature in the house of 65° to 70°. Until then keep them dry in a temperature of 60°, falling to 55° on cold nights, so as to afford them a complete and decided rest. This is the only method you can adopt for insuring your object.

Syringing Fruit Trees (Old Subscriber).—You cannot err by carrying out your project, as, although cleansing the trees now will not prevent the attacks of aphides in spring, you may expect they will be diminished in numbers. Soft soap dissolved at the rate of 2 or 3 ozs. to a gallon of water, adding also a small lump of soda, then a fluid ounce of petroleum to each gallon of the soapy water, would be a good and safe dressing to the trees now, and you may apply it at a temperature of 140° without any fear of injuring them when their buds are dormant. The orchard-house trees may be treated in the same way, but it will be advisable to prevent any great quantity of the liquid draining into the pots or saturating the soil containing the roots. Mr. W. Litchfield recommended on page 596 last week what we believe will prove an excellent dressing for destroying insects on trees. He describes the process as follows:—"First slake a peck of lime with water to the consistence of cream, and whilst still hot add one pint of the brown oil of tar. This when mixed forms a tar soap or emulsion which annihilates the American bug. Colour with soot if you like." This will no doubt form a good dressing for both trees and walls that are infested with insects, and we shall be glad if those of our correspondents who may try it will eventually state the results.

Pears not Thriving (Trike).—The reason your cordon Pears do not succeed is not far to seek, as you say you made your border on the top of the grass. We presume by that you did not break the grass surface up at all, and hence adopted very bad practice. Your only remedy will be to take up the trees and well trench the border 2 feet deep, but if the subsoil is not good do not bring it to the surface, but well stir it up with a fork. Mix your newly-made border with it, adding a little well-decayed manure and wood ashes, and when replanting the trees place some good loam around the roots. Mulch in the summer to keep the roots cool and moist.

Budding Fruit Trees (Idem).—Plums and Cherries are budded in July, or when the bark runs freely. Select a smooth place on the stock where you wish to insert the bud; tie it in with soft matting, taking care that the eye of the bud fits closely and firmly to the stock. Do not head the stock down at the time of budding, nor until the following spring, or the growth will start prematurely, whereas the buds should remain dormant. The stock should be cut down to within about 4 inches of the bud, and as the young growths advance tie them securely to supports, or they may get blown or broken off.

Fertilisation of Arums and Anthuriums (Norman).—Though both these genera are included in the family Aroideae there is considerable difference in their floral structure. In the Arums the flowers are unisexual—that is, male or female only, and are produced on the lower portion of a fleshy spike termed a spadix, the upper portion being without flowers and club-shaped. The flowers are in rings, the highest being the males, which consist of anthers only without filaments or envelope of any kind. Below these are a number of thread-like projections, which are really abortive flowers, and below these at the bottom of the spadix are the female flowers, simply ovaries without perianth or appendages of any kind. The spadix is wholly, or partly, surrounded by a coloured leaf-like expansion termed the spathe. In the Anthuriums the flowers are perfect—that is, contain both stamens and pistil enveloped by a perianth, and, as in the Arums, are closely packed on a cylindrical spadix. To insure fertilisation in the case of the Arums, it is obvious that pollen must be conveyed from the stamens at the upper part of the spadix to the ovaries at the base, but this is unnecessary with the Anthuriums, as when the anthers burst the pollen can be readily distributed, and they are indeed, to a great extent, self-fertilising.

Climbing Plants for a Porch (F. C.).—No permanent climber grows with the rapidity of an annual. Could not you continue to have boxes for annuals alongside the others for a time? Ivy would answer well in boxes, and its growth is much accelerated by making the soil very rich with manure. The Silver Ivy (*Hedera elegantissima*) is very handsome, of free yet neat growth, and would make a bright chaste clothing for your porch. We have one planted ten years ago that is now 20 feet high. If you prefer green leaves, then take the Irish Ivy (*H. canariensis*), or *H. Regneriana* with its large handsome heart-shaped foliage. If your porch is not exposed to cold cutting winds, *Escallonia macrautha* is preferable to Ivy. It is an evergreen, has handsome glossy green foliage, grows

fast in rich soil, and has lovely deep pink flowers both in spring and autumn. A Clematis might be planted with it, preferably *C. Jackmannii*, always valued for its deep purple flowers, and doubly valuable for you because it would blossom when the *Escallonia* had not much bloom.

Various (Idem).—If the temperature of your house is much higher than that in which the plant was grown in the nursery, that would account for the flower buds falling. A minimum night temperature of 55° is suitable for *Abutilons*, with the usual increase during the day. You could only expect quite a small plant or "rooted cutting" for the price you name. We presume you removed the flower. The treatment you describe is correct, and with care the plant may be expected to grow. Cuttings of the healthy shoots of *Zonal Pelargoniums* inserted now singly in very small pots of sandy soil placed on a shelf in your pinery, and watered judiciously, will emit roots, and in due time make healthy plants. When water is given apply it in sufficient quantity to pass quite through the soil. Surface sprinklings are dangerous to cuttings of all kinds. Water must only be given when the soil is so dry as to crumble when pressed with the finger. The older plants keep dry, giving them little or no water for a month, and cut them down early in March; then, after they have pushed fresh growth half an inch long, shake them out and place in smaller pots, using fresh, loamy, and gritty soil.

Inarching Vines (G. P., Hants).—If the Vines to which you refer are healthy and vigorous, you would in all probability produce fruiting canes more quickly by inarching than by planting the young Vines; but if the Vines are exhausted and make but little growth it would be preferable to plant out the Muscats, but it is little use doing so in an old border, and stations of fresh soil should be provided for them. The condition of a Vine is of far greater importance as a stock than its variety. The Canon Hall Muscat is not an easy Grape to grow, and skilled attention is needed to insure the berries setting and swelling. We should not have two Vines of this variety in a small house, but we presume you have no choice in this matter.

Yellow Chrysanthemums (W. G.).—Your request is not so clear as is desirable. No one can tell whether you want one or a number of varieties, or whether you want incurved or Japanese flowers, or both. Of the bright yellow incurved varieties none is better for decorative purposes than *Mrs. Dixon*; of Japanese *Fulton* is one of the brightest and best; and the reflexed *Chevalier* *Domage* is valuable for the conservatory. No Chrysanthemums are naturally dwarf, but those we have named may be rendered compact by the cultivator by frequently stopping the shoots and training them neatly. Cultural notes have recently appeared in our columns, and you will find others in the present issue, while still others are awaiting publication. If after these have appeared you need further information we will readily give it, but we must ask you to state your wants more fully and clearly.

Renovating Old Pear Trees (A Notts Vicar).—The method of removing the spurs and inducing fresh growths that we have previously recommended, but which you cannot remember, is probably the following:—The fact that fruit is produced only on the extremities of the branches of the trees on walls suggests a remedy. With a saw remove the fruitless spurs close to the main branches, paring the "cuts" smoothly with a sharp knife. If the branches are covered with moss it will be well to dress them with freshly slaked lime, the colour of which can be toned down with soot if required. This will cleanse the bark. In the spring fresh growth will be produced in clusters all along the stems; this must be thinned out by rubbing off a great number of the shoots—not cutting them, eventually retaining only those that are short-jointed and placed 2 or 3 feet apart. These should be tied down to the main stems, and if they are not shortened they will in due time produce fruit spurs precisely in the manner of the extremities of the branches. The exact distance for leaving these young growths can only be determined by their character. If the growths are very luxuriant they may be bent and trained backwards along the main branches—that is, with their points directed to the trunk of the tree, but if only of moderate strength this is not necessary. By adopting this practice there will be no fruit for two years; but after that time fruit will in all probability be produced freely over the entire surface of the wall, and with judicious pruning the trees will continue fruitful for a considerable time. We have proved the value of this method of rendering old Pears fruitful, but it is only applicable to trees that are healthy and free from gum and canker.

The Myrtle-leaved Orange (D. C.).—The fruits of this Orange are small, with an acid and bitter pulp, and the plant is grown chiefly for ornamental purposes, but probably the rind might be candied as you suggest, though we should advise a trial on a small scale first. By some it is considered a variety of the common Seville Orange type, and is named *Citrus vulgaris*, var. *myrtifolia*, but others describe it as a variety of *C. Aurantium*, and it has been considered as a distinct species. A good figure of it is given in the "Botanical Register," plate 346, 1819, under the name of *C. Aurantium myrtifolia*; and it is mentioned that Sir Joseph Banks then had some fine specimens at Spring Grove, Isleworth, his method of increasing it being to graft six scions of the variety upon a stock of the common Orange. By this means handsome examples were obtained, which flowered and fruited extremely well. The plant when grown upon its own roots is much dwarfer than other Oranges, never exceeding the dimensions of a small shrub.

COVENT GARDEN MARKET.—JANUARY 3RD.

OUR market has been very dull since Christmas, but with slack supply prices have been rather better.

VEGETABLES.

		s. d.	s. d.		s. d.	s. d.					
Artichokes.....	dozen	2	0 to 4	0	Lettuces	score	1	0 to 1	6		
Asparagus.....	bundle	0	0	0	Mushrooms	punnet	1	0	1	6	
Beans, Kidney	100	1	0	0	0	Mustard & Cress ..	punnet	0	2	0	3
Beet, Red.....	dozen	1	0	2	0	Onions.....	bushel	2	3	2	6
Broccoli.....	bundle	0	9	1	6	Parsley.....	doz. bunches	3	0	4	0
Brussels Sprouts..	½ sieve	1	6	2	0	Parsnips.....	dozen	1	0	2	0
Cabbage.....	dozen	0	6	1	0	Peas.....	quart	0	0	0	0
Capsicums.....	100	1	6	2	0	Potatoes.....	cwt.	6	0	7	0
Carrots.....	bunch	0	4	0	0	Kidney.....	cwt.	6	0	8	0
Cauliflowers.....	dozen	2	0	3	0	Radishes.....	doz. bunches	1	0	0	0
Celery.....	bundle	1	6	2	0	Rhubarb.....	bundle	0	4	0	0
Coleworts.....	doz. bunches	2	0	4	0	Salsafy.....	bundle	1	0	0	0
Cucumbers.....	each	0	6	1	0	Scorzenera.....	bundle	1	6	0	8
Endive.....	dozen	1	0	2	0	Seakale.....	basket	1	9	3	3
Fennel.....	buuch	0	3	0	0	Shallots.....	lb.	0	3	0	0
Garlic.....	lb.	0	6	0	0	Spinach.....	bushel	3	0	0	0
Herbs.....	bunch	0	2	0	0	Tomatoes.....	lb.	0	8	1	0
Leeks.....	bunch	0	3	0	4	Turnips.....	bunch	0	2	0	3

FRUIT.

	s. d.	s. d.		s. d.	s. d.
Apples.....	½ sieve	2 0 to 7 0	Grapes	lb.	2 0 to 5 0
".....	per barrel	20 0 40 0	Lemons.....	case	10 0 20 0
Apricots.....	doz.	0 0 0 0	Melons	each	0 0 0 0
Cherries.....	½ sieve	0 0 0 0	Neetarines...	dozen	0 0 0 0
Chestnuts.....	bushel	10 0 12 0	Oranges	100	6 0 10 0
Currants, Black..	½ sieve	0 0 0 0	Peaches	dozen	0 0 0 0
" Red.....	½ sieve	0 0 0 0	Pears, kitchen ..	dozen	1 0 2 0
Figs.....	dozen	0 6 1 0	dessert	dozen	1 0 2 0
Filberts.....	lb.	0 0 0 0	Pine Apples, English	lb.	2 0 3 0
Cobs.....	100 lb.	50 0 55 0	Raspberries	lb.	0 0 0 0
Gooseberries	½ sieve	0 0 0 0	Strawberries	lb.	0 0 0 0



POULTRY AND PIGEON CHRONICLE.

A RETROSPECT OF THE HOME FARM, 1882.

AGAIN we give a retrospective view of the circumstances which have attended the home farmer in his endeavours to successfully carry out his practical business. In our former retrospects we have always assumed that his agricultural year or season commences on the first day of October, our opening observations will therefore begin with October, 1881. We cannot remember a more favourable season for Wheat-sowing on all soils, and likewise the seed time for Rye, Trifolium, Vetches, Winter Beans in the proverbially fickle climate of the British Isles. We can recollect years when the autumn season had been quite as forward, but never one more healthy, during which nearly all kinds of farm work had been carried on with so little interruption either in the cultivation of the land or in another important point, that of the management and health of the flocks and herds generally throughout the kingdom. The progress on the home farm at the commencement of the year was very promising, for all the Wheat and autumn-sown catch crops were remarkably healthy, at the same time the health of the stock was much better than it had been for several previous years. The early lambing Dorset and Somerset ewes had passed through a favourable lambing season, and a large number of healthy lambs had been saved. Dairy cows had never passed through a better autumn season, for the grass continued fresh and growing on all favourable situations, and the milking period was continued longer than usual, whilst the store cattle and young stock were never known to have been in finer condition than at the close of the year. This is a favourable picture of the stock and prospects of the home farm.

A few words must, however, be said relative to the probability of the home farmer having more land on his hands on various estates than he has ever had before, and also that more intelligent, industrious, and persevering men will be required in the immediate future to manage farms which through the general agricultural depression have been thrown upon the hands of proprietors. In consequence of what we term the great revolution in agricultural affairs, both in regard to the interests of proprietors of land as well as occupiers, it is quite clear that home farmers as well as occupiers generally will have to make and undertake to carry out a new departure—a change of cropping and system of cultivation.

In the home farm department of this Journal we have kept steadily in view during the past five years the actual necessity of treating most of our subjects introduced during that period with the object of enabling the home farmer to combat with success the great and increasing difficulties surrounding his position. In doing this we have brought the experience of a long life to bear upon the various subjects; and although many of them some years ago were not appreciated by some farmers, yet as they were

based upon our own practice we with confidence have recommended them for adoption as the means of proceeding under what we term a new departure, so indispensable for application in the present and approaching difficulties of the future. We must ask him to refer more particularly to the articles explaining the alterations in cropping and cultivation of both light and strong soils as compared with the four-course rotation and other systems so much in fashion in times gone by. We must also call his attention to the subject of continuous corn-growing upon fertile and vale soils, as well as vegetable cropping of lands near the towns and within reach of the metropolis by railway. At the same time, it should be remembered that manuring by green crops ploughed under on certain outlying soils has been found to have the double effect of manuring and fallowing at one and the same operation, and at a less cost in some cases than the naked fallow. In fact, it will be found that under a system of continuous cropping it proves to be a continuous fallowing as well as cropping. In our case we never made a long fallow for more than twenty years, for when couch and weeds are forked out at every opportunity it diminishes the cost of either steam power or animal labour in the cultivation.

Again, with reference to the breeding and feeding of stock, our articles upon the subject show that animals do not pay for fattening under ordinary circumstances, unless the breeding is connected with it on the same farm. Frequently, too, it does not even then pay unless the animals, whether they are of sheep or cattle, are maintained in improving condition from their birth to their death by slaughter, being kept and fed so that the animals may never lose their calves or lamb's flesh, and be fed under a liberal system of proper food, upon the principle and practice of early maturity. To prove this it is only necessary to examine the weight for age of the stock at all the recent cattle shows—those of London, Birmingham, and other large towns, and it will be found that lambs in the sheep classes are the heaviest at their age; and it is just the same with bullocks.

Let us consider how these facts affect the consumers of this country. It is collected from the statistics in the total of Great Britain, and shows a decrease of cattle between the years 1874 and 1882, amounts 318,491 of all ages; and also exhibits the decrease in sheep of all ages for the period from 1874 to 1881 to have reached the marvellous number of 5,732,888; and the decrease in swine is proved to be 374,742 of all ages for the same period. Let us now consider how this deficiency can be made up, for it is evident that our foreign importations, great as they have been, are likely to fall off rather than otherwise, because the population abroad over the areas of production continues to increase to an enormous extent. This diminution of live stock has been going on for years, but to a very large extent the quantity of meat has been made up under the system of early maturity to which we have referred, and will in the future be the means of equalising demand and supply.

With reference to the price of corn, so long as we have foreign imports to contend with the price must be low, and our only refuge to which we can resort is in obtaining large and abundant crops, but this has unfortunately for seven years been denied us as a rule, through the influence of adverse seasons. To take another rule, we find that crops of corn, but especially Wheat, are still the rent-paying crops upon arable farms, and so we believe they are likely to be for many years to come, the only exceptions being the produce of certain districts where local requirements are of a special kind, such as fruit and vegetables, for it is evident that we keep stock for the purpose of manuring the land to enable it to carry full crops of rent-paying commodities. Yet it is a common thing to hear the unpractical portion of writers upon the subject exclaim, "Oh! corn does not pay for growing, you should therefore fall back upon stock." This is an extreme fallacy, for unless upon fertile pastures the feeding of cattle or sheep for slaughter, or the results of dairy farming, it cannot be made to answer the purpose other than as above stated, the manuring of land to secure full crops of corn. It is true that the statistical returns show that the growth of Wheat has decreased during the past eight years by 626,300 acres, and Barley also during the same period by 32,937 acres. However, this indicates chiefly the inability of the landed proprietors, as well as tenants, to find capital sufficient for its cultivation, and consequently we find an increase of land left in pasture or run to waste amounting to 1,643,988 acres, for we know various properties now only a sheep walk which were formerly within our knowledge arable farms cultivated successfully.

We must now, however, consider the nature of the season after entering on the year 1882. The growing Wheat presented a beautiful and luxuriant appearance, with a regular plant, very forward, and of a deep green colour, which usually promises abundance. The work of the farm, too, was forward, it having

been conducted without any interruption, so that all the Leut corn, Barley, and Oats, as well as Beans and Peas, were sown early, with as fine a tith as could be desired. All the field grasses, Clover, and Sainfoin were strong and of luxuriant growth as well as regular in plant. The pastures likewise carried a most promising appearance, the only exception being a rather irregular growth in the water meadows owing to a short supply of flood water in the previous winter. This altogether beautiful prospect induced us to think that although Dame Nature had in previous years got into our debt we may expect to be paid in the course of the seasons. The flocks of sheep both on the hill and vale farms were generally healthy, and the ewe flocks had produced a large number of lambs of nearly all varieties. Cattle, too, were reported free from disease in nearly every district.

This prospect of early abundance had the effect of raising high hopes in the farmers' breast, that we had entered upon a cycle of seasons which would requite them for their many losses by flood and field. It was, however, not destined for the present year to prove one of the cycle, for on the 29th of April a terrible storm prevailed throughout the kingdom with more or less severity, and it was followed by cold easterly winds, which arrested in their growth all kinds of vegetation, and destroying at one blow all our anticipations in which we had indulged of an early and abundant harvest. Nevertheless, although the character of the weather during the summer proved cold and stormy and unfavourable for cereal crops, yet the hay crops were bulky in quantity; the Bean and Pea crops, too, were good in the midland and western counties, and the season may also be called one particularly favourable for the grazing of cattle. Still, though the hay crops were good all round, yet the difficulty of securing it in good condition was very discouraging. It was, however, a season well suited to test the experiments of securing hay in bad weather by the use of the exhaustion of heat from the ricks after being built with the various kinds of fans devised for the purpose, and it is unfortunate that many failures have occurred by the hay ricks thus treated proving in most cases of little value. It is, however, with regard to both hay and corn, especially in the northern counties and Scotland, that we yet trust the system may ultimately be made available. We cannot but consider the statements made by Messrs. Neilson & Knowles, the originators of the system, are truthful, and as it proved successful with them for a series of years there is yet hope that farmers may eventually master the details. The Royal Agricultural Society made a sad blunder in the experiments carried out at the Reading meeting, and is likely to discourage many persons; we have, however, strong hope that eventually it may be brought into use so as to enable the farmers to combat the climate. Mr. Gibbs' steam hay-drier will be sure to answer the purpose of drying both sorts of hay, either of meadow or field growth, but it is better for the former than the latter, as we fear much leaf of the field hay will be lost in the process; this, together with the cost of the machinery, being £350, will serve to exclude its use in many instances.

We must now refer to the root crops of the kingdom. Mangold and Potatoes are both under the average by reason of the low temperature which prevailed; but Swedes, Turnips, Cabbage, and Carrots are fine crops, and the late crops of grass most abundant; this tended to raise the value of sheep, together with diminished numbers, to a price higher than we can ever recollect in any previous year. The same may be said with cattle, which have made high prices. Serious floods have occurred in various counties which have proved disastrous in grazing districts.

To conclude our retrospect we give a general statement of the results of the harvest. We estimate the Wheat crop as an average one of the last seven years, but under the average of twenty years, with a large acreage grown owing to the favourable seed time, and the grain of good quality where well harvested. Barley like Wheat is about an average of the last seven years, but of poor quality and badly harvested. Oats are one of the finest crops ever grown in England, having been, however, somewhat injured by the difficult harvest. We cannot omit the notice of full crops of straw generally, which is important both for fodder and sale, especially the latter, as it has lately made a higher value than it has ever done before.

MAXIMUM WEIGHT FOR AGE OF CATTLE AND SHEEP.

(Continued from page 603, last vol.)

As space could not be found last week for the conclusion of our remarks we now give the weight for age of sheep and lambs, some of which were exhibited at Bingley Hall Show and some at the Islington Hall Show. The heaviest pen of three Lincoln wether sheep alive, weight of 9 cwt. 0 qrs. 22 lbs., is recorded. The pen

of Coltswoold wethers, shown by Mr. Thomas of Cardiff, weighed 8 cwt. 4 lbs. The Leicesters, formerly called the premier breed of England, are at present held by few, especially of the pure Dishley stock descended in a direct line. The weight of the heaviest pen of wethers was only 6 cwt. 3 qrs. 14 lbs. The South Downs, although maintaining their admirable position for quality, are in weight much less than some others; but we cannot refrain from giving them a place here, as the wethers shown by the Duke of Richmond weighed 6 cwt. 9 lbs., and at weight for age nearly approached the Leicesters, and we notice them, readily admitting nothing in the mutton classes can exceed them for quality. We will now refer to the Oxford Downs (the pen of wethers weighed 8 cwt. 8 lbs.) shown by Mr. Brassey. The Shropshire class exhibited a pen of wethers, the best weighing only 7 cwt. 1 qr. 6 lbs., as shown by Mr. Loder. We must now refer to what is frequently called the coming sheep—viz., the Hants and Wilts Down sheep. But although splendid and heavy weight for age as they show, exceeding all others for early maturity, yet they can never displace the long-wooled breeds in their native strongholds (the grazing pastures of the midland and northern counties), for this simple reason—that they cannot be trusted to graze in company with bullocks as the long-wools do because of their roaming habits, for they will not cat and lie down side by side with horned cattle as the long-wools will always do. The heaviest pen of wethers was shown by Mr. Morrison, who, it seems, cannot yet be beaten in wether sheep, weighed 8 cwt. 2 qrs. 24 lbs. As in the cattle classes we made especial mention of the weights for age of the youngest animals, so we must give special attention to the weights of lambs in the sheep classes. At Bingley Hall Show the pen of three Hampshire Down lambs, exhibited by Mr. Morrison of Tisbury, Wilts, weighed at about ten months old 7 cwt. 3 qrs. 1 lb., live weight. At the Islington Hall Show a pen of three lambs of the same breed, exhibited by Mr. Wm. Parsons of West Stratton, Hants, at the same age weighed 6 cwt., live weights. Either of these pens of lambs exceed in weight any lambs of the long-wooled breeds and all others, and this is very important for practical men to consider; but at the same time it must be remembered that these lambs were probably housed and fed under cover during their whole lives, and were also selected from large flocks, and as the per-centage of exceptional animals may be reckoned at 3 per cent. every lamb shown was an exceptional animal, for even amongst the three exceptionals there will always be one better than the others. It is, therefore, not too much to say that several breeders of Hants Downs may have done likewise, especially Mr. George Judd of Barton Stacey, Hants, who took the prize for the best hundred lambs at Winchester Show Fair in October last, which lambs averaged over 13 stone at about eight months old, all fed in the open field. We mention this to show the home farmer the actual difference between open field feeding with a whole flock and house feeding with a few select exceptional animals. The result of this selection and house-feeding must at any rate meet with the approval of the butchers and consumers, especially at Christmas time. Such results as we have named cannot be realised by any of the long-wooled breeds, weight, age, and quality considered.

POULTRY AND PIGEONS

CHALLENGE CUPS.

THERE can be no question about the fact that the Birmingham challenge cup has given a great impetus to the Game fancy. In what other breed do we hear of £50 and £100 being given for a bird? Now and then, it is true, some famous Dark Brahma fetches an equally long price, but then it is a bird which is sure to win, and to win back a considerable part of its purchase money, and with this object it is bought. Game fanciers, however, have of late given these sums for specimens of high pedigree with a view solely to breeding. Making allowances for the fact that they have long been peculiarly scientific and careful breeders, and that consequently it is to them of supreme importance to have stock birds as near perfection as possible, still the desire to win the great prize encourages this care, and the chance of winning it attracts new admirers to the breed. Is it desirable that any breed should have this special encouragement? We have seen plausible reasons against the offering of such cups. Some years ago cups of considerable value were subscribed for and given at the Crystal Palace for Dark Brahma cockerels and pullets. These were objected to, and not without reason as it seemed to us, because in the first place they were only the result of a transient *furor* of the year, and there was little

attempt to make them an annual honour; and secondly because, being got up for the particular occasion and shortly before the show, there was a strong presumption as to who the winners would be. Indeed, it was rumoured that the probable and, as the event proved, the actual, winners really did subscribe a considerable amount of the cup's value. To the case, however, of challenge cups subscribed for or presented long before the competition, and only to be held for a year, or actually made over to their holders after a series of victories, these objections cannot possibly apply. The very conditions under which they are to be held and won provide for several years at least, and prevent all chance of a fancier who happens to have a good lot of chickens subscribing for his own benefit. The only reasonable exception, as far as we can see, that can be taken to them is this—viz., that they make too much difference between the first and second-prize birds. It may be asked, Why put this great distinction between two birds which possibly differ so little as to cause a judge much perplexity, and which different judges would place in different order? To this we say, the objection applies to all order of merit in awards. In every prize list it must of necessity frequently be the case that there is hardly appreciable superiority in some first-prize bird over the second, or second over the third. The objection applies far less to a cup given to the best of many first winners, because in several classes there is more chance of one bird standing out in front of all competitors than there is in a single class.

However, putting aside these minor objections to any large and handsome prize, all of which seem to us easily answerable, we must look at the whole subject from a broader point of view. What is the object of all such competitions and all prizes? Surely it is to encourage the breeding of poultry through the means of emulation, and whatever arrangement of awards promotes that emulation in the best and fairest way is the best arrangement. The rewarding of this or that specimen with a first or a second prize is only a minor and accidental consideration. The general encouragement of intelligent and enterprising breeders is the main end, and the one which we should keep steadily in view when we draw up schedules and arrange prize lists. "The proof of the pudding is in the eating," and the fact that the offering of a challenge cup for one particular breed has had a marked effect in promoting excellence in that breed is in itself a strong argument in favour of the offering of challenge cups.

The aim which we have in view in calling attention to this fact is to suggest to fanciers of other breeds whether they might not usefully combine to procure similar distinctions for their own varieties. Dorkings especially occur to us. There is not the array of them there once was at Birmingham when the prizes were pecuniarily far better worth winning than they now are. We are inclined to believe that this decline in numbers has some connection with reduction in the amount of prizes. Those who trade upon exhibition and sell their superfluous stock at enhanced prices on the strength of one or two Birmingham prizes are content with this, and do not think so much about the sums actually won. There are, however, many exhibitors of Dorkings, and there used to be more, who do not show anywhere else. Owners of parks and large estates peculiarly adapted to the cultivation of this variety allow their bailiffs and gamekeepers who rear them to show a few birds once a year for their trial, and Birmingham is generally the show selected. If, however, the returns are very small, and nothing but a first or second prize can possibly recoup the cost of entry fee and travelling expenses, this permission is likely to be withdrawn, and as we well know often has so been. Still, the numbers have fallen off, and not the quality. It struck us this year at Birmingham that the Dorking winners were an extremely good lot, surpassing far in excellence as a whole those of any other show of the season. This is evidence that it is the place to which the great Dorking fanciers turn in spite of the fact that the prize list is hardly worthy of the place or the breed. We cannot but think that if some energetic admirer or band of admirers of this fine old breed would collect enough to purchase a handsome challenge cup great good would accrue. Those who possess fine stocks would be encouraged to keep them up, and those who do not exhibit their birds to do so at least this once a year. We think much of this last point, for we feel sure that there are owners of fine yards of Dorkings who seldom or never let their birds be publicly seen, and so do not give their neighbours a chance of buying of them. All that tends to discourage overshadowing and professional showing of a few birds, but promotes the occasional exhibition of the flower of many yards, does good to the poultry fancy. Some more challenge cups would probably have this desired effect.—C.

FORTHCOMING POULTRY SHOWS.

It is to be hoped for the sake of exhibition poultry that the month of January may not be a cold one. A number of schedules of shows

are lying before us, the greater part of them to be held during the early weeks of next year. For the 10th and 11th of January the second of the revived Taunton shows is fixed, of which we have before spoken. Classification for poultry and Pigeons is good and exhaustive. There is a valuable prize—viz., a six-guinea cup, offered by Mr. Marshall, the President of the Society, for the winner of the largest number of prizes in the open Pigeon classes. This cup is awarded in a somewhat unusual way, for prizes do not, according to their degree, count so many points, but all are considered equal.

ON the 11th, 12th, and 13th the Aberdeen Show is to be held. There are sixty classes for poultry, arranged alphabetically. Among them are eight for Dorkings, which are always strong classes in Scotland. The entry fee is moderate—viz., 3s. 6d. The Judge is Mr. A. Comyns, Hon. Sec. of the Poultry Club. The Pigeon classes are forty, twelve being for Pouters, the special fancy we presume of the locality. The Pigeon Judge is Mr. E. Beckwith. The entries close on Dec. 30th, and the Secretary is Mr. John Cowe, 27, Dee Street, Aberdeen.

THE Show of the Dudley Columbarian Society is fixed for Jan. 12th, 13th, and 15th. The poultry section consists of six classes for Game and five for Game Bantams, and is to be judged by Messrs. Robert Ashley and W. H. Wheeler. Pigeons have twenty-seven classes. Among them are special classes for "Eastern Frilled," and "German Non-Frilled." The Judge of Pigeons is Mr. J. W. Ludlow. There is an unusually good schedule for cage birds. The Hon. Sec. is Mr. G. H. Parke, Saracen's Head Hotel, Dudley.

WE have the schedule of the first show of any importance, to be held at Buckingham on January 17th and 18th under Poultry Club rules. We fancy that its origin, like that of the Hemel Hempstead Show, is greatly owing to the energy of the Rev. H. R. Peel, whose name we observe upon the Committee. Poultry have forty-one classes, Pigeons eleven. The Judges are Mr. Teebay and Mr. Esquilant. The Hon. Secretary, Mr. G. F. Marsh, Buckingham.

ON the 24th and 25th the sixth Yeovil Show is to be held. It has certainly become a leading Exhibition, and the classification is extended. It is one of the few shows of the season at which fanciers of White Game and Silkies will find classes for their favourites. Game Bantams, too, are favoured with eight classes for single birds, and other Bantams with five for pairs. In Pigeons Pouters have four classes, Carriers six, Dragoons six; Tumblers, Owls, Turbits, and Antwerps, each four. But fanciers should send for the prize list to Mr. Robert Leach, Pall Hotel, Yeovil.—C.

OUR LETTER BOX.

Goat Farming (*A Subscriber*).—We shall most readily redeem our promise made on November 23rd, 1880, and propose to give an article on Goat farming in an early issue.

Book on Poultry Keeping (*J. N.*).—The price of the book by Mr. Cook is 2s., post free 2s. 2d.

Crop-bound Fowl (*Ernest Bewley*).—You have adopted the right treatment, and if further efforts fail to afford relief the only alternative will be to open the crop and remove the obstruction; but skill is requisite for performing the operation successfully, and we should persevere with the warm water, rubbing, and castor oil remedy for some time longer, and especially as it has proved beneficial.

METEOROLOGICAL OBSERVATIONS.

CAMDEN SQUARE, LONDON.

Lat. 51° 32' 40" N.; Long. 0° 8' 0" W.; Altitude, 111 feet.

DATE.	9 A.M.					IN THE DAY.				Rain.
	Barometer at 32° and Sea Level	Hygrometer.		Direction of Wind.	Temp. of Soil at 1 foot.	Shade Temperature.		Radiation Temperature.		
		Dry.	Wet.			Max.	Min.	In sun.	On grass.	
1882.	Inches.	deg.	deg.		deg.	deg.	deg.	deg.	deg.	In.
December.										
Sun. 24	29.832	33.5	32.0	N.W.	38.8	40.2	30.4	56.1	27.2	0.071
Mon. 25	29.629	44.6	44.6	N.W.	37.8	52.5	31.8	52.7	27.8	0.524
Tues. 26	29.370	50.1	50.1	N.W.	40.8	49.8	43.8	61.5	43.1	0.205
Wed. 27	29.555	54.4	52.0	W.	43.0	57.2	48.5	57.8	45.3	0.066
Thurs. 28	29.736	54.5	51.6	W.	45.0	55.4	52.8	57.5	50.2	0.012
Friday 29	29.606	51.3	50.0	S.W.	45.7	54.3	48.8	55.3	47.2	0.196
Satur. 30	29.737	49.7	49.2	S.W.	46.1	53.3	46.9	54.2	45.3	0.443
	29.638	48.3	47.2		42.5	51.9	43.3	56.4	40.9	1.517

REMARKS.

24th.—Fine, bright, and frosty.

25th.—Dull, wet, and mild.

26th.—Fine but damp morning; rain afterwards.

27th.—Fine at first; afternoon and evening wet; very warm.

28th.—Squally during night; fine, dry, mild day.

29th.—Squally; slight misty rain at times.

30th.—Very wet morning; fine, with clearer sky, in afternoon; dull damp evening; still very mild.

Although the first day of the week was frosty, the latter part was so remarkably warm as to raise the mean for the week to nearly 48°, or 9° above the average.—G. J. SYMONS.



11th	TH	Royal Society at 4.30 P.M.	
12th	F	Quekett Club at 8 P.M.	[Covent Garden.
13th	S	Sale of Hardy Plants and Bulbs at Mr. Stevens's Rooms,	
14th	SUN	2ND SUNDAY AFTER EPIPHANY.	
15th	M		
16th	TU		
17th	W	Society of Arts at 8 P.M.	

GARDEN STRUCTURES.

THE part which glass houses play in the success or non-success of gardeners has not, I think, ever been fairly taken into account in estimating results. Even the Grape Vine resents in many cases the accommodation afforded it, while there are very few gardens which have not one or more examples of plant structures totally unfitted for the purpose. Not only is this the case, but such examples are to be found in instances where the glass has been lately erected, sometimes by horticultural builders. Only lately a gentleman applied for the plan of a structure in which plants would grow, and yet he had within the last two years erected a series of houses for plant culture. I had an opportunity of inspecting the range, which looked most promising from the further end of the garden, but the houses were not fitted for the work. I know it is said that gardeners are not to blame when such cases occur, but I know more than one gardener who has had the planning of houses. I have a very unsatisfactory house, but it is, however, the only structure out of several since erected that I would condemn; the pitch of the roof being too steep, and practically unsuited for cultural purposes at any time except during spring and autumn. There is perhaps no plant, at least no popular plants, which so thoroughly show like or dislike to their quarters as many Orchids, and not only uncommon Orchids, but even the best known kinds. I know a good Orchid grower who fails with *Dendrobium nobile* and *Cypripedium insigne*, because there is not a structure in his garden in which they will grow. A visitor lately expressed his surprise at the growths *Odontoglossum Roezlii* was making here, as he could hardly induce it to keep alive. In this instance the plant in question grows like a weed with no more care than is bestowed on our commonest plants. The following is a very striking instance of the effect that a proper house has on the health of a plant. When I came here I found the *Eucharises* in a very poor condition, and ascertained that there had never been anything made of it. A fresh stock of healthy plants was obtained, and these went exactly like the others, and for several years experiments were tried, and always without success, until a new structure was erected for growing that and similar plants, and within six months the stock was in perfect health. We have a large and uninterrupted supply of *Pelargoniums* and *Lily of the Valley* the whole winter through; but a few years ago we could not have so managed with the kind

of glass houses then at our command. Now with proper structure we find no difficulty.

As to the kind of structure for particular purposes, I would greatly prefer large structures for the culture of fruit. A Peach house or a vinery as a lean-to should not be less than 18 feet wide. The cost of erection is considerably increased in the case of large houses as against small ones, but after they are up and paid for the large houses have all the advantages on their side. To the gardener who is pressed not only to produce fruit but also to produce flowers without the necessary accommodation, these large houses are especially valuable; so valuable are they that I know an instance where a crop of *Chrysanthemums* from two Peach houses nearly doubled the amount brought for the legitimate crop in the previous summer and autumn. When fruit houses are erected the requirements of the future with regard to flowers should most decidedly be taken into consideration. The furore for fine-foliage plants appears to be decreasing, and flowering plants becoming more prominent. By this change in fashion more work will be entailed on gardeners, and so much the easier will it be for those who can employ their glass structures for the production alike of fruit and flowers.

We do not need plant houses very large. Gardens generally are not so much kept up for show as for utility. Large specimen plants are in most cases found to be costly, taking up room without any adequate return being given; the most useful plant structures therefore will be found to be low flat buildings about 12 or 13 feet in width, with a central path and two side beds or benches. At the same time where cut flowers are in great demand *Camellias*, *Lapagerias*, and *Gardenias* will require structures of larger dimensions in order to allow for planting out.

Would-be investors in glass houses must be much perplexed by the several inventors and patentees in the field. Having to do most of such work with local and estate labour, I have had my share of thought in connection with this matter. Putty or no putty, Belgian *versus* English glass, deal against log, iron instead of wood, have all been under serious review. Several hundreds of miles have been travelled to see the best systems. However, up to the present we have not dispensed with putty, though it is employed only as a bed for the glass, as effective and more lasting than using it as a holder-down as well. Good Belgian glass we found to be as expensive as the same quality of English, and have employed the latter in preference. In the matter of wood that has been bought in the log, cut up and dried before using, we can insure getting wood of an older growth from the log. Between wood and iron a compromise has lately been made. The last erection here had all the main bearers of tee and angle-iron battened into the walls, and on these the wood framework was laid and fastened down here and there with screw nails. Such a structure is as nearly indestructible as can be expected. When the woodwork gives way (there are no heavy rafters required) the screw nails are easily taken out, the roof removed, the glass taken out of its bed, a new wooden framework laid on and screwed down, and the glass returned to its former position. Such an arrangement is also cheap, while thoroughly strong. We have not tried the iron rafters on large structures as yet, but hope to

do so on a range of new vineries. Two-inch tee and angle-iron is employed for these plant structures. For large vineries with a length of 20 to 24 feet of roof a stronger make will be required.—R. P. B.

CULTURE OF CHRYSANTHEMUMS FOR EXHIBITION.

I wish to make a few remarks through your valuable Journal with regard to the production of good flowers of the Chrysanthemum. In reply to your correspondent "J. D." (page 556, last volume), one of the main features which will lead to success are never to let the plants receive a check. I much prefer striking the cuttings singly in small thumb pots not later than the end of February; allow them to remain in these till the pots are full of roots, which will be about the third week in March; shift them into pots two sizes larger, in which they can remain till the end of April, then transfer them into 6-inch pots, using moderately good soil. The plants remain in these until the middle of June, and the early-flowering varieties ten days or a fortnight later, when they are placed in 8 or 9-inch pots. The soil I employ is a strong loam, with about a sixth of leaf soil with a little bone dust or crushed oystershells.

The Chrysanthemum requires very firm potting, a little soot mixed with the soil being beneficial, and careful drainage is essential. I make a point of not overfilling the pots, leaving from 1 to 1½ inch of space for top-dressing. This is given about the middle of September. A mixture of equal parts of fibry loam and well-decayed fowl or pigeon manure is placed about half an inch deep on the surface, leaving the other space till the middle of October, when the same mixture is employed, with the addition of a little guano. I think it matters very little what kind of liquid manure is chosen if it be used judiciously. It would be a difficult matter to lay down a rule on this point, as some varieties require more feeding than others.

To ripening the wood I pay very little attention, as it is impossible to retain the foliage where the wood is ripened and to have good plants with foliage covering the pots. The wood must not be too ripe: the best and largest flowers are produced on rather soft wood.

One of the main points which leads to success is stopping at the right period. This requires much judgment, as some varieties need stopping as early as the last week in April, say Mr. Brunlees, while others should not be stopped till within a fortnight of the time of their final potting.

To bring perfect Chrysanthemums, whether incurved or Japanese, they require both heat and air night and day. When unfolding their blooms they will stand more heat than many suppose, but must have plenty of air after the flowers show colour. I use shading in bright sunny weather, as many of the colours are very delicate and soon become pale: white turns lilac, and lilac becomes almost white; besides, the incurved varieties will soon reflex and become useless for exhibition, especially for grouping.

I am convinced that several varieties are synonymous. For instance, Golden Queen and Emily Dale, Queen of England and Princess Royal, are alike. Empress of India, White Queen, and Mrs. Cunningham are also much alike, and there are several others. I will say more on a future date.—A GROWER AND EXHIBITOR.

VENTILATION.

This is a subject of general interest to gardeners, and, although I have no doubt that to the majority it is a mere matter of daily routine, and causes little or no perplexity, I must confess that I cannot look at it in that light; in fact I think that if any subject needs ventilating it is ventilation.

I am well aware that if I were to quote different writers to the horticultural press an abundant weight of evidence would lie on the side of free ventilation, while a few lines would suffice for any to the contrary. However, to start with a high authority. Mr. Taylor in his recent articles on Grape-growing says, on page 338, vol. iv., of the Journal, "Unless a house is glazed closer than I ever saw one it is not necessary to open the ventilators merely for an interchange of air." The Lanea-

shire system of Cucumber-growing has often been alluded to in these pages lately, especial mention having been made of Mr. Whittaker's nursery at Preseot by Mr. Bardney and others, and it has been pointed out how not only Cucumbers but large quantities of sturdy plants of various kinds are grown in large houses without any ventilators whatever; and yet Mr. Iggulden a week or two after, writing on winter Cucumbers, insisted on the importance of ventilating on all favourable occasions.

I think that ventilation is often overdone. We endeavour to obtain what we consider a suitable condition of atmosphere in regard to heat and moisture at great labour and cost, and immediately use means to get rid of the same as speedily as possible. Science should help us here. We know that a room filled with human beings soon becomes unfit to live in if there be no ventilation, and we have no difficulty in learning how many cubic feet of fresh air a man requires in a given time; but we want to know to what extent plants vitiate the air, or what property there is in fresh air that they require, and how much.

I may mention that at the present time I am chiefly interested in Orchids, and diligently read all I can on the subject. The stereotyped directions are, at least in the growing season, "plenty of atmospheric moisture with abundance of air," conditions easy to maintain perhaps with a genial moisture-laden south-west breeze; but how with a dry north-easter? Then it seems to me, as I have seen it before expressed, like trying to damp the air of the whole country side.

"I could a tale unfold," which, if the reader has any sympathy for the tender feelings of plants, would "harrow up his soul;" and if the recital did not "freeze his blood in his veins" the reality did do so most effectually, for a batch of Phalænopsis just pushing into growth after their long voyage was ruined, although it was done with the kind intention of giving them air.

In conclusion, in all ordinary glass houses where a considerable difference between the outside and inside temperature exists, is it necessary to open the ventilators to change the air? Will not the radiation of heat from the hot-water pipes prevent stagnation? and does any tropical plant in its native habitat ever experience anything like British east wind?—J. J., Lancashire.

DUKE OF ALBANY PEA:

THE new year is not an inappropriate time to refer to new vegetables, and amongst these must be included the Pea in question. When we remember the splendid Peas that have been introduced during the past few years it is evident that a new comer must possess high qualities to obtain a creditable position. The Duke of Albany does possess high qualities; the rows of it at Riverdale last year, where it was raised by Mr. Abbott, surpassed all others in the same garden, where all the best were grown in the most satisfactory manner.

The Duke of Albany is the result of a cross between Abbott's Hallamshire Hero, a variety of superior quality, and Culverwell's Telegraph. It is a wrinkled Marrow, growing 5 or 6 feet high, and bears its large dark green pods in pairs, the rows being laden with them. They were larger than those of Telegraph, not quite so much curved, and covered with a dense bloom. The peas are large, from nine to eleven in a pod, deep rich green in colour, and in this respect and flavour being quite equal to Ne Plus Ultra. But the new Pea is much earlier than this old favourite, for on some of both being sown on June 12th the Duke gave an abundant yield of fine pods, while Ne Plus Ultra in the cold Sheffield district failed to fill any pods at all. Judging by the rows in the Sheffield garden, and by a sample of Peas cooked and served at table, it is fair to describe the Duke of Albany as a very large early Ne Plus Ultra, and higher praise than that few, if any, Peas can merit.

The new Pea has been frequently exhibited, and has been awarded five certificates at local shows, at which all the leading varieties have been represented. As the stock of this Pea has, as I understand, passed into the hands of Messrs. Hurst and Son, London, for distribution, cultivators will have an opportunity of trying this new claimant to popular favour. If

such rows and produce are obtained as were seen by many competent judges at Riverdale last year the Duke of Albany will establish itself, as it promises to do, as a standard Pea both for exhibition and culinary purposes.—J. WRIGHT.

BLACK ALICANTE GRAPES.

THIS handsome variety is much grown, and is justly admired as being a showy late Grape. Perhaps a few notes on some of its peculiarities may be of use to those who may be about to plant vineries.

This Grape when well ripened keeps remarkably well, and when not sufficiently ripened it often turns black in the stalk. Bottled, it keeps much better than Gros Colman, and almost as well as Lady Downe's. When the laterals grow strongly they are extremely difficult to tie down to the wires, having generally to be left untied for some time after other varieties in the same stage of growth have been tied down.

Another peculiarity is that sometimes the bunches are produced on the extreme end of the lateral, and are consequently rather awkward to deal with; they are also sometimes found growing upwards instead of downwards.

Thinning the Alicante is no joke, as it sets so thickly and has so many small berries among the larger that cannot be knocked off by syringing, as in the case of other varieties. Black Alicante has a tendency to show small bunches, and, indeed, sometimes fails to show any when the rods become old; and much is gained in point of having well-shaped bunches and plenty of them, by either planting young Vines, which can be easily done without interfering with the rods under crop. In spite of these peculiarities Black Alicante is much in favour with many, and where a showy late Grape is wanted intending planters should not let its peculiarities exclude it from a place in their lists.

Many admirers of the Alicante maintain that it has a better flavour than Lady Downe's and Gros Colman. My estimate of it would place it before Gros Colman and behind Lady Downe's for flavour.

The number of stones in each berry is rather against Alicante when being eaten, and sometimes when it is not thoroughly ripened a tough skin and a mouthful of water and stones are what the consumer is rewarded with.

When in its best condition Alicante is possessed of a certain freshness in the mouth, that in some measure compensates for the tough skin and numerous stones. No variety can equal Alicante for bloom, and when seen in its best form it is really a handsome Grape. It will bear heavy cropping with greater impunity than any other variety, hence it is a great favourite with many market growers, some of whom do not hesitate to take two bunches off most of the shoots, and have the bunches so close together that very little roof space is left uncovered. This extremely heavy cropping tends, however, to weaken even such a sturdy Vine as the Alicante, and frequent renewals are required. Gros Colman has in some measure taken the place of Alicante in many of the market places round London; still large quantities of the Alicante are grown.—A MARKET GROWER.

ONCIDIUMS.

(Continued from page 587, last vol.)

AMONGST the strange modifications of Orchid flowers the similarity which some assume to insects or birds is very remarkable, and in some well-known instances the resemblance is so striking that it has given rise to the specific names. Several examples of this occur amongst the British terrestrial Orchids, particularly in the genus *Ophrys*, in which are species named *O. aranifera*, *O. fuscifera*, *O. muscifera*, *O. tabanifera*, *O. apifera*, and *O. tenthredinifera*, from their resemblance to spiders, drones, flies, dunflies, bees, and sawflies. Instances of this character are, however, not so common in the tropical Orchids as might be expected, considering the extraordinary forms assumed by so many, and which are so obviously adapted to insure cross-fertilisation. Of the tropical imitative species perhaps none is more singular and beautiful than the Butterfly Orchid—*O. Papilio*—which is so distinct from all its relatives, if we except *O. Kramerianum*, apparently merely a variety of the former, that it has been considered by some as constituting a different genus. This plant, moreover, is one of the few that has handsome foliage, and even the pseudo-bulbs are attractive in no ordinary degree, both that and the former being mottled with dark green and brown. The flowers are borne singly at the extremity of a long peduncle, and bear a fantastic resemblance to the general conformation of a butterfly, one of the chief characters that give rise to this simi-

larity being the three sepals, which are long, narrow, and directed upwards, forcibly reminding us of the proboscis and antennæ of the Lepidoptera. The petals are much broader, not so long, the margin undulated, and yellow with orange, brown, or chocolate transverse irregular bars. The lip is rounded, narrowed at the base, and indented at the outer margin, bright yellow in the centre, and broadly margined with reddish or orange-brown.

There are several varieties differing greatly in the size and colouring, and some are comparatively worthless, such, for instance, as was figured in vol. xi. of the "Botanical Register." The best varieties are, however, extremely fine, and the long period the flowers remain in perfection is an additional recommendation of great value. Indeed, the plant is in flower at all times of the year; but the bloom or spike should never be cut, as fresh flowers are produced at the top after the old one has faded, the spike thus continuing on the plant for a great length of time. It is not difficult of cultivation, and may be grown either in a pot or on a block, preferably in a warm house with the other heat-

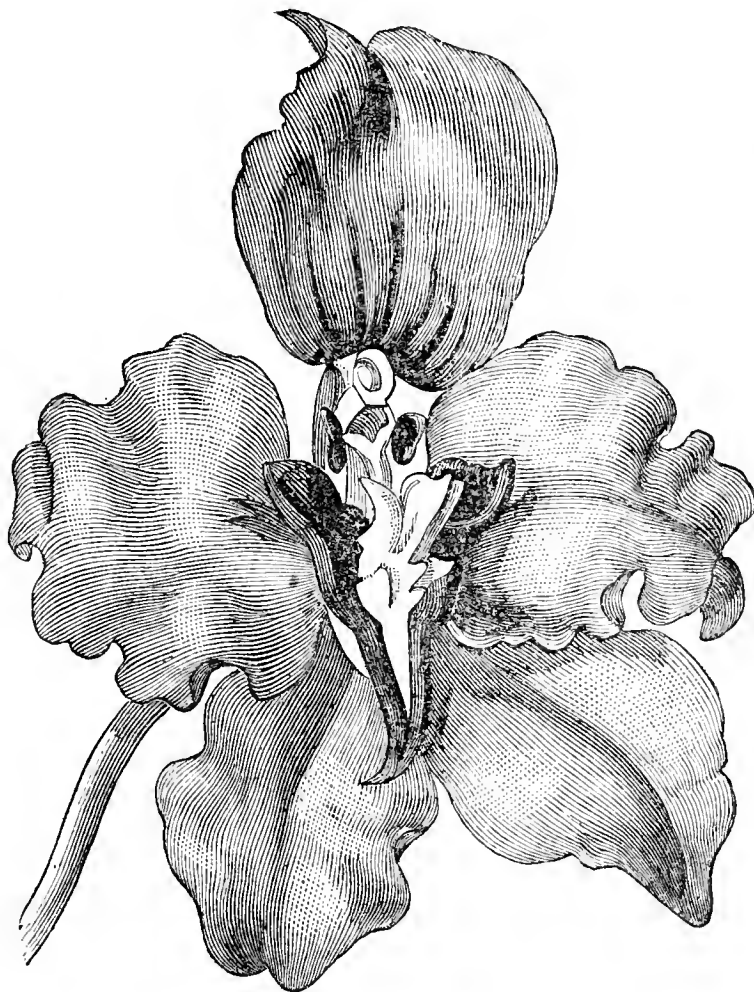

Fig. 6.—*Oncidium macranthum*.

loving Orchids, though it also succeeds well in an intermediate or cool house, and if placed in such a structure when the plant is in flower it lasts even longer than usual in a higher temperature. A compost of peat, sphagnum, and small potsherds or pieces of charcoal suit it when in a pot, and the same compost is the best that can be employed for all *Oncids* under culture in pots. The species was introduced by Sir Ralph Woodford, Governor of Trinidad, in 1825, so that it is quite an old friend now; but its ally, a variety, *O. Kramerianum*, which differs chiefly in the deeper colour of the flowers, is of much later introduction, and has now only been in cultivation about ten years. It is very handsome, and a great favourite with orchidists. Several other species of *Oncidium*s are supposed to resemble insects, animals, or birds in their flowers, such as *O. raniferum*, which has small purple and yellow flowers somewhat like a frog, while the column of *O. pelicanum* has been considered like a "pelican pecking its breast," and by a little stretch of the imagination the similarity may be perceived. Both these are comparatively rare, and by no means so attractive as the showy Butterfly *Oncid*.

O. MACRANTHUM.—The woodcut (fig. 6) represents a flower of average size of this very distinct and beautiful *Oncid*, for the better varieties now well merit the designation "beautiful," as with other Orchids, in this genus the earlier forms are not equal to some of these subsequently obtained by introduction or selection. The species is a native of New Granada and Peru, and it

was first described from specimens collected by the travellers Ruiz and Pavon. It has been found at great elevations on the mountains of South America—namely, at 14,000 feet on Tanageragua by Hartweg, and on the Andes at 7000 feet by Professor Jameson of Quito, and, as might be expected from its habitat, the plant thrives best in a cool house in company with *Odontoglossums* and other *Oncids*. It first flowered in England about 1868, both in Lord Londesborough's and Messrs. Veitch's collections.

The panicle is long, straggling or climbing, and it is usually trained round a few stakes or light trellis, and some attention of that kind is absolutely necessary, as, though the normal type has been described as not exceeding 3 feet in length, varieties are now grown of which the panicles have reached 8 feet. The sepals are roundish, of irregular form; the two lower of an orange hue, and the upper one brownish or bronzed. The petals are of similar shape but pale yellow, while the triangular pointed lip is white in the centre, bordered with deep rich purple. The contrast of tints is very striking. *O. maeranthum* var. *hastiferum* is remarkable for the length of the spike, commonly exceeding 6 feet, and sometimes as much as 9 feet long, bearing thirty or forty flowers. The species and its varieties require culture in pots, similar compost to that already recommended being suitable. The flowers are produced in spring and early summer.

O. MARSHALLIANUM.—A magnificent Orchid, and unquestionably one of the best in the genus, but unlike the preceding in requiring a higher temperature, and must therefore be grown with the other heat-loving *Oncids*. This species has a large broad branched panicle bearing large flowers, of which one is shown in fig. 7. These have the two lateral sepals very small and inconspicuous, the upper being much larger and barred with purple. The petals are still larger with an undulated margin, bright yellow, barred and blotched with purple in the centre. The lip is of great size, contracted at the base into a claw which is spotted with bright red, the other portion being rounded, two-lobed at the apex, and of a brilliant clear yellow hue. This grand Orchid was first flowered by W. Marshall, Esq., of Enfield, in honour of whom it is named.

Some have failed in the cultivation of this Orchid, chiefly for two reasons—first through growing it on blocks, and secondly by having it in too low a temperature, the remedies for which will be evident to all. *O. Marshallianum* has been found to be one of those Orchids which is in danger of flowering itself to death unless very well treated, and it has often caused an inexperienced grower surprise to observe pseudo-bulbs yearly decreasing in size, while the flowers continue to be freely produced. Perhaps the best temperature of all is an intermediate one with liberal supplies of water, and if the plant gives evidence of deteriorating remove the flower spikes until strength has been regained.—L. CASTLE.

(To be continued.)

AIGBURTH BRUSSELS SPROUTS.

IN reply to your correspondent "S. D.," page 568 of the *Journal of Horticulture*, in reference to the above, permit me to say that my experience has been quite the reverse to his. I had not become a constant reader of the *Journal* a year ago, therefore I did not see the article written by Mr. Iggulden as referred to by your correspondent "S. D." I have been acquainted with the Aigburth Sprout ever since it was first sent out by Messrs. Ker and Sons of Liverpool. I have seen it in several well-managed gardens in different parts of the country, and all with whom I am acquainted that grow it speak highly of it. I have grown it here for two seasons, and rather extensively too, as Brussels Sprouts are favourites here, and the principal green vegetable for winter and early spring. I have grown it in rich deep stiff soil, also in rather poor shallow soil, but the crops from the former have been in every way superior to the latter. On shallow soil it scarcely becomes 15 inches high, whereas in deep soil it is nearly 2 feet, and well studded from bottom to top with rather large, very firm, and first-rate flavoured sprouts. It has another advantage over any other variety that I am acquainted with—that is, it keeps longer in good condition. This year I have also grown the Dalketh Improved, but I find the Aigburth so far superior that, contrary to "S. D.," I shall not grow any other while the Aigburth does so well.—W. C., *Leagram*.

HAVING this season grown the above and the old imported variety side by side, I may be allowed to corroborate what your correspondent "S. D.," on page 568, says respecting its merits. Both were sown at the same time, and received precisely the same treatment, the Aigburth from the first outstripping its rival in luxuriance of growth. Its greatest drawback is the short time

the sprouts keep whole, the imported keeping tolerably well up to now, only a few of the sprouts opening here and there, while the sprouts of the Aigburth are nearly all open and useless. The soil in which they are growing is good. Thus the Aigburth not having proved satisfactory it will not be again grown by me.—J. RICHARDSON, *Calverton Hall*.

EASTER BEURRÉ AND BEURRÉ RANCE PEARS.

IN answer to the query in last week's *Journal* concerning these Pears, at Holme Lacy there are trees of the former on walls facing south, east, and west, also trained as espaliers in the open, on Quince and Pear stocks, and the fruit was seldom worth eating, bearing no comparison to other good late kinds. I have often heard that in France Easter Beurré and Duchesse d'Angoulême are the best melting Pears, whilst in England they are too often comparatively worthless for dessert. Sometimes Beurré Rance is found worth eating, but generally it is the other way. In my opinion they are Pears not to be relied on. I may mention that the soil at Holme Lacy is all that can be desired for producing good Pears.—A. YOUNG.

NEITHER Easter Beurré nor Beurré Rance Pears can be depended on to ripen in Nottinghamshire, at least in a garden where the soil is strong and the subsoil clay. For ten years I gathered crops of the former, but the fruit was never more than second-rate in quality, and occasionally decidedly third-rate. Beurré Rance is still more uncertain, as it frequently refuses to ripen at all; is, in fact, no better than a stewing Pear. After trying these varieties over the period stated the trees were cut down and grafted with Josephine de Malines and Bergamotte Esperen. On visiting a garden in the neighbouring county (Lincoln) last year, I found much the same results with the two Pears first named, and the gardener resolved to do what I had done—cut them down. I am told these Pears are uncertain even in the south of England.—A NOTTS GARDENER.

FLORISTS' FLOWERS.

I THINK that I am justified in saying that this is about the most critical season of the year for the florist and the one which most tries his patience. There is nothing to be seen of the beauty of his plants, and indeed they are at their very worst; but none the less does he need to exercise careful supervision over them, for neglect now means loss and disappointment by-and-by. A few hints, then, concerning them for those who are not perfect in their culture, nor among those happy individuals who never have anything the matter with their plants, may not be unacceptable.

Auriculas.—The great danger to guard against in the Auricula frame is damp. Cleanliness, of course, has to be secured; green fly must be carefully guarded against and brushed off whenever it appears, and weeds must be taken away. But drip is a more insidious enemy, especially when, if the weather be severe, it becomes necessary to keep the frames close. If a pot has become soddened by wet, and then the frames have to be kept close, the great probability is that the plant will be lost. Therefore it is well to examine the frames from time to time, and, if any drip should show itself, to remove the plant from under it (as there will be little chance of remedying the fault just now) into some drier spot. This very wet season has made this a point very necessary to be continually attended to. One great evil of autumn blooming is, that if the flowering stem has come from the heart of the plant in a damp season like this it is almost impossible to prevent injury. The stem gradually decays down to the heart of the plant, taking mildew with it, and too frequently permanent loss, and it too often happens that it is some of our best varieties that take this freak of autumn blooming. Very little requires to be done in the way of watering; indeed it is astonishing for how long the Auricula will last without it. Where there is any sign of flagging of course it must be done at all risks, but otherwise they will require none.

As next month will be the time for top-dressing it will be well to be provided with the necessary compost in time, keeping it dry and ready for use. There are various ways of top-dressing, some using a larger quantity of manure than others. I believe, however, that it is better to have the compost not quite so rich as some advise, but, as in ordinary potting, using a large quantity of good loam, into which the roots proceeding from the upper part of the plant will soon push themselves, and the more fibrous it is the better they seem to enjoy it. Beginners must not be disappointed at the meagre appearance of their plants now all the fine luxuriant leaves of the last season have died off; but if a little stout stubby heart is left there is no need to be discouraged, for it is

astonishing how rapidly when the proper time comes the plant is developed.

Carnations and Picotees.—Here again the great enemy is damp. They do not mind cold provided the earth in the pots is kept sufficiently dry; but where this is not the case then spot commences, and this very soon spreads in a collection. It will be therefore necessary if it occurs to cut off with a pair of scissors the leaf or part of the leaf so affected, and to remove all decaying leaves. I have seen but little of it in my frames this year, although in some seasons I have been troubled with it. Where the plants have been potted in good loam with a little road grit added they are, I fancy, less liable to it than when closer compost has been used. Keep green fly away, remove weeds from the pots, and when necessary stir the surface with a blunt stick.

Pansies.—Where these are grown in pots it will soon be necessary to think of repotting them. In the meantime the same directions will apply to them as to the foregoing, only that as they are more succulent they will require a little more attention in the way of watering, which, however, should be very carefully done.

Pinks.—The great danger to these in beds is that, owing to the action either of frost or worms, they may be drawn out of the ground. If, however, when they were planted a small piece of stick has been used to secure each plant there will be less danger

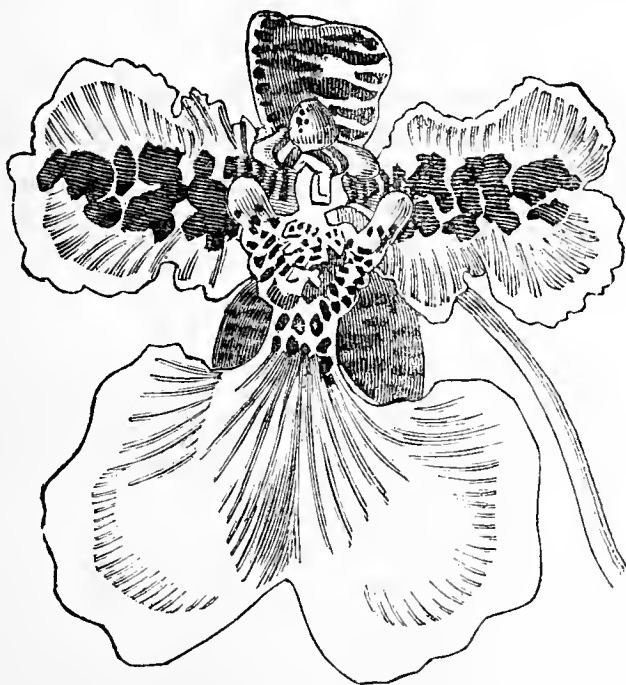

Fig. 7.—*Oncidium Marshallianum*. (See page 24.)

of this. By-the-by, what a comment on the neglect of florists' flowers in and about the metropolis is the fact, that while money in abundance was forthcoming to establish a Pink show, the thing failed because there could not be brought together a sufficient number of exhibitors to make a show. Imagine anywhere in the north or in Scotland such a state of things as this.

Tulips.—For those who grow the florists' varieties (which I do not) this must have been a very trying season for planting. I have had a great difficulty in seizing an opportunity for planting my bed of early Tulips, and as this can be done in a much easier manner than the late-flowering ones I imagine there must have been considerable difficulty.

Ranunculus of course are safe and snug in their drawers or boxes, and will only require looking at now and then to see that there is no mildew.

Finally, whenever the weather is favourable give all the air possible to the frames. Coddling is one of the great enemies of florists' flowers. They are mostly hardy plants, and being treated thus as half-hardy ones it becomes only necessary to see that they are supplied with that which they would have in abundance were they treated as hardy—plenty of fresh air.—D., Deal.

CARTERS' LITTLE PIXIE CABBAGE.—At this time of the year, when neither Cauliflower nor Broccoli are generally to be had, a sweet, melting, delicious small head of excellent Cabbage takes precedence for most purposes of any other vegetable in general utility. I say "small" head, because no matter how grown, a large variety will be now stringy, fibrous, and with a disagreeable amount of midrib. Now, this dwarfish Cabbage can be used whole, and can hardly be said to have any waste. After 14° of frost at the commencement of last

month, it now fully merits the description of hardy, juicy, and melting. Where there is a large household it should not be grown alone, but in conjunction with larger kinds, with the view of having it for special members of the family. I have commended it to several, and their testimony to this effect is unanimous.—W. J. M., Clonmel.

MRS. PINCE GRAPE.

I WAS very pleased to observe Mr. Roberts saying a good word at page 594 of your last volume for Mrs. Pince. When properly grown this is a really good late-keeping black Muscat; as grown at Worksop Manor it has the "musque" flavour well developed early in the season.

I beg to add my testimony to the excellency of the Grapes at Woodseat in general, and of Mrs. Pince in particular. Unless my memory deceives me, the bunches grown by Mr. Hollingworth last season would average quite half a pound more than those borne by the famous Mrs. Pince at Garston Vineyard in 1868. Having been an occasional visitor to Woodseat since 1865, I believe I can safely say that the crop of Grapes in 1882 was never before surpassed, not even by the famous prize bunches grown by Mr. Rabone, good as they were. Mr. Hollingworth is one of those gardeners who appear to have no difficulty in growing excellent fruit.—J. U. S.

SELECT VEGETABLES.

(Continued from page 590, last vol.)

Brussels Sprouts.—The newest among these is Suttons' Reading Exhibition and the Aigburth, and they are both good for exhibition, but they require to be well selected before they will become trustworthy varieties for everyday use. Among the best Brussels Sprouts I have grown or seen is the one known under the name of Webbs' Matchless. It grows most compact, and buttons evenly from bottom to top. Scrymger's Giant is only third-rate. The Dalkeith when true is better.

Cabbages.—These are grown in every garden, and we have many varieties to select from, but our stock is well reduced, and only the very best is grown. Ellam's Early Dwarf Spring is a new variety but rather small. Wheeler's Imperial is larger and better. Cocoa-nut is too small. Nonpareil is good. Early York will never be grown here again. Redbraes is the best of all the mid-season varieties. Webbs' Imperial is another which should be grown everywhere. Drumheads should only be grown for feeding cattle. The Colewort is most useful in winter. Red Dutch is the best for pickling. Chou de Burghley was at first known to us as the Cabbage Broccoli, but under any name it is a splendid winter vegetable which will no doubt find a place in every garden.

Cucumbers.—Of these there are some new or improved sorts being introduced almost every year, but all do not excel the old kinds. The true Telegraph is still a Cucumber of the highest merit, and although we may grow other kinds on trial and otherwise, we will never be without a few plants of Telegraph. In newer kinds we have a highly promising sort in Pettigrew's Cardiff Castle, and Carters' Model is very useful. The latter appears to be a well-selected variety of Telegraph, and as such we value it much; and of the Cardiff variety it is impossible to speak too highly. It has an excellent constitution, is most prolific and of fine flavour. It is an all-the-year-round bearer, as it fruits almost as freely in winter as summer. The fruits are from 12 to 15 inches long and are produced in clusters at every joint. I would never desire a better table Cucumber than this, and it should be grown by all. Many Cucumbers have only their great length and size to recommend them, and some growers appear to value this quality above all. I have proved repeatedly that the largest-fruited kinds are not the most profitable, and would neither recommend them for the table nor encourage them at shows. From time to time I have secured many prizes for Cucumbers, yet I never competed with a fruit more than 15 inches in length.

Cauliflowers.—This is one of the most popular of vegetables, and no doubt that is the chief cause of there being so many new, distinct, and superior varieties offered every year, but a very few of the best will give more satisfaction and as heavy and long a supply as innumerable sorts. Veitch's Extra Early Dwarf Forcing is sure to become a great favourite, as it is the earliest of all, very true to name, dwarf and compact in growth, and produces small white heads of the choicest quality. If sown in spring it will head equally as early as those sown in autumn, and in this way all the trouble of keeping plants over the winter for the spring supplies is avoided. Early London is a good successional one to this. Dwarf Mammoth is a splendid summer variety. It is dwarf in growth and bears very large heads. I have cut more fine heads from a thousand plants of this variety than from any other.

It is very true to the original character. As an autumn Cauliflower Veitch's Autumn Giant is now favourably known. For a supply from September to Christmas it has no equal, and after that the Broccolis referred to in my last notes come in.

Carrots.—Those who object to new kinds of vegetables appearing too rapidly must be pleased that the Carrot has been so long left alone, as no new varieties have been introduced for a number of years. The earliest of all Carrots is the small French Forcing, which is an excellent early one for a frame. Nantes Horn is the best to follow this, and in shallow soils it should be grown as a main-crop variety. James's Intermediate Scarlet is another first-class variety, and no other need be grown for autumn and winter use. Red Surrey is the best of all the long varieties; but long Carrots are no favourites of mine, as they are the least profitable as a crop and the most inferior and coarsest in the kitchen.

Celery.—Varieties of Celery differ widely, and it is on variety as much as culture that good produce depends. The red varieties are the hardiest and soundest-growing, the white ones being most tender and not to be recommended for the winter. In fact I am about to discontinue growing white Celeries on this account. My selection of the red varieties is as follows—Defiance, Major Clarke's, and Williams' Matchless. The first-named is perhaps the best. Of whites Sandringham and Turner's Incomparable are to be preferred.

Celeriac, or Turnip-rooted Celery, is dwarf-growing, most useful for soups or stewing.

The large Spanish variety of Cardoon is the best for all purposes.

Capsicums.—These are not always classed amongst vegetables, but in some parts of England they are regarded as such, particularly about Cheltenham, where no show collections of vegetables are considered complete without them. The Long Red is the largest fruiting variety and the most useful. Prince of Wales and Princess of Wales have much smaller pods and are very ornamental.

Chicory.—One of the most useful of plants for winter salads. The largest-rooted Brussels is generally known as Witloef, and is the best to grow.

Endive.—This is another most valuable winter salad plant which everyone should grow. We have tried a dozen or more varieties, but only grow two as main crops; one is the Moss Curled variety, but the other is newer, and is the Improved Broad-leaved Batavian. This in my opinion is the finest winter salad we possess. Last year I had several new sorts of Endive from Messrs. Carter which deserve careful trial.

Fennel.—The ordinary kind of this is seldom used as a vegetable, but there is a newer sort named the Sicilian Sweet, which will be much used in this way when better known. It forms thick stems not unlike Celery, and is used in much the same way.

Leeks.—These are most useful at this season, and a good patch of them is never out of place in my garden. The New Carentan is disappointing. It is no longer than some others and not so hardy. The Musselburgh is the best of all Leeks. Ayton Castle Giant is another good one. The Lyon lately introduced must be tried further before it can be placed amongst the standard sorts, but it promises well.—A KITCHEN GARDENER.

(To be continued.)

THE COOL SYSTEM OF GRAPE CULTURE.

YOUR correspondent, "Vitis Secundus," is evidently anxious to prove that I am on the side of the cool-treatment advocates. No one would be more willing to grow Grapes on the cool treatment than myself, but I have hitherto failed to do so satisfactorily. Others may have succeeded in producing as finely finished Grapes with the cool treatment as with a warmer one. When anyone says he has done so I am ready to believe the statement. There is nothing to be gained by quibbling and casting doubt on others' veracity. Fair discussion and assertion of opinion and experience are productive of good, but away with all petty endeavours to pick holes in another's statement simply for the sake of being considered smart.

When I said, Start the Vines in the "middle of February" to be in "good condition for the table" by the middle of September, I meant by "good condition" not merely being eatable, but in perfect condition. All who have experience of Grape culture should know that there is a time when each variety of Grape is in its best condition for use. I say, then, that the Duke for instance, if started the middle of February, is "eatable" by the beginning of August, but "perfect" by the middle of September. This I have proved repeatedly.

The Duke is earlier than the Black Hamburgh. I have had

the Duke eatable a fortnight earlier than the Black Hamburgh, both grown in the same house, this when they were being grown for early work.

Will anyone assert that the Black Hamburgh is in perfect condition as regards flavour when used as an early Grape and cut immediately it is black? In my experience it is the last used early Hamburghs that may have hung a month longer than those first cut that alone have rich flavour. It is the rage for having early Grapes, flavour or no flavour, that causes so many Grapes to be cut when they are far from being in really good condition for the table. In inside borders the Duke and Madresfield Court will improve greatly in flavour and richness by being allowed to hang at least a month after the time they may be considered eatable.

I gave advice to "J. E. R. I." thinking that he wanted Grapes in perfect condition, and I have seen no reason for altering my opinion. The Duke can be had in an eatable condition in five months, in a better condition in six, but perfect in seven. "Vitis Secundus" has shown some ingenuity in trying to prove me a follower of the cool system, but I can assure him he is wrong.

For some important reasons I would gladly practise the cool treatment and give honour to those who had led me to try it if I could succeed with it, but this I have not been able to do, therefore intend to abide by a mode of treatment that has proved successful. I am not prejudiced against the cool treatment, I simply speak from experience.—VITIS.

VIOLET ODORATA PENDULA OF NEW YORK.

I DO not send blooms of these as being anything very remarkable in the way of specimens, but simply because they have been gathered from plants growing in the open garden January 2nd. The Violets are odorata pendula of New York chiefly; there are also a few of De Parme. We picked this morning all from plants of New York, growing out of doors without protection, sufficient to make thirty large bunches, and the plants are still covered with buds and blooms. They have continued in constant bloom since the end of August, and although we had one week of very sharp frost, they seem to be going on again as gaily as ever. I grow twenty-six varieties of Violets, but I have none which equals New York for general utility. The bunch of Primroses and Polyanthus is also rather a phenomenon at this season, ours seem to have been in bloom all the autumn and winter so far.—R. W. BEACHEY, *Kingskerswell, Devon.*

[The blooms of odorata pendula are large, full, double, rich in colour, and very fragrant, those of De Parme being rather smaller and paler. Both are good, the former very fine. The Primroses and foliage are fresh and bright, as we usually see them in April. We thank our correspondent for this appropriate new year's gift. The New York Violet evidently merits the prominence that is accorded it.]

MY SUBURBAN GARDEN.

(A COLUMN FOR AMATEURS.)

THE garden which I am proud to call my own would be lightly regarded by those professionals who are happy, or otherwise, in the charges of long ranges of glass and acres of pleasure grounds; but what would be small to them is great to me, and the pleasure I derive from my little enclosure cannot be estimated by its size.

I rejoice in a few small houses for plants and Vines; very small some of them are and plain, yet they are neat and answer their purpose. They are supplemented by a small range of frame-like brick pits and a few moveable frames or boxes, as all houses should be. My garden contains a small lawn with flower beds, shrubbery borders, herbaceous beds, and two rockeries, one in the sun for alpine plants, the other in the shade for Ferns. A square is devoted to vegetables, with a few pyramid fruit trees next the central paths and arched over it, and on the boundary fences I have next the houses Roses and other flowers, and further distant cordon Pears, Currants, and Gooseberries. This variety is afforded in a small space, for the entire "property"—lawn and paths, shrubbery, vegetable ground, structures, and residence—occupy less than an acre of ground.

My labour consists in my own spare hours in a professional life and the aid of my factotum George, who has "risen in the world" from bootboy to groom and gardener, and I think he is proud of his position. He is a handy man, has grown up with the place, and will do certain things that perhaps a "real" gardener might think *infra dig.*; but this is an advantage rather than otherwise, and he possesses the virtue of obedience. Occasionally,

it is true, he has mildly remonstrated against a prescribed course ; but has never gone beyond this—"Course I'll do it sir, but if it doesn't answer don't blame me." In that there is nothing improper, but, on the contrary, the course is prudent ; and, besides, the remark indicates that the man thinks as well as works, as every man must do if he wishes to excel in his calling. I also employ a labourer for a week occasionally to do plain straightforward heavy work, such as digging and setting things square for routine operations.

Now, if there is nothing very great accomplished at Beechwood Villa, nor few startling effects produced, there is generally something to look at and something to eat. For instance, Grapes, Apples and Pears, Tomatoes, Rhubarb, and Mushrooms of our "own growing," with flowers in abundance were in season at Christmas, so were Kidney Beans, but those had been salted down. Scheming and economising are practised to maintain the rounds—to "always have something ;" and although there are periods of scarcity and mishaps occasionally, a total blank has seldom to be deplored.

A rather good judge of gardening, in fact a rather great man, was a Christmas guest at the Villa this year, and he was good enough to express his approval of the garden and its products, and to suggest that it would be useful to other suburbanists, and even to him, to know how it is managed, and that I ought to write to the papers. "Write to the papers," I repeated, I fear rather contemptuously ; "no editor would print what I could say about such a bandbox of a place." "Wouldn't he, though ; try him," was the reply. The notion that at first seemed almost ludicrous, on reflection did not appear unreasonable, for, others having benefited me, why should not I attempt, at least, to benefit others? Then, on still further reflection the fact grew clearer and clearer, that after all there are ten times more small than large gardens, and ten times more amateurs needing instruction than can possibly be gardeners, for these are already skilled. I therefore make the venture, and submit what is my test paper. If it is rejected no one will be the worse, and if accepted I will, as time permits and the Editor wills, tell in my own way how I manage my own garden, in the hope that a hint may be scattered here and there that may be of service to little men. The great gardeners will, therefore, please skip this column, or if they read it remember that the writer has no claims to equal knowledge with themselves, but simply desires to aid others who, like himself, may be seeking to derive pleasure, recreation, and health in the better management of their suburban gardens.—M. D.

PETTIGREW'S CARDIFF CASTLE CUCUMBER.

THERE are few of the many novelties that are added to our seed catalogues yearly which deserve more praise than this Cucumber. For shape, size, and flavour it is all that can be desired, and for its bearing I do not think there are any Cucumbers to equal it. Along with other old standard varieties we had three plants of Cardiff Castle, all planted early last spring ; and although the other varieties were completely worn out by autumn Cardiff Castle has continued bearing, and at present (3rd January) we have good Cucumbers still on the plants. The only extra treatment they received was after the other plants had been removed, when they were trained equally over the roof, and the bed received a top-dressing of manure. This is a seasonable time for the readers of the Journal to give their opinions on the former years' novelties, and I think when such is recommended to the public and proves such a success it reflects great credit to the raiser, and also to the firm that sends such novelties out.—D. M. C.



THE IMPERIAL HORTICULTURAL SOCIETY OF RUSSIA will hold an International Exhibition and Congress at St. Petersburg on the 5th of May, and it will continue open for twelve days. Invitations have already been issued to the leading European horticulturists and botanists, and a highly satisfactory show is confidently expected. Unfortunately, however, the dates of this and of the Ghent International (April 25th) will clash to some extent.

— THE ninth Exhibition of the PELARGONIUM SOCIETY will be held on Tuesday, June 26th, in the Royal Horticultural Society's Gardens, South Kensington, when the usual prizes will be offered for Show, Fancy, Zonal, and Ivy-leaved varieties. Certificates will be awarded for the most distinct and meritorious new varieties, and the Council of the Royal Horticultural Society offer a silver Banksian medal as a prize for the best specimen Pelargonium in the Exhibition. The report which accompanies the schedule states that at the last Show there was competition in all classes except those for hybrids of *Geranium pratense* and *Pelargonium oblongatum*. As, however, it is believed there are hybrids of these species in cultivation, the classes have been retained in the present year's schedule because they "might result in bringing before the public novelties possessed of peculiar interest."

— WE may remind our readers that the objects which the Pelargonium Society has set itself to accomplish are :—1, To promote the improvement of the various groups or sections of the genus *Pelargonium* ; 2, To facilitate the introduction of new species, and the raising of new varieties and hybrids ; 3, To give system and method generally to the practice of hybridisation in this family. These several objects it proposes to accomplish :—1, By facilitating intercourse and interchange of opinion and experience between raisers and cultivators of these flowers ; 2, By fostering a spirit of emulation in the production of new varieties and in meritorious cultivation ; 3, By offering prizes—as liberal and numerous as the funds subscribed may permit—for competition amongst its members ; 4, By determining the merits and distinctive qualities of new varieties, so far as they come within its cognizance ; 5, By cultivating for criticism all obtainable novelties, British and foreign, side by side, the first year under glass, and the second year out of doors—facilities for accomplishing this have been generously afforded by the Royal Horticultural Society at Chiswick ; 6, By awarding certificates of merit to varieties considered worthy of that distinction, and publishing an annual list of awards.

— ONE of the most attractive features in the Royal Horticultural Society's Gardens at Chiswick at the present time is a fine batch of *Echeveria retusa*, which is extremely useful as a winter-flowering plant. Easily increased and cultivated this plant has rapidly advanced in public favour, and it has now taken a place amongst the best of market plants in winter. The flowers are bell-shaped, much larger than *E. secunda* ; orange red, very bright and rich outside, the inner surface being yellow. They are borne in a two-branched inflorescence at the extremity of the stem, the two branches curling slightly downwards. Plants in 48-size pots are most useful and produce several flowering stems, the blooms lasting for a considerable time in good condition. A rich light loam and well-drained pots are needed to insure success, and plants are best prepared by growing them out of doors during the summer, lifting and potting them in the autumn, when they can be transferred to the conservatory or greenhouse. The species was found by Mr. Hartweg growing on rocks near Auganguco, Mexico, and was first received from him by the Royal Horticultural Society in 1846. An excellent engraving of the plant was given in this Journal, page 188, vol. xxxiv., March 7th, 1878.

— AS a proof of THE MILD WINTER, it may be mentioned that Primroses were being sold in penny bunches in the southern suburbs of London last week. The hawkers stated that they were chiefly gathered in the copses among the Surrey hills around Sanderstead, Warlingham, and Barrow Green.

— MR. S. MORTIMER, The Gardens, Purley Park, Reading, writes :—"I send you a pseudo-bulb of *Cœlogyne cristata* with flower spike attached. It is from a plant in a 9-inch pot, and is

now carrying forty-one spikes of bloom, being quite three weeks earlier in flowering. As soon as the plant began to make its growth about the middle of April I gave it a shift into a pan about 16 inches in diameter by 6 inches deep, and it has succeeded splendidly under the treatment advised in this Journal, being now a plant 3 feet in diameter." The flowers and pseudo-bulb received indicate excellent health, and the plant must be very handsome.

— PROMINENT amongst the few plants in flower out of doors in January may be noticed *TUSSILAGO FRAGRANS*, which, however, is less noteworthy for its beauty than for the Heliotrope-like fragrance of the flowers. A clump or two in a rockery now is most welcome, and if potted a few plants are valuable for the conservatory. The flowers individually are small and white, in dense heads about half an inch or more in diameter, and these are borne in clusters at the upper part of the stem. The style protrudes much beyond the flower, the tip being white with a ring of dark reddish anthers, the contrast being very notable.

— THE usual monthly meeting of the HORTICULTURAL CLUB took place on Tuesday at the Club-room, 13, Henrietta Street, Covent Garden, and was well attended. Several subjects of interest were brought forward. Dr. Masters very kindly exhibited the beautiful series of photographs of Orchids, &c., taken by Mr. Stevens. A curious form of *Echeveria secunda glauca*, fasciated and almost like a green Cockscomb, originated by Mr. Brown, gardener to A. J. Waterlow, Esq., Reigate, was shown by the Secretary. There were also shown a very minute form of *Polypodium vulgare* called *parvissimum*; some dried fronds of Ferns, the most beautiful being a very delicate form of *Athyrium F.-f. plumosum*; and some remarkable specimen of fungoid growth. It was arranged that during the summer months meetings should be held at some place of horticultural interest in the neighbourhood of London.

— MESSRS. J. CARTER & CO., High Holborn, inform us that they intend offering the following SPECIAL PRIZES AT THE ROYAL HORTICULTURAL SOCIETY'S SHOWS:—For the best brace of fruits of Carters' Blenheim Orange Melon and Carters' Emerald Melon; first prize £2 2s., second £1 10s., third 15s., fourth 10s. 6d., fifth 7s. 6d. July 3rd, for the best four dishes of Peas (fifty pods each) of Stratagem, Telephone, Pride of the Market, and Culverwell's Telegraph; first prize £5, second £3, third £2, fourth £1, fifth 10s. 6d. July 24th, for the best six dishes of Tomatoes, twelve fruits to form a dish, to include Dedham Favourite, Green Gage, Vick's Criterion; first prize 63s., second 42s., third 21s., fourth 10s. 6d. December 11th, for the best twelve dishes of vegetables, to comprise twelve Onions, Golden Queen, Silver Ball, and Golden Globe; three Cauliflowers, six Carrots, three Celery, six Parsnips, fifty Brussels Sprouts, three red Beet, twelve Parsnips, twelve Potatoes, six Leeks; first prize £5, second £3, third £1 10s., fourth £1, fifth 10s., sixth 7s. 6d.

— THE members of the Tooting Horticultural Society, at their monthly meeting held on the 4th inst., presented their Secretary, MR. W. H. GOWER, with a testimonial consisting of a handsome oak writing desk and inkstand combined, as a mark of their esteem, and in appreciation of his services rendered to the Society since its formation.

— RELATIVE to MUSHROOM CULTURE OUT OF DOORS "Agaricus" writes—"I adopted the mode of preparing the manure and making the beds so fully and lucidly described by Mr. Wright in the Journal, and am well pleased with the result. I have three times the quantity of beds from the same amount of manure, and the crop is equally as good as under the old system. Now being a good time to form outdoor beds, the appearance of the promised work on Mushroom culture would be a boon to many. The little brochure will prove a standard work. When shall we have it?" Soon.

— AT a general meeting of the ROYAL HORTICULTURAL SOCIETY last Tuesday, Mr. David Wooster in the chair, the following candidates were unanimously elected Fellows, viz:—G. Mander Allender, John Avery, R. Barbey, J. Hall, T. Hankin, Thomas Scruton, and Walter Williams.

— GARDENING APPOINTMENTS.—Mr. T. W. Sanders, recently foreman at Buxted Park, Uckfield, has been appointed head gardener to J. W. Larking, Esq., The Firs, Lee; and Mr. A. Taylor succeeds Mr. H. Walker as gardener to Mrs. Jas. Taylor, Ashdown, Apperley Bridge, Leeds.

— THE annual general meeting of the METEOROLOGICAL SOCIETY will be held at 25, Great George Street, Westminster, on Wednesday, the 17th inst., at 7 P.M., when the report of the Council will be read, the election of Officers and Council for the ensuing year will take place, and the President will deliver his address.

MARÉCHAL NIEL ROSE.

THE universal failure of Maréchal Niel in the open air during the last few years has caused no little tribulation among Rose exhibitors, and I was therefore glad to see that a correspondent called attention to the fact in your paper on page 565, last volume. For my part I have little doubt as to what is the cause of the evil.

Nearly every plant sent out to buyers is raised in heat. A large number of Maréchals are grafted in the winter, and being kept in warm houses the plants grow with astonishing vigour. In the summer they are sent out, to all outward appearance, fine healthy plants. If they are planted in the open air they forthwith dwindle and fail. If they do not die in their first winter they only drag on a sickly existence afterwards. Maréchal Niel is a tender Rose no doubt, but not nearly so tender as is generally supposed; but if it were as hardy as *Senateur Vaisse* it would fail out of doors if it had been raised in heat. Under this forcing system an extraordinary growth is made in six months, but all the stamina is cooked out of the plant.

Unfortunately it is by no means an easy matter to raise the Maréchal in the open, either by budding or by cuttings, while under glass it is the easiest thing possible; consequently it pays to produce these grand-looking plants in heat, but it does not pay to produce much smaller but much hardier plants in the open. Under these circumstances it is almost useless to hope that the present system of raising the Maréchal will be altered. The stock will of course be raised in the easiest and most paying manner.

The only thing that amateurs can do then, if they want to have the Maréchal blooming out of doors in June, is to raise plants themselves in the open. From experience I believe that the best plants are obtained from cuttings, and that a well-grown Maréchal on its own roots is not to be surpassed; but it takes two or three years to get a plant raised from a cutting to grow and bloom in perfection. If a man has the patience to raise his Maréchals in the open air in this fashion he will have his reward. A Maréchal in a small pot, a plant six months old with a shoot 8 feet long, is a snare and delusion.—GAMMA PHI.

CUCUMBER DISEASE.

I HAD some experience with this much-dreaded pest a few years ago in a garden where Cucumbers were in great demand. It was then August, and every probable remedy had been tried that could be thought of—viz., new soils and fresh seed obtained from a source where there was no Cucumber disease; but the results were that as soon as the first fruits were seen the disease appeared. Cucumbers were, however, wanted winter and summer, so after trying all remedies by day we determined to begin by night. Fumigating with tobacco paper three nights in succession was tried, the atmosphere being kept drier and the temperature higher. After three or four nights fumigating was again tried. This treatment was carried on for about three weeks. The plants were then carefully examined, and all spotted leaves and gummed fruits removed, a top-dressing of fresh soil being applied. The result was that the plants started growing freely, and produced a very fair crop of fruit for Christmas and on till February, quite free from spot or gum. After that I always kept a sharp lookout for the first spot, and if any was seen the fumigator was placed in the house two hours after dark. The two following seasons Cucumbers were cut by hundreds without a spot. I feel sure if your correspondent, Mr. A. Harding, will try the above

cure next season he will not suffer from this troublesome pest. I may add that I have not seen any trace of it for over three years.—THOS. WEAVER.

NOTES ON CHRYSANTHEMUMS.

I NOTICE that Mr. Moorman says the blooms are grown larger and of greater substance and solidity than formerly—that is to say, the growers of to-day grow better blooms than those of some years ago. I am not prepared to dispute this, it may be so; but we ought to take into consideration the fact that we have now better material to work with. Every year adds some new sport or variety to the incurved sorts, and what would our exhibitions be without the Japanese, which were not in the country a quarter of a century ago? It is nearly twenty-five years ago since Golden Queen of England was sent out, and I well remember being at the exhibition when prizes were offered for it for the first time, and those blooms with others exhibited with it are still vividly impressed on my mind. I am not sure if I have seen better since of the same varieties; but many varieties introduced since that time are far superior in quality. Mrs. Rundle had not been raised, nor Empress of India, and Princess of Teck is a more recent introduction still. Mr. Burbidge alludes to the old Crimson Velvet. This is by no means an old variety. I bought it from Mr. Salter the first year it was sent out; perhaps it was twelve or fifteen years ago. It is quite distinct from King of Crimson, which is evidently an older variety. I may be wrong, but I believe Triomphe du Nord and Julie Lagravère were both in cultivation before Mr. Fortune sent the Japanese varieties over to Mr. John Standish; and King of Crimson is not a Japanese, nor has it been certificated as one. The best of the reflexed blooms is Mr. Sharpe, a purplish crimson sort that Mr. Forsyth, late of Stoke Newington, used to exhibit well as a specimen. The specimen plants we have seen exhibited in recent years are not, I think, superior to what we have seen some years ago. The large specimen from Mr. Bryant's garden, of which a very good illustration was given in the Journal, was certainly a very wonderful production as regards size; but I fancy if that and the others exhibited at Kingston had been put into competition with the six that gained the first prize at that Show the large specimens must have been in the second place only. I think it right to say this in justice to the grower of the six premier plants at the Show.—J. DOUGLAS.

[We did not engrave the plant in question as the best in the Show, but because it was the only good specimen of which a photograph was placed at our disposal.]

FRUIT-GROWING ON CHALK SOILS.

IN these days of economy it may be doubted if many will be induced to follow the proposal of "Et Cætera" (page 525, last volume) in making borders for fruit trees of imported loam and with concreted bottoms, and neither is it at all necessary. Thin soils on chalk are no worse for fruit-growing than are thin soils on many other bad subsoils. A rusty, impenetrable, iron-bound, or a cold cankered clay is as bad, and, in some respects, even worse than chalk, yet good fruit is produced on both without the great expense advised. Fifty or a hundred years ago, before the advantages of root-lifting and pruning were understood, and when large trees, such as were considered indispensable a few years ago, it was the custom, and a necessary one too, to clear out subsoils, concrete the bottoms, and fill up with costly imported loam. In these days agriculture was at its best, now it is at its worst. Then labour was very cheap, now it is dear. Then gardeners looked upon such preparations as absolutely necessary, now we can grow healthy trees even on bad soils without such preparation.

The writer of this has had no experience of chalk, but some on thin soils, in one instance with a very cold unhealthy clay subsoil that was poison to the trees when the roots entered it, and also on a very rusty subsoil that was even worse, and yet managed to grow trees in the best health.

Your correspondent proposes an expensive method of—What? It is well to clearly understand what. Well, it is neither more nor less than keeping the tree roots out of the subsoil, and making sure of their being always among the upper soil. That is all that is necessary; but if the trees are periodically lifted, and any down-going roots laid near the surface, and a few inches of firm soil placed underneath, concreting will not be necessary. Indeed, concreting, plausible as it looks on paper, tends to produce an unhealthy soil in which no trees will long thrive unless very skilfully managed. More than one concreted border has been broken up because of the impossibility of keeping soil that is isolated from the subsoil in sweet condition.

The concreting might be overcome, but where is the necessary loam to come from? Is the garden to be deepened by rendering barren a portion of the park or farm? Those who live in the centre of a chalk, clay, or sand district have either to bear the expense of carting loam miles or removing the surface of what is near, and so spoiling the land thus robbed, and not one owner in a hundred will listen to either proposal. The writer remembers a case when the loam was brought by the canal ten miles for a Vine border, and although nothing was paid for the loam, its carriage cost more than the vinery after everybody was paid! But how many could find loam even ten miles away, or indeed at all? In the cases mentioned the estate on the clay and the other on the loam both belonged to the same owner, otherwise neither love nor money would have procured it.

But, except in extreme cases, it is not necessary. By root-pruning and lifting the roots of trees can easily be kept among the surface soil. Under such circumstances trees of large size need not be looked for, but in the case of wall trees the returns need not be less. Nay, it ought to be more, for trees so started are always more fruitful than trees the roots of which live in a colder climate than those which are kept at the surface. And beyond that the finest fruit almost invariably comes from the lifted trees, simply because the roots being near the surface gather a sap that is warmer than deep-rooted trees can. Moreover, such can be fed better and better protected from drought by mulching, because one may be perfectly certain where the roots are.

The subject deserves some consideration, but as we look at it all the advantages offered by such costly means as your correspondent proposes may be secured in most cases much more cheaply.—J. H. H.

NEW PICOTEES.

PICOTEES of late years have not yielded many novelties, which must be owing to the older varieties being so fine that it is nearly impossible to surpass them. In red-edged Picotees I like Winifred Esther (Dodwell), a medium red edge, in style of Wm. Summers, which it very much resembles, but excels. Another variety, Elsie Grace, by the same raiser, has a fine petal—a light-edged red. No doubt it is a seedling from Mary. It wants shading, or else, like that variety, it flushes in the white.

In purple Picotees I have seen three. Clara Penson (Willmer) is a light-edged purple in the style of Her Majesty, but certainly not so good as that variety, all the flowers of it grown both by Mr. Bower and myself being curled in the petal. This sort may do well enough in the south, but in my opinion it will never make a northern flower. Mrs. A. Chancellor (Turner), a very heavy purple, is a finely marked flower with plenty of petals. Another fine flower is Master Nichol (Schofield), a light-edged flower of the largest size, pure in the white, and a perfect wire edge. It is the best light-edged purple that I have seen with the broad petals of Mary, but more of them.

In heavy-edged roses Lady Holmesdale (Schofield) is a splendid flower, and deservedly won premier at Wakefield Carnation and Picotee Show. It is a large flower, smooth on the edge, and free from spots or bars. I may say that there is no great stock of plants of the two latter varieties, as they were only partially distributed in 1881.—G. RUDD, *Undercliffe, Bradford*.

THE PARSNIP.

THIS year I had this crop in the vegetable garden proper—the Jersey and hollow-crowned varieties; in my experimental vegetable garden principally the Maltese, and in our attached farm a considerable piece of The Student Parsnip. As I think this vegetable is not as much grown as its merits deserve I propose to give a few notes on its culture for culinary purposes generally, on the varieties, and the diseases to which I noticed them liable.

One of my oldest recollections is a discussion of the relative merits of the Parsnip as a substitute for the Potato in Ireland as a general article of diet. Like the Artichoke for such a purpose, its merits were then over-estimated by its advocates and depreciated by others. But its culture in both countries—and I have personally noted the fact—is much less than it should be. It is not so palatable as the Potato as an article of general diet during the winter and spring months, when it should be more generally used. But one of the reasons is that its cooking is very imperfectly understood. I should mention, too, that it is a mistake to remove this vegetable from the soil until required; it becomes more tender with age. But then its tendency to certain diseases, to be immediately referred to, must be kept at the same time in mind. During the past month we had here 10° of frost (22° Fahr.), and have just had 10 inches depth of snow. The Parsnip is one of the very few vegetables that will not suffer. But a supply should

have been housed previously and covered with clay or, better, sand in any open shed or corner. A French cook once said to me the Parsnip can be made much more digestible by thorough boiling, previous peeling, mashing, and removal of any fibres, but always using or serving up with gravy, or in its absence "drawn butter." The poorer classes, he said, during winter might advisedly use rendered and purified lard. He challenged competition from any other possible or probable vegetable during the months of December, January, and February, and felt inclined to add March. Everything considered, I did not feel disposed to dispute the point, and would like to hear the opinion of any of your correspondents as to its relative merits during those months for the artisan and labouring classes. That the extended use of vegetables is desirable, and especially during the early spring months, medical men are unanimous; and that to those classes Cauliflower and Broccoli, or even good Cabbages, during those four months are, as a rule, an almost unattainable luxury seems equally unquestionable. Indeed, to my own knowledge in the thickly populated districts of the north of England out of gentlemen's gardens at any time those crops are much more difficult to grow than the Parsnip.

In the old and constantly cropped soil of our vegetable garden this crop fails to do well. Both the hollow-crowned and Jersey became diseased around the crown. I examined them very closely, but failed to find any insects in the rusty brown half-putrified portions affected, but this may have been owing to the injurious agent, if the larvæ of some insect, having taken another form, which it would be likely to do, before November. The same varieties grown on our farm in new soil escaped altogether; and though the ground was not so heavily manured nor so rich, the crop was much finer. But the field variety here that gave the finest—a magnificent—crop was The Student Parsnip. This we sold by auction, and realised the sum of £50 per Irish acre, which, after paying all expenses, including good manure at 4s. per ton, would still leave a good profit. This variety, though very large and a heavy cropper, has two disadvantages with me—it is liable to "fork," or divide the main stem, and for general table use much inferior in quality to the Maltese. Personally I did not like Parsnips until I commenced using the last-named variety, and would with some confidence commend it, cooked French fashion, as indicated already, to the most fastidious of your readers, especially from this time forward, when other vegetables are scarce. I have heard some gardeners complain of the Parsnip being subject to a disease somewhat similar to that affecting the Potato, but here it is not known. A commoner source of injury to the Carrot as well as the Parsnip are the larvæ of the click beetle and of the negro fly, and I regret to say I am unacquainted with any remedy. I would, however, hope that the recent severe frost and heavy snow, in addition to thorough cultivation, may be efficacious.—W. J. M., *Clonmel*.

COVERING HERBACEOUS PLANTS.

BORDERS of herbaceous plants are now very bare, and growers of these plants have in many instances cleared away the withered leaves and stems. In large public establishments such a course is really necessary, but in private gardens they may be left on the plants with advantage until spring. By this course we might preserve many of the plants we are continually losing; because, by cutting away their natural protection, we expose the tender crowns to the many changes of an English winter, so detrimental at least to South European plants. Where the dead stems cannot be left I would advise that a few Spruce or Pine branches be placed neatly round them; they are not at all unsightly, generally keeping their dark green colour until spring, and enlivening the otherwise rather dull monotony of bare rocks and empty borders.

In the north of Scotland branches are used to great advantage on parapet and other walls for covering climbers. They are tied round the plants with tar twine at the first approach of winter and left untouched until late in April, when the plants are found to be not only alive but quite healthy. By this means I have preserved plants which were killed at another place four miles distant and much less exposed.—HERBATIA.

OLDEST TREE IN THE WORLD.—The oldest tree in the world, so far as anyone knows, is the Bo tree of the sacred city of Amarapoora in Burmah. It was planted 288 B.C., and is therefore now 2170 years old. Sir James Emerson Tennent gives reasons for believing that the tree is really of this wonderful age, and refers to historic documents in which it is mentioned at different dates, as 182 A.D., 223 A.D., and so on to the present day. "To it," says Sir James, "kings have even dedicated their dominions, in testimony of a belief that it is a branch of the identical Fig tree under which Buddha reclined at

Urumelaya when he underwent his apotheosis." Its leaves are carried away as streamers by pilgrims, but it is too sacred to touch with a knife, and therefore they are only gathered when they fall. The king Oak in Windsor Forest, England, is 1000 years old.—(*Journal of Forestry*.)

NEW AND CERTIFICATED PLANTS OF 1882.

MR. B. S. WILLIAMS, UPPER HOLLOWAY.

THE Victoria and Paradise Nurseries have, as usual, contributed largely to the new plants of the past year, many distinct and handsome novelties having been recorded in these pages as justly honoured with certificates by the Royal Horticultural, Royal Botanic, and other Societies. A brief review of the plants under their respective classes will, however, convey a better idea of the extent to which the horticultural world is annually indebted to Mr. Williams for improvements and introductions. Commencing with the great feature of the nurseries, the

ORCHIDS.—The large collections of these grown at Holloway have a deservedly extensive fame amongst orchidists, and it is equally well known that no care is spared to secure the best varieties and the most beautiful or distinct species possible. As a necessary result the collection is constantly increasing in interest and value. During the past year eight Orchids have been certificated, comprising the following:—*Cattleya gigas grandiflora*, a superb variety of a handsome species, the flowers being, as the name implies, of great size, the broad sepals and petals deep rose, the lip white tipped with crimson. *Cœlogyne Massangeana*, a distinct species with long spikes of yellow flowers, the brownish lip contrasting curiously with the sepals and petals. *Lycaste Deppei punctatissima*, a variety with flowers very thickly dotted, which is the chief distinguishing character, except that the lip is a lighter tint of yellow than the species. *Odontoglossum Alexandræ virginale*.—Varieties of this favourite Orchid are now becoming quite numerous, but that named above deserves a place amongst the best. The flowers are finely formed; the sepals and petals broad, pure crystalline white; the lip also being white with a deep red spot, which renders the purity of the other portion of the flower more noteworthy. *Pescatorea Klabochorum*.—Like the *Bolleas* and the *Batemannias*, some of the *Pescatoreas* are very attractive, and that now mentioned would form a fine contrast to *Bollea cœlestis*. The flowers are large; the sepals, petals, and lip of wax-like texture, pure white tipped with purple. *Phalænopsis Esmeralda*.—Though without any pretensions to sharing the imposing characters of such species as *P. Schilleriana* or *P. grandiflora*, this is a distinct and pretty form of the small-flowered type, the crimson-purple flowers being borne on long slender spikes. *Pleione præcox*.—This might at first glance be taken for *P. Wallichiana*, which it much resembles; with the rosy sepals and petals, however, is associated a white lip spotted with yellow. Last, but by no means least, the handsome *Zygopetalum Clayi* merits a word of praise. This is unquestionably the finest hybrid in the genus, and will probably in the future prove a close rival to *Z. Mackayi*, as it is a really useful and beautiful Orchid, free and vigorous in habit. The sepals and petals are barred with deep purplish brown, and large lip mottled with rich violet blue. An engraving well showing the markings of the flower and general habit of the plant was given in this Journal, page 319, vol. iv., April 20th, 1882. We recently saw a still darker and more beautiful form in the Holloway Nurseries, of which, doubtlessly, more will yet be heard.

AMARYLLISES.—These plants have for many years been one of the leading features at Holloway, and the best of the varieties sent out thence are, it can be confidently said, unsurpassed in brightness of colour. Especial attention has been paid to improving the colour, and the success attained is considerable; the flowers also, though of moderate size, are of good form, very neat in outline, and are borne in fine heads. Two handsome varieties were honoured with certificates in 1882—namely, *Dr. Masters*, of brilliant scarlet colour and superb form; *Mrs. B. S. Williams*, a variety with pure white flowers, a fine companion for the preceding. *Mrs. Garfield*, which was certificated in 1881, deserves notice here, as it is still a novelty of great merit. It may be remembered that this is a hybrid between *A. reticulata* and *A. Defiance*, one of the *Hippeastrum* type, resembling the first in the foliage, which has a white band down the centre, and the flowers are of a rosy tint netted with a deeper hue, and like the other parent in size and shape. It is specially valuable, as it flowers in autumn, and is therefore doubtlessly a step towards a distinct type.

FINE-FOLIAGE PLANTS.—Though the number of novelties in this class of plants is steadily decreasing, a few are still being added yearly, and as more difficulty is experienced in gaining certificates for such plants, the value of that recognition is pro-

portionately increased. A trio of new Crotons have been exhibited and found to merit this honorary award—namely, Baron Schröder, Bruce Findlay, and Princess of Waldeck. The first has oblong elliptical golden leaves, the midrib crimson, and the margin green. The second is one of the largest-leaved varieties in cultivation, broad and long, mottled and blotched with yellow and green. The third also has broad leaves, but not so long; bright

yellow edged with green. *Dieffenbachia majestica* does not belie its name, for it is of noble appearance, having large rich green leaves blotched with a lighter hue. *Phalangium elegantissimum* will no doubt become a favourite decorative plant, its narrow arching Anthericum-like leaves being prettily marked with green and yellow longitudinal stripes.

FERNS.—The collection of forms constitutes another of the

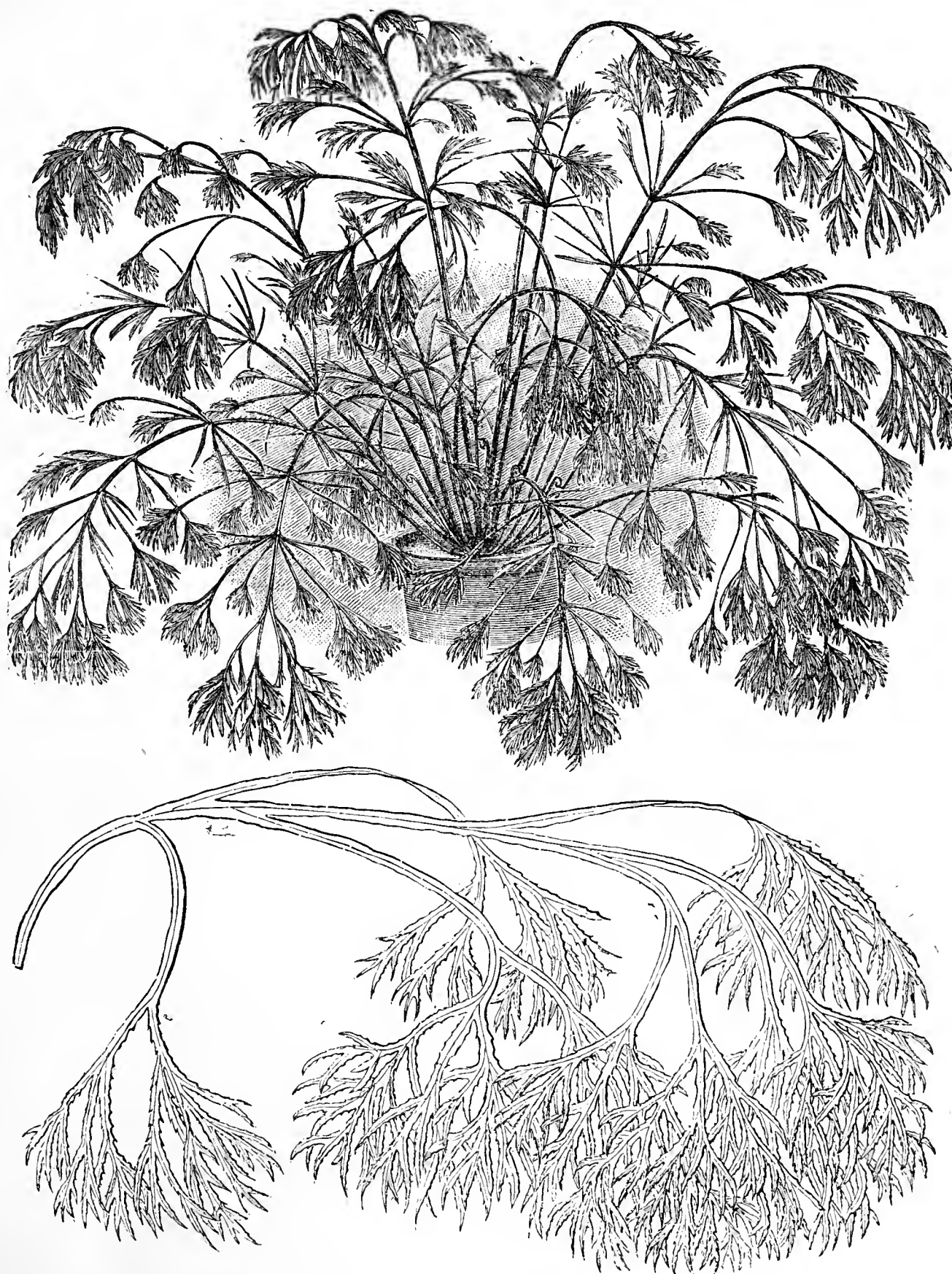

Fig. 8.—*PTERIS SERRULATA CRISTATA LACERATA*.

most attractive portions of the Holloway nurseries, all the chief useful genera being largely represented, and with the excellent collection of Filmy Ferns occupy considerable space. First deserving of notice amongst the new forms is that represented in the woodcut, fig. 8, *Pteris serrulata cristata lacerata*, which is a fine addition to the useful *Pterises* already in cultivation. The

fronds are about a foot long, drooping and feathery, the pinnæ being much divided and crested, especially at the points of the fronds. Its graceful habit will greatly recommend it for decorative purposes. Of the certificated Ferns *Adiantum Lathomii*, a strong-growing form with large pinnules; *A. dolabriforme*, an elegant species suggestive of *A. lunulatum*; *Davallia fœnicu-*

lacea, a large-fronded graceful species; and *Pellaea Doniana*, with long pinnate leaves, are the best, and all are worth a place wherever Ferns are appreciated.

STRAWBERRY BANKS.

AT this season of the year alterations and improvements are being carried out in many gardens. One such that may well receive attention now is a bank for early Strawberries. Sloping to the south at a sufficiently acute angle to derive full benefit from every ray of early summer sunshine, and planted with Black Prince if it is a small bank, but if large enough half should be given to Keen's Seedling or any other favourite early sort. There is no question that ripe fruit may be had from a warm sheltered sunny bank a week or two before it is ready upon open flat spaces. Why, then, are such banks so few? Making one in proportion to the size of any garden is no great affair, and if made in the right place it has certain advantages worthy of attention. Has your garden no wall, but only an unproductive hedge or fence surrounding it? Throw up a bank instead in the form of a ridge, plant the outer slope with shrubs and the inner slope with Strawberries, and you gain the triple advantage of early Strawberries, increasing shelter, and an ornamental enclosure. Or have you a little frame ground wherein you make hotbeds of fermenting materials, which it is highly important should be screened from cold winds? Enclose it with a ridge, which may be covered with Strawberries, early sorts having the south slopes, intermediate sorts the west, and late ones the north and east, and you have a succession of crops which must prolong the season of this desirable fruit.

Due care being taken to enrich the bank with a heavy dressing of manure, the earliest runners must be pegged in 3-inch pots of very rich soil, such as old leaf soil or an old hotbed, in order to secure enough strong plants for planting the bank as early in July as possible. Do this as well as you can; see that the plants do not suffer from drought, but are kept growing freely till autumn, and you will be rewarded by a good crop of fine fruit next year; but if the planting is not done till August it will be vain to hope for fruit till the second year. Let the plants be a foot apart every way the first year, and immediately after the fruit is picked hoe up every alternate plant so as to have the remainder 2 feet apart the second year. This is done to let every plant enjoy the full play of light and air on every side, for it is impossible to obtain very early fruit from plants crowded thickly together, or when the fruit is much shaded by foliage.—
A KENTISH GARDENER.

AN AMATEUR'S HOLIDAY.

THE excellent observations of "Excelsior" on "Gardening Past, Present, and Future," in a recent issue of the Journal, have received the attention they deserve. His advice should be laid to heart by all who desire success in horticulture. In a few instances, I found gardens affected by the adverse times to which he alludes; but other causes sometimes operate. Attached to the remains of one of our former royal residences is a garden with every nook of which I was familiar in boyhood. The whole was an appanage to an estate the possessor of which was endeared to all around him by every trait of a true gentleman. Under the gardener still in charge the gardens acquired a well-deserved name; but subsequently others entered into possession. On my recent visit I found evil reports but too well founded. A fair estate so far despoiled, the mansion let to strangers, the gardens now shorn of their former attractions, and my friend, now grey in service and sad at heart, struggling to maintain in the gardens what appearance he could with the feeble aid of those who under the former régime would long ere now have been relieved from labour and care. On another estate a few miles removed I visited another garden equally well known, where still labours one to whom I was indebted for many a little treasure in those days. What a contrast! So hale and hearty was my old friend I could scarcely believe that nearly twenty years had passed since last we stood together among his Dahlias and other favourites cherished still as then; but in attachment to his aged master and his family, in the absence of all anxiety as to the present or the future, lay the grand elixir that had so defied time and kept him but little changed.

EAST LOTHIAN.

I know no part of Scotland where a few days can be more pleasantly spent than in the beautiful county of East Lothian. Places and objects of varied interest abound everywhere. Gosford with its fine grounds and ponds stocked with waterfowl; the still splendid Binning Woods, old Tantallon, and the Goblin Hall of Yester, both familiar to readers of Sir Walter's "Marmion;" the venerable "Lamp of Lothian," Hailes Castle, associated with Bothwell and Mary—turn where we will, beauty, history, or romance arrests us. At Whittinghame, another residence of Bothwell, where part of the old tower and the original gateway are still to be seen, an immense Yew com-

mands attention. It covers a space of about 100 feet in diameter, and must be nearly 60 feet in height. Under it, it is said, Bothwell, Morton, and others concocted the murder of the ill-starred Darnley. A specimen of the *Eucalyptus* is near by, which nearly perished in the winter of 1860, but has subsequently produced five or six stems, and has now attained considerable size. At Smeaton is the finest specimen of *Picca nobilis* I have seen, about 70 feet in height. The pleasant county town, Haddington, boasts one of the oldest lodges of the Ancient Fraternity of Free Gardeners in the country. Age has certainly not brought debility. More enthusiastic horticulturists than the present worthy brethren it would not be easy to find. The district abounds in fine gardens, although one or more suffer at present from the crippled resources to which "Excelsior" refers. These deserve more than this passing notice.

In one or two, notably at Gilmerton and Stevenson, I found such crops of Apples and Pears as have been very rare this season. Gilmerton is well known for its hardy fruits, Mr. Brunton invariably coming to the front with these and others at our leading shows. At Stevenson I have never missed first-class bedding, and Mr. McLean's work in this and in ribboning was the best I met throughout my ramble. But what pleased me most perhaps were his mixed borders. In these the choicer herbaceous plants were judiciously interspersed with Pelargoniums, Calceolarias, Sweet Williams, and Pinks, the result being one of the most pleasing combinations I have seen. My herbaceous borders have as yet failed to please me. I obtained many plants that turned out quite unsuitable to my object. Next follows turning these out, and with Mr. McLean's borders as a model I may by-and-by come nearer to my ideal. His Tomatoes in pots were wonderful in number and size of fruit. His stuffed cat, now looking as if it deserved release from duty, he still holds to be a sufficient terror to birds. Tynninghame is pretty well known to your readers. I saw enough of the Phloxes and the fine herbaceous borders to make me regret that I had not called earlier so as to see them at their best. In no other part of the country have I seen such masses of *Tritoma Uvaria*. Even the cottages of the farm servants on the way towards Haddington were gleaming with the "Red-hot Poker." I commend East Lothian to the attention of those who, interested in horticulture, have not yet made acquaintance with it.

ARDOCH.

In another county, Perthshire, the famous Roman camp at Ardoch attracts many visitors annually. I have no doubt that such of your readers as have been there know that immediately adjoining can be seen a garden of moderate size but of high excellence. Among other things the mention of Dahlias and Hollyhocks has for years to my mind suggested Ardoch, where Mr. Dingwall grows these, as he does whatever he attempts, very satisfactorily. He still clings to the latter with a devotion that late difficulties cannot overcome. About a mile to the west lies Fedall, where in little over three years part of a moor has been converted into a garden well worth seeing now when yet incomplete. The proprietor, Mr. Stewart, is one of "Excelsior's" "liberal-minded gentlemen who do not grudge the expense," and the abilities of Mr. Dingwall have therefore had full scope. I daresay it is rare to find two brothers in charge so closely adjoining; it is not, I hope, so rare to find between two gardeners a friendly difference as to which serves the best employer. The extensive houses at Fedall seem most complete. The divisions between these are of thick glass. Of this Mr. Dingwall approves most highly, and considers that the ripening of the wood of Peaches, Nectarines, &c., trained against these glass partitions is of itself enough to justify the extra outlay of about one-third in their erection. I was at once on entering the vineries with their abundant crops struck with the sweetness and freshness of the atmosphere. I observed that the hot-water pipes entered through open squares of brick, by which air heated in passing over the flues was freely flowing, while the lights in every house were to be seen, the fires being at a little distance and out of sight. The situation of Fedall is an exposed one, and some time must elapse before trees will afford their share of protection now so far secured by high and substantial walls.

ROSES AT DUNKELD.

I embraced an opportunity of visiting Dunkeld. Seldom have I enjoyed two hours as I did those spent with Mr. Gray among his Roses. In "Roses in the Perthshire Highlands" in last "Rosarians' Year Book" he described, as no one else could, how he has responded to the question "Hoo can ye expek to keep a coo on a presipis?" not indeed by attempting to keep the "coo" there, but by converting that very precipice into a unique and beautiful Rose garden. In that article the confessed disciple of the Rev. Canon Hole certainly "revelled in refuse and danced on his dunghill with delight." The outcome of his labours, of his "dainty viands," his "Dunkeld whisky," his "Highland blankets," is there to see in such a rosery as could be looked for only from an enthusiasm that could inspire that article, and conceive and compass the subject of it. At the close Mr. Gray has indicated pretty accurately "Roses that are not trumps" with a good many as well as himself, and I trust he will let us know some others that he has tested fairly and found to be not winning cards in Scotland. His opinions on this point will, I presume to say, be corroborated by others, and would be useful to young amateur rosarians in the north. But few are privileged to gather experience from such a collection as his, embracing then two thousand Perpetuals and five hundred Teas, which number is now

doubled in nearly the same proportion. The last addition at least, if I mistake not, are worked chiefly on the seedling Briar. With his staff of a woman and a boy Mr. Gray has his work provided. The Roses of Eastferry are not by any means its only attractions, and the extreme courtesy of its master to a comparative stranger demands this acknowledgment at his hands.

And I saw Drumlanrig. To that wonderful place I may afterwards have the temerity to revert. Meanwhile your correspondent "P. U." recalls a visit to another place, the Ormeau Park, Belfast. It is seldom in my experience that we see beds of Verbenas now: there this season they were beautiful, and these were all from seed. I considered several of them well worth preserving; but the Curator, Mr. Dickson, informed me that he never fails to secure as good, and he has nearly discarded them. I found that he also relied for a white and a blue Viola upon two of his own raising. They were, perhaps, the most effective I have seen, the white being especially fine, and both contrasted very favourably with others of their colour. The Park is a fine one, and should not be omitted by visitors to Belfast. I will next beg leave to notice one or two of our nurseries in the north, some of which were new to me, and may be interesting to your readers.—A NORTHERN AMATEUR.

ALPINE AND BORDER FAVOURITES.

ERIGERONS.

E. aurantiacus.—This is one of Dr. Regel's introductions from Eastern Asia, having but recently found its way into our gardens. It is a striking little plant, and quite hardy. The flowers are solitary, on stalks from 4 to 9 inches high, bright orange-red; in fact, just the same colour as those of the old Hawkweed (*Hieracium aurantiacum*), but twice the size. This colour is scarce in the Erigerons, and it is on this account very desirable. It is a rock plant, enjoying a warm well-drained position, flowering early in the year, and again during the autumn. It is easily increased by division of the root, and the seedlings are readily raised in a cold frame; thus stock may be quickly secured.

E. philadelphicus.—Although with flowers not so large as many of the others, this is one of the best, owing to its very floriferous habit. It flowers during the greater portion of the year, until checked by frost. It grows from 12 to 18 inches high, with loose cymes of pink flowers, being very pleasing. Mr. Wolley Dod regards this as one of the best border plants; or it may be planted on the rockery. It increases rapidly, and is quite hardy.

E. speciosus (*Stenactis speciosa*) is a much older inhabitant of our gardens, and is very useful, flowering during June, July, and August most freely, good masses having a very striking effect. As all lovers of these plants know, the flowers are about 2 inches across, with blue-purple rays and yellow disks—most useful and decorative. The width of the ray florets vary in different plants (the wider they are, of course, the better), consequently we sometimes see a form called *superba*, which has wider rays, and is really better than the typical form. This grows from 18 to 24 inches high; in warm light soils it does not reach even the lesser height.

E. alpinus grows from 6 to 9 inches high, with small light purple flowers.

E. glabellus is a pretty border or rock species growing about 9 inches high, producing freely purple flowers about the size of a shilling.

E. mucronatus, generally known as *Vittadenia triloba*, is a pretty species, producing small Daisy-like flowers, white tinged with pink, in great abundance all through the late spring and summer months, until checked by frost. As a rock plant it is much to be desired, for, although not very showy, it is extremely pretty.

AUBRIETIAS.

Among the many Aubrietias now known perhaps none is more showy than *A. Hendersoni*. It is flowering very freely this autumn, the flowers being large, bright purple, and very freely produced. *A. græca superba* is also an excellent variety, flowering very profusely, but the colour is not so deep as that of the last. *A. violacea*, a new kind, promises to be a very striking addition. I have just seen a few flowers, and they were deep violet-purple; in fact, quite distinct from any known to me. If this character is constant it will certainly be a very valuable addition to our spring-flowering plants.

MULE PINKS.

The Mule Pinks (*Dianthus hybridus*) are very useful and showy plants, sadly too much neglected by our gardeners. The reason of this is difficult to understand, as they are very easily grown, and well repay in richly coloured flowers for any labour bestowed upon them. I should strongly urge all lovers of hardy flowers to secure a few and give them a trial. Among those known to myself as excellent varieties are the following:—

Napoléon III.—Very floriferous and compact, producing deep

crimson flowers about the size of a florin, very double and finely fringed, with a slight fragrance, on stiff slender stalks. It is a most valuable flower for bouquet work, the size and colour being especially suited for the purpose. It has a strong propensity to flower itself to death. Two batches of plants should be kept, one for flowering and the other for securing cuttings from, which root freely in a cold frame.

Marie Peré.—Also a very free-flowering kind, with pure white double flowers about the same size as the last, produced in clusters, and it is a most persistent bloomer and highly serviceable.

Miss Paterson is a very vigorous grower, producing large trusses of double crimson-pink flowers in abundance.

Tom Thumb is a very dwarf kind with brilliant scarlet flowers on stiff erect stems and very pretty. We rarely see this variety, and yet it is one of the handsomest border plants. Others might be mentioned, but the above represent the shades of colour, and they possess good constitutions. They are readily increased by cuttings, which root freely under a handlight in a cold frame.

CORONILLA IBERICA.

This is a very showy and useful plant, and which one but rarely sees, although it has been known as an inhabitant of our gardens for a considerable period. It is dwarf and creeping, with trifoliate leaves, and numerous racemes of bright golden-yellow flowers produced throughout the summer months up to the present time. I know of no place where it thrives so well as at the Rev. Ewbank's of Ryde; but of course soil and climate there are remarkable.

C. varia is a first-rate plant where it can enjoy unlimited room, as it rambles over a large space of ground, producing an immense quantity of flowers throughout the spring and summer months, of a delicate pink and white colour. If planted in a hot and dry position on the rockery it does not ramble so much, and the colour of the flowers is rather deeper. It is a useful plant for the wild garden or for positions where space is no object.—X.

ROYAL HORTICULTURAL SOCIETY.

JANUARY 9TH.

PRIMULAS and Cyclamens were shown in strong force by several firms, and indeed these plants formed the chief portion of the display. Both Committees were largely represented, but their duties were light.

FRUIT COMMITTEE.—Harry J. Veitch, Esq., in the chair, and the following members were present:—Messrs. Phillip Crowley, John Barnett, Arthur W. Sutton, J. Woodbridge, R. D. Blackmore, H. Howcroft, G. Bunyard, G. Goldsmith, Sidney Ford, Z. Stevens, John E. Lane, J. Willard, and Harrison Weir. Fine samples of Apple Calville Blanche were shown by Mr. Z. Stevens, The Gardens, Trent-ham Hall, Staffordshire; they had been grown in pots in an orchard house. The Apples were large and of a fine clear yellow colour. A cultural commendation was awarded. Mr. Stevens also sent samples of Duke of Buccleuch, and Black Hamburg, and Madresfield Court Grapes, the first-named being in fine condition. Mr. Sidney Ford, Leonardslee, Horsham, was awarded a vote of thanks for samples of Gros Colman from Vines grafted on Black Prince and Alicante, also of Mrs. Pince on Royal Vineyard, and Alicante on Raisin de Calabre. Some good fruits of Pear Josephine de Malines were also sent. Messrs. Downie & Laird and Mr. Dunn of Dalkeith sent samples of John Downie Grape, but they were found to be different, and further specimens were desired. A vote of thanks was accorded to Mr. J. Cauchoux, Orleans, France, for fine fruits of Doyenné d'Hiver (Easter Beurré). The six fruits weighed 5 lbs. 7 ozs.

A cultural commendation was awarded to Mr. G. R. Allis, gardener to J. Shuttleworth, Esq., Old Warden, Biggleswade, for three fine bunches of Black Alicante Grapes in good condition and well coloured, weighing about 8 lbs. A cultural commendation was awarded to Mr. Miles, gardener to Lord Carrington, Wycombe Abbey, for two handsome fruits of Lord Carrington Pine Apple, large and well ripened. Several varieties of Red Celery were sent from Chiswick, comprising Williams' Matchless, Big Ben, and Winchester.

FLORAL COMMITTEE.—G. F. Wilson, Esq., in the chair. The following members were present:—Rev. G. Henslow, and Messrs. T. Moore, J. Laing, W. Bealby, Shirley Hibberd, J. Douglas, H. N. Ridley, G. Duffield, W. B. Kellock, H. Cannell, J. Dominy, J. Hudson, C. Green, J. James, H. Ballantine, and J. Wills. A silver medal was awarded to Messrs. James Veitch & Sons, Chelsea, for a collection of exceedingly well-grown Cyclamens, fine vigorous specimens in 32 and 24-size pots, the foliage strong and the flowers of great size with broad petals. White, crimson, purple, with rose and white, were admirably represented. Two plants of the new *Cattleya labiata* Percivaliana were shown in flower by Mr. Salter, gardener to J. Southgate, Esq., Selborne, Streatham, and Mr. B. S. Williams, Upper Holloway. The flowers are of moderate size, with pale purple sepals and petals, the lip very rich crimson streaked with deep orange in the throat, the markings being much more prominent in Mr. Williams' plant. Apparently the chief recommendation of the plant is the season at which it flowers.

Mr. B. S. Williams was awarded a silver medal for an extensive and beautiful group of Cyclamens and Primulas, the former predominating and representing a great variety of rich and pure colours, the flowers large, compact, but vigorous. *Primula palmata alba* was notable for its dwarf habit and large well-formed flowers. Messrs. James Dickson & Sons, Newton Nurseries, Chester, sent four plants of an extremely dwarf *Primula* named *floribunda*, which is not more than 4 inches high, and bears heads of diminutive bright yellow flowers, the lobes round and spreading. A cultural commendation was awarded to Mr. J. King, Aylesbury, for strong plants of *Primula Mont Blanc*, with large flowers, white faintly tinged with pink. G. F. Wilson, Esq., Heatherbank, Weybridge, sent flowers of *Primroses*, crimson, purple, and yellow.

Messrs. H. Cannell & Sons, Swanley, exhibited a collection of *Primulas*, amongst which a delicate pale pink variety named *Princess of Wales*, which has large flowers in dense heads. Other good forms were *The Queen*, white tinged with pink, large and fringed; *Swanley Red*, very deep; *Swanley White*, pure; and several unnamed forms. *Wallflowers*, *Cineraria cruenta*, and *Primrose Harbinger* were also much admired. A cultural commendation was awarded to Mr. C. Green, gardener to Sir G. Macleay, Pendell Court, Bletchingley, for flowers and leaves of *Dahlia arborea*, a species in the style of *D. imperialis*; tall, frequently 9 feet high, with large pinnate leaves and rosy purple flowers, some with central tubular florets coloured like the ray flowers. Flowers of *Nardosmia (Tussilago) fragrans* were also sent. A cultural commendation was also awarded to Mr. F. Miller, gardener to J. T. Friend, Esq., Northdown, Margate, for a branch of richly coloured *Bougainvillea spectabilis* flowers, and some *Camellia* blooms. Mr. Hughes, gardener to E. A. Wood, Esq., St. Nicholas House, Scarborough, sent plants of some peculiar single and double *Primulas* of a yellowish tinge, and some double whites, which were much better.

Messrs. J. Carter & Co., High Holborn, were awarded a bronze medal for a fine collection of *Primulas*, comprising the following varieties:—*Holborn Gem*, the noted blue variety; *Rosy Morn*, large and rich rose; *Magenta Queen*, deep colour, large; *Mauve Queen*, fine lilac hue; *White Queen*, large and handsome; *Elaine*, a Fern-leaved white; *Covent Garden Favourite*, rosy crimson, handsome; *Golden Leaf*, a form with yellow foliage; and *Hederifolia*, with very sharply lobed leaves, and somewhat like an Ivy-leaved *Pelargonium*. A large collection of *Primulas* was sent from Chiswick, a number of good and distinct varieties. The best were *Chiswick Red Improved*, very deep colour; *lilacina*, delicate; *cristata nana*, with crisped leaves; *cuprea*, of a peculiar rosy red tint; *rubra violacea*, very rich colour; and a white variety of great beauty, the blooms large and well formed. Specimens of the free-flowering *Echeveria retusa* were also sent.

First-class certificates were awarded to the following plants:—

Azalea Duchess of Albany (Todman).—Certificated as a decorative plant. This was described as a hybrid *China Azalea*, and bears pure white flowers of moderate size, with rounded petals, and they are produced very freely at this season.

Odontoglossum madrense var. giganteum.—This very fine variety was exhibited by W. Vanner, Esq., Camden Wood, Chislehurst. It has narrow sepals and petals, the former being larger and more tapering; both are white blotched with claret purple at the base, the triangular lip being white at the point and bright yellow at the base.

SCIENTIFIC COMMITTEE.—Mr. G. F. Wilson in the chair.

Rhododendrons.—Mr. Mangles exhibited a three-year-old seedling of *R. nobile*, a form of *R. arboreum*, from an elevation of only 6000 feet in Ceylon, and which lately withstood 19° of frost; while *R. arboreum* proper, a hybrid of the last, *R. cetosum* from 13 to 16,000 feet, and *R. anthopogon* were all more or less injured, although coming from a much higher elevation.

Magnolia Campbelli.—He mentioned on the authority of Mr. Gumblen that this species had flowered in Europe, as well as that the tree at Mr. Crawford's gardens near Cork has at the present moment thirty buds.

Ozonium auricomum.—Dr. Masters exhibited a specimen of this fungus from a Sycamore. Mr. W. G. Smith remarked that he had observed the same fungus on wood in a cellar.

Dahlia arborea.—Mr. Green forwarded a branch bearing single as well as Anemone-flowered forms. There appeared to be some doubt as to its specific identity, as it has never been known to flower before. It was referred to Dr. Masters to report upon.

Pines.—Dr. Masters also showed specimens of *Pinus contorta* remarkable for its twisted branches, *Pinus Bolanderi*, *P. Murrayana*—all these from California and supposed to be the same, but the hypodermic cells clearly show that they are specifically distinct.

Melon Grown under Electric Light.—A small green smooth-skinned Melon sent from Dr. Siemens' garden. It proved very watery and sugarless. Dr. Masters will inquire and report on the exact conditions of its growth.

Mycelium on Alum.—Mr. W. G. Smith exhibited a vessel full of solution of alum in which a fungus was growing. On transferring it to a syrup it proved to be the Vinegar Plant, or *Penicillium crustaceum*.

Lapageria rosea.—Mr. Boscawen sent a fine spray of this plant, which was grown out of doors in Cornwall, as well as flowers of a species of *Colchicum* from Cyprus.

LECTURE.—The Rev. G. Henslow called attention to various Pri-

mulas exhibited, which showed different types of foliage as well as of blossoms. The typical form of leaf is palmate, resembling the palm of the hand. Of this Messrs. Carter exhibited a golden-leaved variety which is now permanent, having originated as a single seedling from Vesuvius. A second variety is the Ivy-leaved form, which appeared suddenly in different gardens, a peculiar form having no minor indentations in the margin. A third variety is the crisped-edged leaf. This form, like curled Cabbage and Parsley, is due to a kind of hypertrophy or excess of growth. It is interesting to note that this is accompanied by very poor flowers, but after a few years the curled habit will doubtless become fixed, when the blossoms can be improved by crossing. Another remarkable fact connected with this sport, as with some others, is their sudden appearance simultaneously in different localities, and without a common origin. It was observed several years ago that double *Petunias* appeared on the continent and in England for the first time simultaneously. What the meteorological conditions may be to give rise to this curious coincidence are as yet unknown. The second type of foliage is the Fern-leaved, in which the apex has grown out so that the form is elongated. These two types of foliage run through other plants and give rise to the corresponding types of "compound" leaves, such as the digitate of the Horse Chestnut and the pinnate of the Ash. Similarly Palms are mainly divided into fan-shaped and feather-shaped leaves, according as the midrib is arrested or elongated.

With regard to the flowers, the diversity in the tints of red is almost infinite, but curious results follow from crossing. Thus, two whites crossed may give a deep red. A mauve (*Holborn Gem*) self-fertilised gave half its seedlings white, the other half mauve, or the so-called blue. Such diversities are well known in other plants besides *Primroses*; thus, Mr. Veitch found that an orange *Rhododendron* crossed by a white one gave white, pink, and yellow-flowered seedlings. The same thing occurred in *Abutilons*.

HISTORICAL JOTTINGS ON VEGETABLES.—1.

THE aboriginal inhabitants of Britain appear to have done little or nothing in the way of plant-culture with any object. It was after the arrival of the Romans that the subjugated Britons began eventually to follow the fashions of Italy, and those who could formed flower gardens and orchards; kitchen gardens perhaps, one has to add, since the Romans were "no great shakes" at the cultivation of vegetables for culinary purposes. In the matter of fruits we all know our great indebtedness to them. They introduced new species, they also improved upon others that were growing wild in our extensive forests. The Fig, Pear, Plum, Cherry, Quince, Apricot, Peach, Chestnut, and Walnut are only a part of the fruits the Romans have been credited with, but they did not add much, if anything, to the English kitchen garden. Demand creates supply, as we are aware, and the Roman fashions in regard to meals, even during their grandest days, were rather peculiar. De Quincey has proved beyond question that their *jentaculum* and *prandium* translated by us as "breakfast" and "dinner," were meals of a shadowy kind—a slice of bread or a biscuit, eaten anywhere, flavoured by a Fig, a Date, or an Olive. The *cæna* or supper was the sole substantial meal, consisting of several courses. One course was all fish usually, another all fruits, but vegetables did not occupy a place of importance in any. Some dishes of broth or stews were, however, flavoured with herbs, and the vigorous stomachs of the Romans relished Onions, Leeks, and Garlic. In two of these our taste is, on the whole, not at all in sympathy with theirs.

During the unsettled times when Dane and Saxon contended for the mastery gardening was not much attended to in England. We know that many plants which had been introduced by the Romans were lost sight of. The preponderating population—the Anglo-Saxon race—had no particular genius in this direction, and it was not till after the Conquest that the London citizens appear to have turned their attention to the raising of vegetables for the table. That city, from its position as the chief resort of visitors and the abode of the Court, was sure to take the lead in all matters of progress. Undoubtedly the English got some valuable hints from over the Channel, nor should we be reluctant to acknowledge our early horticultural obligations to our French neighbours. We have not failed to make them returns; indeed, at one time it was remarkable how eagerly every English method in gardening was examined and acted upon by the French gentry.

Subsequent to the Conquest a great impulse was given to all branches of gardening by the Crusades, which opened up more frequent communications between the countries of Europe and parts of Asia. Then, again, the palmers and pilgrims in their peregrinations often carried from one monastery to another the seeds or branches of some plant that was a novelty, which the monks would carefully cultivate in their small but well-tended plots.

There exists in the London chronicles an old petition of the

date of 1345, addressed by the gardeners of various nobles, bishops, and merchants to the Lord Mayor, their complaint being that they were no longer allowed to take up their accustomed standing in the front of St. Austin's Church, where they used to vend vegetables, fruit, and herbs. They had been interfered with by the ecclesiastics on account of the noise they made, and the Mayor allotted them another place; but he could not re-instate them as they desired. It is a curious fact that these personages five centuries ago could grow more than they required for their own households. There could not, however, have been much variety of vegetables, probably some sort of Kale and pulse—*i.e.*, Peas and Beans. Perhaps it was the increasing smokiness of the centre of the metropolis that led a number of citizens some few years afterwards to take a tract of land near the City Road, which they formed into garden plots for their convenience and recreation. For a long period the place retained the name of the "City Gardens."

The early "professional" traders in vegetables, it is supposed, grew what they sold along the streets in their small gardens about Golden Lane and neighbourhood, now densely populated; also they offered fruit, Apples prominently, whence they came to be called "costard-mongers." The herb-women, or herb-wives, seem occasionally to have carried vegetables. As the population of London increased the farmers began to grow these for the market in the fields towards Hoxton, about Whitechapel and Shoreditch, north and east of the city. The first ground on the west side that was broken for gardening purposes, in order to raise a variety of choice vegetables, was in the district of the "Neat houses" between Millbank and Chelsea, where the moist rich soil made it particularly suitable. But this was not till about the middle of the seventeenth century, when more esculents had been introduced. Strype refers to the quantities of Asparagus, Artichokes, Cauliflowers, and "Musmelons" grown on the part of the Thames bank. These and other plants came into England during the times of the Tudors, principally owing to those inhabitants of Flanders and the Low Countries who were driven from their homes by persecution. In 1530 and years following parties of these emigrants worked their way across Kent to the suburbs of London, and they had market gardens on its south side at Vauxhall, Battersea, and Bermondsey.

A fresh impulse was given to gardening during the domestic peace that followed the Restoration, and more new vegetables were introduced. Yet it was not until nearly the close of the century that our forefathers came to regard vegetables as a leading item in their daily food, and most private residences of any importance had a kitchen as well as a fruit and flower garden. Then vegetables ceased to be imported from Holland and France, partly from the interruption to trade by war, and partly from the cheapening of home produce, owing to the increase in market gardens near London and elsewhere. The culture of vegetables for profit was, I should consider, at its best during the reign of good old George III.—J. R. S. C.

MICROCACRYS TETRAGONA.

TASMANIA is not rich in Conifers, though examples of several genera unknown or rare in the northern hemisphere occur in the island, such as *Arthrotaxis*, *Fitzroya*, *Dacrydium*, *Podocarpus*, and *Microcachrys*; but few of these are confined to that country, some being common both to New Zealand and Australia. *Dacrydium Franklini*, the Huon Pine, is a well-known inhabitant of Tasmania, but the plant of which a spray is shown in the woodcut (fig. 9) is rare in its native country, and also rare in cultivation in England. It is, however, one of the most remarkable of the Conifers found at the Antipodes, and indeed in the whole family. The great peculiarity of the plant is that the female cones are of a semi-transparent texture, fleshy, and most brilliantly coloured, being of a rich red hue that in sunlight is very striking. These cones, though small, are borne in considerable numbers on short branchlets, and, the main branches being of a decumbent or drooping habit, the plant has a graceful and really beautiful effect grown in a pot with the main stem secured to a stake. It is found growing on the western mountains of Tasmania, where it forms a low straggling bush, the branches being four-angled, as the specific name indicates, the leaves small and closely pressed to the stem. It was introduced to Kew about 1862 by W. Archer, Esq., of Cheshunt, and several plants in the temperate house there succeed very well and produce their attractive cones very freely.

Several Conifers produce coloured fruits, but in most cases it is a disk, aril, or some appendage that is so coloured, and not a true cone, as with the *Microcachrys*. For instance, the fleshy aril of the common Yew is well known, and in the genus *Podocarpus* several similar examples occur, one of the most noteworthy being

P. neriifolia, the Oleander-leaved Podocarp. The fruit of this species has a large fleshy globular or ovoid bright red disk about half an inch long, upon the top of which is seated the seed, a true fruit about the size of a large pea, but more egg-shaped and

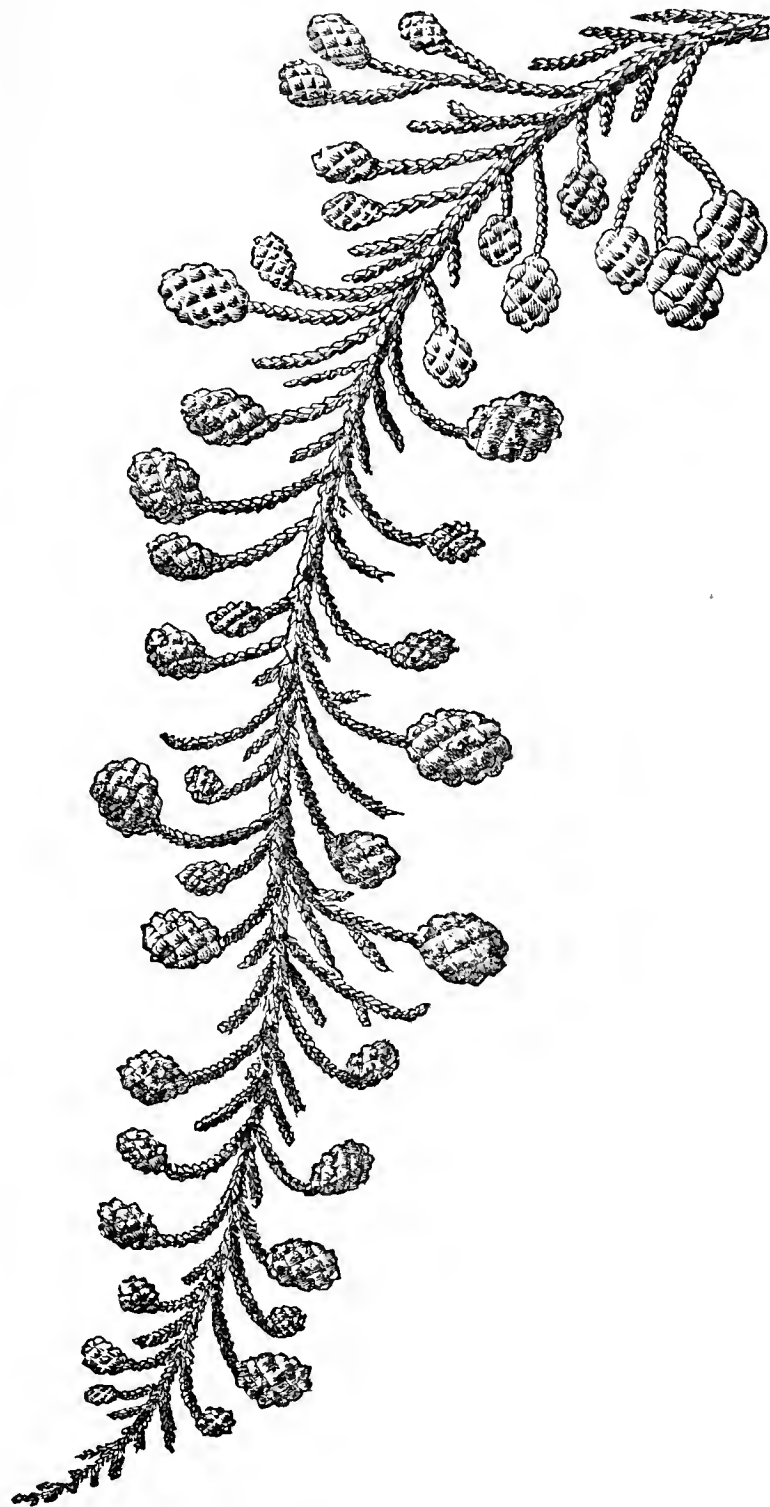

Fig. 9.—*Microcachrys tetragona*.

bright green, forming a most peculiar contrast with the richly coloured disk.—L. C.

EXPERIMENTS WITH POTATOES.

IN a late number of the Journal I praised the Champion, Skerry, and Magnum Bonum Potatoes as prolific and good keepers. In confirmation of the same I enclose you a clipping from the *Belfast Newsletter* which appeared some time after I wrote my paper, and possibly the report may interest your many readers, horticultural and agricultural.—COMBER, *Co. Down*.

AT a recent meeting of the Chemico-Agricultural Society of Ulster Mr. Davidson read the following report on "Experiments on the Potato Crop:"—In presenting the report of the experiments conducted on the Potato crop at Brookfield Agricultural School, in order to prevent miscalculations by any portion of the public interested in such experiments, I may be permitted to state that all possibilities of waste are excluded from these calculations, that an acre means every inch of land in an acre, and that no allowance is made for the necessary waste of culture, fences, or any other sources of deficiency, and that no part of the crop is considered beneath the care of calculation. A Potato the eighth of an ounce in weight,

although diseased, is carefully taken into consideration in the calculation of results.

These experiments have been made on the growth of eight different kinds of Potatoes and under seven different conditions of soil, drainage, and manures, and upon twenty-three experimental plots, of the common kinds of Potatoes, Champions, Skerries, and Magnum Bonums, grown under ordinary conditions in the same kind of soil—a sandy loam with sandy subsoil. The Champions yielded 3 tons 18 cwt. 3 qrs. of good table Potatoes, 4 tons 5 cwt. 1 qr. 7 lbs. of inferior quality, and 9 cwt. 3 qrs. 10 lbs. of diseased tubers, making a total of 8 tons 13 cwt. 3 qrs. 17 lbs. per acre. Skerries yielded 4 tons 16 cwt. 1 qr. of good table Potatoes, and 1 ton 6 cwt. 1 qr. of inferior quality, making a total of 6 tons 2 cwt. 2 qrs. per acre. Magnum Bonum 6 tons 4 cwt. 2 qrs. 21 lbs. suitable for table use, and 2 tons 12 cwt. 2 qrs. of inferior quality, being a total of 8 tons 17 cwt. 0 qrs. 21 lbs. per acre. The per-centage of diseased tubers in the Skerry and Magnum Bonum was so exceedingly small that it is not given, that of the Champions is considerable.

The advantage of changing seed is shown by the following:—Skerry seed, grown on the same farm for several years, yielded per acre 6 tons 17 cwt. 3 qrs. 7 lbs.; but new seed on the same ground yields 7 tons 10 cwt. 3 qrs. 21 lbs. per acre; and the increase of quality was exactly in the same proportion.

The advantage of well-drained land over undrained has been very strikingly shown this year. Skerries, new seed, in undrained land yielded 7 tons 10 cwt. 3 qrs. 21 lbs., but in drained soil yielded 8 tons 17 cwt. 21 lbs. per acre. The Champions under similar conditions in undrained land yielded 6 tons 11 cwt. 1 qr., but in drained soil the yield was 8 tons 13 cwt. 3 qrs. 17 lbs. per acre. The Magnum Bonum presents even a greater contrast. In undrained soil there was a yield of 4 tons 11 cwt. 3 qrs. 14 lbs., but in drained soil it was 8 tons 17 cwt. 21 lbs. per acre. The difference in quality cannot be well shown in figures, but of picked Potatoes suitable for market the undrained land yielded only 2 tons 12 cwt. 2 qrs., but the drained soil yielded 6 tons 4 cwt. 2 qrs. 21 lbs. It should be also observed that in undrained land the diseased tubers form a percentage of the refuse of all the lands; even of Magnum Bonum there were 6 cwt. 2 qrs. 7 lbs. per acre of diseased Potatoes.

But of all the conditions which influence the production of crops over which the farmer has control the action of manure appears the greatest. In a portion of land where the crop was grown without manure there was a yield of 3 tons 5 cwt. 2 qrs. 14 lbs. per acre, and in the same soil with the ordinary manure (about 25 tons per acre) the yield was 6 tons 17 cwt. 3 qrs. 7 lbs.; but with extra manure at the rate of 56 tons well-rotted farmyard manure the yield was 15 tons 8 cwt. 1 qr. 21 lbs. per acre, but with the same heavy manuring on undrained soil the yield was much less—8 tons 10 cwt. 2 qrs. 14 lbs. per acre.

Of new kinds reared by Mr. Torbitt, and the seed supplied for these experiments by Mr. A. Green, Trumra, a round blue Potato like the Skerry, and named New Skerry, yielded 7 tons 17 cwt. 2 qrs. of good table Potatoes, and 2 tons 19 cwt. 0 qrs. 7 lbs. of small ones, making a total of 10 tons 16 cwt. 2 qrs. 7 lbs. per acre. This is a very superior Potato in every respect, and free from disease. A white Potato named Tenant Right, elongated, with a rather uneven surface, but good to eat, yielded 12 tons 9 cwt. 1 qr. 14 lbs. per acre, of which 9 to 10 cwt. were suitable for table use, but in undrained ground the yield was under two-thirds of this. A very nice white Potato, round-shaped, remarkably free from disease or waste, and named Gladstone, yielded 7 tons 17 cwt. 2 qrs., and of these 6 tons 4 cwt. 2 qrs. were fit for table use; and an unnamed Potato yielded 8 tons 10 cwt. 2 qrs. 14 lbs. per acre, but being subject to disease would not be worth preserving.

The experiments made to test the value of Mr. J. L. Jensen's recommendation of heavy covering as a protection against disease has not confirmed his anticipations. In July, when the disease appeared first on the leaves, I selected a few perches in the ordinary crop, towards the middle of a field, and got our gardener to turn the haulms carefully towards the east, and on the west side of the drill to put on a covering of between 6 and 8 inches of mould, leaving that side of the drill perfectly clear of stalks, and the soil at an angle of about 45° so as to protect it against rain. On the 26th of October I had them raised, and found 42.105 per cent. diseased tubers, and in a drill alongside of them, which had received the ordinary culture, I found only 33 per cent. of diseased tubers, or a difference of 7 per cent. against the protected Potatoes. The soil is heavy, drained, and rich on which the experiment was conducted.

To summarise these results, we find the advantage of the Potato crop of this year in drained land over undrained, all else being equal, is from 16 to 94 per cent., according to the kind of Potato grown, and the difference between a light and heavy soil is almost in the same proportion. The advantage of changing seed is at least 11 per cent., but the application of an increased quantity of manure gives a return so far beyond expectation that, without actual experiment, it appears incredible. It would not be just to draw any decided opinion from these limited experiments on the merits of Mr. Jensen's protective covering against the Potato disease; but from other experiments and microscopical examinations, with the object of tracing the origin and progress of the disease, extending over several years, I am of opinion that, whether there be a possible remedy or not, it is yet undiscovered. But that which promises most

practical advantage to agriculture is the successive introduction of new kinds of Potatoes carefully selected by practical farmers under scientific guidance; and as the necessity must be continuous and the expense is considerable, Government assistance should be offered to such agricultural associations as by past gratuitous labours have proved their ability to conduct such work, as well as their zeal for the furtherance of agricultural prosperity.

PROF. MEEHAN ON EVOLUTION.

At the meeting of the American Association for the Advancement of Science at Montreal last year Prof. Thomas Meehan, in response to the invitation extended him at the Cincinnati meeting to address the Biological Section, spoke on variations in nature, and their bearing on the doctrine of evolution, and the theory of natural selection. He premised that the doctrine of natural selection, as propounded by Mr. Darwin, could not be controverted in so far as the continual dropping-out of intermediate forms was concerned, which left the extremes without connections, and gave us the idea of distinct species. He thought there were some weaknesses in Mr. Darwin's method of advocating his views, but these removed only left Mr. Darwin's position stronger than he himself perceived. He then proceeded to show that variations in nature were much greater than Mr. Darwin evidently had knowledge of. The popular idea that no two leaves on a tree were exactly alike in every respect was shown to be literally true. Many illustrations were given, and specimens exhibited showing the great variations in seedlings of the same species, often from the same seed vessel; some from the latter would be regarded by any botanist who found them wild as distinct species. A series of sixteen cones of *Pinus rigida* was exhibited, each from a separate tree, all growing within a circle of twenty miles; and the central links being taken away left nominal *Pinus serotina* at one end and *Pinus rigida* at the other. Other species could be made by taking the interior series of forms. The speaker contended that variation was not a mere condition, but had to be accepted as a primary law of existence. As no two things have ever been produced exactly alike so far as we know, the result must necessarily be a wide divergence in time; and as we know that death was also a certainty to individuals, distinct forms must certainly ensue.

Heredity, as established by Mr. Darwin, was next reviewed, and shown to be established as a counterpoise to variation. It held variation in check, but was finally overpowered by this the greater force. Sex was an attribute of heredity. Sex in flowers had no bearing on the future good of the race, and therefore crossing by insect agency or otherwise had no reference to the good of the race by aiding variation in the direction of change to suit environments. It rather brought back what Mr. Darwin would imagine a useful variation towards its starting point. A variation which had started from the centre of a circle had to be cross-fertilised, if at all, from the centre from which it sprung, and the progeny was thus brought back towards its parent's starting point.

The next point made was that variations had no relation to the good of the individual or race. Numerous cases were adduced to show that the forms which had prevailed had not the slightest physiological advantage over the forms displaced, and that those who argued on the contrary were reduced to the solitary argument that there must have been some advantage or the species could not have survived. It must be so because it is, is an argument which has no place in researches such as we are engaged in now. The actions and behaviour of both plants and animals were not for their own individual good. Their whole efforts were in the interest of their progeny—for posterity, for the future, for objects wholly unknown to the individual. Yet we found from the science of the past that all this self-sacrifice—pleasant as it was made to be to the individual, and ignorant as these individuals were of what they were working for—all had resulted in present harmony. In the speaker's language "we and all organic things are the invited guests of Nature. She makes our stay with her as pleasant as possible, but she ruthlessly dismisses us the moment we cease to serve her future purposes." The laws by which destruction were brought about were then considered, and the manner in which species were created by the aid of this destructive power discussed; and how, under the operation of the law of heredity, surviving forms found a temporary standing ground until the greater law of variation again finally removed them.

Finally the speaker took up the objection that Mr. Darwin's views were destructive of Christianity, and showed that they were in reality the strongest confirmation of Christianity's essential features. To his mind Christianity differed from all other systems of religion by insisting on the necessity of self-sacrifice. We have "to do the Father's will" regardless of all consequences to ourselves, as the condition of happiness, and the Great Teacher himself sealed these doctrines which shine from almost every page of the New Testament by the Saviour offering up His own life. This is precisely what science, as he had endeavoured to trace it, was now teaching. A wiser Power than any science had as yet been able to fathom was directing all things to some far-away object, to us unknown; not for the individual benefit of anything, except in so far as it was in harmony with this Power, holding all things together for good in spite of the seeming clashings of individual interest, and he was assured that the time would come when evolutionists, and especially those who advocated the theory of natural selection, would come to be

regarded as true Christianity's warmest friends.—(*The Naturalist's Leisure Hour.*)



[By the most skilful Cultivators in the several Departments.]

HARDY FRUIT GARDEN.

Planting.—In favourable weather forward the planting so as to finish it before the end of the month. In so wet a winter the trees should be procured before the ground is touched, then prepare each station and plant the tree in it before starting with another, the object being to avoid stirring the soil and then leaving it to become saturated with rain before planting. In new gardens and orchards drain thoroughly before any planting is done, making the drains 30 feet apart, and from 2 to 4 feet deep, according to the nature and condition of the soil. In old gardens renew or repair the drains as appears necessary. Examine the soil with great care, and deepen or enrich it as seems necessary. Never forget that a fruit tree is liable to suffer from canker and to decay early in a poor shallow soil, therefore see that every station has a depth of 2 feet of good soil and is 6 feet square. In old gardens there is no objection to planting young trees in the same place as the old trees grew in, provided due care is taken to remove all particles of old roots from the soil, and to renovate it with a dressing of lime and a little fresh soil. We have a heap of pond mud which was mixed with lime some eighteen months ago that we are using for this purpose now.

Pruning.—Pruning all kinds of fruit trees, except Filberts and other Nuts, should be continued on every favourable day, so as to finish it in good time before the buds commence swelling. Let the condition of each tree be the guide in pruning. Unhealthy or weakly growth should never be retained. All the fruiting wood of a Noblesse Peach was found to be so weakly last January as to be incapable of bearing fine fruit. It was cut off at the expense of last year's crop, but now the tree has magnificent fruiting wood, singularly sturdy, and thickly set with triple buds. There should be much caution in pruning Cherries. We have a fine collection of pyramids, which we used to prune closely till they were as large as we required them and were in full bearing. Since then hard pruning has been gradually discontinued, and a thinning of crowded growth is almost all that is required, very little of the young growth having to be shortened. The hard pruning of Cherries in full bearing leads to premature decay, and should be avoided as much as possible, even in the deepest richest loams. It is a rule in the large Kentish plantations to finish pruning bush fruits by the end of January. Very strong shoots are removed from all sorts except Black Currants, which cannot be too strong, and other growths are thinned so as to give free admission to light and air. Raspberries are shortened to 3 feet and have no supports; but in the garden we prefer the canes 4 feet 6 inches long, and tie them in rows to tarred string fastened to stakes driven in the ground along the rows at intervals of 6 feet.

Training.—A healthy tree with every branch equally vigorous and fruitful, combined with a symmetrical shapely form, should be the end and aim of all training. Air and light should enter the tree freely to the base of every branch and among every cluster of spurs. To secure this will be to thin branches and spurs in the best way, and the eye will be the guide in this matter better than any stated distance apart could do. Let every branch point upwards, or at as acute an angle as possible. See that all tight shreds or strings be removed, so that there is no hurtful pinching or hindrance to the free growth of young trees. Carefully examine all wire stays, and loosen any that may require it. Neglected wire supports or fastenings are a greater and more frequent source of harm to fast-growing young trees than any other material used for training or supports.

FRUIT HOUSES.

Strawberries in Pots.—In order to secure a supply of ripe Strawberries at the end of March or beginning of April the plants must be introduced to an early Peach house or vinery where the night temperature does not exceed 50°; but as this will be the minimum of a vinery preference should be given to a Peach house, which will have a night or artificial temperature of 40° to 50°. The drainage should be examined and if necessary rectified, carefully removing all worms. The surface of the pots being loosened

with a pointed stick and removed should be given a top-dressing of old Mushroom-bed refuse or something similar. Vicomtesse Hericart de Thury, La Grosse Sucrée, and President are suitable varieties. Early varieties started last month will be slowly advancing now. Take advantage of fine days to apply a little heat, and increasing the atmospheric moisture by sprinkling the paths, the plants being lightly syringed and afforded a proper supply of water at the roots. The night temperature must not greatly exceed 50° until the trusses are prominent, or they will be liable to become drawn and the flowers prove abortive.

Peaches and Nectarines.—Where forcing was commenced early in December the buds on the most forward trees are now fully expanded, and should be dusted on fine days with a soft brush to distribute the pollen. Where fermenting materials have been used the moisture arising from them in combination with the damping of paths will be sufficient, and syringing the trees will be unnecessary until the fruit is set. Keep the ventilators open day and night unless the weather be very severe, and even then they should be left slightly open at the top of the house constantly. The night temperature should be maintained at 55°, or 5° less in very severe weather, allowing a rise of 5° to 10° by day with fire heat, and 5° to 10° more from sun heat. Houses recently closed should have a night temperature of 45° to 50°, with a rise of 5° by day from fire heat and 10° to 15° from sun heat. Syringe twice a day, and allow a circulation of air constantly. If there be any aphides in the house fumigate before the flowers open. Complete the dressing of trees in late houses, and do not neglect the supply of water.

Cherry House.—The trees in this structure being started the day temperature by artificial means should be kept steadily at 50° to 55°, and the weather being fine it may be allowed to rise to 60° or 65°, but it must be from sun heat alone, admitting air more freely. Syringing must be attended to in the morning and early afternoon, and allow the night temperature to fall to 45° or 40° in severe weather. See that the borders are well moistened, as frequent syringing in houses is likely to mislead as to the moisture at the roots. This more particularly applies to trees in pots. The watering is essential in encouraging root-action, which takes place simultaneously with growth; indeed the root-action commences with the swelling of the buds. The water supplied should be about the same temperature as that of the house.

Pines.—Let every attention be given to the Queen plants which are about to be started for the London season, keeping them well supplied with the requisite heat and moisture. Maintain the night temperature at 70°, not allowing it to fall below 65° in the severest weather, 70° to 75° by day, and 80° to 90° under solar heat, closing the house at 85°, and giving a slight damping overhead about twice a week. Similar treatment will need to be given fruiting plants. In successional houses provide a mean temperature of 60° at night, 65° to 70° in the day, and 80° from sun heat. Suckers should have a temperature of 55° or a few degrees higher, and 60° to 65° by day. See to the supply of soil, as the time is fast approaching when properly prepared soil and other requisites will be wanted.

PLANT HOUSES.

Greenhouse.—Epacris, Erica hyemalis, and other early varieties that have been flowering in the conservatory and are past their best should be cut close back. Some care and attention must be devoted to these plants after removal from any structure that is warmer than the ordinary greenhouse, for if placed at once in a cold house they will be seriously checked. If possible give them a temperature of 45° to 50° according to the weather, and keep the house or pit in which they are placed a little closer for a few weeks. Ericas will not long endure a close atmosphere, and thrive best when once fairly started into growth with abundant ventilation. The former will be much benefited if encouraged by moderate heat in their early stages of growth when required for flowering in early winter, than to have to force them into flower when wanted. E. gracilis, E. Caffra, and others are very liable to the attacks of mildew. At its first appearance dew the affected parts with the syringe and apply sulphur. Avoid a stagnant damp atmosphere, which is detrimental to Heaths. These, as well as all hardwooded varieties, should be kept as cool as possible by free ventilation, and apply fire heat on fine days to expel damp.

Keep a sharp look-out for aphides, which will appear at this season upon Pelargoniums, Calceolarias, and Cincarias. This pest increases rapidly on these plants, and should at its first appearance be destroyed by fumigating with tobacco paper for two or three successive nights, which is preferable to one strong application.

Stove.—Gardenias that have been kept in a night temperature

of 60° up to the present have their flower buds swelling rapidly, and should, if grown in any quantity, be divided into two or three batches. The most forward should be placed where a rise of 5° at night can be given them, with a corresponding rise during the day. They should be syringed once or twice daily when the weather is favourable. The young plants that were rooted in autumn and kept in small pots can now be transferred into others 5 or 6 inches in diameter. The points of the shoots should be pinched out as soon as the roots take to the new soil. If young plants have not been prepared for an early start strong cuttings should at once be selected from the non-flowering shoots and inserted singly in thumb pots. The compost should be sandy peat for the cuttings, and then good fibry loam, to which should be added one 6-inch potful of bonemeal and half the quantity of soot to each barrowful of soil, and sufficient coarse sand to render the whole porous. After the cuttings are well watered they should be plunged into a bottom heat of 85° and covered with a bell-glass or handlight. Gardenias are free-rooting plants, and every cutting will quickly strike. From cuttings inserted and rooted at once fine plants will be produced in twelve months, carrying from twenty to thirty flowers each. Young plants propagated and grown annually are preferable to retaining old specimens. The oldest, or three-year-old plants, that have been retained for early flowering should after blooming be thrown away. Young plants under cultivation in pots grow more luxuriantly, and are in consequence less liable to the attacks of mealy bug and scale.

Gloxinias that have had a good season of rest can now be started. The old soil should be shaken from them and the tubers soaked in tepid water. After they have drained sufficiently they can be repotted in the same or larger pots, according to the size of the tubers. The drainage should be liberal and the pots clean, using a compost of loam, one-third leaf soil, and a seventh of decayed manure, with a liberal quantity of sand. Pot them firmly and place the pots where a temperature of 60° to 65° is maintained. *Caladiums* may also be started, using similar soil for potting.

Achimenes for early flowering should now be shaken out of the old soil and then placed in any light sandy soil in pans, watered, and placed in heat.

THE BEE-KEEPER.

EXCESSIVE SWARMING.

OWING to the many unfavourable seasons for bees during the last ten years many young apiarians are unacquainted with the difficulties of excessive swarming. Bee-keepers of longer experience know that in some seasons not favourable for honey-gathering bees are slow to swarm and seem unwilling to leave their parent hives, and that in hot and honey seasons they often swarm before they are fully ready, and even first swarms send off colonies or virgin swarms before their own hives are filled with combs. Bee-keepers are now more numerous than they ever were before, and, what is better, they are more enlightened than they were a few years ago; and though the past of their experience in many cases has been rather disappointing, they are still hopeful of a return of good bee seasons. I am one of the most hopeful, and believe that we shall have, as in olden times, warm seasons and heavy harvests of honey. When honey seasons do come bees will swarm often and readily, and many young apiarians will be perplexed. In such times swarms come off unexpectedly, and many are lost.

The preparations and arrangements which bees make for swarming have been explained by several teachers in this Journal. First swarms take the queen with them, but before swarming royal cells are formed and eggs placed in them, so that the parent hives shall not be long queenless after the swarms have left. First swarms never issue till royal cells are occupied by eggs or grubs. This is well known, and many bee-keepers try to prevent swarming by cutting out all the royal cells. The bees soon build more, place eggs in them, and swarm all the same. This practice of cutting out royal cells may be repeated again and again without finally preventing swarming. In hot seasons bees will swarm, and it is a difficult matter to thwart them while the swarming fever lasts, for sometimes they will set eggs in royal cells and swarm the same day; and if first swarms are cast back on the parent hives they will issue again within twenty-four hours. In such struggles between bees and their masters many swarms are lost. To prevent the loss of swarms some bee-keepers clip a wing off every queen, so that they cannot fly; but even this does not prevent swarming, for though the queens without wings cannot

follow the swarms, they leave their hives with them and fall over the flight boards and crawl about in front of the hives till the swarms return; but still swarming is not prevented, for if the queens crawl back into the hives the efforts to swarm will be repeated again and again. All this is not surprising, for it is as natural for bees to swarm in good seasons as it is for broody hens to seek nests. In hot honey seasons many second swarms are obtained, and sometimes three swarms issue from one hive. When the eggs set in royal cells come to perfection the piping sounds are heard; the young queens—one hatched, the others in their cells—pipe and bark at one another for three days and nights before second swarms issue. If all the royal cells but one are removed or cut out before piping commences no second swarms will issue. If this is not done, and second swarms do issue when not required, they should be cast back on the mother hives some hours after they left, and this will prevent further swarming, because all the queens will be destroyed but one, and the hives have no eggs at the time.

Though I am now going to mention the measures adopted to prevent swarming I do not wish the reader to believe that I manage my bees on the non-swarming system. In most seasons I follow the swarming principle, believing that it is the best and most profitable way of managing an apiary; but I try to keep swarming within proper limits. Many bee-keepers prefer the non-swarming system of management, and aim at great results in super honey.

Supering, or enlarging hives by supers, is the general mode adopted to prevent swarming, but this too often fails and swarms are lost; hence it is desirable to cut all the royal cells out of hives at the time supers are placed on them. This may be considered one of the best modes adopted for preventing swarming, and very often answers, especially in the Stewarton principle of supering. The bees, being deprived of their royal cells at the time, they find plenty of room added to their hives for expansion; they often abandon the idea of swarming and settle down to hard steady work for the whole season, filling one super after another.

Many artificial measures are adopted by advanced bee-keepers to prevent the loss of swarms in hot seasons. By artificial swarming I have been able to manage a large apiary for many years at a small expense of time and anxiety. If men know when their bees are ready for swarming, and also able to swarm them artificially in a few minutes, an apiary in their care and management is comparatively but a small undertaking; but untutored and inexperienced bee-keepers unable to adopt the artificial practice may well fear the loss of swarms in seasons of excessive swarming. As various modes of artificial swarming have from time to time been given in detail in this Journal I shall not go over the ground in this letter. I am anxious, however, for beginners to know and remember that in both natural and artificial swarming the parent hives are queenless for awhile after first swarms are taken or go from them. If two hives become ready to swarm about the same time one of them may be swarmed and placed a few feet to the right of the old stand, and the swarm as far to the left. The queen of the other hive ready to swarm could be taken from it and given to the one which has been swarmed. Thus swarming in both hives would be prevented for at least seventeen days; but the one which yielded the queen for the other would have young queens ready for piping and swarming on or about the seventeenth day after losing its queen. If we do not want second swarms at all we cut all the royal cells out of hives as soon as the queens begin to pipe, and this prevents piping and swarming too. If all the queen cells cannot be seen or reached while the bees are in the hive we drive them into an empty hive, remove the royal cells, and cast the bees back.

Again, if the bees in two hives are ready for swarming at the same time, and only one good swarm is wanted, we drive all the bees and queen from one hive into an empty one, and place the swarm on the same stand. Then we take a swarm at once from the other stock and cast the bees amongst the combs and brood, while yet warm, of the first hive. Thus the queens, combs, and brood of both hives are utilised, and swarming is prevented for about three weeks. Thus by a little skilful manœuvring swarms are not lost, and excessive swarming is prevented. In hot seasons and in the hands of inexperienced people swarms multiply too much. It would be better for them to put two or more swarms in one hive than have a great number hardly worth keeping or noticing. In most seasons and places one swarm is enough to take from each stock, and in the best of seasons and localities never more than two swarms should be taken from a stock hive, however excellent.

In order to prevent swarming in ordinary seasons large supers should be placed on hives before they are quite ready for swarming, and as much freedom of access to them as possible. Room

and ventilation tend to ward off the swarming fever. In wishing the bee-keeping community a happy and prosperous year I may say for their encouragement that seasons remarkable for swarming are generally remarkable for honey-gathering; that the weather which multiplies swarms fills the flowers with nectar and hives with honey. The apiarians of England are now anxious to have such a season, and ready to take advantage of it. When it comes many young bee-keepers will have a new experience, and many older ones will have stories to tell of greater success than they have yet known.—A. PETTIGREW, *Bowdon*.

BRITISH BEE-KEEPERS' ASSOCIATION.—The next quarterly conversation will be held in the board-room of the Royal Society for the Prevention of Cruelty to Animals, at 105, Jermyn Street (near Piccadilly Circus), London, S.W., at 6 P.M., on Wednesday, January 24th. Subject for discussion—"The Best Means of Instructing Cottagers in Bee-keeping." To be introduced by the Rev. W. E. Burkitt, of Buttermere Rectory, Hungerford.—HERBERT R. PEEL, *Hon. Sec.*

TRADE CATALOGUES RECEIVED.

Edmund Phillip Dixon, Hall.—*Catalogue of Garden and Farm Seeds for 1883.*

E. Mount, 154, Blackstock Road, Finsbury Park.—*Catalogue of Horticultural Buildings.*

Sutton & Sons, Reading.—*Pocket Garden Calendar for 1883.*

William Paul & Son, Waltham Cross.—*Catalogue of Flower and Vegetable Seeds.*

S. Dixon & Co., 34, Moorgate Street, London.—*Catalogue of Flower and Vegetable Seeds.*

Kelway & Son, Langport, Somerset.—*Annual for 1883.*



** All correspondence should be directed either to "The Editor" or to "The Publisher." Letters addressed to Dr. Hogg or members of the staff often remain unopened unavoidably. We request that no one will write privately to any of our correspondents, as doing so subjects them to unjustifiable trouble and expense.

Correspondents should not mix up on the same sheet questions relating to Gardening and those on Poultry and Bee subjects, and should never send more than two or three questions at once. All articles intended for insertion should be written on one side of the paper only. We cannot reply to questions through the post, and we do not undertake to return rejected communications.

Pruning a Black Alicante Vine (*A Young Gardener*).—According to your note the Vine at 4 feet from the ground has produced two canes each 10 feet long. The sample of wood you have sent is excellent and well ripened. A length of from 4 to 5 feet of such wood may be safely left for bearing fruit, but it does not follow that all the bunches that are produced should be permitted to remain and ripen.

Seedling Dipladenia (*J. G., Bristol*).—A plant such as you describe would be well worth preserving, for we do not know one of "shrubby habit," and it would prove valuable for culture in pots if, as you say, the flowers are larger than those of *D. boliviensis*. Send us a flower and leaf.

Mushrooms for the Million (*T. C. and others*).—The articles which have appeared in this Journal under the above heading will be published, with some additional matter on the subject, in manual form in the course of a week or two; indeed the matter is now in hand, and will be completed as speedily as possible.

Covering Walls in Orchard House (*W., Surrey*).—We have no doubt you could grow Figs and probably also Pears on the walls, but Apricots would be less liable to succeed. You do not state the height of the walls, and it depends on this and the height of the trees in the centre as to what extent the former would be shaded. We should plant strong cordon Pears 2 feet apart and train them obliquely, affording them the lightest position, a little shade being less injurious to Figs than to Pears.

Poultry Manure (*F. H., Guernsey*).—An addition of dry soil, so that the manure may be rendered friable enough to be passed through a fine sieve to enable you to distribute it evenly and thinly, will be much better than an application of sulphuric acid, and much cheaper. The addition of nitric acid would add to its value, just as an addition of any other plant-food would, but it is not usual to add nitrogen in any form to manure so rich in that substance as poultry manure is. Moreover, it is far cheaper in the form of nitrate of soda or sulphate of ammonia than nitric acid.

Dissolving Bones (*Idem*).—Eighty-five pounds of acid and 15 lbs. water used to damp the bones is the usual amount of acid employed by manufacturers. To render the resulting superphosphate dry sulphate of lime (plaster of Paris) should be used—not ordinary lime. The above manure should be applied to the surface in spring, and forked in very lightly. We do not advise you to mix this with the poultry manure.

Potatoes for Planting an Acre (*Vaux*).—The weight of tubers requisite for planting an acre depends entirely on the size of the sets that you intend using. At the distance you name about eleven thousand sets will be needed. If you weigh a sample of those you propose planting, say 1 cwt., or any other given quantity, you can determine with considerable exactitude the weight of seed to purchase.

Forest Tree Seeds (*Idem*).—As the firm you name is unable to supply seeds of the American trees you require, we can only suggest that you apply to such American firms as Messrs. Ellwanger & Barry, Mount Hope, Rochester; P. Henderson & Co., 35, Cortland Street, New York; or Hovey & Co., 16, Market Street, Boston.

Insects on Fruit Trees (*W. J.*).—If you dissolve 4 ozs. of softsoap, nicotine soap, or Gishurst compound in a gallon of water, then add a lump of soda as large as a walnut, and a wineglassful (two fluid ounces) of petroleum, apply this to the trees as hot as the hand can be borne in it, scrubbing the branches well and working the solution into the crevices, we think few insects will survive; or you might try the tar remedy, as described for Vines by Mr. D. Murray on page 547; or what has been suggested as an improvement on it by a correspondent on page 596, last volume. With all these remedies at your disposal it will be your own fault if the insects are not destroyed.

Orchard House Ventilation (*J. E.*).—The method shown so clearly in your sketch we think very good, and we have no doubt it will answer your expectations. Relative to the Peaches, Alexander has large flowers and round glands; Nectarine Peach large flowers, small kidney-shaped glands; Early Ascot small flowers and round glands. The Dymond Peach has large flowers, but we have no record of the glands, nor of the flowers and glands of the Marquis of Downshire. Probably the nurseryman from whom you obtained the trees would supply you with the information, or possibly some of our readers may be able to do so.

Wintering Fuchsias (*Wood Broughton*).—Such old plants as you describe may be wintered safely under a stage of a greenhouse from which frost is excluded. They are no worse, but better for losing their leaves, as light then is not needed, and only sufficient water for keeping the shoots fresh and firm. This if given about once a week, will suffice. In the spring when the buds commence swelling, moderate pruning will be required, and shortly afterwards, when the growths are from a quarter to half an inch long, the plants should be shaken out of the pots, removing all the old soil from them, repotting in fresh compost in smaller pots, and by syringing daily in bright weather and applying water judiciously, cautiously at first until fresh roots have formed, and afterwards more copiously, you will soon have fine plants if they are grown in a light position. They can afterwards be shifted into larger pots or planted in the garden according to the purpose for which you may require them. The publication of this and the following reply was accidentally omitted last week.

Pruning Black Currants (*A Bristol Inquirer*).—You say you have been accustomed to prune Black Currants the same as Gooseberries are pruned, but now you have taken charge of bushes that you describe as being grown on the "long-rod system," and you wish to know which course to pursue. Our advice is that you follow the "long-rod system" and relinquish the practice of spurring, which is unnatural as applied to this fruit. We know Black Currants may be produced on the short-spur system just as Morello Cherries and Peaches can by the same method of pruning, but full crops of the finest fruit are more certain and easily obtained by retaining the young wood when the growths have been sufficiently thinned for the foliage to be fully exposed to the light and air. Thin out the branches of the Black Currants if the bushes are crowded, and encourage the production of young wood. These annual shoots do not shorten beyond removing the tips from any that are growing out of place, or for imparting to the bushes a neat appearance, and you will then have larger crops of finer fruit than you can obtain under your former method of pruning. Black Currants are not suitable for growing as cordons for covering a wall. They will cover a wall well enough, but should be trained like Peaches—that is, have a selection of the best young shoots secured to the wall in the summer at distances of about 6 inches apart, removing the others entirely, and not shortening those retained. Certainly try both the methods of pruning Gooseberries to which you refer, and you will gain experience that will be useful. The right method of pruning can only be determined by the condition of the bushes. Some are under-pruned and others over-pruned, and you will act wisely to find out the method that answers the best with those in your keeping.

Propagation of Chimonanthus fragrans (*F. H., Devon*).—This shrub is very difficult to propagate, and it is said that Professor Lindley once offered a guinea for every cutting that could be rooted. That mode of increase is, however, very unsatisfactory, though a few instances of success have been recorded. The best results appear to have been attained when cuttings of the young partially matured wood were taken in the early summer and inserted in sandy soil in a cool shady position. Layering is also practised, the process being similar to that adopted with other shrubs, but even this is often attended by failure. Seeds would appear to be the safest and surest method of increase. But here there is another difficulty: the flowers are not self-fertilising, and unless care is taken to insure artificial fertilisation no seeds will be perfected. This is chiefly due to the fact that the anthers are what is termed extrorse—namely, the portion bearing the pollen is turned away from the pistil—namely, towards the circumference of the flower, and at the time when the plant flowers in England there are no insects to convey the pollen to the stigma. Your best course would be to procure young plants from a nurseryman who makes a speciality of shrubs.

Treatment of Calanthe Veitchii after Flowering (*R. C. D.*).—After the flowers have faded the plants will require a good season of rest, withholding water until growth is observed to be commencing again. That is the best time for potting, employing a compost of peat, light loam, and well-decayed cow manure, with a little sand, the peat forming the chief part of the mixture in bulk. Drain the pots carefully, and over the crocks place a layer of sphagnum moss, then a little of the compost, and upon that the pseudo-bulbs, filling up with the compost to within about an inch of the rim of the pot. To encourage vigorous growth the plants must have a position in the stove or similar warm house; and as a light position is requisite, they are usually placed upon a shelf near the glass, but where shade can be afforded in bright sunny weather. Supply water liberally while growth is advancing, weak liquid manure being also beneficial if given occasionally. During the period of flowering less water will be needed.

Vegetables for Market (*Co. Down*).—Knowing nothing whatever of your soil, nor the adaptability of the district for vegetable culture, we are unable to give a categorical reply to your question. We have no doubt if the soil is fertile and the locality favourable to the production of early crops that a competent and industrious man might succeed fairly well in growing vegetables for the Liverpool market; but it would be advisable to make inquiries of

vegetable salesmen and greengrocers there as to the vegetables most in demand and the prices that are usually obtainable, also to procure information as to the cost of transit from the ground to the market. As you say the vegetables would be grown by a "professional man," he ought to be competent to judge, after making the inquiries we have suggested, what kinds it would answer best to cultivate. Much forethought is requisite in work of this nature, as it is not uncommon for the inexperienced to produce good crops of a particular vegetable just when the market is overstocked and the prices consequently low. Much labour has been wasted and money lost by accidents of that kind. Be first in the market with good produce and you will find vegetable-growing profitable, otherwise you will not find the occupation equal your expectations.

Gladioli for Scotland (Ayrshire).—The following notes on culture and selection of varieties by a successful Scottish cultivator will answer your inquiry:—About the middle of February, if favourable weather be had, trench your ground to a depth of at least 2 feet. See that the drainage be satisfactory, and incorporate with the soil some well-decayed manure. We believe cowdung is, on the whole, the best. Keep this at sufficient depth to avoid immediate contact with the corms, and if the soil be already in good condition do not enrich it too much. Weak liquid manure can be applied with more safety as the plants progress. About the middle of March, if the weather allow, plant the corms a foot apart each way, the smaller about 4 inches, the larger 5 or 6 inches deep. Rather delay for a week or two than plant in soil saturated with wet. Place each root in sand and cover it with it. Beds of three, or at most four rows, allow of the plants being easily reached for the purpose of staking, shading, &c. The former should be attended to by the time the plants begin to run to flower. The latter is essential to having clean and well-furnished spikes. Planted at the depths given watering will in your district be little needed, unless in exceptionally dry seasons. The following are twenty-four leading competition varieties of moderate price:—Adolphe Brongniart, Camille, Carnation, Celimene, Daubenton, De Mirhel, Giganteus, Horace Vernet, Jupiter, Leander, Le Phare, L'Unique Violet, Mary Stuart, Matador, Meyerbeer, Mons. Legouvé, Murillo, Norma, Ondive, Orpheus, Pauorama, Pictum, Primatice, and Shakespeare. Should you wish you may safely add or substitute any of these six dearer sorts—Archduchesse Marie Christine, Baroness Burdett Coutts, Eclair, Flamingo, Marquis of Lothian, Victor Jacquemont.

Edgings for Carriage Drives (W. A. Newton).—The question of edgings is very much a question of cost. We presume you desire a permanent earthenware edging, in which case you cannot do better than write for a priced illustrated catalogue from those firms who advertise them in our columns. In some places bricks placed diagonally are largely employed as edgings. The following description of this plan was forwarded to us many years ago by Mr.

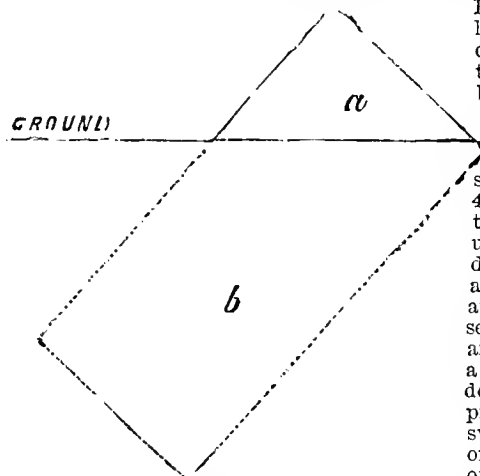

Fig. 10.

a, The corner of brick forming the edging. hard.
b, The hurried portion of the brick.

Rohson:—"For many years I have been in the habit of using common kiln bricks as an edging to walks through dark shrubberies and similar places. These are laid in a diagonal position—one edge and one flat side presenting each an angle of 45° to view, or, in other words, they are laid with an angle-edge upwards, thus—and, being placed deep enough in the ground to allow only about 2 inches of the angular side of the brick to be seen, its appearance is pleasing, and it is not easily moved; even a wheelbarrow driven over it does no further damage than chipping the angles off a little; and sweeping and all the other ordinary work of cleaning a walk only improve its appearance." The bricks should be burned

Inarching or Bottle-grafting Vines (Gardener).—You need have no difficulty in carrying out your object, and you will find full instructions for doing so in No. 617, the issue of January 23rd, 1873, which can be had from the publisher in return for 3½d. in postage stamps, quoting the number and date that we have submitted. We cannot detail the practice so fully in this column as we will find recorded in the number in question.

Peach and Fig Trees in Vinery (R. H. R.).—We gather from your letter that you propose growing the trees in large pots or tubs. You may very well do so, and with good cultural attention, and especially preventing red spider becoming established on the Peach, you may succeed in producing a few acceptable dishes of fruit without in the slightest degree injuring the Vines. Until the Vines cover the roof and cast a heavy shade below you can ripen the Peaches and Figs in the house if you choose, or you can remove them to the greenhouse, or even plunge the pots in a warm position out doors after the fruit is set. If the crop is allowed to ripen under glass it will be well to place the trees in a sunny position in the open air, plunging the pots or tubs, and applying water as may be necessary for maintaining the health of the trees. We are acquainted with a vinery in which a Peach tree is ained close to the glass at the end of the house, the roots being outside, and though the roof is covered with Vines, from six to ten dozen of fine Peaches are gathered from the tree yearly. The gardener takes care to permit no red spider to infest the tree, and consequently he has none on the Vines, but instead a very fine crop of Grapes annually. Some years ago we planted and trained a Fig tree similarly, which has since produced thousands of excellent fruits without interfering with the Vines in any way. You cannot have a more useful Fig than the Brown Turkey, nor a better Peach than Grosse Mignonne.

Name of Plant (R. H. D.).—Tussilago fragrans. See note on page 28. It is a native of Italy, but has been in this country since the commencement of the present century. It is commonly termed the Sweet-scented Coltsfoot.

Dead Queen (E. T.).—At this season bees have no eggs and cannot rear a queen to replace the one you found dead on the flight board. Even if a queen could now be bred she would, in the absence of drones, remain unfertilised and be useless. The bees of your hive should be united to another stock having a queen, or otherwise the bees and queen of a less valuable hive united to it.

The work of uniting bees at this cold season is best done by candlelight in a hothouse or warm room of a dwelling-house. First sprinkle a little warm syrup over the bees or on the combs of bees to be surrendered about sunset. Close the door of the hive and take it into a dark room for an hour, the bees will then be all astir and easily shaken from the combs or the hive. Smoke the bees a little, lift out the bees singly and rapidly, and with a hand-brush sweep the bees from the combs into an empty hive, keeping the candle as much out of sight as possible. All this is but the work of two or three minutes. The hive to receive the bees, previously treated with syrup like the other, should be placed on and over the bees. The candle should be put out and the bees left to unite and fraternise. We have practised this mode of uniting bees in cold weather in scores of instances, and never once failed. The only risk is in losing a few bees that fly to the candle. But in the hands of an expert the work is so speedily done that the bees seldom have time to fly. Hives with fixed combs are treated differently. By giving them a sudden jerk or two all the bees fall from the combs to the floor, when the hive to receive them is placed over them.

COVENT GARDEN MARKET.—JANUARY 10TH.

We have been badly supplied during the week with fruit generally, excepting Grapes, which have barely maintained Christmas quotations. Vegetables plentiful.

FRUIT.

	s. d.	s. d.		s. d.	s. d.
Apples.....	½ sieve	2 0 to 7 0	Grapes	lb.	2 0 to 5 0
".....	per barrel	20 0 40 0	Lemons.....	case	10 0 20 0
Apricots.....	doz.	0 0 0 0	Melons.....	each	0 0 0 0
Cherries.....	½ sieve	0 0 0 0	Nectarines..	dozen	0 0 0 0
Chestnuts.....	bushel	10 0 12 0	Oranges.....	100	6 0 10 0
Currants, Black..	½ sieve	0 0 0 0	Peaches.....	dozen	0 0 0 0
" Red.....	½ sieve	0 0 0 0	Pears, kitchen ..	dozen	1 0 2 0
Figs.....	dozen	0 6 1 0	dessert.....	dozen	1 0 2 0
Filberts.....	lb.	0 0 0 0	Pine Apples, English	lb.	1 6 2 0
Cobs.....	100 lb.	5 0 5 0	Raspberries.....	lb.	0 0 0 0
Gooseberries....	½ sieve	0 0 0 0	Strawberries....	lb.	0 0 0 0

VEGETABLES.

	s. d.	s. d.		s. d.	s. d.
Artichokes.....	dozen	2 0 to 4 0	Lettuces.....	score	1 0 to 1 6
Asparagus.....	bundle	0 0 0 0	Mushrooms.....	punnet	1 0 1 6
Beans, Kidney....	100	1 0 0 0	Mustard & Cress ..	punnet	0 2 0 3
Beet, Red.....	dozen	1 0 2 0	Onions.....	bushel	2 3 2 6
Broccoli.....	bundle	0 9 1 6	Parsley.....	doz. bunches	3 0 4 0
Brussels Sprouts..	½ sieve	1 6 2 0	Parsnips.....	dozen	1 0 2 0
Cabbage.....	dozen	0 6 1 0	Peas.....	quart	0 0 6 0
Capicums.....	100	1 6 2 0	Potatoes.....	cwt.	6 0 7 0
Carrots.....	bunch	0 4 0 0	Kidney.....	cwt.	6 0 8 0
Cauliflowers.....	dozen	2 0 3 0	Radishes....	doz. bunches	1 0 0 0
Celery.....	bundle	1 6 2 0	Rhubarb.....	bundle	0 4 0 0
Coleworts.....	doz. bunches	2 0 4 0	Salsafy.....	bundle	1 0 0 0
Cucumbers.....	each	1 6 2 0	Scorzonera.....	bundle	1 6 0 8
Endive.....	dozen	1 0 2 0	Seakale.....	basket	1 0 2 0
Fennel.....	bunch	0 3 0 0	Shallots.....	lb.	0 3 0 0
Garlic.....	lb.	0 6 0 0	Spinach.....	bushel	3 0 0 0
Herbs.....	bunch	0 2 0 0	Tomatoes.....	lb.	0 8 1 0
Leeks.....	bundle	0 3 0 4	Turnips.....	bundle	0 2 0 3



POULTRY AND PIGEON CHRONICLE.

GOAT FARMING.

AMONGST other matters which are coming forward at the present time Goat farming is becoming prominent with amateurs, but it is likely also to attract more attention than it has done amongst farmers who may be so situated as to be able to turn it to advantage. It will, however, no doubt, receive most notice from those engaged in what we call suburban villa farming; still, there is an opportunity for the home farmer in some situations to profit by the management of Goats under special circumstances and in particular situations. We propose, therefore, to place before our readers such information as we have been enabled to obtain in connection with the subject, which may be not only interesting to amateurs but profitable to the farmer. We shall not only explain our opinions, but also the best and most advanced practice of those who have taken a decided interest in the matter, and who have valued the Goat as an animal capable of furnishing milk, meat, and mohair. From these items the public and consumers have not hitherto obtained much benefit; it, however, remains to be seen how far their requirements in this direction can be met by farming this kind of stock. As, however, a Goat Society has been formed, we assume that an amount of enterprise and spirit will be called into operation, so that the



18th	TH	Royal Society at 4.30 P.M., Linnæan at 8 P.M.
19th	F	
20th	S	
21st	SUN	SEPTUAGESIMA.
22nd	M	
23rd	TU	
24th	W	Society of Arts at 8 P.M.

ON RIPENING AND PRESERVING PEARS.

THE question is asked by "Wiltshire Rector" (page 566) of the experience of other fruit-growers, whether they have noticed a change of season in the ripening properties of many of their Pears, and "what can be the reason why a Pear should be ripe three months before its time in spite of its being kept in a cold fruit-room?" Now I confess I should be far more surprised than I am at not a single reply being given on a subject of such universal interest—for how seldom at dessert is a dish of well-ripened late Pears allowed to pass!—were it not that I have long noticed, as one taking a somewhat practical interest in these matters, that, put poetically, a flash of silence is all that follows. Except perhaps it be a short or very occasional notice of the relative merits of one Pear over another, our horticultural journals do not compare the experience of fruit-growers as they ought, very profitably to themselves and the public, on this most delicious of all luxuries. In spite of the editorial note appended to "Wiltshire Rector's" question, I venture in all humility to send you a few remarks, more in the way of challenging discussion than for a moment imagining I am giving a definite solution.

With the great majority of medium and late Pears of the two last unfavourable years, the constituent properties of the fruit was so bad, so manifestly deficient in the development of those gradual chemical changes so essential to their proper keeping, that this fact alone is almost a sufficient answer. Most Pears I assume, as grown of late, with few exceptions, except in highly favoured localities, were gathered as unripe or crudely developed Pears, however apparently full-sized and healthy, and as such incapable of keeping long even under the most careful and intelligent treatment. It is a matter of my own sad experience that not a tithe of my deficient crop of Pears survived the second sorting, and from what I hear this generally was the case. I give the following illustration from a useful publication, "The Chemistry of Daily Life" (Johnson and Church), as showing up to a certain point my meaning here.

"The ripening Pear (or Apple) presents us with an illustration of special chemical changes proceeding continually in the plant to a specific and useful end. The unripe Pear shrinks in, refuses to retain its natural size, and cannot be kept for any length of time. The effects are the consequence of the thin bark which covers the fruit not having attained its matured com-

position. While unripe this coating is porous and pervious to water, so that when moved from the parent plant the fruit gives off water by evaporation to the air, and this shrivels and shrinks in as has been described; but when ripe this porous covering becomes chemically changed into a thin impervious coating of cork, through which water can scarcely pass, and by which, therefore, it is confined within for months together. It is this corky layer which enables the winter Pear or Apple to be brought to table in spring of their full natural size."

On the hypothesis that Pears this year are gathered in the situation of Pears before they are ripe, this statement affords a solution to "Wiltshire Rector's" questions, but only to a certain point—viz., in pointing to the deficiency of gradual chemical change in the development of the fruit; other and more important chemical changes must take place in the constituent properties of a Pear to insure a healthy and reliable ripening of the fruit in its due season.

Popularly and broadly stated, as regards the bad effects on such fruits as Pears ripening and keeping well during the two last unfavourable seasons, it may be laid down that there was too little saccharine matter as an element of preservation and too much water as an element of decomposition. However, according to the latest scientific discoveries on the subject it has been for some time quite recognised as an established fact, that well-defined and even classified and named microscopic organisms of the family of the yeast plant attach themselves to the external surface of all fleshy fruits, such as Apples and Pears, at the season of ripening: some adapted to aerial growth, while others are capable of living when submerged in fluid. These Saccharomyces, or Sugar Funguses as they are called, exist principally by feeding on the decomposition of the saccharine matter with which they come in contact. Thanks to M. Pasteur, this knowledge that all healthy ripening and preserving properties in such fruits as Pears and Apples is connected with the growth of fungus yeast by a process of insensible fermentation, is capable of illustration. This distinguished French chemist obtained these fungus germs by washing ripe fruit with chemically pure water, which was rendered slightly turbid by the presence of myriads of small particles, such as atoms of dust, &c., including what seemed to be spores of funguses.

These particles, widely in appearance differing among themselves, M. Pasteur cultivated in saccharine fluids. When under the microscope he was able to determine them as the true yeast plant or sugar-eating funguses, all differing from the other in size of cells, shape, and growth.

Such living organisms, modern science thus clearly demonstrates, contribute to the life from whence they themselves derive their life-growth. If further illustration were necessary it might be found in this way. If, instead of affording saccharine fluid for these yeast plants' or sugar funguses' use, a solution, say, of gum was used, no sensible effect would take place; and why not? In the one case the minute plants have met with food congenial to them, in the other they have found nothing on which they could thrive and grow.

This is just the condition of the present Pear crop in the main during the late cold and sunless seasons. The low temperature and thin watery juices have failed

in affording nourishment in the shape of saccharine matter which the sugar funguses require, while they in their turn have given way to various other species of false or diseased funguses, producing the result which the "Wiltshire Rector" and his brother fruit-growers deprecate in capricious and often very precocious maturation.

Two significant lessons seem to come of the above remarks. (1) To grow only or mainly those superb all-round varieties of Pears like Doyenné du Comice, whose superabundance of sugar can cope with a season like the present; and (2nd) wherever and however fruit-repositories may be chosen, not to have them too dry, this being far more important than temperature, when sooner or later the fruit may ripen; but with too excessive evaporation in the case of substances of such different densities coming into action as air and water, no precaution with fruit of inferior juices in a wet season can help shrivelling and imperfect maturation.—HEREFORDSHIRE INCUMBENT.

ODONTOGLOSSUM ALEXANDRÆ.

ONLY a few years ago it was generally impressed upon the minds of most persons that the cultivation of Orchids entailed a large amount of trouble, and that they of all plants were the most difficult to manage. This notion and the enormous price at which they were sold prevented many from obtaining them, and those who did grow them and attained a fair amount of success were regarded as having achieved the masterpiece of gardening. Tens of thousands of Orchids have been collected and imported to this country during the past few years in fresh condition, and they can now be obtained for a few shillings each, thus being within the reach of all who possess a garden and a greenhouse. The idea that they are difficult to grow is still prevalent with many; but this is not the case, although it applies to certain species and varieties, and the supposed difficulties attending the management of some of the most handsome and useful kinds I hope in a few years will have died away.

Odontoglossum Alexandræ is one of the easiest, cheapest, and most lovely Orchids that can be grown. If I was confined to the cultivation of one variety I should choose this one. It has graceful arching flower spikes, which are freely produced, and many of the varieties are beautifully spotted with crimson, purple, and brown spots, which show to great advantage on the pure white ground; others are slightly suffused with pink or rose, while some are conspicuous for their spotless purity. This Orchid is now very popular, and there can be no doubt that its popularity is rapidly on the increase, and in a few years will be as freely grown in the majority of gardens as Zonal Pelargoniums are at the present time. Already we find it in hundreds in some gardens, and no better plant can be grown where choice flowers are required during the winter.

The flowers last for five or six weeks, and their usefulness in a cut state is too well known to need any remarks from me. But not only are the flowers useful in that way, but the plants when in flower can be used for a variety of decorative purposes. It will safely bear removal without injury from the house in which it is grown, and will stand in rooms for at least three weeks where gas is not employed and cold draughts kept from the plants. When arranged in the conservatory few plants have such an elegant appearance with their graceful arching flower spikes standing well above other plants. If the hot-water pipes are directly under the stage and dry the plants quickly, it is a good plan to place under them a shallow pan of water in which is inserted a flower pot for the pot in which the plant is growing to stand upon.

Imported plants I have found do the best when obtained either during the winter or in early spring, and if they have not started into growth on the journey so much the better. If the pseudo-bulbs are fresh and plump when they arrive the plants are almost sure to start freely and make a good growth the first season. If, on the other hand, the back pseudo-bulbs are much shrivelled, they seldom grow vigorously, and often remain small for a very long time; in fact I would not purchase such, because abundance are now landed in this country in the best condition, and upon this depends much of the rapid develop-

ment of the plants afterwards. After they are first received the dead roots and decaying pseudo-bulbs that may be upon them should be removed, and the plants laid thinly in pans or sieves in a shady part of a house where the night temperature is maintained at about 50° until they show signs of starting into growth. At first the moisture of the house will be sufficient, but after ten days or a fortnight they should be lightly syringed two or three times weekly. As soon as they commence growing they should be placed in 2½-inch pots, in fact the smallest pots the pseudo-bulbs can be secured in, as I have found them do better than when larger pots are employed. The pots should be about one-third filled with small crocks for drainage, and the remaining portion filled with fibry peat, from which the smallest particles have been shaken, and clipped living sphagnum moss, used in about equal proportions. The pots should be filled a little above the rim, and the pseudo-bulbs firmly secured on the top. If they have not sufficient roots to hold them firmly, a small stake can be placed between them and into the material used for potting. They should then be placed closely together, so that they will be convenient for syringing until they have well started into growth.

When once fairly started into growth, if the pseudo-bulbs were fresh they quickly commence forming roots, and are then top-dressed with sphagnum moss, and the plants watered, as I shall detail in a future issue for established plants. Some of the plants will grow more rapidly than others, and soon form their first growth and then start again vigorously, and require 3-inch pots before the summer is over. Others will only make one growth the first season, but the majority will throw small flower spikes, on which we only leave one flower just to see what the variety is like. It is a mistake to leave more flowers upon these small plants or allow the one to remain long, for I am convinced that it weakens them materially. Those plants that have made a second growth will very often produce a very fair spike with five to seven flowers upon it, but will be later than those that make but the one bulb.—W. BARDNEY.

(To be continued.)

ECONOMICAL MANURING.

HAVING in my last letter (page 590, last vol.) attempted to prove that applying manure during autumn and early winter was generally a mistake, the all-important question now is, How can it best be preserved till the time is favourable for its application without any material loss, and at the same time that it shall be so far decomposed as to be available immediately for the sustenance of the crops for which it is applied?

What I have for manure—and I am afraid many other gardeners are just as badly off—is simply the straw which has been used one night in the stables in which carriage horses are kept, the urine from which mostly passes away in the drains, and the droppings I am obliged to collect for the purpose of growing Mushrooms. There is then very little besides the straw itself to act as manure, and if this were left to become violently heated or much washed with the rains the support it would give to growing crops would be small.

The best plan I know is to mix the fresh material with some which is partly decayed, and turn it frequently during the winter. In my case I have a quantity of fresh litter to apply at each turning—say once a fortnight till the end of January, and I find that in the short time between the turnings all the fresh material is so far decomposed as to be scarcely distinguishable from that which has lain together six months, so fast does decomposition help decomposition. The fresh material is never added in sufficient quantity to produce violent heating, and the old material supplies ample moisture to keep all in such a condition that it will absorb all or nearly all the rainfall, so that there is little or nothing washed away, and the combustion being slow, gradual, and continuous, there is little or nothing carried away by the atmosphere.

While the manure has been accumulating another heap consisting of refuse soil, weeds, lawn mowings, &c., has also been formed. This, too, is turned up together to assist decomposition. Then there is some harder material in the shape of prunings, Asparagus roots which have been forced, Cabbage stumps, tops from the strong-growing Potatoes, &c., which

require the action of fire to bring them speedily into condition for manurial purposes.

I believe I use these most economically by putting them in with the clay which is burned in great quantity every winter; but clay is not burned in every establishment, and then it is advisable to have a slow fire for the purpose of bringing these harder materials into manageable form. The fire must be a slow one, and the materials burned without admitting more air than is necessary for combustion, or much of their valuable properties will be lost. It should be kept banked up with refuse soil, and be simply allowed to smoulder.

We have now three heaps differing considerably in their constituents and also in their texture, and the most economical way of using them is to mix them all together before applying them to the land. It may seem a good deal of labour to do this, and will be beneath the notice of those who can have as much manure from a covered cattle yard as they like to use, but to others situated like myself it may be worth considering. And as good crops are produced by these and similar means, it follows that where they are not utilised and labour is cheap there must be some waste.

On large estates there are generally opportunities for collecting leaves in quantity, and these when decayed make an excellent dressing for the land. I used to collect them in autumn and winter to mix with the litter received from the stables, and thus add materially to the size of the heap; but I think the leaves are made better use of now by allowing them to decay where they fall or where they are blown to (of course I am not recommending this practice near the mansion or in dressed grounds), and then the naturally made leaf soil is collected from the little hollows, which for some reason not quite clear to myself is very much better in quality than any leaf soil which can be made after the leaves are collected in heaps. Perhaps it is these very heaps which spoil it. The quantities which are blown together in the woods are comparatively small; the air and rain can act on them, and the birds by scratching them about not only assist in aerating them and breaking them up, but they prevent slugs, worms, &c., accumulating, as they are apt to do when the material is collected in large heaps. The leaf soil thus obtained is not, of course, mixed with the manure for growing Cabbages and the like; it is used for a few favoured plants, but it ultimately finds its way into the garden.

I commend the Crown Manure Company for their attempt to help those situated like myself with regard to the manure question. Their "improvers," if made in a scientific manner, ought after a few experiments to be just the thing for us to mix with the manure heaps I have attempted to describe, and I should think that guessing what they are likely to be short of would not present great difficulties to the chemist. I may tell those of your readers who are not aware of the fact, that artificial manures can be used most economically and with the best results when they are used in conjunction with natural manures, or on soils where the remains of former applications of natural manures are present in quantity.—WM. TAYLOR.

NEW AND CERTIFICATED PLANTS OF 1882.

MESSRS. H. CANNELL & SONS, SWANLEY.

THE "Home for Flowers" has gained a world-wide fame for the most popular of plants—florists' flowers; and the advance effected in many of these in recent years, which has been directly or indirectly due to Mr. Cannell's attention, is considerable. All the best of softwooded indoor plants, such as Pelargoniums, Primulas, Begonias, Cinerarias, Fuchsias, and many others, have been submitted to a course of improvement; and to the satisfactory results obtained, exhibitions in all portions of this country, and gardens in both the old and new world, have amply testified. As one stage in this onward career it may be well to note the novelties that made their appearance from Swanley during the past year, and also some of those which will be placed in commerce during the present year.

FUCHSIAS.—As one of the classes of plants to which Mr. Cannell first gave his attention the Fuchsias merit prominent notice. Novelties, however, are not numerous amongst these now, and apparently so great a degree of perfection was obtained in the past that there is little room left for improvement. A few are

occasionally added, and well merit the attention of growers and lovers of Fuchsias generally. One of last year's novelties is Nellie Morton, a seedling from the well-known Miss Lucy Finnis, and with similarity of habit and colour, differing, however, in the flowers being less double and in smaller clusters, so that the branches are more erect than in Lucy Finnis. It is very free, graceful, and attractive, and will no doubt become as great a favourite as the older form. A variety that will be sent out during the present year is Mr. Rundell, which was raised by Mr. Todman, and is an improvement on Earl of Beaconsfield. The great recommendations of the novelty in comparison with the older variety



Fig. 11.—Chrysanthemum Star of Whyke.

is the better form of the flowers, its quick growth, and free-flowering qualities, in other respects it is similar to that.

PELARGONIUMS.—Continued progress is being made with these plants in nearly all sections, and their numbers are increasing extremely fast. The chief difficulty now is in selection, as few can grow one-tenth of the really good varieties offered, but the advantage of having so many to select from is that most varied tastes can be suited. Zonal Pelargoniums have deservedly received much attention in recent years, and at Swanley the large collections of both single and double varieties afford abundant evidence of their usefulness. For two very pretty single varieties Messrs. H. Cannell & Sons were awarded certificates in 1882, and the honour was well bestowed. These are Improved White Clipper and Mrs. Gordon. The former, as its name indicates, is an

improvement on White Clipper, with large trusses of pure white well-formed flowers that are produced very freely; and the other has brilliant scarlet flowers with a well-marked white eye which renders the scarlet hue still more striking. During the present season a dozen new round-flowered Zonal varieties are to be sent out from Swanley. Six of these were raised by Mr. Windsor—namely, Snowball, white; Mrs. Naish, bright red, like Mrs. Moore; Mr. C. L. Teesdale, scarlet; Bayswater Burley, salmon, white eye; Peter Henderson, reddish salmon; and Mr. G. Brunning, deep red. Five are from Mr. George—viz., Emperor, crimson scarlet; Favourite, cerise scarlet; Edith George, reddish pink; Surrey Scarlet, and Crimson Gem; while one, Kate Greenaway, was raised by Mr. Harrison Weir, and resembles Lizzie Brooks. All these are distinguished by the fine form of the flowers.

In other sections of Pelargoniums several handsome varieties are ready for distribution. As a bedding variety Miss Blanche is likely to prove very popular, the colour being a rich purple-pink, and the flowers in large trusses. In the Hybrid Nosegay section Aurore Borcale and Gloire Lyonnaise are the best, the former light scarlet and the latter rosy-scarlet. Amongst the Ivy-leaf forms the grand single variety Masterpiece, with rich crimson flowers, and the doubles, Jeanne d'Arc, white, and La Rosière, rosy-lilac, are the best. Double and single Zonals from Lemoine include what may be termed the Egyptian series—viz., double, Admiral Seymour, Khedive, and Sir Garnet Wolseley; single, L'Egypte and Tel-el-Kebir, of varied colours. Show and Regal varieties are also represented by several novelties of merit.

CHRYSANTHEMUMS.—An enormous collection of these is grown at Swanley, comprising nearly all the named varieties in cultivation. Three very striking additions were made to them last year. Lord Wolseley, which was certificated at Kensington and several Chrysanthemum exhibitions, is a distinct sport from Prince Alfred, with large handsome blooms of a peculiar bronzy hue. It will undoubtedly become a favourite exhibition variety. Mrs. John Crossfield is a sport from White Globe, with large, well-formed, pinkish blooms, and it was certificated at Liverpool. The last of the trio is styled by Mr. Cannell "a double Pompon," under the name of the Star of Whyke. It is, however, larger than ordinary Pompons, as the woodcut (fig. 11, p. 45) shows, and is chiefly remarkable for its floriferousness and the long period during which it blooms, being one of the latest, continuing to near Christmas. It possesses all the characters of a really useful variety, either as affording a supply of flowers or for decorative purposes. Another useful late variety is Mrs. Carey, which is flowering at the present time. It is very distinct from other varieties, and, as Mr. Cannell states, "it will not bloom until it has had its Christmas holiday."

DAHLIAS.—A collection of similar extent to that of the preceding is one of the Swanley features; Show, Fancy, Bouquet, and single varieties being largely represented. Of the last, however, it is only necessary to speak here, as it is to these that the chief additions have been made. Of the Gracilis type, one of the best of all the singles, the forms luteo-nana, yellow; rubro-nana, bright scarlet and concinna, orange scarlet, are very notable. Three fine single varieties were certificated at Kensington—viz., Marguerite, deep rose; Tyro, purple shaded; and Yellow Gem, bright yellow. Those are of a taller-growing race than the preceding, but the blooms are of excellent form. Seven new and beautiful varieties have been selected for distribution from a large number of seedlings. Many others of equal merit, such as the "White Juarezii" Constance, are also included in the forthcoming novelties.

PRIMULAS.—The Swanley Red, Purple, and White strains of *Primula sinensis* have established their fame, but fresh varieties are being constantly added. One that was certificated last year—namely, Princess of Wales, is unquestionably one of the most distinct, delicate, and useful of the recent improvements. The flowers are flushed with a soft pink tint, and are borne in large compact trusses well above the foliage. A most distinct Primrose, and one the utility of which is already being widely recognised, is Harbinger, which Mr. Cannell has secured for distribution. The flowers are much above the ordinary size, white with a deep orange eye—a striking contrast; and as it shares the free character of its relatives it may be relied upon as useful either indoors or out.

ABUTILONS.—The valuable qualities of these plants for winter decoration are now well known, but their popularity is still increasing. Six of the best of Mr. George's seedlings have been selected for sending out in 1883, and they maintain the high character for which the Putney plants are famous. The best are Belle of Surrey, is of a delicate rosy hue; Dazzle, bright shining red; Le Grande, rosy red; Rosy Morn, bright rose; and Striata splendida, bright orange. All these possess the symmetry of form

in the flowers combined with sturdy habit and clear bright colours. The woodcut (fig. 12, page 49), shows the general form and size of the flowers of this improved race of Abutilons.

Tuberous Begonias have been magnificent, some extremely large-flowered and brilliantly coloured varieties having been obtained. At the present time the Primulas and Violets are the chief features in the nursery, several houses containing an enormous stock of these plants. In innumerable other genera additions have been made during the past year, but the above are sufficient to show the character and extent of advance.

EARLY CAULIFLOWERS AND LETTUCES.

GARDENERS in the south, having quite a different climate to deal with from their brethren in the north, may not always comprehend the difficulties we have to contend against. The notes which follow may not, in consequence, appeal to their sympathies. Northwards, where both Cauliflowers and Lettuces are somewhat difficult to manage through winter, they will be better understood. It is a common practice to grow Cauliflowers under handlights in all parts of the country, and from these the earliest crop is gathered. In the north, however, a break is likely to occur when depending alone on autumn-sown plants to follow these. I have been in the habit of sowing seed in heat at this time in order to make sure of overcoming this difficulty, and at the same time a little Lettuce seed is sown. The best sort of Cauliflower for this purpose is Veitch's Early Forcing, a new variety which has been found most satisfactory. Early Dwarf Mammoth should also be employed to afford a succession to the above. The earliest Lettuce is one of the All-the-Year-Round type, or, where size is not a necessity, the Tom Thumb type may be used. In my experience these are not appreciated, and that best of all Lettuces, Hicks' Hardy White Cos, is employed for use at all seasons.

The treatment of both kinds of vegetables is very much alike. The seedlings are raised in a temperature of about 55°, and when well up they are kept near to the glass, in due time being transferred to a cold frame until ready for pricking out singly in a bed prepared as follows. On a hard bottom a thin layer of Mushroom-bed refuse is made firm, and on this a couple of inches depth of compost made of half loam and half manure is placed. Into this the young plants are put out about 2½ inches apart each way. Boards placed round the sides and ends admit the placing of old sashes above the plants. In March they are ready for transplanting. If the weather becomes cold after they are planted we place a twig or some evergreen over each plant, and find this of benefit as a protection. This sowing of Lettuces is planted between the rows of yearling Strawberries, and are cut before the fruit is ready. We invariably have our finest Lettuces under this treatment. The Cauliflowers, I find, derive great benefit from a slight dressing of sulphate of ammonia to each plant.—B.

ANEMONE JAPONICA.

MUCH has been written on the merits of this plant for beds and borders, but a few more words of praise will not be out of place. I consider it to be one of the most showy and useful plants for the herbaceous border, flowering as it does for a considerable time through the latter part of summer and autumn months. I saw it used last September with good effect in a round bed about 15 feet in diameter. The bed in question was filled with plants varying from 3 to 4 feet high, the taller in the centre. I never saw this Anemone grown finer, and when in flower about the middle of September nothing could surpass it in beauty. Another bed was planted with the rose-coloured variety and growing equally as strong. Near to these two beds of Anemones was a bed about the same size planted with the purple Clematis Jackmanii rambling over sticks that were arched over the bed, the highest part of this bed being about the same height as the Anemones. These beds were backed up at some distance with a mixed border containing at intervals plants of the white and rose-coloured variety of Anemone. The effect viewed from a little distance was such that would not soon be forgotten. I have never seen anything more pleasing than these beds when in flower. Anyone pretending to possess an herbaceous border should grow this plant, and in fact no garden, however small, should be without it. Where there is sufficient room it should be grown in quantity, as it is extremely useful for cutting purposes. The flowers being pure white are always appreciated. The flowers may be used in many ways; for filling vases it is very effective associated with other flowers, or, as I have seen, vases filled with it entirely with a few fronds of Ferns.

Anyone wishing to increase their stock of plants should do so now while the weather is open. Autumn is also a good time for

removing the plants after the foliage has died. The best way to increase this plant is by division of the roots, for although it flowers very freely I have never been fortunate in obtaining seeds, but probably this has been an oversight. The old plants should be lifted and divided. The strongest pieces will flower the following autumn, and if a favourable season many of the smaller ones will produce a few flowers. If it is desirable to have a bed or a large clump of them, the strongest should be selected for the middle, the medium-sized plants following, and the smaller ones for the outside; by so planting all the flowering plants will be together. I find the general height of this plant is given at between 2 and 3 feet, but under good cultivation it greatly exceeds this height. A rich loam suits it well with a top-dressing of decayed leaves and manure forked in through the winter.—G. W.

A SOUTH-WESTERN ASPECT FOR GRAPES.

THE readers of the Journal must not infer from the above that it is the best aspect in which to grow Grapes, but that as good results can be obtained from houses erected in a south-western aspect as from any other, all other things being equal. Those who have to buy ground for the purpose of erecting houses for the production of market Grapes, not only build on the most favourable aspects, but through necessity more than choice on aspects less favourable. The ground is economised to admit of the greatest quantity of glass being built in a given space; they would be taking the money out of their own pockets if they did not do so. In many gardens there are to be seen considerable ranges of houses in what may be termed westerly aspects, especially in market establishments. The Vines are selected for the different positions, and consequently give as great satisfaction as those which are growing in more favourable circumstances. The south-western aspect is not good for Vines that require to be early started, as fire heat must be used in excess to raise the morning temperature; but if their roots are all inside and under command they are not long in regaining what was lost. A south aspect is the best for growing most kinds of fruit, whether they may be planted in span-roofed or lean-to houses. A south aspect with a point east is held in great favour by some of the best Grape-growers of the present day, and especially those who believe the morning sun has a great influence on colouring white Grapes, Muscats in particular. Equally good Grape-growers, on the other hand, seem to think the effect of the morning sun in colouring very questionable, and that good cultivation carried out with the houses facing south can produce equally good results.

Houses that incline eastward have the advantage of both a quick and high temperature in the early part of the day, instead of raising the temperature by fire heat. The advantage gained in the morning by an early rise from sun heat may be said to be counterbalanced by the heat being early out of the house in the afternoon, but when closed early with a high temperature and accompanied by a little fire heat in the pipes, the effects are as beneficial to the Vines as in cases where the sun lingers a little longer in the afternoon.—NORTHERN.

CARNATIONS AND PICOTEES FOR BEDS.

THE best time to plant Carnations and Picotees is October, as they become thoroughly established in the soil, whilst otherwise they require frequent examination to keep them from being disturbed by the frost. This season having been so wet has prevented planting as yet, but now I shall commence planting them the third week in February as I did last year. Another advantage of growing them in beds is that they do not require planting every year as they do when in pots, as the finest blooms are generally to be had from them the second year. All surplus plants when layered can be removed, leaving about four plants to each stool.

A plot of ground that has been occupied by Potatoes is most suitable for them, as the wireworm will have been taken out with the Potatoes. If a Potato patch is not to be had dig the ground over, carefully destroying all the wireworms that can be seen. The most suitable soil for them is a good marl. The Carnation is, however, very accommodating and will grow in nearly any kind. I have used light soil, pressing it firmly around the plants, whilst in strong soil I do not press the soil so firmly. In planting I raise the beds a few inches above the surrounding ground, planting the plants in twos or threes according to their strength. The clumps are a foot apart and 15 to 18 inches between the rows. Only two rows are placed in a bed, leaving a pathway between that and the next bed, so that they are convenient for layering. A plan I adopt with particular sorts is to lift them and pot and layer them; by doing this the plants will

give seed after layering. Mr. Dodwell was the first to inform me of this, and I have since proved it to be so. The plants after being layered in the ordinary way never set any seed.

If the ground is poor it is a good plan to dig in some well-decomposed manure, that from an old hotbed will do very well. Before planting thoroughly incorporate it, and if at all sour give a sprinkling of lime, digging it in a few days before planting. If these simple cultural directions are followed any grower may succeed in growing Carnations and Picotees in beds. I will give a few simple cultural directions occasionally on growing the plants in beds.

The following is a list of the varieties I have found the best suited for culture in beds:—

CARNATIONS.

Scarlet Bizarres.—Admiral Curzon, John Burnett, Edward Adams.

Crimson Bizarres.—Rifleman, Lord Milton, J. D. Hextall.

Pink and Purple Bizarres.—Falconbridge, Wm. Murray, Sarah Payne.

Purple Flakes.—Dr. Foster, Jas. Douglas, and Squire Meynell.

Scarlet Flakes.—Dan Godfrey, Sportsman, and Clipper.

Rose Flakes.—Sibyl, John Keet, and Rose of Stapleford.

PICOTEES.

Heavy Red.—John Smith, J. B. Bryant, Brunette.

Light Red.—Sarah Elizabeth, Thomas William, Violet Douglas.

Heavy Purple.—Alliance, Zerlina, Tinnie.

Light Purple.—Ann Lord, Alice (medium), Master Nichol, and Her Majesty.

Heavy Rose or Scarlet.—Fanny Hellen, Lady Holmesdale, and Mrs. Rudd.

Light Rose or Scarlet.—Mrs. Adams, Mrs. Allcroft, and Miss Wood.—G. RUDD.

MAKING AND RENOVATING LAWNS.

LAWNS are made for the purpose of ornamentation, for recreation, or for both, but in the latter case there is the disadvantage of their being disfigured from being browned or made patchy. It is always advisable, when practicable, to have separate grounds for recreation, and these should be so extensive as to admit of a change, so that when one part becomes at all unsightly it may be allowed to recover its freshness.

As ground for recreation depends in a great measure upon the goodness of the turf—its even surface, closeness, and toughness, with freshness—it is essential that the ground be good, and if not naturally such its improvement must be effected to secure a good growth of grass, whether by sowing seeds or laying turf. Efficient drainage is of primary importance, and not less so is the loosening of the soil to an even depth to admit of the water passing through the soil readily. Heavy soils will be improved in texture and allow of the water percolating freely away by a free mixing of ashes with the soil, and light soils by an admixture of well-pulverised clay, so as to render it more retentive of moisture. To allow of the water passing away from the surface speedily after showers it is not unusual to cover the surface before laying the turf with a couple of inches thickness of ashes; or, if the turf is to be obtained by sowing, cover the ashes with a couple of inches of fine rich soil. This answers well enough in heavy soil, but where the soil is sandy and the subsoil of a porous nature is both superfluous and injurious.

Where good turf is to be had it is the readiest method of securing a good sward, but, failing this, grass seeds sown in proper season will soon make a good turf. The most suitable time for sowing grass seeds is during April, and preferably in dry calm weather, but with an early prospect of rain. Soils differ somewhat in texture, and the mixture will need to be composed of grass seeds suitable to the soil; but, as a rule, it should be composed principally of the harder-textured grasses, as the Hard Fescue (*Festuca duriuscula*), Red Fescue (*Festuca rubra*), Fine-leaved Fescue (*Festuca tennifolia*), and that best of all lawn grasses, Crested Dog's-tail (*Cynosurus cristatus*). A small proportion of Perennial Rye Grass (*Lolium perenne*), of which Pacey's is a fine selection, should be added to act as nurses to the finer grasses and aid in the speedier formation of the sward. Clovers should be excluded, for though they soon make a beautiful surface, it will not bear the same amount of use as turf formed of the harder-textured grasses, and is liable to remain longer damp after rain or dew.

Then as to the surroundings of grounds for recreation, it is absolutely necessary that they be not of too close or dense a character as to prevent the free access of air, and yet they should be sufficiently compact and high to secure privacy. Stiff

formal outlines should, as far as possible, be avoided, such as hedges or screens of Yew, Arbor Vitæ, &c., as they are extremely monotonous. Evergreens that naturally have a tufted appearance, as low-growing evergreen shrubs, Rhododendrons, and Berberis Darwini, with the choicer description of deciduous flowering shrubs, disposed in wavy rather than in straight lines, will afford a pleasing contour and variety. Tall trees must be at a reasonable distance, and yet a spreading Beech tree or Lime readily accessible and provided with seats will be much appreciated in the intervals between games. Arbours and summer houses, good as they may be in their way as refuge from a passing shower, or a shelter from heat to non-players, or resting spot for the heated or fatigued player, are inadvisable from their being suggestive of complete seclusion or retreat from the affairs of ordinary life, and are incompatible with the associates of a playground. Temporary shelters from sun and rain answer their purpose much better, as for instance, tents or awned seats.—G. ABBEY.

(To be continued.)

EASTER BEURRÉ AND BEURRÉ RANCE PEARS.

THE first-named Pear (referred to on page 11) is with me not to be depended on. Although blooming profusely, and often setting a heavy crop of fruit, very few, considering the quantity, are of any use, as they crack seriously, and are very often covered with black spots. The soil is a deep loam, rather stiff, but well drained, and although this variety is trained to a wall in the best part of the garden as regards aspect and soil, the produce is anything but good. Our largest tree of this kind (fan-trained) had quite a bushel and a half of fruit on it this season, but the majority had to be thrown to the pigs, it being so badly spotted and cracked. The rest that were stored in the fruit-room are not keeping well, and will be of little value.

Beurré Rance, I find, is much more useful, and as a January and February Pear is very good, being juicy and rich in texture, but cannot be depended on only from walls with an exposure to the south. This, and last year too, most of the fruit was good for dessert purposes, many being from 6 to 9 inches in length; but this variety, with many others with me, is liable to crack. The trees of these two kinds are old, but are enriched with decayed manure about the roots annually. The fruit, too, is left on the trees as long as possible, being generally the last two kinds that are gathered. A few trees of these two kinds planted in the open are of little use, only very few fruits on them coming to perfection. I intend to saw them down and graft early kinds upon them, as they are certainly more profitable. Beurré Rance I could recommend as a winter Pear to anyone having south wall space sufficient to spare, to be grafted on the Pear stock, and the branches to be trained horizontally a foot apart, not forgetting to mulch in winter with decayed manure, as it tends to keep the roots near the surface.—A. HARDING, *Orton Hall Gardens, Peterborough.*

MY SUBURBAN GARDEN.

(A COLUMN FOR AMATEURS.)

"DIDN'T I tell you that if you sent a letter to an editor of one of the gardening journals that he would insert it? I had no doubt whatever he would do so. Learned and scientific disquisitions are all very well, but unless I am very much mistaken the majority prefer plainer fare; and while I do not go so far as to say that 'he who drives fat oxen must himself be fat,' I am strongly of opinion that no one can communicate information that is so useful to amateurs as an amateur himself who records his own practice. Go on as you have begun. I shall look out for the next edition."

Such was the letter which last Saturday's post brought me from my horticultural friend; and although I did not in the first instance tell him to which paper I should address my letter, he making no suggestion on that point, he has evidently been on the "look out," and I have obtained at the least *one* reader. I will take this as encouraging and proceed.

I wish to say a little more about my glass structures, or rather about plant houses generally, for these are increasing apace, and I perceive that money is being wasted in their erection. The first house I had built was the most elaborate of all, cost by far the most money, and has given the least satisfactory results of any. It is a conspicuous span-roof, very lofty, with upright side lights (which do not open), 8 feet high, and a lantern roof containing ventilators. A flat latticework table for plants runs round the sides over the hot-water pipes, and a stage step above step occupies the centre of the house. Why I had such a house built I do not know. The plants cannot be watered without climbing up

amongst them, and the result is that those at the top are often too dry. "But did you not state for what purpose the house was required?" some reader may ask. Yes, I did, in a way. I told the builder I wanted it for "Camellias, Azaleas, Fuchsias, Palms, Lilliums, and all those sorts of things," and he appeared to know in a moment as if by intuition; and with a "Leave it to me, sir, leave it to me," the affair was settled.

Now the plants in this "great mistake," as we call it, never have done well. The Camellias cast their buds and have too many brown leaves; the Palms have a yellow hue that is not agreeable; Fuchsias get infested with thrips; and small plants, such as Cinerarias and Calceolarias, fall a prey to aphides. The truth is the house is not adapted for plants in pots; it is too hot and dry in summer, and in winter makes sad work with the coal heap. A correspondent last week referred to unsuitable structures for plants. This is a case in point. Such erections as this are plant-killing, not plant-growing houses, and I would warn all inexperienced amateurs against erecting them.

Now, as I cannot grow plants in this house, what am I to do with it? "Clear out the stage, take up the brick floor, make a bed in the centre, and plant Palms, Araucarias, and such-like," says one friend; but purchasing plants of that kind and soil in sufficient quantity for supporting them is a costly experiment; and, besides, I do not want such big plants. No, I shall turn it into an orchard house. I believe the natural soil will grow Peaches and Pears very well, as they grow well in the open; but fruit does not always follow the blossom. My plan is to plant cordon Pears on the outside of the house and take them through like Vines, training them either vertically or obliquely up the sides at intervals of 3 feet. At this distance sufficient light will pass between them and through the roof for the Peaches in the centre, which will be grown the same as they are grown in America—namely, as standards, as I apprehend I shall have an American climate. What a sight an American Peach orchard is! Once seen it is not likely to be forgotten by any traveller from the old country. But to the Pears. As each cordon can attain a length of at the least 10 feet by curving over the path, I think the plan worth trying. So much for an initial mistake in building and the proposed remedy.

To proceed again. The next house I erected was much less pretentious. I think the more experience a person has the greater is his disposition to approach simplicity in most things. His zest for doing something greater than his neighbours becomes dulled, and he adopts a more common-sense practice of doing that which will be best for himself. With this object I erected a low span-roofed structure, 25 feet long and 12 feet wide, with a 3-foot path down the centre, and side stages each $4\frac{1}{2}$ feet wide. The walls are 2 feet 9 inches high, and glass lights with sliding ventilators, above them, 1 foot 3 inches, the height from the floor to the apex of the roof being 8 feet. This is a serviceable house, and nearly everything grows well in it. The two shelves 15 inches from the glass overhead on each side of the path are especially useful and also convenient, being only 5 feet 6 inches from the floor. The roof ventilators consist simply of three 18-inch "skylights" on each side on hinges and perforated rods for affixing on a pin where required; thus the lights can be opened from an inch to a foot according to the weather. This is no doubt very rudimentary, but the plan has this advantage—it answers well. The stage is 2 feet 9 inches from the ground, and 15 inches from the glass roof in front. But for the shelves, which hold as many plants in a small state as can be grown to decorative size on the side stages, the house need not have been so high or the roof so steep; nor do I see that the side lights are of any real service. The house is divided so as to form a warm and cool greenhouse, and with all its faults suits both the plants and myself.

The side stages of this house are of open latticework, which I have found is decidedly not the best base for the majority of plants. The air, often too dry, rising up through the pots and striking the under sides of the leaves, is not good for such plants as Cinerarias, Cyclamens, Calceolarias, Primulas, Begonias, Gloxinias, Hyacinths, and Ferns. All these plants thrive much better and are less liable to the attacks of insects when the pots stand on a surface of ashes, gravel, or cocoa-nut fibre refuse kept more or less moist according to the season of the year and weather. That this is so I have no doubt whatever; indeed, if it were not I think we should not find so many what I may term close stages in nurseries; and why with that experience before us persons will go on making open latticework stages passes my comprehension. I will have no more of them, nor do I advise their adoption by other amateurs who wish to grow softwooded plants in the best manner with the least trouble in watering and fumigating.

My stages are now covered. The best and cheapest method of

doing this was the subject of much consideration and discussion. Boards, slates, asphalt roofing-sheets were all under review, but we wanted something thinner and cheaper. My man solved the problem, or at least a piece of tarred brown paper he accidentally came across did it for him. Thick carpet paper, the kind sold for placing under carpets, was procured. One side was smeared with hot tar and thickly dusted with sand; this side having dried, the sheets were turned over and other side treated similarly. Nothing could have answered better. They were placed on the stage, covered with ashes, and these surfaced with crushed shells. Three years have passed since then, and how long the paper-flooring will last I cannot tell, but no doubt for three years longer, and we are well satisfied with the experiment.

In connection with the use of tar it may be well to state that it must never be introduced into a house with plants until it has thoroughly dried, for in a moist state it is dangerous. On one occasion towards the end of the summer a vessel of warm tar was placed in a Cucumber frame and left there all night to try the effects of the fumes on red spider. It was very striking, for I believe it killed every insect, as it certainly did every leaf, on the plants, while the fruits when cut had a very pronounced tar flavour and could not be eaten.

I have more to say on glass structures, but at present must leave the subject and describe my method of pruning Vines, this being, so I am told, a slight departure from the stereotyped practice. The vineries are crowded with plants, which need at the least glimpses of light in summer. The rods are 3 feet apart, hence the laterals when trained in the ordinary manner completely covered the roof with foliage, and the glass was scarcely visible on looking upwards. This the plants did not like, nor were the Grapes very superior. I thought I should, therefore, lose little by an experiment first tried last year and now just repeated.

Instead of cutting the laterals off close to the spurs I only removed every alternate one, and tied the others in lengths of a foot or more close to the main rods. In the spring I had such a break of strong growths as I never had before, and it was apparent that nine-tenths of them must be removed. The plan adopted was this:—The best bunch was selected on each lateral (and I had a choice of from three to six), all the rest of the growths being gradually rubbed off except one at the base. The bearing shoots were stopped, some at the bunch, others at one leaf beyond, and a young shoot from each spurred lateral kept and trained up the rods for the fruiting the following year. The crop was by far the best I ever had, the bunches hanging in a close row directly under the rods, and by removing a leaf here and there from the bunch-bearing laterals those for succession are now as good as I can desire them, while all the summer I had a comparatively light house for plants instead of, as before, a dark one. This, the Peach system of pruning, more than answered my expectations, and I shall follow it until it fails, which I am sanguine will not be this year nor next, nor the next after that.

And now ye great gardeners—men who have taught me so much by which I have profited—have ye not sometimes taught *too* much? Have ye, in insisting that Vine shoots must be stopped one leaf at least, and more preferably, beyond the bunch, found by full and fair trials that that is the only method of securing good Grapes? If so your Vines are different from mine, for the Grapes stopped at the bunch and the leaf there preserved—none beyond—were quite as good as the others that were treated in the orthodox manner, while more light was allowed to the foliage of the successional laterals. Dare anyone venture to try this out-of-the-way method of pruning on one Vine this year? I have tried it on a dozen; but then I am answerable to no one if I fail, of which untoward result, however, I have not the remotest fear.—M. D.

LEWISIA REDIVIVA.—A charming little alpine with a long fleshy rootstock, producing a tuft of narrow fleshy leaves, and large flowers like a *Mesembryanthemum*, of a bright magenta-rose colour, with a diameter of 3 to 4 inches when expanded, which it does during sunshine. It comes from the western States of America, and is quite hardy with us if planted in a proper position. Mr. Backhouse of York places it in vertical clefts in his rockery, and it thrives well. If this is not done it should have a thoroughly drained position and sunny, and be planted in limestone chippings, crocks, and sand, with a little loam added, so that during the winter the fleshy rootstocks

will be comparatively dry. *L. brachycarpa* is similar, but produces white flowers. It should be treated in the same way; mixed together in clumps they are very pretty.—X.

MUSHROOM CULTURE.

THE Mushroom is grown with more or less success in most gardening establishments, and under various conditions. By way of adding another name to the list of successful Mushroom growers which have already been recorded in the Journal, I wish to mention that of Mr. Charles Warden of Clarendon Park Gardens, Salisbury, where on the flags under a step stage in a lean-to house are two beds which are specially worthy of notice, as demonstrating the good account to which hundreds of such places could be turned without in any way interfering with the special use of the house. These beds are about a foot deep, enclosed by boards



Fig. 12.—Abutilon. (See page 46.)

of the same depth, and were spawned when the heat of the beds was not likely to rise above 70° or 75°, and cased over with soil, beaten firmly together with the back of the spade in October last, and then covered with clean straw which subsequently was damped over occasionally with tepid water from the syringe. The main temperature of the house being about 52°. They are now, as they have done for several weeks past, producing abundance of fine Mushrooms, many of which are 5 and 6 inches in diameter. Mr. Warden is equally successful in the production of Mushrooms in the Mushroom house proper, as in the case above cited, and the same remark applies to the culture of them out of doors, as amply testified by a small ridge (about 12 feet long) which was made last autumn, and from which he has recently gathered between 25 and 30 lbs. of excellent Mushrooms. This is only one of many instances resulting from the series of excellent articles which appeared in the pages of the Journal some time since by Mr. Wright.—VISITOR.

[A sample of the Mushrooms referred to has been sent to us, and the specimens are very fine indeed.]



NOTES AND GLEANINGS.

THE following persons are recommended by the Council to be appointed to the offices of President, Treasurer, Secretary, and Auditors of the ROYAL HORTICULTURAL SOCIETY, at the annual meeting on the 13th February, 1883:—President, Right Hon. Lord Aberdare; Treasurer, William Haughton; Secretary, Major F. Mason; Auditors, R. A. Aspinall, John Lee, and James F. West. The vacating members of the Council are Colonel R. Trevor Clarke, Rev. H. Harpur Crewe, and J. T. D. Llewelyn; and the following gentlemen are recommended by the Council to fill the above-mentioned ordinary vacancies—Sir Charles W. Strickland, Bart., Sir P. Cunliffe Owen, K.C.M.G., C.B., C.I.E., and Colonel Beddome.

— WE are informed that MR. E. TUDGEY, who was recently gardener to J. F. G. Williams, Esq., Worcester, has commenced business as a nurseryman at Waltham Cross. He has purchased the handsome specimen plants with which, on behalf of his employer, he has gained so many honours at the London and provincial exhibitions, and in future, therefore, he will appear in the nurserymen's classes if he continues showing, as he undoubtedly intends to do.

— MESSRS. JAMES CARTER & CO. desire us to state that their COLLECTION OF PRIMULAS will be on view at the Nurseries, Forest Hill, up to January 31st. It is necessary that intending visitors should obtain a card of admission at their offices, 237 and 238, High Holborn, London, W.C.

— A SOCIETY for the encouragement of the CULTIVATION OF FLOWERS has been formed in Lerwick, Shetland. Sheriff Rampini has been appointed President of the Society, and Mr. R. B. Hunter, Secretary and Treasurer. This, writes "Northern Amateur," shows that floriculture is receiving an impetus, under influential patronage, even in the far north of Scotland.

— A SUBSCRIBER writes:—"I have amongst a small collection of Orchids a plant of DENDROBIUM FIMBRIATUM, and one of CYMBIDIUM MASTERSII, which, though growing vigorously, I am unable to bloom, although I have treated them like other Dendrobies, for example D. densiflorum, clavatum, &c. Will any of your subscribers say whether they have experienced similar difficulty, and if successful the mode of culture they have followed?"

— THE REPORT ON THE CONDITION AND PROGRESS OF THE ROYAL GARDENS, KEW, IN 1881 has just been issued, and apart from the particulars immediately concerning the home establishment, it contains a number of interesting and instructive reports upon various important subjects in connection with the products of our colonies and dependencies. This portion of the Report annually increases in usefulness, and conveys some idea of the extent and importance of the work in which Kew has so large a share. To these we shall return on a future occasion, as many of the matters treated of have a general interest. The number of visitors [to the gardens during the year was greater than any previously recorded—namely, 836, 676, an ample proof, if any were needed, that while maintaining its position as the leading scientific institution in the horticultural and botanical world, it yet continues to increase in popularity with the general public. The many improvements which have been effected under the direction of Sir William and Sir Joseph Hooker have greatly tended to this, the efforts of the latter having also been aided by the Curator, Mr. John Smith, and more recently by the Assistant Director, Professor Dyer.

— MR. T. S. MURPHY, Hillington Hall, writes:—"I was glad to see your correspondent Mr. F. Richardson's remarks on the handsome flowering plant BOUGAINVILLEA GLABRA. A small plant of it was placed out here last March against the back wall of the Melon house. It was inserted in the path, which consists of sandy gravel, and to see it growing and flowering was most astonishing. It bloomed the whole season, and supplied us with a large amount of cut flowers which we found very useful. I certainly would not recommend giving any sort of manure whatever, as poor soil seems to suit it best."

— A CORRESPONDENT, "J. D.," requests information on the subject of VEGETATION FOR A ROOKERY, and with the object of eliciting it we print his letter as follows:—"I have just entered on a place where there is a large rookery, and underneath the old trees that compose it no vegetation is left alive. What would be my best way of trying to get some sort of green carpet below it? I do not wish to make away with the rooks. Would any kind of Sedum grow under such circumstances? or would Ground Ivy be available? Something that would hide the bareness, and still admit of the masses of fallen leaves being gathered up pretty readily, appears to me to be the desideratum."

— MR. ALLIS, gardener to Joseph Shuttleworth, Esq., Old Warden, Biggleswade, has sent us a sample of PEARSON'S GOLDEN QUEEN GRAPE, which we have seldom if ever seen in such good condition. The berries are of a clear amber colour without spot or blemish, and the flavour is particularly refreshing, having a delicate and agreeable aroma of the Muscat. Mr. Allis grows this Grape with the Black Alicante, of which he considers it the best white companion, both growing and bearing with the same freedom, ripening at the same time, and keeping equally well.

— AS FOREST TREE PLANTING ON WASTE LANDS is a matter of considerable interest to the public at present, we record the following example of extensive planting:—"By directions of Sir Henry Loch, K.G., Her Majesty's Commissioner of Woods and Forests, a large extent of Crown lands in the Isle of Man is about to be planted with forest and ornamental trees. About five hundred acres are now being so planted on the mountain called Archallagan, where cabins have been erected by the contractors for the accommodation of the men. Messrs. Little and Ballantyne, Knowefield Nurseries, Carlisle, have been entrusted with the contract, one of the largest of the kind ever entered into in Great Britain, and already the first instalment of a quarter of a million of young trees have been shipped from the Carlisle Nurseries for the work."

— "G. S." writes:—"EASTER BEURRE Pear is one of the most reliable in this locality (South Yorkshire) both for productiveness and quality. We are now heading down trees of inferior varieties, intending to graft them with this, which I consider to be one of our best late Pears. This year it has ripened much earlier than usual, also Glou Morceau and Josephine de Malines, being all ripe and sent to table before the present time. The above are the three best late Pears here. The soil is on strong magnesian limestone. Other varieties that I have found to succeed well are Jargonelle, Williams' Bon Chrétien, Marie Louise, Beurré Diel, and Louise Bonne of Jersey, each in their season being of good quality."

— MR. W. JENKINS, The Gardens, Aldin Grange, Durham, writing respecting LATE-FLOWERING CHRYSANTHEMUMS, observes:—"I send you a couple of blooms of Chrysanthemum Guernsey Nugget, to show what a useful variety it is, flowering as it does into the new year. I find Princess of Teck and Beauty of Stoke Newington good companions to it, all three varieties being dwarf-growing and well adapted for conservatory work. I think the first-named is not sufficiently known." The blooms received

well merit the praise our correspondent bestows upon them. Guernsey Nugget, very bright yellow, fresh, and of good form; Beauty of Stoke Newington, pale pink, nearly white; and Princess Teck, pure white, the blooms very compact and distinct. They form a trio of very useful late varieties.

— "A NORTHERN AMATEUR," referring to his notes on page 32, writes:—"Allow me to notice that in speaking of the construction of the houses at Fedall, I intended to use the words 'well raised' after 'the lights in every house were to be seen.' I intended also to say that Mr. Dickson of the Ormeau Park, Belfast, 'has nearly discarded the named sorts' of Verbenas, not his own seedlings. Hasty and indistinct writing may have caused these errata."

— A MEETING in support of a PROPOSED CHRYSANTHEMUM SHOW AT LINCOLN took place last Thursday evening. The Mayor, W. T. Page, jun., Esq., took the chair. The meeting was attended by a number of gentlemen and practical gardeners well known for their interest in horticultural matters. It was resolved to form a Lincoln Chrysanthemum Society, with the objects of promoting the cultivation of the Chrysanthemum and of holding an annual exhibition some time in November. A sub-committee, consisting of Mr. Whitbread, Mr. Buffham, Mr. Cooling, head gardener at Monks' Manor; and Mr. Wipf, head gardener at East Cliff House; with Mr. R. J. Ward as Chairman, and Dr. G. M. Lowe as Hon. Sec., was appointed to carry out details and issue a schedule as promptly as possible.

— THE ROSARIANS' YEAR BOOK.—The issue of this welcome annual for 1883 (Bemrose & Sons) is now in the hands of many readers, to whom it will doubtless prove even more acceptable than previous editions. It includes entertaining articles by the Revs. H. B. Biron, J. A. Williams, and the Editor, H. Honeywood D'Ombraïn, with Messrs. J. Hinton, D. T. Fish, E. R. Whitwell, G. Paul, A. H. Gray, Hubert Bensted, Edward Mawley, and C. H. Hawtrej, upon various subjects more or less connected with Rose-growing and exhibiting; in addition being given excellent photographic portraits of George Baker, Esq., of Reigate, Vice-President of the National Rose Society, and of E. R. Whitwell, Esq., the winner of the Amateurs' Challenge Trophy in 1882. As an example of "light reading" we propose to publish Mr. Hawtrej's amusing article in a future issue.

— GARDENING APPOINTMENT.—Mr. James Clark, formerly gardener to the late E. Hermon, Esq., Wyfold Court, Henley, has entered on his duties as head gardener to Lord Camoys, Stonor, Henley-on-Thames.

— WE are informed on the best authority that MESSRS. JAMES VEITCH & SONS have purchased the freehold of the King's Road Nursery, together with that of Stanley House and the grounds pertaining to it. The latter will always have an interest attached to it from being the residence where the late Mr. James Veitch, the founder of the London house, lived and died. We cannot but congratulate Messrs. Veitch on having acquired so precious a possession, where, we trust, for many years to come the family and the family name will be preserved in connection with a pursuit they have for four generations already so highly adorned. The nursery, which was founded by the late Mr. Joseph Knight in 1815, was of small dimensions; and when Mr. James Veitch, jun., left Exeter and succeeded Messrs. Knight & Perry in 1853, it very soon became apparent that the new energy he introduced into the establishment proved too great for the small space in which it was confined, and as a natural consequence greater scope had to be provided. In 1857 the acreage of the nursery was doubled, Mr. Perry having purchased Stanley House and the land adjoining, which he let to Mr. Veitch, and now Mr. Harry J. Veitch has become proprietor of the whole. Now

neither he nor those who would regret to see the old associations with the King's Road severed, need have any misapprehension on that point. We congratulate Mr. Veitch most heartily on this valuable acquisition, and we, in common with a host of well-wishers, hope he may be spared many years to enjoy his well-gotten gain.

— LAST Monday evening a number of the AURICULA GROWERS OF ROCHDALE, Middleton, and Todmorden met at Rochdale, and after considering the matter resolved to revive the Auricula Show in that town. The meeting were presided over by Mr. James Chceatham, who was Secretary of the old Society when the shows were discontinued. Mr. C. M. Royds, J.P., was elected President, and Messrs. Samuel Barton, J.P., Stakehill, Richard Gorton, Eccles, and William Bolton, Warrington, Vice-Presidents. The Hon. Secretary and Treasurer is Mr. James Chceatham, Waraleworth Brow, and the duties of Hon. Assistant Secretary will be discharged by Mr. James Brodie, Mitchel Street. The date of the Show was fixed for the day following the Exhibition of the National Auricula Society in Manchester, and rules and schedule of prizes were adopted.

— REV. DAVID LANDSBOROUGH, Kilmarnock, writes:—"Your correspondent 'G. L.,' who wrote recently respecting the HARDINESS OF CORDYLINAE INDIVISA (page 8), will be interested in the following extract, which appeared in a Scotch paper four and half years ago:—"In the grounds of South Park, Campbeltown, Argyleshire, the residence of Lady Campbell and Sheriff Gardiner, there is at present to be seen in flower a very fine specimen of the New Zealand Cabbage Tree or Palm. The plant is fully 11 feet high, its stem is about 8 inches in diameter, perfectly straight, and is ensheathed, except 2 feet at the lower part, in beautifully green long sword-shaped leaves. The flower is an immense panicle covered with innumerable little florets. It proceeds from the top of the stem, but takes a very peculiar twist, and lies toward the sun. The plant was raised from seed by Lady Campbell eleven years ago, and has stood out of doors all these years without any protection, exposed to all the changes of our very variable climate. It is highly ornamental, and apparently quite hardy." I may add that *Cordylina australis*, *C. indivisa*, and *C. Veitchii* are all quite hardy in the garden of Cromla House, Corrie, Isle of Arran, where they have grown in the open air for five years without receiving the slightest injury. I saw lately a very beautiful and striking photograph of the Palm avenue in the Botanic Garden, Ballarat, Victoria. Why should not some of our favourite watering places possess a similar avenue, as we have those which possess the requisite climate and shelter?"

— MR. C. A. WHITE of Washington has the following observations in the last issue of *Nature* on the REVERSION OF SUNFLOWERS AT NIGHT:—"While the fact that Sunflowers turn their faces toward the sun in its course during the day is as old as our knowledge of the plant, I am not aware that any record has been made as to the time of night that they turn to the east again after their obeisance to the setting sun. One evening during a short stay at a village in Colorado, in the summer of 1881, I took a walk along the banks of a large irrigating ditch just as the sun was setting. The wild variety of *Helianthus annuus*, *Linn.* (= *H. lenticularis*, *Douglas*) grew abundantly there, and I observed that the broad faces of all the flowers were, as is usual in the clear sunset, turned to the west. Returning by the same path less than an hour afterwards, and immediately after the daylight was gone, I found, to my surprise, that much the greater part of those flowers had already turned their faces full to the east in anticipation, as it were, of the sun's rising. They had in that short time retraced the semicircle, in the traversing of which with the sun they had spent the whole day. Both the day and night were cloudless, and apparently no unusual conditions existed that might have exceptionally affected the movements of the flowers. I doubt not that many persons like myself

have supposed that Sunflowers remain all night with their faces to the west, as they are when the sunlight leaves them, and until they are constrained by the light of the rising sun to turn to the east again. It is not my purpose to offer any explanation of the cause of the phenomenon here recorded, but it seems to me improbable that it could have been an exceptional instance; and I only regret that no opportunity has since occurred to me to repeat the observation."

— THE members of the SICK FUND ESTABLISHED AMONGST THE EMPLOYÉS OF MESSRS. T. RIVERS & SON, AT SAWBRIDGE-WORTH NURSERY, held their seventh anniversary last week, and the event was celebrated in a memorable manner. The Society was established through the exertions of Mr. William Camp, the energetic and courteous manager of this old-established and famed nursery. All the workmen are eligible for membership, whether old or young, the men paying 2*d.* a week and the boys 1*d.*, and membership is not compulsory; but the beneficent results which have attended its operations have had the effect of attracting to it the great majority of the hands employed by Messrs. Rivers, who have themselves generously fostered the "sapling," which has hitherto flourished vigorously. This year, and for the first time, arrangements—thanks to Messrs. Rivers' ready kindness—were made to hold the annual dinner at the nursery instead of at one of the inns. One of the spacious forcing houses, 150 feet long by 24 feet wide, was cleared and decorated for the occasion, and formed an elegant and imposing banqueting hall. Mr. Camp presided; Mr. W. Tarling, the principal departmental foreman, occupied the vice-chair, and about sixty members and friends were present. After dinner the Chairman, having first given the toast of the Queen and the Royal Family, which was received with cheers, proposed health and prosperity to Mr. T. F. Rivers and family and Mr. H. R. Rivers. Mr. Camp referred to the considerate, kind, and liberal way in which Messrs. Rivers invariably treated their employés. Other toasts followed, and the Chairman next reviewed the progress of the Society since its establishment in 1876. They started with forty-seven members, and had a balance of £21; in 1877 there were forty-eight members, and had a balance of £20; in 1878 thirty-two members and £23; in 1879 thirty-three members and £21; in 1880 thirty-three members and £24; in 1881 thirty-four members and £28; and in 1882 they had forty-nine members, and a balance of £37 7*s.* 8*d.* Messrs. Rivers generously contributed five guineas annually, and as soon as the dinner was proposed to be held at the Nursery they kindly placed that house at their disposal, besides horses and carts and men to assist in the preparations, and also defrayed other contingent expenses. Mr. Camp then submitted a proposal for extending the sick payments during the ensuing year to sixteen weeks—eight full pay (5*s.*) and eight half-pay. This was agreed to unanimously. The meeting terminated with a musical entertainment.—(*Abridged from the Herts and Essex Observer.*)

DRESSING CHRYSANTHEMUMS.

DRESSING Chrysanthemums a few years ago received too much attention, and does so still in some cases, but the fact is well known that highly-dressed flowers fade much more quickly than those that have not been subjected to such manipulation. It is impossible, as Mr. Moorman states, to do much with some varieties, and his remarks would lead us to believe that dressing is but little practised at the present time. But the exhibitor who stages a box of twenty-four blooms, incurved varieties, as cut from his plants and only "cupped," would have a poor chance of gaining a place with those who had used the tweezers. However well the flowers may be grown, there is produced in the majority of them narrow quilled petals that are either too long or too short; in fact they are not wanted and must be drawn out, as well as a few of the broader petals that crowd the flower, and thus prevent them incurving properly. The narrow petals must, however, be removed or they will mar the beauty of the flowers when seen on the exhibition table. It is well for either Mr. Moorman or Mr. Rowe to

remark that there were no "highly dressed" flowers at Kingston simply because dressing has to be conducted on a much different principle now large blooms are shown than when the blooms were so dressed as to admit of Lady Talfourd being shown in the stands. Those that are accustomed to be behind the scenes could give a different account from Mr. Moorman. What were some of the exhibitors and their assistants doing, I wonder, with the bloom "cupped" and in one hand and the small tools in the other, to which I have referred, for hours—I was going to write days—before the blooms were arranged in the boxes ready for the Kingston Exhibition?—O. P.

COTTAGE GARDENS IN WINTER.

AS a rule there are no gardens better filled with useful vegetables in summer than those attached to cottages; but little can be said in their favour in winter, as the majority of those I have seen in many parts of the country have supplied no vegetables of any value from November until the following April or May. This state of matters is not confined to cottage gardens, as I know many farmers' gardens and others about which the same could be said, and this is certainly neither profitable nor creditable to the owners or cultivators. A little extra attention at certain seasons would soon bring better results, and I wish to suggest improvements. A good supply of Parsnips, Carrots, Turnips, and Onions may be maintained during the winter from one sowing, as summer-sown Onions, Carrots, and Parsnips can always be preserved throughout the winter, and if the Turnips are sown on the Onion ground when they are harvested in August or September they will be ready for daily use from November until May, when the spring-sown ones come in, and the winter root-supply is in this way secured. But more than roots are wanted in the winter, and quantities of Savoys, Brussels Sprouts, Kales, and Broccoli are most desirable and acceptable. I have frequently asked cottagers if they would not prefer to see their plots filled with those in winter to having them empty, and their answer was invariably Yes; but it was stated that as their ground was full of Potatoes in summer there was no space to plant the winter greens, and this is the general idea; but it is a mistake, as has lately been proved in many of the cottage gardens about here.

In establishing our cottage garden society valuable cash prizes were offered for the best cropped cottage garden. The competition generally takes place in August, when many of the early Potatoes have been lifted; but should this space be empty when the judge goes round of course it would tell against them, and to obviate this most of them plant their ground with winter vegetables as the land is cleared of any of the summer crops. As soon as the late Potato stems begin to decay winter plants are dibbled in between the rows of Potatoes, and when these are dug up the ground is left with a valuable winter crop on it. I know cottage gardens now which were treated in this way during the summer, and their owners may cut a dish of green vegetables from them daily for the next three months. This is undoubtedly the way to make cottage gardens and small gardens generally profitable, and it would be very pleasing to see a system of this kind in general practice throughout the country. In our kitchen garden here I follow the same plan, and find it answer admirably.—J. MUIR, *Margam.*

LILIES OF THE VALLEY FOR FORCING.

PEOPLE are still incredulous about forcing Lily of the Valley year after year. The subject was brought before me the other day by a florist stating his difficulty to obtain good spikes earlier than the middle of January; and on one of the last days of the past year I had an opportunity of seeing the produce of some selected single crowns in a nursery. These were dumpy little spikes, averaging 4 inches in length and without foliage. I send you a sample of spikes and foliage from home-grown plants, which we have been cutting from at the rate of ten dozen spikes a week for the past few weeks. They are grown in an ordinary stove, and with the most ordinary treatment. Of course neither flower nor foliage are so strong as later batches will be. At the same time, when compared with what I saw the other day, they are fairly creditable to our own country.—R. P. BROTHESTON.

[They are very creditable. The spikes are strong, each containing sixteen flowers, and the foliage is well developed, stout in texture, and healthy.]

CULTURE OF THE STEPHANOTIS.—A correspondent (page 7, of January 4th) recommends planting out the Stephanotis. I prefer

culture in pots. I had a plant here in an 11-inch pot, which flowered from March to November, including those months, and had at one time upwards of one thousand trusses, with an average of ten pips each, some of them having fifteen. My object in writing is to recommend flowering *Stephanotis* in a small state. I strike them annually, grow them from 4 to 6 inches high, and obtain from each three or four trusses of flowers. I have them at the present time with the trusses just showing, and expect they will be open by the end of March.—J. G., *Brentrey*.

THE WAY TO GROW SO-CALLED LARGE BUNCHES OF GRAPES.

WITH the debatable question whether they are genuine and *bonâ fide* single bunches I do not propose to deal, although without doubt this is a question which urgently requires some official

and trustworthy solution if such a thing be possible. A discussion on this point in the *Journal* could not fail to have a beneficial result by drawing public attention to the subject, and perhaps clear the way to a solution of the question. The present seems an opportune time to mention the subject before the schedules for the summer shows have been drafted. In the classes for weight of bunch this matter has often caused sore dissatisfaction among exhibitors, and justly so too in many instances. I send you herewith a small bunch as a sample of how the thing is manipulated. I am afraid it would be difficult to figure the shoot and bunch, or this would help very much to show the process.

You will perceive that after the second bunch had shown, the shoot on which the first bunch, A, is grown was stopped and the leaf nipped off. The consequence of this was that the shoot broke again behind the second bunch, B. This second break or sub-lateral is then encouraged to grow to form the leading or permanent shoot

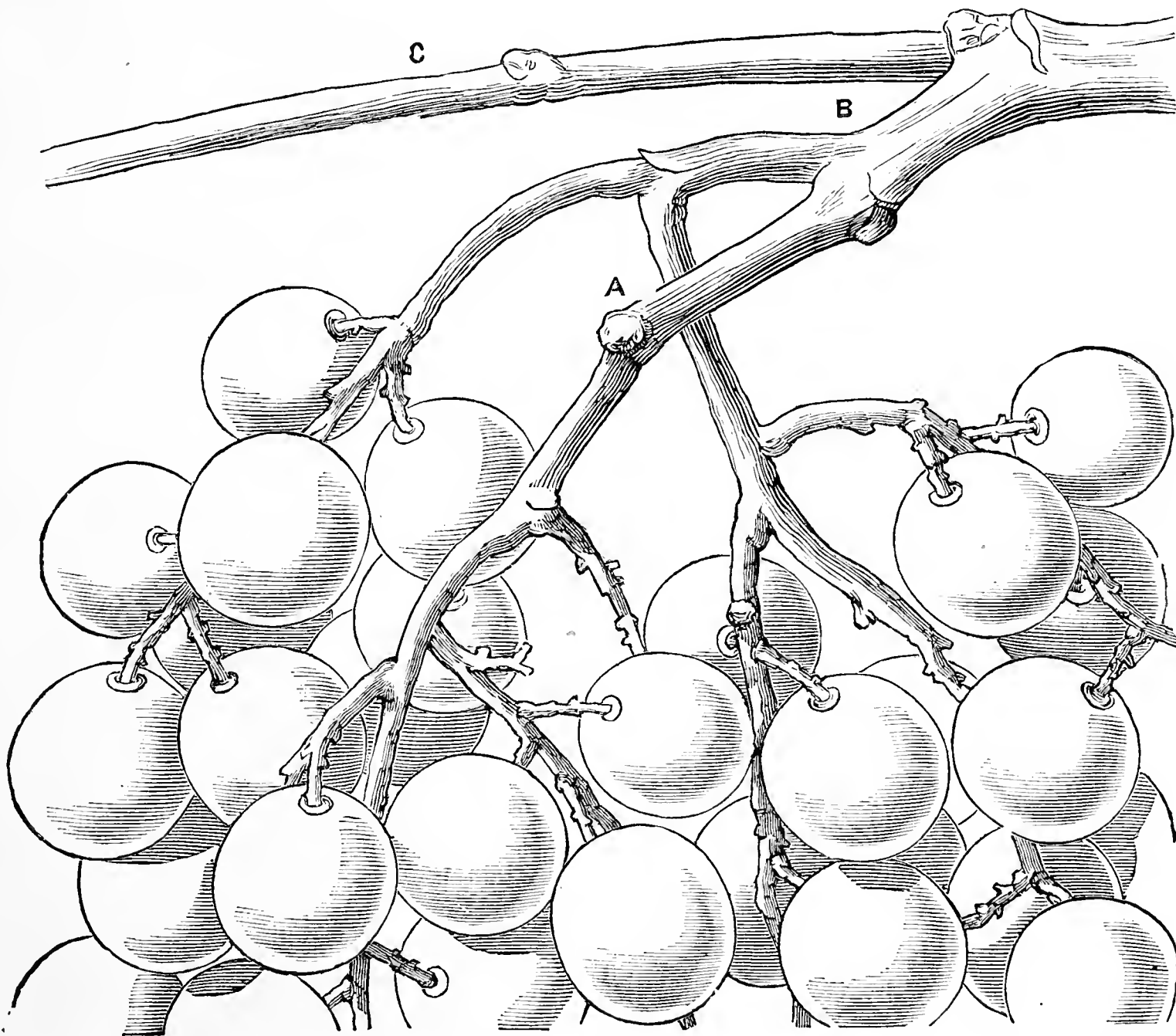

Fig. 13.—CLUSTER OF GRAPES.—A, Lateral stopped at the first bunch ; B, second bunch produced ; C, second break or sub-lateral, forming leading shoot.

at C, instead of the first that formed ; and the end of the first shoot, which of course is soft, green, and pliable, is appropriated as it were by the two bunches to wed them together and form the stalk to the united bunches. Anyone feeling sceptical on the subject can try it for themselves this spring and summer. I am far from condemning the practice—on the contrary, strongly commend it, especially to those who wish and are expected to grow large clusters of fruit, and where three bunches show on a shoot the clusters may still be had heavier by stopping at the third instead of the second bunch. Another interesting point in Grape culture which this practice demonstrates is the fallacy of the old, and for that modern teaching too, that it is quite necessary to have two or three leaves ahead of the bunch to secure perfect

development of berry. To show that this condition is not absolutely necessary to produce first-quality Grapes, I may mention that often in carrying out their practice the shoot does not break the second time, and the bunch is left with only the three or four leaves between it and the stem of the Vine, and it not unfrequently happens that these prove to be some of the best clusters in the vinery.—DRUID.

FILMY FERNS AND THE FROST.—It is no small recommendation to the more extended culture of this charming section of the Fern tribe that the majority of those in cultivation ignore coddling and fire heat altogether, and will not wince even with the mercury in-

clined to touch zero. Looking in last week at that very interesting compartment, the Filmy Fern house at Glasnevin, nothing could look more happy than the *Todeas*, *Hymenophyllums*, and other pellucid beauties in their garniture of richest green, profusely beaded with diamond dewdrops, notwithstanding that in their cool and humid quarters there must have been in the previous week some fifteen or more degrees of frost.—(*Irish Farmers' Gazette.*)

DO AQUATICS LIKE MANURE?

THIS always seemed questionable to me till I saw the beneficial effects of good soil and culture upon some plants of *Menyanthes* found in a swamp in Ashdown Forest. Wonderful as was the change wrought in them by a single season's care, yet the result was by no means conclusive, for mere wildings growing in an exposed situation amongst a crowd of other plants are unlikely to grow so freely or to become so robust as they do when a special station is given them in a sheltered pond. Last summer, however, the matter was settled beyond dispute: a sewage pipe burst near the pond containing the principal collection of aquatics, and the sewage ran into it through an open-jointed land drain. For some weeks before this was known the extraordinary vigour of several of the plants attracted notice. A little plant of Water Violet planted in the spring had become a square yard of stout vigorous branches, while three others planted at the same time in separate ponds had only made a few new shoots in the ordinary fashion. *Calla palustris*, *Pontederia cordata*, *Villarsia nymphaeoides*, and others planted near the mouth of the pipe through which the escaped sewage entered the pond all showed such unwonted vigour as to extend far beyond the bounds assigned them, becoming crowded and somewhat unsightly; for aquatics never look so well as when each plant or group stands out clearly from the others margined by clear water. At length the discoloration of the water and its foul odour showed the probable cause, and the sewage pipe was repaired.

Although it was thus made clear that aquatics do like manure, it by no means follows that its use is desirable either in a solid or liquid form, excepting, perhaps, for the promotion of quick strong growth in a newly planted pond, or when it becomes desirable to increase stock quickly in a nursery garden; for mere size in this class of plants does not constitute beauty, a coarse rank growth tending to rob many of them of the elegance and refinement of their normal condition. The Arrowheads and Callas are the probable exceptions, for it may safely be said of all of them that beauty grows with size. Certainly I have never seen the double Arrowhead so fine as it was this year both in foliage and flower.

Twice have I lost the Water Violet from its being overgrown and killed by other plants, its growth without manure being very slow and so fragile as to be liable to destruction from a variety of causes. Now, however, I have enough in a single season to stock a dozen ponds, and intend to fill a little pool with it for future emergencies.

Since writing the above I have read in Burbidge's "Cultivated Plants, their Propagation and Improvement," that "it does not appear to be generally known that manure has a wonderful effect on the common white *Nymphaea alba*, causing it to grow with tropical vigour, and produce leaves and flowers twice the ordinary size, and so distinct in appearance that one would readily imagine plants so stimulated to be a distinct variety." This statement appears to me so important that it is worth quoting.—EDWARD LUCKHURST.

THE COLOURS OF FLOWERS.

DECANDOLLE'S opinion that "blue and yellow being the two primitive colours of flowers, and always exclusive of each other, no blue flower ever changes to yellow nor yellow to blue," certainly needs some modification to bring it into accordance with well-known facts, and, as "C. M." suggests at page 591, last volume, the subject is well worthy of consideration to determine upon what grounds that statement was founded. A few preliminary observations upon the origin of colours may, however, not be out of place.

The rich tints of yellow and red assumed by leaves in autumn have been considered by many botanists, chemists, and others to be due to the varying oxidisation of the chlorophyll, which gives the colour to green leaves, and that similar changes are effected in this way has been proved by the fact that the sap of some plants is greatly altered in tint upon exposure to the air, such changes being, however, prevented when the cut portions of plants are at once plunged into a liquid or gas which does not contain any oxygen. Though the colouring matters of flowers differ in constitution from the ordinary green chlorophyll of leaves, yet the

red or yellow substances in leaves have been found to be chemically similar to the same tints in petals or bracts, and on that account they have been considered due to the same cause—namely, oxygenation. Upon these facts the classification of colours adopted by Decandolle was founded. This was originated by Schubler and Funk, who classed them in two series, the "oxydised" and the "disoxydised," termed by Decandolle respectively the xanthic (yellow) and cyanic (blue) series. These were arranged as follows, excluding white as a negative condition and green as a combination of the two series. Xanthic: red, orange-red, orange, orange-yellow, yellow, yellow-green. Cyanic: greenish-blue, blue, violet-blue, violet-red, red. From the observations then made it was considered that the range of variation in the flowers of a plant would be confined, with few exceptions, to one of these series, and how far that is the fact will be discussed further on.

Different views have, however, been held regarding the cause of variation in colours. Thus it has been observed that the expressed juice of most red flowers is blue, and this is supposed to be due to the colouring matter being reddened by carbonic acid which escapes on exposure. "The same blue-colouring matter as that of the Violet exists in many other flowers, and seems also to form the most usual red of the red flowers, in which it is apparently reddened by an acid, for many of these reds become blue when neutralised by an alkali, and green and yellow by an excess of alkali."—(*Brande & Taylor's "Chemistry."*) The application of vegetable blues, such as litmus, as tests for acids, is well known; acids cause the blues to become red, and alkalis restore the blue colour. Other investigators have concluded that there is only one colouring matter, which is termed chromogen, consisting of two principles, one forming a red compound with acids and the other a yellow with alkalis, the green being produced by an admixture of blue with the yellow. But one of the latest writers upon the subject, Mr. Sorby, notices the similarity in many instances of the colouring matters in flowers to those in leaves from which the chlorophyll has disappeared, and considers that such matters are already contained in the tissues of plants, and only require to be variously modified to produce all the tints which render flowers so attractive. He states, "The facts seem to indicate that these various substances may be due to an alteration of the normal constituents of leaves. So far as I have been able to ascertain, their development seems as if related to extra oxidisation, modified by light and other varying conditions not yet understood." The two last theories seem to be partially in accord with that first mentioned, and it may be well to endeavour to ascertain how far they are borne out by facts.

To form an idea of the range of variability of plants we cannot select any better fitted for the purpose than those which have been some time in cultivation, and which have been the special objects of horticulturists' attention. In the improvement of those plants hybridising has had an important effect, and results have been obtained within the average life of a man that, judging by the extent of the divergence from original types and the comparatively slow manner in which such changes are effected in a natural state, would probably have taken centuries to produce without artificial selection and assistance. In races of plants that have been cultivated for hundreds of years we might expect an even greater range of colours than of other characters, and that is so; yet notwithstanding the prolonged careful efforts to extend the range of colours, it is surprising how closely they keep within certain lines, corresponding in some measure with the xanthic and cyanic series already mentioned. To exemplify this I have selected the following as amongst the best known kinds or races of plants that may be classified under five heads: 1, Those having varieties with yellow and blue self or parti-coloured flowers; 2, Those with yellow or orange flowers, but excluding blue; 3, Yellow or orange with purple; 4, With blue flowers, but excluding yellow; and 5, Purple, exclusive of yellow. In this way the plants will rank as follows:—1st, Pansies, Violas, Hyacinths, Crocuses, Iris germanica, Aquilegias, and Auriculas; 2nd, Tulips, Azaleas, Carnations, Roses, Tuberos Begonias, Abutilons, Antirrhinums, Fuchsias, Helianthemums, Gladioli, Lantanas, Narcissuses, Rhododendrons (greenhouse hybrids), Chrysanthemums, Calceolarias, Bouvardias, and Potentillas; 3rd, The first eleven of the last series are also included in this, together with *Primula vulgaris* and *acaulis* and Picotees; 4th, Canterbury Bells, Cinerarias, Achimenes, Clematises, Delphiniums, Gloxinias, and Verbenas; 5th, Pentstemons, Petunias, Phloxes, *Primula cortusoides*, Rhododendrons (hardy), Pelargoniums, *Primula sinensis*, and Balsams. Thus, in forty-one examples we have only seven, including both blue and yellow, while there are seventeen possessing yellow, but excluding blue. It is curious, however, that eleven of the latter should possess purple tints, which may be considered as varying only in the proportion of blue they contain, red-purples being more common

amongst them than blue-purple. Amongst them are two of the oldest genera in florists' flowers—namely, the Tulips and Roses, which have long defied all our skill to eliminate the red from the purples they contain. Blue flowers, excluding yellow, are comparatively few, only seven examples being given above, and the last of them is slightly doubtful, as Verbenas often have strongly marked yellow centres. But with the eight having purple and no yellow flowers, which might almost be ranked with the last, we have a total of fifteen, excluding yellow from association with blue or blue tints. The results will stand thus—yellow combined with blue or purple, 18; blue or purple excluding yellow, 21. Not taking the purples into consideration, however, the results are much more striking—that is, blue and yellow combined, 7; blue without yellow, and yellow without blue, 25—a sufficiently large proportion to indicate that there is somewhat more than mere chance in the separation of these colours.

It may be observed that the foregoing are mostly varieties or hybrids of a few species, but some are varieties of but one; and in estimating their colours chief regard is paid to self-coloured flowers, and those in which the limb of the corolla are distinctly coloured, the markings in the tubes of monopetalous corollas not being considered, as in most instances they are comparatively unimportant. However, yellow frequently occurs in these tubes, but usually when the limb is red, and seldom in combination with blue, which is more frequently attended by white. The next point deserving attention is the proportion of blue to yellow-flowered species in the same genus, but first a few peculiarly changeable species deserve notice, and a few of these are most directly opposite to the Decandolle theory, that "no blue flower ever changes to yellow, nor yellow to blue." One of the best known and most remarkable is *Myosotis versicolor*, the flowers of which are at first yellow, then becoming blue, and finally purple—an extraordinary change in one flower, for though the flowers of many other members of the Boraginaceæ family are changeable, the progression is usually from red to blue and purple, as in *Echium vulgare*, *Achusa sempervirens*, and *Myosotis repens*. Still self-coloured flowers of the most pure yellow and blue tints occur in the same order and in closely allied genera, though not exhibiting this changeability. In another family *Cheiranthus chamaeleo* is a peculiarly varying species, the flowers opening white, advancing to yellow, red, and violet, thus having a similar range to the *Myosotis*. This is the most remarkable phenomena in the colouration of flowers; and were it more frequent in a similar direction to *Myosotis versicolor* there would certainly appear to be no rule regulating the exclusion of yellow or blue respectively. This is far from being the case, and in the majority of colour-changing flowers the evidence is more in its favour than otherwise, as in *Hibiscus mutabilis*, the flowers of which expand green, becoming white at midday, and advancing to crimson in the evening.—L. CASTLE.

(To be continued.)

SOLANUM HENDERSONII.

THE above is one of the best of the berry-producing plants commonly called Christmas Cherries. For decorative purposes during the Christmas festivities they are very useful and appropriate objects. Having been fairly successful in their culture I give my experience for the benefit of others.

To commence with the seeds. These should be sown early in January if useful-sized and well-berried plants are to be secured the first season. However, those not having a genial temperature at command, say 55° to 60°, had better wait until they can command such. Sow the seed thinly in a pan or pot, covering the seed with some finely sifted soil. The pot should have a good drainage of potsherds. The seed, if good, germinates freely in the above-mentioned temperature, bottom heat not being necessary. When the seedlings are well advanced they should be placed singly in thumb pots. Any good soil suits them well.

All that is necessary to secure good plants is attention to watering, potting as required, thinning the berries when a sufficient number have set, and pinching and regulating the growths from time to time. The best sized pot and one in which they may be grown large enough for decorative purposes is a 6-inch pot. As to the shape in which they are grown, that is a matter of taste with the cultivator. They may be grown successfully in the bush form or as standards; I prefer the latter. With about 6 inches of clear stem they are very attractive as standards. When the pots are filled with roots, being gross feeders, they cannot be too liberally supplied with water. Diluted cow urine given every other watering when the pots are well filled with roots is very beneficial. During bright sunny weather a good syringing with tepid water about 4 P.M. each day is also beneficial. Occasionally

fumigating with tobacco paper will keep down any green fly that appears; this insect seems to be the only one troublesome.

With such treatment as I have endeavoured to describe good results may be obtained the first year; and if the cultivator can command a genial temperature, they may be kept in tolerably good condition up to the following February. The second year, however, far better results may be obtained. In the second year's treatment proceed thus:—When the plants begin to look shabby cut them well back and place them in a genial temperature until such time fresh growths are produced. This taken place, shake all the soil from the roots and repot into the same sized pots. A good portion of the roots may be advantageously cut away with a sharp knife before potting.

They may be planted out during the summer, lifted and repotted again in the autumn. However, with the uncertain summers we have, it is preferable to keep them under glass, far better results being so obtained.—J. RICHARDSON, *Calverton Hall*.

A BOTANICAL RAMBLE WITH THE LATE MR.

J. SADLER.

A TOUCHING sketch of the late Mr. John Sadler, Curator of the Royal Botanic Gardens, Edinburgh, from the pen of our valued correspondent, Dr. Stuart of Chirnside, appears in the *North British Advertiser*, from which we extract the following graphic descriptions of botanical excursions made in Mr. Sadler's company. Speaking of the discovery of *Salix Sadleri* Dr. Stuart says:—

"We had almost crept along the precipitous ledges running from the Break-neck Waterfall, at the head of Glen Callater, which extends towards the weird-looking inky tarn, gathering *Carex rupestris* and other rarities. The day was grey and very windy, and our footing on such steep ground was far from secure. John Sadler took to the steep grassy ledges facing the north-east side of the lake, and ascended for about 1000 feet, from one ledge to another. The climbing was not so difficult, but the getting down was another matter, especially as the way was obscure, and not without risk did he make the descent, bringing with him cuttings of the Willow and a *Carex* never before gathered nearer than the Swiss Alps, and named *Carex frigida*. Both were submitted to Dr. Boswell Syme, LL.D., who pronounced the Willow new to Britain, and named it *Salix Sadleri*, after the discoverer; and the *Carex* also proved a species new for Britain. A plant of the Willow is growing on the Rock Garden, Botanic Gardens, Edinburgh, and the *Carex* has also been cultivated with success.

"The favourite quarter of our departed friend in the north was Bridge of Lochay inn, half a mile from Killin, on the road to Kenmore. Picturesquely situated on the river Lochay, and overshadowed by the Finlarig woods and the everlasting hills, this quiet retreat has been a welcome sight to many a weary botanist; and Mr. and Mrs. Cameron have ever a kindly welcome for the whole brotherhood. Ben Lawers, Maol-na-Ptarmachan, Cam-a-Creag, Maol Ghirdy, Craig Mohr, &c., are within reach, and their alpine flora is the richest in the kingdom. Here Mr. Sadler has conducted many a happy party, and introduced many an ardent botanist to the beauties of Flora in this classic region. No one can ever forget the pleasure of a first excursion to Cam-a-Creag and Maol-na-Ptarmachan, and the delight with which he saw growing the snowy Gentian, the mountain Forget-me-not, the 'himmel' blue of the mountain Veronica, the green of the Spleenworts which fringe the moist crevices, the alpine Willows and mountain Saxifrages, the rare *Woodsia hyperborea*, &c. Here, on the mica schist, in a state of disintegration, there is a growth observed and a vigour attained by these alpine seen nowhere else. Wherever our party began operations, even in the far north, the finish to the excursion was generally at Bridge of Lochay; for whether at Ben Lawers, Cam-a-Creag, or Craig Mohr, there is always, if the weather proves favourable, a grand excursion to be had. It would be difficult to relate how often Mr. Sadler made returns to his favourite ground; at all events, he never tired of renewing his acquaintance with the alpine flora of the district. In the year 1876 we visited the West Highlands, and ascended Ben Nevis on a very stormy day. Botanically we did little. On the following day the precipices under the peak were examined, *Saxifraga rivularis* and *Juncus castaneus* being the best plants obtained, close to the melting snow.

"Mr. Sadler did not like Ben Nevis much, so we returned through Glencoe, and got to Tyndrum early next day, proceeding to Bridge of Lochay partly by rail. In the evening we hired a vehicle and drove up Glen Lochay to a deserted farmhouse named Chirrai. Climbing up the grassy bank covered with sweet-scented *Gymnadenias* (*G. conopsea* and *G. albida*) and Butterfly Orchises, we came to the roofless dwelling. Our friend, ten years before, when botanising, had lived here among the herds, and, looking down, began in his humorous strain to describe his experiences. In the big kitchen lived the master and mistress, with half a dozen herds, and a number of lasses to mind the dairy work. Our friend occupied the other end, and pointed out the remains of a wall press where he kept his plants. At night the herds retired up a ladder or 'trap' to one side of the

loft followed by about half a dozen colliers; the lasses retired up the same 'trap' to the other side of the loft. Shortly the snoring of the sleepers was appalling, but worst of all the dogs first commenced to snarl and then to fight in earnest: clouds of dust descended through seams in the boarding upon the devoted head of our friend, who was only too delighted when day broke, and he was able to extricate himself from his difficulties and breathe the pure air of Maol Ghirdy. I feel how vain on my part it is to describe the recollections of the scene as related at the time, but I have endeavoured to give a sketch of an actual adventure which our friend had, and he had many such to relate. We returned down Glen Lochay on a lovely summer night to our hostelry, and it is difficult to realise that the man who had kept us all amused has passed away from among us almost in his prime.

"His popularity among the students attending the botanical class is too well known to require to be noticed. At the weekly excursions he was their genial companion, and did everything to inspire them with a love of nature and the interesting science they were studying. It is sad to think that the bright career that was before him as Curator of the Botanic Gardens and Arboretum—work so congenial to his nature—should have been so suddenly closed by his untimely death. Providence has so ordered it; but his memory will ever remain green in the hearts of many true friends, who have spent happy days in his company in climbing most of the Scottish mountains in pursuit of their favourite science.

'Fell star of fate! thou never canst employ
A torment teeming with severer smart
Than that which memory pours upon the heart,
While clinging round the sepulchre of joy.'

—C. STUART, M.D."

WRITERS ON VINE CULTURE.

I THINK you, most head gardeners, under gardeners and foremen of any pretension or status, and most amateurs, will agree with me that Grape culture, especially varieties of Duke of Buccleuch, Madresfield Court, have had their culture especially well discussed during the past twelve months in your columns. Let me suggest, especially to those writers who have lately become very personal in their criticisms of other gardeners' suggestions, to entirely leave off writing on this subject for a time, and instead to practise the many good hints that have been printed from known and respected professionals in Grape culture.

Let me suggest to a number of these writers that nearly all of us want some practical hints on other things; and I beg to suggest to amateurs and professionals a subject wanting all their powers to cope with it—viz., the extermination of all sorts of garden vermin, especially out-of-door pests. This subject will stand some thrashing, with many others in your columns which have been so generously given up to Grape culture, a fruit, by-the-by, that is being erroneously overdone everywhere, as the price of them from August 1st to November 1st has proved the last few years.—SAXORING.

I DO not know when I have been more interested than in reading the articles on Grapes that have lately appeared in the Journal, and I feel certain as a young gardener searching for information that I shall be able to turn some of the valuable hints to profitable account. If I can succeed, as I now think I can, in growing those grand varieties the Duke of Buccleuch and Madresfield Court, this alone will repay me for investing in your useful Journal. The instructions on ventilation, pruning, and watering I have never seen so clearly stated before as during the last twelve months, and I trust those cultivators who have been successful in growing what may be termed fickle kinds of Grapes will not fail to point out any special items of treatment that may be needed in the future as they have done in the past, as there are hundreds besides myself who do not yet know all they wish to know about this important fruit. I think to fail in Grapes is to fail altogether or nearly so in gardening, and I wish to succeed.—J. PAGE, *Barnet*.

HORTICULTURE IN 1882.

AT this season of the year, when persons of all classes are taking stock of the past, are balancing their accounts, and seeing how they stand with regard to the coming year, it may not be altogether unprofitable if we do the same with regard to that pursuit in which, in some of its many branches, we are all interested, and ask, What has been the position of horticulture during the past year and what are its prospects?

It was hardly to be expected that at a time when an undefinable but still very patent depression exists in all departments of commercial enterprise, when the reaction from the "lumps and bounds" of an inflated prosperity has told so evidently on all, when to the ordinary causes of that depression is added that

which has so materially affected the land and all connected with it—viz., the strange cycle of unfavourable seasons, should not very seriously interfere with horticulture, and especially with the maintenance of the gardening establishments of our nobility and gentry. In very many instances that have come under my own observation, and doubtless but samples of many more, I have seen lamentable reductions in the staff, and a consequent falling-off in the appearance of the garden; while in others, although the staff has been maintained and the gardens exhibit the same appearance as before, yet it has been done by turning my lord into a market gardener and nurseryman combined, for we know of princely establishments where well nigh anything of fruit and flowers can be purchased; and I cannot but think that some symptoms of this restricted expenditure has had something to do with the falling-off (for such there has been) in our great metropolitan exhibitions. The growing of plants or flowers for exhibition is a luxury, and luxuries are the first things to be curtailed. I do not think that the shows of our two great royal societies have been anything like what they were, while those who recollect what the exhibitions at the Crystal Palace were in Mr. Bowley's or Mr. Wilkinson's time must write "Ichabod" on them now.

Of provincial exhibitions the palm must as usual be given to Manchester, but, even there, there was a falling-off. Of the other provincial shows, Edinburgh (if the northern metropolis will suffer itself to be classed amongst provincial towns) was undoubtedly the star of the year, although far short of the magnificent autumn exhibition held at Manchester in 1881; but I have not in my recollection known one which has given rise to more controversy as to the character of the judging. As far as my experience of provincial flower shows goes the West of England, Bath, Taunton, Weston, &c., are carried on with the most spirit and obtain the greatest measure of success.

Turning from flower shows to flowers, I do not think that during the past year we have seen any very startling additions to either our plants or flowers. Of course many beautiful things have been in both exhibited, but nothing of that surpassing character which marks an epoch in our gardens. Orchids still seem to be as much in demand as ever; and although some well-known collections are dispersed yet others are springing up in all directions; while the continuous importations which are week after week brought to the hammer at Stevens's are rapidly cleared off, and one would almost think that their native habitat must soon be cleared out. Thousands of *Odontoglossums*, *Cattleyas*, &c., are offered for sale, and that not in single bulbs but in large clumps; and the well-known exuberance and quickness of growth of tropical vegetation must be stretched to its utmost limits to make up the gaps made by ardent collectors, who have respect more to the money's worth of what they are collecting than for any sentimental notion about despoiling the native forests, &c., of their beauty. To my mind the most extraordinary "craze" of the year has been the rush for single Dahlias. When raisers of seedling Dahlias can look back and recollect how deliberately every single flower was forthwith pulled up they must be amazed to find that the rejected of former years are the favourites of to-day. They are all very well in their place. A few of five or six different shades of colour in any moderate-sized garden are very desirable; but to have our gardens crammed with them, to grow them, as some growers for sale, by the acre, to see nothing but single Dahlias in vases, is a little too much for one's nerves; and worse still, to hear the grand and brilliant double Dahlias decried for the sake of exalting these humble brethren, is making matters worse. I have heard of one city house where a bundle of these were shown in a vase in the window, and in three days orders were received for 780 plants. The craze has, I think, been evidently encouraged by the granting of seven certificates for single Dahlias in one day by the Floral Committee.

The attempt to revive an interest in florists' flowers in the south has been successful in one direction, although a failure in another. The Dahlia Show at the Crystal Palace was an instance of the former, the Pink Society of the latter. A meritorious attempt to inaugurate one was made, but it was found that while money enough could be obtained there were not exhibitors sufficient to make a show. The Auricula and Carnation Societies have both made progress. The exhibitors from the southern part of the kingdom are, however, still too few to justify me in saying that the revival of the culture of florists' flowers has become very active.

The close of the year always leads us to look back on the gaps that death has made amongst us, but happily this season we have to record the loss of fewer names in the horticultural world, as distinguished from the scientific, than usual. An enthusiastic florist, Mr. George Smith of Edmonton, whose last public act was

the origination of the Crystal Palace Dahlia Show, and whose health had for years been feeble, died before he was able to see the accomplishment of the work he had undertaken. The death of Mr. Robert Osborn, the last member of his family, at an early age, led to the breaking-up of one of the old historic nurseries of the metropolis—Osborn's of Fulham; and so has followed, although from a different cause, in the wake of Glendinning's of Chiswick and Rolleston's of Tooting. One does not like to miss these old familiar names who did real and good service to the cause of horticulture in days gone by; and amongst horticulturists all over England there was no name that stood higher for probity and honourable dealing than that of Osborn of Fulham.

Such are some of the points which have presented themselves to me in connection with the past year. Looking at it in a horticultural point of view there is nothing to discourage and much to encourage us in our onlook. Never was the love of flowers so great amongst us as it is now; and although, as is usual, there are some eccentricities, yet on the whole taste is, I think, improving. Less and less grow the polychrome beds of colour of the bedding-out system; more numerous become the herbaceous beds and borders. Old-fashioned flowers are once more in favour. We go into gardens now where we can catch the delicious fragrance of the Sweet Pea, Mignonette, or Lavender; and although there are some who are inclined to ride this hobby to death, yet on the whole horticulture is vastly benefited by the change. May all the readers of the Journal have a good time in their several departments in the year on which we have now entered.—D., *Deal*.

RICHARDIAS.

THE glowing accounts of the grand successes of our great plant-growers cause their less fortunate brethren to heave many a sigh. They eagerly read such accounts in search of cultural details that may lead them to a similar result. I have experienced this myself in reading the pages of the Journal, which I have done for twenty years, and it is pleasant to succeed in accomplishing an object. I have lately read a paragraph by one of our leading plant-growers, in which plants grown in pots all the summer are described as superior to those that have been planted out and potted in the autumn. In my small stock of fifteen plants I found on December 18th last, twelve were showing spathes, and seven had fully expanded spathes. These were planted out about the middle of May in the kitchen garden. The roots were not disturbed, but some old potting soil was packed round them. An occasional watering in dry weather was all the attention they received till they were again lifted the second week of September. They were placed in 6 and 8-inch pots, stood on a plank behind a north wall, where they were syringed twice a day in bright weather. Early in October they were placed in a late Peach house, but free from frost, and where the syringing is continued on the mornings of fine days. By the third week of October the roots had taken possession of the soil, and a few of the plants showing bloom. The plants were then removed to an early vinery, the temperature ranging from 40° to 55° according to the weather. This is all the forcing that was necessary to produce the result above stated.—R. INGLIS.

REVIEW OF BOOK.

Text Book of Botany, Morphological and Physiological. By JULIUS SACHS. Edited by Sydney H. Vines, M.A., D.Sc., F.L.S. Second edition. Oxford, The Clarendon Press, 1882.

The first English edition of Sachs's "Text Book of Botany" has been for some years out of print, and the botanical public have been eagerly looking for the second, which now reaches us under the able editorship of Dr. Vines. The work is so universally recognised as the best text book for advanced students in botany, and is so widely known, that any criticism or even description of its general scope by a reviewer is needless. As compared with the first English edition, which bears the date 1875, it indicates the marked advance which botanical science has made in the interval. It has long been admitted that it is in investigations of the lowest rather than of the highest forms of either vegetable or animal life that the philosophical physiologist and evolutionist must seek to gain insight into the mysterious laws, still so imperfectly known, which underlie the phenomena of organic life, and which connect together the links in the endless chain of living beings. The study of cryptogamy has in consequence found of late years many ardent followers both in this country and on the continent, and our knowledge of some of the lowest forms of vegetable life has been greatly enlarged. The increased attention paid to this branch of botany is manifested by

the large space devoted to it in the volume before us, and by the variation in its treatment from that which it received in the earlier edition. As regards the primary classification of cryptogams, or rather of their lowest section, the Thallophyta, Prof. Sachs is an able advocate of the system, now widely followed in Germany, of discarding the familiar classification into Fungi and Algæ, dependant on the absence or presence of chlorophyll. Considering this not to be a differentiation which underlies any necessary great difference in organic structure, but rather an adaptation to external conditions, he divides the Thallophytes—*i.e.*, everything below Mosses and Liverworts—into four classes, distinguished essentially by their mode of reproduction—the Protophyta, Zygosporæ, Oosporeæ, and Carposporæ, in each of which are two parallel series, one autonomous and containing chlorophyll, the other parasitic and destitute of chlorophyll. In accordance with the researches of Schwendener and others, Lichens are deposed from their position as a primary class, and described as a section of the Ascomycetes, themselves an order of Carposporæ. All Lichens are, in fact, regarded as illustrations of that singular commensalism or symbiosis of which so many examples have lately been detected in both the animal and vegetable kingdoms; in this instance consisting of organisms destitute of chlorophyll (Fungi), parasitic on those that contain it (Algæ).

Although it is more and more fully recognised that scientific knowledge must lie at the base of all sound horticulture—that the horticulturist must be a botanist before he can be a successful horticulturist—yet anyone practically engaged in horticulture will naturally turn with special interest to that portion of this bulky volume, about one-third of the whole, which is devoted to those problems of physiology which puzzle him or which exercise his attempts at solution, as he comes across them in his daily avocations. And he will find abundant food for thoughtful study in the chapters with the following headings:—Molecular Forces in the Plant; Chemical Processes in the Plant; General Conditions of Plant Life; the Mechanics of Growth; Periodic Movements of the Mature Parts of Plants and Movements dependant on Irritation; the Phenomena of Sexual Reproduction; the Origin of Species.

It might have been wished that Prof. Sachs had adopted Darwin's admirable plan of giving at the close of each section of his works a summary of the results obtained. In the absence of such summaries we may illustrate his mode of dealing with his subject by the following general statement of the phenomena connected with periodically motile and irritable parts of plants.

"It is remarkable that all organs at present known as coming under this category are, in a morphological sense, foliar structures—as green foliage, leaves, petals, stamens, or occasionally parts of the carpels (styles or stigmas). It is the more striking that no axial structures or parts of stems are contractile in this sense, because the contractile parts of leaves are usually cylindrical, or at least are not expanded flat, and therefore possess the ordinary form of an axis. There is this further agreement in the anatomical structure of all parts which exhibit these phenomena—that a very succulent mass of parenchyma envelopes an axial fibrovascular bundle or a few bundles running parallel to one another, the elements composing these bundles being only slightly or not at all lignified, therefore remaining extensible and flexible—a fact of importance in reference to the possibility of the movement, which consists of flexions upwards and downwards, generally in the median plane of the organ; the fibrovascular bundle thus forming the neutral axis of the curvature. The mass of parenchyma which envelopes the fibrovascular bundle often has the form of a pulvinus, and does not contain in its outer layers any air-conducting intercellular spaces, or only very small ones; while in the inner layers they are larger, especially in the immediate vicinity of the bundle, these being, according to Morren, Unger, and Pfeffer, wanting only in the irritable stamens of Berberis and Mahonia. The tension of these layers of tissue, which is generally very considerable, is caused by the stronger turgidity of the parenchymatous cells on the one hand and the elasticity of the axial bundle and epidermis on the other hand. As far as observations go at present, especially those made on the larger contractile organs, the tendency to extension is greatest in the middle layer of the parenchyma between the epidermis and the axial bundle, but the elastic resistance of the epidermis is less than that of the bundle."

One great value of this work is the copiousness of the references to the most recent and trustworthy memoirs on special departments of the subject. Its main purpose is to describe the phenomena of plant life which are already accurately known, and to indicate those theories and problems in which botanical research is at present especially engaged. It would obviously defeat this object if special points were gone into too much in detail; but

with the aid of these references the reader will be able to do this for himself. To anyone who wishes to keep himself abreast of the most recent developments of botanical science the work is indispensable.

HYACINTHS AND TULIPS FOR EXHIBITION.

HYACINTHS and Tulips that have been plunged under cocoa-nut fibre or ashes, and wanted for exhibition or to bloom from the middle to the end of March, will require removing now from the plunging material. As a rule I remove ours on the 20th of this month, and allow the small pots which cover the crowns to remain over them for a few days longer to gradually inure them to the light, or the foliage is liable to crack near the bulb; besides, from a sudden transmission from the plunging material to a strong light the tips of both the leaves and truss are often permanently injured. For some little time they will not require water unless the soil is very dry, which is seldom the case after passing through a mild wet season like the present. When they require water it may be given copiously, and weak liquid manure will also greatly assist in giving strength and a green lustre to the foliage. A good Hyacinth should have a strong bold truss thrown well above the foliage, which should be dwarf and rigid.—J. W. MOORMAN.



[By the most skilful Cultivators in the several Departments.]

KITCHEN GARDEN.

WHEN the forcing of vegetables is commenced there should be no deficiencies in the supply until the outdoor crops are ready. A good supply of hotbed material is now required, and with plenty of this and a few frames and lights no one will find it very difficult to raise vegetables; but in forcing for the table a succession of small quantities is much better than having large batches coming in at long intervals. Sow successions of whatever is likely to be scarce. Admit abundance of light to all young plants.

A few rows of early Carrots may be sown on a south border. The drills for the reception of the seed should not be more than 2 inches deep, and if they are filled with river sand the young plants will progress better than if covered with cold soil. Spinach may now be sown; a double row should be put in each space between the earliest-sown Pea rows. This is one of the quickest vegetables to gain maturity, and where other spring vegetables are scarce it should be sown in large quantities. More Radishes should be sown at the base of a wall; extra firm ground causes them to bulb early. A pinch of Cabbage and Brussels Sprout seed may be sown in a sheltered corner. Our earliest seed is sown in rows, and as soon as the plants can be seen above ground a little bank of finely sifted ashes is placed along each side of the rows. This effectually prevents the slugs doing any injury, and it affords shelter from the wind as well. We advise the application of this to all tender young vegetables in the spring months. Where autumn-sown Onions are scarce or have failed, and their absence is likely to be felt in spring, seed must be sown at once. The variety should be one usually sown in spring, and a large number of plants may be raised in a few 6-inch pots in very gentle heat, but a cold frame is their proper place as soon as the plants are through the soil. By March they will be large plants, ready for placing in the open quarters, and they will be ready for use long before those sown out of doors. This is a good way of forwarding Onions to be shown throughout the season as "spring-sown."

Early Cauliflowers and plants of this kind may be raised with advantage in this way. Young vegetable plants which have been wintered in frames and under handlights show signs of resuming growth, and air must be admitted on every favourable occasion; keeping the atmosphere close about them, and covering them at night when such protection is not wanted is often the cause of failure.

Where Asparagus roots were not mulched in autumn it should be done forthwith. If 4 lbs. of salt and 4 lbs. of guano are mixed to every hundredweight of dry ordinary manure and spread over the beds to the depth of 3 inches the benefit will be considerable.

Mushroom beds should be formed whenever any material for making them can be had. Lately we have been most fortunate with beds in cool sheds. In preparing the manure more litter is left with the droppings than is generally the case, and this has proved to be a great advantage. The beds cannot be made too firm, as the longer they retain the heat the better. As soon as they are spawned and soiled a covering of hay about 1 foot in thickness is kept over them until bearing ceases, and changing this covering when it becomes too damp is the whole of the attention they receive.

Those who allow their vegetable gardens to remain in a semi-dormant state in winter should be stirring for a good and early start in spring. All seed lists of any importance have now been received for the present year, and orders should be made up and dispatched quickly.

FRUIT-FORCING.

Peaches and Nectarines.—In the house closed in November, and in which fire heat was commenced early in December, the flowers are now fully expanded, and in some instances the fruit set; but the temperature should still be kept at 50° at night and 55° by day, allowing an advance from sun heat to 65°, accompanied with free ventilation. Continue artificial fertilisation as the pollen becomes ripe; and as the large-flowered varieties are frequently deficient of pollen as compared with the small-flowered sorts, it should be taken from the latter and applied to the stigmas of the former. Continue damping available surfaces in the house as they become dry, but until the fruit is set syringing the trees should not be practised. Disbudding must be commenced so soon as the shoots are sufficiently large to be rubbed off, which should be done gradually, so as not to give any check to the trees. It is necessary to have a growth on a level with or above the fruit, which, when it has made a leaf or two of growth, should be stopped, and another will need to be retained as near the base of the present bearing wood as possible to replace it for next year's bearing. Provision will also be needed for trees extending, so as to originate growths at the proper distances for furnishing the trees—*i.e.*, main shoots at 12 to 15 inches, and bearing shoots at 15 to 18 inches distance upon the main shoots of last year, so as to obtain a supply of bearing wood.

The trees started at the beginning of the year are now swelling their buds fast, and if there be Strawberries or other plants in the house likely to harbour green fly, fumigate so as to destroy the pests before the flowers expand. Continue syringing the trees until the flowers expand. The temperature must be maintained at 50° by day, advancing to 60° or 65° from sun heat, with a free circulation of air, and for the present the night temperature should be kept at 40° to 45°, and gradually raised to 50° at night by when the flowers expand, with 5° more in the daytime. See that the inside borders are sufficiently moist.

The house to which fire heat is to be applied early next month should now be closed, ventilating fully when the temperature exceeds 50°. The inside borders should be thoroughly saturated with water, or, if the trees are weakly, liquid manure at a temperature of 70° to 75°. Complete without delay cleansing late houses, pruning, dressing, and retying the trees; and as the buds are already starting, ventilate fully in all but very severe weather.

FLOWER GARDEN AND PLEASURE GROUND.

Collecting Leaves.—Advantage should be taken of fine weather to collect as many leaves as possible. These will prove valuable for mixing with rough stable manure, as they will moderate the fermentation. Oak leaves will be found the best, next to these in point of duration being Beech and Chestnut leaves. Leaf soil is invaluable for mixing with other soils for potting purposes, and there are few flower gardens that would not be greatly benefited by a good dressing of it. For either purpose they may be collected and stored in a convenient uncovered corner, turning the heap once or more during the twelve months they are decomposing. In many cases the ordinary method of collecting has to be altered, as the frequent winds have cleared the parks and other comparatively open spots, and the supply has to be drawn from the shrubberies.

Thinning out and Arranging Shrubberies.—During mild dry weather the work of thinning crowded shrubberies should be proceeded with, the supernumeraries in this case being shifted to other quarters in order to allow those planted permanently to develop. This practice of planting thickly for immediate effect is worthy of adoption by intending planters, always, however, taking proper care to dispose the trees and shrubs with the view of eventually thinning them. Prior to planting, all the sites for the tall-growing shrubs, evergreen and deciduous trees, should be marked with tall stakes, shorter stakes being employed to denote

the sites for the dwarf-growing kinds. By these means the quantities required can easily be computed, and the work of planting be much simplified; all intervening spaces to be filled in with commoner kinds of shrubs, and which will eventually be treated as supernumeraries. Shrubberies, in common with the other parts of the garden, require to be deeply drained, and in some instances where clay predominates open surface drains prove extremely beneficial. Few shrubs or Conifers will thrive in an undrained clayey loam, but if this is well drained it often proves highly suitable for them and also Roses. Some clays are more easily dug in wet weather, consequently now is the time to either drain or lightly dig such soils.

Preparing Flower Boxes.—The time is rapidly approaching when it will be found necessary to commence propagating the stock of various kinds of bedding plants, and it is advisable to anticipate this with regard to preparing pots, pans, and boxes. The two former ought long ago to have been washed and stored in a dry shed, as they are not improved by frequent saturations, and are easily cracked by frost. Boxes requiring new bottoms should be repaired, in many cases this being best accomplished by nailing the new bottom to what was previously the top part of the frame. When making new boxes those intended for propagating purposes may be about 24 inches long, 15 inches wide, and 6 inches deep, which depth will admit of a square or squares of glass being laid on. For newly-struck cuttings deep boxes are unsuitable, as Iresines, Coleuses, and Alternantheras do not thrive in a great body of soil. Even Pelargoniums, Verbenas, Lobelias, Gazanias, and Alyssums do not require deep boxes. We recommend a uniform depth of 3 inches for all kinds, draining the boxes more or less according to the constitution of the plants they are to hold. Boxes may be strengthened and preserved by nailing two strong pieces of wood across the bottom, these raising them from the ground or beds as the case may be, and thereby retarding the otherwise inevitable early decay.

PLANT HOUSES.

Stove.—Allamanda Hendersoni that has been at rest during the past two months and kept in a temperature of 50° to 55° should now be started. Prune closely back—similar to Vines grown on the spur system—if the plant has attained the desired size to cover the trellis on which it may be grown, or the portion of roof under which it is to be trained. If grown in pots the old ball should be reduced by half, and then soaked in tepid water. The same or a larger pot should be used, according to the space to be covered with the plant. The drainage of the pot should be liberal, and then covered with a good layer of decayed manure, the most suitable compost being rich fibry loam, one-seventh of manure and coarse sand. Press the soil as firmly as possible into the pots, and place the plant in a temperature of 65°, syringe twice daily, but give little or no water at the root until signs of growth are observed. If planted out remove as much of the old soil as possible, and employ fresh soil with a little more manure.

Bougainvillea glabra may also be started at once. Prune freely by removing all the weak puny growths, as a number of strong shoots will produce more flowers than a crowded plant with a much greater number of small twiggy growths. This should be treated in every way similar to the preceding plant, and the same compost will be suitable.

Plants of Clerodendron Balfourianum should also be introduced into the same temperature, well watered, but not disturbed at the roots until growth commences. When potting is done care must be taken not to injure the roots. It is not necessary to repot this plant annually. Rich top-dressing and liberal feeding will keep them in good health for several years. When potting really has to be done remove one-third of the old ball, and replace it in the same size pot, using the compost already recommended, with the addition of a little charcoal and rough half-decayed leaf soil. Plants to bloom later in the season and now at rest must only have sufficient water to prevent the wood shrivelling, and must not be in a lower temperature than 55°. A plant or two of the shrubby-habited C. fallax should also receive attention by now being closely pruned, leaving only one or two eyes on each shoot of the previous year's wood. This variety is the best when grown with a clear stem about 18 inches high, and then allowed to form a small head. Small decorative plants can annually be raised from seed, but a plant grown on into a specimen in a 10-inch pot is when in flower a noble object, with its large terminal erect panicles of bright scarlet flowers. In repotting the old ball can be well reduced, and done directly after pruning or when the young shoots are about an inch in length, using the same soil as for C. Balfourianum.

THE BEE-KEEPER.

THE ART OF BEE-KEEPING.

(Continued from page 600, last volume.)

HIVES.

As we have already seen, the honey bee is one of the few insects capable to a certain extent of domestication. In a state of nature its colonies are found in hollows of rocks or trees, and occasionally in exposed situations. The first hives were doubtless hollow logs or sections of bark, and these have in the course of ages developed into the modern moveable-comb hive, now all but universally in use among advanced apiarians. We may regard the straw skep as the modern representative of the hive with fixed combs, while the octagonal Ayrshire or Stewarton hive may be regarded as the connecting link between the skep and the bar-frame hive proper. The combs of the Stewarton hive are sometimes built in moveable frames, but as these are necessarily of unequal sizes they are only partially interchangeable. When the rectangular form is given all combs become interchangeable, and we have the bar-frame hive proper.

Which of these is the best hive? has been and still is the source of much controversy among bee-keepers, a controversy frequently complicated by the introduction of various side issues, such as the material of hives or the different systems of management. Apart from these issues, however, the question resolves itself simply into that between fixed and moveable combs, and we shall shortly give our reasons for using and recommending the latter. The questions as to material and management are equally applicable to each of the styles of hive mentioned; thus we may have wooden skeps or straw Stewartons or bar-frame hives.

What, then, are the special advantages we claim for the bar-frame hive? First of all we place the facility it offers for inspection. To the experienced bee-keeper it resembles a book-slide. Each of its combs is a volume easily withdrawn and studied. In a moment the inmost mysteries of the hive can be reviewed. We see the whole development of the bee from the egg to the perfect insect. We note the presence or absence of a queen, and judge as to her condition or fertility. We can inform ourselves as to the condition of the whole stock, whether duly increasing at the proper season, free from disease, or sufficiently supplied with stores. We may tell almost to a day when it intends to swarm, or satisfy ourselves of its non-intention. And if curious as to the natural history of the bee, we may note every stage of the growth of the inmates, the wonderful production of royal cells for future queens, the method of storing honey and pollen, and the formation of the beautiful combs. If it be granted that such knowledge is of practical importance in bee-keeping, we do not see how anyone can doubt the advantages of the moveable-comb hive.

But in the next place we note the facility it affords the bee-keeper for aiding Nature in her work. We can readily supply embossed sheets of wax called comb foundation, of the full size of the combs required, containing sufficient wax to nearly finish them, and thus insure combs of unsurpassed regularity in a third of the time required to build them naturally. We may have these combs entirely composed of worker cells if desired, and exactly in the place wanted. This advantage alone is worth much when we consider that every ounce of wax produced by the bee is at the cost of at least 1 lb. of honey. We may contract or enlarge the hive to suit the necessities of the stock or the season, and thus dispose of all controversy as to the proper size of our hives. We can supply weak hives with combs of hatching brood taken from stronger stocks, or with combs of honey if provision be found scarce. We can with ease cut out royal cells, to prevent swarming, or insert them where we wish to have queens raised, or we may join stocks by simply lifting the combs and bees of two or more into a common hive; or, *vice versa*, we may divide a stock as in artificial swarming. Here again we claim the undeniable superiority of the moveable-comb hive.

Lastly, we note the facility with which such hives may be deprived of their surplus honey. Moveable combs can, by the aid of the machine called the honey-extractor, now so extensively used, be in a few minutes emptied of their contents and returned undamaged to be refilled by the bees. When we consider that the production of wax is not only a costly but a slow operation, necessitating the perfect inactivity of the bees so engaged, it is evident that the usual plan of crushing the combs to obtain the honey is a needlessly wasteful one, and it is established as a fact that bees supplied with combs ready made store more than twice as much honey as when they have also the combs to build. Extracted honey

obtained by this process is besides absolutely pure, and a great contrast to that usually obtained from crushed combs, in which may generally be found not only a considerable proportion of wax, but of pollen and the juices of grubs or immature bees.

Objections have been taken to the rectangular shape of the bar-frame hive on the ground that it is not so well suited to the globular form in which bees naturally cluster, but this objection holds true to all hives so long as they are larger than the cluster of bees. Indeed, large skeps such as are now chiefly recommended are the most objectionable of all hives in this respect. They entirely conform to the ideal form in summer when they are full of bees; but at this season all hives under proper management are also filled with bees, and even though vacant corners may exist, the warmth of the temperature renders these but slightly objectionable. In winter, however, when the bees shrink into small bulk, so much of the interior of these large skeps is unoccupied that, as a matter of fact, the combs so exposed are in the greatest danger of becoming damp and mouldy. In the Stewarton hive this objection is lessened by the removal of such sections of the hive as are not occupied by the bees, but with regular bar-frame hives the objection may be entirely removed by the timely contraction of the space to such dimensions as the bees can easily keep warm and dry, in which case the globular form is of no further advantage.

There has also been much controversy as to the best material for hives, mainly between the advocates of wood and straw respectively. Doubtless the large accession during late years to the ranks of bee-keepers of beginners imperfectly versed in the principles of the

management of bar-frame hives, many of whom have reported disaster to their stocks from cold or damp, has tended to create a prejudice to the use of wood as a material for hives. The early forms of the bar-frame hive also tended to such untoward results. But now it is quite different, and hives of wood are now made that for warmth and dryness are not surpassed by the best straw hives made. The art of working straw hives is confined to the few, while any handy man can construct a hive of wood. The roughness and inflexibility of straw is against it as a material for rectangular bar-frame hives, though such are occasionally made of it. Besides, it requires an outer casing almost as costly as the hive itself. Its sole advantage is its superiority as a non-conductor of heat, and it is here that the great improvement in bar-frame hives has been most marked of late years. First of all the wooden crown board was abolished, and in its stead was introduced the porous quilt of carpet or house flannel, supplemented in winter by an extra covering of chaff or cork dust. Next, the sides of the hive opposite the frame ends were doubled so as to give an inch or more of dead air as a non-conductor, this space being sometimes also packed with chaff or other light material. And lastly, the plan of removing the outer combs before winter and filling their place with chaff, &c., completed the arrangements of a hive that for security against cold and damp is undoubtedly superior to the best straw hive ever made. We give sections both ways of such a hive showing its arrangement for winter. (See figs. 14 and 15.)

NOTE.—The stippled spaces inside the hive represent the chaff-packing, and that underneath the sawdust, which protects from cold

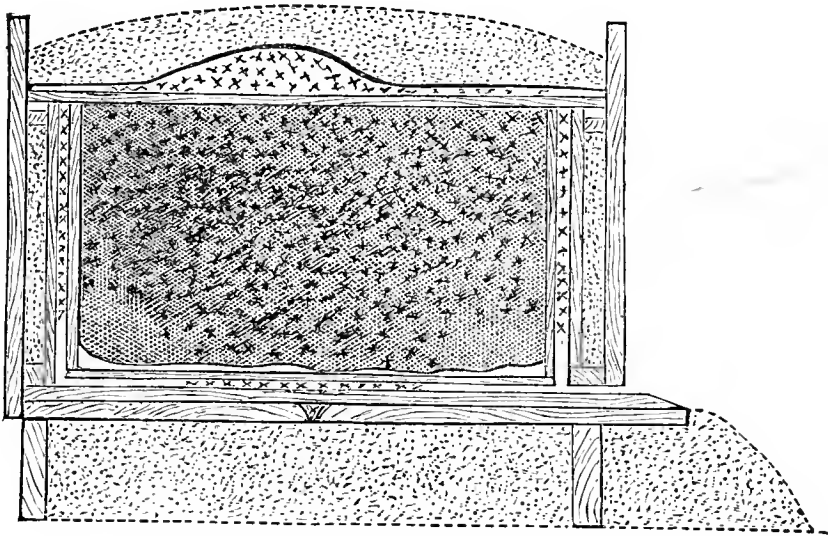

Fig. 14.—Longitudinal section of a bar-frame hive, showing arrangement in winter.

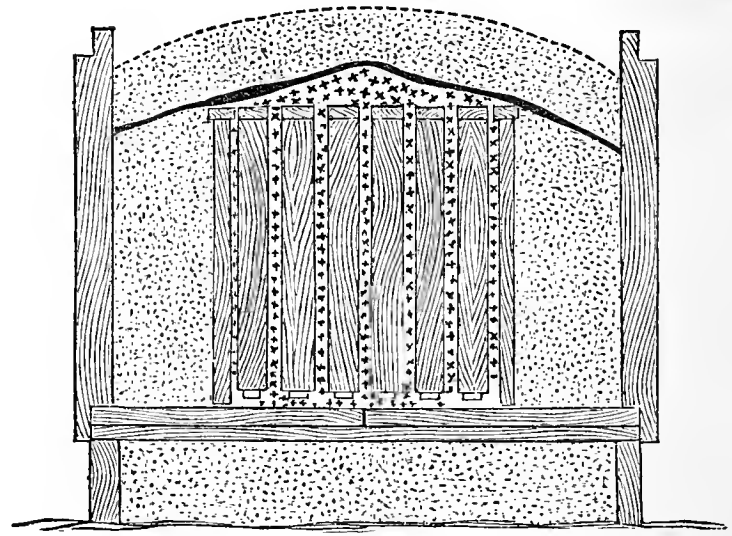

Fig. 15.—Cross section of the same.

and damp from beneath. The cavity between the quilt and the tops of the frames affords a warm winter passage from comb to comb, and is always found full of bees. The roof of the hive is not shown here.—WILLIAM RAITT, *Blairgowrie*.

(To be continued.)

STIMULATING FEEDING FOR BEES IN AUTUMN.

I WAS surprised to read "P. H. P.'s" remarks on autumn stimulating feeding. Does he mean to say that he can induce his queens to start laying after they have ceased in the autumn? After many years' trial I find it not worth the trouble, and I am borne out by several English and Scotch bee-keepers of no mean repute. I know "P. H. P." to be a good bee-keeper, but I should like the opinions of others. If the stocks are scarce of food by all means feed them, not without. I find in most cases the best results not in autumn stimulating feeding, but in spring feeding.—STINGER.

SEPARATORS A NECESSITY.

THE use of separators having become to me "a necessity," and as some prominent apiarists seem to think "they are a useless appendage" in the modern bee hive, it is just possible there may be certain conditions in which we may get good combs without them, but I have yet to find them. It has been said the hive must be full of bees, and honey coming in fast; then, with sections filled with good thin comb foundation, no trouble would be experienced.

I determined to give this matter a fair trial during the past season, and so prepared six good colonies, with upper storeys filled with wide frames, all being filled with 1 lb. sections, and each containing a full sheet of thin foundation, thus giving them such good facilities for

comb-building that I thought if ever good combs could be had without separators I would have them. The result proved exactly the reverse. The honey season being a good one the bees soon built them out and filled them with honey, but when I came to crate these same boxes for market more than one-half had to be laid aside for the home market; and even then they are a "bother and vexation of spirit," as they are sure to crowd against each other and start the honey to leaking; and these combs, be they bulged ever so little, are likely to have the caps of the cells broken if they but touch each other. It seems to me the only advantage we could gain in discarding them lies in the fact that more honey can be stored in the same box; but this is of little account when we sell the wood in the box at the same price as the finest honey. Supposing, then, we must use separators, shall we use wood, tin, or paper? I have never used anything but tin, though I am assured by a friend of mine, who uses wood entirely, that it is just as good as tin. However, another important item comes in here. Will as much honey be stored with as without them? I have thought some seasons the bees were reluctant to work among them; then, again, they seemed to pay no attention, but worked as busily as though no separators were present.—J. V. CALDWELL (in *The American Bee Journal*.)

TRADE CATALOGUES RECEIVED.

Wm. Cutbush & Son, Highgate and Barnet.—*Catalogue of Vegetable and Flower Seeds.*

Dicksons & Co., Waterloo Place, Edinburgh.—*Catalogue of Flower and Vegetable Seeds.*

James Dickson & Sons, 108, Eastgate Street, Chester.—*Catalogue of Vegetable and Flower Seeds.*

Bruant, Poitiers, Vienne, France.—*List of New Plants.*



* * All correspondence should be directed either to "The Editor" or to "The Publisher." Letters addressed to Dr. Hogg or members of the staff often remain unopened unavoidably. We request that no one will write privately to any of our correspondents, as doing so subjects them to unjustifiable trouble and expense.

Correspondents should not mix up on the same sheet questions relating to Gardening and those on Poultry and Bee subjects, and should never send more than two or three questions at once. All articles intended for insertion should be written on one side of the paper only. We cannot reply to questions through the post, and we do not undertake to return rejected communications.

Violet Culture (*L. L. D.*).—Mr. Beachey's article on Violet culture which you require is on page 321, vol. i., third series, the issue of October 7th, 1880. The number can be had for 3½d., sent to the publisher.

Cardiff Castle Cucumber (*Henry Canning*).—You will find this Cucumber advertised in our columns.

Angle of Glass Roof (*G. D. O.*).—The angle you suggest, 45°, for a roof under which Tomatoes are to be grown in the summer, will do very well. An angle of 35° would do equally well, but the more acute the angle the greater is the extent of the roof surface.

Lawn Unsatisfactory (*A. D.*).—As the lawn is "as deplorable and unsatisfactory as anything can possibly be," there is not much hope of your making it presentable by any applications of either manures or renovating mixtures; and the best, and in the end the most economical, method to adopt will be to plough it up as you propose, clean the land well, level it, and sow a suitable lawn mixture. You will find notes on lawns in another column, and these, with what will follow, may be of service to you. If you need more specific information we will readily afford it if you will state your requirements.

Gas Lime for Gardens (*Idem*).—The time that should elapse between applying the lime and cropping the land depends entirely on the quantity that is applied. At present 2 ozs. per square yard or 5 cwt. per acre should not be exceeded, and if this is well mixed in the soil in digging you may crop the ground in a month. In all probability a heavy dressing, say at the rate of 60 or 80 bushels per acre, of freshly slacked ordinary lime would be very beneficial both in destroying slugs and improving the soil. Your other question we print on page 50 in case any of our correspondents can give the required information.

Chrysanthemum grandiflorum (*J. M.*).—The Chrysanthemum which you find so useful, and which you say you had in flower until February last year, is *grandiflorum*, though the blooms are slightly different from those produced earlier in the season. The characters of the foliage, however, are easily distinguishable.

Propagating Dahlias (*H. S. P.*).—You say you have "plenty of glass and want plenty of plants." You can easily raise them if you can command bottom heat of 80° or 85°, such as may be afforded with sweet fermenting materials, and top heat in a frame or propagating case of 70° to 80°. Place the roots in the bed, not dividing them, and just cover them with leaf soil. If kept moist they will commence growing at once, and each shoot when 3 inches long can be inserted in sandy soil in a thumb pot, kept close until rooted, then assigned a cooler and light position, the plants to be eventually shifted into larger pots. The tops of these young plants can be taken off and inserted as cuttings if needed, but this must be done before the stems become hollow.

Dahlias for Exhibition (*Idem*).—The following are the names of the varieties included in the collections that were placed first in the classes for twelve show and twelve fancy Dahlias at the National Dahlia Exhibition held at the Crystal Palace in September last year:—Show varieties—Julia Wyatt, Duke of Connaught, Mr. Harris, Prince Bismarck, Vice-President, Frank Rawlings, Perfection of Primroses, James Cocker, Sunbeam, Royal Queen, Harry Walton, and Criterion. Fancy varieties—Flora Wyatt, Henry Glasscock, Mrs. Browning, Parrot, Mrs. Saunders, Professor Fawcett, Viceroy, John Lamont, Wizard, Letty Coles, Fauuy Sturt, and Gaiety. If you only need twelve, select six each of these; or the safer plan if you intend exhibiting would be to obtain the twenty-four, as there will be then a better chance to select a good dozen blooms.

Early Dwarf Kidney Beans for Field Work (*H. S. E.*).—Unless you have an early field, the soil of which is light and warm, it is doubtful if you will find any variety of Dwarf Kidney Bean profitable. Others have tried the experiment, but have discontinued growing them unless they can contract to supply large pickling firms with young Beans. In this case as soon as the demand in the markets slackens they cease to send. As a rule they are grown between the trenches prepared for Celery, and the varieties grown are the prolific though small Newington Wonder and Negro Longpod. Osborn's Forcing is undoubtedly superior to either for very early crops, but does not long remain in full bearing. The seed probably will be found rather expensive. We have had no experience with Early Rachel. Spring frosts are very destructive among Beans, and for this reason a high and sunny field should be selected for them. Scarlet Runners are found much more profitable than these Beans.

Potting Carnations (*B. D.*).—If you can, place a few leaves or other sweet fermenting material in a frame so as to afford a gentle bottom heat. We should place the young plants in small pots now, using gritty loamy soil, and plunge them in the material. This would greatly facilitate the emission of fresh roots, and by judicious ventilation the plants would be kept sturdy, but for a week or two we should keep them rather close than otherwise. In the absence of artificial heat we should defer the potting for a week or two unless the weather were mild, and with a fair prospect of it continuing so for some time to aid them in recovering from the checks as speedily as possible.

Chrysanthemum Etoile d'Or (*Subscriber*).—If the shoots are fresh and crisp, not hard and wiry, the cuttings will strike if you pinch out the flower bud immediately it is visible. If you cut a plant down—that is, shorten the

branches half way down or lower, and place it in gentle heat, it will in all probability produce an abundance of growths of the best character for propagating. If you have only one plant try the effect of shortening a few of its branches in the manner indicated.

Deutzia crenata flor-cicno (*Idem*).—This is a very useful plant for forcing, but does not flower so early as *D. gracilis*. Pruning should be done immediately after flowering, and be limited to the removal of those portions that are exhausted by flowering, not necessarily removing the flowering branches entirely, as certain portions of these, which are easily observable, form spurs, which in turn produce clusters of flowers, but at the same time preserve and encourage the young growths. If one or two of these are very strong and likely to grow much longer than the rest pinch out their points while still young, and they will break and make second growths that will be strong enough for flowering. About a fortnight after flowering and pruning repeat if needed, and let the plants have a very light position under glass until the weather permits their being placed in the open air, then plunge in an open sunny position, watering them the same as you do Chrysanthemums. If you want very large bushes in the shortest time you may plant out the Deutzias and repeat in the autumn; but plants so treated do not usually flower so freely as those kept in pots. Azalea narcissiflora is not deciduous, but, like other varieties of *A. indica*, casts a portion of its leaves in winter or early spring. It is very useful for forcing and affording white flowers for cutting during the winter months. Our reply to "C. Wilks" will answer your question about Celery.

Moss on Tennis Lawn (*F. C. D.*).—If the water cannot drain freely from the soil, but becomes stagnant, moss will take possession of the lawn whatever you may apply to the surface. Lack of drainage is possibly the cause of the evil in your case, and it will probably be advisable to make drains 4 or 5 yards apart and 18 inches deep, falling into a cross drain at the lower level for conducting the water away. Two-inch pipes will do for the drains, covered with rubble, but in the catchwater drain the pipes should be larger. If you cannot drain the land we should spread a layer of ashes 2 or 3 inches thick, covered with an inch or two of soil, on which to lay the turves. Whether the present turf will do to lay down again we have no means of knowing; but you may judge by the following test:—If when pared off about an inch thick it will roll as represented in an engraving on page 13, you may venture to use it again; but if it is full of moss as to break in pieces when you attempt to roll it, it will not be likely to prove satisfactory. Before removing it comb out all the moss you possibly can with a small and sharp-toothed rake, and when it is laid down again give a light sprinkling of fine soil containing a sixth part of its bulk of lime, and scatter on some fine grass seeds, and roll the surface when it is dry enough not to adhere to the roller. Under any circumstances we should not purchase fresh turves, but if the present turf cannot be used should prefer a lawn formed entirely by sowing seeds. We have seen close lawns in six weeks from the date of sowing, and in two months tennis was played in the most satisfactory manner. Sheep must be kept off newly formed lawns, and from old lawns too in wet weather, as, unless the ground is very firm and well drained, they will inevitably make indentations in the surface that will not be agreeable. On some tennis lawns they do no appreciable injury. The seasons recently having been unusually wet caused the moss to spread in the manner you describe.

Grapes Cracking (*H. Stone*).—The reason why the Madresfield Court Grape is more liable to crack than many others is because of the comparative inelasticity of the skin, and it is rendered still more brittle and unyielding to pressure from within by injudicious ventilation. Any check to the free swelling of the berries when young by an atmosphere alternately moist and dry, or by a sudden inrush of cold dry air, or by not opening the ventilators soon enough in the morning, then throwing them open too widely at once, causing sudden and extreme evaporation from the fruit—any one or all these mistakes affect injuriously the cuticle of Grapes (but the results are more apparent in the variety in question than in most others), and predisposing them to cracking. Then, again, an excess of water at the roots on the approach of the ripening period, and especially if the soil has been previously rather dry, causes such an influx of sap that the berries cannot resist the pressure. The roots of this Grape should be under command, and the water supply also; but even then if sound judgment be not exercised in management the fruit will crack. This Vine should be allowed to carry as much foliage as can be fully exposed to the light, so as to appropriate the sap, and there must be no ruthless removal of long sub-laterals that may have been allowed to extend unduly on the eve of the ripening process. This is yet a too common practice. Cutting a notch in the laterals just below the bunches has been found by some cultivators to arrest a too free flow of sap to the berries, and others have effected the same object by twisting a piece of wire tightly round them; but many skilled cultivators produce splendid examples of this splendid Grape without having recourse to such manipulation.

Black Hamburgh Grapes Mouldy (*Idem*).—The mouldiness on Black Hamburghs is caused by defective ventilation and a too low night temperature after a sudden change to mild weather following a period of cold. Much moisture is then inevitably condensed on the cold surfaces of the berries, and this, especially after they have been long ripe, accelerates their decay. We will reply to your question about raising Vines in turves in a future issue. We cannot answer it so fully as is desirable this week.

Celery "bulging" (*C. Wilks*).—While we cannot state the precise cause of your Celery bulging or bursting 3 or 4 inches above the roots, we can, perhaps, enable you to determine the matter for yourself. If earth is applied too early and too much is placed round the plants at once the upward growth of the stems is in a measure arrested, and the consequence is that the leafstalks become more or less curved below the soil. When this occurs they never recover their upright position, as further applications of soil naturally tend to aggravate the evil. This will cause Celery to bulge. But there is another cause. Many years ago we had something to do with a breadth of Celery in which there were many spoiled heads in every alternate row by bulging and bursting. As all the rows were of the same variety, and the plants raised in the same seed bed, planted at the same time, and watered alike, it was apparent the evil was attributable to some defect in earthing. This work was done by four men, two working at each row. The following year the same men were employed in earthing the Celery, which was not commenced until the plants had attained nearly their full size. As the men commenced the work of placing the soil round the plants with their hands after it had been broken fine with spades, it was observed that two of them placed it round lightly, not pressing it in the least, while the other pair kneaded it firmly round the plants, the top of the ridges being beaten almost hard round the stems of the plants, the earth being applied as high as possible in both instances. On the men being asked why they made the soil so hard, one of them replied, "Because we think it makes the Celery solidier." They were then told to make it as solid as they liked round two dozen plants, and not to firm the remainder of the rows at all. On

digging up the crop there were no bulged heads except among those particular plants which the men endeavoured to make "solider," most of which were spoiled, not one being straight as it should have been. You can now decide for yourself wherein you have erred, for it is certain that either of the mistakes we have indicated will spoil Celery by causing it to bulge below in consequence of the great resistance of the firm soil above preventing its free upward growth.

Grafting Plums and Cherries (Trike).—We gave you instructions for budding in compliance with your wish. This method of propagation is much better than grafting, which frequently predisposes the trees to gumming, and this is an evil to be avoided. Very few Cherry and Plum trees are grafted in the best fruit nurseries; still, grafting can be done. The present is the time for taking off the scions, placing them in soil in a cool position to retard the swelling of the buds, the time for grafting being when the stocks show signs of growth, proving that the sap has commenced rising. The stock should be in advance of the scions. The method of grafting depends on the size of the stocks. We shall probably make the matter plain to you in time to be of service. Cherry stocks are raised from seed of the ordinary varieties, gathered and kept in sand until February, then sown in drills, and the young trees transplanted in October. For dwarf trees the Mahaleb stock is preferred, and propagation is effected by layers. The Brussels and Muscle stocks are used for Plums, and are raised from suckers, layers, and seed.

Double Petunias (F. J.).—Young plants raised annually are usually the most vigorous and produce the largest flowers. They can be raised either from seed or by cuttings at any time when a minimum temperature of 65° can be maintained in a frame heated with fermenting materials or a propagating house. When very large specimens are coveted, those old plants that produce fresh growths from the lower parts of the stems will afford them if the plants are cut down, very carefully removing a portion of the old soil from the roots, repotting in smaller pots, growing in a light house having a temperature of 55°, shifting, stopping, and training as needed.

Liquid Manure for Bulbs (Idem).—An ounce of nitrate of soda dissolved in four gallons of water is a quick and good stimulant for bulbs, to be applied twice a week after the pots are filled with roots and the flower spikes are fairly visible. A large handful of soot or about a pint, tied up in a piece of old canvas and immersed in the same quantity of water for a day or two, will give you a safe and excellent stimulant; also good and safe is a quarter of a pound of fresh cowdung mixed in a large garden pot of water and used as required. Any of these stimulants will do good, as the whole of them applied alternately will benefit bulbs that need more sustenance than the soil affords. Let the twin plants grow, as if you remove one of them the number of flowers will not increase on the other, nor would they be appreciably larger if the plant is well supported. For reference to Violets see our reply to "L. L. D." You will be sorry to hear, as we are, that our correspondent "Single-handed" is seriously ill again, but will be glad to hear of your kind inquiry; and we are obliged by your good wishes.

Renovating Vines (J. Smith, Surrey).—According to your description of them the Vines of which you have taken charge are in a very unsatisfactory state, and your first proposition if it could have been carried out would not only have been the most satisfactory, but in the end the most economical, as the value of the fruit would have been so much greater than the produce of exhausted Vines however well they may be managed. But gentlemen do not always regard matters from a purely commercial point of view, and if they do they have reasons for not desiring to invest their money as a gardener may naturally wish. In such a case as yours a gardener must simply accept the position and make the best of it. This we are sure you will do, and your letter affords evidence that you will do all that can be done towards restoring the lost vigour of the neglected Vines. We do not think you can adopt a better plan than the one you propose, of trenching the border, making good the drainage, utilising the good soil, and replacing the had with the best compost at your disposal, cutting off the old roots at the bottom of the border, and placing the smaller and healthier in good soil nearer the surface, and leaving 4 feet next the house untrenched at present, but enriched for supporting the crop next season. In lifting the roots we should notch them at intervals, making a straight cut downwards and half through the roots, meeting it with a cut slanting upwards. These roots we should surround with fresh compost, consisting in great part of wood ashes. Even if only placed round them an inch or two thick, you will find it of great advantage in facilitating the emission of fresh roots, and the border should be mulched for keeping the surface moist in the summer. It is surface drought and disturbing the border by digging that drives the roots of Vines downwards. The heat from the sun will never attract them to the surface, as some persons erroneously suppose, if the soil is loose and dry. In addition to improving the border we should at once cut down every alternate cane to the bottom of the rafter. You have nothing to lose by doing this, as the rods are far too numerous, but we think you have much to gain, as in all probability fresh growths will start from the shortened rods, and by selecting the best from each you may with better root-action succeed in obtaining good young canes the first season; or, if rather weak, you would by cutting them down again insure stout growths and fine canes next year, these to be treated as young Vines. In the meantime the existing rods will, if not too much exhausted, maintain the supply of Grapes; but to effect this in the best manner we should not spur-in the laterals closely, but should retain the best of them, shortening at the most prominent bud where the wood is hard and matured. Whether each bud is 3 inches from the main rod or thrice that distance, tying if needful these shortened, but still long, bearing portions to the main rod. The base buds of exhausted Vines are always weak and produce weak growths and small bunches, if any, the bolder buds producing stronger growths and, provided the wood is ripened, better bunches. By carrying out this method intelligently and disbanding freely, disposing the best growths thinly for a future crop, you will possibly be surprised by the results. We have proved the value of this practice, and have seen it carried out by others in the most satisfactory manner until the young canes trained between the bearing rods have attained a strong free-bearing state, the older portions being then in turn cut out. We desired to answer your letter fully, as our reply may be of service to others, hence the little delay that has occurred in attending to the matter, as an earlier answer would have been necessarily shorter and consequently less useful.

Names of Fruits (William Heale).—The Apple is Pigeon. The Pear is Martin Sec, a very old French variety. (W. Henry Ashwin).—1, Trumpington. The other we do not recognise; it possesses little or no merit.

Names of Plants (J. C.).—1, Davallia tenuifolia; 2, Libonia pichrosiensis. (Subscriber).—1, Abies lasiocarpa; 2, Juniperus chinensis, the male form; 3, Pinus Lambertiana; 4, Pinus Cembra; 5, Abies canadensis; 6, Cedrus, probably Deodara. It is highly desirable that the habits of the trees be stated when sprays are sent for naming.

COVENT GARDEN MARKET.—JANUARY 17TH.

TRADE remains quiet with no alteration. Grapes continue to be supplied freely. Vegetables plentiful.

FRUIT.

	s. d.	s. d.		s. d.	s. d.
Apples.....	½ sieve	2 0 to 7 0	Grapes	lb.	2 0 to 5 0
"	per barrel	20 0 40 0	Lemons	case	10 0 20 0
Apricots.....	doz.	0 0 0 0	Melons	each	0 0 0 0
Cherries.....	½ sieve	0 0 0 0	Nectarines..	dozen	0 0 0 0
Chestnuts.....	bushel	10 0 12 0	Oranges	100	6 0 10 0
Currants, Black..	½ sieve	0 0 0 0	Peaches	dozen	0 0 0 0
" Red.....	½ sieve	0 0 0 0	Pears, kitchen ..	dozen	1 0 2 0
Figs.....	dozen	0 6 1 0	dessert	dozen	1 0 2 0
Filberts	lb.	0 0 0 0	Pine Apples, English	lb.	1 6 2 0
Cobs.....	100 lb.	5 0 55 0	Raspberries	lb.	0 0 0 0
Gooseberries	½ sieve	0 0 0 0	Strawberries	lb.	0 0 0 0

VEGETABLES.

	s. d.	s. d.		s. d.	s. d.
Artichokes.....	dozen	2 0 to 4 0	Lettuces	score	1 0 to 1 6
Asparagus.....	bundle	0 0 0 0	Mushrooms	punnet	1 0 1 6
Beans, Kidney....	100	1 0 0 0	Mustard & Cress ..	punnet	0 2 0 6
Beet, Red.....	dozen	1 0 2 0	Onions	bushel	2 3 2 6
Broccoli.....	bundle	0 9 1 6	Parsley..... doz.	bunches	3 0 4 0
Brussels Sprouts..	½ sieve	1 6 2 0	Parsnips	dozen	1 0 2 0
Cabbage	dozen	0 6 1 0	Peas	quart	0 0 6 0
Capsicums.....	100	1 6 2 0	Potatoes.....	cwt.	6 0 7 6
Carrots.....	hunch	0 4 0 0	" Kidney.....	cwt.	6 0 8 0
Cauliflowers.....	dozen	2 0 3 0	Radishes.... doz.	bunches	1 0 0 0
Celery.....	bundle	1 6 2 0	Rhubarb.....	bundle	0 4 0 0
Coleworts....doz.	bunches	2 0 4 0	Salsafy.....	bundle	1 0 0 0
Cucumbers.....	each	1 6 2 0	Scorzoneria	bundle	1 6 0 8
Endive.....	dozen	1 0 2 0	Seakale	basket	1 0 2 0
Fennel.....	bunch	0 3 0 0	Shallots	lb.	0 3 0 0
Garlic.....	lb.	0 6 0 0	Spinach.....	bushel	3 0 0 0
Herbs.....	bunch	0 2 0 0	Tomatoes.....	lb.	0 8 1 0
Leeks.....	bunch	0 3 0 4	Turnips.....	bunch	0 2 0 3



POULTRY AND PIGEON CHRONICLE.

GOAT FARMING.

(Continued from page 41.)

We have stated the peculiarities of certain species of Goats, and wish to name all the best sorts which are all likely by crossing to contribute to the improvement of the capacity of yielding milk, meat, and mohair. Having, through the experience and intelligence of breeders both of cattle and sheep, obtained all that we require, this is a good reason why we should be able to accomplish and obtain what we desire in breeding Goats in order that Goat-farming may become a profitable pursuit, and at the same time interesting to amateurs.

It is necessary to know the habits and capabilities of the best varieties before we can attempt cross-breeding, and this is extremely necessary, simply because no single pure breed will yield all we wish for to the fullest extent. We, therefore, now refer to the Angora Goat; and as we find it well described by the same author we have previously quoted, Mr. S. Holmes, in an essay in the "Live Stock Journal Almanack," and his description is the best we have met with. He says:—"The Angora Goat differs considerably both from the common Goat and from the Cashmere, although with the latter it is often confounded. It is met with in Asia Minor under almost as great a diversity of form, size, and characteristic as are our own in England, some being a reddish-brown, others white, and at times even quite black. Their ears also vary from being short and almost upright to moderately long and pendant. The horns, in like manner, are of various descriptions; in some cases nearly perpendicular, in others curling laterally, but always more or less spirally inclined. Even the true Angora—that is to say, the breeds which are cultivated for producing the finest and best mohair, are not all of the same type, equally good clips being obtained from some of the small half-pricked-eared varieties as from the lops, whilst again, although most of the herds are white, there are brown and occasionally black animals which yield heavy fleeces.

"The following points are those which, by the generality of the mohair breeders, are looked for. A fine head with ears semi-pendulous, wide, and thin, horns fine at the base and tapering gradually to a point, flat-shaped, and set as far apart from each other as possible. In the male they should make a direct curve to the rear as soon as they leave the head, bending then outward, and finally pointed upwards, forming a spiral. In the female they grow out more in a lateral direction as they separate at the base, the spiral being more decided, and the extremities directed downwards. The shape and expression of the face in the Angora strongly resembles that of the sheep, with which it has many characteristics in common.

"The coat is composed of two descriptions of hair, the principal of which is a fine silky kind of wool, which hangs in long wide flakes, terminating in ringlets all over the body and down to the hocks. In the most valued specimens these flaky strands of wool are closely matted at the base, so that after being sheared the whole falls in a united mass like the fleece of a sheep. It is this substance which is known commercially under the name of mohair. The other and inner coat is of the same nature as the hair of the common Goat; it is quite short, and grows close to the skin. This is no doubt intended by Nature as a protection to the animal when the outer covering falls, as it does every spring unless shorn, and until its growth is sufficiently restored.

"The yield of fleece varies greatly according to the age, sex, and quality of the individual, the average produce of an ordinary herd, reckoning adults and kids of both sexes, being about 2½ lbs. each, but in herds of the best breeds it reaches an average of 6 lbs. The greatest weight is taken from the rams, but the finest quality from the castrated males of two, three, and four years old. A fine well-bred entire Goat will sometimes yield as much as 10 and 12 lbs., the length of the strands being from 8 to 9 inches. The value ranges from 3s. 6d. a lb. for the very best, to 2s. and less for very inferior qualities.

"The endeavours which on a few occasions have been made to acclimatise them for commercial purposes in England have signally failed, our atmosphere and soil being much too damp. In 1848 a choice herd was sent by the Sultan as a present to Dr. J. B. Davis in the United States. Referring to this importation an American author writes:—"They do surprisingly well on the Pacific coast as far as introduced, but especially in California and Arisona, whose climate and topography closely resembles that of their Asiatic home." At the Cape of Good Hope, where large numbers of Angoras have of late years been bred, they appear to do as well as on their native hills, the quality of their produce comparing favourably in many cases with exports from the East. When Goat-farming soon became general, the rate at which it progressed may be judged by the fact that whereas the export of mohair in 1865, the first year, was only 6804 lbs., it had by 1877 reached as much as 1,395,850 lbs.

"The finest specimens of the Angora that ever left their native country were imported to this colony in the spring of 1879, when Mr. J. B. Evans, a large and enterprising farmer of these animals at Scoorsteenberg, Eastern Province, brought over from Asia Minor a herd of twenty-seven head, to secure which he had left the Cape two months previous, and travelled into the heart of the Angora country, where he obtained, but only at fabulous prices, the flock in question, valued at £2000. As these animals were transhipped at the Victoria Docks in London, an opportunity was afforded me through the kindness of the importer, of inspecting them, and I am therefore indebted to Mr. Evans for much of the information upon this breed which I am able to place before my readers. An idea of the superiority of this consignment may be gathered when it is stated that the weight of fleece of the males averaged from 12 lbs. to 15 lbs., and that of the females from 7 lbs. to 8 lbs.

"The flesh of the Angora closely resembles mutton, to which in its native country it is much preferred, whilst its milk, though less plentiful than that of the common Goat, is much richer. As it feeds more freely on grass than the latter, and fattens casier, being less fond of browsing on hedges, it is considered by Mr. Evans probable that a cross between the two varieties would be better suited for pasturing in small herds in England for the sake of the milk than our own breeds, provided only they were located on dry soil and housed in winter."

This concludes our quotation, which although it has extended to an unwonted length, and is throughout not only interesting to the general reader, but of great importance to us in the consideration of our subject, and the observations we shall have to make in reference to the obtaining all the combined qualities in one and the same type of animal, which may be obtained by crossing and judicious mating of the animals, and which we shall endeavour to describe as the result of our many years' experience in the

cross-breeding of sheep, and describing as far as possible the means whereby we hope to obtain success. For as "like begets like" is a truism, we can adopt a system of breeding whereby the desirable qualities of one type or species may be so blended as to improve any other, and yet obtain the advantages of both, by excluding or obliterating undesired points, whilst profiting by and retaining superior qualities to the extent we may require.

(To be continued.)

WORK ON THE HOME FARM.

Horse Labour.—Wheat-sowing as fast as the ground is ploughed daily is the work still going on at every favourable interval, but very much yet remains to be done on the strong and flat-lying soils in every district. This employs the horses when it is possible to work the land so as to bury the seed, but on heavy soils scarcely any drilling has been possible, therefore broadcast seeding has been the mode adopted. If the weather continues changeable and the ground not so heavy but that the seed can be fairly buried, the sowing since Christmas is likely to produce a more regular plant of Wheat than much of the ground sown in November and early part of December. In such a season as we have just passed through the chalk hill lands, sandy land districts, and generally vale soils have had the advantage over the mixed or heavy soils; for at almost all intervals the fallow-ploughing has been continued upon those farms which had finished the sowing of Wheat at the early period.

In other cases the carting of earth for compost heaps of manure has been the work for horses, also the carting of chalk or marl where the distance is not too great from the pit has been done. In many cases, however, the railways will supply chalk and bring it within reach of various farms which must otherwise be treated with lime and mineral manures. The work of obtaining these substances and placed in store or heap is very important, and in various districts great complaints are made of the cereal crops being subject to blight or mildew. This in our opinion is often caused by the absence of chalk or lime in the soil, for it is not sufficient that the home farmer shall liberally manure his land in various ways to enable it to produce a full crop of straw. If lime and silica are entirely or partially absent in the land the growth of straw may be abundant, but the straw will be weak, and in seasons like the past it will be subject to disease on the surface of the stem, and be attacked with parasites of various kinds and be called blighted or mildewed. The straw will then go down and be lodged without the ears being properly filled with grain, which would not be the case as a rule if the carbonate or common lime had been liberally applied to the soil, but especially in the fen lands of the eastern counties, and vegetable loams of some of the western counties. We are so strongly convinced of the necessity of the applications we have named to such soils as we have indicated that we shall continue to repeat these opinions until we notice that they are somewhat more generally taken up and acted upon. In the districts where chalking was formerly pursued as an important operation in the tillage of the land it is shown that the numerous chalk pits and limekilns are at present for the most part unused and neglected.

Hand Labour.—Whilst open weather continues forking-out grass from the root crops may still be done, also on some lands intended for Lent corn after Wheat; and this is a matter of great economy, inasmuch that a small outlay in manual labour will save the larger outlay in horse labour to a great extent in the tillage for spring crops. Hedging, ditching, banking, and planting trees for plantations of Larch and other Firs may now be done with advantage, and where the land in hand is not good enough for tillage or pasture it can be turned to good account by being planted for timber or hop poles, the latter giving the quickest return.

Live Stock.—This is now the busy time for shepherds having charge of the various breeds of Down sheep, for the lambing will now be going on, or preparations should be made for the near approach of the lambing season of later flocks. We hear much of the death of sheep in some districts by the coathe or rot through flukes in the liver. For several years, but especially in 1879 and 1880, the losses by rot were enormous, and we see a difference of opinion exists as to the possibility of curing sheep with flukes in the liver, and it still remains an open question whether it can be done or not; but we blame every farmer who has suffered in former years from losses by rotten sheep if he still continues to pursue the system of feeding sheep on doubtful soils without using the necessary precautions, for it can certainly be prevented or avoided, and prevention being better than cure, it is within the farmer's power to prevent losses by rot, which we have explained fully in articles in this Journal on the 31st of July and 7th of August in 1879.

Under the present circumstances as to the high price of cattle and sheep, the latter especially, we recommend that all the stock required for fattening should be bred on the farm, in which case if there is any profit to be obtained it will be done to the fullest extent only in the breeding of all animals required on the farm, the benefit being not only certain, but arising or accruing in various ways, one of which is the avoidance of disease brought on the farm by purchased stock, and as the seasons vary the breeder is said to have the advantage in some years, and the feeder in others; we say, therefore, Take both and be satisfied. There is much lameness amongst sheep, especially where they are feeding on roots on strong or flat-lying land.

The only way to keep it under is by constant attention, having the sheep penned every day, and those which are attacked to be treated with the remedy the first day they are seen, for the difficulties in curing are consequent upon allowing the disease to extend under the hoof of the foot. It is, therefore, a question of immediate treatment, and let the labour of attention be freely supplied, for we have known the value of the cake consumed entirely lost by inattention at the proper time.

POULTRY AND PIGEONS

THE POINTS OF JAPANESE BANTAMS.

As fresh breeds of poultry come into popularity fanciers turn their attention to their points of beauty. It seems to us high time that admirers of Japanese Bantams should arrive at some understanding as to what are the chief characteristics of their quaint favourites. We believe that a Sub-committee of the Poultry Club, which has with much labour been drawing up a "standard of perfection" for many of the larger breeds, will ere long be approaching Bantams. There is, we understand, likely to be a conference between this Committee and the Bantam Club to arrive at a standard which may generally be received by judges and fanciers of Bantams. We do not here wish to anticipate them by drawing up a standard of our own, but merely to point out the fact that there is no breed of Bantams so well recognised as Japanese are, so well represented at almost every show, and so distinctly characterised, about which some of our generally best judges seem to have such vague ideas. Classes have for three or four years been given for them at the Crystal Palace, and they are well filled. We wonder that they continue so to be, for we must confess that once if not twice about the worst pair in the whole class has been picked out for the cup, at least according to the consentient voice of three or four of their oldest admirers.

Of course it is not very easy to arrive at the proper standard points of a breed which is imported from the ends of the earth, and with whose first producers or present breeders in their native land it is almost impossible for us to communicate. If a new variety were by selection perpetuated here, as were Laced Bantams by Sir John Sebright, the founder of the race would of course start with some ideal of what he wished to arrive at, and would make it known to those who followed him. In the case, however, of breeding a variety whose cradle is so very far off there seem to us only three possible courses—1, We may follow some standard either written or derived from pictures procured from the land whence the breed comes. 2, We may observe the points of apparently the most characteristic imported birds, and their general harmony, and breed up to them. 3, We may take a breed as it comes to us and arbitrarily decide that we like this or that point and do not like the other. We will illustrate our distinctions by actual examples—1, Japanese Silkies were for a long time very far from a distinctly characteristic race. Were they to have four claws or five claws? Were their combs to be double or single, their faces red or purple, their legs clean or feathered? All these salient points were debated, and so an open question. By degrees their admirers gleaned what information they could from eastern travellers, and came to a general conclusion that a four-toed red-faced Silky was an Indian fowl, but that in Japan the Silky usually had a very dark double comb, dark face, and five claws. There was still a question as to whether the earlobes should be black or of a beautiful turquoise blue we sometimes see. Wandering in the Japanese department of the great Paris Exhibition of 1878 we came upon an exquisitely painted screen, and there saw a trio of our favourite Silkies portrayed with evidently scrupulous accuracy; all their points agreed with the now received standard, and their earlobes were bright blue. Silkies, then, have in the main been bred on the first of these systems—viz., according to the ideal of their native fanciers. Possibly minor points, such as that vulture hocks are in them an eyesore, have been decided on the second—viz., because they do not harmonise with the general characteristics of the bird.

2, Cochins and Pekin Ducks have, according to the second course we enumerated, been bred up to those points which seemed the most distinctive one of imported birds. The general rotundity and fluffiness of Cochins were the points which on their first importation struck all beholders, and these have consequently been received as their most important characteristics. In the case of Pekin Ducks, their peculiar stilted gait and lemon tinge of plumage were something quite different from other Ducks, and at once became, and reasonably so we think, characteristics to be sought.

3, The third course open to breeders is one which has also been followed, but which we think extremely undesirable in the case of

imported breeds of well-marked features. When Leghorns were first brought to us from America, whither they had probably gone from Italy, they had as now yellow legs and corresponding yellow earlobes. Certainly the latter appendages were of a silky hue and not beautiful, but the best and finest birds had them, and probably they had long appertained to the breed. At once English fanciers set to work to get rid of them; they crossed Leghorns with Minorcas, forgot about size, about colour of hackle, about brightness of legs—the great object was white earlobes. They have almost been obtained, but at great sacrifice. This is simply a puerile fancy, and not the breeding of true fanciers.

We have instanced these cases to show the way in which we think a well-defined oriental breed like Japanese Bantams should be approached. Things in the east move slowly; but if slow, easterns are very persevering. It is probable that all selection of particular specimens with the view of producing or perpetuating peculiarities originated in the east. It has doubtless been the cradle of our races of fancy poultry and fancy Pigeons as it has been of races of men. It is impossible not to admire the patience and perseverance of those who have produced the many curious types of oriental Pigeons, or distinctive miniature races like the Pekin or Japanese Bantam. When intelligent people have for generations been aiming at producing a bird with certain characteristics it is perfectly ridiculous for us, their inferiors in the skill and patience necessary for such a task, just to decide that this is and that is not to be a point of a breed without doing our best to discover what its producers and native fanciers consider to be its beauty. As in the case of Japanese Silkies, there is much probability that in these days when communication, even in Japan, is ever becoming easier, travelling fanciers will give us some information, and some may be gained possibly from pictures, as to the true standard for these Bantams. At all events, we hope that those who have to draw up such a standard for the guidance of breeders will look to the points of those imported birds which are evidently highly bred. They will, we fancy, have little difficulty in seeing that short legs and long tails carried squirrel-wise are among their characteristics, and then we shall not see a cup card over a pair with long legs and small tails. It matters not so much who wins this or that prize, but it is a pity that by such an award unthinking English fanciers should be encouraged to try and spoil a beautiful type of bird which it has probably taken various intelligent Japanese a few generations to obtain.—C.

OUR LETTER BOX.

Silver-Laced Bantam (Baltimore).—If there is the slightest discharge from the nostrils do not let the bird run with the rest. Try effect of injecting dilute solution of chlorinated soda through the nostril, two parts water to one of the solution. If this does not answer you can only cut open the face and remove the cheesy formation.

Fowls Pecking off Each Other's Feathers (G. A.).—Your fowls lack something, or they are overfed. Supply them with growing sods of grass, and let plenty of fresh soil be taken up with these; let the birds also have lime and bricklayers' rubbish in their run. If you have Lettuces, give some to the fowls.

METEOROLOGICAL OBSERVATIONS.

CAMDEN SQUARE, LONDON.

Lat. 51° 32' 40" N.; Long. 0° 8' 0" W.; Altitude, 111 feet.

DATE.	9 A.M.					IN THE DAY.				Rain.
	Barometer at 32° and Sea Level	Hygrometer.		Direction of Wind.	Temp. of Soil at 1 foot.	Shade Temperature.		Radiation Temperature.		
		Dry.	Wet.			Max.	Min.	In sun.	On grass.	
1883										
January	Inches.	deg.	deg.		deg.	deg.	deg.	deg.	deg.	ln.
Sun. 7	30.491	39.6	37.7	N.E.	43.0	40.8	38.2	47.9	35.4	—
Mon. 8	30.262	32.7	32.3	N.E.	42.1	42.0	30.7	60.2	25.2	0.029
Tues. 9	29.897	35.4	32.4	E.	40.8	39.8	32.1	58.8	31.9	0.019
Wed. 10	29.645	40.6	39.7	S.E.	40.1	43.2	33.2	46.1	29.4	—
Thurs. 11	29.605	40.1	39.7	S.E.	40.7	41.4	39.0	42.3	33.5	0.014
Friday 12	29.611	39.6	38.0	S.E.	41.0	41.9	37.8	52.3	37.2	0.038
Satur. 13	29.313	40.4	39.9	S.E.	41.0	44.3	38.5	47.9	37.0	—
	29.319	38.3	37.1		41.2	41.9	35.6	50.8	32.8	0.100

REMARKS.

7th.—Fine, bright, and cool.
 8th.—Fine with bright sunshine, rain at 8.30 P.M.
 9th.—Dry, very cold wind; bright sunshine in forenoon.
 10th.—Cold and damp.
 11th.—Dull and overcast throughout.
 12th.—Dry, overcast, except for short interval at out noon.
 13th.—Dull and damp, with rain.

The temperature has fallen rapidly to about its usual value, but accompanied by much damp and cloud, which has kept the range of temperature very small.—G. J. SYMONS.



25th	TH	Royal Society at 4.30 P.M.
26th	F	Quekett Club at 8 P.M.
27th	S	Royal Botanic Society at 3.45 P.M.
28th	SUN	SEXAGESIMA.
29th	M	Sale of Lilliums at Mr. Stevens's Rooms, King Street, Covent
30th	TU	[Garden.]
31st	W	Society of Arts at 8 P.M.

POTTING SHEDS—A SUGGESTION.

NEVERY week something instructive or interesting is forthcoming in the *Journal of Horticulture* for each class of readers, and frequently we are favoured with articles that the majority, whether they be employers or employed, are constrained to read with more than passing interest. In this latter category I should like to include my theme, being under the impression that a garden without a potting shed is quite as incomplete as a builder's yard would be without a workshop.

We meet with many strange apologies for potting sheds; in fact, according to my experience, utterly unsuitable structures are the rule, the exceptions being very few indeed. In some instances they are dark, cold, and wet; others are much too small, and it may be extremely dry and dusty, owing to the fact of the presence of the stokehole; others, again, are inconveniently disposed either as regards contiguity to the frame ground and compost yard, or too great a distance from the plant houses. Many have to be contented with the corner of a shed which also has to be utilised for storing roots, pots, carts, wheelbarrows, and tools. Yet it is in these miserable makeshifts much of the most important work connected with the majority of gardens has to be performed; and is it to be wondered at if it is "scamped," more especially by the assistants, who may be thinking more about getting into warmer quarters than the work in hand?

Slates and tiles have been too long employed for covering roofs where glass might with advantage have been substituted, and it is surprising to me that our undoubtedly clever horticultural architects and builders have not more fully realised this. Designs in abundance are forthcoming for houses adapted to the culture of all kinds of plants and fruits, and why should not potting houses be included? Not but what most gardeners are competent to design such a structure, but what is really wanted is the suggestion conveyed either by illustration and advertisement or a discussion in your columns. Once let employers as well as gardeners realise that a potting house may be made a source of profit and pleasure, and I venture to assert many new ones on improved principles will be constructed, as well as many old ones modified. For several years I have hoped to be in a position to arrange for the construction of a house on a very different principle to any I have yet seen, but as I appear to be as far off as ever from the realisation of my project, I am now writing with the motive of inducing others to profit by my not

quite original conception. What I wish to construct is a combination of potting house and either vinery, orchard, or plant house, and I have had ample proof the idea is by no means impracticable.

My ideal potting house would necessarily be disposed, built, heated, and utilised according to circumstances, everything depending upon the arrangement of the plant and fruit houses, whether much exposed or not, contiguity to the boilers, and what class of house either for fruit or plant culture was most required. In many cases it would have a span-roof, the walls to support this being about 9 feet high all round, the ends above this height being glazed. I would dispose a strong potting bench along the darkest side, a staging of the same width round the rest of the available space, and a strong shelf considerably higher completely round the house. These benches and shelves would be found serviceable for plant-growing, and more especially for drying off many plants and bulbs which generally, even when fairly treated, present a very poor appearance in the plant houses; and where unfairly treated—that is to say, when stored away under the stages, are apt to prove disappointing when taken in hand again. The roof could be utilised for Grape, Peach, and Nectarine culture, or if preferable, especially in an unheated structure, for Pears and Plums, the roots of these in each instance being confined in narrow raised brick pits under the benches. Roses, again, would succeed admirably on the roof or trained across overhead, and if preferable both these and Grape Vines may easily be planted in an outside border. I may mention having had the pleasure last season of inspecting a plant of Gloire de Dijon Rose growing in a very poor though light potting shed, which was carrying fully two hundred expanded blooms, while numberless buds were developing. I have also seen good Grapes grown in a potting house disposed on the north side of a garden wall and at the end of a range of houses. If these results are possible under difficulties much better things might be achieved in a well-designed house.

It may be said, "Why build a house for potting purposes that will cost as much as an ordinary plant or fruit house?" I argue, Is it not better to provide a roomy, light, and warm structure where most important work can be performed comfortably and without possible injury to the plants, especially seeing that this same house, besides being a boon to the employed, can be made profitable to the proprietor? According to present arrangements much of the potting necessary in the case of hothouse plants has to be performed in the houses where the plants are growing, simply because the sheds are too cold or otherwise unsuitable for the work. A potting house or shed need not necessarily be the receptacle of all kinds of rubbish, including heaps of soil, broken crocks, dirty and clean flower pots; on the contrary, all these even in many cases under the present arrangements should be properly disposed elsewhere.

As before stated, slates and tiles have too long been relied upon for covering roofs, as a glass roof if originally dearer is the cheapest eventually. Many an out-house, if glazed instead of being covered with slates or tiles, would easily be adapted for hardy fruit culture. With the aid of glass and no great amount of skill in cultivation, such kinds as Apricots, Plums, Cherries, Figs, and in many districts Peaches and Nectarines, could be relied on to yield abundantly, and without

materially interfering with the utility of the structure. Some of the best Grapes I have seen this season, and which were bought in this district, were grown in a glass corridor originally constructed for the purpose of affording a covered way between a private house and an office. A friend of mine grows Cucumbers in an engine room, and we also hear of similar places being utilised for plant culture. Glass is of necessity freely employed in the construction of railway signal boxes, and most of us have seen many of these gay with healthy pot plants.

One other example of the advantages of a glass roof and I have done. Several years ago I walked a considerable distance to see the crops of fruit hanging on a number of trees grown under a timber shed owned by a builder at Beeston near Nottingham. If I remember rightly the glass roof was supported at the back by a low garden wall, and in the front, which was highest and open, with pillars at wide intervals. Here was stored a great quantity of timber, while the roof was covered with Apricot, Peach, Nectarine, and Plum trees. The fruit of the former had been picked, but the others were beautifully fruited. Pitmaston Orange Nectarine and Coe's Golden Drop Plum were particularly fine. The trees were standard-trained, and I believe were planted and trained under the surveillance of the late Mr. Pearson of the Chilwell Nurseries.—
W. IGGULDEN.

CURRENT TOPICS.

INSECTICIDES—CARBOLIC ACID AND METHYLATED SPIRITS— WATERING, VENTILATING.

THERE is nothing, I quite agree with W. Litchfield of Coventry, like soft water and the syringe as an insecticide. If plants are kept in good health by proper care and attention in watering and syringing there is not the same need for insecticides, and a little soft soap in the water used at a temperature of 120° to 130° will do no plants harm, and is a pretty sure remedy against red spider, thrips, and green fly. I am, however, very much surprised that so many persons still recommend the most dangerous insecticide under its different names of paraffin, petroleum, kerosene oil, &c. It is quite insoluble in water. No doubt with soft soap, soda, and constantly working the syringe into the mixture it may for a time be separated into smaller particles, but it is almost always left behind on the leaves in its original form of paraffin, and nothing is more destructive to tender foliage than it is. The smell, too, which is left behind when a house has been freely syringed with it, is enough to drive anyone out of it for many days, and, after all, it will not kill mealy bug. I have found carbolic acid much safer to use; merely the common commercial carbolic acid.

One of the simplest ways is to get half a dozen or more clear quart winebottles and place in half of them about an ounce of carbolic acid each, then fill up with soft water. When the acid, which is heavier than the water, has settled pour off the liquid, which will be nearly clear, into one of the empty bottles, and continue the process till all the acid is dissolved. The result is a saturated solution, as pure soft water is capable of dissolving, according to the strength of the carbolic acid, a certain per-centage. This solution may be corked for use, and about one part to ten be added in the water used for syringing. It is especially useful for scale and the white aphis, and one advantage is that it does not leave the same unpleasant smell behind, nor does it injure paint as soft soap and paraffin does. It is better not to use it too strong with tender young foliage, but plants that have stiffer foliage, such as Camellias and Cyclamens, can bear it stronger.

I have also found methylated spirit a very useful application to destroy mealy bug, used with a feather or camel's-hair brush in places where it is difficult to remove with a sponge. Take,

for instance, the flower of the Poinsettias in the centre of the bracts, and those of the Stephanotis when first showing buds. May I ask those who have tried fir-tree oil whether there is any practical difference between it and pure turpentine, which I have of en used in very weak solution, especially for black aphides on Peach trees in a small unheated Peach house, syringing afterwards with pure water?

While speaking of the free use of soft water, I can quite corroborate the remarks of one of your correspondents on the subject of watering plants, especially, I may say, in winter and early spring. I find it most difficult to make persons who are not thoroughly experienced in watering understand when to water and how to water. So many men water all the plants in a house, when they are told to water, indiscriminately, whether they are in large pots or small, or whether they are dry or not, or whether exposed to the action of hot-water pipes or standing in the cooler parts of the house. I remember once in a friend's garden being asked by the gardener what to do to prevent Calceolarias damping off. He took me to see them, and I saw the bedding Calceolaria amplexicaulis and *C. aurca floribunda* in small pots on shelves in a vinery facing the south, catching every ray of sun there might be, and flagging by want of water. He was rather surprised when I told him the only chance was to take them down from the shelf and plunge each in a bucket of water, and then to stand them in the coolest place he could find; and he was still more surprised when I told him that none of my bedding Calceolarias were ever inside a house, but were always struck in the open ground with a frame over them, and merely protected by litter in severe weather. Some persons, again, only keep the surface of the soil damp, giving a slight sprinkling with a rose on the surface, whereas the roots may be as dry as ever. Others, again, when the pots are thoroughly dry and the soil cracked away from the sides, hear the water go through, and think that the plant must be properly watered. Nothing in my experience injures plants more in winter when fire heat has to be kept up than allowing them to be too dry at the roots, especially when on open staging over hot-water pipes, for when once the leaves of a plant flag by want of water the younger and tender rootlets are sure to suffer.

The question of ventilation, too, which has much to do with watering, has cropped up in your last issue. For my part I am sure that in winter very little ventilation is ever required, as hot-water pipes secure a constant circulation of air. I have openings in the brickwork under the stages with moveable shutters worked by means of a cord, and air is supplied under the plants so as to come in contact with the hot-water pipes before it is admitted to the house. What we have to avoid is cold draughts, which are not necessary for securing a proper change of air.—C. P. P.

TASTES IN FLORICULTURE.

IN his note on "Horticulture in 1882" "*D., Deal,*" speaking of the "craze for single Dahlias" (page 56) says, "The craze has, I think, been evidently encouraged by the granting of seven certificates for single Dahlias in one day by the Floral Committee." Will you allow me to remind him and your readers that on this occasion the two largest growers exhibited, and that a great part of the tables on both sides of the Council room were covered with endless new varieties of colour, making a display which will not soon be forgotten? The Floral Committee selected seven out of the hundreds for first-class certificates—that is, they marked seven single Dahlias as being in their opinion far in advance in colour and form, and as being very desirable plants, but did not in any way consider the comparative merits of single and double Dahlias. I think, judging from the opinions expressed by people about here, considered of taste, on single Dahlias grown in a neighbour's garden, the craze is likely to be an enduring one. There is no doubt that there are situations in some gardens suitable for single Dahlias where the most beautiful of the doubles would be out of place, unless, perhaps, some of the beautiful little Pompons which Mr. Turner has brought to such perfection. It seems to me best to enjoy one's own hobbies, and let others enjoy theirs. The bountiful mother Horticulture has

pleasures and work enough for all her votaries, with all their varieties of taste. Some take the greatest delight in Carnations arranged by means of a pair of pincers; others in making individual Gooseberries of an enormous size; others in beautiful varieties of Ferns; while others care only for species. Bog plants, water plants, rock plants, Orchids have all their admirers, and I think it is best for the advancement of horticulture that this should be so. I should have written this note sooner after the publication of your Journal, but had been away on a short garden run with my son. It began with Sir Trevor Lawrence's Orchids, which were a great treat, and reminded by their perfect cultivation of old days with Mr. Rucker, only with a great increase of numbers of species and varieties. We then went to a relative at Reigate, who gave us the best large home-grown Oranges which I have ever tasted from a tree in one of his houses, and drove us over to Pendell Court Gardens, where Mr. Green showed all his plant wonders. The cut blooms which he brings up from time to time to the Floral Committee give but a faint idea of their beauty when seen on the plants. The out-of-door department, where I should have been most at home, was at rest, but showed what beauty there must be in summer.—GEORGE F. WILSON.

FRUIT-GROWING ON CHALK SOILS

THE criticism of your correspondent "J. H. H." on page 29 on the above subject, demands a passing notice from me; brief it shall be, but to the point. In the first place I must candidly say that on reading his remarks over a second time I was somewhat doubtful as to whether I ought to come to the conclusion that he was a practical man or not. Assuming, however, that he is, I am surprised that he is not better acquainted with the writings of any of the old authors than he appears to be, and that he is not is plainly visible from the fact of his statement "Fifty or a hundred years ago, before the advantages of root-lifting and pruning were understood," &c. If he did not know it before, let me inform him now for the first time that the practices referred to have been known for centuries.

Seeing that "J. H. H." admits that he has had no experience on chalk soil, it is quite evident that he is not qualified to give an opinion of much value on the subject, and it seems rather strange why he should put himself forth as a teacher on such a topic, as what he states can have little weight with those who are located on chalk soils, and in whose interest my note (page 525 last volume) was written. The number of random phrases your correspondent makes use of precludes me from alluding to all of them in detail; at the same time I cannot refrain from referring to one or two. Firstly, as to "imported loam," permit me to say that if he will read my note (page 525) over a second time he will find no allusion made therein to such a commodity. What was mentioned was "the best that could be obtained in the locality," and not brought "ten miles by canal route."

"J. H. H." also asks, "Is the garden to be deepened by rendering barren a portion of the park or farm?" Decidedly not, is my reply; neither is there any necessity for such a thing, and this your correspondent may prove to his own satisfaction if, when he obtains turf from pasture land, he will add the same bulk of old soil from the garden and sow it with a mixture of grass seed suitable to the locality in April. By so doing he will hardly be able in twelve months' time to tell where the turf was taken from. My reply to "J. H. H.'s" note might be considerably enlarged, but as I am no advocate for superfluous writing I will not trespass on your valuable space by any further comment.—ET CÆTERA.

CHRYSANTHEMUMS AT CHRISTMAS.

A FEW words may be interesting to some of the numerous readers of the Journal as to the best way to attain flowers as late as Christmas. Much depends upon the treatment the plants receive through the growing season. I have had some good flowers of a few varieties until the 4th of this month. The treatment I give them is about the same as the other earlier-flowering varieties until the last stopping, which is not done until the end of July. The plants are kept outside as long as possible, covering them at night with tiffany or anything light. I afterwards place them in a house having a north-west aspect, used also for retarding Azaleas and other plants. I do not grow a large number of varieties, only a few of which I find keep best. I cannot speak too highly of Snowdrop, a most valuable Pompon sent out by Mr. Cannell last spring. It is very prolific, not large, but pure white; in fact the later it flowers the more pure they are. It

requires no disbudding. Fleur de Marie is another valuable pure white variety of the Anemone type, flowering remarkably late, though the guard florets are apt to damp. Malvaeflora is a very late Japanese form, also pure white; but to have it good it must not be stopped at all. I have mentioned these three, as white flowers are always in demand, more especially at Christmas and Easter. I cannot too strongly recommend Lady Slade as a lilac incurved variety which comes very handsome late. This I think the best of all the coloured kinds, especially for specimen glasses or table decoration. Isabella Bott is another grand variety. I must not omit one other Pompon, a very useful variety of the Anemone section; it is useful for bouquets or floral decoration, as it lasts a long time after being cut—Souvenir de Jersey, a very bright orange Pompon, with fringed edges and lasts remarkably well, but must be disbudded or it will not be satisfactory.

The following are a few others which I have found useful of the incurved sorts:—Angelina, Blonde Beauty, Guernsey Nugget, Hero of Stoke Newington, Duchess of Teck (a sport from Hero of Stoke Newington); Themis, Nonpareil, Eve, Yellow Perfection. Julia Lagravère is a very useful reflexed variety, one of the darkest in colour, must not be disbudded. Progne is also very useful and keeps well, requiring disbudding. Several of the Pompon varieties I find keep well, such as Brilliant, Bob, Calliope, Madame Marthe, and the Golden variety of the latter which should be in every collection. Rosinante is very free, silvery-rose tipped with gold; this is one of the very best to grow in small pots for market or furnishing.

Japanese do not keep so well as the incurved kinds. I find La Nymph one of the very best; with Fair Maid of Guernsey, White, Meg Merrilees, Striatum, Yellow Dragon, Gloire d'Or, Laciniatum (comes very pretty when not disbudded), and Grandiflorum. I may here add I have seen some quantities of Elaine, and very good flowers too, produced on the stems of plants where the flower was cut early in November. Guernsey Nugget will throw very useful flowers this way; I have had these as late as the end of January. Perhaps these few remarks may induce some of your readers to state their experience with late-flowering Chrysanthemums.—A GROWER.

A TRIAL OF POTATOES.

I SEND you the results of last season's trial of the following kinds of Potatoes. Possibly you may think them of interest to your readers. 7 lbs. of each variety were planted, and the produce is as follows:—Ashleaf, 41 lbs.; Suttons' First and Best, 30 lbs.; Beauty of Hebron, 84 lbs.; Reading Hero, 126 lbs.; Reading Russet, 68 lbs.; Reading Abbey, 39 lbs.; Suttons' Fifty-fold, 65 lbs.; Suttons' Red-skin Flourball, 120 lbs.; Magnum Bonum, 102 lbs.; Rector of Woodstock, 42 lbs.; Schoolmaster, 46 lbs. It will be seen that Reading Hero is the heaviest cropper, but the two seasons I have grown it it unfortunately decayed after being stored; so I reluctantly discard it, as I do the light croppers. For the future I propose growing only Magnum Bonum, Red-skin Flourball, and Beauty of Hebron. I may add the eleven rows were grown side by side, 27 inches apart; each consisted of eighty roots, 14 inches apart, and on a light soil without manure. If the three sorts I have selected can be improved upon I shall be exceedingly glad of any hints to that effect.—J. ROBINSON, *Suffolk*.

PLANTS FOR A DARK CONSERVATORY.

A DIFFICULTY.

WILL any of your readers kindly tell me what climbers or other plants are best suited for covering the back wall and roof of a dark conservatory? The house is 28 feet long, 11 feet 6 inches high, and 9 feet 6 inches wide, the only light it gets being from six windows in front, which are 3 feet wide each, 5 feet 6 inches above the floor, and glazed with small panes of glass about 1½ inch wide and 5 inches long. The house can be heated in cold weather.

May I further ask what plants are best suited for the decoration of this house? We have no stage nor any means of planting out, therefore the plants are arranged on the tiled floor, and I find they damp off very much, while some, such as Ferns and Eucalyptuses, shrivel as though they were scorched. Would it be advisable to have a low stage, say about 18 inches or 2 feet high? Any information that can be kindly given will be gratefully received.—A. T.

LAMBETH PALACE GARDENS.—In a recent article upon these gardens in a daily contemporary the following particulars were given—"Authorities appear to differ as to the precise extent of the 'park and gardens' attached to Lambeth Palace. Originally it seems to

have been 13 acres, but it far exceeded this at one time. The kitchen garden used to cover 3 or 4 acres, and may do so now, and used to be famous for the abundance and excellence of its fruit and vegetables. Cardinal Pole is believed to have planted certain Fig trees, which formerly grew against that part of the building, with the foundation of which he is accredited. Mr. Allen says that they 'are of the white Marseilles sort, and still bear delicious fruit.' When Allen wrote, however, Lambeth was hardly the Lambeth of to-day. The smoke demon had hardly overspread the place as he has now, and if Cardinal Pole's Fig trees were still in their prime they would, we fear, hardly be very famous as fruit-bearers. There were two of them, and Mr. Timbs, in his 'Curiosities of London,' says that they were more than 50 feet in height and 40 in breadth, and one of them was 28 inches in circumference, and the other 21 inches. They had to be removed during the rebuilding of a part of the Palace, but they are, we believe, represented still by young trees propagated from them, and still growing between the buttresses of the library. There used to be in a small private garden attached to the Palace a third Fig tree, traditionally asserted to have been planted by Cardinal Pole like the other two. Whether that, too, has disappeared we are unable to say. Another feature of the grounds here, which used at one time to attract considerable attention, was a curiously constructed summer house, said to have been built or designed by Dr. John Ponet, chaplain to one of the Archbishops, and who seems to have been something of a genius this way. It was a wooden fabric standing a short distance from the Palace, and was repeatedly patched and repaired by Archbishop Parker. At length, however, it fell into such decay that it had to be cleared off. The garden has suffered a good deal in many ways. In 1779 a terrific storm threw down three chimneys from the Palace and tore off a great part of the roof, while in the grounds no less than seventeen large timber trees were uprooted. Then the embanking of the Thames took off a slice, which unfortunately included the famous 'Bishop's Walk,' with its fine row of Elm trees, beneath which crusaders and monks, priests and princes, had strolled and chatted century after century. After all curtailments, however, it was stated the other day at the Metropolitan Board of Works that the gardens and the meadow at the back of the Palace still measured about 21 acres in extent."

MAKING AND RENOVATING LAWNS.

(Continued from page 48.)

THE lawn set apart solely for ornament should be on that side or front of the mansion or building it adjoins which is least liable to have its privacy interrupted. It should also be in the position with the best aspect for viewing distant objects, whether park, woodland scenery, or cultivated ground. A hedge or fence of any kind as a boundary is most objectionable, but as some means of separation is absolutely necessary a flat-bar iron fence is the best, as a sunk fence is now seldom formed. It should not be intersected by walks, but if one be absolutely necessary it should be taken directly across it and parallel with the line of the building, at a distance from the latter equal to the height from the base to the eaves, which will admit of the building being viewed from the walk at a favourable angle—*i.e.*, 45°. It is desirable in most cases to have the lawn with a gentle slope from the building, which allows of the latter being seen to the best advantage, and the objects or prospect from it are observed most effectively.

THE SURROUNDINGS OF A LAWN.—If the lawn terminate in park scenery, broad expanses of green sward, flat or undulating, with trees, mostly deciduous, having umbrageous heads, as Oak, Elm, Limes, Beech, and Chestnut, and such smaller trees as Thorn, Beam, Mountain Ash, and Wild Cherry, with Holly and Yew as evergreens, Alders, Willows, and Poplars being employed in low wet positions or for skirting streams; with Oak on the deepest and best soil, knolls supporting Crabs, Thorns, &c., associated with Holly and Yew, the higher eminences capped with Pines, and the declivities with Spruce; but whilst the park trees are chiefly of an indigenous character, nearer home exotic trees may be employed with advantage, yet not to the extent of forming a distinct feature. I do not mean that because the park trees are principally Oak, &c., that those ought to be continued right up to the building to the exclusion of other trees; nevertheless, an Oak would be the fittest and most effective object that could be employed for the lawn at one or both flanks of the building, and for the front too if the building recede in any part of its frontage. The stately forms of deciduous trees harmonise better with a building at all seasons than monotonous tapering Conifers, the majestic Cedar of Lebanon alone excepted. With park scenery comprised of the commonest trees, a Holly or Yew is more in character in the foreground than any exotic, simply because they harmonise with the adjoining scenery. It is not intended that because there be Oak it must not be associated with the other varieties and species of the genus; that having Beech the Purple and Fern-leaved must be excluded, and so on with Elms and

Maples, for to do so would be to lose much beauty inseparable from variety and contrast both of form and colour.

In case the ground slope from the building and is terminated by a hollow, advantage should be taken of this where there is a proper supply of water to convert it into a pond, widened stream, or lake, as the extent of the hollow and supply of water will admit. If there be a constant supply of water so as to admit of the formation of a waterfall or cascade the lower end may be formed of rock; and being formed of boulders bedded in and coated with cement so as to resemble natural rock, it will have an effective appearance when seen obliquely, as it should be, from the principal point of view, the sides of the fall or cascade being planted with dwarf evergreens, such as *Rhododendron ponticum* associated with Ferns at the foot of the rock. If the view beyond the water extend in park or other scenery, trees or shrubs should be introduced sparingly if at all, and when employed should be in keeping with that of the scenery beyond; but if it be near cultivated ground the planting at the back must be more liberal, and, whilst not entirely closing the view in that direction, will considerably modify the formal aspect. If on the other hand, it is inadvisable to continue the view beyond the water, then with as large a grass margin as the ground admits of, a background of such shrubs and trees as are adapted for low ground if flat; or if it rise more or less abruptly, commence with such plants as *Rhododendrons* disposed in groups irregularly, associated with Conifers (*Abies*, including *Piceas*) that thrive in moist soil; and as a higher elevation is reached *Pinuses* should be disposed in masses of one kind with *Larches* and *Scotch Fir*.

In case of the building being situated on the side or at the foot of a hill, the ground sloping from it more or less regularly, or it may be abruptly, to a ravine or wooded valley with a stream of water at the bottom, the treatment will be of a more difficult description than in any of the foregoing, as indeed it will excel in interest and beauty from the greater variety and extent of view. When the ground slopes gradually from the principal point of view to the stream it will be well to continue the lawn if it can be seen down to the water and continue it on the other side, so as to show the water to the best advantage and for the display of trees on the margins. If at the entrance of the stream from the wooded sides of the ravine to the grassy plain it can be made to form a waterfall, it ought to be done.

If the ground is very abrupt, so as to prevent any great extent of visible lawn being formed from the principal point of view, then it will suffice to form so much as can be readily seen, and form at this point that which is to be the foreground to the tops of the trees below and beyond. These of necessity must be low, but of different heights, so as to give the whole a tufted appearance, harmonising with that of the trees below; for however wooded a valley may be, the trees forming it will have attained to different heights. If the view beyond the wooded valley be that of cultivated land distinguished by hedgerows with farmsteads, then it will first be essential to so plant the sides as to break the monotony of the lines of fence, and this more particularly next the wood, disposing them so as to have a harmonising effect. With a farmstead so situated as to form an object of interest and beauty it should be made to stand out prominently by planting trees at the back and sides, and be seen through a vista by allowing the trees on the margin of the wood to be of a low or shrubby character, or, better still, let the homestead be seen across green pastures.—G. ABBEY.

(To be continued.)

MARÉCHAL NIEL ROSES.

I FIND this fine Rose succeeds very well on the Briar stock; and if I want to raise any, all I have to do is to plant Briars against a south wall, and have them budded there. In fine seasons like we had some years ago they did pretty well budded in the open garden, but have not done so lately. The severe winters of a few years back were very trying. I have had large trees with as many as two hundred fine blooms all out at one time against the house; but they were much injured by the severe frost, and either died or had to be cut back, but I have young ones coming on to supply their places. In the absence of any very severe frost they have a tendency to get bare at the lower part of the tree, and should be cut back and started again, or Briars planted to be budded and take the place after a while of the old. It is not too late to move Briars now for that purpose.—AMATEUR, Cirencester.

CULTURE OF HYDRANGEAS.—Mr. A. Young has given some very good hints on the culture of this useful plant, but I think he has omitted one important point in its cultivation—namely, disbudding

or thinning the flower truss. I differ slightly from him in their management, as I transfer them from thumb pots into large 60's, and winter them in them, and when they are started and the truss is formed I place them into 48's, and when the truss is sufficiently expanded thin it to at least two-thirds.—J. SMITH.

ONCIDIUMS.

(Continued from page 24.)

O. ROGERSI.—This deserves a place amongst the best of the whole genus, and it is now a great favourite with all Orchid-growers, as it is very showy and very free when grown in pots in

a warm house. The lip constitutes the great attraction of the flower, that being of great size, frequently $2\frac{1}{2}$ inches in diameter, rich yellow in hue, and slightly lobed at the upper part. The flowers are borne in large-branched spikes or panicles, and a plant in good condition is one of the most striking Orchids during winter. It is a variety of *O. varicosum*, but much superior to the ordinary type, and was introduced from Brazil about twelve years ago. Two other somewhat similar yellow-flowered Orchids are *O. ampliatum majus* and *O. bifolium majus*, but these bloom in spring and early summer. Very handsome specimens of the former are occasionally seen at exhibitions, one of the finest being that shown by Mr. Childs of Garbrand Hall Gardens, Ewell.



Fig. 16.—ONCIDIUM ROGERSII.

A trio of very distinct but extremely useful small-flowered species are *O. cucullatum*, *O. ornithorhynchum*, and *O. cheirophorum*. Of these much the largest flowers are borne by the first-named, the sepals and petals being purplish, the lip rosy purple with deeper spots, some recent varieties being considerably richer in colour and with larger flowers than the older forms, while one has a distinct yellowish tinge. *O. ornithorhynchum* has very small fragrant rose or purplish flowers, but they are borne in such dense panicles that they amply compensate for this defect. A

white-flowered variety is also in cultivation, and forms a beautiful companion for the ordinary type. *O. cheirophorum* is very similar to the last named in the size and form of the flowers and in the form of the panicle, but the colour is clear yellow, and therefore quite distinct from the preceding. It is, however, not so well known as those, and is well worth more attention, as the flowers are very fragrant and bright in colour. It is a native of New Grenada, where it was found by Warscewicz at an elevation of 8000 feet on the volcano of Chiriqui, where it was "flowering

in December, with the thermometer only a few degrees above freezing point." The species is much better known upon the continent than in England, but it has now been in cultivation here about ten years, the first plants having flowered at Kew in 1872. All three are cool-house Orchids, and succeed satisfactorily with *Odontoglossums* and similar plants.

Dozens of other beautiful species could be named, but sufficient have been mentioned to show the principal characters and qualities of the genus, and the following list contains the best, arranged under the heads Cool and Warm-house Species.

Cool-house Oncids.—*Barkeri*, *bifolium majus*, *cheiroporum*, *concolor*, *cucullatum*, *dasystyle*, *excavatum*, *incurvum*, *leucochilum*, *macranthum*, *ornithorhynchum*, *varicosum*, *Rogersi*, *stelligerum*, and *tigrinum*.

Warm-house Oncids.—*Ampliatum majus*, *Cavendishianum*, *crispum grandiflorum*, *flexuosum*, *Forbesii*, *hæmatochilum*, *Kramerii*, *Lanceanum*, *leopardinum*, *Marshallianum*, *Papilio*, *sarcodes*, and *zebrinum*.—L. CASTLE.

EASTER BEURRÉ AND BEURRÉ RANCE PEARS.

I CAN quite confirm what A. Young and "A Notts Gardener" say with regard to Easter Beurré and Beurré Rance. They are of very little use except as stewing Pears in the north. Easter Beurré against a south and a west wall used to do very well in my father's garden in Notts in a good sandy loam, and knowing it well there I planted it here. But, like many of the late ripeners, it is an early bloomer, and seldom sets its fruit well. I found, too, that the older the tree became the more the fruit cracked and cankered, and I have cut it down to make more room for a Marie Louise which was growing alongside. Beurré Rance is also condemned with me, as both a shy bearer and seldom ripening except in more than usually favourable seasons.—C. P. P., *North Yorkshire*.

I WAS somewhat surprised to see Beurré Rance so unfavourably spoken of in our Journal last week on page 24, as I had an impression that it was a much more reliable variety. We have two trees here growing in an old orchard which were planted in the year 1835. On Friday last, after receiving the Journal, I measured the tallest tree, and its height was about 41 feet. This tree scarcely ever fails to give us a crop, and last season carried nearly three bushels of fruit, all of which (with the exception of a few split ones) were fit for table. There is an Elm plantation on the north and east sides of the trees which shelters them from cold winds, otherwise they stand in an open position.

Easter Beurré we do not grow, so I am unable to give an opinion respecting it.—F. H., *Oxon*.

THE INSECT ENEMIES OF OUR GARDEN CROPS.—No. 1.

THE cultivator of fruit and vegetables, whether it be on a large or a limited scale, is sure to make the acquaintance of a variety of noxious insects; noxious—that is, as seemingly interfering with his success. But in the case of some of the insects that are feeders on plants under our management, it may be concluded they are merely removing what had previously entered on the first stage of decay, though other insects do certainly devour roots, leaves, and fruit that are perfectly healthy. Several writers have propounded a theory, satisfactory to them, that the insect enemies of the gardener are sent to make him diligent and careful, showing him that he must take precautions not only against unfavourable weather and the larger creatures who may damage his crops, but against others whose very insignificance is apt to lead him to neglect them. It would appear that in most of the kitchen gardens of the olden time insects were allowed, to a great extent, to multiply unchecked, save only in so far as they were destroyed by their parasitic foes, or by those insect-eating birds formerly more numerous than at present. Hence the modern gardener has a vast advantage over his predecessor; having a knowledge, by no means despicable, of the habits of garden insects, he has also an abundant, perhaps too abundant, supply of remedies to select from. To read the testimonials put forth concerning some of these, almost convinces us that garden insects, by their judicious application, might be entirely eradicated from our beds and frames. But then where would be the occupation of the makers of these compounds?

In the kitchen-garden department, however, as in others, it is a mistake to suppose that all insects seen about are really injurious. Some of those we notice on the wing are simply passengers on their way across to their special resorts. Some, again, have come to our ground in order to draw the nectar from flowers, or they clear

away vegetable refuse. Then there are extensive families, whose instinct leads them to prey upon other insects, and they frequently attack some of our worst enemies just at a stage in their growth when a material check is given to their increase. How important is it, therefore, for a gardener to know at least as much of entomology to enable him to distinguish the common harmless species from the harmful! It is to be noted, though, as a curious fact, that there are instances of very close resemblances between different groups, by which, doubtless, some predatory insects are favoured; and also we have several rather perplexing cases where an insect is at one age useful and at a later age injurious.

The order Lepidoptera, which embraces the butterflies and moths, stands out conspicuously amongst the orders of insects, because to it belong the caterpillars of very varied size, which in many seasons are unpleasingly numerous in the kitchen garden. Their habits were observed even by our unscientific ancestors, who named these creatures, from the effects of their ravages, the "peeling" or "pilling" of plants by the stripping off of their leaves. Hairy or spiny caterpillars, such as that of the tiger moth or the tortoiseshell butterfly, seem to have had the name of "palmerworm" reserved to them, because they are garbed like the palmers of old. All these insects do not feed openly upon the leaves or flowers, as is the habit of many; there are others that carry on their attacks insidiously by burrowing near the roots or working their way into the stems of plants. In their winged state these insects are harmless, except as propagators of their species. Amongst some of the orders of insects we find instances where nearly allied species are hostile to each other, but it is not so with the Lepidoptera of our gardens. There are, however, a few cannibal caterpillars; these occur upon trees or shrubs, chiefly upon those growing in woods and hedges.

We pass on to the Coleoptera as the order next in importance, and this division, embracing the beetles of very varied size, from giant stag beetle and cockchafer down to insects not larger than the head of a pin, furnishes a contingent to our garden foes, in which numbers make up for the small bulk of the majority of the species. Here we have instances of mischief done by the fully developed beetles, and also by the grubs and larvæ, and occasionally a species is noticed to be both hurtful and helpful in two of its stages, though the mischievous qualities are apt to outweigh the beneficial ones. To mention the Turnip beetle or flea, the "wireworm," the Pea weevil, and the black or "grooved weevil," is sufficient proof that the gardener has need to take active precautions against insects of this order, which very often cause him serious losses and disappointments. From their cautious habits they succeed in destroying or greatly damaging some crops before they are observed, and in several species the insects seize the moment for attack when the plant has little vitality, or is exposed to trying weather.

The little order or group called Euplexoptera contains an insect greatly disliked by all gardeners, and one that is not easy to extirpate—viz., the common earwig. Although this insect is very partial to fruit, and also fond of lurking in flowers, especially in those with numerous petals, it condescends to visit some of our garden vegetables, and enjoys the warmth of frames. I am not certain if it is eaten by birds, but it appears to be avoided by most insects, inoffensive as it is. Even a spider may be noticed to eject an earwig from her web with an unmistakable movement of disgust. We are happily exempt in this country from the terrible locust, which is so notable an insect in the order Orthoptera. Its allies, the crickets and grasshoppers, can scarcely be said to be harmful to any garden plants if occasional insinuations have been made against the field cricket and the great green grasshopper. The mole-cricket, however, a species somewhat distinct, has been complained of as a burrower at the roots of vegetables; and the common cockroach, an eastern unwelcome guest, does make excursions during the summer season from the kitchen domain into the garden, desirous of a change of diet, but in nowise particular what it gnaws. Very few insects of the Hymenopterous order are guilty of injuring our vegetables, perhaps less than half a dozen species. One of these is the "nigger," or black canker fly, a foe to the Turnip. Recent inquiries, indeed, concerning an effective means of destroying ants would indicate that some modern gardeners are unkindly disposed towards these busy insects. Entomologists have mostly been inclined to regard the ant tribes as useful in gardens on the whole, though they may be partial to over-ripe fruit. On the other hand, amongst the four-winged flies in this order are a great many species that, as parasites upon caterpillars and grubs, help to diminish the numbers of some of our worst enemies. Various predatory species, large and small, also seize other insects and carry them off to suck their juices; the much-abused wasp, for instance, kills each season swarms of flies and grubs.

The "bugs," to use an uninviting but appropriate epithet for the insects placed in the order Homoptera, would, if left unmolested, convert many a promising garden into a scene of desolation. "Black fly," "green fly," flies of divers colours belonging to the aphis tribe, spare few of our vegetables, appearing at intervals during the season; the unpleasant "cuckoo spit" (*Aphiphora spumaria*) has its special time of attack in the early summer. To this order belong the scale insects, but they rather frequent the houses and orchards. And then we come to the Diptera, or two-winged flies, an order bringing us many minute but ever-active enemies to the Cabbage, Lettuce, Carrot, Celery, Onion, Turnip, and other plants in much demand. Yet here we have also our friends in the form of parasite destroyers of insects. Lastly, in a rather anomalous group we have such wingless species as the millipedes, the mites, and those curious skippers, the Collimbola.

—ENTOMOLOGIST.

BRUSSELS SPROUTS.

THE last few years I have been very much disappointed with Brussels Sprouts. I tried all the varieties in the catalogues, but they all came very irregular, some producing good buttons, but as a rule the greater part were worthless. I determined to select plants and save seed, but the severe winters stopped me. After seeing the Aigburth at the International Show at Manchester I decided to give it a trial, which I did, and a finer piece of Brussels Sprouts I never saw. They are about 2 feet high, and every plant is true. Some of the buttons are rather too large for the table, but not for the servants' hall, and there are plenty that are small enough. I am so well satisfied with it that I thought I should grow nothing else, but the favourable accounts of Reading Exhibition has induced me to give it a trial.

The seed of the Aigburth was sown the first week in March in a cold frame. By the time the plants had been twice transplanted a piece of ground that had been trenched the previous winter was planted in spring with Early Hammersmith Potato. These were now cleared, and the Brussels Sprouts planted with large balls of earth. I might add they were previously transplanted on a piece of ground adjoining, as they could not so easily be carried to a distant part of the garden.—J. L.

LOMBARDY POPLARS AND FROST.

THE effects of the severe winter of 1880 have been particularly noticeable in this village of Astwood Bank, locally known as "The Bank" from its elevated position or ridge, which a mile nearer Evesham is named Ridgeway, on the borders of Worcestershire and Warwickshire, nearly midway between Birmingham and Evesham, north and south, and nearly equal distance from Worcester north-east. Before the severe winter referred to it has always been a very easy matter to point out the village in the landscape from a distance of many miles by the many slender Lombardy Poplars then growing, now I do not think there is one left "to tell the tale." Standing on a prominent spot in September last, when other trees were in full foliage, I counted over fifty leafless Poplars which have now succumbed to the woodman's axe. It is also curious to notice that the same species of Poplar only a short distance away, situate in a valley, the tops of which would probably be on a level with the roots of those killed, are still living. Now, as a rule, frost is more severe in low-lying places, and the inference is that it must have been the penetrating wind which accompanied the frost at the time which proved so fatal. It would be interesting to hear any remarks from other quarters on the subject.—J. HAM.

RAISING VINES IN TURF.

WHAT does "Vitis" mean by growing young Vines in turf? Does he mean he strikes the eyes in pieces of turf and places that on bottom heat, or how? How thick should young canes be in autumn struck from eyes in the previous February?—H. STONE.

[We promised in our correspondence last week to reply to this question more fully than we could do in the column in question. As the subject is one of importance, and this method of propagation a most excellent one, we reproduce the article of its originator, Mr. William Thomson of Clovenfords. Our correspondent "Vitis" appears amongst others to have followed Mr. Thomson's practice and has found it worthy of recommendation. So have we.

"My objections to the usual system I had better state to begin with. The first is the rich soil used for growing the Vines. This gives rise to strong soft roots few in number, and which generally perish during the winter. The second is the coiling of the roots,

first round the small pot, in which the eye is started, before it is shifted into a larger pot; then the same process continued in the larger pot; and lastly, when the Vine has to be turned out of the pot for planting, the extreme difficulty of disentangling the roots, in which process all the spongiolles and small roots are destroyed, leaving a few long bare roots which have to be spread out in the border, reaching a long way across it, and from the points of which the newly-formed roots start, leaving a great part of the carefully prepared border behind them.

"To avoid such evils as I consider these are, I proceeded as follows:—On the pavement of what was intended for and is now a Pine stove, under which are hot-water pipes for giving bottom heat, I placed a complete covering of tough fibry turf taken off a sheep-walk; on this I placed 4 inches of fine fibry maiden loam. In this, at a distance of 6 inches or so from each other, holes an inch deep were made, and filled with white sand, and in the sand the Vine eyes were placed, and just covered with it. The bottom heat did not exceed 60°.

"The Vine eyes started in the usual way, and out of sixteen hundred not six failed to make rapid progress. When they were about 9 inches high, with four or five fully developed leaves, and their first set of strong quill-like roots beginning to interlace each other, I had each plant cut round with a knife, so that it rested on its own isolated bit of turf, and had the points of its roots cut off. They flagged a little for a few days, but soon began to grow again, and I had each plant raised on a square trowel and transplanted to a similar bed of turf and fibrous loam, but this time they were placed from 9 to 12 inches apart, according to their strength, filling in all round with loam in which there was no manure of any kind. When raised on the trowel, the edges of the square of soil they were growing in was a mass of fine white needle-like roots springing from the large roots that were cut across. The Vines seemed to suffer no check from their removal, but grew rapidly.

"When the Vines were about 3 feet high, and just a week before I meant to plant them in the borders, I had them cut round again, but this time the blocks of loam in which they were growing were from 9 inches to a foot square, and 6 inches deep, and one mass of fine active roots more like those of a Box or Privet bush than of a Vine; they were moved entire to where they were planted with the greatest facility, not a root being injured.

"The progress the Vines made after being planted in the borders was, in my experience, altogether unparalleled. The eyes were put in the soil on the 7th of February last, and I send you samples of the wood cut exactly to a day eleven months from the time the eyes were put in the soil. They were chiefly Muscats, Lady Downe's (black and white), Gros Colman, Alicante, and—strongest of all—the Golden Champion. You will note how little pith there is in the wood.

"About seven hundred of such Vines as I did not require for planting I had potted for either fruiting in pots or planting, and they have been equally successful; therefore I can recommend the system for either purpose. An examination of the border shows that the roots are

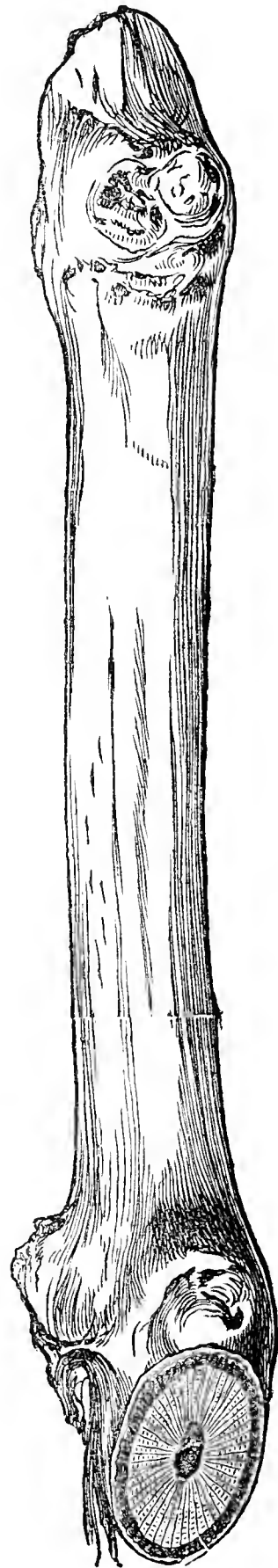

Fig. 17.

An examination of the border shows that the roots are

retaining the habit thus forced upon them, and are, so to speak, taking their work before them.—W. THOMSON, *Dalkeith Park*."

No better-ripened, shorter-jointed, smaller-pithed, finer young wood was ever produced on a Vine; and when it is remembered that no more than eleven months before the eyes producing that wood were planted, we believe that such success was then without a parallel, though it may have been equalled since. The drawing of a section from the Golden Champion cutting is exactly of the size sent to us.]



WE give the three following RECORDS OF RAINFALL in widely separated districts as illustrating the great difference in the annual totals registered.

— MR. R. INGLIS, The Gardens, Borde Hill, Sussex, writes— "THE TOTAL RAINFALL IN MID-SUSSEX for the past year was 33.42 inches. It may on the whole be termed rather a dripping season, there having been rain on 181 days, nearly one-half of the number. The heaviest fall for one month was October—6.86 inches—and the driest month was May, during which 1.34 inch fell. The greatest depth in twenty-four hours occurred on October 21st, when 1.24 inch was registered. The following is the fall in each month:—January, 1.62; February, 6.69; March, 1.34; April, 3.09; May, 1.34; June, 2.41; July, 3.86; August, 1.87; September, 2.44; October, 6.86; November, 4.18; December, 2.72—Total, 33.42 inches."

— MR. GEO. MACHRAY registered the following rainfall in 1882 at Kelly Gardens, Wemyss Bay, near Greenock:—January, 6.50; February, 5.50; March, 3.50; April, 3.70; May, 2.70; June, 5.10; July, 4.20; August, 4.20; September, 4.20; October, 4.00; November, 7.90; December, 6.80—Total, 58.30 inches.

— MR. G. SUMMERS, The Gardens, Sandbeck Park, sends the following record of the RAINFALL—"In 1882, 34.02 inches fell on 214 days; 1881, 27.30 inches on 171 days; 1880, 34.87 inches on 170 days; 1879, 28.61 inches on 209 days; 1878, 26.88 inches on 179 days; 1877, 31.50 inches on 163 days. From the above figures it will be seen that the rainfall of the past year was 6.72 inches more than 1881, a difference of 678 tons, or 151,574 gallons per acre. March was the driest month, 1.37 inch falling on 12 days; and October the wettest, 5.34 inches falling on 24 days."

— "F. H., *Oxon*," writes as follows respecting SUITABLE PLANTS FOR GROWING UNDER A ROOKERY:—"There is a very large rookery here, and I find nothing succeeds better under the trees where the rooks inhabit than the common English Ivy. We have a quantity of it here, with Box trees planted at intervals amongst it, which answers very well. But I would advise your correspondent, "J. D.," not to let nettles find root room with the Ivy, or they will very soon overgrow and kill it."

— MESSRS. BARR & SON, King Street, Covent Garden, send us specimens of CORBULARIA ALBA, a charming little Hoop Petticoat Narciss with neat white flowers. They state that, "In the summer of 1881 we had a quantity of the pseudo-bulbs from Algiers, and planted them in bottomless pans, where they have remained since, with the exception of moving the pans last summer with the view of having them under better control, and have given them a slight protection when necessary of glass, and from this time we shall be cutting them twice a week."

— WE are sorry to have to record the death of MR. ROBERT WRENCH of Messrs. Jacob Wrench & Son, seedsmen, of London

Bridge, which occurred at Gil'amount Surbiton on the 15th inst at the age of seventy. Mr. Wrench was the youngest son of Mr. Jacob Wrench, who founded the house, and originally practised as a solicitor, but on the death of his nephew, the son of his elder brother, Mr. Edward Wrench, he joined the firm. He was for upwards of forty years treasurer to the Gardeners' Royal Benevolent Institution, in the prosperity of which he always manifested the greatest interest. He was for some years a member of the Council of the Royal Horticultural Society, and was long on the Fruit Committee of that Society. He was for many years a member of the Board of Management of Dulwich College, and at the time of his death Master of the Drapers' Company.

— THE following prizes are offered by MESSRS. SUTTON AND SONS, Reading, for competition by amateurs and gentlemen's gardeners at the meetings of the Royal Horticultural Society during the present year:—March 29th, £3, £2, and £1 for nine seedling Cinerarias; May 22nd and 23rd, similar amounts for the same number of Calceolarias, also £2 2s., £1 1s., and 10s. 6d. for the best brace of Cucumbers, any variety. June 26th, prizes of similar value to the above named for nine Tuberosus Begonias, twelve Gloxinias, four dishes of Peas, and six varieties of Lettuce. July 3rd, four prizes ranging from £4 to £1 for a collection of ten distinct kinds of vegetables, no restriction as to sorts; also three prizes of £3, £2, and £1 for the best Melon; and on July 24th three prizes for Cabbages and six for Potatoes, varying from £4 to £1. No variety for which a special prize is offered in the Society's schedule may compete for these prizes. The same firm also provides prizes to the aggregate amount of £40, in twenty-one classes, at the International Potato Show to be held in September.

— THOSE who take an interest in the home cultivation of Oranges will find the ORANGE HOUSE AT THE SAWBRIDGEWORTH NURSERIES well worth a visit at this season. The trees are laden with a profusion of handsome brilliantly coloured fruit, and exhibit a luxuriance of growth which is rarely seen even in the Orange plantations of southern Europe, and the foliage is large and glossy, having no trace of scale or of the black fungus, which are the pests of the Orange tree. It may be worth mentioning that Mr. Rivers sponges the leaves and bark with castor oil, which is washed off with soft soap and warm water, and this is an effectual cure to the pests we have just mentioned.

— THE members of the SUTTON AMATEUR ROSE SOCIETY dined together at the Café Royal in Regent Street on the evening of Tuesday last; Sir Trevor Lawrence, Bart., President of the Society, in the chair. There was a large muster of the members and their friends, and if we may judge by the uniform geniality and enthusiastic tone that pervaded the gathering, there need be no doubt as to the usefulness and permanency of this young but prosperous Society. The proceedings of the evening were enlivened by the execution of some charming solo and part songs by the members under the direction of Mr. Home.

— CONCERNING the IMPORTATION OF POTATOES INTO AMERICA, it is stated that during the year 1882 nearly 9,000,000 bushels of Potatoes paid duty at the various ports of that country, their invoiced value being 4,500,000 dols., and the amount of duty paid 1,118,476 dols. A large portion of these were landed at New York, though Boston, Philadelphia, Baltimore, and New Orleans had their share. The Potatoes were sent from New Brunswick, Nova Scotia, the Bermudas, and some millions of bushels from Europe, mostly from Scotland and Ireland.

— WE learn from the ANNUAL REPORT OF THE ROYAL SOUTHAMPTON HORTICULTURAL SOCIETY for the past year that the Summer Show produced a balance of £87 9s. 11d. in favour of the Society, but the Autumn Show resulted in a loss of 4s. 7d.

which, though unsatisfactory, did not materially affect the general good results. The exhibitions to be held during the present year are the following:—The National Rose Society's Provincial Show, June 28th; Summer Show and Gala, August 4th and 6th; and the Chrysanthemum and Fruit Show, November 13th and 14th. The Society has entered into a provisional agreement to rent 10 acres of land in Westwood Park on a lease of fourteen years, it being proposed to maintain it as a place of recreation as well as a site for the exhibitions. Four hundred pounds are, however, required for preliminary expenses, and it is intended to raise this by issuing tickets available for the whole term of the lease, and transferable on payment of a small fee. It is hoped that all necessary arrangements will be completed in time for the Rose Show to be held in the Society's grounds.

— IN reference to the MILDNESS OF THE SEASON a correspondent writes:—"Observing a paragraph in the Journal the week before last that Primroses had been selling at a penny a bunch in London, as something worth notice at this season, I may state that when out shooting in a wood in Worcestershire last autumn during October, November, and December Primroses were abundant. I also noticed Foxgloves during the same months with Daisies and Buttercups in abundance in some fields. Primroses, no matter what the weather may be, usually make an unnatural growth in woods after a piece has been cleared of underwood for about two seasons, and also on hedgerow banks under the same condition of being cleared. I have had some on north banks where no sun reached all winter. It is a pity that people who could spare the time do not gather Primroses in the country and send to hospitals and other institutions, where they would no doubt be fully appreciated."

— A DAILY contemporary remarks that "the great naturalist, the LATE MR. DARWIN, seems to have had many admirers in Sweden. The subscription for the memorial to him has awakened so much interest in that country that the local committee there formed has received subscriptions from no fewer than 1400 persons, including 'all sorts of people,' writes Professor Loven in a letter to the English Committee, 'from the bishop to the seamstress'—the sums varying from £5 to 2*d.* The English Committee, which has its headquarters at the Royal Society, London, has now received (inclusive of subscriptions from abroad), £4000. The number of subscribers in the United Kingdom is only about six hundred."

— WE regret to have to announce the death of MR. WILLIAM WARD, gardener to the Lady Emily Foley of Stoke Edith Park, Herefordshire. Mr. Ward died quite suddenly at the comparatively early age of fifty-seven, and was able to continue his work until the day of his death. He began his profession by four years' residence in a nursery garden at Jersey, took his first place in the garden of the late Duke of Devonshire at Chiswick, and after staying several years there he became manager of the kitchen garden at Hampton Court Palace for Messrs. Jackson and Son. From thence he came to Stoke Edith some sixteen years ago. Mr. Ward was an excellent practical gardener in all branches of the work, and a very steady intelligent man. For the last few years of his life, in accordance with Lady Emily Foley's directions, he assisted the Woolhope Naturalist Field Club in the preparation of that very beautiful work "The Herefordshire Pomona," not only by supplying such typical specimens of fruits as might be required from the extensive gardens at Stoke Edith, but also by giving the results of his observations and experience in growing the several varieties. It was a real pleasure to him to afford practical information, and he spared no trouble to help the Committee in every way he could, always giving his opinions with equal freedom and modesty. Mr. Ward was a good type of an Englishman, a man of high principle, steady and persevering

in the performance of his duty, truthful, plain-spoken, and possessed of sound common sense—a man, in short, to be relied upon, and who gained, as he well deserved, the esteem and respect of all his employers through life.

— A CORRESPONDENT writes:—"Will the raisers of new plants never 'see the error of their ways' in giving such barbarously long names to their productions as at present prevails? The latest example of this practice that has come under my notice is PRIMULA SINENSIS FLORE-PLENO CRISPATA NANA, which is certainly long enough to do justice to a plant that is remarkable only for a slight crispness of foliage, and flowers smaller than the ordinary type of double Primula. A lady having desired to have the English name, it was given to her in this form—'the dwarf crisped-leaved double-flowered Chinese Primrose,' which was declared to be worse than the other, and the attempt to master the title was resigned in despair."

— IT was stated at the last meeting of the Scientific Committee, South Kensington, that the specimen of MAGNOLIA CAMPBELLI in the grounds of Wm. Crawford, Esq., Lakelands, near Cork, is at length about to flower, there being over thirty flower buds on it at present. "This," says the *Irish Farmer's Gazette*, "will be the first time of it promising flower in the British islands, and we trust the recent severe frost or other winter mishap may not interfere with the full development of its gorgeous flowers. We may venture to correct a mistake in the report of the scientific meeting in our London contemporaries, in which it is stated that the tree is growing in Mr. Crawford's garden, from which it might be inferred that it was trained to or required the protection of a wall. Such, however, is not the case. It is growing as a standard in a low-lying portion of the ground at a considerable distance from the garden, and quite near the foreshore of that portion of the estuary of the Lee known as the Douglas channel. With reference to the foregoing, and the anxiety expressed with regard to the flowering of M. Campbelli, it may be stated that the evergreen Magnolias appear, at least about Dublin, to have suffered from the effects of the December frost to an extent that we never remember to have seen before. In fact, in some places many growing to walls seem completely browned."

— THE report of the EPPING FOREST COMMITTEE of their proceedings under the Epping Forest Acts, from the date of their first appointment to the close of the year 1882, has been printed and circulated. The first Committee was appointed on the 3rd of October, and Mr. Bedford elected Chairman on the 11th. The first question taken into consideration was the extinction of the rights of fuel or wood within the manors of Waltham Holy Cross and Sewardstone, as they were utterly destructive to the appearance of the Forest. The total amount of compensation paid by the Conservators for the extinction of this right was £12,922, 13*s.*, in addition to which they have paid costs, making a grand total of about £15,000. The question as to the waste lands unlawfully enclosed from the Forest, which are in the Act called "pink lands," was next dealt with by the Arbitrator. The condition of quieting the title to those lands it was decided should be by way of rent-charge, and that such rent-charge should be of a uniform rate of 1*s.* a perch (equal to £8 per acre) per annum. The rights of lopping had also to be dealt with, and £7000 paid for the extinction of such rights claimed by the inhabitants of Loughton. The report speaks of the hearty appreciation of the Committee, and of the unwearying patience and careful attention which Sir Arthur Hobhouse, the Arbitrator, bestowed upon the many difficult and complicated questions which he had to decide. The arbitration lasted nearly four years. The total sums paid under the Arbitrator's orders for land and for costs was £77,505 15*s.* 2*d.*, the average cost being about £70 an acre. The entire

cost incurred under the arbitration was £109,505, 0s. 8d. The total sum expended in improvements since the formation of this Committee for roads, ponds, green rides, clearing and thinning, draining and planting, and also for levelling the surface by filling up gravel pits and destroying the artificial boundaries and fences set up by enclosers, has been £15,779. Referring to the withdrawal of the Great Eastern Railway Company's proposed extension to High Beech, the Committee express a strong opinion as to the necessity for this line to be made.

CHRYSANTHEMUMS AT KINGSTON.

IN your issue of January 11th, page 29, I find a communication from Mr. Douglas. I have tried to understand the felicity of his remarks, but quite fail. Surely the question is not debatable whether the Chrysanthemum of to-day is not infinitely superior to what it was twenty-five years ago. It is useless to try and find excuses for what our grandfathers did not do. However, my object in writing you is quite different from dissenting from Mr. Douglas's remarks on the advance of the Chrysanthemum.

I am astonished that Mr. Douglas can come forward and make a statement in reference to my exhibit, which is not only unfair but devoid of truth. My plants were sent "not for competition," not that I feared competition, as the more the better, but I find that showing has its drawbacks, and therefore I have now for some time exhibited only "not for competition." It appears, however, that to exhibit anything above the usual mark, whether in competition or not, calls down the same amount of jealousy. I shall not say a word more in reference to the spirit manifested by Mr. Douglas. Why, I am at a loss to understand; but I shall take especial care that no more Chrysanthemum exhibitions will find my plants included. I have informed Mr. Jackson that I wish my name removed as a Vice-President of the Kingston and Surbiton Society, and withdraw my subscription.—T. H. BRYANT, *Glencairn, Surbiton Hill.*

REVIEW OF BOOK.

Les Plantes Potagères: Description et Culture des Principaux Légumes des Climats Tempérés. Par VILMORIN, ANDRIEUX ET CIE. Paris.

THE ancient house of Vilmorin of Paris has conferred many benefits on horticulture and agriculture, and they have added another to the former by the publication of a bulky volume entitled "*Les Plantes Potagères.*" Some years ago Messrs. Vilmorin gave to the world another work of great usefulness entitled "*Fleurs de Pleine Terre,*" which has passed through several editions; and this which we have now under notice is one of a similar character devoted to the like treatment of garden vegetables. A work of more importance or more greatly needed we could not name, for the confusion that exists in the nomenclature of vegetables is undoubtedly great.

The responsibility of producing such a work could not have fallen into better hands than those of Messrs. Vilmorin, Andrieux and Cie., whose connection with every country on the face of the globe, coupled with the literary and scientific attainments which are known to exist in the establishment, give them an advantage in the preparation of it. It consists of upwards of six hundred pages of matter copiously illustrated with well-executed figures of nearly all the subjects treated of. As an example of the letterpress we give the following translation.

CABBAGE.

Brassica oleracea capitata, DC.

"SYNONYMES.—Chou capu, Ch. en tête, Chou pommé, Chou pommé à feuille lisse.

"FOREIGN NAMES.—ENGLISH.—Cabbage. GERMAN.—Kopfkohl, Kraut. FLEMISH.—Kabuiscool. DUTCH.—Slutkool. DANISH.—Hoved Kall. ITALIAN.—Cavolo cappuccio. SPANISH.—Col repollo. PORTUGUESE.—Couve repolho.

"The common Cabbage is divided into two classes—those with smooth leaves, and those with blistered or frizzled leaves, the former known by the name of Savoy. We conform to this division; and in each of the classes we shall describe the varieties as much as possible in the order of earliness, but also taking into account the affinities of the different races. The number of Cabbage seeds contained in a gramme (15.4 grains) is about 320.

CHOU D'YORK PETIT HATIF.

"FOREIGN NAMES.—ENGLISH.—Early Dwarf York Cabbage.

AMERICAN.—Early May Cabbage. GERMAN.—York'sches allerfrühestes weisses Kraut, Früher Zucker Maispitzkohl.

"We commence the description of Cabbage by this variety, because without being the earliest of all it is one of the best known and that which is generally cultivated as an early Cabbage. It will be more easy to estimate analogous varieties by comparing them with this. Head oval or in the form of a reversed cone, oblong, almost twice as high as wide, small, pretty firm. Leaves of a dark green colour, somewhat bluish, glaucous or greyish on the under side, the outer ones of those that form the head enveloping the others in the way of a hood; the loose outer leaves are not numerous, reversed, often crumpled in the course of the midrib, very smooth; ribs greenish white, pretty wide. Stalk slender, about the height of the head.

"The Superfine Early is a variety of the Early Dwarf York. It differs little from it in its exterior characters, and is principally distinguished by its smaller growth and being about eight days earlier."

There are thirty varieties of Cabbage treated in this manner, and nearly all of them figured, and there are many other sub-varieties which have more or less copious paragraphs devoted to them.

After the same manner all culinary plants, including Melons, Strawberries, and Tomatoes, the three latter of which the French always include among "*plantes potagères,*" are fully described and in many cases their uses are explained. What makes the work doubly valuable is the voluminous alphabetical index, and this is a characteristic which is not always to be found in French books. Every technical word is registered alphabetically, and there is no hindrance to ready reference. We commend this volume as a valuable acquisition to horticultural literature.

NEW AND CERTIFICATED PLANTS OF 1882.

MR. W. BULL, KING'S ROAD, CHELSEA.

THE valuable stores of new, rare, and choice plants in Mr. W. Bull's establishment at Chelsea have gained great fame in the horticultural world, and this is increasing yearly, for extensive additions are annually made of plants remarkable for the beauty of their foliage or flowers, or interesting for their economic uses. So greatly has the collection increased in recent years that the old quarters no longer afford sufficient accommodation for it, and the numerous ranges of useful houses in the other nursery, on the opposite side of the King's Road, are now fast becoming as closely packed with floral treasures as those in the original establishment. An important feature is the Orchids, which have attracted some hundreds of visitors during the past year; and the display promises to be even more magnificent in the course of the present season, judging by the admirable condition of the plants, and in the case of Cattleyas and similar genera by the number of sheaths showing. Even at Christmas, when Orchid flowers are usually comparatively scarce, the houses containing the *Odontoglossums* and cool *Oncidiums* were gay with flowers, and afforded most striking proof both of the utility and beauty of well-grown Orchids. In briefly reviewing the novelties of 1882 that were shown from this nursery, we may therefore appropriately give especial prominence to the

ORCHIDS.—With the exception of *Odontoglossum Alexandræ* perhaps no Orchid can rank higher amongst the most beautiful and useful species than *O. vexillarium*, the large delicate rose-tinted flowers of which are produced in such freedom under good cultivation. This varies considerably in the colour and size of the flowers, and several of the distinctly marked varieties have been named. The one, however, which Mr. Bull has designated *rubellum* is unquestionably the most remarkable in all respects, and it deserves notice here, though not strictly one of last year's novelties. One of its chief characters is the period at which it flowers—namely, in late summer and autumn, thus forming a succession to the ordinary type. Another distinguishing mark is the deep rose colour of the moderate-sized but well-formed even flowers; a difference will also be observed in the pseudo-bulbs and leaves, the former being shorter and more globular, while the latter are broader than the early-flowering forms. These qualities are quite sufficient to entitle it to the attention of Orchid growers, especially when its vigorous constitution is taken into consideration.

A trio of *Odontoglossums* were certificated at the Royal Botanic Society's Shows—viz., *O. Halli nigrum*, *O. Halli pictum*, and *O. Pescatorei album*, three charming additions to a beautiful genus. The first has already been referred to and figured in this Journal (page 107, last vol.), but it may be here observed that it most fully deserves its title, as the flowers are extremely dark, besides being of great size, with broad sepals and petals. *O. Halli pictum* has very dis-

tinct markings on the divisions of the flowers, while the last is a white *O. Pescatorei*, an exceedingly handsome variety, the flowers large, well formed, and the pure crystalline white is relieved by a small blotch of yellow on the lip. *Cypripedium insigne*, though not so brilliant as some of its relatives, has got a well-merited popularity for usefulness, which the variety *aureum*,

certificated last year, is likely to share. As the name implies, this is a "golden" coloured variety, not very strongly marked, but the tint is clear, and gives a very distinct appearance to the flower, especially when several are seen together in contrast with the darker-coloured forms, or with the beautiful variety *Maulei*. *Phalænopsis tetraspis*, which is also included amongst Orchid



Fig. 18.—*CROSSANDRA INFUNDIBULIFORMIS*.

novelties, is an East Indian species, bearing panicles of fragrant white flowers, individually small, but collectively having a pretty appearance.

FINE-FOLIAGE PLANTS.—Additions to these are very numerous, as this class of plants forms one of the special features of Mr. Bull's collections, and many beautiful novelties are annually sent

out from his nurseries. The most remarkable are briefly noted as follows. *Aemena ovata*, an evergreen ally of the *Eugenias*, with ovate purple leaves and petioles, the colour being particularly developed in the young growths. It succeeds in a greenhouse temperature, and will probably become a favourite decorative plant. *Cleyera japonica tricolor* is another useful plant for a

greenhouse or conservatory, the leaves being dark green, banded with a lighter shade, margined white and tinged with pink. Of Palms, *Arenga Wightii*, a dwarf pinnate-leaved species of graceful habit, and *Calyptrogyne teres* with arching leaves, which in a young state have two pairs of narrow leaflets, are the best, the latter especially being likely to prove one of the most useful. Half a dozen new *Crotons*—namely, *illustris*, *insignis*, *linearis*, *rubescens*, *spectabilis*, and *tricolor*, are notable for the richness of their colours, and should be in every collection. *Dicffenbachias majestica* and *princeps* are two other handsome variegated plants, the former being especially bold in habit. *Dioscorea speciosa* is a fine climber for the stove, with heart-shaped dark-green leaves banded with white. *Heliconia metallica*, an ally of the *Musas*, with shining bronzy leaves, and the *Monstera*-like *Epipremnum mirabile*, the "Tonga Plant," which is credited with such valuable anti-neuralgic properties, are all extremely ornamental plants.

Of miscellaneous novelties, that represented in the woodcut (fig. 18)—namely, *Crossandra infundibuliformis*, is perhaps the most striking. It is one of the large *Acanthus* family, a native of the East Indies, and produces its dense spikes of rich orange-coloured flowers very freely. It succeeds in a stove, and would doubtless also do well in an intermediate house. Many other fine plants have been shown by Mr. W. Bull during the past season, and his new plant houses contain abundant stores for future distribution.

ST. JOHN'S WORTS.

(Continued from page 12.)

IN three or four catalogues of hardy herbaceous and alpine plants I find at least twenty kinds of *Hypericum* included under these designations. Three or four of these—as, for instance, the natives *H. montanum* and *H. alodes*—can hardly be considered worth cultivating; others, as I said in my former notes, are just on the line which separate hardy from half-hardy plants, and unless a stock is kept in shelter they are likely to be lost in hard winters. Others again, though hardy, are short-lived shrubs, and require renewal from cuttings. The result is that until recently it has not been very common to see any St. John's Wort in gardens except the old-fashioned *H. calycinum*. This, as I said, is a dwarf running shrub, and it is not easy to define the line between shrubby plants suited for the mixed herbaceous border and those more properly placed in the shrubbery. But here I may mention a St. John's Wort which grows rather too large for the mixed border, though it is decidedly an ornamental shrub growing into a dense bush 4 or 5 feet high, and producing in July and August bunches of five or six or more yellow flowers, followed by dark red or black very ornamental berries. I think it is intermediate between *H. androsæmum* and *H. elatum*; it reproduces itself by self-sown seed, and the seedlings vary considerably both in the form of the seed pods and in the height of the bush. This is perfectly hardy. In fact one of the parents, if my conjecture is right, is a wild plant in the south of England, but it does better where the soil is dug than in wild places.

Another of the shrubby *Hypericums*, pretty in flower and elegant in growth, hardy in catalogues, but not in the cold reality of exposed gardens, is *H. balearicum*. This, therefore, must be treated as the *H. patulum* class. One or two natives may be tried, especially *H. pulchrum*, the slender St. John's Wort, of which the bright red buds and clear yellow flowers make it a very pretty object where it can be kept to a dwarf bushy habit; and in dry warm soils I have seen it become a very pretty garden plant.

The only other native I have tried is *H. humifusum*. The flowers of this are small and inconspicuous, but the compact close-growing mass of neat bright green leaves make it worth the little room it takes on the rockery, where few plants are better behaved. It comes up year after year of the same size, and never takes more ground than is intended for it.

Resembling the last in foliage but not in flower, having beautifully shaped flowers as large as a florin, is the alpine *H. reptans*, the best of all the genus for a close-growing rock plant; but, I fear, like several others, of doubtful hardiness. Still, it ought to be grown on all alpine rockeries as one of their choicest gems. I have had it two or three times, and severe winters or neglect have caused it to disappear; but in October, 1881, a friend in Surrey gave me a piece about the size of my hand. It was not rooted, as the roots will not divide, but out of its numerous shoots I made about fifty small cuttings, every one of which soon struck. Many of them were planted on the rockeries in May, in such positions as to hang over the edge of stones. They flowered through September and October, and no plants I had were more admired both by their owner and by visitors. Some of the plants were a foot square, but of this expanse hardly any of the shoots

overlapped one another, but the growth spreads like a finely divided leaf of Maidenhair Fern clinging close to the stone over which it grows. A pan of cuttings are struck to repeat the same treatment next year, and I may add that they will be moved straight from the pan in which they are struck—an ordinary seed-pan a foot square, to their flowering place.

Of all the St. John's Worts I have tried or seen none comes nearer to the character of a true herbaceous plant than *H. Burseri*. It divides itself into several heads, each having a separate root, preserving, however, a compact habit, and disappearing from the surface in winter. In height and in the size of its flowers it resembles *H. olympicum*, but the yellow of the flower is not so bright nor does it flower so freely, but it is well worth growing, and I think easily kept, though I have hitherto given it select places. Another nearly herbaceous kind, but without much merit as an ornamental plant, is sold, and I believe rightly, by the name of *H. orientale*. Its flowers are not larger than those of the common wild St. John's Wort, *H. perforatum*, which it somewhat resembles, though quite distinct. The foliage is glaucous, like that of the common Spurge, and the plant requires no attention. Few would much regret losing it.

A neat variety for the rockery is *H. nummularium*, a plant which takes its name from the wild Moneywort or Creeping Jenny (*Lysimachia nummularia*), which it somewhat resembles in its growth and the shape of its leaf and the size of its flower. It is, however, less prostrate in habit, and the shoots are much shorter. It increases by running underground and sending up shoots at intervals, much in the same way as *H. calycinum*, but is much shier in growth.

It remains to speak of three neat and pretty dwarf shrubs, admirable rock plants, but, unfortunately, not more hardy than most of the shrubs of this genus which have been already mentioned. The first is *H. empetrifolium*, which forms a nice little bush about 9 inches high, and is covered all through summer with small yellow flowers. In habit it is like that neat evergreen, the native Crowberry (*Empetrum nigrum*), from which it takes its name. Then we have *H. coris*, not unlike the last in leaf and flower. The specific name is taken from *Dioscorides*, the vowel of the first syllable being short in Greek. The root of the word, *kor*, suggests sweeping, and would probably have been applied to some plant like Heather, suitable for making brooms, for which our present subject, as we are able to grow it here, would be too small; but what plant was originally called by the name must remain uncertain.

The last and smallest of all the St. John's Worts is *H. ægyptiacum*; this, too, included amongst hardy plants in catalogues, but not hardy in ordinary gardens. It is so small that a specimen may be planted out on a rockery from April to October for two or three years, and still continue contented to be planted in a thumb pot to pass the winter in a cold frame. These three strike easily from small soft cuttings at any time. This completes the list of those I have proved, but I have three or four more now under probation, and there are probably many more which have not yet found their way into gardens. It may be thought from what I have said that this is a troublesome class, but it is not more so than many half-hardy plants which are grown in most gardens from year to year, and makes a pleasing variety amongst them.—C. WOLLEY DOD.

CULTURE OF THE CHRYSANTHEMUM.

"AN Exhibitor and Grower" in his remarks on this subject (page 22), says he pays little attention to ripening the wood, also that the best and largest flowers are produced on rather soft wood. Upon this question I should like to make a few remarks, as I think it requires further explanation. I have many times read of the ripening system, but if there is such a system have never seen it explained, neither have I seen it practised further than this. If the bud be taken at the end of August, all being pinched off, the plants standing in an open airy position until early in October, the wood must naturally become ripened. Take two plants, the buds of which are taken the same day, place one in an open the other in a shady position, and I have no hesitation in saying the first one will produce finer flowers, retain its foliage better, and the wood be much firmer than the other. Therefore I am at a loss to know what is meant by ripening. If there is a system I should very much like to see it explained. On the other hand, if your correspondent knows of any system or treatment by which fine flowers may be produced from buds that are not taken until October, the wood of which is rather soft, I know of several growers, myself included, who would be glad of the information. For several seasons I have seen the collections that have taken many prizes at the principal exhibitions, but have never seen any

further ripening practised than what I have attempted to explain.
—J. LYNE, *Belvedere, Wimbledon.*

AN HOUR AT READING.

It is scarcely necessary to say that the central feature of the capital of Berkshire is to horticulturists the great establishment of Messrs. Sutton & Sons, but it is not this remarkable building and its marvellous completeness that is to be described now, but only a less imposing but very valuable adjunct—the trial grounds of the firm. These are situated about a mile from the market place, and it is within a walled enclosure that trials of bulbs, annuals, and various kinds of popular flowering plants are conducted yearly with the object of testing their merits, and wherever it is possible raising new and improved varieties. There is necessarily little of interest outside at this period of the year, but in spring and early summer the bulb ground and plantation of hardy Stocks, of which there is a great variety, will be worthy of inspection. At present the houses are the great points of attraction, and especially those containing Primulas and Cyclamens.

It may be useful to notice the character of the structures. They are neither lofty nor architecturally ornate, but plain, serviceable, and admirably adapted for the purpose for which they were constructed. With such houses as these plant culture is easy, and at a comparatively small outlay similar examples might be erected with advantage in gardens large and small over the length and breadth of the land.

They are plain low-span roofs with brick sides, rather flat roofs, the angles not exceeding 30°, and high side stages, so that such plants as Primulas and Cyclamens now, and Cinerarias, Begonias, and Gloxinias later in the season, are brought near the glass, and are thus kept sturdy and in better condition than it is possible to produce them in many far more costly erections with which gardeners are often troubled and owners disappointed.

With means such as is here afforded and the skilled culture which is so abundantly manifest, results are produced of which it is impossible to speak too highly, and the gentle hint that “neither strained praise nor making the best of what is provided is agreeable,” savoured of a tinge of humour almost approaching irony, for it is a simple fact that the Primulas and the Cyclamens were magnificent a week or two ago, and they are doubtless splendid still, alike in variety, diversity, and culture.

Sturdiness with vigour, quality of bloom with substance, purity and brightness of colours, are the prominent characteristics of the plants and flowers. Cross-fertilisation is reduced to a system, every individual cross having been registered for years and its effects chronicled, so that the question of raising new forms is in a very great measure removed from the category of guesswork, and the results can be and are in a very great measure anticipated; and the fact, for fact it no doubt is, appears to be fully recognised that high culture is not only essential for portraying the full beauty of the flowers, but is equally so in the production of seed of strong germinating power. It is believed that just as a weak cutting is typical of the future plant, so it is with seed: hence the practice is adopted of growing the plants so well.

To describe all the varieties of Primulas were impossible, for there are at the least fifty quite dissimilar, but only a few of these are kept separate. One side of a house filled with Ruby King, and the opposite stage with Pearl, showed to advantage the glowing richness of the one and the spotless purity of the other. The first named must have high culture, as a check of any kind, and especially to the roots, predisposes to a “dumpy” habit; but grown as it can be grown, and is grown “at home,” massive pyramids of flowers are produced. Too early sowing, starving in small pots, and high potting, are mistakes to be avoided. If once the collar of the plants gets hard above the soil the sap vessels are inevitably contracted, and a vigorous growth is hopeless. Sow in April or early May, grow without a moment's check throughout, and Ruby King will prove itself worthy of the certificate that it won so well. Its companion, the Pearl, is of free growth, and there is no difficulty whatever in having it in fine condition. It has the great merit of expanding its flowers in the centre of the truss (not producing them in whorls, with flowers outside and buds in the centre), which is no small advantage for market and decorative purposes.

Another white demands special notice, although it is perhaps not yet in commerce. It is named Snowdrift, and a more appropriate name could not be suggested. It is so pure that the flowers actually retain their purity when the petals shrivel. They may be likened to stout note paper when fresh, to tissue when faded. But if Pearl is so pure why is Snowdrift needed? The plants afford a very good answer. The latter variety flowers quite a month sooner than the former, the plants of this averaging at the

least a hundred flowers when the others have not more than half a dozen expanded, thus a natural succession is afforded; and besides, the early or autumn form is Fern-leaved, and the other is not, and they are therefore distinct in character as well as in the time of flowering.

Another Fern-leaved variety, very distinct and charming as seen *en masse* and so well grown, is Suttons' Rosy Queen. It has very short leaves, and the rosy salmon flowers show to great advantage. Like the Ruby King it evidently needs good culture to bring out its full beauty. Of the same type is Reading Pink, a remarkably fine variety that succeeds the other, deeper in colour, and a favourite with all who see it. A cross between Chiswick Red and Ruby Queen has produced, as might be expected, a very richly coloured variety; but is yet scarce, and will be seen to better advantage another year. So will the new blue Primula, which is not yet named. It is quite distinct, and wherever the colour is as developed as in a houseful of young plants here, Suttons' Blue will make its mark. It is curious, almost extraordinary, as was intimated by Mr. Henslow—as he was reported in his last lecture at the Royal Horticultural Society's meeting—that when a distinct break is made in a genus that several examples are likely to occur in the same season. The parent plant was raised by a gardener from a packet of Suttons' hybrids, which are sold in mixture, and was sent to the firm; and it is again singular to observe that the seedlings resultant from this plant produced about a dozen plants with pure white flowers, the rest—about a hundred or so—being what may be fairly termed blue, the margins of some of the segments having a wire of violet. It appears to seed as freely as the others, and is treasured as “something good.”

Another house contains plants from all the strains, so far as could be obtained, in existence, but these cannot be noticed. The task at the best would be invidious, and the space it would occupy not profitably utilised. Then there are double Primulas, or in effect double, but when closely examined the organs of fructification are existent, as in Carnations. These doubles are highly effective, and it is a matter of surprise that more space is not accorded them in the new catalogue of the firm. They certainly merit it, one of them, Prince Arthur, being especially fine.

Yet another house is devoted to Primulas—the curiosity house. There are extraordinary forms here, but their characters are not yet fully developed—crested varieties, like tufts of Saxifragas, yellow-flowered varieties, velvety maroons of the hardy Polyanthus colour, striped and margined and spotted sorts, and plants with foliage and leafstalks so strong that, as an observer remarked “a cat might jump on them and do no injury.” It will be interesting to watch the results of the experiments that will be the outcome of this novel collection.

Leaving this maze of Primulas, just a word must be devoted to the Cyclamens. These fill two or three houses, producing a sheet of flowers, which, however effective they are as viewed collectively in separate blocks of colour, each plant will bear the closest examination, for every one is good. It is indeed seldom that Cyclamens are seen so healthy, floriferous, and fine. The masses of flowers rising like a bouquet a few inches above the foliage need nothing to support them, so sturdy are their stems. A night temperature of about 50° is afforded them now, and in this the flowers expand freely and maintain their freshness for a long time. In the named varieties grown in quantity all colours are represented—at least, all Cyclamen colours, from swan-like white, blush, the various tints of rose, deepening to pink, purple, and glowing crimson, the varieties of the giganteum type being of great size, but the blooms not quite so freely produced as the others. The plants now so fine were raised from seed sown just over a year ago, and thousands of others are now coming through the soil for producing a similar display next winter and spring. A steady unchecked growth induced by a cool stove temperature, with moisture to keep them moving and air and light to keep them vigorous, are the essentials of culture; but it must be observed that such plants can seldom be produced in mixed houses. To have Cyclamens in the finest possible condition separate structures are desirable, and if not indispensable, are decidedly advantageous.

Eventually the houses now so gay will be not less effectively furnished. The Cineraria season is at hand, and plants are as well grown as is possible for making it a gay one. Then follow the Calceolarias, which will be gorgeous in May, the plants having for some time been in the 8 and 9-inch pots in which they will flower. They are grown in low span-roofed frames from which frost is excluded, but means are adopted for preventing dry heated air from the pipes coming in contact with the plants, which are grown on a flooring of ashes kept moist. Insects are not destroyed, for the simple reason that light fumigations periodically afforded

prevent an aphid ever appearing. All who covet a grand display of these beautiful flowers can only have it by pursuing the system of culture briefly indicated. Seed for producing huge specimens should be sown early in July.

After the spring and early summer flowers above alluded to are over come Tuberosus Begonias and Gloxinias. These when in beauty produce a splendid effect under the high culture to which they are subjected. At present the corms are resting, and it may perhaps be useful to some readers to be informed of the method of storing that answers so well. They are assorted according to size and merit of the varieties, the bulk of which are not named, and placed in large flower pots in a mixture of dry sifted peat and pine sawdust, the latter being used to throw mice "off the scent," the turpentine of the sawdust not suggesting to them the choice morsels below. Thus the corms are quite safe, and keep perfectly sound and fresh.

By growing the different plants indicated there is no difficulty

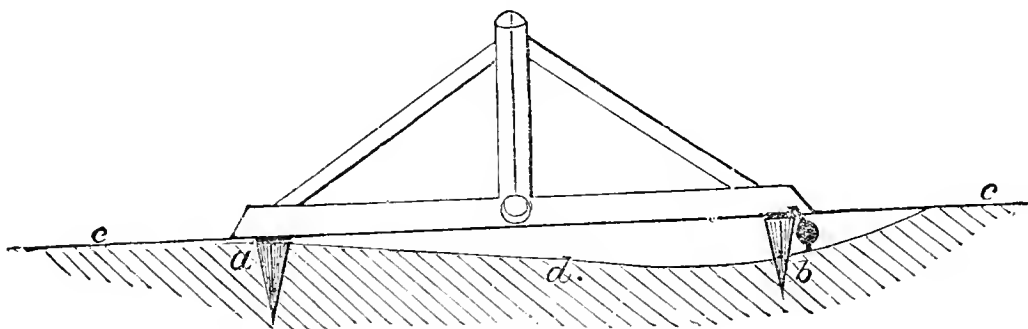

Fig. 19.

in having the thirteen or fourteen houses gay throughout the year, and this more easily and satisfactorily than could be done by growing mixed collections of plants. "Attempt nothing that cannot be done well" appears to be the governing principle, and that everything is done well at Reading will be apparent even to the hypercritical observer, if he will honestly determine to point out the faults; he will not find many, unless he is more acute than—A VISITOR.

LEVELLING GROUND.

I HAVE a piece of unlevel ground on which I am requested to make a tennis lawn of considerable size. Unfortunately, like many other young men, I have had no opportunities of assisting in work of this nature, and I am unwilling to admit my ignorance to the men, some of whom no doubt would be able to do the work. But I wish to understand it myself before commencing, and if you can give me a few very plain instructions you may possibly be doing a service to some others who, from no fault of their own, are as unprepared as myself in a matter of this kind, and may not like to bring the fact to your notice. I shall be glad if you can in any way help—ONE IN A FIX.

[We willingly assist in this case and do not know that we can do so more usefully than by publishing the very plain instructions that were communicated by Mr M. O'Donnell some years ago as follows:—

"If the ground presents an uneven surface, or is formed of a sloping bank, either inconveniently steep or presenting an irregular surface, it will be necessary to level it, which may be done in the following manner:—Take a stout peg and drive it into the ground, as *a*, fig. 19; take a level—either such as is used by bricklayers, as in fig. 19, or a parallel straight-edge containing a spirit tube, commonly known as a spirit level—drive in as many pegs as are required, as *b*, to the same level as the first peg *a*. The level line *c, c*, is the line required; the ground line, *d*, is the uneven surface of the ground, which requires filling up to the level at peg *b*. As soon as the pegs are in, level the ground with a spade, keeping the earth full up to the top of the pegs, tread it firmly all over, rake it carefully, and roll it well.

"If the ground chosen should be sloping, as *b*, fig. 20, two depths must be determined upon, one at the highest and one at the lowest point. Place a borning-rod at each of these points, as at points 1 and 3, place another in any point between the two, as the intermediate borning-rod 2. By looking over the top of rod 1 the person holding the intermediate rod can be directed to lower or raise it as occasion may require, until it is brought to the

proper level, as rod 2. Rod 1 is supposed to be a little raised by placing some earth under it for the purpose of getting it to the proper level, *a, a*—that is, the level determined upon. Rod 2 is elevated until the top edge forms a direct line with rods 1 and 3. Rod 3 is placed on the natural ground. The cross piece of rod 3 should be 1 inch broader and higher than the others—that is to say, if rods 1 and 2 are 4 feet high, rod 3 must be 4 feet 1 inch but a line must be drawn exactly at 4 feet, and the top inch painted black. On looking over rod 1 the black line on rod 3 can be seen more distinctly than the top edge of the rod would be, and intermediate rod 2 can be placed more correctly in a line with the top of rod 3—that is, the under edge of the black, than by looking over the tops of the three rods.

"The borning-rod is composed of a thin piece of board about 4 inches wide, half an inch thick, and about 4 feet in length. The head is a similar piece of board placed crossways, but only about 18 inches in length. The upper and under edge of the board must be perfectly straight and at right angles with the body."]

THE METEOROLOGICAL SOCIETY.

THE annual general meeting of this Society was held on Wednesday the 17th instant, at the Institution of Civil Engineers, Mr. J. K. Laughton, M.A., F.R.A.S., President, in the chair. The Secretary read the report of the Council, which showed that the total number of Fellows was 571, forty-seven new Fellows having been elected during the year.

The President then delivered his address. He referred briefly to the great importance of the uniform series of observations now taken under the auspices of the Society, and proceeded to speak at greater length of certain other points in which the Society might, by its concerted action, further the interests of meteorological science. The first of these was anemometry, which is at present in a condition far from satisfactory. We know nothing positively either as to the pressure or the velocity of the wind: there is no exact standard instrument, and observations, whatever may be their absolute value, are not comparable one with the other. He thought that the Society might properly interfere, so far as to regulate the wide diversity amongst the instruments now used, in order that when the proper time came, and it was known what anemometer could be trusted, the older observations might be reduced. The movement of air in the upper regions of the atmosphere is not measurable by any existing method; but experiments have been made, at the suggestion of the Meteorological Council, in which the drift of the smoke-cloud of a bursting shell may be observed and measured. The observations of the barometer taken at elevated stations in the United States seem to throw considerable doubt on the received formulæ for the reduction of barometric readings to sea level, and for the calculation of heights. When the observations extend over a long period, and are regularly taken under all conditions of weather, then no doubt the height of a mountain can be calculated with a fair approach to accuracy; but

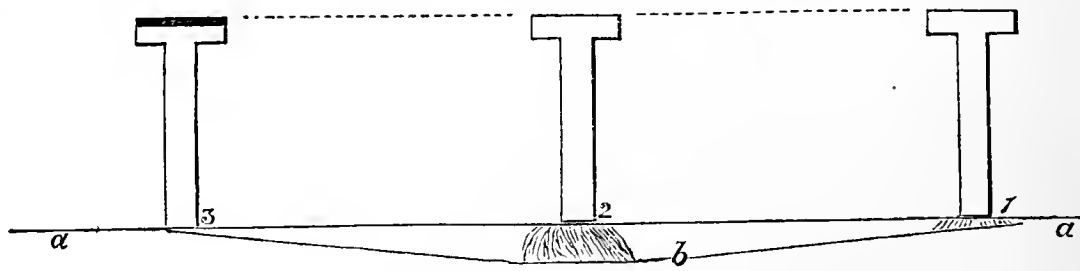

Fig. 20.

isolated observations, subject to the fluctuations of the different readings, are extremely wild in their results. In the same way the reduction of the barometer to sea level is complicated by many discrepancies which arise between observations at the upper and lower stations, which have hitherto been ignored. It is impossible to say how far they affect the isobars on which our daily weather charts are based; but it is at least probable that they are at least one additional source of error and of difficulty. It is much to be wished that systematic and continuous observations at high-level stations could be taken, not only on the top of Ben Nevis, but on the tops of some others of the highest peaks in different parts of the country. In this way alone can these difficulties of reduction be cleared away.

The following gentlemen were elected the Officers and Council for the ensuing year:—President—John Knox Laughton, M.A., F.R.A.S., F.R.G.S. Vice-Presidents—Edmund Douglas Archibald, M.A.; Rogers Field, B.A., M.Inst.C.E.; Baldwin Latham, M.Inst.C.E., F.G.S.; William Marcet, M.D., F.R.S., F.C.S. Treasurer—Henry Perigal, F.R.A.S. Trustees—Hon. Francis Albert Rollo Russell, M.A.;

Stephen William Silver, F.R.G.S. Secretaries—George James Symons, F.R.S.; John William Tripe, M.D., F.R.C.P.Ed. Foreign Secretary—Robert Henry Scott, M.A., F.R.S., F.G.S. Council—Hon. Ralph Abercromby, William Morris Beaufort, F.R.A.S., F.R.G.S.; John Sanford Dyason, F.R.G.S.; Henry Storcks Eaton, M.A.; William Ellis, F.R.A.S.; Joseph Henry Gilbert, Ph.D., F.R.S., F.C.S.; Charles Harding, Robert John Lecky, F.R.A.S.; Capt. John Pearse Maclear, R.N.; Edward Mawley, F.R.H.S.; George Mathews Whipple, B.Sc., F.R.A.S.; Charles Theodore Williams, M.A., M.D., F.R.C.P.

ORCHIDS AT FERNSIDE, BICKLEY PARK, KENT.

CLEANLINESS is here considered of the greatest importance in Orchid-growing. At this time of year the houses are thoroughly washed, so as to admit all the light possible, and the walls are whitewashed. We employ pure water, and consider it best for cleaning the plants. They are occasionally fumigated with tobacco, and if this is done with care it will not injure them. If scale becomes troublesome we use a little Bridgeford's antiseptic liquid, which will soon clear off all scale or any other insects.

The following Orchids are now in flower :—

EAST INDIAN HOUSE.

- | | |
|------------------------|--------------------------|
| Bollea cœlestis | Dendrobium Wardianum |
| Calanthe Veitchii | crassinode |
| nivalis | c. Barberianum |
| vestita lutea oculata | Cymbidium Mastersi |
| vestita rubra oculata | Odontoglossum Roezli |
| Cypripedium pardinum | R. album |
| Harrisianum | Pescatorea Klabochiana |
| Warneri | Lehmanni |
| Dendrobium Ainsworthii | Phalaenopsis grandiflora |
| Cambridgeanum | Spathoglottis Lobbi |
| Findleyanum | Vanda Cathcarti |
| heterocarpum | |

CATTLEYA HOUSE.

- | | |
|---------------------|----------------------------------|
| Cattleya exoniensis | Lælia anceps |
| Ceologyne barbata | a. Barkriana |
| corymbosa | Odontoglossum Londesboroughianum |
| cristata | vexillarium roseum |
| Comparettia rosea | Oncidium cheiroporum |
| Deudrobium Farmcri | Pilumna nobile |
| nobile | Warria cyanca |

COOL HOUSE.

- | | |
|------------------------------|-------------------------|
| Barkeria elegans | Lælia albida |
| cyclotella | Odontoglossum Alexandræ |
| Lindleyana | costrictum |
| Skinneri | Pescatorei |
| Cypripedium insigne, several | Uro-Skinneri |
| i. Maulei | Rossi majus |
| Boxalli | bictonensis |
| Masdevallia amabilis | Oncidium serratum |
| tovarensis, several | superbiens |
| Mesospinidium sanguineum | Houlletia guttata |
| vulcanicum | Sophonitis grandiflora |
| Lælia autumnalis atrorubens | g. violacea |
| autumnalis | purpurca |
| albida rosca | |

—EDWARD WILSON.



[By the most skilful Cultivators in the several Departments.]

HARDY FRUIT GARDEN.

Pruning.—Old trees with huge spurs, apparently barren, are a source of trouble and anxiety to inexperienced fruit-growers. In every case our advice is to do nothing rashly; many precious years are required for the full development of spurs, and not one of them should be removed lightly. It is true enough that the tissue of such old spurs is so much contracted and hardened that sap-action is somewhat sluggish; but that, instead of being an evil is often advantageous in its well-known tendency to induce the formation of fruit buds. Carefully examine them, thin crowded growths, then turn to the roots; sever any of them that have gone down into the subsoil, replace exhausted soil either with rich loam from the surface of a meadow or with soil that will grow good vegetables, and the old trees will probably soon surpass younger ones in quantity if not quality of fruit. Old Plum trees so treated yield abundant crops of excellent fruit. We may also

mention two very old espalier Apples with only the top branches remaining with spurs fully a yard long, which are kept as curious relics of bygone days, that in every favourable season are laden with fruit that is really useful.

In thinning crowded spurs upon young trees, if possible prune to a fruit bud rather than cut close to the base of the interloper if the condition of the tree renders it desirable; but if crowded spurs are thick set with fruit buds, then the entire removal of some of them is necessary, or the fruit will be crowded and small. And remember that it is better to thin the wood than the fruit, for then light and air freely circulates among the foliage, the tree is more easily kept in a healthy condition, and the due proportion of blossom, fruit, and foliage is maintained.

Planting.—This has been much retarded by wet weather, and must now be finished as soon as possible. Never plant a tree that is weakly or having the slightest trace of disease. Shorten any long bare roots, remove all bruised portions with a clean cut, and prune the branches before planting. The greatest possible care must be given to every detail of planting, no matter whether it is in an old or new garden.

There is often much slovenly practice in filling vacancies in old orchards; the soil being disturbed as little as possible, the roots crowded into a small hole, the soil thrown in and trampled hastily upon them, and very little more done. Even if the soil is good it should be broken up for at least a yard around the site of the tree, the roots spread carefully out in it, covered and mulched just as though it were a new orchard, and if it is in grass tree-guards at once put to keep off cattle. A free robust growth the first season always rewards such judicious care, just as a feeble sluggish growth betokens the want of it.

Training Filberts.—No trees require more careful training than Filberts and Nuts, yet how seldom do they have it! We have some trees now in full bearing that were planted twelve years ago. They are 30 feet in circumference, yet the tops of the branches are only 4 feet from the ground. Each tree has four or five main branches, spreading outwards in the form of a shallow basin: this form was imparted to them during the first four years by fastening them downwards and outwards to pegs driven in the soil 2 to 3 feet from the stem.

Pyramidal Fruit Trees.—These also require great care at first while the branches are young and pliant. Pruning to an outer bud must be supplemented by training, drawing each tier of branches outwards from the stem as may be necessary; erect compact-growing sorts requiring more care than others of spreading habit. Tarred string of the soft twisted sort answers best for this purpose; it lasts a year, and the annual renewal prevents that harm to the fast-swelling growth which is so common when wire is used.

Shelter.—This is of much importance in hardy fruit culture. If possible choose a warm southern slope for your trees, or a nook from which wind from the north and east is practically excluded. Failing such natural advantages do all you can by planting a thick belt of fast-growing trees on the cold sides, in order to save the blossom from the fatal effects of cold winds.

FRUIT-FORCING.

Vines.—Proceed with tying and stopping young growths until there is sufficient formed to give an even spread of foliage over every part of the trellis. Select the most compact bunches for the crop, fertilising all shy-setting kinds with pollen from Hamburgs as soon as they come into flower. Thin Hamburgs and other free-stoning kinds as soon as the berries commence swelling after setting. If the inside borders in early houses have not been watered since they were started they should have a good supply at a temperature of 80° to 85° as soon as the thinning has been brought to a close. In the fermenting material, if any have been employed on outside borders, a temperature of 80° must be maintained by frequent turnings and additions of fresh material. That employed inside the house may be continued during the swelling of the Grapes, but care must be taken to employ well-sweetened materials only, or it is likely the ammonia vapour will injuriously affect the foliage.

Syringe succession houses two or three times a day, and turn the fermenting materials frequently for the purpose of liberating moisture and ammonia. Disbud as soon as the best bunches are distinguishable, and discontinue the syringing when they become prominent, but keep up atmospheric moisture by damping the path and walls until flowering commences, when a circulation of dry air with a little more heat will facilitate the setting.

Fruiting Vines in pots must be well attended to, thinning early, and being careful not to overcrop, supplying them with liquid manure a few degrees warmer than the house, and add a little fresh top-dressing as the roots appear on the surface.

Cut-back Vines intended to be grown into fruiters for next season may be placed in heat, and when they have made 2 or 3 inches of growth shake out and repot them in rough rich compost, using pots 6 to 9 inches in diameter, and training the growths near the glass. Examine the bunches in the Grape room, and dispense with fire heat there as far as possible, yet prevent an accumulation of damp.

Melons.—If seed was sown as previously advised the plants will have made one or two rough leaves, and should be potted at once into 6-inch pots, be again plunged in a bottom heat of 75° to 80°, and kept near the glass, placing a small stick to each. Those intended for planting in hot-water pits or dung-heated frames need not be potted, but being stopped at the second rough leaf can be planted as soon as the soil has become of the same temperature as the pits or frames. The best soil for Melons is a turfy loam inclined to be tenacious rather than sandy, which has been cut and stacked during the previous summer. This chopped up will be sufficiently rich without any manure; but if poor soil is used one-fourth of well-decomposed manure may be incorporated. Make a hillock in the centre of each light by placing in a barrowful of soil, and leave a space of 10 to 12 inches from the glass. Insert a plant in each hillock, or two if the light be large, making the soil rather firm about the roots. See that it is moderately moist before planting, and ascertain that the bottom heat does not exceed 90°. A ring of dry soot and quicklime around each plant will keep snails at bay. Sow seed for successional crops, and get more fermenting materials ready for making additional hotbeds and for linings.

Cucumbers.—With more light the growth will be increased, necessitating more copious and frequent applications of liquid manure in a tepid and diluted state. The night temperature may still be continued at 65°; 2° or 3° higher in mild or less in severe weather, ventilating from 75°, and increasing with sun to 85° or 90°, maintaining the bottom heat between 80° and 90°. Close the house early in the afternoon, and damp the pathways and plants when the weather is favourable for so doing at closing time. Remove at once any superfluous or deformed fruit, decayed wood, or leaves as they appear. If green or black aphid become troublesome fumigate on two or three consecutive evenings moderately, applying flowers of sulphur against mildew, or paint the hot-water pipes thinly with the same brought to a thin wash with skim milk. Transfer young plants into larger pots as they require it, keeping them near the glass till ready to plant out near the trellis, placing a stick to each; but those for planting in pits or frames for training over the surface of the soil should be stopped at the second rough leaf. The hillocks can be formed as advised for Melons. Cucumbers thrive well in a compost of three parts rather light loam, and one in equal proportions of old hotbed manure and road scrapings, with a sprinkling of charcoal.

PLANT HOUSES.

Stove.—*Rhynchospermum jasminoides* is a valuable plant for supplying abundance of fragrant white Jasmine-like flowers from the present time to the month of June if properly prepared for the purpose and forced into flower. Although this is a greenhouse plant which will bear a very low temperature while at rest, it will make much greater progress if subject to stove treatment during its season of growth. When grown in heat its shoots are much longer and soon cover a fair-sized trellis. Beautiful decorative plants quite suitable for forcing can be grown in 5 and 6-inch pots, which with a little care and attention soon assume a sturdy bushy habit of growth, which is decidedly the best for decoration and forcing. A number of plants according to the demand should be introduced into a temperature of 55°, and syringed twice daily, and in a few weeks their flowers will be produced. A batch of cuttings can now be taken from any plant that has finished flowering, and these will root readily under a bellglass in any warm house, or better still where a little bottom heat can be given. Useful plants will be obtained in twelve months if grown on under stove treatment. This plant will flourish well in either all peat or loam, the former being preferable, as it does not become sour so quickly.

Greenhouse.—*Cyclamens* from seed sown towards the end of the summer, and which have been kept close to glass in a temperature of 45°, will now be thoroughly established in 2-inch pots, and ready for transferring into others 2 inches larger. Employ a compost of loam, cow manure, a little leaf soil, and coarse sand. In potting keep the corms moderately well above the soil for fear of damp, which should be expelled on fine days by the application of fire heat, when the ventilators can be freely opened. Supply water carefully until the roots take to the new soil, and remove all flowers that make their appearance as soon as they can be seen. Where seed was sown during the month of October,

and the plants kept in a night temperature of 60°, they will now be ready for placing in small pots, using more leaf soil in the compost than will be necessary for the next potting. Potting is preferable to pricking them out into other pans until they attain a larger size, which not unfrequently results in a check.

Place the small pots on a shelf close to the glass, and if practicable plunge them amongst cocoa-nut fibre, which will assist in preventing the soil drying too rapidly. Keep the house close until they commence growth, then admit air daily when favourable to insure a sturdy and dwarf, instead of weak drawn growth. If sufficient stock has not been raised sow without delay, as some very useful plants can be produced for flowering next winter from seed sown at the present time. Plants that have been prepared for flowering and kept as cool as possible will, if placed in a temperature of 50°, quickly produce their flowers. Arrange them close to the glass and ventilate daily to keep the flowers and foliage from drawing, or much of the beauty of the plants will be lost. Give liquid manure every time watering is necessary.

Begonias that flowered in early autumn, such as *Dregei*, *weltoniensis*, and *semperflorens*, should be partly cut back, shaken out and repotted in a mixture of loam, leaf soil, manure, and sand, and placed in more heat and moisture. They will flower again in a few weeks, and not only useful for the stove and conservatory but supply abundance of useful flowers for cutting. Tuberous varieties that were rested early may now be started in a temperature of 50°, and brought on gently for conservatory decoration.

THE BEE-KEEPER.

FEEDING.

(Continued from page 16.)

In the article on Feeding given in the Journal for January 4th, autumn and spring feeding of stocks were recommended. The desirability of the former so as to induce the queen to continue laying up to the end of September seems to be called in question by "Stinger," in his remarks published January 18th. For this reason, before proceeding with our advice concerning the feeding of swarms, and what we termed obligatory feeding, it may be necessary to retrace our steps somewhat, and to say a few more words relative to autumn feeding. "Stinger" asks if we mean to say that we can induce our queens to lay after they have ceased to do so in the autumn. There is not the smallest doubt about it. Our experience, although perhaps not reaching over so many years as that of "Stinger," has clearly shown us that the queen's power of and desire for depositing eggs are produced, not by date or season of the year directly, but by a rising temperature and steady influx of food indirectly. Indirectly the warm summer weather and the natural harvest of honey stimulate the queen to exert her greatest possible powers to increase her colony. In like manner indirectly warm coverings to hives and an artificial supply of stimulative food tend more or less to the same purpose, according as they are asisted or adversely acted upon by bright or dull weather and higher or lower external temperature. Each and all these causes we hold to act indirectly on the queen. The direct agency is the animation caused among the workers, which reacts on the queen, and Nature teaches her to continue, or maybe to recommence, laying in order to replace the balance of animal power lost to the hive through the continued exertions of its workers.

In these days, when thousands of stocks are rescued by intelligent bee-keepers from the sulphur fumes, the fact hardly needs stating that queens can be made to recommence laying after they have ceased to do so in autumn. In nearly every instance in which a stock so rescued has been transferred, combs and all, to a bar-frame hive and gently fed, fine batches of young bees have been raised, and such stocks have invariably turned out to be among the best in the apiary for the ensuing season. Even without the facilities afforded by bar-frame hives and sheets of foundation, we have years ago built up strong colonies in straw skeps, feeding far into October, and these have been wintered with heaps of young bees, proving our best stocks in the next season.

Again, in very mild winters there are hives which are never without some eggs and brood, more or less, according to circumstances, and in tropical climates bees hatch and rear young almost without ceasing. This is caused by the indirect action of a constant high temperature and a supply of honey all the year round where flowers of various sorts are ever in bloom. Speaking of bees in hot climates, we cannot help digressing a moment to record

what came under our notice this Christmas. A friend sent some honey which had been brought from St. Kitts, in the West Indies. It had a decided smack of molasses, not such honey as we should care to have our bees collecting. The foreign little rogues had evidently not been satisfied with lawful spoils. We wrote and told our friend so, venturing a suspicion that his bees had made too close an acquaintance with the pressing-house. He tells us in reply that at times they infect the house where the canes are pressed, although flowers are in bloom all the year round. Doubtless it is at a season when the principal natural supply is failing, and only shrubs here and there are in flower. We know that when the honey harvest is at its height in our own country bees will take no notice of vessels of honey stood about in the open air. However, bees must breed all the year long in such a climate as that experienced in the West Indies, in order to be able to continue the existence of the species. Where there is such continual wear and tear there must be constant reinforcement.

We have gone farther than we need have done to prove that queens can be induced to continue laying after the season of natural rest has set in. We, however, did not say in our letter of the 4th inst. that our queens were permitted to discontinue laying, and then be induced by stimulative feeding to recommence, although this is the inference "Stinger" would draw from our letter. What we advocated was to cause to be carried on by feeding until the end of September what would in some districts be dropped at the end of August—viz., the gradual increase in the numbers of young bees. We did not wish to set down a hard-and-fast rule as to any particular date until which feeding should be continued. It is obvious that locality must greatly influence this. One would not advocate feeding a stock of bees until October in a cold northern country. Between the north of Scotland and the south of England there would, generally speaking, be from six weeks' to two months' difference in what we might term the commencement of winter. The present winter has been a noted example of this. Trains were snowed up on the Scotch lines when we had a temperature of from 45° to 50° in the south-west of England.

Again, the seasons differ. We have of late years, at any rate south of the Thames, had a succession of mild autumns. Should severe frost or snow threaten us early in October, then feeding would be at once discontinued. And how different are the conditions to be taken into consideration by those living in a district where the natural harvest closes when the Clovers are cut from those who enjoy the immediate vicinity of acres, perhaps miles of purple Heather! In the former case the queens cease laying altogether, or only lay small patches of eggs in August; whereas in the neighbourhood of the Heather the greatest harvest of the year is yet to be completed, and the hives are all aglow with fervent work. Where the quickly filled combs are judiciously withdrawn by the careful bee-master, and plenty of space given for storing on the sides of and above the brood-nest, the queen will continue laying vigorously until the harvest ends with the month of September, fine warm weather even continuing it into October in hilly countries. Would "Stinger" in both cases adhere to his maxim—"If the stocks are scarce of food by all means feed them, not without?"

In the Heather district it is very plain that artificial feeding would be unnecessary, providing the weather allowed the bees to take advantage of the harvest. But how different the case in the Clover district. Let us see what would happen if such a rule were acted upon. Granted a successful Clover honey harvest, the bees would have plenty of food. We are, therefore, to let them alone. The same mild weather which allows of the ingathering of the Heather honey will tempt the bees in the other district to be ever abroad. The few flowering plants left will be sufficient to keep the bees foraging, and they will ever be seeking out weak and undefended hives on which to develop their robbing faculties. Still no constant addition is made to the stores. But bees would die. Beaten down by the mild but boisterous equinoctial winds, by sudden showers, or falling a prey to the thousand natural enemies awaiting them, the stock would be considerably diminished. Yet so little inducement would have been given to the queen to lay many eggs, owing to the absence of excitement in the hive, that the colony would settle into its winter quarters with few young bees to recruit its strength, and be a weak one in the spring. What we would aim at is to keep up breeding until such time as the bees are likely at once to remain quiescent through the winter immediately after its discontinuance, to have our hives go into winter quarters with numbers of young bees. For the sake of intending bee-keepers and beginners in the art, we again repeat this sentence—"Numbers of young bees."

By all means let us have the opinions of others on this matter, as "Stinger" suggests. As stated in our last letter, we consider the science of feeding of such paramount importance that it

cannot be too carefully studied or too much written upon, and in the multitude of counsellors there is wisdom. "Stinger's" warnings, however, seem to be, Beware of autumn feeding, and Depend on spring feeding. We would reverse this. Surely hives are often fed too soon in early spring; how much more wintry weather we get in March than in September as a rule! If our pets were put to bed in good condition there is no reason why we should insist on awaking them so early in the cold March morning. Let the energies of the hive be awakened at the same pace as spring awakens the sleeping flowers. When they put forth their beauties from the sun-warmed earth, then it will be time to help the bees to increase rapidly their numbers to woo the sweet blossoms. Last spring was an exception to the majority of many past springtides. Little stimulative food was required; so genial was the opening year that the land yielded her flowers, although not her fruits, in due season.

We have learnt a lesson to be careful—very careful—how and when we force on our stocks in spring. When the weather assists our endeavours it is by far an easier matter to obtain plenty of bees early enough for the summer harvest or for the swarming season than to have stocks which shall begin the winter full of young life; therefore, again, we say that spring feeding is only supplementary to autumn feeding. The stronger the stock which has passed through the winter the safer can we apply to it our system of stimulative increase in spring. With the varying changes of the spring weather—from cold to hot, from hot to cold, so the strong cluster of bees condenses and expands, expands and condenses, still covering the growing brood-nest. We hold that there is more danger of getting chilled brood by feeding not over-strong hives early in spring than there is by feeding stocks up to the end of September. In concluding this letter we must thank "Stinger" for having drawn our attention again to the matter, and thus giving us an opportunity to write more fully on the subject, and we would earnestly invite others to give us their experienced opinion as to the merits of autumn stimulative feeding. Our further remarks on feeding in general must stand over to another opportunity.—P. H. P.

TRADE CATALOGUES RECEIVED.

- Charles Turner, Slough.—*Catalogue of Flower and Vegetable Seeds.*
 William Rumsey, Waltham Cross.—*Catalogue of Vegetable and Flower Seeds.*
 G. C. Elliott, Huddersfield.—*Catalogue of Vegetable and Flower Seeds.*
 W. Tait & Co., Dublin.—*Catalogue of Vegetable and Flower Seeds.*
 J. Cheal & Sons, Crawley, Sussex.—*Catalogue of Vegetable and Flower Seeds (Illustrated.)*
 George Cooling & Son, Bath.—*Catalogue of Vegetable and Flower Seeds.*
 W. Toogood, 58, Above Bar, Southampton.—*Catalogue of Vegetable and Flower Seeds.*
 R. H. Poynter, Castle Green, Taunton.—*Seed List for 1883.*
 E. Wilson, Serpell, Plymouth.—*Seed List for 1883.*
 Hogg & Robertson, 22, Mary Street, Dublin.—*Catalogue of Vegetable, Flower Seeds, Garden Implements, &c.*
 Hooper & Co., Covent Garden, London.—*Spring Catalogue of Seeds and Roots.*
 H. Cannell & Sons, Swanley, Kent.—*Floral Guide for 1883.*
 Stephen Brown, Weston-super-Mare, Somersetshire.—*Catalogue of Flower and Vegetable Seeds.*
 William Bull, King's Road, Chelsea.—*Catalogue of Flower and Vegetable Seeds.*
 P. J. Kane, Kells, Co. Meath, Ireland.—*Catalogue of Flower and Vegetable Seeds.*
 Harrison & Sons, Leicester.—*Catalogue of Flower and Vegetable Seeds.*
 James Coecker & Sons, Aberdeen.—*Catalogue of Flower and Vegetable Seeds.*
 W. Hean Quick & Company, Barnstaple.—*Catalogue of Garden, Flower, and Farm Seeds.*



** All correspondence should be directed either to "The Editor" or to "The Publisher." Letters addressed to Dr. Hogg or members of the staff often remain unopened unavoidably. We request that no one will write privately to any of our correspondents, as doing so subjects them to unjustifiable trouble and expense.

Correspondents should not mix up on the same sheet questions relating to Gardening and those on Poultry and Bee subjects, and should never send more than two or three questions at once. All articles intended for insertion should be written on one side of the paper only. We cannot reply to questions through the post, and we do not undertake to return rejected communications.

Books (G. S.).—Mr. B. S. Williams' work on stove and greenhouse plants will suit you. It can be obtained at the nurseries, Upper Holloway, but we believe a new edition will shortly be issued.

Pine Apple Culture (C. E. P.).—We have notes in hand from the correspondent you name, but they did not reach us in time for publication in the present issue.

Planting Peaches and Apricots (P. H. P.).—As chalk can be obtained without difficulty in your neighbourhood, you cannot do better than apply it to the soil you describe. Spread it 2 or 3 inches thick, forking it into the border, and with otherwise good management your trees will flourish.

The Jew's-ear Fungus (H. M.).—The botanical name of the Jew's-ear fungus is *Hirneola* (*Exidia*) *Auricula-Judae*, and is occasionally termed the Jew's-ear Peziza. It was formerly supposed to possess medicinal properties, being specially recommended as a gargle for diseases of the throat, but its qualities in this respect are quite imaginary. It is more frequently found growing on trees, particularly on Elder and Elm. The following are the name and address you require:—Mr. J. Colam, 105, Jermyu Street, London.

Potatoes for Planting an Acre (Hood).—Your letter is extremely vague, as obviously the weight of sets for an acre depends not on their size alone, but on the distances at which they are to be planted. As you afford us no data on these important points we can only suggest a case. Suppose the sets are planted a foot apart in rows 30 inches asunder, 17,424 will be required for an acre; and if they average 2 ozs. each their total weight will be 19 cwt. 1 qr. 22 lbs. By weighing a few sets and deciding on the distances for planting you will now have no difficulty in making an approximate estimate of the weight you will require.

Exposing Stems of Peach Trees (J. E.).—It would certainly be undesirable to expose the stems of the trees to the sun, nor do we see that there is any necessity for doing so, nor for having the stems further from the glass on that account. By training young shoots up the stems and securing them there they will do all that is required in the way of affording shade, and will produce fruits as well as the others that are trained between the stems, overcrowding of the foliage not being permitted in either case. We should prefer having the wires a little further from the glass, but with a free and careful system of ventilation your plan will answer. Other plans of shading the stems is by pinching the foreright shoots to two leaves, or, if no such shoots are produced, encasing the stems neatly with haybands.

Propagating Arbutuses (J. H.).—Fork in some light gritty soil round the shrub, and in this peg those young growths that have become slightly firm sufficiently deep that the buried parts will be moist in summer, and let them remain till rooted, which may be two years. Twisting the stems so as just to rupture the bark facilitates the emission of roots.

Wiring Garden Walls (J. R.).—We think the plan good, and in the end economical. The wire used may be galvanised, No. 13, and for Peaches, Nectarines, and Apricots should be 5 inches apart, and for Pears, Plums, and Apples 9 inches. The wires should be taken horizontally along the wall, guided by eyed wall nails or hooks, and secured at both ends with spikes or eyed nails, and tightened by raddissemers. The wires should be fixed as close to the wall as possible to allow for tying—not more than three-quarters of an inch from it; ours are about half an inch, and we find raffia a good material for tying. We never give estimates of cost, this being quite beyond our province. Consult our advertising columns and write for the particulars you require.

Cypripedium insigne (T. C., Bath).—Overpotting does not promote free-flowering, but in your case the plants are no doubt kept too close, moist, and warm. After the plants have made their growth they should be removed to a house where they can have abundance of air, a light position in ainery being suitable. A drier atmosphere as the summer advances and not too much water induces a partial rest, which is conducive to free-flowering. You will find the requisite details for growing this useful plant on page 111, vol. xxxviii., the issue of February 12th, 1880.

Camellia Buds Falling (W. H., Liverpool).—There is no doubt whatever that the dry heated air from the hot-water pipes is the chief cause of the evil; it is possible, too, that the plants in pots do not have the support they need, and a gentle stimulant such as soot water might be beneficial. If the stage is of open latticework you would do well to cover it with something that would hold a layer of gravel, and by keeping this moist and syringing the pots occasionally the flowers of the Camellias would probably expand.

Grafting Vines (York).—The method of grafting you propose is not a good one for Vines, as there is often such an escape of sap that the scion is flooded. By far the better plan will be to inarch or bottle-graft. The latter method is almost certain to succeed. You might attach two grafts, one on each side of the stem. Both would probably grow, and you could choose the best for the future Vine. In the unlikely event of both failing you would still have the Vine instead of a blank in the house for a year. Select stout and well-matured laterals, taking a deep slice out of the centre, 5 or 6 inches long, and a corresponding slice from the Vine; secure the two cut surfaces carefully and bind with soft matting or tape, the lower end of the graft, 6 inches or so, to be inserted in a winebottle which should be kept filled with water. This will support the graft until the union is complete. For further details and particulars of a remarkable example of success with this method of grafting, see page 76, vol. xxiv., the issue of January 23rd, 1872, which can be had, if needed, from the publisher in return for 3½d. in postage stamps.

Raspberries and Gooseberries (R. H. R.).—We doubt if there is a more useful Raspberry than Carter's Prolific, which was raised by Mr. Carter of Keighley, and lately advertised in our columns. It is sturdy in habit, and produces large fruit abundantly of good colour and quality. It is the favourite variety with Kentish growers, some of whom send several tons of fruit to the market daily during the season. Prince of Wales is a most serviceable kind, growing more strongly and possibly giving a greater weight of fruit than the other, large but perhaps not quite of such good quality. There is no more useful Gooseberry than the Red Warrington for either culinary or dessert purposes. The richest-flavoured variety is the Red Champagne. If you want, say, a dozen bushes plant nine of the former and three of the latter, and you may expect a satisfactory supply of fruit.

Pruning Plum and Cherry Trees (Old Subscriber).—Judging by the wood you have sent the Plum trees must be in an exhausted state, and probably the "spurs" are not only too long but too numerous. The young growths before us are very weak and immature. We should shorten such shoots to one or two eyes, according to the character of each shoot and the prominence of the buds near the base of the growths. No harm could result by thinning out a portion of the old spurs with the object of obtaining fresh growths, to either be pinched in summer for the formation of spurs or retained and secured to the wall where this could be done without overcrowding. Even if no fresh growths were produced the original spurs would be strengthened, as the resources of the trees would be concentrated in fewer channels. For further instructions read our "Work for the Week." If the Cherry trees furnish the wall sufficiently, shorten the breastwood, but next year pinch the growths a few times in the summer, and there will be less necessity for winter pruning, which it is desirable to avoid as much as possible.

Single Dahlias in Pots (C. D.).—It will be well not to have the plants too early, as they will become drawn if long kept in a greenhouse. If you can procure sturdy plants from a cool house or pit during the last week in April, place them on a shelf in your greenhouse for a day or two, then shift them into pots 2 or 3 inches wider than those in which they arrive, using a compost of turfy loam three parts, the remainder equal portions of leaf soil and decayed manure, adding sand to make the whole porous. As soon as the weather permits place them in the frame. When roots protrude through the pots transfer the plants to larger, 6-inch pots being suitable, using richer soil by substituting manure for the leaf soil, and adding a little soot—about a twentieth part of the bulk. Apply water carefully at first, and afterwards more copiously, ventilating freely and removing the lights on all favourable occasions, eventually at night as well as during the day. Before these pots are crowded with roots place the plants in 8 or 9-inch pots, pressing an inch or two of manure over the drainage, and a sprinkling of soot, using richer and stronger soil than before; plunge the plants in ashes in a sunny yet sheltered position, and treat them the same as Chrysanthemums. When crowded with roots liquid manure will be of service, and eventually top-dressings of rich compost. The following good and free-flowering varieties:—Alba (White Queen), gracilis superba, scarlet; glabrata, lilac; Othello, crimson; Rose Queen, Tyro, mauve; Painted Lady, Yellow Gem, and Zulu.

Syringing Peach Blossom (F. C., Inver).—We think you will have destroyed the aphides, and hope you have not injured the Peach blossoms. We have never tried nor recommended a "paraffin mixture at a temperature of 130° for Peach blossoms;" our method is to destroy all insects before the blossoms expand by fumigating and syringing. We should not like to syringe Peach blossoms at all so early in the season, and especially if the weather were dull, for fear of converting the pollen into paste, and preventing fertilisation and a good set of fruit. In dry, bright, breezy weather we have syringed Peach trees occasionally when in flower, and have obtained fine crops of fruit.

Various (Idem).—Chrysanthemums may be cut down as soon as the flowers have faded, but leaving them until the stems decay does no harm. It is not too late to obtain and pot Tuberoses. Pot them and bury in cocoa-nut fibre refuse as you would Hyacinths, and in the course of a few weeks place the pots in gentle heat, a little bottom heat being useful but not essential. *Lilium lancifolium* should not be placed in heat at any time, a greenhouse temperature being quite sufficient. *Tropeolum speciosum* may be planted now if you can obtain roots, and have them kept quite moist with damp moss in transit. In dry districts it is better with a north aspect; in Scotland and moist localities no particular aspect is requisite. We do not know what you mean by the Passion-flower Clematis. The remaining questions shall be attended to next week; we have answered the most urgent. You usually send your questions rather late; the earlier they arrive after the date of publication the fuller and more useful, as a rule, are our replies.

Destroying Weeds on Walks (Somerset).—Whatever you apply to walks of sufficient strength to kill weeds will injure both Box or grass edgings if they are not protected with boards, or if care is not otherwise exercised in preventing either carbolic acid or salt reaching the edgings. We are not able to say whether "J. H." (page 385, vol. iv.), applies salt to walks margined with Box, but if this meet his eye he will perhaps supply the information. In the other case to which you refer there were no Box edgings to be injured. We should not remove the mats from the Eucalyptus until the spring or when severe frosts are no longer expected. Your other question will be answered next week.

Exhausted Azaleas (Jumbo).—If you cannot improve the condition of the plants by applications of liquid manure, that made from cowdung being good if used clear, and of the colour of pale ale, or by top-dressings by fertilisers, Standen's manure being suitable for these plants, then you must adopt another method. The pots it appears are already as large as you require, but instead of shaking the roots out it will probably be a better plan to shave off a portion of the ball, formed by a mass of roots, with a strong sharp knife. We have seen a small sharp axe used for this purpose, and a slice cut off all round 2 or 3 inches thick, as much as possible of the old soil being also scraped off the surface. It is not unlikely that most of the roots next the sides of the pot are dead, but the stronger roots in the interior may be alive; these if placed in contact with fresh soil and the plants carefully watered will probably emit young fibres, and thus the health of the plants may be restored. Good turfy peat such as Heaths delight in, not a mere spongy mass of decayed vegetation, and a liberal admixture of silver sand will be suitable for placing round the roots. If the peat at your disposal is not of the proper kind, then you may mix with the best you have a little sweet leaf soil and light turfy loam. It is of the greatest importance that the roots are in a moist but not wet medium when the plants are repotted, and they must be soaked if necessary for a few hours to thoroughly moisten the original soil, then allowed to drain. In repotting the pots must be clean and well drained, the new soil to be pressed as firmly as the old, otherwise the water will drain off the former and saturate the latter. If good judgment be exercised in watering and the plants are placed in a brisk temperature and syringed frequently they will possibly recover. In all probability pruning will not be needed, at any rate so freely as you suggest, but the flower buds should be picked off, and any dead and very inferior portions cut out. We have reinvigorated Azaleas in the manner indicated, but success depends entirely on the skill and attention of the cultivator in watering and otherwise ministering to the requirements of the plants.

Fuchsias and Pelargoniums (J. B.).—Unless you can syringe the plants occasionally in the structure in which you keep rabbits the atmosphere will be too dry for the Fuchsias if not for the Pelargoniums. You will do well to defer purchasing plants until May, and then have them strong, well-furnished, and established in 5-inch pots. By shifting them into pots 2 inches larger when the roots show through the drainage of the others, and watering carefully at

first, and syringing, the Fuchsias especially, twice a day in bright weather, pinching off the points of the shoots when they have grown 3 or 4 inches, training the leader to a stake, you may perhaps accomplish your object, but everything depends upon your cultural skill. Stopping the shoots must cease within seven or eight weeks of the show. Suitable soil will be two-thirds of fresh turfy loam, the remainder decayed manure and wood ashes, with a tenth part of sand, more or less according to the texture of the loam. This soil and general treatment will apply also to the Pelargoniums, but they need more sun and less syringing than the Fuchsias. By applying weak liquid manure after the pots are filled with roots you may easily have Fuchsias 2 feet high in 7-inch pots; but it is usual to grow Pelargoniums more dwarf and bushy. Good dark Fuchsias for your purpose are Improvement and Victor Emanuel; good lights, White Souvenir de Chiswick and Starlight. Good Zonal Pelargoniums are Henry Jacoby, crimson; Miss Hamilton, blush pink; A. F. Barron, scarlet; and Fanny Catlin, salmon. By limiting yourself to the prescribed number you may fail, and you should leave a margin for accidents or mistakes. Two useful foliage plants are *Latauia borbonica* and *Ficus elastica*; you cannot easily fail with these.

Cropping Land Profitably (J. B. W.).—As so much depends on the skill of the cultivator and his aptitude for commercial gardening, it is impossible to give a categorical reply to such letters as the one before us. The nature of the soil, too, is a matter of importance in determining a question of this nature. We presume Snowdrops and Crocuses do well with you. For the former there is a good demand. Lilies of the Valley might be grown profitably for selling the crowns or flowers, or both. With high culture crowns equal to those imported might, we think, be grown in your district, but whether by yourself or not we cannot say. If Violets thrive well they are very profitable, and you could easily send bunches to all the most important markets of the north. We make these suggestions, but cannot incur the responsibility of indicating a series of crops, for the demand for most things varies from year to year.

Grubs in Celery Leaves (R. C. D.).—The leaf you have sent contains larvæ of the Celery fly (*Tephritis onopordintis*). In the autumn it is very common to observe part of the leaves of Celery plants blistered and turned yellow, and this occurs occasionally to such an extent that their growth is checked and their size diminished. If the withered parts are examined and the skin of the blisters is raised there will be found beneath it some small green grubs that have eaten away all the green pulp (parenchyma) of the parts so withered. These grubs are the larvæ of the Celery fly. The grubs may be found in the leaves of the Celery in June, July, September, October, and November, for there are two or more broods of them in the course of the year. The grubs, through less frequently, are found doing similar damage to the leaves of Alexanders and Parsnips. When full grown the grubs descend into the earth and remain in the chrysalis state until the spring following, when they give birth to the fly. The Celery fly may usually be found upon the leaves of the Laurel, hovering over flowers and resting upon palings in the sunshine, from the middle of May to the end of July. It is one of the most beautiful of the English two-winged flies, and has been thus described by Mr. Westwood:—The general colour of the body, which is five-jointed, varies from rusty brown to shining black; head buff, with black hairs; legs yellow; thorax sprinkled with long black hairs; wings black, with various pale spots; eyes green. The whole length of the insect is not more than one-sixth of an inch, and its wings when outspread barely half an inch across. The motions of this fly are very peculiar. Seated upon a leaf in the sunshine, the wings are partially extended, yet partially elevated, and it has a sidling kind of motion. The withered leaves of the Celery should be picked off and the grubs within them crushed as soon as seen. Mr. Westwood suggests that a string smeared with birchlime and stretched over the Celery plants might catch many of the parents. It will be a wise precaution to grow your Celery next year as far distant as possible from the site of the present crop.

The Cobham or Pope's Apple (J. Hiam).—The fruits you have sent are of this fine variety, of which we seldom receive specimens. It is described as follows in the "Fruit Manual":—"Fruit large, ovate, handsomely and regularly formed. Skin clear yellow, tinged with greenish patches, and strewed with dark dots; on the side next the sun it is marked with a few faint streaks of crimson. Eye large and open, like that of the Blenheim Pippin, and set in a wide and plaited basin. Stalk short, deeply inserted in a round cavity, which is lined with rough russet. Flesh yellowish, tender, crisp, sugary, and juicy, with a rich and excellent flavour. A very valuable Apple either for the dessert or culinary purposes; it is in use from November to March. This variety has all the properties of the Blenheim Pippin, and is much superior to it, keeps longer, and has the great advantage of being an early and abundant bearer. An excellent dessert Apple, with somewhat of the flavour of Ribston Pippin. September to January. Dr. Hogg met with this excellent Apple in the neighbourhood of Sittingbourne, in Kent, about the year 1842. The account he received of it was, that the original tree grew in the garden of a cottager of the name of Pope, at Cellar Hill, in the parish of Linstead near Sittingbourne. It was highly prized by its owner, to whom the crop afforded a little income, and many were the unsuccessful applications of his neighbours for grafts of what became generally known as Pope's Apple. The proprietor of Pope's cottage built a row of other dwellings adjoining, in the gardens of which there were no fruit trees, and, for the sake of uniformity, he cut down Pope's Apple tree, notwithstanding the offer of twenty shillings a-year more rent to spare it. The tree, being condemned, was cut down in 1846, at which period it was between fifty and sixty years old. The name of Cobham was given to it by Kirke the nurseryman at Brompton, by whom trees were distributed."

Feeding Last Year's Swarms (Lux).—Though the two stocks—last year's swarms—which you have lately purchased are light, they are not in immediate want of food, and though bees do not eat much in the winter months, we advise you to begin feeding yours slowly—that is to say, give them small doses of syrup two or three times a week. This process is now called gentle stimulative feeding. If the weather remain mild, so that the bees can safely go abroad for water, the little food given will much assist the bees by causing them to breed. One pound of sugar made into good syrup will be ample for both hives weekly for at least a month. As the hives increase in strength and the bees in activity more food will be required. As the season advances the numerical strength of hives and the large cakes of brood that are built have to be considered in the administration of food, and it is always well to let the bees have enough. In unpropitious weather, about the beginning of April, 1 lb. of syrup per hive per week is not more than enough. In early spring feeding it is important to keep hives warily covered.

Light Hives (K. B.).—As your hives are very light, and as breeding has begun, you should begin at once to feed your bees. Give each hive weekly half a pound of sugar made into good syrup. At first let the syrup be slightly warmed in order to tempt the bees to take it. By-and-by they will require more than half a pound per hive weekly.

COVENT GARDEN MARKET.—JANUARY 24TH.

MARKET very quiet, with short supplies generally. Vegetables only plentiful.

		s. d.		s. d.				s. d.		s. d.	
Apples.....	½ sieve	2	0	7	0	Grapes.....	lb.	2	0	5	0
".....	per barrel	20	0	40	0	Lemons.....	case	10	0	20	0
Apricots.....	doz.	0	0	0	0	Melons.....	each	0	0	0	0
Cherries.....	½ sieve	0	0	0	0	Nectarines....	dozen	0	0	0	0
Chestnuts.....	bushel	10	0	12	0	Oranges.....	100	6	0	10	0
Currants, Black..	½ sieve	0	0	0	0	Peaches.....	dozen	0	0	0	0
" Red.....	½ sieve	0	0	0	0	Pears, kitchen..	dozen	1	0	2	0
Figs.....	dozen	0	6	1	0	dessert.....	dozen	1	0	2	0
Filberts.....	lb.	0	0	0	0	Pine Apples, English	lb.	1	6	2	0
Cobs.....	100 lb.	50	0	55	0	Raspberries.....	lb.	0	0	0	0
Gooseberries....	½ sieve	0	0	0	0	Strawberries....	lb.	0	0	0	0

VEGETABLES.

		s. d.		s. d.				s. d.		s. d.	
Artichokes.....	dozen	2	0	4	0	Lettuces.....	score	1	0	1	6
Asparaghs.....	bundle	0	0	0	0	Mushrooms.....	punnet	1	0	1	6
Peas, Kidney....	100	1	0	0	0	Mustard & Cress..	punnet	0	2	0	3
Beet, Red.....	dozen	1	0	2	0	Onions.....	bushel	2	3	2	6
Broccoli.....	bundle	0	9	1	6	Parsley..... doz. bunches	3	0	4	0	
Brussels Sprouts..	½ sieve	1	6	2	0	Parsnips.....	dozen	1	0	2	0
Cabbage.....	dozen	0	6	1	0	Peas.....	quart	0	0	0	0
Capiscums.....	100	1	6	2	0	Potatoes.....	cwt.	6	0	7	0
Carrots.....	bundle	0	4	0	0	Kidney.....	cwt.	6	0	8	0
Cauliflowers.....	dozen	2	0	3	0	Radishes.... doz. bunches	1	0	0	0	
Celery.....	bundle	1	6	2	0	Rhubarb.....	bundle	0	4	0	0
Coleworts.... doz. bunches	2	0	4	0	Salsafy.....	bundle	1	0	0	0	
Cucumbers.....	each	1	6	2	0	Scorzoneria.....	bundle	1	6	0	8
Endive.....	dozen	1	0	2	0	Seakale.....	basket	1	0	2	0
Fennel.....	bunch	0	3	0	0	Shallots.....	lb.	0	3	0	0
Garlic.....	lb.	0	6	0	0	Spinach.....	bushel	3	0	0	0
Herbs.....	bundle	0	2	0	0	Tomatoes.....	lb.	0	8	1	0
Leeks.....	bunch	0	3	0	4	Turnips.....	bunch	0	2	0	3



POULTRY AND PIGEON CHRONICLE.

GOAT FARMING.

(Continued from page 63.)

HAVING given details of the various species of Goats of foreign origin, as well as those which have been for many years common and acclimatised in the British Isles, we shall endeavour to lay before our readers a mode of proceeding which will be likely by judicious selection of animals for crossing to obtain what we require—viz., milk, meat, and mohair from the same type. If we refer to the capacity of the different breeds as we have given them, we shall find that no one breed at present existing possesses these requirements to the fullest extent. In consequence of this we are obliged to resort to crossing, and any person will see at a glance by attending the principal Goat exhibitions those stock animals which can by judiciously selecting and mating them enable us to secure in the future animals of various capacities which no one breed at present possess. Although the points have been named which we have deemed requisite for animals in the interest and profitable management for Goat farming, we shall, in order that a distinction may be made by the requirements of the amateur or suburban villa-farming objects, treat of these requirements separately, and refer first of all to cross-breeding for combining in one type of animals all three of the prominent and important points, objects, and capacities which will be required by Goat-farming companies, or by individuals in the business of Goat farming.

It may take some years to obtain the objects we have in view, although it may be commenced by enthusiastic and persevering men and regardless of expense; for it must be remembered that in the various breeds of sheep which have now an established type, such as the Oxford Down, the Shropshire Down, and the improved Hampshire Down, were only obtained by judicious selection and mating of the animals; but none of these were so established as for 'like to beget like,' except under twenty years of careful breeding and selection. Therefore at the outset the breeders of Goats of a new type, and possessing such valuable characteristics as we have named, must not be too sanguine as to the period

within which they will obtain all that is required. Breeders must have a determination to overcome all difficulties, and our best encouragement will be found in following the example which has been so successful in the cross-breeding of sheep, and which has given us some of the most valuable stock in England.

Before we proceed farther let it be understood what we require in the Goat of the future, to afford us not only what we think necessary in production by the animal in milk, meat, and mohair, but also the objections in detail which we wish to avoid and exclude in the animal. First, we wish to exclude entirely the objectionable smell or odour which is found in some species. Nor do we require horns, for we can only consider these as required by the amateur, who may reasonably be pardoned for estimating them as a point in the beauty of the animal. As, however, we are now stating the objectionable points in a Goat required only for farming upon profitable and commercial principles, we shall endeavour to get rid of horns in the animal of the future, as they are by no means necessary or contributing to profit. It must, however, not be forgotten that in seeking to obtain good fleeces of mohair upon our milking animals, that some objection is taken to long-haired species, as it is said to be in the way in the act of milking; but the hair, however long, may be shorn off near to the udder, so as to facilitate milking, whether done at the rear or flank. We cannot, therefore, allow a matter so easily overcome to impede our operations in the attempt to raise mohair upon animals which may be the best for producing both milk and meat.

There is one question which must be carefully attended to, as it is quite clear from the statements we have made that no breed at present exists which offers all we require in the same type. We must therefore seek to produce it by crossing, for in making selection of the best milking variety we may take and choose from the best hornless English Goat, and also the Maltese or the Nubian breed may be selected if hornless animals can be found amongst them. Either of these breeds may do for crossing with the object of obtaining milk and meat. Now, without a name to the animal as to breed, we noted that at the Dairy Show in 1880 the first prize in the polled class was awarded to Mr. J. Arnold's Brown Kate, carrying a splendid udder with long teats. This we consider a very good specimen of the kind we are seeking for to cross with Angora blood, which is the only animal from which it is likely we shall ever obtain a full fleece of mohair. But we are told by our experience in cross-breeding sheep that we can get rid of the horns peculiar to the Angora, if the same results are to be expected in the mating of Goats as with sheep, and we certainly can see no reason why it should not be so. The chief difficulty, however, may be overcome in time by careful selection without doubt, for in sheep it is no matter whether a polled ram is mated with a horned Dorset ewe, or *vice versa*, for the result is the same—polled lambs are obtained as a rule.

Our reason for stating these matters is to show the importance in other respects as to which of the sex we take for producing certain characteristics, for in this the object would be sure to be obtained almost, as a rule, based upon our well-known practice in cross-breeding—namely, that the female furnishes the internal formation and qualities, like milking and the constitution; whilst the male is expected to furnish the outward form as well as colour and size. The chief benefit, it may be anticipated if the Goat progeny followed that of the sheep, is that we may expect to get rid of the horns after one or two generations, if not in the first cross, the produce of mohair would be surely inherited. Therefore the only difficulty which can arise would be doing away with the horns, which, if the horns occurred in the first cross or afterwards, they must be got rid of by careful weeding, time, and selection. We do not see any doubt but that our requirements would be obtained as regards milk and meat by selecting the best females for the purpose, and gradually by selection obtain

the mohair skin and covering through the influence of the Angora ram, as this is the only source from which it can be derived. It is of great importance when it is known that a herd of females will yield 7 or 8 lbs. of mohair each, generally worth from 2s. 6d. to 3s. per lb., at the same time, too, where our sheep yield about the same weight of wool only worth from 10d. to 15d. per lb.

The method to be pursued in cross-breeding must now be referred to, the details of which are of the most important nature, because in securing all the points which we require in the new type of animal which we wish to obtain, is only to be obtained by the Goat farmer who has the means and the opportunity in consequence of the numbers in the herd. The first object is to obtain maiden animals of two years old, for when the females have never bred to any other ram we may expect to secure the full influence of the ram which is used. We therefore propose, in case only one person should engage in the raising of new breed or type, that three selections should be made of females of five or six each of hornless animals from three or more breeds known to be of good milking and meat-making character, such as the best English, Nubian, and Maltese or others which the breeder may desire to try in this experiment, but at the same time select those having the longest hair, as in crossing these would nick better with the Angora ram so celebrated for the growth of mohair. Let each selection of females, five or six in number, form separate families with their produce, each having bred to three separate Angora rams, if possible obtained from different sources, yet each exhibiting fully the required character as to mohair. In these separate families we have an excellent opportunity for selecting for breeding purposes in the future from the offspring, and in mating the animals a change of blood can be secured without deviating from the cross of the object in view; and if the offspring of each of these separate families are marked in the ear or otherwise it will prove of some consequence in the future in various ways, for it is necessary that all defective females or males in each family should be withdrawn, and that the best and most robust male animals only should be selected for use, keeping steadily in view the object to be attained.

(To be continued.)

WORK ON THE HOME FARM.

Horse Labour.—Wheat-sowing is still going on, so much land having been left unsown at the usual period in consequence of adverse weather, and, in fact, some which has lately been sown has been got in with the land in a better state than much which was done in the month of November and December. It is even now not too late to obtain a good crop of Wheat where the land works heavy; but in case the weather should change to dry suddenly and the land work too light we should prefer to sow Oats, Barley, or drege, according to the nature of the soil and its condition as to fertility. We note, on referring to our work during this month, that in January, 1862, we had at this time just completed sowing Morton's Red-strawed White Wheat, some of which sort we have sown this season, it being a good yielding sort, very stiff-strawed, and well adapted for late sowing in any of the eastern, south-eastern, or home counties, as we find that upon the mixed soils on the vale farms it gives grain of excellent quality. The Wheat we have just referred to was sown during the latter part of December and first fortnight in January, being, after stubble Turnips, fed off by sheep eating oilcake and hay, and a heavy dressing of box manure applied in addition, the former crop having been Early White Canadian Oats; and we have found for some years that Wheat, if sufficiently manured, succeeds well in this rotation, although sown in January, if the land is not too light. In fact, we have found that Wheat after Wheat, with stubble Turnips fed in the same way, with ample manuring, has also succeeded well. The only two points to be considered is heavy manuring and a favourable season for the summer growth. Carting dung to heap in readiness for Mangold and Potatoes has been continued at intervals when the plough was impeded, otherwise ploughing has been continued for land intended for early white Oats, and will when the time for sowing arrives most probably be found mellow and stale, so essential for their successful growth, as compared with recently ploughed land in the month of March.

Hand Labour.—The employment for men will now be hedging, banking, trenching in the meadows, filling manures in process of carting to heap, also forking out couch grass and weeds from all the fallow surfaces, whether in fallow or on the root land, in which latter work the women will assist, and as the season proceeds this work will be continued on the land intended for Mangolds and Potatoes, early Peas or Beans, or on the Wheat stubbles intended for Oats, the ploughing following the forking of couch as fast as completed.

Live Stock.—Sheep generally have not done so well as we could wish, the land being made heavy and cold by successive rains. Having recently stated the mode of feeding early lambs, we must now state the method of feeding and management of the ewes with lambs at side. Upon the vale farms when sheep are very dear, as they are now, we think it a good plan to separate the flock into two

parts. Those which drop their lambs at the earliest period, say the first half of the flock, may be kept apart from the late-lambing ewes, so that the latter may be fed in a different manner, and kept in fair stock condition only, and eating roots off the land without cutting, with a fair allowance of hay, but no cake or corn; but the lambs running in advance of the ewes should be kept in the best possible manner, as we have often described, in order that they may be ready for sale early, or continued on to make heavy weights as tegs. The ewes having been only fed for stock when the lambs are sold or weaned, as the case may be, will be found in excellent condition, and will, if properly managed, make first-class stock to hold over, and bring their lambs early in the next year, and from being acclimatised will prove better for themselves and lambs also than any which can be purchased at the fairs in the autumn. After being shorn and the rams turned amongst them they may be folded at night if well kept during the day on the best succulent food, such as rape and vetches, until they all prove in lamb, when moderate keep will be sufficient such as old lea, down, or hill pasture.

In the case of the early-lambing half of the flock which had been purchased in the previous autumn, these should be fed with Mangold, or Carrots, or Swedish Turnips cut and placed in troughs mixed with cake meal and bean meal, being fed also with good sweet Clover hay three times a day, taking care, however, that they do not have too many cut roots given to waste. This should be regulated by the animals eating all the cut roots in admixture with cake before they leave their troughs, and the troughs turned upside down immediately afterwards, in order that they may be clean for the next feeding. It will then be carried out without waste of superior food, and when the lambs are sold the ewes, too, will be fit for the butcher at the same time, for we have sold the Dorset Down ewes at Easter (with lambs at side), weighing 14 stone of mutton when fed as we have described. The dairy cows are now in most cases out of profit and are forward in calf, in which case it is not well to keep them too high with cake or other extra food, for it frequently leads to inflammation of the udder and other difficulties at calving time. If the cows get a few of the large Drumhead Cabbages, and sweet oat straw daily it is the best food they can have after the milking period is passed and before they calve. We do not approve of cows running in the pastures during the wet weather, as their tread is very damaging to pastures. We advise if the animals are in calf that they have something like an hour's exercise every day, but not to be allowed to remain out and be found shivering under some hedge or shelter they leave their droppings, which is lost.

POULTRY AND PIGEONS

ABOUT A DORKING CHALLENGE CUP.

ON reading the article with regard to the above signed "C.," I thought at first something good might come of it, but on reflection I could not determine where from. "C." points to the Game fowls, and says, "See what a challenge cup has done for them;" but of that presently. Supposing there were a challenge cup for Dorkings subscribed for. In the first place where are they? secondly, who should act as the judge? To my mind certainly not those who have been so acting, for it is entirely to their want either of knowledge of the true bird or to timidity in the administration of their awards things are as they are. I do not intend to go largely into the matter, as it is not convenient for me to do so at the present time; but I trust I may be able to show in a few words what I mean. In the Standard of Excellence, which was really a very, very good one, published many years ago by the then Poultry Club, after enumerating the many good points a Dorking should possess, it goes on to say, Disqualification "legs any other except white," and this is also put forward as a disqualification in the new Standard of Excellence sent by the present Poultry Club.

Does the word "disqualification" mean anything or nothing? If the latter I have no more to say. If the former, it means, I contend, that a bird having those defects stands disqualified *without any act on the part of the judge*; in other words, it is "out of Court," and "out of Court" for many a long year have often been the so-called Dorkings, the owners of which have carried away the prizes, the same Dorkings having dark legs, dark spots in their legs, dark toes, &c. On one occasion I pointed out to my good kind old friend, the late Mr. Hewitt, that the first-prize had small stubs of feathers on its legs. "Yes," said he, "but see what a large bird it is." "But," said I, "it is not a true Dorking." "Well," said he, "they will have size, and Dorkings are not my forte." I said no more. Again, I pointed out not long since a prize bird with dark legs to the judge. "I know it is wrong," said he, "but where are we to get the old pure white ones? They will have it so." I only asked who are "they." I am always met with that word by judges, who are so called wrongly, but none

have ever defined to me who "they" are. It is always pushed on to someone else, some invisible unknown being. Why does not the judge speak out fairly, honestly, and openly, and say at once "Others are doing wrong, and I am not strong enough to act up to the proper standard, and insist upon what is right?" Forgetful also is he that he is doing an injustice by giving away prizes that should properly and truthfully belong to others, giving prizes to birds that stand even before he comes to judge them, Disqualified. There is no hope for the Dorking or any other breed of fowls or Pigeons arriving at the height of excellence under the present method (for I call it nothing else) of judging.

A Dorking challenge cup would not help the Dorking breed one whit unless they are judged up to the true Dorking standard in all its entirety, which certainly is not the case now; hence the muddle and mongrelism that take the place of order and breed.

At the commencement I said I would say something about the Game fowl challenge cup. What I would say is, that to my thinking the falling-off is most lamentable. When I look back to the time when French's Game cock won at Birmingham, and before it left the showyard sold for £100, and compare it with the long-legged, long-thighed, breastless present snow bird, I cannot for one think "change is progress." It is said that as fighting days are over the Game fowl should not be what it was, yet the show Game fanciers talk a quantity of utter nonsense about length of reach, &c. Bah! it makes sad one who has handled many a bird of the old type—a bird of beauty of form, beauty of colour, a representation of the Englishman for courage; a bird for table purposes surpassed by none for flavour and fine tissue, not even the playmate of my childhood, the Dorking of world-wide renown. Look at him as he stands, the true old English Game cock, thick-set and sturdy, with the "light of battle in his eye," with his proud and haughty step. Even his very hens standing about seem to admire him as one would Adonis. Look at him in his bygone days, and look at what the challenge cup has brought him to. Look on this picture and then on that.

I am not speaking of individual birds, but the show Game as a class. All must admit that the cup Black Red at Birmingham had his attractions, but a genius like that of Capt. Heaton's refines and give lustre to all it touches.

No, I for one am much obliged to "C." for his suggestion of a challenge cup for Dorkings, but cannot see that it would remove the present difficulty in any way.—HARRISON WEIR.

POULTRY NOTES.

THIS is of all others the time of year at which the management of our breeding stock is of importance if we are to have many and strong chickens. Starved or overfat fowls will not produce vigorous or healthy offspring. The latter is by far the most frequent fault. During the moult and autumn fogs much nourishment is necessary to make birds resist the cold and bear the strain on their system which the growth of fresh plumage entails. When this is over we are too apt to continue the same scale of diet to their great detriment. They are just now peculiarly liable to put on too much flesh, especially in such warm weather as we have lately had. Fanciers should beware of this, and look well that those who have charge of their stock do not continue the same bountiful diet that we have prescribed for the late autumn, but diminish it judiciously as the days lengthen and temperature rises.

IN another fortnight or three weeks all Pigeons may be mated; it is now, therefore, high time to be putting the loft in order. Every removeable nest should be removed, thoroughly cleansed and disinfected. Much trouble from vermin in the summer may thus be obviated. No birds need now be disturbed by their quarters being turned out in a way which in the middle of the breeding season would cause disastrous alarm and confusion.

COOPS, too, which ought all to have been thus cleansed before being stowed away at the end of last chicken season should now be looked to and repaired. It is very bad economy to put broods into rotten or dilapidated abodes when a few shillings would make them warm and watertight.

THE financial management of the first Buckingham Poultry and Pigeon Show, held last week, might well be copied by managers of other shows who wish to make them popular. We know that in some cases cheques for the prize money must have been posted within twenty-four hours of the close of the Show. This promptitude is peculiarly satisfactory to young exhibitors; we often hear of their surprise and disappointment at having to wait weeks for

their winnings. We remember that the Hemel Hempstead Shows were soon distinguished for the same promptitude; probably Mr. Peel has imported the good custom to Buckingham.

WE have before us the schedule of a Poultry and Pigeon Show to be held at Hereford on February 15th. There are twenty classes for poultry, nearly all cock or hen; this is not a good or satisfactory division. It is quite impossible for anyone to balance well between the merits of a cock and a hen. Pigeons also have twenty classes. Entries close on February 2nd, and the Hon. Sec. is Mr. E. G. Fluck, King Street, Hereford.

POULTRY Shows seem at present to prosper much in the western counties. Within two months there have been three great shows in the county of Somerset alone—Ilminster with 750 entries, Taunton over 1200, and this week Yeovil with, we believe, over 1600. We understand, too, that at Gloucester, held simultaneously, and with quite a modest schedule, there are 1000 entries.

THE Dorchester Committee have, we are informed, complied with the peremptory request of the Poultry Club, and are about to issue an amended prize list and pay all the prizes irregularly withheld. This is clear proof of the power which such a body as the Poultry Club has. Individuals by isolated action would never have been able to enforce this tardy act of justice.

THE Liverpool Show is advertised January 31st and February 1st. The classification is generally good, but the prizes are very small.

AS Pigeon fanciers we have always been strongly averse to Pigeon-shooting. The daily papers announce that the Princess of Wales has put herself at the head of an alliance of ladies, who have determined never to countenance by their presence this so-called "sport."

THERE has lately been much grumbling about the appointment of extra judges at certain shows, whose names were not advertised in the schedule. It is impossible for a committee who project a show to calculate beforehand the number of entries. A judge who can take three hundred pens well cannot do justice to eight hundred. At the same time we advise the insertion in every schedule of a saving clause, allowing the appointment of extra judges if necessary, and their names should if possible always be announced in the poultry papers before the opening of the show.—C.

THE POULTRY CLUB.

A MEETING of the Committee of the Poultry Club was held at the Charing Cross Hotel on Wednesday, January 17th, at 2 P.M. There were present Mr. S. Lucas (in the chair), the Earl of Winterton, and Messrs. T. W. Anns, G. B. C. Breeze, R. A. Boissier, A. Comyns, T. C. Lawson, Rev. E. H. Morgan, and C. F. Montrésor.

ELECTION OF OFFICERS AND COMMITTEEMEN.—The Secretary reported that he had issued voting papers for the annual election, and that the following was the result of the voting:—*President*: Mr. S. Lucas, 40 votes. *Secretary*: Mr. A. Comyns, 45. *Committeemen*: Mr. O. E. Cresswell, 41; Mr. L. Norris, 40; Mr. T. W. Anns, 39; Viscount Grimston, 38; Mr. G. Vigers, 30; Mr. G. H. Wood, 30; Mr. T. C. Lawson, 28; Mr. R. E. Horsfall, 21; Rev. E. H. Morgan, 20; Rev. H. C. Fellowes, 15; and that accordingly all the gentlemen named, with the exception of the Rev. H. C. Fellowes, had been duly elected. The Committee examined the voting papers and directed that the Secretary's report be confirmed.

The new President, Mr. S. Lucas, took the opportunity to thank the members for the honour they had conferred upon him in electing him President of the Club, and said he should endeavour at all times to fulfil the duties of that office to the best of his ability.

NEW MEMBER.—The following new Associate was elected:—E. T. Gardom, Longford, Gloucester.

DORCHESTER SHOW.—The Secretary read some further correspondence with the Chairman of the Dorset County Poultry and Pigeon Society, from which it appeared that the Dorchester Show Committee had decided to adopt the suggestion of the Poultry Club Committee and pay the prizes as offered in the schedule, in all cases other than those in which the prizes had been withheld for want of merit. The following is the amended prize list:—

CREVE CŒURS.—1, J. T. Calvert; 2, R. R. Fowler & Co.

HAMBURGHES.—*Silver-pencilled*.—1, J. Rawnsley; 2, H. Beldon; 3, F. Jagger

h.c., H. Pickles. *Golden-spangled*.—1, H. Beldon; 2, J. Rawnsley; 3, R. W. Bracewell; h.c., H. Pickles. *Silver-spangled*.—1, H. Beldon; 2, H. Pickles; equal for 3, F. Jagger and J. Rawnsley.

MALAYS.—1, Rev. A. G. Brooke.

LEGHORNS.—*White*.—1, Brierley and Smith; equal for 2 and 3, A. C. Bradbury and R. R. Fowler & Co.

ANY OTHER VARIETY.—1, Mrs. Muir; 2, Hon. and Rev. F. G. Dutton; equal for 3, J. T. Calvert and R. R. Fowler & Co.

DUCKS.—*Mandarin or Carolina*.—1, E. A. Bontcher; 2, Mrs. S. M. Pratt; equal for 3, C. F. Williams, A. Whitehead, and S. Wade.

SELLING CLASS.—*Cocks*.—1, G. H. Wood; 2, C. Bloodworth; 3, W. Street.

STANDARD OF PERFECTION.—The publication of the new Standard was further discussed. Mr. A. Comyns was appointed Editor, and the following gentlemen were requested to act as an editing Committee—namely, the Earl of Winterton and Messrs. T. W. Anns, G. B. C. Breeze, R. A. Boissier, O. E. Cresswell, S. Lucas, and L. Norris.

SHOWS UNDER CLUB RULES.—The Secretary reported that the Belfast, Buckingham, Hednesford, and Gosforth Shows were to be held under Club rules. Subscriptions were granted in aid of the funds of the first three of these shows.

DATES OF MEETINGS.—The following dates were fixed as those on which meetings of the Committee shall be held, subject to any alteration which the Secretary may think necessary:—At the Charing Cross Hotel at 2 P.M. on Fridays, February 9th, March 9th, April 13th, May 11th, June 8th, July 13th, and August 10th; and on the second days at the Dairy Show, Birmingham Show, and the Crystal Palace Show.—ALEX. COMYNS, *Hon. Sec.*, 47, Chancery Lane, London, W.C.

OUR LETTER BOX.

Parasites on Pigeons (*J. E.*).—Lice infest the bodies of the birds, breeding among the feathers, mostly about the head and neck, but also running all over the body. These usually attack sick or delicate individuals; and they may almost be considered as constitutional with some. They are very annoying to the birds, keeping them in low condition, and retarding their recovery. A little powdered sulphur dusted in among the feathers is a good remedy. Cleanliness and good condition are the best preventives.

Lime Water for Fowls (*D. D.*).—This is beneficial for an occasional drink to fowls, as it is a preventive of diseases, and assists the formation of bone and eggs. Prepare as follows:—Pour over quicklime some warm water, and when the lime is slaked and settled draw off the clear liquid, which can be kept for a considerable time. The lime will be useful for whitewash.

Fowls Suffering from Cramp (*Eccles*).—The sudden change of weather from extreme drought to constant damp and heavy rains may account for much of the cramp you complain of. It is, however, more often caused by improper flooring for their roosting-places, such as stone, brick, or boarding. If you have either of these remove it; if you cannot do that, cover it some inches deep with dry gravel. If you have no gravel, get that which is most like it. Road grit is an excellent substitute. Onions are very good for Turkeys. Stimulants, such as strong beer, a mixture of bean, pea, and barley meal slaked with beer is good food. The chickens will rally by having bread steeped in it. The present weather will necessitate generous feeding.

METEOROLOGICAL OBSERVATIONS.

CAMDEN SQUARE, LONDON.

Lat. 51° 32' 40" N.; Long. 0° 8' 0" W.; Altitude, 111 feet.

DATE.	9 A.M.				IN THE DAY.				Rain.	
	Barometer at 29s and Sea Level.	Hygrometer.		Direction of Wind.	Temp. of Soil at 1 foot.	Shade Temperature.		Radiation Temperature.		
		Dry.	Wet.			Max.	Min.	In sun.		On grass.
1883.										
January.										
Sun. 14	29.576	36.9	36.3	E.N.E.	40.2	33.7	46.4	29.8	0.175	
Mon. 15	29.385	41.9	41.2	W.	40.6	48.3	36.1	59.4	0.310	
Tues. 16	29.725	37.4	35.7	N.N.W.	40.8	45.8	36.2	65.7	0.019	
Wed. 17	30.147	43.2	42.6	S.W.	40.1	48.2	31.8	50.8	0.229	
Thurs. 18	30.167	50.0	48.8	S.W.	41.5	51.3	42.1	52.6	0.068	
Friday 19	30.333	40.1	40.1	S.E.	42.6	51.0	38.0	50.4	0.058	
Satur. 20	30.249	48.3	47.7	W.	43.2	51.3	39.5	56.9	—	
	29.940	42.5	41.9		41.3	48.9	36.8	54.6	0.639	

REMARKS.

14th.—Damp, misty, and dull.

15th.—Dull at first; fine day with sunshine; solar halo at 1 P.M.; heavy rain in evening.

16th.—Dull morning; sunshine in middle of day; misty evening.

17th.—Rain at first, dull and damp throughout.

18th.—Dull, with rain all the morning; fine in evening.

19th.—Foggy morning; slight rain after 11 A.M.; fine evening.

20th.—Dull and damp.

Maxima considerably above those of the previous week, and mean temperature also higher and above the average. Much dull damp weather, although the barometer has been high.—G. J. SYMONS.



1st	TH	Royal Society at 4.30 P.M. Linnean Society at 8 P.M.
2nd	F	
3rd	S	
4th	SUN	QUINQUAGESIMA.
5th	M	
6th	TU	
7th	W	Society of Arts at 8 P.M.

THOUGHTS ON GARDENING AND GARDENERS.



It is often remarked that much good comes from people seeing themselves as others see them. I would in the following lines endeavour as a follower of the art of gardening to see myself and fellow men who are connected with it in a light that I hope will show some of our shortcomings, while at the same time displaying some good qualities.

I may here remark that nothing is more calculated to degrade the gardening profession than envy and malice displayed to horticultural brethren who may prove more fortunate or more skilful in their work. Let there be no such feeling existing, and gardening is at once relieved from a blot that unfortunately it has not always been free from. In the pursuit of gardening no trace of jealousy or evil speaking should be found, and then a more perfect union of the brethren could be attained, a more perfect sympathy with each other be aroused, and gardening be made more pleasant to all concerned. From time immemorial the gardener has plied his trade, and in these days of ours has reached such an eminence that a large amount of literary skill and publishing enterprise is devoted to chronicling his sayings and doings, and in keeping him up to the times in what is going on in the horticultural world around him.

I would like to call the attention of all young men who may be just entering on their course as gardeners to the great difficulties that lie before them in their career, at least if they wish to become competent in their profession. Gardening requires a man to be thoroughly in earnest. He must devote every moment he has to the study and practice of his calling; he must be a close and attentive observer of Nature and her wants; he must be able to grapple with many difficulties, and by assiduous endeavours seek to comprehend the varied details in connection with the multitudinous subjects that come under his notice and require his attention.

I would like to impress upon all young men who are thinking of following or are following gardening that they must resist the temptations of the bothy system, where they are exposed in many cases to inducements to become frequenters of public houses, card players, or to staying out late at night, engaging in foolish sports, and a course of conduct that can never make a man master of a pursuit that needs undivided attention. Far be it from me to say that such conduct is common among young gardeners; still I know that

sometimes such is the case, and I would therefore warn all who care to read what I say, that such conduct is incompatible with the earnestness in gardening. The spare time of young gardeners cannot be more profitably spent than in improving themselves by observation and study—observation of all that is going on around them, so that they can be deducing lessons that will benefit them in the future from the operations of the present; study of every book and paper obtainable connected with their profession, also study of any and every branch of education that can benefit them in any way in after life.

It is a great mistake for young men to rest content with what little learning they may have attained at school. What they have learnt there should but be considered a stepping-stone to something better, and no effort should be spared to improve what has simply been begun in youth. No man needs such a diversified education as a gardener if he seeks to attain to eminence in his business. Does he not need Latin to enable him to master the names of the plants he is called upon to grow? Does he not require a knowledge of landscape gardening, of the arrangement of colour, of geometry, of arithmetic, of composition? Should he not be a good penman and able to keep accounts? Should he not have some knowledge of chemistry to enable him to provide suitable composts and maintain certain conditions of soil, air, and water suitable to his many subjects? Should he not know something of mechanics and natural philosophy, of the theory of ventilation, of the science of botany, of natural history, and other subjects numerous and varied, and which, when all put together, form a list quite formidable enough to frighten any young man, but which are, nevertheless, of untold benefit to any who desire a good position in the gardening world?

Are there not some men who take to gardening and fail entirely to perceive that many of such branches of knowledge as I have mentioned are requisite for their success in life? And above all a gardener should be—as I am glad to say in many cases he is—a gentleman, I mean a gentleman in the truest and best sense of the word. When such a man is met with, one who has devoted his time to an intelligent study of everything connected with his profession, who is able clearly and pleasantly to discourse on subjects bearing on his calling, mark him well! He has not attained such a position without a hard struggle, many an hour spent in study and observation, and much self-denial and discipline. Let such a man be the model for all young gardeners to copy, and gardening will become more and more appreciated as a calling which requires men of no mean ability, no mean education, and no mean power of self-control and self-discipline to master the difficulties attending its successful pursuit.

I say, then, to all young gardeners, Be up and doing. Do not let the pleasures of thoughtless youth be yours. Do not rest content to be mere cyphers in the gardening world. Strive assiduously to rise to distinction, and if you fail to reach the highest position in the realm of gardening, let it not be through any want of endeavour on your part: if you cannot command success, at least deserve it. No one will be the worse of trying to master everything connected with his profession. The time will be well spent, and if at the end of life's journey the highest position in the gardening world has not been theirs, no regrets for

time misspent will arise to trouble them; and if they have above everything else remembered and sought after that "good part that shall not be taken away," then indeed happy are they.—EXCELSIOR.

GESNERIA CINNABARINA.

For a number of years I was in the habit of growing several varieties of Gesnerias, but the above proving to be the most pleasing both to my employers and myself, the rest were discarded to make more room for it. I have often wondered why these showy useful plants are not more generally cultivated, considering that they bloom in such profusion at a time of year when flowers are very acceptable. A cool stove here, at the present time and for several weeks past, has been exceedingly bright with them. I offer a few remarks on their culture as followed by myself, and which has for several years proved very satisfactory.

As soon as the plants have flowered they are removed to an intermediate house, and the supply of water is diminished until the foliage is withered; they are then placed in a rather cool position, and never are allowed to become dust-dry. They remain there until the last week in May or the first week in June, when they are shaken out, and the tubers are placed in pots, one tuber in a 60-sized pot, and three in a 48. The soil used at this first potting is composed of loam, leaf soil, and sand. If the soil is at all damp no water is given for at least a week. The pots are then placed on coal ashes in a cold frame—which is kept close—on a north border. Under this cool treatment the growths come very strong, and when half an inch long they are at once taken to the intermediate house, which at this time is occupied with Melons and Cucumbers, and they afford a shade for the young Gesnerias. It is surprising what progress they make at this time, and are soon ready for the shift into their flowering pots.

The soil in which the plants are to bloom is made richer by adding well-decayed manure, and is used in a tolerably rough state, as I find a porous soil is the most suitable. They do not like bright hot sun, so this is guarded against by providing a shady position. Thrips and mealy bug are their worst enemies, but good daily syringings keep them free from both. As soon as the pots are full of roots and the flower spikes begin to appear weak liquid manure is applied twice a week. The weak points of this plant are—first, that it is little or no use for cut blooms; nor will the plants do for room-decoration, especially when gas is burnt, as in either case the bloom falls quickly, but for a cool stove or warm conservatory well-grown plants have few others to equal them, and none to excel in their season.—W. W. B.

GARDEN STRUCTURES AND VENTILATION.

I AM always interested in any communication that practical men or gardeners make on these subjects, as an authoritative guide is greatly needed to point out what is right amidst the maze of applications for, and instructions how to build, glass houses that are received from ladies, gentlemen, and gardeners. "R. P. B." has missed a grand opportunity of enlightening us on this matter (page 21). He speaks of seeing a range of houses built within two years, in not one house of which plants would grow; of others in which Orchids, Eucharises, and Pelargoniums would not grow; but since new structures have been erected no difficulty is experienced. How easy for him, and how useful to others, would it have been to describe the faults of the bad houses and the merits of the good ones. In nine cases out of ten it is the gardener who is consulted as to the erection of the houses, their height, width, pitch, and mode of ventilation, and few professed horticultural builders would commence building without knowing the gardener's wishes on these points. Why, then, so many failures? Is it that most gardeners do not really know what is the best kind of house, and go on in old grooves, asking for the old style of fifty years ago, because they are puzzled with the many patent glazing systems? I have before me letters from gardeners—one wanting a vinery with heights which make the roof an

angle of 25°, another for Cucumber house at 70°; another insists on 6-foot front for 12-foot-wide lean-to against 12-foot wall, and refuses a 3-foot front and 13 feet wide, with steeper pitch and 2 feet longer rafter, though it is exclusively for Vines, and the cost is much less than his idea, the expense of which is too great.

A common cause of failure is such a one as I was recently called to. A gentleman employed a local man (who dubbed himself a horticultural builder because he had made two Melon boxes for the clergyman and repaired his greenhouse) to build him some greenhouses. After three months one was erected and a new gardener engaged, who found it faced N.E. The other two houses were then arranged at right angles to face S.E.; but the gentleman insisted on the fronts being heavily ornamented and 7 feet high with an almost equal-sided span-roof to save building a high wall, and these were to be vinery and Peach house, the credit of building which for this purpose would afterwards be given to the horticultural builder from London. Returning, however, to "R. P. B.'s" article, he says that "a Peach house as a lean-to should not be less than 18 feet wide," but does not state the height. Now, if the majority of gardeners are to be relied on, a steep pitch of 50° to 60° is the proper one for Peaches, and such a width would thus require a wall over 20 feet high. Vineries are of an made 15 to 18 feet wide, and the finest crop I have seen for many years was in a house 21 feet wide with 30-foot rafters erected nearly fifty years ago; but old walls suitable for such structures are very rare, and it is still rarer for new walls to be built as high as 15 feet even.

As to construction, I would observe that the replacing of the woodwork when it does give way (which ought not to be for an ordinary lifetime if the erection is "nearly indestructible"), and the taking-out of glass bedded in good putty, will not be such an easy matter as "R. P. B." seems to think. One word on the reference to glass, as it will cause many to suppose that Belgian is equal to English. Belgian glass of seconds quality is not equal in appearance to thirds English, nor so free from blemishes and bubbles that burn the foliage. Its so-called weight of 21 ozs. to the square foot rarely exceeds 18 ozs.; its colour is bad, and it is so brittle that a 21-oz. Belgian pane is often broken with a force that tough 15-oz. English will resist.

"J. J.," on the following page, refers also to a most important question, that of the right amount of ventilation. Not being a gardener I cannot advise as to time for, or extent of, opening the ventilators in different houses, but from observation I am quite convinced that many are radically wrong in their method of giving air. Early one bitterly cold day in November I was in Yorkshire, after having travelled all night, to see some gardens. The gardener had met me at the station about 6.30 A.M., and we went into a house to show me the kind of structure he wanted. I remarked that it seemed "stuffy," and observed all the laps of glass were puttied up. He said, "Oh! we have not opened the ventilators yet," and instantly did so, temperature outside being 34°, and inside 65°. He did not require it above 55°, and could easily have kept it above that with all laps clear, as they should be to keep up an insensible circulation the whole night through. If these had been clear there would be no need for admitting air at 30° lower in order to reduce the temperature 10°, and there would have been no "stuffiness." The chief use of ventilators, I take it, are in summer or with the sun shining, when the temperature under glass increases so rapidly; in winter the laps of glass, with an occasional opening of lights for an inch or two, should suffice. Some will tell me, as the gardener above did, I do not know the requirements of plants, and that you cannot fumigate with open laps of glass, but I fancy that many of the causes for fumigating would be removed by a more constant circulation of air. Radiation of heat from hot-water pipes will not of itself produce this without means of inlet and outlet for air.

There are fixed rules for judging the best flowers or fruits, there are elections as to best Roses, Apples, &c.; could there not be instituted a fruit-house and a plant-house election, or some general rules for the erection and ventilating such houses? Many of our best gardeners send in reports annually of the

fruit crops, &c., at a time when they are very busily occupied; but the present is a comparatively slack season, and if these gentlemen would give their experience briefly in a tabulated form as to best early vinery, its internal width, heights back and front so as to get pitch of roof, method of ventilating, size of glass, &c., with remarks as to whether late vinery should be flatter or steeper, there would be some data for others not so experienced to work from. Similar tables as to the best width and form of plant houses, forcing houses, &c., would be equally useful.

It is easy to calculate how best to catch the sun's rays on an average, or to secure the greatest benefit at any particular month of the year, but this is not all that is requisite to know to secure successful results. For instance, an angle of 40° to 45° is the most favourable for receiving the sun's rays at a right angle for the best part of the year, yet houses requiring most heat for forcing or for tropical plants are not built at that pitch; on the contrary, as a rule they are so flat that the sun's rays can never strike them at a right angle. There are some reasons for this general selection of a flat roof, though not very forcible ones in many cases, and I usually do as I am bid if my suggestions are not approved of, though in many cases I know the structure is not the best for its purpose. As "R. P. B." says in his opening sentence, "the part which glass houses [and their heating] play in the success or non-success of gardeners has never been taken fairly into account in estimating results;" if it had the Royal Horticultural Society would have compiled tables and given useful advice as to the best forms and construction of these, the largest often and most expensive portion of the furnishing of a good garden.—B. W. WARHURST.

CHRYSANTHEMUMS AS CUT FLOWERS.

GROWERS of large blooms of Chrysanthemums suitable for exhibition purposes are very apt to write disparagingly of the grower who devotes his time and attention to such plants and varieties that will yield the greatest supply of flowers most suitable for cutting. What analogy can there be between a bunch of Grapes and a Chrysanthemum? And although a gigantic bunch of the former is noble and striking in appearance, it is questionable if it is as serviceable to those who have to supply the constant demands of a family as a number of smaller bunches. The same may be said of large flowers of any of the sections of Chrysanthemums, which are individually beautiful where they can be employed singly in specimen glasses, in which their real beauty can be displayed to advantage. I have not one word to urge against the cultivation of large blooms, but where light and artistic arrangements are daily in demand these large blooms are useless. In this case what an advantage would a gardener reap in growing large flowers, say from one to three upon each plant, simply because they please a section of the Chrysanthemum-loving public, and thus be no service to him other than to make heavy formal arrangements instead of having them light and elegant? The requirements of gardeners differ widely, and the man who wants abundance of flowers suitable for cutting will not long devote his time and attention to the production of material unsuitable for his purpose. Those who grow for "cutting" do not find one or two flowers on a plant, say of Elaine, as useful and satisfactory as has many hundreds, and every flower suitable for the purpose for which they are grown.

The demand upon gardeners at the present day for cut flowers is one of the main reasons why they do not produce a few "fine flowers" in preference to basketfuls of those suitable for "cutting." What gardeners want who have flowers to provide is a dozen or score of good free-branching varieties and in quantity, and not 150 varieties or more, and one or two plants of each. I think there is equally as much credit due to the grower who produces plants suitable for decoration and cutting in a high state of perfection as to the man who grows one or two fine flowers on a plant suitable for exhibition.

I grow about five hundred plants, some with large flowers, but now the majority otherwise, and should therefore be in a position to know which of the two are the most serviceable for those gardeners situated similar to myself.—INCOGNITA.

RIBES SPECIOSUM.

RIBES SANGUINEUM and its varieties are well-known ornaments of our gardens, but the species of which a spray is shown in the woodcut (fig. 21) is by no means so common; yet though some-

what less showy than the other, it has sufficient attractions to recommend it to all who regard flowering deciduous shrubs with favour. The flowers are bright red, both in form and colour being suggestive of some of the small-flowered species of Fuchsia. They are borne three or four together on short peduncles, and are slightly pendulous, thickly clothing the branches, which have bright green Gooseberry-like leaves and abundance of rather formidable spines. It is a native of California, and is said to be also found in Mexico. Seeds were first sent to this country in 1828.

Respecting its name Professor Lindsay wrote as follows in the "Botanical Register" in 1833: "By the late Sir James Smith this plant was called *Ribes stamineum*, that learned botanist not having discovered in 1819 that it had been described in a well-known English work in 1814 under the name of *R. speciosum*, an



Fig. 21.—*Ribes stamineum*.

oversight not confined to this species alone, but connected with others of the same nature, which form part of one of his communications to the Encyclopædia of Dr. Rees. It is not surprising that these errors should have been copied by M. Berlandier in De Candolle's 'Prodromus.'

PINE APPLE CULTURE.

UNDER the signature "J." in the *Journal of Horticulture* of December 28th, 1882, are some encouraging remarks on Pine-growing. I have a friend who has a small hothouse, with bottom heat in a large bed, heated by a flue. I should be glad if your correspondent could give me a few simple rules—heat required, time of planting crowns, compost to be used, and any other hints that may be considered fitting.—C. E. P.

[In reply to the above note it will be well for the inexperienced to procure Mr. Thomson's book on the Pine, which is very valuable for aiding anyone commencing to grow this fruit. I may, however, try to give a few notes of what I have found a successful mode of treating Pines. In regard to the propagation, suckers are generally preferred to crowns. I have found suckers do better

than crowns, and generally only used the latter in cases where the former were not plentiful. It often happens that the fruits are sent where the crowns cannot be got back for propagation, so we may say that suckers form the principal means of propagation. If they can be obtained they may be potted from this time on to September, or even later. When I had good suckers they were invariably taken off and potted, no matter what time of the year it was. Suppose a lot obtained in February, they should be potted in 6 or 7-inch pots, well drained, and potted firmly in rather light fibry loam; no bones need be added till the final potting. If the soil is moderately moist no water need be given till there are signs of rooting, and then only with great care; when watered giving a good soaking, but not repeating the dose till the soil is again becoming dry, but not dust-dry. Many suckers are spoiled by overwatering. When potted the suckers should be plunged in either tan, leaves, cocoa-fibre refuse, or sawdust; any of these materials will do. Bottom heat should not exceed 85°; if the bottom-heat thermometer shows more than that temperature the pots should be loosened in the bed, thus allowing some of the heat to escape.

When plenty of roots are seen at the outside of the ball of soil the suckers should be shifted into their fruiting pots, which need not be more than 11-inch. Some growers give them two shifts, but I have found this unnecessary. This time the same kind of loam should be used, with the addition of a good sprinkling of fine bones. I have found them act quicker than larger pieces; and when twelve months is about the time that strong plants require to occupy their fruiting pots, the advantage of giving them what they can obtain most benefit from in that period is obvious. In potting, at least an inch of space should be left for watering, as when done it should be a good soaking.

No water should be given after shifting till the new soil has a good number of roots in it. The bottom heat should be kept at from 80° to 85°—a genial temperature maintained in the house, allowing it to run up to 85° in the daytime with sun, and keeping the night temperature about 65°. If the temperature is about 70° at the close of daylight it will be quite sufficient. Syringing and damping-down must be attended to, but by all means avoid a stagnant atmosphere; admit a little air whenever such can be done; examining the plants for those that are showing signs of fruit, selecting them and placing them where they can be pushed along as required occasionally. If only one house is devoted to Pines this selecting should still be practised, as it is much better to have all the fruiting plants together. When the fruits are approaching maturity syringing and damping must be discontinued, and watering also. When the latter is practised after the ripening stage has begun the fruits are sometimes found bad in the centre.

During winter those plants intended to start about January or February should be rested for a couple of months—November and December. The temperature need not be more than 65° by day, and as low as 55° by night. All temperatures and the amount of moisture maintained in Pine stoves must be regulated by the outside conditions. No hard-and-fast rule can be laid down. When the weather is cold and dull a correspondingly low temperature and drier condition of the house should be preserved. These and other things can only be learned by observation and attention. A steaming atmosphere and great fire heat in dull cold weather are to be avoided.

The Queen is the best for fruiting during the summer. Smooth Cayenne is best for a winter supply. Black Jamaica is a good variety for winter, possessing a fine flavour. Charlotte Rothschild has proved good both in winter and summer. Where only one house is devoted to Pine-growing it will be extremely difficult to maintain a succession of fruiting plants; still, by potting suckers at different times, and selecting the most forward for the warmest end of the house—should there be such—much can be done to forward some, and when approaching maturity much can be done to retard, if such is desired, by removing to a cool house or any other cool place. The extensive grower does not need so many makeshifts when he has his sucker-pit, his succession and fruiting houses. Extra good suckers well cared for can be made to produce fruit in about twelve months, but more ordinarily it is from fifteen to eighteen months. Old stumps of such a kind as the Smooth Cayenne, which does not show suckers freely, should be plunged among sawdust or fibre in a good bottom heat, when a good supply of suckers can generally be obtained, which can be potted as required.

Pines are sometimes subject to scale and mealy bug. Never having been much troubled with either of these pests on Pines, I cannot from experience recommend a cure, but there are several receipts given by others for the eradication of these pests. Finally Pine-growing is simple enough when certain conditions are main-

tained, keeping up a continuous succession of fruit being one of the most difficult matters, as conditions of weather often upset the most careful calculations, and sometimes hasten when such is not wanted, in other cases retard when that is not desired.

Overwatering, overpotting, overcrowding, oversteering, and overshadowing are all to be guarded against. Indeed, shading has been very seldom practised by me, and then only with newly potted plants. Liquid manure in the form of guano water should be used when the plants have rooted well in their fruiting pots; of course in a weak condition, as when strong, the roots suffer. When the plants are resting during the winter two months may elapse before they need water, and when given the soil should be stirred up, and firmed round the edges of the pots, as it sometimes shrinks from the sides, when the water would simply round down without wetting the ball at all.

There are numerous other matters which might be descanted upon, but enough has been said, I trust, to enable anyone about to start Pine-growing to comprehend the requirements.—J.]

THE COLOURS OF FLOWERS.

(Continued from page 55.)

THE foregoing observations and facts adduced are sufficient to prove that, with a few exceptions that can scarcely be said to invalidate the general rule, Decandolle's opinion was not so erroneous as at first sight might appear to be the case. The subject is, however, an interesting one, and we may pursue it a little farther with some advantage, commencing with a few

COLOUR STATISTICS

In the following remarks it must be borne in mind that, though pointing to some curious facts, they have no direct bearing upon that portion of the subject already discussed. The previous observations chiefly had reference only to the changeability of species individually, but we may now consider the relative proportion of colours in different genera. Of course these can only be regarded as groups of allied species, of similar value to the larger groups of tribes, sub-orders, and orders under which plants are arranged, and it is to this circumstance that the bearing of the facts here named is quite different from those first advanced. I have carefully examined the majority of the cultivated species (nearly three thousand) included in 240 genera, distributed over the whole vegetable kingdom, and as a result I have obtained the following numbers, indicating the relative proportion of colours, which may be taken as fairly representative of the general characteristics, as the largest and most distinct genera possessing coloured flowers have been selected for the purpose. Of the 240 genera, 39 include species bearing blue and yellow flowers, 57 have purple and yellow-flowered species, 26 have blue but no yellow-flowered species, 28 purple without yellow, 105 yellow without blue; but as the latter includes the 57 purple and yellow-flowered genera, there are only 50 genera with yellow flowers, but without blue or purple. Thus there are 96 genera comprising blue and yellow tints, and 124 in which either is exclusive of the other, the remaining 20 containing neither colour. In reference to the large number in which there is a combination of colours, it must, however, be observed that of the 1626 species comprised in the 39 genera possessing blue and yellow flowers, 981 are blue-flowered species, and only 221 yellow-flowered—an extraordinary difference, and upon which some remarks will be offered later on. Red (including scarlet, rose, and pink) and white are comparatively evenly spread over the two series; but the former appears to be more frequent in the xanthic, and white in the cyanic groups, though the latter occurs in nearly all the larger genera.

In regard to the comparative proportion of colours several observers have recorded some curious results, but the most striking are those given by Köhler and Schubler, who examined four thousand species in twenty-seven natural orders, and ascertained that 1193 had white flowers, 957 yellow, 923 red, 594 blue, 307 violet, 153 green, five orange, and eight nearly black. It has also been remarked that amongst five hundred members of the Rosæ family blue is not found, nor yet in the 1300 Myrtle allies, whilst red is unknown in the five hundred Campanulaceous plants, excluding varieties obtained in cultivation. Further attention will be devoted to these peculiar facts when discussing the merits and defects of the latest dissertation upon the colours of flowers—viz.,

MR. GRANT ALLEN'S THEORY.

Any consideration of the facts bearing upon the changeableness of colours and the laws determining their combinations in flowers would be incomplete without some reference to the theory recently advanced by Mr. Grant Allen first in the *Cornhill Magazine*,

and subsequently at greater length in *Nature*. He divides the subject into five parts, under the heads—1, Origin of Petals; 2, General Law of Progressive Colouration; 3, Variegation; 4, Relapse and Retrogression; 5, Degeneration; and under these heads a large number of interesting facts are discussed most ably, and afford abundant matter for reflection upon a curious and perplexing subject. The following is a general outline of his argument and the facts by which it is supported. First, the petals of flowers are considered to be metamorphosed stamens "which have been set apart for the special work of attracting insects;" and "as the stamens of almost all flowers, certainly of all the oldest and simplest flowers, are yellow, it would seem naturally to follow that the earliest petals should be yellow too." This transition of form and function is illustrated by reference to the Nymphaeas, Roses, Mesembryanthemums, Orchids, and other cases in which it is found the stamens are converted into petals or organs serving a similar purpose. Under the second head—"The Law of Progressive Colouration"—a mass of facts are advanced, and the following conclusions are arrived at—namely, 1, "Most of the very simplest flowers are yellow," the simplest flowers being described as those in which there is little or no irregularity or combination of petals, stamens, or carpels. 2, "Many of the simpler flowers in each family (except the highest) are apt to be yellow;" highest here meaning those in which the greatest modifications occur. 3, "The more advanced members of very single families are usually white or pink." 4, "The simpler members of slightly advanced families are usually white or pink." 5, "The most advanced members of all families are usually red, purple, or blue." 6, "Almost all the members of the most advanced families are purple or blue." 7, "The most advanced members of the most advanced families are almost always blue, unless spotted or variegated." It will thus be seen that Mr. Grant Allen attributes the range of colours found in flowers to their different stages of modification, commencing with yellow in the most simple, and advancing to blue in those that have been greatly changed by cross-fertilisation due to insect aid, especially bees, which, according to Sir John Lubbock, have a great preference for blue and purple shades. Before discussing the evidence on this point it may be well to mention that under the head "Variegation" are considered a number of apparent exceptions to the above rules, but in which different shades of colour are seen in one flower either in streaks, spots, or blotches, and indicate a corresponding modification, though in a different direction; while a number of other seeming anomalies are referred to as examples of "relapse, retrogression, and degeneration."

The whole subject is most admirably and fairly treated, but several portions of it appear to me slightly defective, and some thoughts upon this I must reserve until another occasion.—
L. CASTLE.

(To be continued.)

MY SUBURBAN GARDEN.

(A COLUMN FOR AMATEURS.)

My last "column" I perceive extended nearly to a page. I regret to have put so much pressure on your space, but experience will enable me to estimate more correctly. I must own I was surprised by the length of my last letter, and I will endeavour not to transgress so flagrantly again. As intimated, I have a little more to say on glass structures. I am confident from past experience and mistakes that this subject is one of the first importance to amateurs, and I venture to think has not received the attention it deserves.

The side lights of my plain but useful span-roofed greenhouse I have said are not of real service, and I may as well state the reason for arriving at this conclusion. Desiring to utilise the wall on the south side I planted Tomatoes along the base and trained them up the brickwork. They grew well, but I soon found that a height of 2 feet 9 inches was not sufficient for making the best of them, so they were trained up the glass as well, or altogether a height of 4 feet. Now, although the glass was hidden the plants in the house grew quite as well, and were in every respect as satisfactory as during the previous year, when the side glass was exposed; in fact, the Tomatoes did not shade the plants materially, but only the pots, and I thought this an advantage rather than otherwise in hot weather. The light from the roof proved quite sufficient for the plants.

My next advance in building was another step towards greater simplicity, as I determined to have no side lights, but simply brick walls and a glass roof. I remember just at that time visiting Mr. Bull's new nursery and inspecting the ranges of span-roofed houses of, I apprehend, the most approved kind, and was a little amused, though I said nothing at the time, to see boards

elevated on pots as close to the roof as possible at the base of the rafters, so that the banks of plants should slope to the path. "What is there to be amused at in this?" does someone ask? Well, nothing; and perhaps "amused" is not the proper word. Still it was curious to see side lights employed for lighting the inverted pots supporting the plants, for they served no other purpose, except, perhaps, facilitating the escape of heat from the house. As I did not wish to burn fuel to warm the outer air, preferring to leave that to the sun, I decided on the course adopted, and I have had no cause to regret having done so. The house or pit affords me great delight, as one division supplies me with Cucumbers and Melons, the earlier plants followed by Tomatoes; and the other contains plants of various kinds that need more than a greenhouse temperature, such as Gardenias, Bouvardias, and Tea Roses for buttonholes in winter, with Begonias and sundry other plants that my family and friends admire.

This house is the same width as the other, but the walls externally are only 2 feet high, while the path in the centre is sunk 18 inches, the height from the floor to the roof being 8½ feet; thus the majority of the plants on a flat stage are nearer the glass than if the angle were more acute, though a deeper pitch might perhaps be better for fruit-growing. In one division are side stages, and the other pits with means of affording bottom heat when more is needed than is afforded by fermenting materials; but these I prefer, as cheapest for use and best for the plants. This is a capital house, and has a most valuable adjunct outside—so valuable that I would urge its adoption by all amateurs. There is nothing whatever novel about it, but, on the contrary, it is the essence of simplicity, while it is economical and efficient. It is simply a lean-to frame or pit running along both sides of the house. All that was needed was to run a wall 4½ feet from the house and parallel with it, and cover the intervening space with glass. The front wall is only a foot above ground, but a little excavating was done to afford head room for the plants. A flow pipe in the house was pierced, and an inch gas pipe attached, which was connected with a 3-inch pipe taken along the front of the pit, and attached to the pipe in the house at the other end in a similar manner. A valve enables me to turn the heat on and off the frame at will. If anyone can suggest a simpler, cheaper, and better method of making and heating a pit they will do good service by recording it; and those who have frames of this kind will, I am sure, admit their value. Calceolarias and Cinerarias, Cyclamens and Primulas, Bouvardias and Mignonette, bulbs and Lilies, Pelargoniums and Solanums luxuriate in them, and thus the frames prove feeders for the houses; and one of them will, I am expecting, afford me a "feed" by-and-by of new Potatoes grown in pots, and another of Beans, for I dabble in almost everything in my endeavour to "always have something;" but it is certain I could not have what I have without these handy little lean-to pits.

Under the stages of the warm house or pit are stored Caladiums, Gloxinias, Achimenes, Gesnerias, and Tuberos Begonias, as I find they keep better there than in a cold house. On examining them I find they are quite fresh and sound, and must soon be started into growth. It was from here my Christmas Rhubarb was had, and Seakale is now ready. Under the stage of the cool house are stored early Potatoes, also Dahlias and flower pots, while good crops of Mushrooms are had sometimes, these as a rule bothering me and my factotum more than anything; but we are improving.

I intended referring to outside affairs this week, but feel I am encroaching, and I must tell another time of my mountain of gold.—M. D.



AMONGST other damage caused by the storm of last Friday, the WINTER GARDENS AND CONSERVATORY AT SOUTHPORT suffered considerably, portions of the roof being blown in, and workmen had to be called up during the night to shore up the front facing the sea. The Botanic Gardens and National Schools also suffered. The wind was so violent during the night that it resembled the reports of artillery, and rendered the streets almost impassable.

— RELATIVE to TURNER'S INCOMPARABLE CELERY, a correspondent expresses his surprise that such an experienced culti-

vator as "A Kitchen Gardener" appears to be, should intimate on page 26 that this and Sandringham White are distinct varieties, and thus lead inexperienced readers to purchase two packets of seed of the same vegetable.

— MR. B. S. WILLIAMS, Upper Holloway, sends us blooms of PRIMULAS RUBRO-VIOLEACEA and CHISWICK RED, both exceedingly fine varieties, the former being of a very rich purplish crimson hue, and the latter bright red with a decided tendency to scarlet. The blooms are large, of good form, and very freely produced.

— AT the annual dinner of the Committee of the Wimbledon and District Horticultural Society, held last Friday, a pleasing PRESENTATION WAS MADE TO MR. J. LYNE, gardener to A. Schlusser, Esq., Belvedere. The testimonial took the form of a handsome plated tea service, and on the teapot was the following inscription:—"Presented to Mr. John Lyne by a few members and friends of the Wimbledon Horticultural Society in appreciation of his services as a member of such Committee, January 26th, 1883." Mrs. Lyne was afterwards presented with half a dozen silver spoons.

— THE ANNUAL DINNER of the workmen employed by Messrs. R. E. Crompton & Co. and Messrs. T. H. P. Dennis & Co. at the Arc Electric Light and Anchor Iron Works, Moulsham, took place at the Public Hall, Moulsham, last Saturday evening. Mr. F. A. Fawkes presided at the dinner, being supported by Mr. G. Kapp, Mr. Thos. Thompson, and Mr. W. A. Kyle. After dinner the chair was occupied by Capt. Crompton, who was supported on the platform by those already named and by Mr. J. Luckin. Mr. S. Sudworth was in the vice-chair. After the usual toasts had been proposed and suitably acknowledged a pleasant evening was concluded with a musical entertainment.

— GARDEN APPOINTMENTS.—Messrs. J. Carter & Co. state that the following appointments have been recently made through them:—Mr. A. H. Wright to be head gardener to J. V. Hornyold, Esq., of Blackmore Park, Upton-on-Severn; and Mr. Geo. Stuart, head gardener to C. Howard, Esq., Woodcote Lodge, Shere, Guildford. The late Mr. Ward has, we are informed, been succeeded by his son as gardener at Stoke Edith.

— WRITING on the 29th ult. "A Northern Amateur" says:—"The EFFECTS OF THE WEATHER we have had in Perthshire for some time is to be seen. In my garden the buds of fruit trees and bushes are swelling, and Roses are moving. I see on a south wall shoots about half an inch long on a plant of Charles Lawson, and a plant of Maréchal Niel which has been slightly protected is also pushing. During the last week Snowdrops are in flower, Crocuses are showing their tips, white and red Hepaticas, the first laced Polyanthus, and one plant among seedling Primroses are in bloom. On the 27th they were covered with 3 inches depth of snow, which soon began to thaw on the low grounds, although the hills all round are still white, and we have again a repetition of wind and rain. I lately had a plant sent me; the name on the tally is not very legible, but seems to be *Primula glaucescens*. The foliage is unlike that of any of the other Primulas I have, and I cannot find it in any catalogue. Can any of your correspondents give me any information as to such a variety beyond the colour implied in the name?"

— AN American contemporary has the following respecting the LILY OF THE VALLEY:—"The flowers of the Lily of the Valley, universal favourites, are used during the winter months in great quantities in our large cities and towns, New York city alone probably using a million, the average price of which is about five cents each, so that for this flower alone 50,000 dols. is annually paid by the bouquet makers of one city to the florists, the consumer, no doubt, paying from one-third to one-half more. The

Lily of the Valley is nearly all imported from Germany and France, usually in single crams or "pips."

— THE fifty-fifth annual report of the MANCHESTER BOTANICAL AND HORTICULTURAL SOCIETY states that several important changes have been carried out in the garden during the past year. During the past year the old range of houses has been removed, and five new houses, 300 feet long, have been erected in a position further back than the old ones occupied. The erection of these houses and the labour consequent upon the removal of the old buildings has caused an extraordinary outlay of about £1400. The number of new life members who joined during the year exactly corresponded with that of the preceding year, while the income from two-guinea subscribers is four guineas in excess. About £1000 was awarded in prizes during the year to encourage the cultivation of plants, flowers, fruits, and vegetables, and so numerous were the exhibits sent in that much difficulty was experienced in finding accommodation for them. Another feature of the increasing public utility of the Society is the assistance afforded to botanical students (professional and amateur), to artists and others. A series of botanical lectures was given during the summer months by Mr. Leo Grindon, to the evident satisfaction of the members present. The Council state that the large exhibition house in which the exotics have been exhibited for the last thirty years is in a very unsafe condition (unfit to hold another exhibition in); consequently they have resolved to remove the present structure, and to build a new one about one-third larger. It is estimated that the cost of the proposed new exhibition house will be about £2000, and it has been resolved to make an effort to secure one hundred additional life members to cover the expense. A life member's ticket is £20. The income for the year has been £4204, and the expenditure £5384.

— PARTS 26, 27, 28, and 29 of Messrs. Cassell's re-issue of "PAXTON'S FLOWER GARDEN" contain coloured plates of the following plants, in addition to the woodcuts in the gleanings and original memoranda:—*Oncidium variegatum*, a pretty species with bright pink flowers, borne in a loose panicle. *Jonesia Asoca*, an East Indian tree, included in the natural order Leguminosæ, but very distinct from the majority of that family; the flowers are orange-coloured, fragrant, and borne in dense terminal heads. *Pleione maculata* and *P. lagenaria*, two well-known dwarf Orchids, the former with white sepals and petals and a rose-striped lip; the latter differing chiefly in the sepals and petals being purple, and the flowers rather larger. *Veronica Andersonii*, a hybrid raised from crossing *V. salicifolia* with pollen from *V. speciosa*, from which a beautiful race of Veronicas has been obtained. *Vanda tricolor* is represented by a good plate, and is accompanied by an enumeration of the species. *Aponogeton distachyon* is also faithfully depicted. *Berberis Darwinii*, undoubtedly the most ornamental and useful of the genus, is well shown. *Salvia gesneriæflora*, a favourite rich scarlet-flowered Sage, which is closely allied to *S. fulgens (cardinalis)*, and is especially valued for the brilliancy of its long tubular flowers. Much interesting information is given in the gleanings, through the additions in the present issue do not appear to be very numerous.

— MANY readers of this Journal will welcome the work just commenced by the publishers of the above, entitled "FAMILIAR WILD BIRDS," which is illustrated with coloured engravings, and accompanied by descriptive letterpress in a similar style to the "Familiar Wild and Garden Flowers." The plates are admirably executed, the two in the first part representing the Goldfinch and Magpie. This work will undoubtedly become as popular as the other serials already noticed.

— WE have been shown some specimens of FLORAL PHOTOGRAPHY executed by Mr. Henry Stevens of the well-known firm

of J. C. Stevens of King Street, Covent Garden, which are marvels of the photographic art. Landscape photography has long attained to high perfection, but the most difficult of all photographic manipulation was to properly represent flowers. All attempts in this direction which we have seen are unsatisfactory; but those that Mr. Stevens has succeeded in producing are of such a nature as to be works of art of a very high order. In all the floral photographs we have seen there is either flatness or a want of definition, and unless all the parts were brought into the same plane or focus some of them are foggy while others are sharp in their outlines. In these productions of Mr. Stevens' there is a depth and decision which amount to perfection, and no artist with his pencil could produce a more faithful representation of his subject. What struck us most on examining some of the photographs, and especially those of Orchids and Lilies, was the remarkably faithful representation of the texture of the floral segments: indeed so well was this done that even the transparency was shown, and one could fancy without any effort that transmitted light was shining through the substance of the flower. In this respect these photographs far surpass the efforts of the most skilful pencil artist, and even the best colourists fail to convey the effect produced by this style of photography.

— “AMONG the rarities in flower at Glasnevin just now,” says the *Irish Farmer's Gazette*, “a little gem deserves special notice. This is a DIMINUTIVE EPIPHYTAL TILLANDSIA, of Pine Apple aspect, growing on a piece of wood no thicker than a finger, and the plant itself so small that a pill box would cover it. The leaves have their surfaces glistening as if beautifully frosted with silver, and from their centre rise a slim pair of narrow, tubular, glossy purple, Crocus-like flowers, each not thicker than a crow quill, and crowned with gold in the shape of the yellow anthers, which rise just barely above, and contrast strikingly with the colour of the flowers. The plant and wood, we fancy, would scarcely weigh half an ounce.”

— A CORRESPONDENT of the *New York Weekly Tribune* recommends SWEET BRIAR AS A HEDGE PLANT when strengthened by wire. “The Sweet Briar has all the merits attributed to the Barberry or Privet, the Buckthorn, or the Japan Quince. Cattle do not eat it, it is not subject to insect injury, it does not sucker, but makes as thick a base as the Barberry and will grow in as thin and dry ground. It is equally hardy, its thorns and leaves even more numerous, and although the foliage is paler it is only the more distinct for that. The fruits or hews are bright red and showy. The peculiar and special merits of the Sweet Briar as a wire-hedge plant, are that the leaves have a penetrating and delightful fragrance, that it soon grows up, and that it requires the least trimming of all, as it does not exceed in height the stature proper to a hedge, and not sprawl about, but grows erect, trim, and full of shoots from the base. But its stems are not stiff enough, and did not interlace enough or thrust out new growth laterally to fill a gap so quickly as to serve as fence against cattle without the aid of a wire.”

ABOUT WATERING.

“How often should it be watered?” is a question frequently asked by the proud possessor of a small window plant, and the surprise is genuine when it is found that no practical man will give a simple straightforward answer to the question. Indeed, the fact of being practical seems to stultify the power of giving a simple answer, and it is questionable if the late Robert Thompson, the talented author of the “Gardener's Assistant,” within the last ten years of his life ever gave a simple answer to any question on the subject of pomology, and I suppose no other man living then knew more about that science practically as well as theoretically. But I remember Mr. Barron, the present Superintendent for the Royal Horticultural Society, asking Mr. Thompson in my presence and for my especial benefit (telling me beforehand the sort

of answer he was likely to get), a simple question as to the best means of eradicating insects from a fruit house.

Mr. Barron had previously put the same question to me, as he had a query from a correspondent on the subject. I gave my answer straight without a moment's consideration, and was astonished that so clever a man as Mr. Thompson should hesitate to do so. But such was the case. The question is much easier for any of us to answer to-day than it was then; but although I do not claim to have got very far up the ladder on which Mr. Thompson stood at the top, I begin to think that what are apparently little questions are not so easily answered as I once thought.

For what purpose is water supplied to plants?

The question I know will appear to many readers to be an absurd one to ask of those who have a water pot in their hand every day, but I must acknowledge my inability to give it a complete answer. I will, however, answer it as far as I can, and that will bring me to another question—How and when should water be applied?

Water is an indispensable plant-food. A large portion of the plant itself is water; a certain amount of supply, then, is necessary for building up the plant. But this, it may be said, is only a very small percentage of the quantity it is found necessary to give to the roots of the plant. Next, transpiration, or the exhalation of moisture from the leaves, is a necessity of a plant's healthy existence, which takes place more or less according to the state of the atmosphere, the extent of the leaf-surface, and the nature and condition of the plant, as well as of the soil in which it is growing. In the open air the quantity of water evaporated by plants is very large, in some districts it is said to be even in excess of the rainfall; but of this I have no proof, and I am not aware that we have any record of experiments to determine the relative amount of evaporation from plants in our houses compared with those grown outside, but I should imagine the ventilators will regulate that to a great extent.

Then we know that a plant cannot extract food from a soil which is too dry, even though the foliage should be kept from drooping, and a plant when allowed to droop is of course visibly suffering, and, with the exception of the actual feeling, may be compared to a horse which after a hard day's work is taken out to work all night without its supper; in other words, forces are being used up which ought to be accumulating, and this state of things cannot last any more than the business of a man who, finding the interest of his capital insufficient, is continually drawing on his accumulated principal.

There is probably nothing new in what I have said so far on the subject. I feel there is much more which ought to be said, but I dare not at present trust myself to commit it to paper, as I am only beginning to learn a little about it, and should be glad to be informed where I may read up the subject in its physiological aspect. But there is one point mentioned on which I can enlarge somewhat, and I will introduce it by asking another question. How is it that if I take a particular plant under my especial care with regard to watering, and allow it to share all the rest of its treatment with the other plants in the house under the charge of an assistant, that my plant is very likely to excel?

The answer is to be found in the fact that I should take care always to anticipate the wants of my plant. I would no more allow it to flag than a careful nurse would allow a patient to cry out for the necessaries of existence. I would take to know my plant well; it should never have water when it did not want it, and when it did want it, it should have abundance. You would never see me running with the water pot after the sun had been shining some time. My plant is looked to in the morning or in the evening after the sun has gone down, and is prepared to utilise the sunshine to its fullest extent when it comes again. If it shines brightly all day and the pot is getting full of roots probably another supply will be necessary, and if not I shall take care that it is always prepared for any sort of weather. Anyone who will allow a healthy plant indoors to flag, or will give it some cold water after the sun has been shining on it some time, is not fit to be trusted with one.

So long as a plant can be kept sufficiently moist the less number of times it is watered the better, and were I able to attend to a houseful of plants myself I would have the pots both glazed and without a hole for drainage. I have frequently with advantage corked up the bottom of a pot after it had become full of roots, but I have looked after the watering myself.

There is scarcely a limit to which softwooded plants may be grown in a few months if all their wants are anticipated. As an instance I may mention that on the only occasion I have shown plants, some Fuchsias were struck from cuttings in December and exhibited at Dorchester during the first week of the following June, several of them being 6 feet through and as much high. To

my mind—but perhaps I am not an impartial judge—these plants having been grown without stopping or tying, were the best Fuchsias I have seen, but they travelled badly and lost many of their blooms.—WM. TAYLOR.

BOSSIAEA TENUICAILIS.

SEVERAL Bossiæas are in cultivation, but they are comparatively rarely seen except in large collections of plants. Yet they are well entitled to a foremost position amongst the best of the Australian Leguminous plants, as they are mostly free in growth and astonishingly profuse flowerers. Two of the most handsome and useful are *B. linophylla* and *B. tenuicaulis*, the latter being represented in the illustration (fig. 22). *B. linophylla* is a slender shrub with linear leaves and bright yellow flowers, which are pro-



Fig. 22.—*Bossiæa tenuicaulis*.

duced from May to September. *B. tenuicaulis* is rather more straggling in habit, with ovate leaves, the flowers being rich yellow streaked with red. It also flowers earlier than the other—usually during April and May. Both these, like all the others, thrive in a greenhouse temperature, a compost of peat and turfy loam and sand, with good drainage, being all the attention needed.

NOTES ON CHRYSANTHEMUMS.

LATE VARIETIES.

MUCH discussion has taken place in the Journal on the varieties of Chrysanthemums most suitable for late-blooming purposes, some writers naming amongst others the following as "Chrysanthemums to bloom from Christmas to the middle of January:" Fair Maid of Guernsey, Cherub, Arigena, Mrs. Haliburton, Hero of Stoke Newington, Princess Teck, Sarnia, Ethel, Grandiflorum, Madame Lemoine, Oracle, Baron de Prailly, Striatum, Guernsey Nugget, Meg Merrilees, &c.

It would have been well if we could have learnt from those who have lauded any varieties for their late-blooming qualities what treatment those varieties have been subjected to during the later

autumn months, for experience has taught me that the lateness of blooming of any variety is more affected by the time that the growth was made and the buds formed than with the nature of any particular kind. Some varieties are, it is true, later to bloom than others when subjected to exactly the same treatment, but there is not that difference in the time of their blooming as the teachings of some growers would lead the inexperienced to think. The names of fifteen distinct varieties are given above, and have appeared in print during the past week or two as having produced flowers late in January. How many of them could not have been found plentifully distributed among the exhibition prize stands in the middle of November? I will venture to say that fourteen out of the fifteen named would be found in almost any detailed account of an ordinary exhibition. The only variety I exclude is Arigena, and this is not that it is a late-blooming kind, but because it is unfortunately too rough and coarse to be admitted in any stand of good flowers. If this is so how can they be properly termed "Christmas" or "January" varieties, unless a special or different treatment is brought to bear on any of them to prevent them blooming during November?

I consider Fair Maid of Guernsey to be an early-flowering sort, following always very close after Elaine, which is the earliest of all the Japanese forms. Cherub and Mrs. Haliburton, if not early bloomers, are by no means late; the first will frequently be found in collections at exhibitions, the later not so often, as the blooms are somewhat small or medium-sized. Hero of Stoke Newington and Princess Teck are counterparts of each other, differing only in colour of bloom, and are both useful varieties and late in blooming, but not so late but that they can be had in November. These same remarks apply to all the others named, Grandiflorum and Meg Merrilees being the latest of these. Mr. Tunnington exhibited at Kingston in his stand for the challenge vase one of the finest blooms of Meg Merrilees I have ever seen, and that was about the middle of November.

I will now give my views respecting retarding the plants, and desire that all who have produced flowers late to state their treatment. It is well known amongst Chrysanthemum growers that to produce the large flowers seen at exhibitions the crown terminal bud is selected, and all others on the same shoot or growth are pinched off. Now, it sometimes happens that from various causes the point of a shoot may be "blind"—that is, no fully developed bud is to be found there, and when this is the case other shoots are made later in the season which bloom very late. This in my opinion is one way to obtain late flowers; another way is not to disbud the plants but get as late a growth as possible. Where a supply of flowers is wanted about Christmas there are many persons who plant out during the summer months numbers of such varieties as Princess Teck, lift them in the autumn, pot and house them. By this means they get a plentiful supply of useful flowers from Christmas to the end of December, or even later. I have at the present time (January 22nd) several flowers on Meg Merrilees, Red Indian, Arlequin, &c., that are merely side flowers, produced from buds that were not pinched out at the time of disbudding, and have formed after the growth was arrested by selecting the crown terminal bud.

Almost any of the varieties will produce flowers from the laterals if allowed to do so, but exhibitors generally very carefully rub off all these as they show, in order to throw the strength into the bloom that is selected on the crown of the shoot. It is but a very short time since the Japanese forms were all considered not to bloom until very nearly Christmas, and when the Royal Horticultural Society offered prizes for competition this was reserved until their December meeting. Now we are accustomed to see them amongst the very earliest to bloom, and why? Simply because they are disbudded to bloom early in November. If these notes are of any service, or may cause other growers to state under what circumstances they are able to produce late flowers, or if they consider the varieties named are to be termed late-flowering kinds, I shall not have penned them in vain.—J. W. MOORMAN.

P.S.—When I penned the above lines I had not the remotest idea that a paper was so soon to appear on this subject, and it will seem I had anticipated some of the remarks of your correspondent "A Grower" on page 67, but in a few particulars we vary in opinion. The value of the Pompon Snowdrop is not overrated by him. The perfect imbricated character of its miniature Camellia-like flowers renders it not only one of the most useful but also one of the most attractive varieties in cultivation, and only wants to be grown once to be appreciated. Souvenir de Jersey, although rightly described by your correspondent with respect to colour, &c., does not belong to the Anemone section. Isabella Bott and Fleur de Marie are both grand varieties in their respective sections, but there are many others that are more free to bloom than either of them.

I have never found that the Japanese are worse to keep than the incurved section. I have found that there are certain varieties in all the sections less liable to damp than others. What is the cause of the complaint of some flowers damping, or, indeed, decaying at the earliest stages of their blooming? Has not high feeding with artificial manures much to answer for this? Many of the varieties named by your correspondent have excellent qualities, but *Laciniatum* is more curious than useful; it is, to say the least, a shy bloomer, of small size, and is surpassed by numbers of others.—J. W. M.

[Accompanying this communication were several blooms, the majority of them Japanese.]

MY BOX OF TWENTY-FOUR.

[By C. H. HAWTREY, condensed from the "Rosarians' Year Book.]

"ETHEL comes this afternoon, so please be in about four o'clock—don't forget."

Ethel Craven is my niece—stay—let me first re-introduce myself, John Briggs, of the Lodge, Crawford, and my wife, who has just spoken.

Ethel is the daughter of my eldest sister, who years ago married the vicar of a country parish in Cornwall. My brother-in-law is a first-rate fellow, but, like many a country parson, he is not blessed with a superabundance of this world's goods.

Capital friends are my niece and myself, for we have a common bond of union—namely, Roses. And it is partly to this that we owe the pleasure of her visit at this time of the year, for at the end of this week the Great County Rose Show is to be held at Cattham, which all the world knows is the principal town of Marlshire, where the Assizes, the Hunt Ball, and the Agricultural Shows are held—and I wish to have the benefit of her aid and good taste. Besides the classes for Roses, which are, of course, to my mind the principal part of the show, there is a prize for the best table decoration, and in this particular line Ethel is very difficult to beat.

"No," I reply, "I won't forget—I think I'll just go out now and have a look at the Roses."

Smart is now my gardener; and since he has been with me the garden has indeed thriven. How Greybridge could have parted with such a treasure I cannot think.

I find Smart busily engaged with two lads brushing green fly off the Roses.

"Good morning, Smart. How are the Roses? Do you think we shall show well on Saturday?"

"Oh, us'll be right enough, sir. The best of 'em 'll have to be prntty handy to beat we this time."

"Remember, it's a box of twenty-four. We've never been so ambitious before."

"Ah, but then you see, sir, you've so many more to pick and choose from this time. 'Taint as if we was how we was at the 'Parliss.' Us was terrible bad there, sir. Just an orsight long o' they others."

Smart must mean "eyesore" I think; but I cannot agree with him that our Roses were that, though I own they were not good.

"Well, Miss Ethel is coming to stay this week, so she will help us and do the table decoration."

"Is she now? Well, I be main glad to hear that, sir."

On my way back to the house I meet James Greybridge coming across the lawn. James is to dine with us this evening. I trust he is not going to disappoint us, as there is nothing that upsets Mrs. Briggs more than having the arrangements of her little dinner parties disturbed.

"Morning, old chap," he cries. "Thought I should find you muddling away at the Roses, so came straight out here. Got anything to do on Thursday?"

"Thursday, let me see. No. We're disengaged on Thursday?"

"Well I wish you'd do something for me. You know we've got a cricket match for Thursday against Murchison's people. Quite forgot that I'm engaged to play lawn tennis at old Boffer's. Got a sporting match on with old Tiddywhack himself. Can't disappoint Boffer, you know. Would you mind just seeing after the cricket match for me?"

"And now," cried Ethel, "do let us go out to the Roses. I long to have a good chat with Smart."

The interval until it was time to go in to dress for dinner was most agreeably spent by Ethel and myself. There were the blooms to be inspected; the new Roses too, and the Briars that were nearly ready for this year's budding.

Of course the great object of interest was the prospect for the following Saturday. We could count fifteen or sixteen buds which we thought would be just right; and if the weather was hot why there would be plenty more. If it was cold, then we hoped that the more forward buds would not be gone by.

The prospect was hopeful. A thrill of pride and anticipation was making my blood tingle, when I was startled by a cry from Ethel.

"Good gracious! Uncle John, what have you got here! I didn't think it of you. I didn't indeed."

I was at this time inspecting a bud of A. K. Williams, which I had been counting on, and which to my disgust I found had lately been

devoured on the under side by a grub and rendered perfectly useless. I hurried on at once.

"What is it?" I asked.

"Look," she said. "I wonder what Mr. Camm would say."

Well, they were beautiful plants. Nobody could deny that. And I dislike Paul Neron as much as anybody does; but then an exhibitor must grow as many sorts as possible, and even Paul Neron is not to be despised when you don't know how to make up your box.

"Ah," says Smart, "wery prutty I calls it, sometimes. You minds, sir, when—"

"Pretty, Smart!" says Ethel; "it's hideous!"

There they stood, eighteen great fine plants. The foliage was splendid, and one or two huge blooms appeared amidst it. But these blooms were as nothing compared to what were to come. The buds were like cricket balls; and I noted the fact privately, and I know that Smart had noted it too, that they would be "in" on Saturday. And if it should happen that we should be short, of course—why, we should have to—well, there was no need to say anything about that at present.

"Uncle John, can't you get Mr. Greybridge as a favour to accept these plants next autumn? If not, we will subscribe and pay someone to take them. Or, as a last resource, we might send them to Major Milman to be planted in the west of Ireland."

* * * * *

The next day I am quite myself again. Well, yes, I confess I am excited about to-morrow's contest—awfully excited. The weather has been favourable, and I certainly never had any Roses to compare with these. Ethel and I are having a quiet look at them this evening, and we can cut to-morrow morning.

Good gracious! Here comes Greybridge; what on earth does he want? He hangs about me like an influenza cold at Christmas-time.

"Good evening, Miss Craven," he says. Then turning to me, "Well, old chap! Now for the Roses!"

* * * * *

We walk down the cinder-path which divides the Rose garden. Presently we come to the Paul Neron. Well, upon my word, they are wonderful: one has often seen them like saucers: these are like soup plates. Coarse! I should think so! I was going to say that coarse is not the word. But it is; that is just exactly what it is. Coarse is the only word that describes them. Utterly, frightfully, hideously coarse.

James eyes them; he stops; he leaves the path. He walks round those eighteen plants; then he looks up at me and says, with great solemnity,

"Briggs, old chap, you'll win that cup to-morrow. I'm blown if you won't."

* * * * *

Smart and I got the twenty-four ready, while Ethel was preparing for the dinner-table decoration. James followed her about, held flowers for her, and, in short, did exactly what he was told. I don't suppose anybody who knows James will believe this; but I can't help that. It is a fact. He did what he was told.

Only once did he take any interest in what Smart and I were doing. It was when we came to the Paul Neron. He walked across to see them cut. I passed them.

"Hullo," he said; "ain't you going to cut these?"

"No," said I; "I don't think we shall want them."

"Humbug!" he answered; "you won't win the cup without these. Cut them at once, Smart," he went on in his old imperious manner.

"They'll do for spares, sir," said Smart to me, apologetically. I am aware that Smart has a sneaking fondness for the hideous monster.

So they were cut and put into the spare box.

Everything was ready in good time, and I was in high spirits, for the Roses surpassed all my expectations. It must be a real good Twenty-four to beat me to-day.

* * * * *

I gloated over every bloom. How exquisite the *Devoniensis* looked between Prince Camille and Charles Lefebvre. The grub-eaten A. K. had quite gone by, but here was another, rather small perhaps, but such perfect form. There was not another Catherine Mermot in the show like mine; of that I was certain. And then Emilie Hausburg, so much undervalued by those who don't know a good Rose when they see one, and so much prized by those who do.

And these were only some of the especial beauties in my Twenty-four. Marie Baumann was grand; so was Louis Van Houtte; the Baroness splendid; Thomas Mills a marvel of brightness. In fact there was not a bad bloom in the box. No room for Paul Neron here. It would have been a real case of Beauty and the Beast.

"Well, Smart, what is it?" I asked.

"Come to see how you was a-getting on, sir," answered Smart. "They don't seem to want I down there, so I come along."

"Not much doubt about the cup this time, Smart," I exclaimed.

"No-o, blesh you, sir. We're right t'is time. I see'd 'em a looking precious sly at we when the cover was took off of the box."

"Ah, well, there's many a slip," said I, trying to control my excitement; but the fact was, we were clearly best—at least, I thought so—clearly, clearly best.

The bell rang. One last look, just to see that the names were all right.

Then we went out of the hall to spend that tedious hour-and-a-half as best we might, while the judges had it all their own way."

"Everything comes to the man who knows how to wait," even admission to a flower show.

It came; and again we entered the hall. The dinner-table decoration was in the centre of the room, right opposite to us as we entered.

"What is it? First Prize! Bravo, Ethel! Well done!"

There was Greybridge, standing by the table as pleased as Punch. Leaving Ethel with him for a moment, to admire her own work and to hear the remarks of unknown spectators, I hurried on to my Twenty-four. The fact was, I felt that I must see it alone first of all. My excitement was too great.

There was the place. Aha! it must be all right. There was quite a big crowd round my box already. I hurried on.

Hullo! What could there be to laugh at? Why! They were roaring! Shaking their sides! In fits of laughter!

"Smart," I called out in some little alarm, "Smart, what is it?"

"Oh, it wasn't right," said Smart, shaking his head.

It clearly was not right. I never saw Smart's face so long in my life.

"What is it? For goodness' sake tell me what we've got," I almost screamed.

"Dis-qualified," answered poor Smart.

"What?" I shouted.

"Go and see, sir," said Smart; and he turned away. His feelings were too much for him.

I made my way as best I could through the crowd, and reached my box. I could not believe my eyes. Where were the Devoniensis, the Prince Camille, the A. K. Williams, the Catherine Mermet, the Emilie Hausburg? Gone! gone! gone! And in their places were five huge hideous Paul Nerons! the labels were unchanged. Was it any marvel, then, that on my box lay a large card, with "Disqualified for Duplicates" written on it in great black letters?

Five Paul Nerons, all named differently! Two actually put side by side, and called Prince Camille de Rohan and Devoniensis! No wonder the judges and everybody else laughed till they cried.

I couldn't speak. I knew all about it at once. Only one man in Europe could have done that thing. He stood before me.

"Well, old chap," he said, "I did the best I could for you, but there's no satisfying these beggars. Cheer up! You never could have won with the things I pulled out of the box. So there isn't much harm done after all."

"What is the matter?" asked Ethel, as she came up.

"Five Paul Nerons in my Twenty-four, Ethel," I said in my misery.

If my look was one which ought to have slain Greybridge, the look which Ethel gave him was one which apparently very nearly succeeded in killing him outright.

"Mr. Greybridge, I'll never forgive you. Never in all my life. Never!" and she evidently meant it. "Go this moment to the Committee, and explain what you have done; and ask Mr. D'Ombraim to come and speak to me."

By this time Mr. D'Ombraim had come upon the scene, and in two minutes more the hateful "Disqualified" card had disappeared, and had been replaced by one on which was printed "Extra Prize."

"Good afternoon, Mr. Greybridge," said Ethel, with the coldest little bow imaginable; and then she turned short round. "Let us go," she said to me; "I don't want to stay any longer."

And home we went. As we were in the train, I could not help feeling sorry for poor James, and I told Ethel so.

"Uncle John," she said, "you are the kindest old thing in the world." And I thought I saw a tiny tear glistening in her eye.

When I got home, I sat down at once and wrote a note:—"Dear James—Come and dine this evening, I am sure you meant it all for the best. Yours sincerely, JOHN BRIGGS."

The answer was not long in coming. "Dear Briggs—I think you are the best fellow I know. Thanks, old chap, a hundred times. I'll come. Yours ever, J. G."

He came, and was forgiven. Yes, in spite of everything. A very pleasant little party it was; just James and ourselves. After dinner we went into the drawing room, and first we had a little music. Then my wife, I am sorry to say, began to nod, and in two minutes she was fast asleep. It is a shocking habit that she has, and I do all I can to break her of it; but I am afraid she rather enjoys it.

I myself never go to sleep in the drawing room. I make a great point of always keeping awake, so that I may be conscious of setting a good example to Mrs. Briggs. But on this occasion—I really don't know how it was (I had been up very early, you see, and had been through a very trying day)—well, on this particular evening I believe I did drop off too. I had only been asleep for a minute or two—in fact, I believe I had only just closed my eyes—when I woke with a start. James and Ethel were not in the room. The next minute I heard their steps on the gravel outside. They came in.

"Oh! Uncle John," said Ethel, kissing me, and looking wonderfully pretty, "it is such a lovely night."

"Ethel, dear," said my wife, waking up, "it's time for bed."

James Greybridge came into my room for a smoke and a chat. We talked for a long while; in fact, it was past one when he rose to go. As for our conversation, I need not give it in detail. The tenor of it may be gathered from the last remark which James made to me.

"By Jove!" he shouted, as he slapped me on the back; "what a lark! I never thought of that!"

"Thought of what?" I asked.

"Why, you'll be my uncle John!"

CHRYSANTHEMUMS AT KINGSTON.

ON reading the remarks by Mr. T. H. Bryant last week I referred to what I said about his plants at page 29, and I do not find there any "unfair" remarks or anything "devoid of truth." What I do find is a harmless criticism of the large plants exhibited by him, and if he is afraid about his plants being criticised he ought not to send them to a public exhibition. Anyone reading my remarks would naturally believe his plants were not in competition, at least I intended they would have that meaning. Mr. Bryant may think his plants were the best in the exhibition; I think they were not the best, and because I was unfortunate enough to express my opinion Mr. Bryant accuses me of making unfair statements, and also statements utterly devoid of truth. I know nothing of Mr. Bryant—I did not even know the name of his gardener before I saw it in print, and beg to say that I am not jealous of his plants, and said not a word but what I believed to be strictly in accordance with facts. I hope I have the right both to express an opinion and also to differ from Mr. Bryant, with whom I do not intend to enter into any controversy.

"Oh, wad some power the giftie gie us
To see ourselves as others see us,
It would from many a blunder free us
And foolish notion."

—J. DOUGLAS.

NOTES FROM MY GARDEN IN 1882.—No. 1.

GLADIOLUS.

SEVERAL letters that I have received privately from correspondents who want to know when I am going to give these notes convince me of the fact that they have some degree of interest for many of your readers. As certain manuals of health teach us what to eat, drink, and avoid, so the lessons of horticulture are as much what we are not to do as what we are to follow; and yet there are some cases in which all our failures seem to advance us no whit further in the avoidance of them for the future. Conspicuously is this the case with the Gladiolus. I have now been a grower of it for five and twenty years; I have watched it narrowly in my own garden and in those of friends for that length of time, and I honestly confess I am just as far from understanding them as we are from understanding the cause of the Potato disease and suggesting a remedy. And now to my experience of last season.

I was very much struck at the Great Exhibition at Manchester with some magnificent spikes exhibited by Mr. Thompson of Newcastle, and especially to find amongst them some of the older flowers which I had never seen in such good form. On inquiring of them as to their method of culture they informed me that they planted the corms in pots first, and then turned them out into the open ground in April. As I had tried various plans, none of which had been of the slightest avail in preventing loss, I determined to try this plan, although it involved some trouble, and I reserved one bed for this purpose. I had a considerable number of corms imported from France, some of Mr. Kelway's, and some of my own saving; and having some good, sound, fibrous loam about 140 were planted in pots and kept in a cool house. They started well, and when they had grown about 6 inches and were looking very promising they were planted out with great care about 6 inches deep, and nothing could be more satisfactory to a grower than the regular-looking condition of the beds. I had from them some magnificent spikes of bloom, but I had, alas! also a large number of failures. They spindled for bloom, they opened their flowers well, and then withered. I mention this because Mr. Kelway attributes some of the failures to the corms being exhausted by seed-bearing. In other cases the plants never bloomed but withered away, the foliage turning yellow and brown. When the corms were lifted they were found to be more or less spotted, the outer skin rough and thready (if I may use the expression), and the base of the corms from whence the roots proceed quite black. The degree of the decay differed, but I have always found that it proceeds rapidly, and, no matter how the corm is treated, it is utterly useless. I think there was probably less loss in the imported ones, but the difference was not very great, and this disposes of the idea that there is no such loss among the growers abroad. Thus out of two dozen imported corms of Meyerbeer I only lifted a dozen sound ones. Again, it showed that the idea of English-raised and English-grown Gladioli

being hardier is a fallacy. I may, while on this very disheartening view of the situation, mention that my friend Mr. Banks of Sholden, who was the largest amateur grower in England, and who for many years had fought manfully a losing battle, has at last been obliged to confess himself beaten, and after having lost fifty thousand plants in two years has finally given them up. Nor can I look forward very hopefully to the coming season. The heavy and continuous rain in the autumn months has made the

difficulty greater. I have no doubt that the corms are not sufficiently ripened; indeed in a letter from my friend M. Souillard of Fontainebleau he says they have had a great difficulty in securing their bulbs. It must be remembered that size is no proof of soundness. I remember once lifting four corms of Madame Desportes, each of which weighed a quarter of a pound, and every one of them failed when planted.

I have again tested the plan of cutting the corms in halves,



FIG. 23.—CHIONODOXON HOOKERIANUM. (See page 98.)

securing an eye to each section, and am quite satisfied that it is the best plan to adopt where they are of sufficient size, for it secures a better bloom, and you are just as likely to lift good-sized corms as where they are left whole. It may be asked, What about the other beds in which the Gladioli were planted in the usual way without having been grown in pots? There was but little difference, the upshot of all being that, although I planted

four hundred bulbs, I did not lift more than two hundred sound exclusive of seedlings. Nothing is to be learned from the success of these. The vigour with which they start, like that of the young man, lasts them for awhile, but after a year or two they fall into the same bad way and perish. Here again one traces a similarity to the Potato. How many varieties are advertised as disease-proof! and so they may be for a year or two; but they

very soon show that this is simply a condition of their youth, for after awhile this character is no longer appended to the description of their qualities.

What then? Are we to abandon their culture altogether? We hardly like to do that, and there are two things in our favour. In the first place the prices of really good varieties have been so much diminished of late years by the French growers that fine varieties can be obtained for a trifle, Meyerbeer, Schiller, Eugène Scribe, Norma, Le Phare, and others of good exhibition kinds included amongst them. We do not mind giving sums like these for Hyacinths, which only last for the season, or for *Lilium auratum*, which very often dies after its first year of blooming; and so we may be content to grow our *Gladiolus* on the chance of getting a season's bloom out of them. It may be very discouraging, but I think that we must accept the inevitable. Then there is another hope for us—the reproduction of the varieties by the spawn or small corms which are formed round the base of the corm in all sorts of odd ways. These should all be removed, put into small paper bags, and then sown in the early spring. I prefer to sow mine in pots, and then when they have started well to turn them out into the open ground. Others, where the quantity is large, sow them in drills in the open at once, having properly prepared the ground previously. Some varieties produce these small corms very freely, others very sparsely indeed, and hence some which have been in commerce for many years are still as dear as they were. I have taken off one plant of Horace Vernet one hundred small ones, while I have taken up a dozen of Adolphe Brogiart without obtaining a single cormlet.

There were some fine flowers amongst those sent out from Fontainebleau last year. Opale is of a peculiar fresh colour; Mount Etna and Flambozante are fine scarlet flowers; while Mdlle. Marie Verdale is a fine salmon-coloured flower, striped with vermilion and scarlet; but the season was unfavourable for judging of the merits of these new flowers. Mr. Kelway, as usual, sent out a goodly number of varieties, and doubtless there were some fine flowers amongst them; but I have not had an opportunity of seeing them.

My first notes are not very encouraging, but one must speak the truth; and when I see good people narrating their success I am inclined to say, "Let not him that putteth on his harness boast against him that putteth it off." Let him bide a wee, and after three or four years' time he will join in the assertion that the *Gladiolus*, beautiful and striking though it is, is a trying and disappointing flower.—D., Deal.

CRINODENDRON HOOKERIANUM.

THIS very distinct and beautiful evergreen shrub (fig. 23, p. 97) is botanically related to the Lime, but in general appearance possessing no resemblance whatever to that well-known tree. It is a native of South Chili, where, however, it is by no means abundant, and whence it was first introduced by Messrs. J. Veitch & Sons, Chelsea, in 1880. As might be expected from the locality in which it is found, it requires very little heat, and a greenhouse temperature suits it admirably. It can be grown in a compost of peat, loam, and sand, the two former in equal proportions, and sufficient of the latter to render the soil porous.

The leaves are lance-shaped or narrowly egg-shaped, the flowers being produced singly or in pairs from the axils of the leaves, and have been not inaptly compared to *Lapageria rosea*, particularly in colour and texture. They are pendulous and freely produced along the branches, giving plants of moderate size a very striking appearance. It was certificated at the Royal Botanic Society's Show, May 19th, 1880, where it was greatly admired by the visitors. It was there shown under the name already given; but it has been subsequently determined to be *Tricuspidaria hexapetala*, but this title is not generally known.—C.

HYACINTHUS CANDICANS.

THIS with its Yucca-like foliage and handsome spike of white pendant bell-shaped flowers is deservedly becoming popular, as any doubt as to its hardiness has been happily dispelled; and blooming at a season when flowers of the character are not plentiful it becomes valuable, the flowers being produced successively over a lengthened period. It flowers in late July or early in August, and prefers a light rich soil, but will do well in most soils that are well drained, and it should be planted 4 to 6 inches deep. Solitary plants have a poor effect compared with those in clumps of a dozen or more. A mulching of well-decayed manure or leaf soil round the plants in autumn and pointed-in in spring will greatly benefit them.

Plants for conservatory decoration are not numerous in August,

and this grown in pots, a dozen in a 9 or 10-inch pot are very effective. Good turfy loam with a fifth of well-decayed manure, and a sprinkling of sand will grow them well, placing the roots so that the crowns will be covered 2 inches deep. The pots should be efficiently drained, as they require plentiful supplies of water when in free growth. In winter they may be plunged in ashes outdoors, and be grown through the summer in an open situation but sheltered from winds. The plants must be supplied with water and liquid manure, removing them indoors when the spike appears if wanted early or when the first flowers expand. If wanted to flower late they may be retarded by placing them in June at the north side of a wall, and they may then be had in flower as late as September.—G. ABBEY.



[By the most skilful Cultivators in the several Departments.]

KITCHEN GARDEN.

GROUND should now be prepared for Parsnips, and the seed may be sown the first time the soil is in favourable condition. A moderately rich deep soil is the most suitable. They grow luxuriantly in a very rich soil, but it is in this they are most liable to rust and decay in autumn. The rows should be from 18 inches to 2 feet apart, and the drills 2 inches deep. By putting three or four seeds down every foot or so a little batch of plants will be secured, and much less seed will be used than when all the row is sown.

Garlic and Shallots may now be planted. We treat them both alike, and put them into rich open soil in rows 1 foot apart and 6 inches from plant to plant. A small hole is made for each bulb with a blunt-pointed dibble, and the soil is not drawn in again, but the bulb is surrounded with a handful of river sand, which keeps it snug and fresh until growth begins.

Cabbage plants raised from seed and planted in their bearing quarters in the autumn promise, owing to the mild weather, to be unusually early. They succeed best in winter when the ground is very firm about the roots, and we have sometimes been afraid to disturb them too early, as to loosen the soil to induce them to grow more rapidly not unfrequently makes them "bolt;" but at present we would advise their being all examined, filling any blanks and drawing a little soil to the stems of the early batches. Plants which are too late for any special time or purpose should have the soil loosened among them with a fork to encourage their speedy growth.

More Peas should be sown, and the earliest kinds are still the most suitable. The most favourable positions should also be selected for them. At this time we give great attention to cropping along the borders near walls, and all available space here is being filled with early tender spring crops. These consist of Potatoes, dwarf Peas, Cauliflowers which have been wintered in frames, Lettuce, Radish, &c.

More Broad Beans should be sown. As yet we have not sown our main crops, but only a few rows between Gooseberry bushes, which is generally a sheltered position for them at first. A sharp look-out must now be kept for slugs. Gathering with the hand and slight dustings of soot and lime frequently applied are sure means of keeping them in check. Earth up and stake all Peas which are visible above ground, and keep all surfaces between growing crops clean and open with the Dutch hoe. Remove decaying vegetables to the refuse heap, and manure or lime and dig or trench every empty space.

Rhubarb and Seakale are advancing in growth in the open ground, and it is not now necessary to lift these for forcing, as they will come rapidly on if covered with their pots, or any old box or barrel, and hotbed manure. Cauliflower plants in frames should now have abundance of air admitted to them, that they may be well hardened previous to being transferred to the open quarters. Lettuces may be treated in the same way.

In the forcing house attention must be paid to Cucumbers, Tomatoes, Vegetable Marrows, &c. Those which have now formed a few rough leaves should be potted, keeping them as near the glass as possible. Sow more seed of the things just named. Kidney Beans may be placed in their fruiting pots as soon as they are large enough; good drainage and a rough soil suits them best. Sow successions every fortnight. Do not syringe any which may be coming into flower until the pods have been formed.

Peas may be brought forward under glass if sown in strips of turf or small pots, but to secure any advantage in this way they must be kept very near the glass and in an airy atmosphere. A pinch of early Celery seed should be sown in a pot or box, and kept in the forcing pit until the plants are half an inch high, when more air and less heat will benefit them.

The general stock of seed Potatoes must now be examined. Where they have been heaped together in rather a close place many of the lowest will have made long growths, which are of no use, and it is with the object of removing these and spreading the whole out thinly that they should be looked over. Only the short stubby growths should be allowed to remain, and if they can all be spread out in a single layer exposed to light and air they will be found to be in excellent order at planting time.

FRUIT-FORCING.

Strawberries in Pots.—Plants in flower should be watered on the mornings of fine days, keeping the leaves and flowers raised by one hand, and also to keep the crown from being saturated, the latter being often injured by the constant application of water over it. The air of the house should be dry for a couple of hours each day, so as to secure a favourable condition for fertilising the blooms, which is expeditiously done with a feather duster daily, until there is a good crop set, after which all superfluous flowers and deformed fruit should be removed. Introduce more plants to a Peach or other houses about to be started so as to maintain the succession of fruit after it once comes in, and see that those advancing for flowering are free from aphides, which sometimes harbour in the crown ready to infest the rising leaves and trusses.

Pines.—The fruit of Queens and other varieties for the summer supply of fruit will be emerging from the centre of the plants, and in order that these may be produced well above the foliage every encouragement should be given by prompt attention to watering, bottom heat, &c., with a night temperature of 65° to 70°, and about 75° in the daytime, by artificial means. In this and the fruiting department the heating apparatus must of necessity be almost always kept constantly hot, and on account of this aridity of the atmosphere results unless the ordinary means of syringing or sprinkling be pursued; therefore take advantage of such times as the pipes are coolest to saturate the surroundings. In light structures the plants will need to be syringed more frequently than in damp ones, but the necessity for syringing may be ascertained by examining the base of the leaves; if the axils contain moisture none need be given. Take advantage of suitable opportunities to have materials in hand for making up or renewing exhausted beds, and for potting purposes.

Peaches and Nectarines.—Late varieties still in flower in the earliest house should have the flowers dusted with a camel's-hair brush daily, keeping the house moderately dry with ventilation until the flowers show signs of falling and the skins are being cast, when gentle syringing with tepid water should be resorted to twice a day. Proceed cautiously with disbudding and shortening shoots that were left full length at pruning time. Remove the foreright shoots first, commencing on that part of the trees which are the most vigorous, and finish with the weakest or horizontal parts. Keep a sharp look-out for aphides, fumigating as soon as the pest appears, but be careful not to give an overdose, or there is danger of the tender foliage being injured, especially if it be moist. See that the roots are properly supplied with tepid water, or weakly trees with tepid liquid manure. Trees in succession houses approaching the flowering stage should be treated precisely as advised in former calendars for the earliest house, continuing to syringe well until flowers expand, and do not omit to fumigate before that when the trees are dry. Buds very thickly studded on the under side of the shoots should be removed before they expand. Where there are a number of houses another may now be started to give ripe fruit by the middle of July. Late houses should be kept as cool as possible by free ventilation.

FLOWER GARDEN AND PLEASURE GROUND.

Planting and Treatment of Hedges.—Should mild weather continue the present is a good time to plant hedges of any plants except Hollies. The latter, which forms by far the best evergreen hedge, should not be planted till late in March or early in April. The next best for a hedge with regard to appearance is the common Yew, and this is particularly well adapted for formal hedges sometimes considered necessary for dividing purposes in the pleasure ground. Quick Thorn and Privet mixed will form a neat and fairly strong hedge, but the former alone would be the strongest, while Privet alone will offer little obstruction. For enclosing extensive pleasure grounds and plantations we prefer a mixture of Quick Thorn and Beech; the latter retaining its

foliage nearly the year round, and therefore serves as a screen or cover, grows freely, and is easily managed. Whatever may be employed it is imperative that the ground be both manured and deeply dug. Neglect this precaution and the probability is, in the majority of places, a good even hedge will never be secured. Carefully plant in double lines about 12 inches apart, and 12 inches asunder in the rows and angled. If strong plants of Yews are obtainable these may be planted at wider intervals, so that each plant touches its immediate neighbours. It is not absolutely necessary to cut back either Yews or Hollies in the earliest stages, both naturally forming good bottoms; but the other kinds, notably the Privets and Thorns, should at this time of year be cut down to within 5 inches of the ground the first season after planting, repeating the operation with rather less severity the next two seasons. By this plan only will a substantial hedge with a sufficiently strong bottom be secured. To further induce vigorous growth the ground on each side of the young hedges must be annually lightly dug, kept perfectly free from weeds, and mulched if no manure was given prior to planting. When trimming well-established hedges, and which in the case only of Privet, Thorns, and Beech to be now completed, the Scotch plan of forming them wedge-shaped—that is to say, with a wide bottom and the top brought up to a point, insures strength where most required—viz., at the bottom, and is besides very neat in appearance.

Early Cuttings of Bedding Plants.—Where a large number of bedding plants are required the stock of Verbenas, Lobelias, Ageratums, Heliotropes, Alyssums, and Abutilons may now be introduced into a warmer house than that they were wintered in. This will induce them to produce fresh shoots, which will be found to strike more readily and surely than the hard old growth. The common practice of striking most of the foregoing thickly in 5-inch or 6-inch pots in the autumn, and wintering them in this condition is a mistake, as they soon become starved and produce fresh growth in less quantities and much inferior in quality to that obtained from more liberally treated plants. Verbenas especially ought to be wintered thinly in boxes and in a cool house, and if the cuttings when inserted were clean and healthy they will form vigorous plants. From these in the following spring can easily be obtained abundance of good plants, which will grow healthily and flower freely during the season. Cuttings struck from diseased insect-infested plants are useless, and will inevitably disappoint the grower. Any stock plants much root-bound will be greatly assisted by occasional supplies of liquid manure.

Preparing Manure for Hotbeds.—A heap of fermenting material should now be prepared for propagating and other purposes for which hotbeds and frames are largely employed. A mixture of leaves and stable manure gives a sufficiently powerful, and, at the same time, comparatively sweet heat. The latter this season, owing to the half-decayed state of the leaves, should, in order to remove rank heat, be well shaken out and thrown into a heap, allowed to remain a week or longer according to circumstances, then returned and again allowed to heat rapidly for a similar time prior to the leaves being mixed with it. The leaves will sweeten and moderate the heat and increase the bulk. The rough manure obtained from a cow yard, if slower in preparation, is powerful, and much sweeter than the horse yard manure. The roughest of the latter may well be spread in the cow yard for a time.

PLANT HOUSES.

Forcing House.—If the principal heat in this house has been derived from fermenting material, and has cooled considerably, some fresh leaves and litter should be introduced, and the whole turned over and thoroughly mixed. The length of time leaves and litter supply heat entirely depends upon the condition of the material when the bed is made. If wet it heats violently for a time, but will not last long; on the other hand, if moderately dry and properly prepared by frequent turning, the heat is very steady for a long period, and a few barrowfuls of fresh material soon revives it when declining. Avoid placing such plants as Spiræas, Ghent Azaleas, and similar plants too soon on fermenting beds that have been re-made, for if the ammonia thrown off is strong the tender foliage will be injured. There will be no fear of this if the bed is properly made to start with, and renewed from time to time as indicated above. The moist genial heat derived from leaves, &c., is preferable for forcing plants into flower than dry heat from hot-water pipes.

Introduce from time to time, according to requirements and demand, Lilacs, Deutzias, Prunuses, Dielytra spectabilis, and the many other plants suitable for forcing into flower early. Before placing the varieties of Azalea indica in heat examine them carefully, and if there is or has been any thrips upon them wash them thoroughly with a solution of tobacco water and soft soap, to which has been added a lump of common washing soda about

the size of a cob nut to each gallon of the mixture. Thrips spread rapidly upon plants in heat, and will injure these plants when in flower.

Rhododendrons multiflorum, Gibsonii, Nobleum, and caucasicum varieties will come readily into flower if placed in heat, and will succeed Early Gem and præcox. Plants of the latter that have been kept in a cold house are coming into flower, while the latest batch that have been plunged and are still outside are swelling their buds rapidly, and will be allowed to open under cool treatment. All plants forced should be introduced in time, so that they can be allowed to open their flowers in a temperature of 45°. Not only are the flowers more natural in colour, but they last nearly double the time either on the plant or in a cut state. All plants from the present time that have been started for a week or two in a temperature of 45° will come forward rapidly in the forcing house, which should be kept 55° to 60°, according to the weather. Syringe the plants in this house twice daily, giving air when favourable, and close the house early, so as to husband as much sun heat as possible. Dutch bulbs of every description will come forward very fast from the present time, and fresh batches should be introduced every week or ten days to maintain an unbroken supply. Keep them close to the glass, and remove them into a much lower temperature as soon as the first flowers open.

Imatophyllum miniatum and its varieties should now have their flower spikes well advanced in a cool house, and if wanted early place them in heat; if not, allow them to open in the cool. When it has flowered, if this plant is assisted to make its growth under the influence of heat, and then kept cool afterwards, it will open its flowers naturally during the winter and spring months. Single plants in from 5 to 7-inch pots are the most serviceable for decorative purposes, and large plants can be split up directly after flowering, and placed in single pots if necessary. These plants will do in the same pots for a number of years with liberal feeding, providing the drainage is good, or can have the old soil shaken from them annually after flowering, placing them in the same size pots with new compost, which is preferable.

THE BEE-KEEPER.

DOES AUTUMN FEEDING CAUSE BEES TO RECOMMENCE BREEDING?

A CORRESPONDENT of the Journal has lately suggested a fuller expression of opinion on this subject than we have had; and if I understood his letter he thinks that the weight of evidence given by experienced men is not in favour of autumn feeding being practised for the object of getting a late hatch of brood. In this thought we agree with him, believing that the most successful bee-keepers of Great Britain do not feed their bees in autumn merely to get late hatches of brood. But does autumn feeding cause queens to recommence laying after the regular season has passed?

At the end of the Clover season, say at the end of July or beginning of August, many hives or queens cease to breed; and when taken to the moors about the 12th of August during a glut of honey recommence breeding, and fill their hives with brood from side to side. If bees in August and the beginning of September be constantly and vigorously fed they will recommence breeding. The weather then is not cold, and pollen is abundant. But August is not an autumn month as understood by bee-keepers. The Clover season in Scotland does not end till the middle of August, when the rich Heather begins. Take a hive in the middle of September a month after the queen has been resting and barren, and begin to feed it in moderation, say 1 lb. sugar per day, and watch the result. Probably not more than one queen in four so treated will recommence to lay even if surrounded with peameal and barley bannocks. It is unnatural for queens to lay at that season, and hence the artificial attempts made to overfeed queens and cause them to lay often fail. We do not follow or recommend such artificial practice in order to get hatches of brood. That hatches of brood are sometimes obtained by artificial feeding we know very well. Even when obtained they are comparatively small and hardly worth the cost and trouble of their production. Another consideration, not important, is this: Does a late hatch exhaust and weaken the queen to a certain extent, and prevent her from laying so early in spring as she otherwise would do? This question we cannot answer with certainty, but we hesitate not to say that the more

closely the lines of Nature are followed the better it will be for bees, and probably also for their masters.

The process of creating stocks in autumn from bees of honey hives, and from those snatched from brimstone pits and sold as condemned bees, I have lately explained; but I may here say that if such bees are put into empty hives in August or the first half of September and then fed vigorously the bees build combs rapidly, and great sheets of brood are generally produced; but if this work be attempted later in the season it is more difficult of accomplishment, as the bees sit more closely together, less inclined for work, and more reluctantly build combs—such combs being thick and dumpy, built to hold syrup and not brood. The queens, too, want rest, and it is a difficult matter to bring them into a state of pregnancy.

Our system of autumn feeding practised for fifty years is easily explained and understood. The bees of honey hives are preserved and united to the stocks marked for keeping, thus making them numerically strong. Even the brood in the honey hives is preserved, hatched, and utilised in the same way. Such strong stocks require much food from September till April. If they have not enough honey in September we give them sufficient syrup then, and give it to them rapidly. Our feeding boards hold from 4 to 6 lbs. of syrup each—that is, from two to three quarts. And our bees in September can take and store up three quarts in a day easily. But why feed them so rapidly? Because we care nothing about a late batch of brood, and know well that in rapid feeding in autumn there is less consumption and waste of food. Slow and continuous feeding is desirable in spring when breeding commences, and when once begun it should be continued and encouraged by the administration of food; but in autumn things are different. Robbers abound, pillage is the order of the day, and hence the quieter hives are kept the less food is consumed and fewer lives are lost. In ordinary seasons good hives require about 15 lbs. of honey or syrup to keep their bees from September till March. If bees are kept comfortably warm in winter, the less they are then disturbed by feeding the better.—A. PETTIGREW, *Bowdon.*

INTRODUCING QUEENS WITHOUT ENGAGING.

It is well known that a serious loss is occasioned to a colony of bees, especially in early spring, by the exchange of queens through the stranger being caged for forty-eight hours, or even a less time. The colony does not only lose the eggs that might have been produced during that time, but the sudden check imposed upon a full-laying queen by being imprisoned, throws her back so much that she does not recover her usual fecundity for some days. Imported queens will often not lay at all for the first few days; and the original sovereign having been deposed or destroyed, the colony suffers the loss equivalent to an average swarm before the new arrival is in good order for laying.

This has been so strongly impressed on my mind that for a long time past I have been experimenting, in the hope that I might ultimately be enabled to dispense with the introducing cage entirely. I am happy to say that I have succeeded beyond my expectations, and the method is so simple that the only wonder is that I had not thought of it sooner. Colonies with fertile workers, or those that have been long queenless without brood (as they are sometimes found in early spring), cause me no trouble whatever, as I can give them a laying queen without her ceasing her work except for the few moments that she is being transferred from one hive to another. When a queen is sold with a swarm another can be immediately inserted, and the queen of one colony can be exchanged with that of another without confinement, and none of the bees of the respective colonies will know the difference.

It is generally known that the bees of one colony may be united with those of another by alternating their combs, and there is no disposition to fight. Having always succeeded in uniting them thus, I came to the conclusion that a queen on a comb with her own bees and brood would be taken no more notice of than the others, and this I have proved to be the case by continued and unvarying success. Taken from one hive and placed in another while parading among her own subjects and without being handled, the queen takes no notice whatever of the change, and thus her unconcerned behaviour saves her from any rude inquisitiveness. I have introduced them under all the respective conditions before mentioned by this means, and I have not met with a single failure; and during the last two seasons I have been saved a large amount of extra work by this method, besides a considerable gain in increase in bees. As soon as the comb, queen, and bees are inserted the job is done, and I never trouble to look at the hive again until its turn comes in the ordinary course of manipulation.

The foregoing applies, of course, to queens reared in the same

apiary when taken from nuclei or other hives with frames all of one size, as should be the case in a well-conducted apiary. If a nucleus cannot afford to lose the comb of brood taken from the queen it is easily replaced by one from some other colony. When queens come from other apiaries the mode of procedure is slightly different, though a state of things somewhat similar has to be introduced. An imported queen will never lay vigorously for the first few days, therefore it might be said, What delay would there be in encaging her? There would be considerable delay if the present laying queen were at once deposed.

To make the most of the queens first secure as many combs of hatching brood as there are queens to be introduced, and after cleaning them of every bee place each in a nucleus hive with a tight-fitting division board on either side, put the queens in, and close each so that no bees can get out, but give ample ventilation. Now put these nuclei into a moderately warm room for two or three days, when, many young bees having hatched and the queens nearly recovered from the effects of their previous confinement, each nucleus may be stood by the side of the hive its queen is to be introduced to, and the bees allowed to fly for a day or two before being united to the full colony. As soon as the imported queen is laying nicely on her one comb the condemned queen can be removed and the former inserted on her own comb with the bees at one and the same operation, and no notice will be taken of her. By reserving the condemned queen till the moment the other is introduced the colony receives no check whatever. The single comb is quite enough for the new arrival for nearly a week, as, after her long confinement, she is some days before getting into full laying order. It will be observed that instead of the usual way of allowing the bees to find out their loss, the exchange is completed before they are aware of the occurrence.

I have no doubt many will still cling to the cage, but no advancing bee-keeper can afford to lose so much valuable time at the beginning of the season. My experience bears me out in stating that there is absolutely no risk whatever in introducing in this way, even in what might be thought most obstinate cases.—SAMUEL SIMMINS (in *The American Bee Journal*).

TRADE CATALOGUES RECEIVED.

- John Green, Thorpe, Norwich.—*Catalogue of New and Rare Plants.*
 Louis Van Houtte, Ghent, Belgium.—*Catalogue of Gesneriaceous Plants.*
 W. P. Laird & Sinclair, Dundee.—*Catalogue of Vegetable and Flower Seeds.*
 W. Lovel & Son, Driffield, Hull.—*Select List of Strawberry Plants.*
 Edmondson Brothers, Dublin.—*Spring Catalogue of Vegetable and Flower Seeds.*
 W. Wells, Redhill.—*Catalogue of Vegetable and Flower Seeds.*
 Daniels Brothers, Norwich.—*Illustrated Guide for Amateur Gardeners.*
 E. Webb & Sons, Wordsley, Stourbridge.—*Spring Catalogue, 1883.*
 Thomas S. Ware, Tottenham.—*Catalogue of Florists' Flower and Hardy Annual Seeds.*



** All correspondence should be directed either to "The Editor" or to "The Publisher." Letters addressed to Dr. Hogg or members of the staff often remain unopened unavoidably. We request that no one will write privately to any of our correspondents, as doing so subjects them to unjustifiable trouble and expense.

Correspondents should not mix up on the same sheet questions relating to Gardening and those on Poultry and Bee subjects, and should never send more than two or three questions at once. All articles intended for insertion should be written on one side of the paper only. We cannot reply to questions through the post, and we do not undertake to return rejected communications.

Vine Eyes (*H. S.*).—No. 1, too small and immature; 2, decidedly the best of all, but too much pith, and bud too pointed; it would make a fairly good but not a strong fruiting cane. 3, Not good, far too much pith; 4, worthless. If you have sent us a fair sample of wood your Vines are not in good condition. We can only give brief replies to letters that reach us after Monday, and will answer your further inquiries next week.

Tuberoses (*Reader*).—If you want flowers as soon as possible plunge the pots in a bottom heat of 80° to 85° at once, the top heat not to exceed 60°. Burying the pots in cocoa-nut fibre refuse in a cool pit or greenhouse for a few weeks, then plunging in gentle bottom heat, is perhaps a safer plan, but the plants do not flower quite so quickly. If you send your questions late you can

only expect short replies or no reply at all until the following week, as in the case of your second question.

Propagating Conifers (*H. Scott*).—Larches and Silver Firs are raised from seed, which can be obtained from most large vendors. All the other kinds you name may also be raised from seed, but we do not know whence you can obtain it. They are also propagated from cuttings in the manner described in vol. iii., page 215, September 9th; page 262, September 21st; and page 319, October 6th, 1881. It is impossible to give in this column instructions so full as contained in the numbers referred to, and which can be had from the publisher for 10½d. in postage stamps.

Sawdust for Plunging Purposes (*Idem*).—We have frequently used it both in pits and frames, and have never found any inconvenience result from its use. Stirring it occasionally prevents the growth of fungus, and if any should appear it can be destroyed with boiling water.

Pine Apple Discoloured (*Lindfield*).—It is not unlikely that the fruit has been injured by tying the plant roughly and too closely. We have seldom tied up the plants at all, and the practice in question, however convenient it may be, has certainly been abused, and both plants and fruit injured. We are of opinion, also, the plant has had too much water, and possibly liquid manure may have been applied too strong and too near the ripening period. No water ought to have been given after the first symptoms of colour were visible, and if you continued it longer, and kept the atmosphere also too moist, this would, in a great measure, account for the condition of the fruit of which you have sent us a sample. Thus, we suspect, that both rough handling and over-watering have contributed to the unsatisfactory result, of which we have seen several similar examples from the causes indicated.

Pelargoniums Diseased (*Idem*).—The cause of the disease is not known. It is indicative of some inherent weakness in the plant, induced, probably, by defective root-action at some time. Possibly the roots of your plant are not in a very active state now. The best method of treatment is to cut the plant pretty closely down, and it is just possible the subsequent growths may be healthy. If they are not prepare the plant for the open air, and in due time plant it out in good soil and a sunny position. If this does not cure it nothing will, and it will be advisable to destroy it. We never propagate from plants similarly affected.

Protecting Fruit Trees (*F. J.*).—The method you propose will answer very well, and better if supplemented with a broad coping board, and the poles need not be more than 2½ or 3 feet from the bottom of the wall. We prefer moveable blinds sufficiently stout to exclude sharp frosts, only covering the trees when required, and cheap canvas we have found answer well. If the covering is fixed then hexagon netting is useful as affording some, and often sufficient, protection; while at the same time light and air are not excluded from the trees. Everything should be in readiness for covering the trees when the first blossoms are approaching expansion. If the Vines do not break regularly bend down the canes as you show in the sketch. We cannot account for your Cinerarias withering. They are rather apt to collapse suddenly, but the cause appears obscure. Plants that were much rootbound before their final shift are usually the most liable to be affected in the manner indicated.

Raising Galtonia (Hyacinthus) candicans from Seed (*D. Somerset*).—Seeds of this plant germinate very readily in mild bottom heat, and you will experience no difficulty in raising a stock if the seeds are fully mature. Sow them in pans of sandy soil, and as soon as the seeds have germinated and made some progress transfer them singly to small pots, when they can be placed in a cool house and subsequently planted out in a border. Any light rich soil suits them, but they appear to much better advantage when planted in clumps than if singly.

Ardisia crenulata not Flowering (*X. F. Z.*).—Your plants have probably made too vigorous a growth, and the soil appears to have been too heavy. If you have no other small plants to grow on, shake out the old ones, cut in the shoots moderately, and place them in smaller pots than those they previously occupied, employing lighter soil, then plunge the plants in brisk bottom heat, and when sufficient growth has been made place them on a shelf near the glass in a stove or similar house. If you still have young plants be careful not to overpot them or induce too vigorous a growth, keeping them in a light position. Seedling plants flower equally as well as those from cuttings, and often much better, and propagation by seeds is by far the most satisfactory method of increasing the plant.

Culture of Stephanotis (*H. J. P.*).—Though this plant succeeds best in a stove temperature it will also grow in an intermediate house or a greenhouse; but in the cooler houses it is often very unsatisfactory, and to ensure the best results it should be grown in the stove. Abundant supplies of water are needed during growth, and frequent syringing is essential to preserve the plant in health and keep it free from insects. A compost of light turfy loam, peat, or leaf soil and sand, all moderately rough but well incorporated, is the most suitable, providing good drainage whether the plant be grown in a pot or planted out. It should be rather restricted in root-space, and when growth is matured the supply of water may be considerably diminished, so as to afford a partial rest. It may be propagated by cuttings or layers, the former being most usually adopted, inserting the cuttings of half-matured growths in sand, and plunged in a hotbed or ordinary propagating frame. In pruning remove all old straggling bare shoots, retaining the young healthy growths.

Tabernamontana Flowers Falling (*J. H. S.*).—Although you say your plants are "very healthy," it is not improbable they are still overtaxed and unable to support all the buds that are produced "by the hundred." Are you sure the soil has not become too dry at some time? An hour's dryness would cause the buds to fall, so also would a sudden change from a moist to a dry atmosphere; and if you syringed freely and frequently you may have gone from one extreme of moisture to the other by ceasing syringing altogether. Then, again, a sudden fall in temperature would prevent the flowers expanding. You say the "average" temperature of the house is 60° to 70°. In a case of this kind an "average" heat is of less importance as affecting the plants than the minimum temperature—for instance, 60° by day and 50° by night would afford an average of 65°; yet 50° is decidedly too low for Tabernamontanas. Try a night temperature of 65°, syringing the pots and the stage on which the plants are arranged occasionally, thin out carefully some of the buds, apply a little perfectly clear soot water to the plants, and we think you will succeed in your object.

Planting Roses (*La France*).—We like the plan of your proposed Rose garden very much, and you cannot err by planting all the varieties, the names of which you have submitted, provided the plants are healthy and especially have good roots, with such others that are named in the election of "garden Roses" on page 341 of our issue of October 30th, 1879, and in the election of

exhibition varieties on page 358, October 12th, 1882, both of which numbers can be had from the publisher if you do not possess them. By all means trench and manure the soil now, giving preference to cow manure, as the soil is light, adding also any heavier soil you can procure. A dressing of bonemeal at the rate of a quarter pound or more to the square yard, and pointing it in after the trenching is completed, or mixing a handful with the soil that is placed round the roots of each plant when it is inserted. Planting cannot be done too soon, and it is most important that the roots be kept moist during the process of removal. If you purchase any plants especial attention must be directed to this matter. We should only reject those of your own that are not well furnished with healthy roots, should prune closely immediately after planting, and surface the beds with manure. In trenching do not bring up much inert subsoil, but break it up, leaving it at the bottom of the trenches.

Culture of *Hymenocallis macrostephana* (F. R. B. S.).—This requires similar treatment to *Eucharis grandiflora*, both as regards soil and temperature. A compost of turfy loam, with a little peat, well-decomposed cow manure, and sand is the best suited for it, well draining the pots. When about to start the plants into growth place them in a strong stove heat, supplying water liberally, and syringing them frequently after they have made good progress. Gradually diminish the supplies of water, and place the plants in a cooler house, but do not dry them off to the extent that is sometimes advised. Plants can then be again introduced to heat at intervals, and flowers will be readily produced, provided you avoid overpotting the bulbs, as they flower much better when somewhat confined at the roots.

Various (J. S. Cairnie).—The plan usually adopted to prevent water passing through a roof in such a case as yours is to solder a piece of zinc to the pipe, affixed in such a way as to conduct the water where it is required. For gates and outdoor work generally we find anticorrosion paint answer our requirements; colour is a question of taste; we use chocolate. You can get it from ironmongers. It is quite impossible for us to answer your third question usefully. Examine one of the articles that you can find in use, or in the stock of a vendor, and exercise your own ingenuity.

Repotting Palms (E. Sendall).—If you will inform us whether you have a greenhouse or other glass structure we will readily advise you on the matter, both as to the time and manner of repotting the plants, also on the Ferns. Our reply to be useful must be governed by the cultural conveniences at your disposal.

Mixing Lime with Tanner's Bark (T. S.).—We have mixed lime with tan to prevent the increase of worms, which are often so troublesome when pots have to be placed on it or plunged, but we have not observed that this caused the heat to be more continuous; indeed, we have thought it had rather a contrary effect. Our experience, however, in mixing lime with tan has been somewhat limited, and if any of our readers have adopted the practice and found different results we will readily publish them on being forwarded.

Burnt Clay for Heavy Soil (W. H.).—You have been rightly advised to apply the burnt clay to your soil; it will make it work better, it will be less tasteful to slugs, and it will stand dry weather better, at the same time superfluous water will readily pass through it. Clays of course vary in their composition, but amongst other things they all contain more soluble potash after burning than they did before, and they have the property of absorbing ammonia from the atmosphere. When burned hard as bricks clay is not nearly so valuable as when it is burned by a slower process and reduced to powder. Ballast is excellent for placing over drain pipes, but has little, if any, manurial value, but its mechanical action is not unfrequently beneficial in very heavy and naturally adhesive soil.

Sawdust in Gardens (T. H. F.).—It is useful for mulching, but if the soil is very light, too light, the dressing should be scraped off and removed after it has served its purpose of arresting evaporation in the summer or excluding frost in winter. If the land is not too light the sawdust may be dug in. We have seen it mixed with very heavy soils with decided benefit. We have also when quite dry seen it spread a few inches thick on soil, and burnt there with great advantage to the after crops. It is useful for plunging purposes, and the fact of its not being a quick conductor of heat is not a serious drawback, for when once warmed the heat is retained with comparatively little drawing. We have long used it in a bed over hot-water pipes, and when placed in we make it warm in a moment by simply pouring over it sufficient hot water to moisten the entire bulk, and find no difficulty in maintaining the requisite heat in the bed afterwards. Cuttings of all kinds of plants do not strike well in sawdust, but those of several will do so freely if they receive proper attention.

Guernsey Lilies (F. C.).—The bulbs of Guernsey Lilies (*Nerine sarniensis*) arrive in August, but it is very advisable that orders be booked in July, as the bulbs spoil in a few days if not potted. The flower scapes are usually visible when the bulbs reach their destination, and the flowers sometimes expand in less than a week—in fact, we have known them to open in transit. They should be placed in 4-inch or 5-inch pots, using any ordinary light gritty soil. They are very bright, also somewhat curious, and flower before the leaves are produced. If the bulbs emit roots and take possession of the soil leaves then follow, and the plants must be grown on a light shelf in a warm greenhouse similarly to *Amaryllis*. Many of them, however, emit no roots, and are therefore of no further use after flowering—indeed, you had better not expect the plants to flower again the second year. As to their being "really good plants," that is entirely a question of taste. That some persons admire them is evident by the considerable demand for bulbs that is experienced by all large dealers; but this demand bears no comparison to that for *Hyaenanthus*. As Guernsey Lilies are not costly you might try half a dozen of them, and if you order them early and pot them quickly, placing them in your greenhouse, you will not have long to wait for their bright red miniature *Amaryllis*-like flowers, with gracefully recurved segments.

Potting *Erica ventricosa* (Idem).—Few plants are more difficult for amateurs to grow well than hardwooded Heaths, and no plants need greater care in potting and judgment in watering. If you shake all the old soil from the plant you will certainly kill it. If you venture on repotting defer the work until May or June, keeping it in the meantime in a very light position in a cool and well-ventilated greenhouse. In June it will be better in a frame, standing the pot on a slate, so that no worms can enter through the drainage. A plant that crowds the pot with roots must always have the soil moist, not at the top merely, but throughout the mass. If the soil is allowed to get dust-dry for an hour the plant will be ruined, while if it is saturated so as to render the peat sour it will refuse to flourish. If when you rub the soil with the finger it is in the slightest degree pasty no water is needed; but if the soil has a tendency to crumble apply water at once in sufficient quantity to moisten every particle of soil. In the summer a rootbound plant requires much water, but how often it should be given it is utterly impossible for anyone to say. If you repot the

plants you must obtain firm fibrous peat, not bog peat, and add a sixth part of silver sand. Mind that both the soil round the roots is neither wet nor dry, yet decidedly moist. The new pot must be clean and well drained, and two sizes larger than the other. Do not disturb the roots of your plant at all, even not removing all the old drainage material, and when placed in the new pot on a layer of fresh firm soil the surface of the original soil must be nearly an inch below the rim. Place in the soil all round, a little at a time, and press it down as hard as you can with a blunt stick, making the new soil, in fact, as hard as the old, or no water will pass through the latter. And now your skill in watering will be put to the test. If you make the new soil too moist the roots will not enter it, while if the old becomes too dry they will shrivel. A little shade for a week if the weather is bright and syringing occasionally will lessen the necessity for frequent applications of water, at the same time the soil must not be allowed to get decidedly dry. A newly potted plant never requires so much water as a plant does that is rootbound, and a plant should not be watered immediately it is potted unless the roots have been much disturbed. A Heath can be kept healthy in a small pot if it is liberally supplied with water in the summer and the pot is shaded from the sun. You must now decide the question of potting for yourself, in accordance with the cultural skill you may possess in ministering to the wants of the plant under differing circumstances.

Caterpillars or Grubs on Apricot (Inver).—The packet or case of eggs was too damaged in transit to be identified, but we rather doubt whether those you describe are connected with the caterpillar in question. In the spring the young leaves are sometimes attacked by the grub of a sawfly, but its eggs are laid in the month of April. The caterpillars of that destructive species, the Winter Moth, feeds upon the Apricot not unfrequently, not, however, under glass. The fragment of weed sent was crushed beyond recognition. We do not know any weed by the name of "Spilt Milk," but probably if a specimen reached us in good condition we should be able to determine the name of the plant. Specimens whether of insects or plants ought to be sent in boxes, not simply enclosed in letters, if they are expected to reach us in even fair condition.

Raising Asparagus (E. P. C., Loire et Cher).—We presume you do not intend any of the plants to remain in the seed bed, but intend transplanting the whole of them, or at least all you require, for the ground you intend to occupy. In this case we should not sow thickly in a series of narrow beds, but should select a piece of rich and, if possible, rather light ground, and sow in drills a foot apart and an inch deep, scattering the seeds thinly, as it is not easy to draw out superfluous plants without injuring the others when they are much crowded in the rows. The date for sowing is not of nearly so much importance as the state of the weather and free condition of the soil. In England fine weather towards the end of March is suitable, but possibly you may sow somewhat earlier in your district. By sowing as we propose there is sufficient space for using the hoe freely but lightly between the rows, not only for preventing the growth of weeds, but for accelerating the growth of the plants, stirring the soil being of great benefit in that respect. Two cwt. of nitrate of soda mixed with one of common salt is an excellent manure for Asparagus, scattering it on the surface of the soil at the rate of an ounce per square yard soon after the plants appear, and just before rain if possible; this dressing being repeated at monthly intervals, hoeing the ground afterwards, will be better than one heavier application.

Vines on Greenhouse Wall (Hambro).—We quite fail to understand you, except on the assumption that you prune the laterals close to the main rod each year, and stop them beyond the bunches that are produced. In this case you simply prevent the growths covering the wall. Instead of stopping the laterals let them grow until they meet in the centre of the space. You may not have quite such fine Grapes the first year, but you would have at the least five times the weight the second season if you preferred. Another plan is to stop after the sixth instead of the second leaf; you would then have equally fine fruit, while much of the space would be covered. This year only cut about 6 inches off the ends of the laterals, or rather leave all the wood you can that is hard and contains bold dormant eyes. These growths will form horizontal rods, and will themselves produce fruit-bearing laterals which can be stopped at one or two leaves beyond the bunches as heretofore; but these must not be closer to each other than 18 inches, as the horizontal mains are decidedly too numerous. They ought to be 2 feet apart. The manure to which you refer is, we presume, mixed with ten times its bulk of soil, and in that case it would prove a valuable top-dressing, spreading it an inch thick. Such dressings with judicious watering would keep your Vines in health in the narrow border.

Bottled Grapes not Keeping (G. F.).—As you have previously been successful in keeping the fruit under the same conditions, we think a solution of the mystery is only to be found in the character of the weather and the condition of the growth during the ripening period. Great difficulty was experienced in bringing late crops of Grapes to perfection during the past season, and although they presented little difference in appearance to those grown in more favourable seasons, some of the best cultivators had their doubts as early as October as to whether the fruit was so thoroughly matured as it appeared to be. Fruit is easy enough to keep when well grown and thoroughly ripened during a favourable season, but last season was anything but favourable, and we are not surprised that many fruits besides Grapes have kept badly. An excess of ammonia supplied either in the shape of liquid or solid manure during the growing season would, by stimulating the growth to a greater extent than could be consolidated by the scanty supply of sunlight and heat, have the effect of preventing perfect maturation of the fruit, and without this the most skilful management will fail to keep it. If the leaves of your Vines did not ripen and fall off at the usual time it is quite likely they have had too much nitrogenous food for such a sunless season, and we should advise you to supply less of that commodity during the coming season, and give instead a dressing of wood ashes and bonemeal, or you might use one of the many good samples of concentrated manures advertised in our columns, as Standen's, or the preparation for the purpose made by the Crown Manure Company.

Camellia Blooms Falling (L. J. K.).—This evil may be brought about by a sudden change of temperature or a dry atmosphere, but neither of these appear to be the cause in your case, as you say the plants have been kept in a greenhouse, and the temperature has not ranged higher than 45° to 50° according to the weather. Dryness at the roots, or the soil allowed to become saturated through too much water, exhaustion through carrying too many blooms, or too strong applications of liquid manure, are all sure means of causing the plants to throw off their buds or flowers prematurely, or a sudden check to the plants from any other cause will not unfrequently end in the unsatisfactory results you complain of. The evil in the majority of instances is done long before the flowers expand, and if you examine some of the buds on your plant we do not doubt you will find long before they commence opening that the base of the calyx is brown in consequence, in which case the buds are sure to fall from the plants in time even if they remain until the flowers are partially open. Thus the flowers falling now may not be due to any mismanagement at the present

time, but the injury in all probability has been done some weeks or even months ago when the buds were in a very small state, and the result of the check then received is only now apparent. Some varieties are much more liable than others to throw off their buds and flowers from the slightest check. The Countess of Derby is rather subject to this if the greatest care is not exercised. If you can find out the cause from which your plants have been checked you may be able to guard against it in the future, and achieve success another year.

Pipes for East Indian Orchid House (Idem).—Two 4-inch hot-water pipes are not sufficient for the house you describe if the height is in proportion to the length and width. You should have at least four 4-inch pipes. It is always desirable to have sufficient pipes to maintain the necessary temperature without overheating them, which you would have to do during severe weather if only two pipes were placed in the house. Overheated pipes are very injurious, and you had much better have two extra pipes than have to place them in after you have probably injured your plants. The extra piping would also effect a saving in fuel. The suggestion of the tank is a good one, as you will then always be provided with water of a suitable temperature with which to syringe and water your plants. The small pipes placed in the tank should be supplied with valves, so that the heat can be shut off when the water is liable to become overheated and cause too much vapour to rise in the house. This may only be necessary occasionally during the winter when the atmosphere and the plants will require to be kept drier. During the growing season the moisture rising from it would prove an advantage rather than otherwise, and if placed on the shady side of the house would suit Phalaenopsis suspended directly over it. Your other questions will be answered next week.

Vines in Pots (H. W.).—We consider the safest plan for you to adopt will be to plunge the pots in a bed of fermenting materials composed mostly of leaves, and afford a gentle heat not exceeding 80°; but we should not do this until they had made growths a few inches long. We are not among those who believe that Vines *never* make roots until they have produced foliage. We know they never do so under natural conditions, but we have some reason for supposing that they can be made to produce them under artificial circumstances and thereby weaken the canes. Plunged as we have indicated the Vines would root through and over the pots if covered, and thus derive considerable support. We say this is the safe plan to adopt, because we are not acquainted with your skill as a cultivator, and especially your judgment as a waterer of plants. If in these respects you feel equal to Mr. Bardney, which for anything we know to the contrary you may be, then we should advise you to do as he does, report the Vines as he has described on page 41, January 20th, 1881. This number (No. 30, vol. ii., third series) can be had from the publisher if needed at the usual price, 3½d. We never saw finer Grapes on Vines in pots than those produced by the cultivator named, and the crop on some of the pots was as good the second year as is often seen the first time that strong pot Vines are fruited. We know well that good crops can be grown with the pots standing on hot-water pipes, and we know at the same time that there is risk of a person failing to succeed in a first attempt. Malt dust is an excellent manure for top-dressing Vines and fruit trees. Cases for binding this Journal can be obtained through a bookseller for 1s. 6d. each, this is better than having them by post. You had better consult your bookseller about binding them, as he may be able to give you useful advice.

Pruning Gros Guillaume Vine (J. E.).—This Vine bears better on young wood, stout and matured, than from spurs formed by the ordinary close pruning, and this is what the cultivator to which you refer meant when he advised its being pruned on the long-spur system. The practice he adopts is to have some of the laterals a foot long more or less, and secure them if necessary to the main rod, pruning to the best bold eye where the wood is hard and ripe. Better bunches are almost certain to be produced by this plan than by pruning closely and leaving only one or two eyes at the base of each lateral. By the long-spur system disbudding in the spring is very important, otherwise the growths would be far too crowded. The figure to which you refer represents the long-rod system, and well carried out there is not a doubt it would answer for Gros Guillaume; but it is absolutely necessary that the young growths trained this year for fruiting next be thinly disposed, so that the leaves are fully exposed to the direct action of the sun. Your Gros Guillaume coloured well because the crop was so light. If the Vine is healthy you may have larger bunches and more of them by pruning the laterals much less closely—in fact by practising the long-spur system in a more or less modified form according to the condition of your Vine and surrounding circumstances. There is a Vine of Gros Guillaume in the large vinery at Chiswick, and Mr. Barron systematically trains up young canes, removing from time to time some of the older rods, of which there are several, as he finds a better crop is invariably produced on the young canes than on the older spurred rods.

Names of Plants (G. P.).—1, *Alocasia metallica*; 2, *Begonia manicata*; 4, *Cereus flagelliformis*; 3 and 5, insufficient without flowers. The name on the label is *Zygopetalum Mackayi* superbum. (*W. Monk*).—*Eucharis candida*. (*Reader*).—1, *Melanthus major*; 2, *Scempervivum azoides variegatum*; 3, *Asplenium Ruta-muraria*.

Various (M. B. D.).—As you are satisfied there is plenty of honey in the hive we should not feed the bees at present; it is only in cases of necessity that we give them syrup at this season of the year. The comb foundation is quite right, and you may safely trust the bees to adapt it to suit their wants. It will not make the honey of a dark colour. It is better to take the honey from supers and leave the body of the hive as a food store for the bees. At a meeting of the British Bee-keepers' Association held on February 15th, 1882, it was unanimously resolved that the outside dimensions of the standard frame should be 14 inches long, 8½ inches deep; the top bar to be three-eighths of an inch thick, bottom bar one-eighth of an inch thick, side bars a quarter of an inch thick. These dimensions do not refer to anything outside of the rectangle. It was also resolved that standard frames, duly stamped should be provided at 1s. each.

COVENT GARDEN MARKET.—JANUARY 31ST.

THE supplies and character of business remain the same as last week.

FRUIT.

	s. d.	s. d.		s. d.	s. d.
Apples.....	½ sieve	2 0 to 7 0	Grapes	lb.	2 0 to 5 0
".....	per barrel	29 0 40 0	Lemons	case	10 0 20 0
Apricots.....	doz.	0 0 0 0	Melons	each	0 0 0 0
Cherries.....	½ sieve	0 0 0 0	Nectarines.....	dozen	0 0 0 0
Chestnuts.....	bushel	10 0 12 0	Oranges	100	6 0 10 0
Currants, Black..	½ sieve	0 0 0 0	Peaches	dozen	0 0 0 0
" Red.....	½ sieve	0 0 0 0	Pears, kitchen..	dozen	1 0 2 0
Figs.....	dozen	0 6 1 0	dessert	dozen	1 0 2 0
Filberts.....	lb.	0 0 0 0	Pine Apples, English	lb.	1 6 2 0
Cobs.....	100 lb.	50 0 55 0	Raspberries.....	lb.	0 0 0 0
Gooseberries....	½ sieve	0 0 0 0	Strawberries....	lb.	0 0 0 0

VEGETABLES.

	s. d.	s. d.		s. d.	s. d.
Artichokes.....	dozen	2 0 to 4 0	Lettuces	score	1 0 to 1 6
Asparagus.....	bundle	0 0 0 0	Mushrooms	punnet	1 0 1 6
Beans, Kidney....	100	1 0 0 0	Mustard & Cress..	punnet	0 2 0 3
Beet, Red.....	dozen	1 0 2 0	Onions.....	bushel	2 3 2 6
Broccoli.....	bundle	0 9 1 6	Parsley.....	doz. bunches	3 0 4 0
Brussels Sprouts..	½ sieve	1 6 2 0	Parsnips.....	dozen	1 0 2 0
Cabbage.....	dozen	0 6 1 0	Peas.....	quart	0 0 0 0
Capsicums.....	100	1 6 2 0	Potatoes.....	cwt.	6 0 7 0
Carrots.....	bunch	0 4 0 0	Kidney.....	cwt.	6 0 8 0
Cauliflowers.....	dozen	2 0 3 0	Radishes.....	doz. bunches	1 0 0 0
Celery.....	bundle	1 6 2 0	Rhubarb.....	bundle	0 4 0 0
Coleworts.....	doz. bunches	2 0 4 0	Salsafy.....	bundle	1 0 0 0
Cucumbers.....	each	1 6 2 0	Scorzoneria.....	bundle	1 6 0 8
Endive.....	dozen	1 0 2 0	Seakale.....	basket	1 0 2 0
Fennel.....	bunch	0 3 0 0	Shallots.....	lb.	0 3 0 0
Garlic.....	lb.	0 6 0 0	Spinach.....	bushel	3 0 0 0
Herbs.....	bunch	0 2 0 0	Tomatoes.....	lb.	0 8 1 0
Leeks.....	bunch	0 3 0 4	Turrips.....	bunch	0 2 0 3



POULTRY AND PIGEON CHRONICLE.

GOAT FARMING.

(Continued from page 84.)

AFTER using the before-named precautions we need not be afraid of what is called in-and-in breeding, for when we have obtained a good family likeness of the type and character we advocate we must not think of change of blood outside the boundary of the families we have established. After years of careful selection amongst them we can safely use the best animals of each family for crossing with each other, either of males or females as may appear desirable. We may, however, after the desired type is fixed and the increased stock has got into other hands, go to them for a change, which may prove advantageous through the influence of soil and climate on which they may have been reared. Still we advise breeders to ascertain with jealous care that those animals obtained outside the boundary have been bred with the same objects in view as those by which the new type had been secured; but the only safe means of continuing a breed for special and profitable purposes will be by the establishment of a herd book and society for the same objects that have induced cattle breeders to associate for the same purpose, and admit no animals except by a pedigree to be agreed upon as the basis. It must be remembered, also, that whatever difficulties may have occurred to persons engaged in the formation of a new type of Goat with special objects in view, that although the objects may have been obtained, yet the difficulty of maintaining intact the new style and type will prove greater than any which had attended the work of combination during the progress of cross-breeding, for the simple reason that Nature never stands still, but is either advancing and improving, or deteriorating and retrograding. Hence the animal we advocate, being a composite of various characteristics, will require extreme care and intelligence to prevent future generations either wholly or partially receding into one or other of the races from which they were originally derived.

We will now suppose that the object of our ambition has been obtained, but in Goat-farming we may all have much to learn in their management. We will, therefore, now endeavour to combine in our observations as much as is known relating to the best system of treatment of the animal in its artificial state (for it will be certainly not in its original) either as a breed, or the conditions under which a herd of animals either in large or small numbers can be associated in future Goat-farming. We shall therefore lay before our readers not only the practice of other breeders of experience, but also our own ideas as to further improvements which we shall suggest as desirable and likely to

contribute to profitable results. One of the first objects to be noticed is the fact that to obtain mohair in our climate the animal must be treated to a certain extent artificially, and in doing this we may no doubt collaterally secure a corresponding or additional advantage in the increase of milk and improvement in condition with a larger production of meat, and at the same time defend the animals as much as possible against accident or disease. The important point, however, is to protect the animals by housing in the winter months entirely, and partially in the summer, by either moveable or fixed sheds or shades, against the extremes of weather either of great heat or heavy rains, and thereby endeavour to give them artificially the advantages which our choicest varieties enjoy in their native country—Asia Minor; and this will no doubt prove of great importance in Goat-farming, especially in obtaining commercial profits.

Whether Goat-farming is to be carried out by a company having a large and sufficient capital at command, or by individuals upon a smaller scale, we propose to apply our observations, in order that the principles and practice may be adjusted to the requirements of either large or small concerns. We will suppose that on

choosing a farm suitable for our purpose that it should consist of dry soil, either of sand, chalk, or limestone subsoil, and quite dry and friable on the surface. It is also desirable that it should consist of two-thirds in pasture and the remainder in arable, so that the grazing may be obtained in summer, and the root crops, &c., the produce of the arable land, to furnish vegetable food in the winter, in very much the same way as takes place upon the majority of dairy farms for cows. It is also necessary that the pastures should be divided either by live fences if they exist; if not, by iron fencing, for the latter will be required under any circumstances, as the animals will be sure to gnaw and destroy any live fences. These if required to remain must be protected by the strongest and largest pattern of galvanised wire net fencing not less than 5 feet high; and even then it should be placed on the top of a dwarf bank about 1½ or 2 feet high, the ground being lowered inside the fence and removed to form the dwarf bank, as this tends to make approach to the fence more difficult. The other kind of fencing should consist of a kind of moveable iron hurdle not less than 5 feet high, made with upright bar iron and looped at the top above the lateral bar, for points would be serious

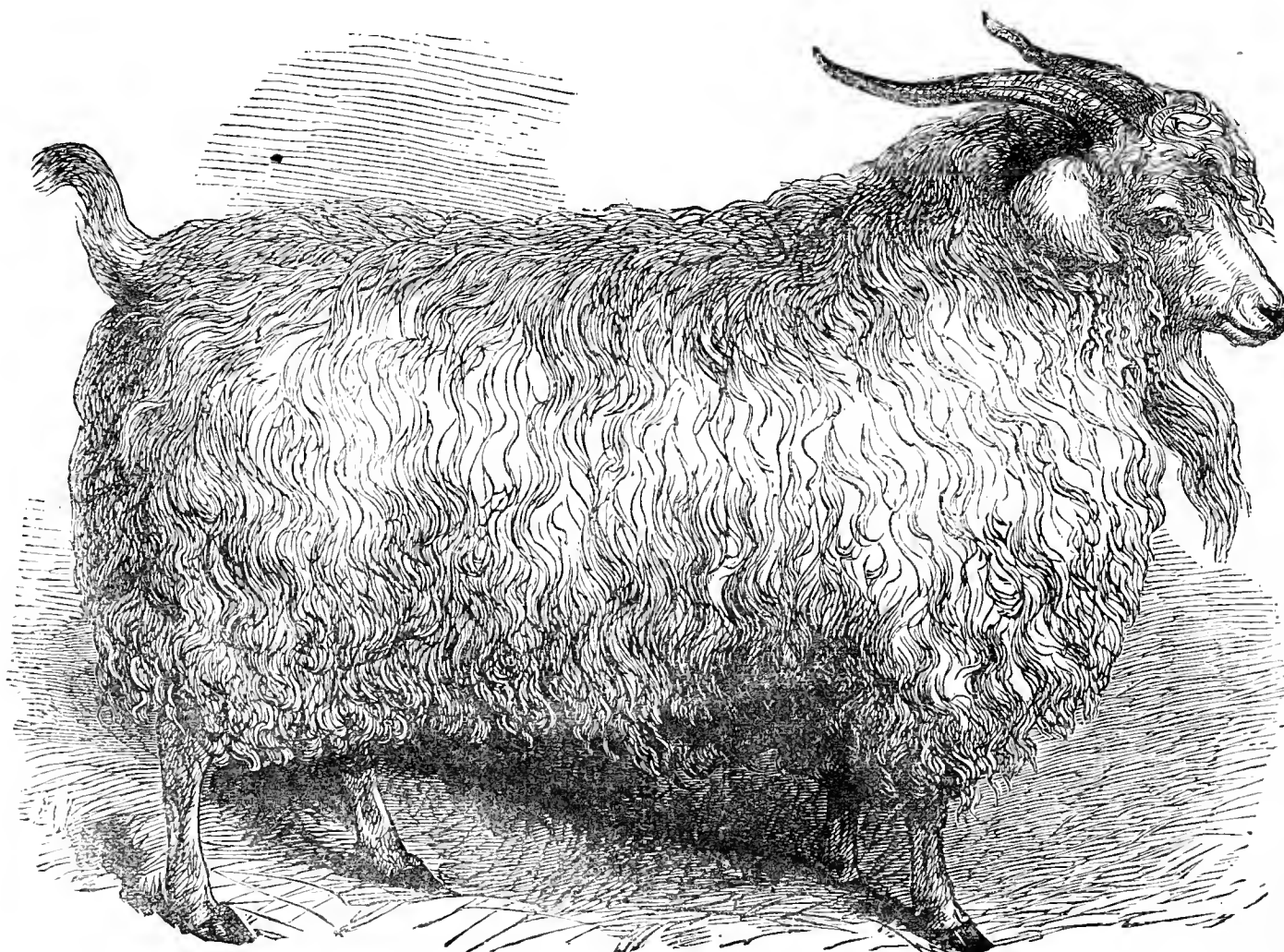

Fig. 24.—MR. J. B. EVANS' ANGORA RAM.

in the event of accidental attempts to break the fold. Such moveable fencing would be available for all purposes on the farm, not only for division of root crops for folding, but also the division of the cultivated or pasture grasses.

The nature of the sheds or shelter for the animals must be next considered; and in order that the same may be available both in summer and winter they should be moveable, so that they may also be made a useful and necessary place and accommodation for milking the animals at all times, as well as being their quarters for feeding and lying, the internal arrangements for which are very important in connection with the system and arrangements generally. It must be remembered that in case we raise mohair on the animals that any old building loaded inside with dust and cobwebs would seriously interfere with the cleanliness which is so desirable, and which is so much sought for by the animals in their native haunts and habits. We, therefore, recommend iron buildings, iron divisions inside, iron fixtures for various purposes, iron troughs for food, water, and salt; in fact, for every item connected with Goat accommodation iron is the best material, and cannot be easily broken or gnawed by the animals. It is also more easily maintained in a state of

cleanliness for all and every purpose, which is so important for animals carrying a fleece of mohair of great value; it may even be necessary, with all and every precaution, found that insects may be bred in the fleece, but they may, no doubt, be removed by the use of the same means as required to destroy ticks or lice in sheep. At the same time it must be remembered that our new type of animals could never be curried or combed with the dandy brush in the same way as the best short-haired milking Goats are often treated, by reason of the length or hair and mossy fur next the skin upon all Goats valued for their mohair.

In a herd of the description which we have indicated as desirable, we having various objects and productions in view, we should therefore have several departments or herds of different ages. The females for milking would be kept separate from the castrated males, the former being fed of producing milk chiefly, the latter more particularly for meat, or mutton as it may be called, and also mohair, and be sold at three years old just after being shorn. The kids also of both sexes, which would be weaned at about six weeks old and fed in a particular manner, must when separated from their parents be accommodated at a considerable distance from, and quite out of hearing by each other.

The males or rams should have specially arranged quarters to themselves, and only leaving them when required for mating with the females. In all these various requirements numerous questions will arise as to cleanliness and health connected with their boxes or sheds, for the rams would live in the former, but the herds whilst in the sheds in summer time, which were moveable, would be dropping their dung, both liquid and solid, on certain selected spots, remaining only long enough to manure the land, and then the site would be occasionally changed during summer. In the winter whilst feeding under cover cleanliness and purity of the air must be obtained and maintained, and this can be best secured by the flooring of earth which we have so often advised in the apartments and pens for all animals, and in Goat-farming this is advisable in all cases, for single Goats or for herds.

The illustration (fig. 24) exhibits the type of Angora Goat imported into the Cape colony by Mr. J. B. Evans in the year 1879, which were the finest specimens of the breed that ever left their native country. The twenty-seven animals were valued at the sum of £2000 on their arrival from Asia Minor.

(To be continued.)

WORK ON THE HOME FARM.

Horse Labour.—The sowing of Wheat will either now be finished or abandoned as hopeless, seeing that the rainy period has lasted so many months; the horses will therefore be employed as soon as the land is dry enough in ploughing and planting or drilling Beans. Instead of drilling or planting in the ordinary way as formerly, the plan now we recommend is to use a drill attached to the presser either for Beans or Peas, separate or mixed, in which case the seed falls into the grooves formed by the rings of the presser, and is therefore well buried by two three-times with the iron harrows. We do not advocate in seeding pulse crops the drilling of the seed after every ring of the presser, which would bring the lines too near together to allow of horse-hoeing between the rows, but by drilling after every other ring of the two-ringed presser would place the rows at about 22 inches apart—a very fair distance for interculture in the early stages of growth. We advocate Vetches or Peas being grown as a mixed crop. As soon as the Vetches or Peas begin to spread they will effectually keep down the weeds and produce an enormous crop generally; but, at any rate, in those seasons when the black or green aphides appear (they seldom both appear in the same season), therefore one crop or the other is almost sure to escape their attacks, and thus making a mixed seeding more certain of a full crop than either of them drilled separately.

Laying out manure on the Clovers has not been done, as the land in most cases would not bear treading without injuring the young Clover or Grass plants, therefore the yard manure has been carted to heap where the fields on which it is to be used lie wide from the homestead in readiness for the root crops, such as Mangolds and Potatoes. We advise that in the cultivation of Potatoes in the future that half-acre plots of the newest varieties should be planted as an experiment every year, and in this case the varieties which answer best on the home farm may be cultivated in the next few years, for we hold that in the event of the newly raised sorts proving good croppers the chance is more certain of not only obtaining a full crop, but also of keeping them free from disease. We also recommend the trial and growth of the largest and best cropping sorts, such as the White Elephant and one or two others which produce large tubers and prove abundant croppers, that they be grown with the object of selling them when it can be done at advantage; if not, let them be used for feeding dairy cattle engaged in butter-making, the plan being to feed with Potatoes, hay, and crushed Wheat, as being the only materials which will yield not only the best quality of winter butter, but also the greatest quantity; for it must be remembered that although Potatoes may be dearer than Swedes or Mangolds at per ton, yet an acre of Potatoes may contribute as much butter, and of far better quality than other roots.

Live Stock.—We still hear a great deal of complaining in certain districts of sheep rot spreading; but we ask, Why should sheep be kept at all in the best grazing districts and accompany the bullocks during the summer, when it ought to be well known that they injure every pasture (as well as run the risk of rotting) by eating out all the finest herbage and white Clovers, and seriously deteriorate the future feeding value of the grass, especially for fattening bullocks? Many early lambs of the Somerset and Dorset cross are now ready for the market, and really ought not to be sold unless they will make a long price, for, although they may be held over to make mutton as regards weight, they will pay better for so doing instead of selling them at the ordinary lamb weight of 10 lbs. or 12 lbs. per quarter. There is this year a superabundance of root food, and if the lambs are kept to be heavy weights they will pay better for the extra grazing than to be sold at light weights. Nothing but the want of money or scarcity of keep ought to induce the owners of lambs to sell them now the stocks of sheep in the country is short by upwards of 5,000,000, unless a very unusual price can be obtained. The Down lambs are now falling fast, and it is fortunate that as yet we do not hear of many losses of lambs; and keep is so plentiful that both ewes and lambs ought to be found in high condition. In fact, as sheep on the vale

farms have been bought in so high in price, it is worth consideration as to the policy of holding over the latter lambing ewes to breed from again, because the wool and the fold during summer is a fair profit, especially as the numbers tell in favour when double the number can be kept as stock and stores compared with fattening them as usual. The fattening bullocks in the boxes may now be fed liberally with cake and roots, and we recommend the home farmer when Potatoes are plentiful and dull of sale to give some to the bullocks for a month before selling them; and if the tubers can be boiled or steamed conveniently before feeding with them they will complete the butcher's animal in the best and most profitable manner. All young store cattle, both heifers and steers, will now be doing well if fed in yards and dry-lying sheds, getting cotton cake and any middling hay. The dairy cows which are dry and not likely to calve for a month or two should be fed sparingly of the most valuable food, as we fear the result of too high condition at the time of calving.

POULTRY AND PIGEONS

ABOUT A DORKING CHALLENGE CUP.

ALL that Mr. Harrison Weir writes about Dorkings is worthy of most attentive consideration, first because his recollections of the breed date back far beyond those of most present poultry fanciers, or at least to a period when they paid no attention to poultry; and secondly because he seems to have a keen eye for the real beauties of the breed, derived, no doubt, from early acquaintance with it, and a still keener perception of the faults too often to be found in modern Dorkings. It is, therefore, in no controversial spirit, but solely with the object of improving a useful breed, that we proceed to give a few reasons in favour of our suggestion of a challenge cup being offered for Dorkings, which Mr. H. Weir seems to think could do no good. We gave some of them roughly in a former article, but perhaps it will be convenient to recapitulate them in order, and then to consider Mr. Weir's objections to our scheme.

1, We have seen a great impetus given to the Game fancy by the offering of a challenge cup.

2, In former days when the prizes for Dorkings at Birmingham were pecuniarily far better than they are now the entry, as old catalogues will show, was much larger. Whether the quality of the birds was better is a matter of opinion. Many old Dorking fanciers think that it was. May not this decline in entries have some connection with the reduction in the prizes offered?

3, We have reasons for thinking that there are many good yards of Dorkings, probably of the oldest and purest strains, which are not now shown, and from which consequently fanciers have no opportunity of buying. Their owners might be attracted by the rumour of a really valuable cup, and be induced to exhibit them.

4, Those who already breed and show would be incited to more spirited enterprise in procuring good stock, more care in mating their birds, and more attention to the points which are really indications of pure Dorking origin.

5, Might it not be that with this increased responsibility on their hands the judges, of whom Mr. Weir gravely complains, would also take extra trouble, before judging Dorkings, really to study the characteristics of the pure breed?

We will now look at the chief objections urged against our suggestion. They seem mainly to divide themselves under two headings—1, That true Dorkings do not exist; 2, That even if they did there is no one capable of judging them.

1, Probably the Dorking, as Mr. Weir once remembers it, is a very rare bird indeed. Unless we are mistaken he told us some months ago in these columns that the farmers' wives who once had the breed in purity and perfection have them no longer, and say that they know not where to go for fresh stock. Surely there must be some reason for this. There seems no denying the fact that the then Dorking was unsurpassable as a table fowl, but why should it have become so nearly extinct? Because, we have every reason to think, from in-breeding or other causes it was so delicate a race that it could not be perpetuated. Some cross was absolutely necessary to keep it alive. No doubt had there been the communication between fanciers and breeders that there now is, and the knowledge of poultry and of the difficulty of getting good table fowls, there would have been judicious exchanges between the owners of stocks of the pure old race, and so it would have been kept up in purity; but there was not. The first bird that came to hand of large size and tolerably like a Dorking in characteristics was used, and so some of the good points of the old Dorking were lost, though increased vigour of constitution has confessedly been gained. Granting for argument's sake that

there are no Dorkings left such as there were forty or fifty years ago, it seems to us a strange conclusion to come to that fanciers are therefore to throw up their hands and give up Dorking-breeding in despair. If there are no Dorkings to judge and no one who could judge them if there were, the argument would prove more than the present case requires. The Dorking classes should be cut out of the schedules of exhibitions. To us the point for a Dorking fancier now to aim at seems to be to get back any excellence and beauty of the old breed that has been lost, and to combine it with the hardihood of the modern breed. There are surely some birds to be found with purely white legs, and some with the correct round meaty breasts, and some devoid of the Asiatic cushion—a sure sign of impurity. From these an intelligent breeder ought to regain the correct type of Dorking by degrees, even if he cannot obtain birds of the old strain. We are not, however, by any means so certain that he cannot do so, but have a great idea that here and there in neighbourhoods where fanciers of bygone days dispersed them, they are still to be found at farms and gamekeepers' cottages.

About six or seven years ago a lady sent birds to Birmingham peculiarly good in all the points which Mr. Weir considers distinctive; they stood high in the prize list, and we were ourselves glad to purchase some of them. On making inquiry we found that they were from birds picked up here and there in the neighbourhood of Inchmarline, the remnants of the stock which Mrs. Arbuthnott once made so famous. Our contention, then, is that probably the old strains are not entirely lost, but that even if they are, by careful selection of the best birds of the modern race we ought to breed back to the old form, retaining the stronger constitution of the modern bird.

2, As to judges. "Who," says Mr. Weir, "should act as judges?" This is, of course, a highly important point, but rather to be settled by the committee of the show where a challenge cup should be awarded than by us. We will not here give names, but we cannot but think that there are several judges in whom fanciers have sufficient confidence to entrust the task to them. As a rule, we are strongly in favour of individual responsibility and single judging; but in such a case as this we should be much inclined to suggest the employment of three judges, and we believe that three might well be chosen who would be "strong enough to act up to the proper standard and insist upon what is right." Into further detail it would be absurd to go, when the idea is ours and has not yet been ventilated.—C.

POULTRY NOTES.

SHORTLY after the Crystal Palace Show a weekly illustrated contemporary published a page of what purported to be illustrations of cup-winners at the show. Fanciers generally were amused, and the owners of the birds somewhat annoyed that such caricatures should go forth as representations of prize birds in these modern times. They recalled the poultry illustrations of forty years ago, when there were no artists capable of adequately treating such subjects as prize poultry. We felt inclined to protest at the time, but came to the conclusion that all those really interested in the subject here would take the illustrations for what they were worth. Now, however, we find in an American journal (the *Prairie Farmer*) a reproduction of these so-called portraits, and we think it only right to assure our American friends that they no more resemble the birds they pretend to portray than the earliest imported Cochins or Brahmas resemble the birds of these breeds now shown.

It is wonderful what a number of keen fanciers there are in the north of Scotland. The show at Aberdeen a week or two back was a remarkably fine one, which, with such a Secretary as Mr. Cowe and such a really hardworking Committee, is not to be wondered at. Many of the breeds were quite as good as are to be seen in the south. The Langshan particularly seems to have established itself firmly in the northern climes. It has a Club with a standard of excellence of its own, it is numerous exhibited, and the average of the specimens is far superior to that seen in the south. The winning birds were grand specimens of poultry, whether regarded from a mere artistic or from a fancier's point of view. If our southern friends could succeed in establishing a type of Langshans as well here as the northern type appears to be established, we should hear less of hostile criticisms as to the antecedents of these birds. Dark Brahma hens, again, have not been injuriously affected as to size by judging for pencilling only to anything like the same extent in the north that they have here. The winning Dark Brahma hen was a truly grand specimen of the breed; large, shapely, well feathered, and well marked with that sort of marking which can be had without loss of size.

Dorkings again, especially Silver-Greys, are well grown and well shown in the north, but we see there the effect of too great laxity on the part of the judges as to dark feet. These are far too prevalent, and should be stamped out. Several prizes were withheld on this ground. White-crested Polish are generally deemed a somewhat delicate breed. At least one exhibitor in Aberdeen does not apparently find them hard to get on with there. The hens especially were a splendid collection to come from one yard. We were somewhat surprised to find that Scotch Greys were not more numerous represented. Their home seems to be rather in the lowlands of Scotland. Mr. Comyns, who acted as Judge, had a somewhat severe task, as the poultry numbered nearly six hundred.

THE leading distinction between Aberdeen Show and Belfast Show, upon which we have now to say a word or two, is, that whereas at Aberdeen nearly all the prizewinners are of home growth, at Belfast, which is by far the best managed show in Ireland, many of the exhibitors, and amongst them rather too many winners, come from England. The Irish northerners do not seem inclined to exclude foreign manufactures, in the poultry line at all events. They are perhaps wise, as at a really leading show like Belfast it is desirable that exhibits of the very best quality should be seen by Irish fanciers who may not have an opportunity of visiting leading English shows. This season the Irish exhibitors made a better stand than they sometimes do. In Dorkings Messrs. Smyth are of course hard to beat anywhere, and they were here once more successful. Mr. Comyns's Dark Brahmas also gained a fair share of prizes, and the same may be said of Mr. Robertson's Cochins. All these names, however, are known at English shows. Game Bantams seem to be making considerable progress in Ireland. They were numerous and good, as were also the variety Bantam classes, the Judge. Mr. Leno, declaring that the winners (Silver Sebrights) were about as good specimens of the breed as he had seen for some time. In Turkeys, Geese, and Ducks Messrs. Birch as usual showed the Irish exhibitors how much can be done by careful breeding and feeding. Poultry Club rules were observed, and Mr. Waters (the Secretary) deserves a special word of recognition for his energy and uniform courtesy.

OUR LETTER BOX.

Malt and Rye Flour (W. H.).—We have made inquiries on the subject, and regret we are unable to inform you whence you can obtain the above, and the only thing we can suggest is that you purchase malt and rye and have it ground and dressed by a miller. If any of our readers can name any vendor of malt and rye flour we will supply you with the information.

Scaly Legs (A. S.).—The disease is caused by a parasite, and is easily curable if it have not gone too far. Mix flowers of sulphur and lard, using as much of the sulphur as the lard will take up. Anoint the legs plentifully with this ointment. After the lapse of twenty-four hours or so wash well with warm water and a hard brush. Repeat treatment until the scales disappear; you may also give some cooling medicine. The disease is contagious. If you prefer it try the effect of vaseline used as above, and kindly let us know result.

METEOROLOGICAL OBSERVATIONS.

CAMDEN SQUARE, LONDON.

Lat. 51° 32' 40" N.; Long. 0° 8' 0" W.; Altitude, 111 feet.

DATE.	9 A.M.					IN THE DAY.				Rain.
	Baromet- er at 29 and Sea Level.	Hygrome- ter.		Direction of Wind.	Temp. of Soil at 1 foot.	Shade Tem- perature.		Radiation Temperature.		
		Dry.	Wet.			Max.	Min.	In sun.	On grass.	
1883	Inches.	deg.	deg.		deg.	deg.	deg.	deg.	deg.	In.
January.										
Sun. 21	30.394	45.2	44.6	S.E.	43.7	49.4	43.8	49.3	36.6	0.014
Mon. 22	30.549	41.9	40.2	E.	43.8	46.4	40.3	51.4	35.7	—
Tues. 23	30.671	33.7	32.7	S.	42.6	39.2	32.4	55.1	23.3	—
Wed. 24	30.314	33.9	32.3	S.W.	40.3	37.4	28.8	40.8	24.5	0.218
Thurs. 25	29.655	31.3	34.5	W.N.W.	39.3	43.3	33.3	73.9	30.4	0.097
Friday 26	29.214	38.4	34.1	N.W.	39.5	46.6	34.6	73.4	27.4	—
Satur. 27	29.716	38.2	35.8	N.W.	38.8	50.2	33.1	61.2	29.0	0.278
	30.072	38.2	36.3		41.1	44.6	35.2	57.9	30.3	0.007

REMARKS.

21st.—Misty and dull; fine moonlight evening.

22nd.—Fine and dry; sunshine in forenoon.

23rd.—Bright, calm, and cold.

24th.—Fair; very cold wind; slight sun in evening.

25th.—Fine and bright; gale at night.

26th.—Violent gale in early morning; bright clear day.

27th.—Fine at first; afterwards rain and very squally, especially at 3.44 P.M.

Temperature near the average, air drier, and much wind, especially on the 26th and 27th.—G. J. SYMONS.



8th	TH	Royal Society at 4.30 P.M.
9th	F	Quekett Club at 8 P.M.
10th	S	
11th	SUN	1ST SUNDAY IN LENT.
12th	M	(11 A.M. Annual General Meeting at 3 P.M.)
13th	TU	Royal Horticultural Society, Fruit and Floral Committees at
14th	W	Society of Arts at 8 P.M.

CULTURE OF LILY OF THE VALLEY.

LILIES of the Valley are esteemed everywhere, but unfortunately they do not succeed equally well in all gardens. In some cases the plants do not flower well, and in others without any care the flowers are produced in great abundance. The diversity of result may arise from a variation of soil and situation, but except in some very peculiar instances I have never failed to grow these plants satisfactorily in any soil that has been properly prepared. In a stiff soil, which though retentive of moisture, and on that account likely to suit them, they have given the most trouble, as although the plants grew freely and increased fast, few flowering crowns in proportion to those that gave no flowers were produced. This was attributed to the plants being too thick on the ground—the plantation too old. A fresh plantation gave no better results, and others in shaded and open situations were equally unsatisfactory. In the same kind of soil, however, plants on a south border flowered freely, which was unquestionably due to the ripening of the growth. In a shaded wood plants growing in light sandy soil, the roots and crowns all in the 3 or 4 inches depth of surface soil composed of decayed vegetable matter, were all that could be desired. In light and loose soil plants grew well but flowered very poorly, so much so that it was deemed inadvisable to devote so much space to them; but when the ground was made firm by treading it, the growth the following season was much more sturdy, the plant had stouter foliage, and the flowers were abundant. In the loose soil the plants grew well, in the firm soil they flowered well.

The Lily of the Valley is a moisture-loving plant, but it does not grow naturally where there is water lodging in the soil. Shade, however essential it may be to the plants in a wild state, is not needed in cultivation; in fact north borders and shady positions have only the supposed advantage of lessening the necessity for watering, but the small number of flowers compared to those grown in an open situation is a direct loss. Choose, therefore, an open sunny situation, and if the site be not well drained naturally it must be made so by taking out the soil a foot deep and putting 6 inches depth of drainage—any brickbats, stones, or rubble will be available, placing the roughest at the bottom and the smallest at the top, and in addition to this there must be tile drainage to carry off the superfluous water. Where the subsoil is of a dry sandy or gravelly character the drainage may be dispensed with.

Light sandy soil is the most suitable enriched with at least a third of leaf soil or well-reduced manure. Thoroughly mix these together when rather dry, so as to admit of the compost being trodden down firmly. Six inches is a suitable depth of soil, and in this the plants should be placed out 2 inches asunder in rows 4 inches apart, the base of the crowns being slightly beneath the surface. A bed 4 feet wide will hold twelve rows, the outside rows 2 inches from the sides of the alleys, which need only be 12 inches wide. Water if necessary with a rose watering pot, and cover the whole bed with 2 inches thickness of sandy soil and well-decayed manure in equal proportions and thoroughly mixed. Planting may be done in February or March. The after course of treatment is to water once a week when rain does not fall to the extent of half an inch, giving a thorough soaking, employing liquid manure after May through the summer up to the beginning of September. Weeds must be removed as they appear, and in autumn after the tops have died give a top-dressing of well-decayed manure an inch thick. In the third season, or after two seasons' growth, they will be in perfection, and will continue for a number of years to flower abundantly; but after six or seven years they become so crowded, and consequently weakened that they need renewal.

When the object is to raise crowns for lifting to be forced there is no difference as regards the preparation of the soil; but the plants may be inserted in rows 3 inches apart and $1\frac{1}{2}$ inch asunder, and after two seasons' growth they will have formed crowns of flowering size. The whole of the plants should then, or not later than the third season, be lifted, selecting the flowering crowns, which are more plump and round than the others. The latter will be good for planting in fresh beds. By making beds every year a regular succession of crowns can be obtained equal to those imported.

Where clumps are required to be lifted for forcing it will be found much better to plant twelve to eighteen crowns in a circle not exceeding 5 inches in diameter, distributing them evenly and working some soil amongst them, keeping all the crowns on one level, and disposing the clumps 9 inches apart in rows 15 inches asunder, than to rely on cutting out clumps from old beds in which there is certain to be a number of non-flowering crowns. The others, if well attended to with water or liquid manure through the summer in dry weather, will in two or three seasons be very strong and in fine condition for forcing, the clumps being cut out with a long-bladed knife just clear of the crowns. The whole may then be lifted, the beds renovated with fresh compost, and the crowns that have been formed outside the clumps replanted.

Forcing.—If it is desired to have flowers of Lily of the Valley in early winter, plants that have perfected their growth early are unquestionably the best for this purpose. If the demand be great roots can be planted out in heated pits, allowing a distance of a foot from the glass to the soil. The first season the growth should be allowed to be made naturally, the lights being withdrawn in mild weather when the outside temperature is 50° , air being admitted freely on other occasions, so as to prevent the temperature exceeding 50° to 55° . Water must be liberally supplied, also liquid manure, during the season of growth. After the middle of June the lights may be removed altogether. In the follow-

ing season start the plants into growth in January, maintaining a temperature of 50° to 55° artificially after the growth is fairly started, and above which ventilate freely, keeping through the day at 60° to 65° from sun heat. As the season advances the temperature through the day should be kept at 70° to 75°. Supply tepid liquid manure, and damp the plants on fine afternoons with tepid water from a fine-rose watering pot. Early in July the lights may be removed and the growth will ripen early. The following season they will be fit for forcing, which may be commenced shortly after the foliage has died. If the bed is at all dry give a thorough soaking with tepid liquid manure, and keep the temperature for the first fortnight at 50° to 55°, and afterwards at 60° to 65°. Flowers will expand in about six weeks. The plants must not be neglected after flowering, but have the treatment continued as in former years, and they will be available for forcing again. A bed will continue yielding flowers for a month, so that the succession may be maintained by starting beds at intervals, those in cold pits preceding those in the open by fourteen to twenty-one days. Similar results may be secured by plants in pots that have been forced, but they must be grown in a light position, and be well supplied with liquid manure during growth, and be properly hardened off before placing them outdoors after midsummer. Such plants can be readily forced at an early season and do not require bottom heat.

The above method of forcing entails considerable labour, but, all things considered, it is the most economical in the end. Under ordinary circumstances the crowns once early forced are not again available. For an early supply a bed may be made of dung and leaves in a heated pit, and when this has settled tread it firm, so that the surface is a foot from the glass. Put on 3 inches of light rich moist soil, and insert the crowns in rows 2 inches apart and an inch asunder in the rows, firming it about the roots, and having the top of the crowns level with the surface. Make sure that the heat at the surface does not exceed 90°, and is not less than 75° at the commencement. Cover the crowns with an inch depth of cocoa-nut fibre refuse or other light material. If there be any deficiency of moisture in the soil water must be given in a tepid state before covering the crowns. Place a single thickness of mats on the lights, nailing it down to prevent displacement by wind, but to the framework of the light only, so as not to necessitate the removal of the mat when the light is to be drawn off. The top heat should be maintained at 60° to 65°. In a month flowers can be gathered, and they will keep good for about three weeks in a temperature of 50°. Clumps may be forced in a similar manner, but they and the single crowns will come without the foliage if started before the new year; therefore, if foliage be needed, non-flowering crowns should be inserted at the same time as the others, but need not be covered with mats, or the leaves will be yellow. No ventilation is given, for the sun is not powerful enough to affect them, and the flowers lose nothing in delicacy and fragrance. In February and onwards it is advisable, as the plants produce foliage along with the flowers, to grow them in the light, a temperature of 60° to 65° artificially and 5° to 10° rise from sun heat being suitable.

If forcing is not commenced before January bottom heat is not necessary for clumps; yet they must not

be brought forward too rapidly, or they will come up without the foliage, and if placed in too much heat will not start into growth at all. They never ought to be allowed to become dry when at rest. For single crowns bottom heat is essential, yet less is needed than in autumn and early winter. At no time ought it to be less than 70° to 75°. They can be readily forced in a frame over a bed of fermenting materials, the requisite heat being maintained by linings, or in fact in any warm structure where there is command of bottom heat, covering them so as to insure the spikes being drawn to a good length. Handsome specimens may be had for the sitting-room by placing single crowns in pots an inch apart in light soil, plunging in a hotbed and inverting pots of larger size over them, so as to elongate the stems or spikes, and when of sufficient length gradually inure them to light.

The Lily of the Valley season may commence in November or even earlier, and close with early June, growing some plants on a north border with a view to have them as late as possible.—G. ABBEY.

HOME CULTURE OF ORANGES FOR DESSERT.

THE late Mr. Thomas Rivers of Sawbridgeworth was very sanguine that the culture of Oranges would spread to large dimensions in England, and that we would be able some day to walk under the shade of Orange groves, enjoying the sweet perfume of the flowers and the delicious flavour of the fruits far richer than the best to be obtained from "the Clime of the East, the Land of the Sun." Many wealthy owners of gardens might do worse than form an Orange grove in their garden, and many that are not wealthy might enjoy the pleasure of eating their own home-grown Oranges. Mr. Rivers in his excellent book, "The Orchard House," states how they may be grown, and he shows us also practical examples of trees heavily laden with their golden fruit. We have several trees now of the St. Michael's variety and the Maltese Blood, the branches of which are bending with the weight of the ripening fruit. The trees fill odd corners either in Pine house, Cucumber house, or vinery; they require a high temperature when the fruit is ripening, and the trees like a good compost of substantial loam well enriched with decayed manure and crushed bones. The peaty-looking stuff in which the continental trees are potted is no use for growing good dessert fruit. Keeping the trees quite clean is absolutely necessary to insure success.—J. DOUGLAS.

[An Orange tree laden with "golden fruit" exhibited by Mr. Douglas at a meeting of the Royal Horticultural Society a few years ago was one of the best examples of culture we have ever seen, and suggested that home-grown Oranges might be produced in many gardens where there are heated structures and sui able "odd corners" for standing the trees.]

ORNAMENTAL GRASSES AND EVERLASTING FLOWERS.

DRIED Grasses and flowers are so extensively employed for room-decoration, more especially during the winter months, that it may be interesting to those who are unacquainted with them, and who are desirous of cultivating them, to enumerate some of the most desirable kinds. The varieties to which attention is directed have the merit of being easily grown by everyone who possesses a garden, and do not require the aid of any special process in drying, but simply to be gathered, and when dry placed on one side until they are required for use.

What are known as ornamental Grasses comprise a considerable number of beautiful varieties remarkable for their conspicuous silvery flower plumes, their flossy inflorescence, or the graceful appearance of their exquisite structure. So varied in their forms are these that they admit of being arranged in very elegant bouquets, or when tastefully disposed in vases with

what are popularly designated Everlasting Flowers they become objects of great beauty, altogether differing from the stereotyped bunch of dyed moss and artificially coloured flowers and Grasses. In addition to being useful in a dried state Grasses when judiciously introduced in epergnes of fresh-gathered flowers contribute greatly in producing the lightness that in a skilful arrangement is always so pleasing. Among those best suited for this purpose the following may be selected—viz., *Agrostis nebulosa*, *Agrostis pulchella*, *Briza maxima*, *Briza media*, *Eragrostis elegans*, and *Lagurus ovatus*; and for dried bouquets, in addition to the aforementioned, *Avena sterilis*, *Bromus brizæformis*, *Bromus patulus*, *Chloris barbata*, *Festuca rigida*, *Hordeum jubatum*, *Melica altissima*, *Penisetum longistylum*, *Phalaris canariensis*, and *Uniola paniculata*.

These may be treated exactly the same as hardy annuals, although some of them are of more than annual duration. Seed of any of them can be obtained at a trifling cost, and if sown in March or April in the open ground, the plants after being well thinned require little attention. It is well to gather the flowers in different stages of development, rejecting those that are approaching ripeness, as when dry these will not be of good colour, and, moreover, will be disposed to fall to pieces. To dry them it is only necessary to expose them to the influence of the sun and air, and when fairly dry they should be tied in bunches and placed away in paper-lined boxes until required for arranging into bouquets. It is best to procure plants of the perennial tall-growing species, but it must not be expected of them to flower the first season of planting. Being generally supplied by nurserymen in pots they can be obtained throughout the year. But perhaps the best month for planting them out is April, when the roots are in active growth. *Arundo conspicua*, *Erianthus Ravennæ*, and *Gynerium argenteum* represent the section, the former being an admirable decorative plant when in flower, and much resembles the Pampas Grass (*Gynerium argenteum*), but is of a neater habit of growth and possesses the advantage of coming into flower much earlier.

The time to gather these is when the spikes are about to emerge from their sheaths; by so doing the plumes when dry are of snowy whiteness, and present a very beautiful appearance. Nor should it be omitted to mention with regard to their blades, how much they contribute to the graceful appearance of an arrangement of flowers when introduced after having been carefully shredded, as seen in the exhibits of table decorations at our chief floral gatherings.

The remarks made as to gathering Grasses applies equally to Everlasting Flowers, of which the subjoined may be chosen as deserving of being more generally grown. *Acroclium roscum* and *Acroclium album* are two of the prettiest of the comparatively neglected annuals that can be mentioned, but the introduction of a new double form of the first-named, introduced for the first time this season, may be the means in some degree of bringing the merits of the older varieties into popular notice and favour. *Ammobium alatum*, *Catananche bicolor*, the many varieties of *Helichrysum*, the *Rhodanthes* and *Xeranthemums*, if only for their profuse-flowering qualities, and independently of their value as dried flowers, have a claim on growers of annuals that appears to be not sufficiently recognised.

Honesty (*Lunaria biennis*) is mentioned here on account of the pretty silvery silicles of its seed vessels, which are so admirably adapted for placing with some of the species of ornamental Grasses in large vases. Plants raised from seed sown during the ensuing season will produce their large lilac flowers the following summer, and these are succeeded by the seed vessels which contain the silicles. The stalks bearing them should be gathered before the seed commences ripening, so as to prevent discoloration, and when dried they are readily prepared for use.—S. P. E. S.

PRUNING GOOSEBERRIES.

I WAS pleased to see in the Journal several letters on this subject, and if I may give my experience I should say, Do not prune Gooseberries. I live in a rather windy locality, and as I found the storms injuring the crops of the Cabbage family

I made a hedge of Gooseberries. That was done twenty years ago, and I can safely speak in favour of non-pruning, for when the bushes became about 3 or 4 feet high I gathered more fruit from this hedge than all the trimmed bushes in the garden. This induced me to discontinue pruning except those branches that over-spread the ground; and I have now miniature trees or bushes with not a new shoot on them. They bear wonderfully well, they never fail, and the spring frosts do not affect the fruit when in blossom. I have always a good crop, and am so satisfied with the results that I have not pruned Red Currants for several years, which I am glad to say also answers. After the bushes become a certain age and size they do not make new wood, and the branches only produce spurs or fruit buds.—R. H. D.

SENECIO PULCHER.

EVERYONE who is once fortunate enough to see a good strong plant of "Tyerman's Groundsel" in flower in October generally falls in love with it "right away." Its flowers are larger and of more substance than our large Ox-eye Daisy, and are of a clear and bright magenta earmine with a golden disk, eight or ten blooms being borne in a corymb-shaped mass at the apex of its stout, succulent, leafy stems. As it rarely ripens seeds and divides but badly, I very soon found after its introduction that cuttings of its quill-like roots would grow if cut into lengths about an inch long and inserted in a sand-surfaced pan of soil as cuttings. We

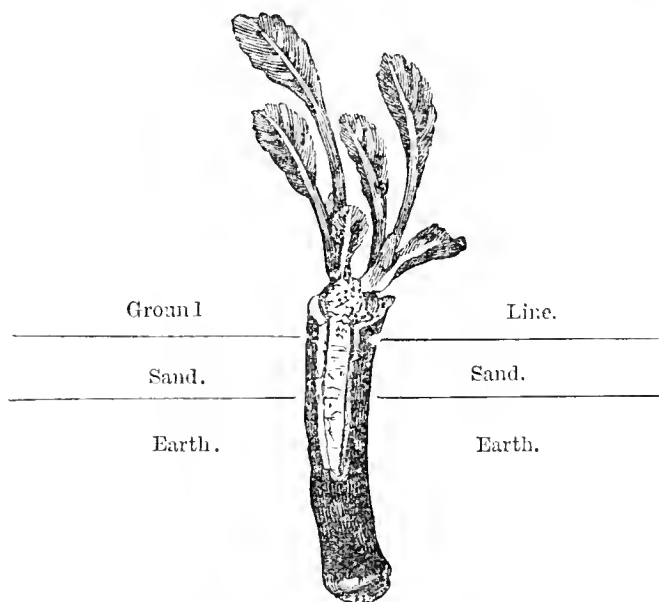

Fig. 25.—Root-cutting of *Senecio pulcher*.

make and put in these cuttings in November as soon as the plants have finished blooming, and place the pan on a shelf near the glass roof of a warm greenhouse. In about three weeks each cutting first splits open as shown in our cut, then they turn green where their tops are exposed by the action of the watering-pot, and finally one or more green-leaved shoots appear, as also shown in our illustration. In this simple way an old plant yields forty or fifty cuttings, 75 per cent. of which will make plants to bloom the second or third year.—B. W.

COLLECTIONS OF SEEDS.

ABSENCE from home, and consequently inability to refer to "our Journal," has prevented my replying to Messrs. Carter and Co.'s letter on page 7 on the above subject. I quite recognise the fact that being able to prepare a large number of boxes before the busy season commences is a great boon, so much so, indeed, that I did not even mention it, thinking it must be patent to all; nor do I for one moment believe that any house can "make up a box to please everybody." I can also say, after having dealt with them for twenty-three years, that their seeds are generally very good. Thus far we are at one; but I do object to be quoted wrongly. I said, "There were enough of those valueless to me to sow a good portion of the garden;" whereas I am made to say, "There were enough of those valueless sorts to sow a large garden." They were "valueless" to me because I did not require them, and "sowing a good portion of the garden" and "sowing a large garden" are very different matters.

As to the contents of the boxes, 5 quarts and 1 pint of Peas in six varieties would be preferable to the same quantity in eleven varieties, as two sorts seldom boil well together, and a sufficiency for a dressing cannot always be had from small sowings after the

first picking. As a rule, enough Beans of all kinds are annually saved here for seed, as well as Onions, Parsnips, Tomatoes, Melons, Cucumbers, and Marrows. Spinach does not find much favour, so 1 oz. instead of four would be ample; therefore $4\frac{1}{2}$ pints of Beans and eleven packets of other seeds would be useless to me, and in an order would of course be left out. Last year was not favourable for saving seeds; still those mentioned were secured with little extra trouble.

Whilst I was away a seed catalogue arrived for my host. I remarked, "You still deal with Messrs. — I suppose?" The answer was, "No, I used to have a guinea box, but there were so many things I did not care for that I have given up that mode." Since that, when walking through a friend's houses, I asked the head gardener if he bought collections of seeds. He said, "No, because there are so many things I don't want. When seedsmen first sent out their boxes they would take out sorts I had and put in a quart or so of Peas instead. They won't do that now, consequently I never buy them." I am in this dilemma: I must either buy, say, a guinea box containing many things which I have in abundance, or pay 26s. or 27s. for a far less quantity.

It has been suggested that if we were to send our orders, as proposed in my former letter, not later than the middle of November it would give plenty of time to execute them before the busy season, and then perhaps seedsmen might see their way to allow a good per-centage off catalogue prices when they made their "own selections," the same as florists do with varieties of plants.—C. T. H., *Dorset*.

A CHRYSANTHEMUM ELECTION.

IN compliance with the frequently expressed desire of many cultivators, we a few weeks ago invited all who were disposed to do so to select what they considered the best forty-eight varieties of incurved Chrysanthemums for exhibition purposes, arranging them in three groups—first twelve, second twelve, and remaining twenty-four varieties. The response has more than equalled our expectations. No less than eighty returns have been sent in from the leading cultivators, and we think all the districts are represented in which special attention is given to the culture of this increasingly popular flower. In addition to selections from many successful growers in what may be termed the metropolitan area, lists have reached us from Liverpool, Birkenhead, Birmingham, Bristol, Chesterfield, Southampton, Newcastle-on-Tyne, Northampton, Manchester, Leicester, Plymouth, Dublin, and Guernsey. The election, therefore, is of wide scope, and as it embodies the judgment of prizewinners and adjudicators at most of the principal exhibitions the results are entitled to some weight; indeed we may go further, and say that the outcome of this united effort to determine the relative merits of the different varieties is the best, most complete, and authoritative selection of incurved Chrysanthemums that has ever been published.

Counting the votes in elections whether of individuals or of flowers not infrequently leads to surprises. Confident anticipations are often rebuked and foregone conclusions shattered. If anyone asks, What is the use of an election of Chrysanthemums? the reply is, The increasing number of requests for lists of the best varieties after selections have been given again and again by ourselves and others well able to give them. Something more than the choice of one or two individuals has been required, and now it is afforded. But it may have been, and has been observed by some, that "any grower knows which are the twelve best varieties, and therefore an election is not needed." The facts are, however, decidedly against the accuracy of this judgment: for so far from "anybody" being in possession of this information we find, as the first surprise, that not one of the eighty electors named all the varieties that received the aggregate number of votes for placing them in the highest position. Again, it was thought by not a few that only a very limited number of varieties would be selected, and the majority of those in commerce, good as they might be, would remain unnoticed. The contrary has been the case; and this brings us to the second surprise and curious fact, that in the seventy-seven lists submitted, of which the votes were counted, just seventy-seven varieties were named as worthy a place in the first twelve. The three remaining lists arrived too late to be included, but we have satisfied ourselves by a careful examination that they would not have altered the relative positions of the best flowers. The total number of Chrysanthemums that have been named in the lists is 156, which exceeds the varieties of the same type enumerated in the majority of catalogues. Many varieties have been named by several cultivators as identical with others that are named, or too closely resembling them. The returns under this head, or an analysis of them, will be published in a future issue, and will certainly not be the least interesting

and instructive feature of this election, although it is not unlikely that the accuracy of some of the individual decisions may be questioned; still there will be such a consensus of opinion in regard to many of the flowers that will amount to a verdict that will meet with general acceptance.

It only remains to be explained that the figures in the first column of the following table indicate the number of first-class votes, or votes recorded in favour of the varieties being placed in the first twelve; the number in the second column representing second-class votes, or those entered for the second twelve varieties; the third, as is apparent, containing the total number of votes recorded for each variety in the list. We have not tabulated any varieties that received less than five votes, but we add them at the foot of the list; nor, considering the great number of sorts included, has it been necessary to add a column for third-class votes for the remaining twenty-four varieties, as those that do not find a place in either of the two twelves naturally fall into the remaining category, and the general estimate of them is expressed by the relative number of votes recorded:—

RESULT OF THE POLLING.	1st Class Votes.	2nd Class Votes.	Total.
1. Prince Alfred	61	13	74
2. Golden Empress of India	64	9	73
3. Princess of Wales	65	7	72
4. Empress of India	65	6	71
5. Jardin des Plantes	45	25	70
6. Queen of England	50	19	69
7. Barbara	37	30	67
8. Princess of Teek	27	39	66
9. Hero of Stoke Newington	41	21	62
10. Mrs. Heale	41	17	58
11. Mr. Bunn	31	25	56
12. Lady Hardinge	25	31	56
13. John Salter	41	11	52
14. White Venus	17	32	49
15. Refulgence	32	15	47
16. Nil Desperandum	18	27	45
17. Mrs. G. Rundle	16	18	44
18. Prince of Wales	15	28	43
19. Alfred Salter	26	16	42
20. Venus	9	27	36
21. Mrs. Dixon	11	21	32
22. Cherub	8	24	32
23. Mr. G. Glenn	8	21	29
24. Princess Beatrice	5	24	29
25. Lady Slade	6	22	28
26. Bronze Jardin des Plantes	6	21	27
27. White Globe	7	17	24
28. Novelty	7	16	23
29. Mr. Brunlee	6	16	22
30. White Beverley	8	13	21
31. Golden Queen of England	11	9	20
32. Eve	7	13	20
33. Isabella Bott	6	14	20
34. Mrs. Haliburton	6	14	20
35. Baron Beust	5	15	20
36. Golden Beverley	4	15	19
37. Empress Eugénie	7	10	17
38. Lord Derby	5	12	17
39. Emily Dale	6	10	16
40. Beauty	5	10	15
41. Mr. Howe	11	3	14
42. Mrs. Shipman	3	11	14
43. Miss Mary Morgan	5	7	12
44. Guernsey Nugget	5	7	12
45. Lady Talford	1	10	11
46. Pink Venus	3	7	10
47. Beverley	0	10	10
48. Pink Perfection	2	7	9
49. St. Patrick	1	8	9
50. Mabel Ward	2	6	8
51. Sir Stafford Carey	2	6	8
52. Blonde Beauty	2	6	8
53. Golden Eagle	0	8	8
54. Lord Wolseley	6	1	7
55. Mr. Gladstone	4	2	6
56. Incognito	2	4	6
57. Antonelli	1	5	6
58. Mr. Cullingford	2	3	5
59. Golden John Salter	1	5	6
60. Beethoven	0	5	5
61. Angelina	0	5	5
62. General Bainbrigge	0	5	5

The varieties that secured less than five first and second-class votes were as follows:—White Queen of England, Hercules, Le Grande, Duchess of Manchester, Mr. Corbay, Belladonna, Enamel, Countess of Dudley, Virgin Queen, Lilac Princess, Queen of the Isles, Fingal, Gloria Mundi, Snowball, Monarch, Clarissa, Orange Perfection, Mount Edgecombe, and Aimée Ferrière.

The following were only included in the lists of second twelves, and each obtained less than five votes:—Aureum multiflorum, Miss

Hope, Abbé Passaglia, Mrs. Cunningham, Faust, Beauty of Stoke, La Belle Blonde, George Peabody, Cassandra, Miss Thurza, Rev. J. Dix, Hereward, Golden G. Glenny, Lady St. Clare, Albert Smith, Rifleman, Donald Beaton, Rev. C. Boys, Boadicea, Princess Louise of Hesse, Princess Alexandra, Nonpareil, Her Majesty, Model, Mr. James, Dr. Rozas, Laurinda, Plenipo, Mr. H. Morgan, Lady Carey, Caractacus, Mrs. Sharp, Marchioness of Lorne, and Maréchal Duroc.

In the third list of twenty-four varieties most of the foregoing were named, and in addition the undermentioned varieties were included in a few of the returns, but none obtained more than five votes:—Mr. J. Laing, L'Orient, Golden Dr. Brock, Miss Marchaux, Captivation, Ossian, Themis, Arthur Worthly, Vesta, Ion, Boule de Neige, Admiration, Hermione, Hetty Barker, Hackney Holmes, Lady Russell, Album Formosum, Little Pet, King of Denmark, Dr. Lindley, Exquisite, Cleopatra, Rotundiflorum, C. E. Waters, Lady Godiva, Princess Marie, Madame Fold, Duke of Roxburgh, Talbot, Cassandra, Duke of Edinburgh, Crimson Velvet, Mons. Bonamy, Candidissimum, Alma, Plutus, Countess of Granville, Golden Ball, Little Harry, Formosum luteum, Mr. Jay, Mrs. Shaw, and Aregina.

Returning to the tabulated list giving the result of the election, we find that the following varieties secured the highest number of votes in the first twelve, as is indicated in the first column—viz., Princess of Wales, Empress of India, Golden Empress of India, Prince Alfred, Queen of England, Jardin des Plantes, Hero of Stoke Newington, Mrs. Heale, John Salter, Barbara, Refulgence, and Mr. Bunn. These are arranged according to the respective number of votes each obtained; and it will be noticed that the result is most satisfactory, for a stand of good blooms of the varieties named would, if well set up, be exceedingly difficult to surpass—in fact, we cannot see how the selection could be improved. There is a due proportion and diversity of colours, including two whites, three yellows, one amber, three dark varieties, two blush, and one rose. The premier varieties in the first twelve are Princess of Wales and Empress of India, each of which obtained sixty-five votes; but the former is entitled to precedence owing to its securing seven second-class, while Empress of India had six in that class; and though Prince Alfred heads the list in the total number of votes, yet it is fourth in the first twelve. Golden Empress, though following the last-named variety in the general total, precedes it by three first-class votes.

Taking the varieties which were accorded the greatest number of second-class votes, as shown in column 2 of the table, and excluding Barbara, Jardin des Plantes, Mr. Bunn, and Queen of England, which came into the first twelve, we have the following, which are also named in order of their votes—Princess Teck, White Venus, Lady Hardinge, Prince of Wales, Nil Desperandum, Venus, Cherub, Princess Beatrice, Lady Slade, Mrs. Dixon, Mr. G. Glenny, and Mrs. G. Rundle. These give the following colours—three whites, three yellows, two dark varieties, two rose, and two blush—also a good proportion. It will be seen that most of these varieties secured a good proportion of first-class votes, but not sufficient to oust the larger-flowered varieties which have obtained so marked a preference.

To decide the best twenty-four we have selected those with the highest total number of first and second-class votes together after excluding those which have gained places in the two twelves. In that way the undermentioned varieties have taken the lead—Bronze Jardin des Plantes, White Globe, Novelty, Mr. Brunlees, White Beverley, Golden Queen of England, Eve, Isabella Bott, Mrs. Haliburton, Baron Beust, Golden Beverley, Empress Eugénie, Lord Derby, Emily Dale, Beauty, Mr. Howe, Mrs. Shipman, Miss Mary Morgan, Guernsey Nugget, Lady Talfourd, Pink Venus, Beverley, Pink Perfection, and St. Patrick. Of course, if it were desired to select twenty-four varieties for exhibition they would be chiefly chosen from the first twenty-four, and those last named can only be considered as affording a surplus in case the others should be unsatisfactory, and the same remark applies to the first twenty-four; for instance, if a stand of twelve were required the varieties could be selected from the leading sorts named in the two twelves, as more scope would thus be allowed.

Amongst other notable peculiarities in the result table it is noteworthy that Mr. Howe and Golden Queen of England each obtained eleven first-class votes, which is the same number as Mrs. Dixon, though the latter gained a place in the second twelve by a majority of eighteen votes over Mr. Howe, and of twelve above Golden Queen. Mr. Bunn and Lady Hardinge secured precisely the same total number of votes—viz., fifty-six, but strangely reversed, Mr. Bunn having thirty-one first and twenty-five second; while Lady Hardinge had twenty-five first and thirty-one second. Mrs. Dixon and Cherub are also equal in total votes—namely, thirty-two each, but the former has eleven first and

twenty-one second, while the other has only eight first but twenty-four second. Mr. G. Glenny and Princess Beatrice are similarly alike in the totals—twenty-nine each, the first leading by three first-class votes. Golden Queen of England, Eve, Isabella Bott, Mrs. Haliburton, and Baron Beust have all equal totals, Golden Queen surpassing them all by three first-class votes. Several other cases of equal totals occur, but they do not need special mention; however, the comparatively high position which Lord Wolsley obtained as a new variety that was exhibited for the first time during the past year is remarkable, and Mr. Orchard, the fortunate raiser, states that if the variety were in commerce he would give it a place in the first twelve. It is strange that, taking the proportion of first to second class votes, the sport should have a higher place than its parent Prince Alfred.

As previously stated, not one of the seventy-seven returns that we have tabulated included the whole of the varieties that have obtained places in the first twelve, and one only comprised eleven of them, which was sent in by Mr. George Burden, Lingdal Lodge, Oxtou, Bickenhead, who is therefore entitled to the premier position as an elector. Twelve returns included ten of the first-class varieties, and were from the following:—Messrs. W. Bardney, Norris Green, Liverpool; John Bradner, Arley Hill Nursery, Bristol; N. Davis, 66, Warner Road, Camberwell; S. Dixon & Co., Hackney; J. Foster, Greenbank, Wavertree, Liverpool; G. Harding, Bristol House, Putney Heath; C. Herrin, Chalfont Park, Slough; H. Langford, Coleraine House, Stamford Hill; G. Mease, St. Michael's Mount, Liverpool; W. Mease, Wyneote, Liverpool; G. Stevens, St. John's Nursery, Putney; and W. Tunnington, Calderstone, Liverpool.

Eighteen named nine varieties:—Messrs. John Baylis, Winterbourne, near Bristol; Beckett, Sandown House, Esher; E. Cherry, Norfolk House, Streatham; E. S. Cole, Woodside, Sneyd Park, Bristol; A. R. Cox, Elm Hall, Wavertree, Liverpool; Draper, 2, Primrose Hill, Northampton; C. Gibson, Morden Park, near Mitcham; S. Gilbey, The Cazenoves, Upper Clapton; G. Langdon, Brooke House, Clapton; Thomas Leadbetter, Bromborough Hall, Cheshire; S. Mahood & Son, Windsor Nurseries, Putney; E. Molyneux, Swanmore Park, Bishops Waltham; Monk, Leytonstone, Essex; J. W. Moorman, Coombe Bank, Kingston-on-Thames; C. Orchard, Coombe Leigh, Kingston-on-Thames; G. Stacey, York Street, Harborne, Birmingham; John Strong, Thames Street, Weybridge, Surrey; and W. Todd, Dingle Bank, Aigburth, Liverpool.

Eleven returns included eight of the first-class varieties—viz., the following:—Messrs. E. Berry, Roehampton, Surrey; W. Burns, Wykham Lodge, Horsham, Surrey; Cochrane, Finsbury Park, N.; James Garaway & Co., Bristol; Thos. Hobbs, Lower Easton, Bristol; A. Holmes, Hawthorns, Clapham Park; J. Holmes, Nightingale Lane, Clapham; Lansdell, Barkby Hall, Leicester; J. Lyne, Belvedere, Wimbledon; Pope, Northbrook House, Southampton; and C. J. Salter, Selborne, Streatham.

The remaining electors named less than eight first-class varieties, but they with those previously mentioned are equally entitled to our best thanks for the cordial and ready manner in which they have given us their assistance.

EASTER BEURRÉ PEARS.

I THINK there are few subjects connected with the cultivation of fruits harder to understand than the variation of Pears in size, flavour, and keeping qualities in different soils and situations. About ten years ago I took charge of a garden on the Bagshot sand formation. One of my first occupations was to plant a selection of fruit trees, including Pears, and many have been my disappointments as old favourites have proved quite useless, although the same varieties had done me good service on other soils. It would occupy too much of your space to relate all my failures. I will only say, that having a vivid recollection of sending a grand lot of Easter Beurré for dessert in February from a tree that grew on a south wall in the neighbourhood of Doncaster, I concluded that trees would do well as pyramids on a warm soil so much further south, and so planted six trees of that variety. They have borne a few fruits each year, but they were very small, very much cracked, and quite devoid of flavour until the last season, when they grew to a moderate size, did not crack, and the flavour was all that could be desired.

I planted one tree of the same variety on a wall with a south-west aspect that has given us much finer fruit, but the flavour has never been good. Last year it bore a good crop, the fruits of average size, about 8 ozs. We are using them at the present time, but they are very mealy, not to be compared with those grown on the pyramids which were about half the size, and, strange to

say, were ripe two months ago. I might write pages on the uncertainty of the time at which Pears will ripen at different seasons, one kind keeping good until Christmas, as a rule, then the next year upsetting all our calculations by ripening in October, but it would be only a waste of time and paper, as I know of no way of retarding them. This last autumn four kinds that should have kept until December were all gone by the end of October, while one kind that has always been ripe in October was good and firm in December.—G. B.

CROTON LEAVES IN FLOWER GLASSES.

ANYONE who has a number of flower glasses to keep supplied with cut flowers during the winter and spring months often finds it more difficult to obtain a supply of fresh Fern fronds than flowers, especially during the spring, as the fronds are cut as soon as they appear, and they keep fresh for a very short time in such a young state. For the last few years when filling our flower glasses we have always furnished a few with Croton leaves of different varieties, and find them both useful and effective. Large trumpet-shaped glasses with a few arching leaves of Croton Warreni give a graceful appearance, and for smaller glasses the leaves of the old variegatus section answer well, and save both Ferns and flowers. The plants that we denude of their foliage for this purpose are such as have been used for room-decoration. Those plants when put back to their old quarters, the stove, generally lose all their leaves by degrees, and it is best to cut them down and let them start afresh.—DAVID MURRAY, *Culzean Gardens*.

THE POTATO DISEASE.

At the recent annual meeting of the Highland and Agricultural Society of Scotland held at Edinburgh, Mr. Jas. L. Guild, Abbey Farm, North Berwick, moved "That, as the cultivation of the Potato is rendered very precarious owing to the ravages of disease, and as it appears that the best mode of resisting it lies in the raising and introducing new varieties, it be remitted to the Directors to encourage the same by the giving of premiums or otherwise." In supporting his motion Mr. Guild said, "From the time of its introduction to the year 1845-46 the Potato grew and flourished in almost perfect health, but in that year a dreadful calamity suddenly overtook it. It would be interesting to know what the meteorological conditions of that year were, so that we might try to account for the collapse which took place; but at any rate, it seemed as if a fiery vapour had passed over the land, for in a few days what were to appearance healthy plants were nothing but blackened shaws from one end of the country to the other; and so much dependance had come to be put on the plant in some quarters, especially in Ireland, that the result of its failure was disastrous, and an amount of famine and loss of life took place which was, happily, unknown before from such a cause in the annals of the country. From that year to the present no season has been entirely free from blight, and for the last ten years—owing, I suppose, to the amount of moisture and other atmospheric causes—disease has been rife, and great loss has been sustained by farmers. I have heard and know of whole fields being actually ploughed up owing to the quantity of sound tubers being too limited to pay the cost of lifting. That the cultivation of the Potato has raised the value of land is undeniable. In East Lothian alone I would estimate the rise from this cause at £2 an acre. Farmers have been growing Potatoes on land which was never intended by Nature to be used for that purpose, and the disease has been so bad on that class of soil that their cultivation will have to be given up, and rents reduced to their old figure. To show the great importance of the Potato cultivation, and the loss sustained by disease, I have made the following calculation. Of course, my figures are open to criticism, but I do not think I am guilty of any exaggeration. The total number of acres grown in the last ten years in Scotland, as given by the Board of Trade returns, is 1,682,627. I would estimate the average crop grown at 5 tons an acre, making 8,413,135 tons. Then the amount of disease per acre I would put at 20 per cent., or one-fifth, making a loss of 1,612,726, at say £3 a ton

But from this I deduct 75 per cent., used for cattle-feeding or other purposes—viz.,	
1,261,970 tons, at £1.....	1,261,970

And leaving a total loss to farmers and the country of

£3,785,911

If the whole of Great Britain be taken, the loss by a similar calculation is three times as great, being upwards of £10,000,000, or over £1,000,000 a year. I do not intend to take up the time of this meeting in speculating as to what is the origin or cause of this disease, it is sufficient for my purpose that the enemy exists, and that to an alarming extent; but I believe there is now little doubt that it is a vegetable fungus which first attacks the leaves, and is the result of fermentation under certain conditions of the atmosphere. Now, I am

quite well aware that commissions have sat, inquiries have been made, experiments have been tried to prevent or mitigate the plague, but hitherto without much success. While saying this, however, I must compliment Herr Jensen of Denmark on the energy he has shown on the subject; but the result of the experiments which have been conducted with his plough this year in East Lothian have not, I am sure, been, even to his own mind, very satisfactory.

There is one way, and one only, by which the disease can be overcome, and that is raising new varieties; and I trust that this meeting will show by their vote their sense of the importance of the subject. It has been proved beyond doubt by actual practice that the various sorts have a limited term of life. Where are all the sorts which were cultivated twenty years ago? The end has been the same in each case. They got too tender and liable to disease, and had to be given up. The once famous Regent is now practically in disuse. Pater-son's Victoria will soon follow. But that is not the worst feature in the case. Fifteen or twenty years ago there was an endless number of varieties; now there are only five or six in general cultivation, and all these are more or less diseased this year. To crown all, I know of only two new varieties ready to take their place, and everything points to the need of a society such as this stepping into the breach with substantial encouragement. I am sorry the Directors of this Society have seen fit to oppose my scheme. I have heard the argument used that it should be left to individual enterprise, there being plenty of payment in bringing out a new variety. Was there payment to the rearer of the Victoria or Champion? But even supposing there was, I deny that that removes the responsibility from this and kindred societies: that argument is utterly untenable. Why does this Society hold shows and give large premiums to the best of the different classes of stock? Is it not to encourage the rearing and breeding of that stock? There is no reason why the rearer of the best variety of new Potato should not also obtain a premium. Is it not the object of this Society to encourage, not one branch but all branches of agriculture? If that is so, then I leave my motion with confidence in the hands of this meeting. I consider that in times like these, when agriculture has received such a shock, that it is particularly the duty of a society such as this to do everything in its power to foster and encourage farming in all its branches, and I make bold to say that it will stultify itself if it refuses this small modicum of help to agriculture which I propose."

Mr. Gardiner, Chapelbank, seconded the motion.

Mr. Scott Dudgeon, Longnewton, said the Society were indebted to Mr. Guild for bringing forward this matter. He did not think the yearly loss was over-estimated at £10,000,000, for in 1879 the loss in Ireland alone was £8,000,000. The Directors, however, had not opposed the motion, but in the present stage of their funds they did not think they were justified in making a grant. A select Committee of the House of Commons sat on the subject two years ago, and agreed that the only hope of repressing the disease was by the creation of new varieties, and the Committee was of opinion that the Government should appoint in each country a superintendent to conduct the necessary experiments and furnish such new disease-resisting varieties. He moved that they memorialise the Government, and draw attention to the report of the Committee of 1880, ask what had been done, and press that the recommendations of the Committee be carried out. He had written to Mr. Barclay, M.P., on the subject, and had received a telegram stating that he did not think there was any hope of the Government doing anything.

The amendment was seconded, but after some further discussion Mr. Guild's motion was carried by a majority.—(*Irish Farmers' Gazette*.)

CHRYSANTHEMUMS AT KINGSTON-ON-THAMES.

In further reply to Mr. Douglas I have to say that it resolves itself simply to this—1st, That the whole horticultural press must be wrong or that Mr. Douglas is right. Let me quote the *Gardeners' Magazine*, November 25th, page 645:—"The other end of the Hall was occupied by a collection of specimens of the most magnificent character from the gardens of T. H. Bryant, Esq., Surbiton." "The most important of the specimens were those exhibited not for competition by Mr. C. Beckett, gardener to T. H. Bryant, Esq., Glencairn, Surbiton. These numbered about thirty, and comprised standards, pyramids, and dwarf-trained, the latter measuring from 5 to 7 feet in diameter, and all were splendidly flowered and highly finished. The dwarf-trained specimens were unquestionably some of the very finest that have ever been exhibited, and the liberality of Mr. Bryant and the skill of his gardener were warmly eulogised by the visitors to the exhibition." I believe the *Gardeners' Chronicle* said, "Trained specimens were poorly represented if we except the magnificent collection at the end of the Hall exhibited by Mr. C. Beckett, gardener to T. H. Bryant, Esq." I need not multiply quotations, your Journal was equally unanimous.

I should not have been so offended at Mr. Douglas's remarks had he not acted as a Judge at the show. Further, he left it two months before he ventures his opinion. However, it will take a much cleverer man than Mr. Douglas to alter a fact, and I most

emphatically re-assert all that I stated in my former letter.—
T. H. BRYANT.

AN AMATEUR'S HOLIDAY.

TWELVE months ago I drew attention to the distinctive features of a few nurseries, without a visit to which any holiday would be unsatisfactory. You may allow me without detail a glance at one or two of these. Although abler pens than mine have lately dealt with some of them, I have noticed a few plants that were either new or rare. I need not say that I found the broader features of each establishment, as the Roses of Belmont and Newtownards; the Pansies and Pinks of Paisley; the Pansies, Phloxes, and Pentstemons of Pinkhill, more than well sustained. I said a year ago that it would be difficult to produce improvements on such flowers as the Pinks and the Pentstemons we already had. In consonance with his convictions as to the early planting of Pansies when done in spring, Mr. Paul has already issued a circular. It is mainly occupied by the fine new sorts about to be sent out by him. It contains, however, six new Pinks. I have seen these both in the nursery and on the exhibition table. That they are added to the collection is sufficient guarantee of their excellence; I consider two of them at least unsurpassed. Mr. Downie's new Pentstemons, too, such as Mrs. Heywood and William McConnaehie, register yet another advance. I think I may fairly claim acquaintance with the Pink and the Pentstemon in many of the best varieties, and I am glad the growing of these two beautiful flowers is becoming more general among our amateur florists. Were it not that I shun the editorial séateur, I would, in the hope of enlisting more recruits into our ranks, dilate yet further than I have formerly done upon their attractions.

In one of the houses at Belfast I noticed the *Passiflora quadrangularis* with its large and striking blooms, and in the open air *Lilium longiflorum Wilsoni*, which was there of dwarfer habit than I have since seen assigned to it. A very attractive house of show and fancy Pelargoniums in beautiful condition was one of the many sights at Belmont. By much the best Dablias I saw were at Newtownards. They were remarkably good for any season, especially so for the last. The Tea Roses were even then rapidly ripening their wood, and were too great a temptation to be resisted. How a dozen or two will succeed with me out of doors remains to be shown.

At Rothesay I found Mr. Dobbie engrossed in harvesting his French Marigolds. I saw the large quantity of his equally fine A ters which he had previously secured in capital condition, and had a look over his Pansies, among which were some fine new varieties in the different sections.

At Pinkhill I saw the new black Grape which ought to be first-rate, honoured as it is to bear the name of John Downie. It has already been noticed in the Journal. I repeat by rote that it combines the best properties of the Muscat and Gros Colman, and I was lately told that its keeping qualities are quite satisfactory. I saw also in one of the houses a plant, not then in bloom, which I had never before heard of—a black *Richardia*-like plant. The flower is in shape and size like the ordinary Lily of the Nile, but in colour and texture like black-silk velvet. Mr. Downie, I believe, obtained it from a gentleman who a few years ago brought it from its native habitat in Egypt. Contrast recalls another flower that I heard of on the same day when, in the Royal Botanic Gardens, Mr. Lindsay pointed out a plant of *Gentiana acaulis* of which the flower is white.

In the Pilrig Nurseries I observed a very large plant of *Veronica Andersonii* and *Saxifraga MacNabiana*, with a sturdy habit and white and crimson blooms, both very desirable flowers. The plant of *Maréchal Niel* at Pilrig, mentioned by a correspondent some time ago, covers nearly 50 feet by 24 feet of the glass. It seems to produce flower buds almost all the year round, but the requirements of the other plants in the large house do not permit it having the treatment it would require for their development. I saw several fine buds on the last day of September. I quote the statement of a gentleman then present that there is a plant of the *Maréchal* at East Linton that is perpetual.

This is a short prelude to a sketch of some nurseries further north which will be given in a future issue.—A NORTHERN AMATEUR.

CLEMATISES AS ISOLATED SPECIMENS.—Clematisees as specimens on the lawn are very beautiful when well trained and attended to. At Holme Laey, Hereford, such specimens may be seen, and during the months of August and September they are pillars of bloom, and are much admired. They are planted out in well-prepared round beds, and trained to an upright round trellis about 7 to 8 feet high; they are about 2 feet 6 inches in diameter at bottom, and taper to the

top. As the young growths appear they are tied down for about two months. If they are allowed to grow straight up at first the base does not get properly furnished. As the plants increase with age tie or peg some of the old wood at pruning time down close to the ground, and regulate the other up the trellis as required, when, if properly trained, at flowering time they are one mass of bloom from the ground to the top of the trellis.—A. YOUNG.



"F. P. D." writes as follows concerning CARBOLIC ACID AND GLYCERINE AS AN INSECTICIDE:—"The value of carbolic acid for destroying mealy bug and other horticultural pests is testified to by your correspondent 'C. P. P.' Like many others, however, he appears to think the acid is nearly insoluble in water. The fact that the addition of a little glycerine to the acid before its dilution renders it perfectly soluble in water is not generally known. Anyone who takes the trouble can, however, in this way secure a perfectly reliable insecticide of any strength required."

— A LARGE cultivator of Potatoes in Kent informs us that MAGNUM BONUM is now, and has been for some time, realising the highest prices in the London markets, and he states it is the same in most other large markets in the kingdom.

— WE shall shortly place before our readers estimates of POTATOES FOR TABLE USE AND MARKET PURPOSES which have been sent to us by many of the leading cultivators in most of the counties in Great Britain and Ireland. As the nature of the soil, time and mode of planting, manure employed, and an outline of culture are given in most cases, information of practical value is provided at an opportune time—the eve of the planting season.

— A CORRESPONDENT in Surrey sends us some blooms of the JAPANESE CHRYSANTHEMUMS MEG MERRILEES, CRY KANG, and ETHEL, which are remarkably bright and fresh for this time of year, and we should be glad to have a few notes from him respecting the method of culture he has adopted.

— THE DUNDEE HORTICULTURAL SOCIETY will hold a Floral Fête on August 23rd, 24th, and 25th of the present year, when a large number of valuable prizes will be offered for plants, flowers, fruit, and vegetables, 203 classes being enumerated in the schedule. The financial report for the past year states that the Society has a balance of £324 in its favour.

— MR. JOHN LESLIE, The Gardens, Springkell, Ecclefechan, writes:—"I enclose table of RAINFALL registered here for each month during the year 1882. You will observe that July has the heaviest rainfall. We had during that month some of the heaviest showers that ever were known in this district—January 1.64 inch, February 3.77 inches, March 2.97 inches, April 4.11 inches, May 2.2 inches, June 4.34 inches, July 10.8 inches, August 4.44 inches, September 2.33 inches, October 3.55 inches, November 3.95 inches, December 4.01 inches; total 48.11 inches."

— THERE is evidently a good demand for CHRISTMAS ROSES—i.e., HELLEBORES, for we have recently noticed that several florists in the metropolis are charging 3*s.* per bloom for them. These are chiefly of the large-flowered pure white variety of *Helleborus niger maximus*; but even some of the smaller forms realise good prices, and in Covent Garden they are freely employed in bouquets. Indeed, a really fine flower of *maximus* is but little inferior to a *Eucharis* bloom, and some prefer the former, as the latter has a bad centre for bouquet work. We have heard of a grower who states that he has realised £60 in one season by forcing Hellebores early and sending the blooms to special markets.

— MR. R. P. BROTHERSTON sends a good flower of CHRYSANTHEMUM FAIR MAID OF GUERNSEY, which he states is the first produced by some plants upon which he has been experimenting with the view to obtaining late flowers. Though rather loose the bloom was attractive, and such flowers would prove useful at this season. Perhaps he will relate his mode of treatment.

— WE have received from the Science and Art Department, South Kensington, a notification respecting the ST. PETERSBURGH INTERNATIONAL HORTICULTURAL EXHIBITION AND BOTANICAL CONGRESS that is to be held this year, and to which we have previously referred.

— "THERE is nothing," writes a correspondent in reference to CHOICE FLOWER SEEDS, "which causes so much disappointment to the amateur as, after spending 5s. upon a small packet of choicest seed, to find the plants produced bear blooms which are worthless. This has just happened to me with a large batch of Cinerarias. Had I known what the seed was I would not have accepted it as a gift. It is very trying to find one's money, time, and trouble all wasted and the house cumbered with plants fit only for the refuse heap as soon as the blooms expand."

— IN Covent Garden Market ORCHID FLOWERS now form an important portion of the florist's stock at nearly all seasons of the year. At the present time the useful *Dendrobium nobile* is strongly represented, many cutting the entire growths instead of sending the flowers singly. Some richly coloured varieties of this Orchid are frequently seen, and they are difficult to surpass; but some of the bouquetists have a curious method of arranging *Dendrobium* flowers with the lip uppermost, which has an unnatural appearance, though the colour in the lip can be seen better. *Odontoglossum Alexandræ* and *O. Pescatorei* are evidently indispensable, while *Lælias*, *Cattleyas*, and many others in their season are largely represented.

— A CORRESPONDENT writes:—"In an essay by Dr. H. P. Walcott upon CHRYSANTHEMUMS AND THEIR CULTURE, which was read before the Massachusetts Horticultural Society early in the present year, and reprinted in the *American Cultivator*, occurs a statement which will somewhat astonish those who are familiar with English exhibitions. After commending the system of culture adopted here, the essayist states that 'only incurved blooms are shown at the great London shows.' It would be difficult to understand whence the doctor obtained this piece of information, and he certainly cannot read the English horticultural periodicals very carefully, or he would not have committed so strange a blunder."

— MR. FOSTER informs us that he has placed the entire stock of his FOSTER'S SEEDLING POTATO in the hands of Messrs. Pennell & Sons, nurserymen, Lincoln. This variety, it may be remembered, was, after being tried at Chiswick, awarded a first-class certificate by the Royal Horticultural Society in 1881.

— AN excellent cultivator and competent judge of Orchids sends us the following note on *DENDROBIUM LEECHIANUM* (*D. nobile* × *heterocarpum*):—"Mr. Swan has sent fresh flowers of three of the best forms of this charming hybrid *Dendrobe*, all distinct in size and colouring, but characteristically alike in structure and parentage. Mr. Swan has bloomed eighteen plants of this fine hybrid this season, some of the varieties closely approaching *D. Ainsworthii* (which is of the same parentage), while others are as fine, if not even finer, than *D. splendidissimum*. All are beautiful, and Mr. Swan and his worthy employer may well feel proudly gratified at having reared such a free-blooming and useful hybrid to their collection, wherein, we believe, *D. Leechianum* is unique."

— WE learn from the *Essex Times* that a PRESENTATION TO MR. JAMES DOUGLAS was recently made by the scholars and

teachers of the Congregational Sunday School, Barking, where he has been teacher and superintendent for the past nineteen years; and as he is about to leave Loxford Hall Gardens for Mr. Whitbourn's new estate, Great Gearies, it was thought a fitting opportunity to accord him some recognition of their esteem. The presentation took the form of a handsome marble timepiece and a pair of tazzas to match.

— "J. J." writes:—"A short time ago a note appeared in the Journal from the *Irish Farmers' Gazette* in which it was stated that it 'had been demonstrated that dwarf plants of *LUCULIA GRATISSIMA* with fine heads of flower can be grown in 6-inch pots.' If any of your correspondents can give instructions for doing this I should be much obliged. I have had partial success, but I have never been able to maintain a plant in good health. The plants sent out from nurseries are generally poor specimens struggling for life; and when visiting some of the best nurseries to choose one with a determination of making one more attempt to grow it, I have never succeeded in finding anything worth having. Why is this? It is a beautiful plant, and as sweet as beautiful. Can no one solve the problem of its easy culture?"

— VERY attractive in the Orchid House at Kew just now are several plants of *LÆLIA ALBIDA*, which is one of the prettiest of winter-flowering Orchids. The flowers are pleasingly fragrant, of moderate size, and are borne five or six near the end of a raceme 18 inches to 2 feet long. The sepals and petals are narrow, pure white, the lip being white, streaked with purple at the base and having a yellow ridge in the centre. A variety termed *bella* is also grown, and is easily distinguished from the species by the sepals and petals being tipped with purple, affording a charming contrast to the pure white blooms of the ordinary type. Both succeed well on blocks in a warm house. *Lælia furfuracea* is flowering freely on a block, the pale mauve sepals and petals being tipped with purple, the lip of a similar colour, with the wings white. In the same house *Ornithidium Sophronitis*, a diminutive Orchid, is also noteworthy for its numerous small orange-scarlet flowers; and in a small pot suspended from the roof it both grows and flowers freely. The fragrant *Dendrobium aureum* perfumes the East Indian house most agreeably. One fine specimen is flowering abundantly, its long-noded growths having in some cases twenty or more flowers borne in pairs and triplets. The sepals and petals are yellow, the lip orange or brownish. It is grown in a basket, the stems being somewhat pendulous.

— THE official returns of the WINE HARVEST IN ALGERIA for the past year show rapid progress in the cultivation of the Vine in the French dependency, although in France itself, owing to the ravages of the phylloxera and the bad weather, the very reverse has been the case. The total area of land now devoted to viticulture in the provinces of Algiers, Constantine, and Oran is 23,724 hectares (about 59,000 acres), of which 19,700 hectares produce the black, and 4,024 the white Grape. In 1878 the total area was only 17,614 hectares. The yield of wine during last year was 400,197 hectolitres (about 9,500,000 gallons), showing a considerable increase as compared with the returns for the preceding year.

— TORONTO in Canada, following the example of Chicago, is engaged in LAYING OUT A BOULEVARD which is to encircle the whole city, and is to consist of a road 100 yards wide, adorned occasionally with flower beds. A "Rotten Row" or riding alley is also to be provided, and the whole is to be preserved and kept in order at the public expense. The similar boulevards at Chicago are a great success, and are much appreciated by the citizens of that densely peopled city.

— IN Signor Berti's project for REPLANTING FORESTS IN

ITALY, the sum of about forty-eight million francs is thus distributed among the different provinces:—Piedmont, seven millions; Lombardy, nine millions; Venetia, two millions; Liguria, two and a half millions; Emilia, eight millions; the Marches and Umbria, one a half million; Tuscany, two millions; Lazio, 139,000; Meridional Adriatica, four millions and a half; Sicily, three millions; Sardinia, five millions; Meridional Tirrena, 2,800,000 francs.

— IN the *Journal of Forestry* for the present month Dr. Lyons, M.P., has an able and exhaustive article upon the RE-AFFORESTING OF IRELAND, which we commend to the attention of all who are interested in this important subject. Dr. Lyons has chiefly considered the matter in an historical point of view, stating the means by which the extensive forests that once existed in Ireland have been gradually destroyed, and also the remedial measure adopted or advocated at intervals during later years.

— THE *Manchester City News* records the death of a well-known local botanist, Mr. W. HORSEFIELD, which took place on the 17th ult. "He was born April 16th, 1816, at Besses. His father was John Horsefield, who died in 1854. This John Horsefield was a botanist well known in his day throughout Lancashire, and, like many northern botanists, he was a working man. His son William, brought up in a home where botany was the constant subject of conversation, acquired a love for that delightful science, and from his boyhood he entered heartily into the study of it. He was much given to botanical excursions, and in company with another well-known botanist, James Percival, he rambled over some of the most beautiful parts of Yorkshire and Durham. For many years he was President of the Prestwich Botanical Society, and for upwards of twenty years he filled the office of postman at Whitefield. He was highly respected in the neighbourhood in which he lived as a man whose character was without reproach."

PEARS AND APPLES IN THE NORTH.

COMTE DE LAMY is the most satisfactory and prolific Pear I had this year. I have only three trees—one against a west wall, the other two bush fruit trees which have not been much pruned, but allowed to extend their outer branches as they were alongside a wire fence. All three trees fruited this year and ripened well. Like all other districts we suffered from the severe gale of April 29th. I was away from home at the time in Devonshire at Torquay. I had left my trees behind a most promising mass of bloom, but, as was the case in the south—(for I never witnessed such havoc as there was to the tender foliage and opening blossoms of all kinds of deciduous trees, not only of the Pears and Apples, but of the Horse Chestnut, Hawthorn, Laburnum, &c.)—so it was, I found, in the north, though the gale was not quite so severe. I left an espalier of Zéphirin Grégoire Pear, for instance, quite covered with bloom. When I came back, as it was more exposed to the direct influence of the westerly gale than most of my Pears, there was hardly a leaf, and certainly no vestige of a blossom left. It made fresh growth, and, oddly enough, even blossomed again late in August. The only position where I had any fruit on Apples and Pears was on the easterly side of the larger and older-established Apples which were not so exposed to the gale—a great contrast to the extraordinary crop of 1881, when we could hardly find room to store them. Louise Bonne of Jersey Pear, on a young bush tree, was also good with me.

Beurrié d'Amanlis Pear is, in my opinion, much overrated merely because it looks well on the table, but it has been voted here very little better than a Turnip. Beurrié Diel, again, is not worth growing north of the Trent.

Amongst Apples I can strongly recommend as sure bearers Winter Hawthornden and Margil, and till one has grown Cox's Orange Pippin against a south wall or in an orchard house we do not know what a really fine-flavoured and valuable Apple it is.

One of the best and most highly flavoured and certain bearers amongst the early Apples is Irish Peach, and among the later sorts Wyken Pippin, which has rarely failed with me, and though only small is a very good-flavoured Apple. Here in the north the old Cockpit is good; Improved Cockpit, which, though a larger Apple, keeps no better; Scotch Hunthouse, and Wellington or Dume-

low's Seedling are still the best for kitchen purposes during the winter, and the old Keswick Codlin and Lord Suffield to begin with; then follow old Hawthornden and Golden Noble, with Alfriston and Warner's King, which many persons are inclined to keep too long. I find it best with me in November and December, and it is one of the best kitchen Apples we have.—C. P. P.

RIPENING CHRYSANTHEMUM WOOD.

THIS is a subject of much importance, and should not be passed over without consideration and discussion. I have been anxiously waiting to see what the advocates of the "ripening system" had to say on this matter. If I am not mistaken the ripening of the wood has in previous volumes been advocated as essential, and one of the most important points in the culture of the Chrysanthemum towards producing compact, well-shaped, symmetrical blooms of the finest exhibition quality. But now, although a writer on page 22, who is evidently not a tyro in Chrysanthemum culture, has stated he attaches very little importance to ripening the wood, no one in favour of the practice has given the result of his experience. Has the practice been abandoned for a more liberal system of cultivation?

Like "Grower and Exhibitor" I consider there is no importance to be attached to the ripening of the wood, and that it is unnecessary and a waste of the energy of the plants to bring them to a standstill by keeping them in small pots or in any other manner to render the growths hard and woody. The past season has been notable for the absence of sun, and the blooms generally last autumn were not behind in size or quality those of any previous year; in fact, the past three or four years have been remarkable for heavy rainfalls and an absence of sun, yet during those seasons Chrysanthemum culture has made rapid progress, and blooms of equal merit were not staged at any previous shows that I had the pleasure of seeing. I prefer by no means sunless seasons in which to grow Chrysanthemums, but the past shows what can be done with unripened wood. I maintain that if the plants are potted as they require it, grown without check in an unshaded position, and secured to stakes so that air can circulate amongst the foliage freely, the wood will ripen sufficiently as it is made in a natural manner without the assistance of artificial means. That finer blooms can be produced after hot dry seasons has yet to be proved. What say others?—SCIENTIA.

YOUR able correspondent Mr. G. Lyne, refers to my observations on ripening the wood of these plants. I have seen much trouble taken, and no doubt he has too, to place plants in a position where they could receive all the rays of the sun possible, such as at the front of a south wall, with the object of ripening the wood. I have seen them kept for weeks in small pots to harden the wood, and have known water withheld for a time with the same object. These are practices that have been adopted, and it is making the stems quite hard and woody by such means that I objected to. I do not hesitate saying that such extreme and artificial ripening means destruction to the lower foliage. Your correspondent will admit that when the wood is very hard that the flower buds seldom open in a satisfactory manner, but come one-sided—in fact, are generally useless.

I know the Chrysanthemum requires a light and airy position, therefore I stand the plants in single rows by the side of walks. I did not assert that the plants will grow satisfactorily in a shady position. As for buds formed in October, I should remove them promptly, as I am sure they would be robbing the principal flowers.—GROWER AND EXHIBITOR.

CYPRIPEDIUMS.

THOUGH dispersed so widely through the northern hemisphere the species of the genus *Cypripedium* bear a strong likeness to each other in the form of their flowers, and there are few Orchids which are so easily distinguished by the uninitiated as the members of the Lady Slipper family. This is chiefly due to the prominent pouch-like labellum which in most Orchids is strangely formed, but in few large genera is the shape so uniform as in that being now considered. Both hardy and tropical species, European, Asiatic, and American, bear this peculiarly modified organ that is so obviously of special importance in the attraction of insects to aid in the fertilisation. The old designation of the British species (*C. Calceolus*), *Calceolus Marianus*, the general title of Ladies' Slippers, and the American *Mocassin Flowers*, have all been derived from the form of the lip, and the generic name, literally Venus's Slipper is also a classical rendering of the same peculiarity. The greatest difference is that between the hardy

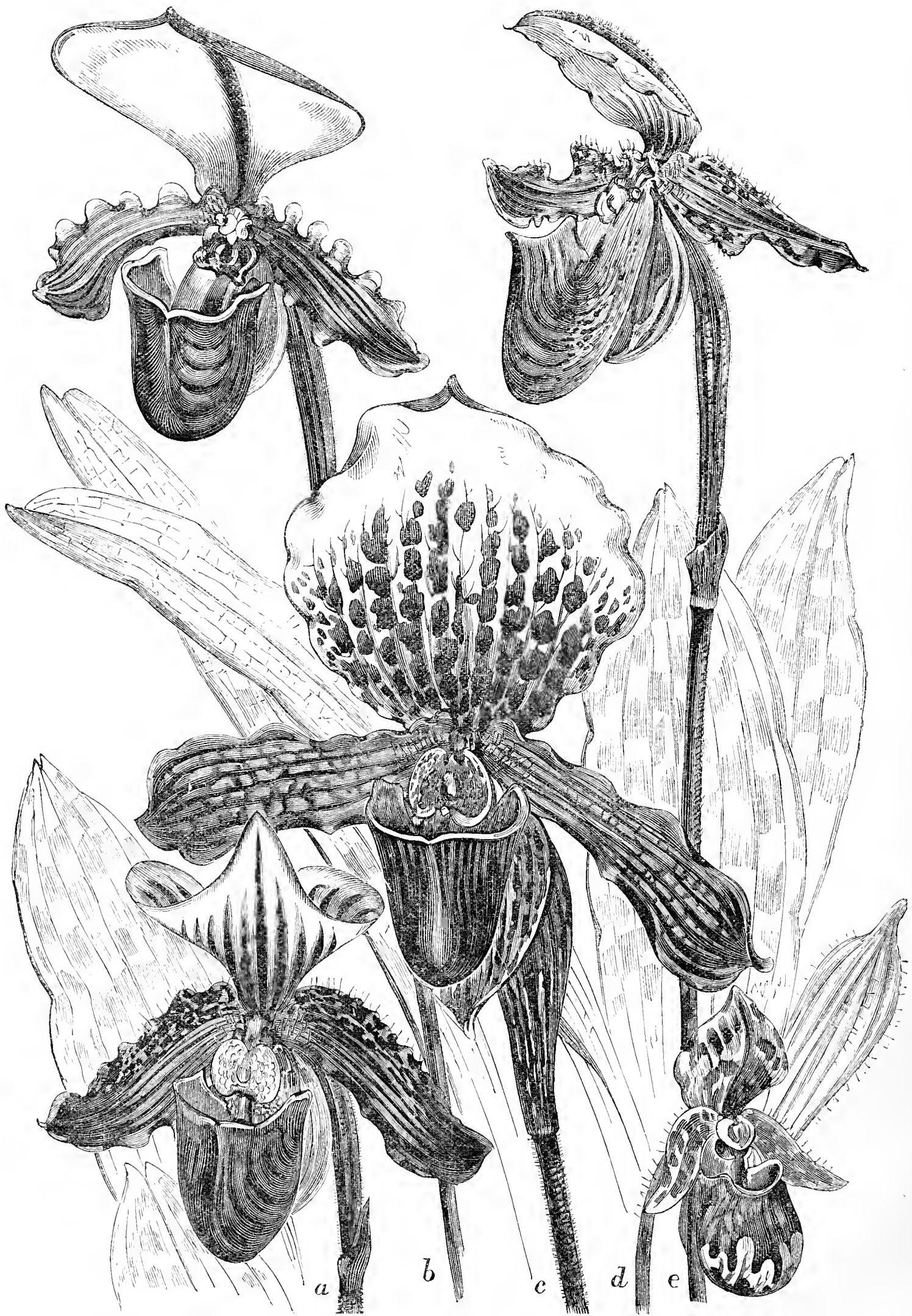

Fig. 26.—*a*, *Cypripedium purpuratum*; *b*, *C. Spiciferum*; *c*, *C. punctatum violaceum*; *d*, *C. guttatum*; *e*, *C. Bullenianum*.

and the tropical species, the latter being evergreen, and the former producing larger lighter leaves that die each year as winter approaches.

Structurally there is a great similarity in the flowers, though they are widely separated from all other Orchids by several strongly marked peculiarities. The most remarkable of these are in the pollinia and column. It is well known that the column of Orchid flowers is regarded as the result of a combination of the pistil with three stamens, and in the majority of species two of these stamens are suppressed, and the anther of one only appears as the pollen masses under the cup at the apex of the column, the stigma being confined to a cavity lower down on the column. In the *Cypripediums*, however, there is a singular divergence from this character: the apex of the column, instead of producing the one anther—*i.e.*, the pollinia, has a large flat angular expansion, two anthers being developed, one on each side of the column below the apical plate. This anyone can readily observe by carefully dissecting a flower, and the method by which cross-fertilisation can be effected, if desired, will be at once apparent. So strange a structure has reference to cross-fertilisation by insects, which in several species is effected in a peculiar and interesting manner.

The species are mostly terrestrial in habit, though a few are found occasionally upon trees in their native localities, the deciduous section being confined to the northern portion of the Old and New World, while the others are found in the Indian Peninsula and Archipelago, the warmer regions of North America, and even in Peru. Of the tropical Ladies' Slippers many have beautifully blotched or marbled leaves, the variegation taking the form of irregular transverse bars, or dark green spots and blotches on a lighter ground; and, like some of the *Phalænopsids*, these plants are handsome at all times of the year, whether flowering or not. The leaves are produced in a two-ranked (distichous) manner—that is, they are arranged opposite each other after the style of the *Vandas* and similar plants; they, however, vary considerably in length and breadth, the plain green forms having the most narrow leaves, and usually the longest. None of them produces a pseudo-bulb, though in the case of the hardy species, which lose their foliage annually, this is supplied by a tuberous rootstock, from which the growth is developed each season; the latter also commonly attain to a greater height than the evergreen forms, which do not reach any great dimensions, fresh growths being produced from the base, and there is thus more tendency to lateral than upward extension. The flowers are generally produced singly (or in pairs) on stems a foot or more in height that arise from the centre of the growths or axils of the leaves; and one remarkable character of many of the species is the great time the flowers continue in good condition upon the plants, often exceeding a month, and in some cases even continuing fresh for six weeks. Flowers also last exceedingly well when cut from the plants, and are thus very useful for floral decoration, though the strangeness of their form unsuits them for arranging with most other flowers, and they usually appear best alone.

CULTURE.—*Cypripediums* are not difficult to grow, and one or two of them may be ranked amongst the most useful and easily cultivated Orchids known. One very important point to observe is that as regards the tropical species, with which we are now concerned, no distinctly marked season of rest, like that needed by many of the pseudo-bulbous Orchids, is requisite. Any attempt at regularly withholding water at certain seasons will result in failure, as all Orchid growers know perfectly well, but an amateur at the first attempt might be induced to give incorrect treatment in this respect. Water must be constantly supplied at all times; but in the winter greater care is needed, especially with some of the delicate sorts, as, though impatient of any approach to drought, they are nearly as much injured by too liberal supplies at the dull season, as the plants are then liable to suffer from damp, especially if a suitable temperature cannot be maintained. The house devoted to East Indian Orchids suits the majority of tropical species, but they will also thrive very well in an ordinary stove; and this is a great advantage, for there are many establishments in which a house cannot be set apart for Orchids alone. The shady side should be preferably assigned to them, otherwise they will need careful shading when the sun is powerful.

As regards soil they are also not very particular, all succeeding very well in a compost of peat, sphagnum moss, and sand, the stronger-growing sorts being benefited by a moderate proportion of light turfy loam. It is strange, however, in what seemingly unsuitable soils Orchids, and amongst them *Cypripediums*, will often grow satisfactorily: for instance, I once visited a small garden where the stock of plants grown under glass was very limited, and the Orchids represented were two species only—namely, *Odontoglossum Alexandræ* and *Cypripedium insigne*.

These were potted in a mixture of old mortar rubbish, turfy loam, and sand, and yet the plants were in most vigorous health and flowered as freely as could be desired by the greatest admirer of Orchids. I should not, however, advise a trial of this compost, though the fact is noteworthy as showing that the importance often attached to special soils mixed in exact proportions is not altogether invariable.

The species in cultivation are numerous, and the hybrids that have been obtained in recent years greatly increase the number of sorts, so that now there is a long list to select from. The following notes are devoted to a brief consideration of these under the heads Tropical and Hardy Species.

TROPICAL CYPRIPEIDIUMS.

These may be conveniently arranged in four groups—those with marbled or variegated foliage, those having plain green foliage, the *Selenipedium* section, and the hybrids that have been obtained between the preceding.

SPECIES WITH MARBLED FOLIAGE.—One of the best known in this group is *C. barbatum*, which is a really useful Orchid, and ranks high in the favour of amateurs and others. The chief beauty of the flower is in the large size and pretty markings of the dorsal sepal, which is of rounded or heart-shaped form, white at the upper part, streaked and clouded with purple of varying degrees of redness at the lower part. The lip is very dark, often nearly black, the petals being dark purple with a row of little tufts of hair on each margin. It is one of the Indian Archipelago species, being found in Java and contiguous localities. Several handsome varieties are in cultivation under the names of *nigrum*, *superbum*, *Veitchianum*, &c. *C. biflorum* is an Indian species closely related to the above, but by no means so well known. Its foliage is more attractively mottled, and it flowers earlier than *C. barbatum*, usually in the present month, but, like that, its blooms are very durable, continuing in good condition for a month or six weeks. *C. concolor* is readily distinguished from the other species. The petals and dorsal sepal are nearly equal in size and form, elliptical, creamy yellow with numerous small dark dots, the lip being comparatively small. The foliage is beautifully marbled, and alone renders the plant worthy of cultivation. A little limestone is needed in the compost employed for this plant, and it succeeds well in an ordinary stove. *C. Dayanum*—the foliage of this species is more beautiful than the flowers, the latter being green, white, and purple, but it is noteworthy as commemorating the name of J. Day, Esq., of Tottenham, whose magnificent collection was dispersed a year or two ago. *C. Hookeræ*—this again has very handsome foliage, indeed it is one of the best in that respect, but the brownish-purple flowers cannot be compared with many others of the genus as regards beauty or brightness. *C. Bullenianum* (fig. 26, *e*) is a Bornean species related to *C. Hookeræ*, but it is even more attractive in its foliage, the contrast between the dark spots and the light ground colour being very striking. *C. purpuratum* (fig. 26, *a*) is another species with dark spotted foliage; the flowers, too, are rather pretty, the dorsal sepals being white, veined longitudinally with purple; the petals are broad purple, and the lip of similar colour. It is a native of the Malayan Archipelago, and was introduced by Mr. Knight of Chelsea nearly half a century ago.

That handsome Bornean species, *C. Lawrenceanum*, which Mr. F. W. Burbidge introduced for Messrs. Veitch & Sons, must not be omitted from this group, as it is one of the best of those with ornamental foliage. The flowers are of great size, the dorsal sepal being very broad and rounded, distinctly veined with dark purple, the streaks extending from the base to the margin following the contour of the sepal. The petals are tinted with purple, and have a few dark wort-like protuberances near each margin, along which there is also a row of hairs. The lip is brownish with a purple tinge, and the leaves are beautifully marbled with light and dark green. It is exceedingly free, and was well chosen to commemorate the name of Sir Trevor Lawrence, Bart., who is widely famed as one of the chief Orchid lovers of the present time.

GREEN-LEAVED SPECIES.—One of these which has come into very prominent notice recently is *C. Spicarianum* (fig. 26, *b*). It is a native of the East Indies, and was introduced a few years since by Mr. Spicer, in honour of whom it is named. It passed into the possession of Messrs. J. Veitch & Sons of Chelsea, and soon became known to the Orchid-growing world. Careful search was made for it, and quite recently Messrs. Sander & Co. of St. Albans succeeded in obtaining a large quantity of plants, which were sold at Mr. Stevens's Rooms, Covent Garden, and is now to be seen in many collections. Before the latter introduction small specimens had realised sixty guineas, and as much as one hundred guineas had been given for larger plants. The large white dorsal sepal contrasting with the reddish brown lip and

greenish petals, gives a very distinct appearance to the flower; and as it appears to share the free-flowering qualities of *C. insignis* it will doubtlessly become as popular as that species.

Notes on the other members of this group must be deferred. The woodcut represents five good *Cypripediums*, three of which have been already noticed. The other two are *C. punctatum violaceum* (*c*), which has violet-dotted attractive flowers, and *C. guttatum* (*d*), a pretty terrestrial species from Canada and Siberia, with white flowers marbled with rich purple.—L. CASTLE.

(To be continued.)

GRAFTING.

JUDGING from inquiries we have received during the past few weeks it is evident that the subject of grafting fruit trees is one on which information is needed, and it is certain that there are

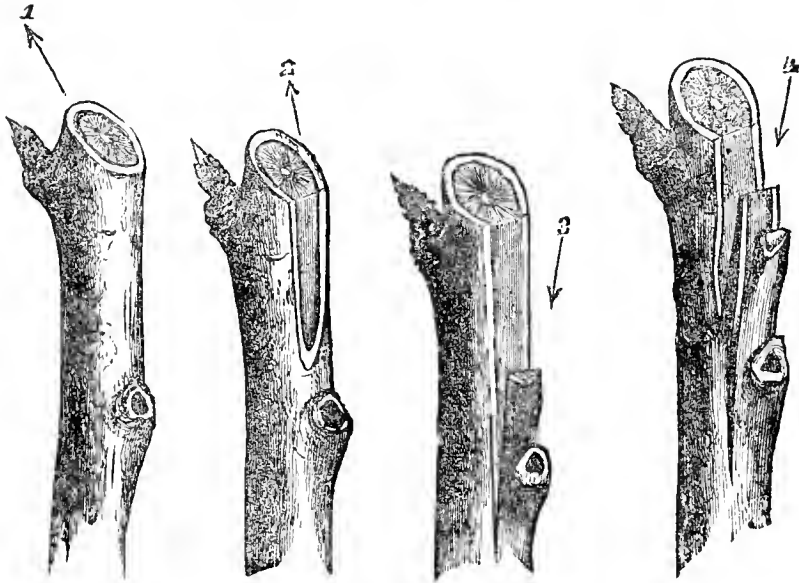

Fig. 27.

Fig. 28.

Fig. 29.

Fig. 30.

many persons, young gardeners and older amateurs, who are not so well acquainted as they should be with the old and most valuable practice of the art of gardening.

"Everyone should learn to graft" wrote Mr. Kingsley in this Journal upwards of twelve years ago, and he related an incident of when a boy of cutting scions from all the Pear trees in the garden, and attaching them to a young Jargonelle with withered Crocus leaves, at the same time cutting out all the buds that naturally belonged to the tree. Years afterwards this was regarded as a wonderful tree by the owner, as every branch bore a different variety. This incident is alluded to as showing how easily learned is the process; and Mr. Kingsley further observes, for the benefit of the inexperienced, that all grafting is performed by fitting one or more buds of one variety (the scion) to another (the stock), which is growing from an established root, and this fitting must be managed so that the living layers (the alburnum) of the wood of both are brought into close juxtaposition, so that the cambium, or fresh deposit of living cells and fibre, may unite, the former being suitable for young trees or small branches, the latter for larger trees that have been "headed down."

The best time for grafting is usually the first half of April, but in early seasons and localities an earlier date is better. The stock should be on the point of bursting its leaf buds, but the scion must have them much less advanced for ordinary out-of-door work. To secure this difference of development the scions are cut off a month at least before the time of using them, and may be cut off as soon as the leaves have fallen. They require to be kept from drought and frost, and the common way of storing them is tie each sort in a bundle, and put it two-thirds of its length in the ground in the open air, under a north wall or other shade from the sun. Perhaps a better plan for keeping is to put them overhead in cocoa-fibre refuse in flower pots, storing the pots in a cool cellar or outhouse, and taking care that the fibre is neither dry nor wet, but only thoroughly damp; scions so stored will keep perfectly sound for a very long time, frequently striking root, and always forming a callosity at the base. Sand used in the same way answers very well, but it is apt to damage the knife if any is left when the scion is being shaped; the cocoa fibre shakes off, leaving the wood quite clean.

The scions are cut from thoroughly ripened shoots of the preceding summer; where it can be done, a piece of the previous year's wood should be cut off along with the new, for if the scion is fitted so that the junction of the two years' growth is applied to the stock, a much larger portion of the living tissue is brought into contact. Some kinds of trees require the second year's wood

to be taken for the scion; and although the fruits we are dealing with do not, I would rather have a scion of the second year's wood than a badly ripened shoot of the previous summer. The buds on the scion must be leaf buds, and the plumper they are the better. Avoid all those succulent shoots commonly seen on the stems of old orchard trees.

We now come to the tools required; they are very simple—a very sharp knife, some matting or yarn for tying, grafting wax or clay to cover up the joint.

As the knife must be in first-rate condition for the most delicate part of the operation, it should never be used for rough work, so use another for cutting off the heads of the stocks and any other preliminary trimming.

Various modes of grafting are adopted for particular purposes. For our present purpose two only are needed—whip or tongue grafting, and crown grafting.

All the books in which I have found a description of grafting seem to me to be very defective in more than one particular, and I shall endeavour to make the matter perfectly clear at the risk of being tedious. A glance at the figures will explain to any experienced gardener all that is new.

Cut down in the autumn all the stocks that are to be grafted in the spring, and any branches of larger trees that are to be grafted afresh, leaving in every case about three eyes beyond the part where the scion is to be placed, at the same time trim off any laterals that require removing. This cutting-back in autumn prevents the check that would otherwise be given to the stock were it cut back after they had begun to move. Then, as soon as the buds which have been left are on the point of opening, choose a day that is calm and warm; if there has been rain shortly before all the better. Cut off the top of a young stock down to a distance of 3 inches from the ground or thereabouts, less rather than more. The cut should be made by putting the edge of the sharp knife just opposite to a bud and bringing it out an eighth of an inch or so above the bud, making the cut quite clean and even, with a very gentle slant, 1 (fig. 27). Next put the knife to a point about an inch below the place where it was first applied, and cut a thin slip upwards, 2 (fig. 28). This slip should remove the bark and a small portion of the wood, but it ought as far as possible to be a section of that layer of living tissue which throws off a ring of wood on one side and a ring of bark on the other: the size of the scion, however, must be the principal guide as to the thickness of the slice cut off, and it is here that correctness of eye is of so great importance. Next reverse the direction of the edge of the knife and run it downwards, beginning at the bottom of the last cut, and keeping the slip the same size, so as to form a flap about an inch long, 3 (fig. 29); and then, again, if the scion be not very small, make a second downward cut, 4 (fig. 30)

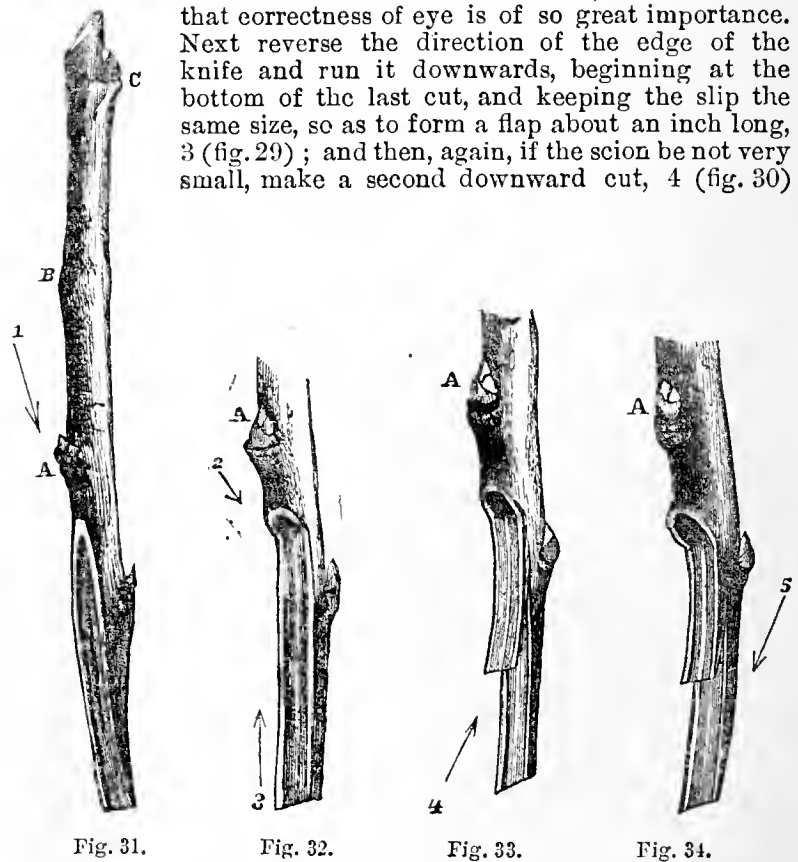

Fig. 31.

Fig. 32.

Fig. 33.

Fig. 34.

starting about half an inch from the top of the stock, and about three-quarters of an inch long. These four cuts are numbered in order in the figures, and the barbs show the direction in which they are made. With practice you will make them in about as many seconds. This is all the preparation needed by the stock.

We now come to the scion. If it has been well kept the base will be perfectly sound, and most likely will have a large callosity formed from the wound. If it is one having a piece of the second

year's wood cut it through an inch below the junction of the two-years growth, and cut it through again above the third bud above the junction. Commonly this will leave a shoot about 4 or 5 inches long. Now look out for the lowest of these three buds, A (fig. 31), and putting your knife from an eighth to a quarter of an inch below it, bring the cut out at the base at the opposite side, forming the bottom of the scion into a wedge, 1; secondly, make a cut, beginning at the same point as before, and slanting exactly the same as the top of the stock, 2 (fig. 32). A little practice will teach you to make this slope always at the same angle; it matters very little what the amount of slope is provided it is not a violent one. The depth of this cut must depend on the thickness of the stock and scion. If the scion is small, and the stock moderately small, this cut should go nearly half through the scion; if the scion is nearly as thick as the stock, the cut should go just half through; but if the stock is much larger than the scion, the cut should go more than half through—just beyond the pith. Thirdly, reverse the knife, and beginning half an inch from the base, make a cut upwards, 3 (fig. 32), to meet cut 2. Fourthly, if the scion is thick enough make another cut upwards, 4 (fig. 33), beginning a little below the middle of the wedge to form the tongue to fit into the opening made in the stock by its cut No. 4 (fig. 30). Lastly, cut a thin slip from the opposite side about an inch long, 5 (fig. 34).

Now fit the scion on the stock, as in fig. 35, slipping the point under the flap and the point of the tongue into the slit made for it, taking care to bring the two slanting portions into close contact, and, above all, being quite sure that the layers of living tissue are accurately joined. This can always be managed for one side, and if the cuts on the stock have been made of the right size, the inner bark will fit on both sides. The outer bark of the stock is generally much thicker than that of the scion, therefore the scion will stand a little within the outer contour of the stock.

Bind the scion and stock firmly together, but not so violently as to bruise either of them. Begin about the middle, and first work downwards, and then wrap the yarn regularly up; and if the scion is properly put on the two slanting pieces at the top will be brought into close contact by the presence of the band. The top of the stock is the most important point for the union to be perfect.

Finally, apply a coating of grafting wax or clay; I prefer the wax. There is a sort manufactured in Paris that is used cold, and is the best I have met with; but any of the common sorts made by softening pitch with lard or tallow, &c., and used warm, are far more convenient than clay, and a dozen grafts can be covered up with the wax in the time required for claying one. If, however, you like to refresh your early memories of clay pies, the application is made thus:—Take a piece of clay about as large as a rather small egg, roll it into a round ball in your hands, then putting it into the palm of the left, beat it out into a flat cake with the right. Take this cake and bend it round the joint, taking care to leave all the buds of the scion above it, press it firmly all round, and point it both upwards and downwards into a spindle-shaped form. You will find it necessary to use cinder dust or dry sand to enable you to accomplish this pastry-making neatly. Of course in using the grafting wax only a small quantity is applied with a brush, so as just to make the joint airtight, and there is no fear of smothering the lowest bud, which bud is finally to become your tree. The bud on the stock below the cut first made is merely for the purpose of keeping the sap at work on the side opposite to the scion, and if it pushes it must be stopped by pinching the end off, and later in the season the shoot must be cut clean off.

Where the stocks are worked close to the ground, to prevent evaporation, and at the same time to keep frosts from the roots, cover up the ground to the top of the stocks with ashes or cocoa fibre. If the weather is very dry water well once a week, and a little guano added to the water will stimulate the growth very much. You must remember that the success of the operation, supposing the joint to have been quickly and correctly made, depends upon vigorous root-action. Any check to the growth through cold or drought is dangerous; in working small numbers both can be securely guarded against, and very few failures ought to occur. This is the form of whip graft I recommend for small trees.

Crown grafting, as applied to stocks much larger than the scions, will be referred to in a future issue; but the scions or

grafts should be cut off the trees or procured at once, keeping them cool and fresh until they are wanted for attaching to the stocks.

THE GREENHOUSE AND ITS INMATES.

(Continued from page 576, last vol.)

BALSAMS.

BALSAMS require to be grown in very rich soil in pits or frames, which are heated either by pipes or, better, by a hotbed. Seed should be sown in April in pots thinly, and placed near the glass on a hotbed. When the plants are 3 inches high they must be placed singly into small pots, employing very rich soil. A single crock over the hole in the pots will do, as the soil will soon be filled with roots, when a further shift will be necessary. Soil composed of half manure and half loam, with some sand to make it porous, will suit them well. The plants should be regularly syringed to keep down red spider. Repotting, keeping up a high moist heat, and ventilating whenever the weather is fine, constitute all that are required to make handsome plants in a short time. Nearness to the glass and a little bottom heat will conduce much towards the formation of strong, stout, as opposed to weak, thin plants. Before removing them to the greenhouse they should be hardened a little.

THE CAMELLIA.

The Camellia is a universal favourite, and no amateur considers his greenhouse, however small it may be, furnished unless one or two good plants are among the occupants. The best compost for Camellias is light turfy loam with an admixture of charcoal and bones broken small, in order to keep it sweet and open, as well as to furnish food for the roots. For small plants an addition of a little leaf soil and a dash of sharp sand will prove beneficial. Small plants require to be watered more frequently than large ones, hence the necessity for sand to prevent the soil becoming soddened. Small plants root with less vigour than large ones, hence the reason for giving that root-encouraging material—leaf soil.

The plants should be repotted just as the young shoots push in spring. Careful draining is necessary, for stagnant water must be guarded against or success will certainly not follow. Twin-potting is also necessary for the same reason. After the plants are potted the house in which they are placed should be kept rather warmer and closer than usual, so that an early vigorous growth may be encouraged. Occasionally dewing the plants after bright days with the syringe will be beneficial. Enough water should be given at a time to thoroughly saturate the whole mass of earth, and then no more until necessary. It frequently happens that the soil becomes so dry that it is not possible to wet it unless by steeping the pots in the cistern or a tub. The weight of the pot will be a guide as to whether the soil is too dry, and if there is any suspicion that dryness exists steeping for two or three hours should be resorted to. The fact that the surface soil is wet is no safe guide to follow. Overdryness and overdampness alike cause the buds to fall prematurely, so both must be guarded against.

After the shoots have become somewhat firm, and the flower buds have commenced swelling, the plants will be benefited by placing them outside, choosing a position where the plants are not too much exposed to beating winds. The pots should be plunged nearly to the rim in order to protect the soil from being too rapidly dried. They must be removed indoors by the end of September again.

Mealy bug is apt to infest Camellias. The best cure is careful sponging with soap and water. Indeed, insects or no insects, the plants will be much benefited by an occasional cleansing with a sponge and warm soapy water.

The following is a selection of twenty-four varieties of proved excellence. White—Alba plena, fimbriata, Princess Charlotte, Mathotiana alba, centifolia alba, and Montironi vera. Red or crimson—Madame Lebois, Rose de la Reine, Benncyi, Manara, and Bealii. Rose—Sarah Frost, L'Avenir, Halleyi, Madame de Streckaloff, Marchioness of Exeter, and Valtavaredo. Striped or marbled—Bonomiana, Adelina Benvenuti, Tricolor, Souvenir d'Amile Dufresne, Giovanni Santorelli, and Lavinia Maggi.—J. H.

(To be continued.)

SMALL SPOTS ON PELARGONIUM FOLIAGE.—I recently visited the gardens of a gentleman who prides himself on his collection of Pelargoniums: Regal, Show, Fancy, and the different sub-sections of Zonals. So attached is he to this favourite flower that I understand Messrs. Cannell & Sons of Swanley hold a general order from him for every-

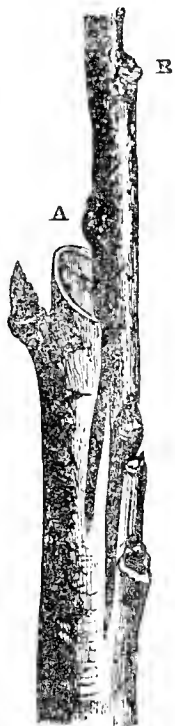

Fig. 35.

thing new that they introduce. Latterly, no matter how robust they arrive to him, after some time (I am now referring to the Zonals) the leaves exhibit whitish spots—I cannot say holes, for the fibrous part of the leaf-tissue remains, but the green is gone. I carefully examined them with a strong lens, but found no insect or larvæ. The plants had not received too much water, nor was the water hard. Perhaps some reader can throw a light on the matter.—W. J. M., *Clonmel*.



[By the most skilful Cultivators in the several Departments.]

HARDY FRUIT GARDEN.

Planting.—In so wet a winter the work of laying out and planting new gardens has been much retarded. Plum buds are already swelling; so, too, are Gooseberries. Not a day should be lost in planting them, and take especial care to enrich the soil with a liberal mixture of old decayed manure to induce a prompt and free root-growth. Also cover the entire surface of each station with a thick mulching of long stable dung or litter, the object of this extra care being root-growth as early, or nearly so, as autumn-planted trees; for if this has not begun when the sap stored in stem and branches is exhausted by the new branch-growth, it will sustain a severe check and do little good till midsummer.

Pruning.—Go a second time over any work done hurriedly or by young hands. We have been doing much good in this way lately in removing decaying wood and dead spurs, which are favourite haunts of insects. Crowded growth, too, has had special attention. Many branches left on with advantage when the trees were younger have been cut off to afford space for the full development of spurs that are annually affording an increasing yield of fruit. A few sturdy branches with large spurs are decidedly preferable to many branches with very short spurs. So, too, is the free growth of standards strengthened, rendered more healthy, and eventually more productive of really fine fruit by timely judicious thinning. Leave all Filberts and nuts unpruned till the male catkins are fully developed and a cloud of yellow pollen can be shaken from it to fertilise the pink female flowers.

Training.—This is almost done for the present, a few Figs on a south wall being the last intentionally, because the buds swell more slowly than most other kinds of fruit. All the main branches are trained diagonally from the base, so as to give the tree the shape of a fan, and the lateral growth is tied along and across them neatly and tolerably close, so as to retain enough unpruned shoots all over the tree to afford a full crop of fruit, which comes near the tops of last year's growth.

Protection.—If bullfinches attack the buds of Gooseberry bushes netting should at once be used to keep them off. It is a good plan to erect a permanent framework around the Gooseberry bed for this purpose, as well as for netting against birds and wasps in summer. If wasps are troublesome in summer Nottingham netting is required, but for keeping off birds fine wire netting is decidedly preferable; it is more efficient, and in the end is cheapest, lasting for a lifetime, while fish netting has often to be replaced with new. Large beds of Heather near our garden prove so attractive to the bullfinches that we need no protection, and never lose a Gooseberry bud. This is a hint worth turning to account, and to which there can be no objection, for the Heather is an ornamental plant which comes freely from seed.

FRUIT FORCING.

Vines.—Strict attention to stopping, tying, and thinning in the early house must be given, and the removal of surplus bunches be promptly done, it being well to under rather than overcrop. A night temperature of 60° to 65° will be suitable, and 70° to 75° by day, advancing 5° to 10° more from sun heat. Close at 80°, and employ plenty of moisture about the house, and in ventilating be careful to avoid admitting cold air, which is often productive of rust. Where Muscats are forced early, so as to have them ripe in June, the house being started in December, they will now be nearing the flowering stage, and should have a night temperature of 65° to 70°, and a rise of 10° to 15° by day in favourable weather, closing the house on fine days at 80°. When the flowers expand fertilise every bunch with pollen collected from Black Hamburgs, which insures a good set; but the setting is not all in the

successful treatment of early Muscats, as to insure a satisfactory result the roots must have the benefit of a well-drained inside border that was mulched in the previous season so as to encourage an abundance of healthy roots at the surface, a clean healthy growth, and the wood thoroughly ripened. This is absolutely essential, as much of the present season's result depends on the foundation laid in the previous year.

When the Grapes on Vines in pots have been thinned the laterals below the bunches should be closely stopped, while those above the fruit may be allowed freer growth, providing there is space for the foliage. Avoid overcropping, quality being of more importance than quantity. Top-dress with rich loam and decayed manure, having rims of zinc fitting inside the pots and about 4 inches deep. In case the pots are on pedestals of brickwork with a strong heat below from fermenting materials, the latter being placed loosely around the pots, liberal supplies of tepid liquid manure should be given; and where the pots are to remain undisturbed until the Grapes are ripe the roots may be allowed to have the run of the bed, and they will enable the Vines to swell off the fruit satisfactorily. In order to obtain a supply of Grapes from the end of July another house should now be closed, following instructions given in a former calendar. Late Vines which had the Grapes removed from them early in January should be closed not later than March, and preferably from the middle to the end of February, the inside border at the time of closing being supplied with water at a temperature of 90°. If fermenting material be introduced it will be advantageous from giving off moisture and ammonia-charged vapour, as well as lessening the necessity for fire heat, the temperature needing to be kept at 55° at night and 65° in the day. Late Hamburgs may be kept cool and allowed to break naturally, as with very little assistance their fruit can be ripened perfectly in September.

Cherry House.—Continue previous directions as to temperature; and in order to destroy any green or black aphides which have escaped at the time of the annual dressing, it will be well to fumigate the house on two or three consecutive evenings before the flowers are fully expanded. When the flowers are open and the pollen ripe apply it with a camel's-hair brush to the stigmas, it being most efficacious when it is light and dry, as will be the case on fine days after air has been admitted a short time.

Melons.—A quick, but at the same time a sturdy, growth is essential, and to effect this sufficient top and bottom heat must be at command, and by ventilating on all favourable occasions a sturdy and consolidated growth will be effected; but an unbroken current of cold air will do irreparable mischief, and must be broken by some small-mesh material, as that of scrim canvas, placed over the ventilators. Dung frames should be covered with a double thickness of mats at night, and the linings attended to as required. Sow seed for succession.

Cucumbers.—The night temperature may now be kept at 65° to 70°, and 80° to 90° with sun, admitting a little air on all favourable occasions, closing early in the afternoon of sunny days; with plenty of atmospheric moisture, and tepid liquid manure judiciously applied to the roots, they will make rapid progress. Maintain a clean growth, and crop lightly. Young plants may now be placed out in the ridges or hillocks in the Cucumber house, it having been properly and thoroughly cleansed, and the soil introduced a few days previously. Press the soil around the plants, a stick being placed to each and secured to the first wire of the trellis, shading for a few days if the sun be bright to prevent flagging. See that the linings of dung-heated frames are properly attended to according to the weather, and to meet demands of this kind keep a good supply of well-mixed leaves and dung in readiness.

Figs.—Nothing is gained by accelerating the forcing of Figs in the early stages, but sharp firing often encourages red spider, which should be closely watched for, syringing the trees twice a day to keep it under. Stop all gross shoots at the sixth leaf, and thin the shoots and useless spray, that the young spurs and fruit may have the benefit of air and light as the season advances. Thin the fruit as soon as the most promising and best placed can be decided upon for the crop. Continue the temperatures advised in our last calendar. Encourage trees in succession houses by applying fire heat and moisture through the day, keeping the borders well mulched and affording plentiful supplies of water to the roots, but avoid a high night temperature in the early stages of growth, more particularly in severe weather. Plants struck from eyes last season should now be encouraged with heat and moisture, as future success depends on their making an early well-ripened growth. Ground suckers should be removed; stop the strong shoots and train the leads to straight stakes, stopping those intended for pyramids at the sixth joint of growth. Eyes may now

be inserted, plunged in bottom heat, and treated like Vine eyes, and these grown on clean stems make the best plants.

FLOWER GARDEN AND PLEASURE GROUND.

Renovating Lawns.—All lawns will be much benefited by frequent rollings, this tending to fix the grasses which annually root afresh, and also materially contributes to the desirable firmness and evenness. It is not advisable to heavily sweep the lawn prior to rolling in order to remove the wormcasts. On the contrary, these if well scattered with a broom or long swish, and when dry rolled into turf, will to a certain extent act as fertilisers. As a rule the lawns are much neglected with regard to manuring, but unless a dressing of some kind is given occasionally the ground becomes impoverished, the finer sorts of grasses perish, and moss takes their place. A few barrowloads of good garden soil if it can be spared, or of road trimmings, should be run through a quarter-inch-mesh sieve, and after about one-third of its bulk of fresh-slaked lime is mixed with it, be thinly distributed over the lawn. It may be well stirred in with a rake, and the roller passed over frequently when dry. Large lawns ought to have similar treatment, and failing this a dressing of artificial manure or soot. Lime and road grit well stirred in will destroy moss and greatly improve the turf. Mild weather, such as we are having this month, is most favourable for turf-laying, and this and levelling may well be proceeded with. In either case, unless the ground when being prepared is rendered firm unevenness will result. When levelling the turf need only be rolled back in strips; the soil can then be removed or added as the case may be, and the turf firmly beaten down.

Climbing Roses.—Where these are growing in a well-sheltered position it may be advisable to prune them at once in order to secure an early supply of blooms. Tea Roses are largely planted in these positions, and with a little protection from severe frost succeed admirably. They should be freely thinned out, the spray especially being removed, and all the shoots retained shortened back according to their vigour. When these are weakly prune hard; if strong, the growths may be laid in to near their full length. If this is attended to and a liberal top-dressing of manure given the plants will always be vigorous and yield flowers in abundance. If a few of the strong growths of Gloire de Dijon are cut back to within three buds of their base long strong shoots will follow, and these if laid in will flower throughout their full length late in the season. Maréchal Niel requires different treatment, as it produces blooms on the growth of the previous season only, and consequently old growth should be cut out where possible, and the long strong shoots which flower at every joint be laid in to their full length. With the object of securing a sufficiency of this class of growths well matured, a few strong shoots should be cut hard back. Noisettes may be rather closely pruned, as these produce large-branching flowering shoots. Bourbon and Chinese Roses are the freest and most continuous bloomers, and should have all spray removed, the remaining growths being cut freely back and large-branching shoots will result. Hybrid Perpetuals, where the walls or pillars are well furnished, may be pruned similar to those grown as standards, all the young growths being thinned out, and those retained cut back to three or more buds. Where necessary the young growths of these and other kinds may be laid in to their full length. Banksian Roses should be treated similarly to Maréchal Niel.

Seeds to be Sown.—All kinds of small seeds germinate readily in February, and these and the seeds of slow-growing subtropical bedding plants may now be sown. Included in the former are Lobelias, Pentstemons, Antirrhinums, Tuberos-rooted Begonias, and Verbenas; while among the latter are Wigandias, Solanums, Cannas, Acacia lophantha, Tobacco, Ferdinandia eminens, Polymnia grandis, Echeverias, Sempervivums, Chamæpeuce diacantha, and Centaureas. It is much too early to sow the Ricinuses. Pans or well-drained pots may be employed, and a light, finely sifted, sandy soil in which leaf soil or peat is freely mixed is suitable. The very finest seeds should be sown on the surface of the firm, even, damp soil, while the remainder should only be lightly covered and watered through a fine-rose watering can. All should be covered with glass, placed on a brisk hotbed, and kept dark till germination. Prior to sowing it will be necessary to soak the seeds of the Cannas and Acacias for twenty-four hours in a pan of water placed on the hot-water pipes or plunged in a strong bottom heat.

PLANT HOUSES.

Stove.—Dracænas that have become tall should now be cut down and the tops inserted in 4-inch pots, placing a good dash of sand at the base for the stem to rest upon, and plunged into bottom heat in the propagating frame, where they will soon form roots. Good

heads when rooted without losing their foliage always form much better plants than those raised from the stem, as the foliage is large and the plants afterwards well furnished at the base. To increase the stock cut up the portion of stem from which the roots are emitted, as plants are formed from it quicker than from the stem aboveground. The latter if used should be well ripened before it is cut, or it is very liable to decay. *D. gracilis*, *D. rutilans*, and *D. congesta* are very useful green-leaved varieties for decoration. Heads of the first-mentioned root readily without being confined in the propagating frame, and the stock increased by retaining the old stem, rooting the young shoots that push from it when 4 or 5 inches in length.

Crotons and Dieffenbachias that have become bare at the bottom can have their tops removed and will root quickly, forming handsome plants in a few weeks. Retain the plants from which the tops have been taken if necessary to increase the stock; and although the young plants taken from the Crotons after the head has been removed will never be so well furnished at the base, but in time if carefully grown will form heads equal to those taken from the parent. These can be then cut off and rooted, and in due time a good stock of well-furnished plants will be provided. The stems of Dieffenbachias can be cut into lengths, and either potted singly or laid in a pan of sand until they form roots and commence growth.

Roses.—During the present dull weather these must not have too much heat, or their growths will be weakly and the flowers comparatively small. Keep the temperature at 50° to 55° at night, with a rise of 5° or 10° on very fine days. The sun will now daily gain strength, but care must be exercised in ventilating. It is better to allow the temperature to rise considerably by sun heat than to have cold draughts strike the tender foliage of the plants. Nothing causes mildew sooner than cold draughts, and when this once attacks the plants its development is rapid if its progress be not arrested. The best preventive is to syringe the plants with a little soft soap in the water. Prepare by boiling for twenty minutes about 4 lbs. of soap in a little water, to which add four gallons of water. Place half a pint of this in every four gallons of water used for syringing. This not only keeps Roses free from mildew and red spider, but checks the development of aphides, besides imparting a dark glossy appearance to the foliage. If the last-mentioned insects are infesting the points of the shoots fumigate with tobacco paper. Tea Roses that were introduced into heat early in December will now be coming into bloom, and will take the place of those that have been flowering since the early part of November. These if allowed to rest in a cooler house for two or three weeks, and then started again into growth, will produce a number of blooms later in the season, but before any can be gathered outside. Succession plants of both Teas and Hybrid Perpetuals should be kept in a steady temperature and as near to the glass as possible. Keep Moss varieties in a cold house, and allow them to start naturally. Those plants in cold frames that are to be grown cool and kept purposely to precede those outside should now be finally pruned. Ventilate as much as possible when favourable to prevent them starting into growth, and thus flower too early.

THE BEE-KEEPER.

THE ART OF BEE-KEEPING.—No. 7.

(Continued from page 60.)

HIVES.

HAVING given our reasons for preferring the bar-frame hive to all others, we proceed to indicate the principles that ought to guide us in its construction; and first of all we may consider it absolutely necessary that, however they may differ in size, material, or construction, all the hives in an apiary should be suited to take frames of a uniform size. That now generally known as the British Standard Frame will doubtless be generally adopted in these islands. It measures 14 by 8½ inches outside, the top bar being three-eighths of an inch thick, side bars quarter of an inch, and bottom bar one-eighth. We recommend a width of seven-eighths of an inch for top and side bars and half an inch for bottom bar. A length of 17 inches is recommended by the Association for the top bar, but we cannot think this will be generally adopted. Such a frame, allowing a quarter of an inch at each end for travelling space and three-eighths of an inch at the bottom, will hang in a hive 14½ inches wide, and on sides 8½ inches deep. The length of top bar recommended will thus have projections of 1½ inch at each end, of which

$1\frac{1}{4}$ inch will rest on the hive sides. Necessarily therefore, unless what are called wide shoulders are adopted, the hive sides must be at least $1\frac{1}{4}$ inch thick, and it is here that the proposed frame fails to give satisfaction. There may be no difficulty with double-walled hives, but when we come to those with single sides we find it impossible to adopt the 17-inch bar without using wood of excessive thickness. Double-walled hives are doubtless to be in most cases preferred, but they are too expensive and difficult of construction for cottagers' use, and quite unnecessary where hives are to be kept inside buildings as is frequently the case. In practice we find that a projection of three-quarters of an inch in the top bar is quite sufficient for convenience in handling, and as this allows a rest of half an inch it would easily fit all hives whether single or double-sided. This would give a length of top bar of $15\frac{1}{2}$ inches.

There is a growing tendency also among bee-keepers towards the two-storey hive, which can only be conveniently used when the body boxes are single-sided. As this is the simplest form of hive body we give the following as its dimensions, assuming that it is intended to hold ten frames—that is, it will measure inside $14\frac{1}{2}$ inches square. To admit of tiering the top must be level with the upper surface of the frames all round, and thus its four sides will be each $8\frac{7}{8}$ inches deep. It is well, however, to allow for a little shrinkage, and we shall say 9 inches planed. The ends on which the frames are to rest must thus be rabbeted half an inch on by three-eighths of an inch down. To admit of this rabbeting these should be at least three-quarters of an inch thick—we prefer 1 inch, but the other sides may be lighter if preferred. We always prefer rabbeting out of solid wood to using thinner wood with plinths nailed on, as these present so many more open joints to the weather. Body boxes so constructed will, if carefully made, fit exactly on each other; but to guard against the possibility of wet entering the lower edge may be surrounded with a plinth on all sides except the front, this plinth depending half an inch, so as to throw rain over the bottom board, or over the junction of two storeys when tiered up. The roof should have its sides large enough to slip over the top of the body, with stops screwed inside to allow of its being let down further when not required for covering supers.

A glance at figs. 14 and 15, page 60, will show the principles on which we prefer to construct our double-sided hives. The internal rabbet at the bottom and the external one at the top serve as receivers for the floorboard and the roof, rendering plinths unnecessary. In these hives we further provide sufficient height in the sides to allow of chaff-packing in winter, though this addition may, especially with single-sided hives, be in the form of a moveable rim. The roof may vary according to taste—either gabled, sloping both ways, or in "lean-to" form, sloping in one direction only. Generally speaking, however, our aim is to have hives constructed of the fewest possible number of pieces, and more especially where these present open joints to the weather. The following minor points also require attention:—Ventilation of the roof should be provided for by holes under the eaves, at least two of 1 inch diameter in each of two opposite sides. The doorway should be cut out to at least 10 inches by three-eighths of an inch, and be fitted either with slides or moveable blocks for reducing its size at pleasure. The floorboard should project at least 3 inches in front to form an alighting board, and is preferably made of two thicknesses well riveted together across the grain, so as to be proof against warping and to be reversible if desired; and all exposed parts should be kept well painted and thoroughly waterproof.

The tendency during the last few years has been in favour of hives large enough to contain from twelve to twenty frames or even more, with a view to having sections hung inside the hives. But experience, especially in poor honey seasons, leads us to conclude that this is a mistake. We very seldom have well-finished sections in such circumstances, and we have no doubt that the older plan of reserving the body of the hive for brood combs and taking surplus in the form of supers proper will yet be generally adopted. Under such circumstances we consider that hives to contain from ten to twelve standard frames are large enough for all purposes. The latter number seems a proper medium for double-walled hives, and we think the former exactly suited to single-walled hives, especially where tiering is intended.—WILLIAM RATT, *Blairgowrie*.

(To be continued.)

AUTUMN STIMULATIVE FEEDING.

I AM puzzled to know why "P. H. P." (page 80) should go to India and back to try to prove himself right; we are in England, and the English climate we have to deal with.

As driven bees, this matter has nothing to do with the question. I ask, Now suppose his queens really have ceased laying, can your correspondent induce them to recommence laying eggs? I

consider that driven bees stand on the same ground as swarms, the extra excitement in feeding, &c., causing the queens to commence laying. This is totally different from ordinary stocks to be kept over the winter. I have, I think, walked as many miles as most men after driven bees in an evening after a hard day's work for others and myself, and I say, By all means unite such bees to your others. This is far safer than stimulating feeding. Suppose you keep up the breeding after the honey harvest is over, your bees come out in larger numbers, so that more die from exhaustion, &c., than you gain. It is not so much the age as the amount of work done by the bees that causes them to die. Then look at the amount of robbing caused by feeding, the danger of chilled brood, danger of dysentery, young bees not able to take cleansing flights, &c. Transferring I strongly condemn, having in so many instances proved the great danger of foul brood afterwards. I examine some scores of hives in the year for myself and others, so I have some chance of observation.—STINGER.

TRADE CATALOGUES RECEIVED.

- J. O. Manson, Harford, U.S. America.—*Catalogue of Flower and Vegetable Seeds.*
 Dickson & Robinson, 12, Old Millgate, Manchester.—*Catalogue of Store and Greenhouse Plants.*
 R. Pennell & Son, Lincoln.—*Catalogue of Flower and Vegetable Seeds.*
 C. Pocock, Wincanton, Somerset.—*Catalogue of Flower and Vegetable Seeds.*
 Walter Ford, Pamber, Basingstoke.—*Catalogues of Vegetable and Flower Seeds.*
 Hogg & Wood, Coldstream-on-Tweed.—*Catalogue of Flower and Vegetable Seeds.*
 Richard Dean, Bedford and Ealing.—*Catalogues of Vegetable and Flower Seeds, Florists' Flowers, and Potatoes.*
 William Paul & Son, Paisley.—*List of New Pansies and Pinks.*
 Vilmorin, Andrieux et Cie., 4, Quai de la Megisserie, Paris.—*Catalogue of Vegetable and Flower Seeds.*
 Carl Cropp, Erfurt.—*Catalogue of Flower and Vegetable Seeds.*
 E. G. Oakshott & Co., Reading, Berks.—*Catalogue of Seed Corn, Beans, and Peas.*



** All correspondence should be directed either to "The Editor" or to "The Publisher." Letters addressed to Dr. Hogg or members of the staff often remain unopened unavoidably. We request that no one will write privately to any of our correspondents, as doing so subjects them to unjustifiable trouble and expense.

Correspondents should not mix up on the same sheet questions relating to Gardening and those on Poultry and Bee subjects, and should never send more than two or three questions at once. All articles intended for insertion should be written on one side of the paper only. We cannot reply to questions through the post, and we do not undertake to return rejected communications.

Cutting Down Vines (*J. T. S.*).—Do not cut them down. We will reply more fully next week. Letters that arrive on Wednesday cannot be answered satisfactorily in the next day's issue.

Fragrant Camellia (*J. S. G.*).—The flowers you sent are very slightly fragrant, and we have observed a similar scent in this and other varieties, but it is never very strongly marked, and is quickly lost after the flowers are removed from the plant. The variety is apparently the old variegata.

Pruning Raspberries (*Novice*).—Your canes are evidently very strong. If you cut "clean off" all the side growths to which you refer, you will probably remove some of the best bearing wood. Thin them out, retaining those that are strong and furnished with prominent buds. Many of the shoots will be so small as to be of little use, and these you may cut off as you suggest. Do not overcrowd the canes; five or six to each stake will be ample. If trained to a fence they should be about 6 inches apart, and if very long they may be trained obliquely, so as to have a greater length for bearing.

Chrysanthemums for Pots (*A. C.*).—We presume you do not require the plants for exhibition, and have therefore named those which are distinguished by their free-flowering qualities. Incurved—Mrs. G. Rundle, Mr. G. Glenny, Mrs. Dixon, Prince Alfred. Japanese—Early Red Dragon, Elaine, Bouquet Fait, James Salter. Reflexed—Julia Lagravère, Chevalier Damage. Anemone—Fleur de Marie and Mr. Astie. Six good useful Pompons are the following—White and Golden Cedo Nulli, Mdle. Marthe, Rosinante, Fanny, and Sœur Melanie, which is rather larger than ordinary Pompons, but very free.

Chrysanthemums (*Salburn*).—Rooted suckers potted now and kept in cool frames, or cuttings struck in early spring and liberal culture given to the plants, will afford you a better supply of flowers than you can obtain by keeping the old plants as you propose. These if planted out in a sheltered position

where protection could be afforded in late autumn would give you a supply of flowers for cutting that might be useful; but first have a stock of young plants established for yielding an abundance of good blooms.

Stephanotis not Flowering (Reader).—Your plant may still flower as the season advances; if it does not you have applied to us too late for information that will enable you to induce it to flower this year. Its failure to produce flowers will be the result of too much heat and moisture during the winter. If it continues growing luxuriantly you had better make the soil firm, or otherwise restrict root-action towards the end of August, and lessen the supply of water, maintaining also a drier atmosphere. From October onwards through the winter the soil may be kept comparatively dry, only giving water when the foliage commences to feel flaccid and limp when pressed between your finger and thumb, a temperature of 60° falling to 55° in the winter being ample. If a plant has had its growth ripened in the autumn followed by a rest in winter does not produce flowers in the spring it will in all probability be a shy-blooming variety with large leaves, and not worth the space it occupies.

Liquid Manure for Mushroom Beds (I. W. Mansfield).—The drainings from stables consisting largely of urine can only be applied with advantage to Mushroom beds when they are so dry as to need watering, and this ought never to be the case with new beds, as if the material of which they are made is not moist fermentation will not occur to produce the necessary heat. Beds that are more or less exhausted by heavy crops, and also dry, are often benefited by liquid manure applied at a temperature of 80° or 90°. Pure urine must be diluted with six times its volume of water, and is then valuable to all Mushroom beds that need additional moisture, not otherwise. If a drop of water can be squeezed from the manure by the hand it is too moist for Mushrooms; and if a handful will not "cake" or adhere when firmly grasped it is too dry. You can by this rule determine whether to use the drainage or not in the manner you suggest.

Heating Apparatus Unsatisfactory (Hortus).—From your description of the disposition of the pipes, and the sketch showing the return pipes, we are unable to notice any defect in the arrangement. It is likely, however, that there may be air lodging somewhere in the system, yet this ought not to be the case if there be air pipes, as there ought, at the highest part of the pipes where the return is made to the boiler. The highest point of the system being in each case at the doorway, there should be an air pipe in each flow pipe at that point. Whether the unsatisfactory state of the apparatus is due to defective circulation, or arises from the bad setting of the boiler, is a question for decision on the spot only; otherwise we see nothing, except the want of air pipes, that should prevent the apparatus heating well.

Syringing Peach Trees (F. C.).—We do not remember the strength of the petroleum mixture that you said you had used; but we thought it so strange that you should apply it to the blossoms, that we carefully searched your letter for some qualifying sentence. The mistake on the subject was, as you say, "wholly your own." As the dressing has not injured the trees it will certainly act as a preventive of insects as well, probably, as anything else would; but we do not consider frequent applications of petroleum desirable. We have used tobacco water, diluting the strong juice with six times its volume of water, and nicotine soap is equally effectual. If you syringe your trees with this at the strength of 3 ozs. to a gallon of water just before the flowers expand, you will not be troubled with many insects on the blossoms, and if any appear dust them with tobacco powder or snuff.

Apple Scions (Idem).—We do not know from whence you can obtain scions of the varieties you require. There is no Apple named Mrs. Ward, but there is a Baron Ward. The Mr. Morris to whom you have written died about half a century ago. The site of the old Brompton Nursery is covered with fine buildings, including the South Kensington Museum. We doubt if the Columbia Plum can be had in this country. You say you have applied to many nurserymen, but do not mention Messrs. Richard Smith & Co. of Worcester. Our reply to your last query is—Yes, there has been a slight alteration.

Cinerarias Defective (F. G.).—You ask if frost would cause the florets to curl, as in the flowers you have sent. It would do so, and it is impossible to have satisfactory flowers if they are allowed to be even to the slightest extent frosted. Insects produce somewhat similar results when they are allowed to cluster on the stems just under the flower buds, as they puncture them and extract the sap that is requisite for the support of the blooms. If you had not mentioned frost we should have concluded that insects had caused the evil, and we are still inclined to think that they have had a share in the work. We suspect also they were lurking under the buds for some time before the time you state that they "made their appearance." You afford us no guidance whatever for determining the cause of the Pelargonium leaves withering. Extreme dryness at the roots, excessive fumigation, escape of noxious gas from a fire, or keeping the plants in a very moist atmosphere, then exposing them suddenly to a drying current of air, would cause the margins of the leaves to wither like the one you have sent. If you had briefly stated the conditions under which the plants were grown and the treatment they had received we should in all probability have been able to give a more explicit reply.

Cutting down Rhododendrons (W. G.).—The effect of cutting down the shrubs in the manner you suggest would necessarily render them unsightly for a long time, and some of them might not produce fresh growths freely. This depends entirely on the condition of the shrubs as to vigour and the age and character of the wood. We have seen healthy shrubs break freely, and some of them afterwards grow even too luxuriantly, while others we have seen do little or no good after the operation. You had perhaps better try the experiment of cutting a few of them down and note the results. We cannot incur the responsibility of advising you to clear an embankment in the manner you suggest without knowing something of the actual condition of the shrubs, and on this point you do not say one word. Healthy shrubs cut down now may be expected to mature their growths and produce at least some flowers next year; but if not cut down until after they have flowered in June they will not flower with any freedom for at the least two years.

Inarched Vine (J. B.).—If your rod of Mrs. Pince is satisfactory by all means retain it. It will do quite as well on the stock, provided it is healthy, as on its own roots. Had we known the length and strength of the young cane we could possibly have given you more useful advice. We can only counsel you not to overcrop it, but shorten, if needed, so as to induce stronger growth next year. If there is space for the foliage to develop under full exposure to the sun it will not be necessary to cut down the stock now, and so deprive yourself of a crop of Grapes; but if there is not space you may cut off the spurs from the lower part of the stock for admitting light for the future Vine, while, at the same time, the upper portion of the stock will afford Grapes next summer. Autumn, just after the leaves have fallen, is the best time for cutting down Vines. If cut down at this season of the year excessive bleeding not infrequently results, which it is not easy to check.

Daphne indica rubra (Q. L. K.).—This plant is almost hardy, and consequently will not long thrive in a stove temperature of 60° to 65°. To grow Daphnes well they should have cool-frame treatment, the pots being stood on ashes or some other moisture-holding material. In spring, when these plants are starting into growth, the frame can be closed early in the afternoon, so as to husband as much sun heat as possible to assist them in making their growth, at the same time syringing the plants occasionally. After growth is completed the lights should be gradually removed until they can be left off day and night, or the plants stood outside to form their flower buds. They are best in the frame, so that the lights can be placed over them during wet weather. During frosty weather the lights must be kept on, giving abundance of air when favourable. If the weather proves very severe the frame must be well covered with mats or other protecting material to exclude frost if possible. It is a good plan during sharp weather to plunge the pots entirely in cocoa-nut fibre to keep frost from the roots. We have seen the soil in the pots frozen quite hard without the slightest injury resulting to the plants, but it is better to avoid such risks. During the spring Daphnes can be forced into bloom by the aid of gentle warmth in a greenhouse, but in no stage should they have such a high temperature as you are keeping your plants in. After flowering they must again be gradually inured to cool treatment again, or they will not long retain their vigour. Let your plants be removed to the coolest part of the stove for a few days, then to the warmest part of the greenhouse, and subsequently to a still cooler position, so as to avoid a sudden check. After flowering place them in a frame, and if the roots are active healthy growths will follow for producing flowers next year. These plants must be watered carefully in all stages, especially during the winter season.

Gardenia Buds not Swelling (Idem).—It is impossible to give an explicit reply in a case where no data is afforded to guide us, and can only say that the flower buds of Gardenias do not swell very rapidly at first, and to all appearance remain stationary. If your plants have been checked, or are in an unsatisfactory state at the roots, they may not swell at all, but eventually turn yellow and fall off. If their roots are healthy, the buds fresh and green, and the plants have sufficient heat, you may expect the flowers to expand more rapidly from this date, and in due course properly develop.

Raising Vines in Turves (H. S.).—We have raised Vines in turves and have produced most satisfactory canes without the use of liquid manure; but the turf was taken from rich pasture land, and further, as the Vines increased in size the turves were placed on a layer of rich soil and decayed manure, the spaces between them being filled with the same material. As soon as the roots took possession of this, and before it was interlaced with them, the Vines were planted, and the canes produced were most satisfactory, being strong, short-jointed, and with little pith. If the turf is poor, weak liquid manure applied once a week would doubtless be beneficial, but it would not be needed until the Vines had made considerable growth and the turves were thoroughly permeated with roots. Until Vines have made much growth, say until the middle of August, they need the treatment of stove plants—that is, a genial atmosphere, water in sufficient quantity to maintain free growth, with light and air to keep



Fig. 36.

them sturdy, but no cold currents to cause the foliage to flag. In the autumn a drier atmosphere, abundance of air, and all the light possible are requisite for ripening the wood, but they must not suffer by want of water at the roots. As you are inexperienced you must not expect to succeed like a Thomson on the first attempt; and, besides, if you have no better eyes to start with than those you sent us last week it will not be possible for you to produce superior canes. The roots of your Vines have probably penetrated into ungenial subsoil, and do not obtain the support they need, and the wood is certainly immature consequent on that, and probably insufficient heat and ventilation in the autumn. It is not unlikely, too, that the Vines were overcropped and the growths overcrowded. If the border is permeated with roots near the surface, and the growths are sufficiently exposed to light and air, the canes will be shorter-jointed and contain less pith. The wood marked No. 1 is a good size for propagating, but we attach more importance to the character of the wood and the buds than to mere size. The annexed figure represents a Vine eye prepared for insertion.

Pigny Vines (Idem).—The Vines to which you refer as bearing from one to four bunches of Grapes in 4 to 6-inch pots, were, as is stated by Mr. Henderson, the cultivator of them (see page 236, September 26th, 1867), "raised from cuttings from Vines that had been started in February. The cuttings were taken off the old Vines after the fruit was set, and potted in 5, 6, and 7-inch pots." For striking as suggested a brisk moist heat and a close atmosphere for a time would be essential, and then success could only be achieved by a skilful propagator and cultivator. We have not tried the plan.

Names of Fruit (H. H.).—No. 1 is apparently a fine specimen of Margil, but has been kept too long for us to determine with accuracy. No. 2 is Winter Greening. (Colville Browne).—1, Vicar of Wiukfield; 2, Knight's Monarch; 3, Ne Plus Meuris; 4, Bergamotte Esperen; 5, Cornish Gillyflower; 6, not known, evidently worthless in your soil; regraft the tree with No. 4. (A. Mc.).—1, This is the spurious variety of Knight's Monarch, which Mr. Knight himself distributed by mistake. 2, Angélique de Bordeaux, only fit for stewing.

Names of Plants (H. S.).—Your plant is *Marattia elegans*, a species of Fern from Norfolk Island and New Zealand; most of the forms of this genus inhabit swampy districts, and consequently require abundant supplies of water in cultivation. It will succeed in the ordinary warm fernery or stove.

Moving Stocks (Lax).—There is little or no risk in moving bees at this period of the year, and if you sustain any loss at all it will only be very slight.

COVENT GARDEN MARKET.—FEBRUARY 7TH.

MARKET very quiet. A fair supply of early forced vegetables reaching us, but good samples of late Grapes are short at previous quotations.

FRUIT.

Apples.....	1 sieve	2 0 to 7 0	Grapes	lb.	2 0 to 5 0
"	per barrel	20 0 40 0	Lemons	case	10 0 20 0
Apricots.....	doz.	0 0 0 0	Melons	each	0 0 0 0
Cherries.....	1/2 sieve	0 0 0 0	Nectarines....	dozen	0 0 0 0
Chestnuts.....	bushel	10 0 12 0	Oranges	100	6 0 10 0
"	1/2 sieve	0 0 0 0	Peaches	dozen	0 0 0 0
"	1/2 sieve	0 0 0 0	Pears, kitchen ..	dozen	1 0 2 0
Figs.....	dozen	0 6 1 0	"	dozen	1 0 2 0
Filberts.....	lb.	0 0 0 0	Pine Apples, English	lb.	1 6 2 0
"	100 lb.	0 0 0 0	Raspberries	lb.	0 0 0 0
Gooseberries	1/2 sieve	0 0 0 0	Strawberries	lb.	0 0 0 0

VEGETABLES.

Artichokes.....	dozen	2 0 to 4 0	Lettuces	score	1 0 to 1 6
Asparagus, French	bundle	25 0 30 0	Mushrooms	punnet	1 0 1 6
Beans, Kidney	100	1 0 0 0	Mustard & Cress ..	punnet	0 2 0 3
Beet, Red.....	dozen	1 0 2 0	Onions	bushel	2 3 2 6
Broccoli.....	bundle	0 9 1 6	Parsley.....	doz. bunches	3 0 4 0
Brussels Sprouts..	1/2 sieve	1 6 2 0	Parsnips	dozen	1 0 2 0
Cabbage	dozen	0 6 1 0	Peas	quart	0 0 0 0
Capsicums.....	100	1 6 2 0	Potatoes	cwt.	6 0 7 9
Carrots	bunch	0 4 0 0	"	cwt.	6 0 8 0
Cauliflowers	dozen	2 0 3 0	Radishes.....	doz. bunches	1 0 0 0
Celery	bundle	1 6 2 0	Rhubarb	bundle	0 4 0 0
Coleworts.....	doz. bunches	2 0 4 0	Salsafy.....	bundle	1 0 0 0
Cucumbers.....	each	1 6 2 0	Scorzoneria	bundle	1 6 0 8
Endive.....	dozen	1 0 2 0	Seakale	basket	1 0 2 0
Fennel.....	bunch	0 3 0 0	Shallots	lb.	0 3 0 0
Garlic.....	lb.	0 6 0 0	Spinach	bushel	3 0 0 0
Herbs	bunch	0 2 0 0	Tomatoes	lb.	1 6 2 0
Leeks.....	bunch	0 3 0 4	Turnips	bunch	0 2 0 3



POULTRY AND PIGEON CHRONICLE.

GOAT FARMING.

(Continued from page 105.)

THE milk produce of Goats now requires our attention, as there is every prospect of the milk maintaining a paying value, for it is at certain times of the year worth 5s. or 6s. per quart in London; indeed, at ordinary times the price is never lower than 2s. 6d. up to 4s. per quart, and before proceeding farther we will give its chemical composition in comparison with that of the cow and the ass, which will be seen by the following table:—

	Goat.	Cow.	Ass.
Casein	4.02	4.48	1.82
Butter	3.32	3.13	0.11
Sugar	5.28	4.47	6.08
Salts	0.53	0.60	0.34
Total solid matter..	13.20	12.98	12.02
Water	86.80	87.02	91.65
	100.00	100.00	100.00

The above table shows Goats' milk to contain more solid matter than the others, hence its nutritious qualities. Its chief value, however, consists in its use for invalids, especially consumptive persons and infants. The means of keeping up a supply available at all times is so far a question of breeding as well as of management. We therefore proceed to make our remarks as to breeding. The usual time for the pairing of Goats in this climate is from September to November, and the period of gestation being five months, the kids will appear about March or April. Young Grasses will have then sprung up, especially if we choose a dry soil seeded with Italian Eye Grass and Cooksfoot, both of these being very early, but the latter is a permanent Grass and highly productive. We consider it is an important point that the milking period should be made to extend until within a week or fortnight of the time of parturition again, although the popular opinion is that the female should go dry of milk for two months, for reasons assigned; but where the milk is so valuable the longer it can be maintained the better. With high feeding, housing in winter, and careful management this can be done, and would be likely to avoid all difficulties which sometimes prove fatal at the time of parturition,

because high feeding up to the time is often attended with inflammation, in the same way as cows are affected at calving time.

The earliest age at which breeding may commence with the most advantage is two years, although, if allowed, the Goat will commence breeding at eight or ten months. About the age of seven years they will bring their best kids, although they will, if required, often breed until the age of twelve years. Feeding during the milking period should be liberal, with good hay either of Clover or Sainfoin, and roots, such as Cabbage, Carrots, or Potatoes, with Oats or bran, but what is better, crushed Wheat now it is so cheap, with water and rock salt at all times within reach; but as soon as the animals go dry feeding should be more moderate as the time of parturition draws near. In the case of the male animals intended for sale as mutton they should be castrated at about four or five months old, after which they may be fed on hay and roots as just stated, except that Barley or Beans may be used instead of Oats.

The instances of Goat-farming upon a large scale are not much reported or known in this country, but we have been informed that in California one or more companies exist which have made the growth and sale of mohair their special objects, and very successfully, in consequence of the climate, &c., being so much like that of Asia Minor, Persia, and part of India. In this country, we are informed by a recent notice in the *Agricultural Gazette* by Mr. H. S. Holmes Pegler, Secretary of the British Goat Society, that the experiment of Goat-farming is being carried on in Surrey, and we suppose it refers to a Company which we have heard is being conducted on the estate of the Earl of Lovelace at East Horsely, between Guildford and Leatherhead. It is called the Express Company, and that the milk is forwarded to London in sealed bottles for a price varying from 1s. 6d. and upwards per quart, at which price it is said to be profitable. This Company's practice is no doubt the best model we have at present for reference as to proceedings, still we have but a simple notice, to which we have alluded.

Our reference to the subject must now apply principally to the management of Goats in the hands of the amateur or farmers connected with suburban districts, where only a few animals or one only may be kept for the double object of the amusement and pleasure of the owner, or the finding of milk and cream for a family, and where it is inconvenient or impossible to find room for even the smallest Kerry or Jersey cow. Under the circumstances we have named the Goats kept especially for their milk must be of a strain that are celebrated as milkers, but care must be taken in their daily management, or they may become very troublesome; and to prevent them doing injury to trees ornamental or otherwise they should be tethered at daytime wherever it is attempted to graze them either upon lawns, tennis grounds, or orchards; at night, however, for various reasons they should be housed in the summer and entirely so in winter. We must, therefore, allude to the accommodation for them in house, but it need not be an expensive matter, for an unused stable may be made useful by making an earth floor 15 inches deep, rammed down hard, to every box, which may be partitioned, for we do not approve their being tethered in house, but should have the liberty of a space each of about 8 feet by 4 feet, and littered with straw or peat moss. The earth floor put in dry and being on a level will completely absorb all moisture, and the air will be quite pure. In making a small Goat house it may well be a lean-to on the north-west side of a wall, and made of iron, which will be secure against all weather, and be well ventilated by louvre openings, and divided into as many apartments as are required. The mangers or feeding troughs may also be of iron, in which case, unlike wooden troughs, they can be kept quite clean without any trouble. The partitions may be of iron grating, except a box for the male Goat, which may be enclosed by galvanised corrugated iron, of the same material as we should recommend for the roof and frontage of the house. No racks will be required, because they are frequently dangerous for horned animals and wasteful of the food, which may be given in the troughs either as hay chaff, cut roots, vegetable or other leaves, meal or bran, without any waste at all; a lump of rock salt also should be placed within reach. The north-west aspect for the Goat house is chosen because it can be made warm enough in winter and cool in summer.

Although milk and cream is most important for household use in a family, and which may be secured with a supply all the year round by having the kids to fall at different periods, even if the milch animals went dry for a period; but in the event of only one or two animals being kept it is important to have stock which will hold their milking produce for twelve months or longer, and by not breeding from them so frequently this may be done with the best milking stock and managed accordingly. It is often necessary to have some mode whereby fidgety or young animals

can be made to stand quietly during the time of milking, but trough-feeding simultaneously with milking will go a long way towards quieting them. It is, however, frequently the case that the milking cannot be done without great loss of time in the operation, or the loss of the milk through the action of restless animals, in which case they are obliged to be confined in a guillotine or stocks, in which they are fixed by the neck and can neither move forwards or backwards; but this need be only a last resort, and if it fails to answer it is best to dispose of the Goat. In the act of milking, just the same as with cows, gentleness and kind words will generally have its effect and enable the milking to be effected with promptitude; but heavy milkers will require something more than the usual twice-a-day milking, for those whose bags are very supple and rapidly fill should have them emptied three times daily, when a greater return will be made, for with the Goat the more you take the more she will continue to yield, and for a longer period. For the first three or four months after parturition the yield continues at its height, but at the end of nine months it is customary to allow the supply to cease, but to this course we have before stated our objections. In Goat management there is much more to be learned of detail than we can find space for in these columns; but in order that all which is required for success in Goat-keeping may be learned we will advise not only the amateur but all who feel an interest in the subject to obtain a work, thoroughly practical, called "The Book of the Goat," by H. Stephen Holmes Pegler, which in a frontispiece gives an excellent illustration of an English milch Goat, which may well prove valuable to an intending purchaser.

WORK ON THE HOME FARM.

Horse Labour.—Wheat-sowing is now generally finished, but some farmers still consider Wheat as the rent-paying crop, and we cannot deny it. A farmer recently told us that his ground which had been ploughed ready for sowing during the last two months, and that the land would not work with the harrows at any time since, and he feared it would not work until it became too late. He could have sown it long ago if he had ploughed it again and sowed as fast as it was ploughed daily and hour by hour, but the idea did not occur to him. Our readers will remember that this is the plan we have advised during the whole of the past winter. Ploughing can still be done where it is to be fallowed for roots. In the case of Beans and Peas, however, the land should not be ploughed before, for these crops will always succeed best by ploughing and seeding simultaneously, as this not only insures the work being completed as fast as undertaken, but also favours the growth of any pulse crop much more than when ploughed beforehand. This is not the case with the preparation for Oats or drege, because if the land for this crop is ploughed and pressed early it will settle down close with the heavy rains which usually occur in February, and the working of the land will be easily done on the first dry time afterwards, and after the Oats come up the land will be too close for the wireworm to injure them. Thus the ploughing may be done for these crops the sooner the better. Care should now be taken not to disturb the land intended for Barley until the weather becomes dry, when it may be done by ploughing and sowing simultaneously even after roots have been fed on the land by sheep, but the land should not be disturbed until it is ploughed and sown. Some farmers, however, think that as fast as the roots are eaten the land should be scarified, fearing that heavy rains will wash away the manure, but we have not found this to be the case even on our hilly land, for the urine is the chief manure, and is absorbed as quickly as it is dropped, the ammonia fixed and deodorised. The dung of sheep is often so much trodden into the soil that it does not run away more than the urine.

Hand Labour.—This has consisted of hedge-trimming and cutting, also forking out grass where only a few bunches are found, but in case a considerable quantity is left in the land it must remain until the land becomes dry enough to work the scarifier before ploughing. Examination of all drain work should now take place. We have just completed this work on a farm which was vacated at Michaelmas last; in some parts the drains have been repaired, and in all cases the outlets have been examined and made free from any obstruction.

Live Stock.—The lambing season is now on with all varieties of Down sheep and their crosses. The long-wools will soon follow, and their keeping should be moderate, for root food, like Turnips and Swedes, should be given sparingly if at all. Cabbages are best for pregnant ewes; but in the pasture districts good sweet hay without roots will be sufficient if the animals have access to rock salt and the opportunity of obtaining water, but what is better, a run at daytime on the chalk downs or limestone pastures. We knew a good farmer who would never give his ewes hay before lambing, but instead, did not feed his dry pastures after the 14th of July, and then in the early winter months the sheep were allowed a folding every day of this reserved late summer and autumn growth of grass, and he did this for fifty years with uniform success in the lambing fold and the general good health of his flock, but it is in strong land pasture districts without arable land where the difficulties arise. Would it not be wise to feed fattening bullocks or dairy cows only on such strong land pastures, and

thus escape the fluke rot, and at the same time not injure or destroy the finer gasses by sheep feeding? The store animals are not now allowed, nor the dairy cows either, to go on the pastures, as some of the finest pastures tread very much and are injured by winter feeding, therefore only dry paddocks near the farm buildings should be used as airing ground for any cattle in the wet winter months; but all the young stock which are now being forwarded for the butcher should be kept in the hovels or boxes and fed carefully upon the principle of early maturity—that is to say, to give them the cotton cake as yearlings, with Swedes cut and mixed with it, and good sweet Oat straw, that arising from the white Oats being the best, up to the time of twelve months. After that time they should be kept in separate boxes and never see the sun nor feel the rain again until they pass to the butcher after being fed up to twenty or twenty-four months of age, with 4 lbs. linseed oil cake, 2 lbs. of bean or barley meal mixed with cut roots, 64 lbs. of Swedes, or 56 lbs. of Mangolds, with sweet straw *ad libitum* per day. This is the only way by which we could ever make a profit on fattening bullocks, but in case we gave hay instead of straw it injured the health of the animals, and absorbed 3s. per week of the otherwise profit on feeding.

POTATOES AS A FIELD CROP.

UNDER this heading Messrs. Sutton & Sons of Reading have published a manual of eight pages, which is much more than a catalogue, inasmuch as the prices of the varieties enumerated are not quoted; it is rather a record of the practice of independent cultivators, which is submitted to show that Potatoes may be grown with a fair amount of profit in this country. The following extract will show the nature of the work:—

"Report from a Bedfordshire grower, who annually sends an immense quantity of Potatoes to the London market. He is one of the most competent men we know to express an opinion on this subject.

"December 14th, 1882.

"Ten acres of Wheat stubble owing to unfavourable seasons contained a quantity of twitch in the autumn of 1881. This I determined to plant with Magnum Bonum and Reading Hero Potatoes depending upon this crop to clean the land also, hence the otherwise unnecessary amount spent on the cultivation. The following is the estimated cost per acre:—

	£	s.	d.
Rent and taxes
Once ploughing in September, 1881	0	10	0
Harrowing the tilth, March, 1882	0	1	0
Twenty-five tons shortened manure, at 10s. per ton	12	10	0
Spreading manure	0	2	0
Ploughing in seed Potatoes, April, 1882, per acre	0	10	0
Seed, 11 cwt., at 5s. per cwt.	2	15	0
Women laying in Potato seed, per acre	0	2	6
Scuffling land with six-horse scuffle across furrows after planting	0	5	0
Once drag-harrowing with 4 horses	0	3	0
Twice harrowing at intervals (2-horse harrows)	0	2	0
Horse-hoeing three times with grubbers fixed	0	4	6
Hand-hoeing twice, at 4s. per acre	0	8	0
Earthing up with moulding plough	0	2	6
Digging and sorting	1	5	0
Drawing to railway (at 2s. 6d. per ton) 7 tons	0	17	6
Sowed broadcast before horse-hoeing, 80 bushels soot, per acre at 8d.	2	13	4
Man sowing the same	0	1	6
	£25	12	10
CROP—			
5½ tons best Potatoes at present price (Dec. 14th) £7 per ton	38	10	0
1 ton seed Potatoes	7	0	0
	£45	10	0
Salesman's commission, 6½ tons at 7s. 6d.	£2	8	9
Railway freight, 6½ tons at 7s. 6d.	2	8	9
	£40	12	6
Cost of cultivation	25	12	10
Net profit	£14	19	8

"REMARKS.—Everybody would not be at this liberal outlay for manure and soot, but this is my way of doing it. Some farmers would probably manage at a much less cost. The scuffling and drag-harrowing would be dispensed with if the land was clean.

"The Potatoes were ploughed in by three two-horse teams, the third and covering plough horses walked single out of the furrow to avoid treading on the Potatoes. The Potatoes were laid in the side of the furrow by six women (the labourers' wives); each woman planted a sixth part of the length of the furrow, crossing the land and planting both sides as the ploughs came round. I plant by this means about three acres per diem. The land after the Potato crop was almost clean, and was made quite so at an expense of 3s. per acre forking. It is now ploughed up ready for sowing with Barley, to be followed with Clover, and then Wheat again.—J. M. J."

POULTRY AND PIGEONS

CUCKOO FOWLS.

THERE are undoubtedly certain characteristic qualities which belong to particular types of fowls; thus, as a rule, white-legged birds are meaty and juicy on the table, plump, and full-breasted; red fowls have high courage; blue-legged ones are excellent layers. It seems to us that the peculiarity, and a very valuable one too, of Cuckoo fowls is their hardihood. Whether this is traceable to the fact that the present races of them are all descended from one or two very old and hardy breeds, or whether it is because all Cuckoo families have at some time or other been produced by crossing, we are unwilling to decide dogmatically. Probably both causes may have something to do with it, and a race or races originally hardy have been made still more vigorous by judicious crosses. We have always found it a fact that Cuckoo breeds when kept, as is supposed, pure and to themselves throw many chickens which are not Cuckoo; and, on the other hand, that if a Cuckoo bird be crossed with a black or a white many of the progeny will still come Cuckoo. For these reasons—viz., the facility with which crosses can be made in these breeds without easy detection, and that they do not breed true to colour, they are suited rather to the farmer or breeder of useful poultry than to the mere fancier.

Cuckoo fowls were by no means unknown forty years ago. Writing in 1850 the Rev. E. S. Dixon speaks of them as an old strain. "We here give," he says, "by the name by which it is usually designated in the Norfolk farmyards, a variety which there is good reason to believe to be something old and distinct, though they are generally looked upon as mere barndoor fowls—i.e., the mere accidental result of promiscuous crossing. But there are several forms among the barndoor fowls, so called, that are to be seen repeated generation after generation, the counterparts of which are to be met with scattered here and there over the country. The Cuckoo fowl, it may be supposed, was so called from its barred plumage, resembling the breast of the Cuckoo. The prevailing colour is a slaty blue undulated and softly shaded with white all over the body, forming bands of various width. The comb is very small, irides bright orange, feet and legs light flesh colour. The hens are of a good size. The cocks are large, approaching the heaviest breeds in weight. The chickens at two or three months old exhibit the barred plumage even more perfectly than the full-grown birds. The eggs average about 2 ozs. each, are white and of porcelain smoothness. The newly hatched chickens are grey, much resembling those of Silver Polands except in the colour of the feet and legs. This breed supplies an unfailing troop of good layers, good sitters, good mothers, and good feeders, and is well worth promotion in the poultry yard."

Such were the observations more than thirty years ago of an intelligent poultry fancier. In all probability there then were in the British Isles at least two distinct varieties of Cuckoo fowls—viz., the five-toed Dorking in Surrey, and the ancient Scotch Grey in the Highlands of Scotland. Of the former variety Mr. Dixon seems to have had some knowledge, for he proceeds to say, "In any closer grouping of the breeds of poultry the Cuckoo fowl might perhaps be safely referred to the Surrey fowl, and so to the Dorkings. Some of the grey-barred Dorkings are scarcely to be distinguished from them, except by the fifth toe. Still there is something very remarkable and permanent in the peculiar style of plumage that ought not to be lost sight of. It is with difficulty got rid of by crossing. Half-bred Spanish and Dorking fowls have quite retained the barred and shaded feathers of the one parent, displaying the comb, earlobe, and stature of the other. And this curious and decided plumage is quite confined to one or two breeds, never appearing in others, such as the Game, the Malays, and Hamburgs—a circumstance which makes us believe it to indicate an ancient descent from some peculiar and original parentage." There is much in these remarks made in the very early days of the poultry "fancy" which confirms the experience of later fanciers. Since 1850 much progress has been made in collecting and perfecting pure breeds. Some, doubtless, have been imported from abroad, some have been manufactured by series of careful crosses, others have merely been made more distinct and characteristic by selections from various stocks. Instead of one or two Cuckoo breeds we can enumerate at least five different and distinctive ones, besides two or three others which are very rare, yet still we believe established races.

1. There is the five-toed well-known Cuckoo Dorking, or "Blue" Dorking, as they call it in Surrey, a hardy and good

layer and excellent table bird. They are now almost invariably rose-combed, though we have seen beautiful specimens with single combs.

2. The four-toed Scotch Grey, a very hardy and old Scotch breed, though we fear of late much crossed to gain additional size. Few breeds are more admirably fitted for a farmyard in an exposed situation.

3. The Cuckoo Cochin, not a common breed indeed, but still extant, and very handsome and well-feathered pens we have seen, which proves that it is no mere cross of yesterday.

4. The Plymouth Rock, four-clawed, rather long on leg but fine and robust, somewhat lighter in plumage than the older Cuckoo breeds. No fowl is more in favour just now for useful purposes. Doubtless it is a production of the New World.

5. Dominiques, shorter, rose-combed, yellow-legged; another American breed. Excellent layers in winter and early sitters.

All these breeds have their merits, and either as table poultry or layers are to be recommended. Those who must have something rare may search for

6. The old "Hennies," or Cuckoo Game, now nearly extinct. Or

7. Cuckoo Leghorns, seen now and then both in Italian streets and English poultry shows. Of the ordinary Leghorn form and Cuckoo plumage. Or

8. Cuckoo Polish, a lovely breed. We are the proud possessors of four or five, which we fancy (perhaps erroneously) are the only ones in England. There are still a few in France. Here is choice enough for anyone—not to mention the exquisite little Cuckoo Bantams shown to perfection by two or three ardent fanciers. Cuckoos of any breed to be appreciated must be seen in numbers. A prettier sight than a dozen of them, each one exactly like the rest, is hardly to be seen even in the poultry yard; and here no one can accuse us of an æsthetic fancy, for they are even more useful than ornamental.—C.

OUR LETTER BOX.

Management of Hedges (L. C).—Let your young hedge grow as it will for four or five years, and do not top or buckhead it, but have it laid or, as is termed in Lincolnshire, plashed, and this should be neatly done. The fence or quirk is planted in double rows, cut down one row close to the ground, not allowing any of the stools to be more than 2 inches above the ground; the other row will, if the plants are good, require half of them to be cut out, the other half to be laid down and neatly staked, placing a light binder on the top. After plashing do not top or trim any of the growth before the following autumn or winter, and after that trim once a year and no more, as experience has proved that frequently trimming hedges is quite a mistake. We are acquainted with a district where great pride is taken with the hedges, and these were trimmed twice every summer, and to the astonishment of all these hedges became covered with white moss, and after a few years began to decay and die in patches. These hedges were then allowed to grow for three years, and after that they were plashed and trimmed once a year only; but the herbage was cut clean from the roots, which is of the greatest advantage to get what is termed a good bottom. In some districts all young hedges are trimmed from the first year they are planted, and where this practice prevails there are scarcely any good hedges to be seen—that is, they all have open bottoms, whereas had they been plashed or laid they would have made as good fences as any in the north. Those who have young hedges to plant should trench the ground 2 feet deep and plant on the level without any mound or high bank, which is not only unnecessary but disadvantageous to the growth and well-being of the hedge.

Asthma in Canaries (W. H. Meyer).—Put some tar in the water from which they drink, and before the lungs become seriously affected. Bread and milk and plenty of Chickweed and Groundsel are also beneficial. The use of rice water has been strongly recommended by some.

METEOROLOGICAL OBSERVATIONS.

CAMDEN SQUARE, LONDON.

Lat. 51° 32' 40" N.; Long. 0° 8' 0" W.; Altitude, 111 feet.

DATE.	9 A.M.					IN THE DAY.				Rain.
	Barometer at 39s and Sea Level	Hygrometer.		Direction of Wind.	Temp. of Soil at 1 foot.	Shade Temperature.		Radiation Temperature.		
		Dry.	Wet.			Max.	Min.	In sun.	On grass.	
1883.										
January.										
February.										
	Inches.	deg.	deg.		deg.	deg.	deg.	deg.	deg.	F.
Sun. 28	30.140	36.5	34.2	S.W.	39.0	47.8	34.6	61.9	29.5	0.091
Mon. 29	29.554	51.1	50.0	S.W.	49.2	52.7	36.2	54.3	33.3	0.388
Tues. 30	29.434	36.8	35.0	S.W.	44.7	44.3	34.3	69.3	29.7	0.042
Wed. 31	29.543	30.8	30.7	E.	39.8	40.5	29.4	50.7	26.1	—
Thurs. 1	29.545	33.0	32.7	N.W.	39.0	40.0	30.4	56.7	28.3	0.094
Friday 2	28.981	45.9	44.5	S.	38.9	49.3	32.2	52.3	29.2	0.493
Satur. 3	29.730	40.4	38.0	S.W.	44.0	45.2	36.0	76.1	33.2	—
	29.590	39.2	37.9		39.8	45.3	33.3	60.2	29.9	1.058

REMARKS.

28th.—Fine bright and cold; solar halo at 1 P.M.; rain at night.

29th.—Very mild and squally with almost constant rain; calm in evening.

30th.—Bright, cold, sunny morning; showery afternoon; hailstorm at 4.55 P.M.; fine clear evening.

31st.—Foggy morning; thick white frost; day fair and cold.

1st.—Fine and dry; foggy about 5 P.M.

2nd.—Dull, with heavy showers; strong gale with rain in evening.

3rd.—Fine, with bright sunshine.

Rapid changes of barometer; frequent white frosts; nearly average temperature throughout the week; very heavy gale on 2nd.—G. J. SYMONS.



15th	TH	Royal Society at 4.30 P.M. Linnæan Society at 8 P.M.
16th	F	
17th	S	
18th	SUN	2ND SUNDAY IN LENT.
19th	M	
20th	TU	
21st	W	Meteorological Society at 7 P.M. Society of Arts at 8 P.M.

CERTIFICATED ROSES.

ROSSES have long received a large share of attention in the *Journal of Horticulture*, indeed on account of the numerous excellent articles given in its pages it is widely known as "the Rose Journal." In common with many others I have gained from it innumerable valuable hints on cultural difficulties connected with my favourite flower, and I confidently expect still further future gratification from perusing the contributions of experienced rosarians, who are always so ready to initiate a beginner in the mysteries of Rose culture. After reading so much with benefit to myself I am desirous to make some return, and am prompted to thus rashly invade the editorial sanctum. The mode in which I can best realise my desire is not quite so clear. In the cultural portion I have yet much to learn, and I have no rich pasture to transform into a Rose garden; but I can at least form an opinion on the flowers, and if this is too "rosy" I am open to correction.

During the past few years I have visited as many Rose shows as possible to observe the characteristic merits and defects of the numerous varieties, and I am impelled to record my impressions, but on this occasion will confine my notes to the certificated varieties of the past four years, and risk the gentle criticism of the veteran growers.

In 1879 four Roses were deemed worthy of special recognition at Kensington and Regent's Park, and in my opinion decidedly the best of these was the Hybrid Perpetual Charles Darwin, which was exhibited by the Messrs. Paul & Son of Cheshunt at one of the Royal Botanic Society's Exhibitions, and honoured with a certificate. This has been seen by many who have attended the Rose shows of the past year, but those who have not will form some idea of its merits from the following brief description:—The blooms are of good form and substance, the colour being a rich maroon, very deep and pleasing, and telling in a stand with lighter flowers. Probably one of the finest stands of this variety that have been exhibited was that with which Mr. C. Turner secured the second position in the single variety class at the Crystal Palace Show last year. Abel Carrière was the leading variety, but the competition was close, and the other blooms were greatly admired. At Bath also it was well shown in Mr. G. P. Hawtrey's first-prize box of six new Roses not in commerce before 1879. I have now a regret in not having been able to cut a good bloom last year; was this the fault of myself, my garden, or the variety

—in a word, is Charles Darwin a good and free grower?

Duke of Teck was another of the certificated varieties of 1879, also from Messrs. Paul & Son, but I believe it had been previously exhibited by them, and at the time it was shown at Kensington its merits were fully recognised. It is one of the Duke of Edinburgh type, but brighter in colour, quite a rich scarlet hue pervading the deep crimson. The bloom is of satisfactory form, and the habit of the plant as regards growth and floriferousness is all that could be desired. A handsome bloom of this variety was shown by Mr. B. R. Cant in his premier box of twelve crimson Roses at the Crystal Palace last July, and displayed its distinguishing characters to the best advantage. This I can manage better; indeed, it is so free as to prove an effective garden variety.

Of the two others accorded similar honours in that year one was the H.P. Isabella Ward, a reputed cross between Baronne de Rothschild and Sombreuil, and the chief merit of which appears to be that it is a free autumn bloomer, as the flowers individually are rather loose; the colour, however, is a delicate blush. It was exhibited by Mr. Ward in good condition, but I have not seen a fairly good example of it since. Has anyone else? The three preceding were all of English origin, but the last of the four, Madame Alexandre Bernaix, from M. Guillot fils, is a continental Rose, which is characterised as a Hybrid Tea. The blooms for which the certificate was granted were shown at Kensington by Mr. C. Turner, and bore some resemblance to La France, but of a deeper rose colour; of this, however, like the preceding, I have seen very little, and must leave others to record its merits.

In 1880 four exhibition Roses were also certificated. These were all of English origin, and it is satisfactory to notice the gradual improvement of the home-raised Roses in recent years. At one time, not very distant, we were almost entirely dependant upon the French raisers for our new Roses, but happily, for the credit of British rosarians, this has been to a great extent changed. One of the most noteworthy of new varieties of this year was Duchess of Connaught, from Mr. C. Noble of Bagshot. It is a Hybrid Perpetual with fine crimson flowers, especially noteworthy for their powerful and agreeable fragrance, very free, and of good form. When first shown at Kensington it was certificated as a decorative variety; but last year it was again exhibited before the Floral Committee of the Royal Horticultural Society and certificated as a show variety. It has thus been doubly honoured, and will probably become a favourite both in the garden and on the exhibition table.

Mrs. Harry Turner is one of Mr. Laxton's Roses, but was shown by Mr. C. Turner when the certificate was awarded for it at Kensington in the above year. It is a handsome rich crimson-coloured Hybrid Perpetual of great promise, and on several occasions I have seen it in excellent condition, the well-formed flowers being notable for their shining richness of surface. Mrs. Jowitt is also a beautiful Hybrid Perpetual from Hereford, having been exhibited by Messrs. Cranston & Co. at Kensington and Liverpool, and certificated at both places. It is said to have been obtained from a cross between Marie Rady and Duc de Rohan, and it certainly bears some resemblance to the former, though rather brighter in colour, and possessing a more powerful

fragrance. This was well shown at Hereford last year by Messrs. Curtis, Sandford & Co., who included it in a prize box of new varieties in company with Pride of Waltham and Ferdinand Chaffolte, though the first-named was the most striking.

Pride of Waltham is an addition to the many good varieties for which we are indebted to Messrs. W. Paul and Son, Waltham Cross, and well maintains the credit of the firm. It is a handsome variety of the Hybrid Perpetual section, and bears some resemblance to Marie Finger in style of flower and colour, but is distinct, extremely bright, and of good form. It was honoured both at Kensington and the Alexandra Palace, and during the past two years has been shown on several occasions in the most satisfactory condition. Though not an exhibition Rose, the charming variety of Fairy Rose, Little White Pet, which was shown by Messrs. E. G. Henderson & Co. in the same year as the above, is well worth mention, as it has already become a great favourite in cultivation, its dwarf habit and floriferousness admirably fitting it for culture in pots, and for decorative purposes it is invaluable.

1881 was not very prolific of new Roses, only two having been accorded the honour of certificates. Both these were Hybrid Perpetuals; one, Ferdinand Chaffolte, being exhibited by Messrs. G. Paul & Son, but I understand is of French origin, and the English Rose named Mrs. Gretton, shown by Messrs. Cranston & Co. at Liverpool. The first has made some progress in the favour of rosarians already, and took a prominent place in many stands of new varieties last year, it having dark crimson blooms of good form and substance, and is apparently of strong constitution. Mrs. Gretton is also a rich crimson-coloured variety, but it has not become very generally known at present, though it possesses the good qualities of symmetry, substance, and rich colour.

1882 surpasses the three preceding years in the number of new Roses certificated, no less than seven being so honoured. Five of these are English Roses, the other two coming to us from the continent. Duchess of Connaught has already been noticed, and therefore the first demanding attention is Queen of Queens, a superb Hybrid Perpetual exhibited by Messrs. W. Paul & Son, and entitled to rank amongst the best sent out by that firm. The flowers are large, of good substance, full, and of a delicate rosy pink, most distinct and chaste. The plant is free and the habit vigorous. Ulrich Brunner Fils, shown by the same firm, has rich crimson-scarlet flowers, but rather loose, and to this circumstance might be attributed the second-class honours adjudged for it. Reine Marie Henriette is by no means new, but it was certificated as a climbing Rose when shown at Kensington by Mr. R. T. Veitch of Exeter, and is therefore worth notice amongst the others; it has bright rosy fragrant flowers, and has been not inaptly termed a red Gloire de Dijon.

There now remain only the beautiful pedigree Roses with which Mr. Bennett of Shepperton has at last scored so decided a triumph. No less than three of these were certificated last year, and well they deserved the honours they obtained. Lady Mary Fitzwilliam was certificated at Kensington, Regent's Park, and the Crystal Palace, a triple honour which speaks for itself as to the merits of the variety. It is the result of a cross between *Devoniensis* and *Victor Verdier*, but is somewhat suggestive of *Capitaine Christy* in colour

and form of flowers, which are large, globular, of a delicate pink or blush colour. The plant is dwarf and robust in habit. Her Majesty deserves attention next, as it secured honorary recognition both at Kensington and Regent's Park. It has large flowers rather inclined to be loose, the petals being thin, but the colour, a most delicate pink, is very pleasing. The last of the trio is Earl of Pembroke, obtained from a cross between *Ferdinand de Lesseps* and *Marquise de Castellane*, and has very rich crimson-scarlet flowers, the petals broad, and the flowers full. This was certificated at Kensington, but it was much admired at several other places, and will doubtlessly be seen again this year.

On two occasions last year I was much attracted by a variety that is quite new to me, and which is said to be from America. This is *William Allen Richardson*, and was shown by Mr. House of Peterborough at the Mansion House and the National Rose Society's Show, Kensington, but I am not aware that it has been certificated. The blooms are of moderate size, rich bronzy-orange in colour—a most distinct colour, and when a number of blooms are shown together, as they were in both the above instances, the effect is most striking. Can any of your numerous rosarian readers give the history of this variety?—A YOUNG ROSARIAN.

ON SHALLOTS.

VERY little attention is now bestowed on this old-fashioned vegetable, without which at one time no garden establishment would have been considered complete. It would appear to be going almost out of cultivation, so rarely is it to be met with in English gardens if we except the very highest. Perhaps for Scotland and other more northern places it is much more common.

Botanically the Shallot is nearly allied to the Onion, being of the same genus *Allium*. It is named *Allium ascalonicum*, from Ascalon in Palestine, where it is found in its wild state. The English name of Shalott, or Shallot as it is generally spelt, and the French Chalote and Echalote, are no doubt derived from the same source. In France it is also called *ail stérile*, in allusion to its peculiarity of rarely producing seeds. It is a perennial plant, and is increased or reproduced solely by division, the single bulbs when planted producing in return a number of bulbs in a sort of tuft. These characters are its distinguishing features and are well known.

As to varieties, there are two very distinct types that have long been cultivated in this country, and two only—viz., 1, *Common*.—Bulbs small or about the size of a walnut, 1 inch in diameter and 1½ inch in height, of irregular pyriform shape; the outer skin when ripe silver grey or of a dirty brown colour; the inner scales slightly tinged with purple, produced in tufts of from five to eight or ten in number. Leaves about a foot in length, produced in close tufts of a bright green colour. This is earliest variety. 2, *Large Brown*.—Bulbs nearly twice the size of the Common, being 2 inches in diameter and about 2½ inches high. The outer skin of a reddish brown colour; the inner scales or flesh tinged with deep violet or purple, fleshy. The bulbs produced in tufts of from three to seven or eight. The leaves 18 inches long, not nearly so spreading as the Common, of a deep green colour. In the Royal Horticultural Society's Gardens at Chiswick during the past year numbers of so-called different varieties of Shallots were grown, from which my observations have been taken. The Common Shallot, for example, had for synonymes *Small White Silver Grey*, *Large Brown*, and *Russian*; and the *Large Brown* had for its synonymes *New Russian*, *Small Red*, *Large Red*, and *Large Russian*, also *Stuart & Mein's Exhibition Shallot*, which certainly appeared to be an extra large and fine selection.

Two other varieties were here grown and demand notice—viz., that which is known as the *Jersey Giant Red Shallots* and the *Jersey Silver-skin*, the seeds of which on being sown the one season produce bulbs like the Onion, and which on being

planted out the following season produce flowers and seeds. These are biennial characters similar to the Onion (*Allium Cepa*), and quite distinct from the perennial and almost seedless character of *Allium ascalonicum*. These Jersey Shallots are in fact Onions, and of a very inferior variety. The bulbs are of a fair size, of uneven and irregular growth, being often divided into a number of crowns or smaller side bulbs similar to the Potato Onion. The flesh of the leaves glaucous like the common Onion.

In Thompson's "Gardener's Assistant," new edition, three varieties of Shallots are mentioned—viz., 1, Common; 2, Jersey or Russian; 3, Grosse Échalote d'Alençon, the two latter, on the authority of Vilmorin, being stated "to belong to a different species from the true Shallot, or to be some form of the Onion." The descriptions are extremely vague, the writer being evidently ignorant of the subject.

Turn we now to "Les Plantes Potagères," that magnificent new work on vegetables by Messrs. Vilmorin, replete with the very best information on these plants that is obtainable. Messrs. Vilmorin first describe the Échalote ordinaire (syn. Échalote petite), which is identical with our common Shallot. Several sub-varieties of this are known in the Paris markets—viz., L'Échalote petite Native de Bagnole, a variety somewhat smaller than the type or Common Shallot; L'Échalote Grosse de Noisy, having bulbs the size of a small fig, very thick skin, and keeps well; L'Échalote Hative de Niort, a little smaller than the Common, later, but otherwise resembling it very much.

Secondly, Échalote de Jersey, with the English synonyms Jersey or Russian Shallots. This Messrs. Vilmorin describe as in all its characters to exactly resemble the Onion, "amongst which it should be classed." L'Échalote d'Alençon is described as having larger bulbs than the ordinary form, but with equally glaucous foliage; and the Silver-skin is noted as a bad-keeping variety. L'Échalote de Gand and L'Échalote de Russie are further noted as very similar to the Jersey ordinaire.

Some confusion seems to exist with regard to the Russian Shallot, Vilmorin and Thompson giving it as a synonym of the Jersey; whilst in this country, and more particularly in Scotland, it is well known as a true Shallot and synonymous with the Large Brown, and was in cultivation long antecedent to the so-called Jersey Shallots. It would appear to be unknown to Vilmorin.

It is to be regretted that in so excellent a work as "Les Plantes Potagères" these Jersey Shallots—which it is proven are not Shallots or varieties of *Allium ascalonicum* at all, but true Onions—should have been introduced.—A. F. B.

POTATOES FOR TABLE AND MARKET.

WE know of no more laudable work than that of endeavouring to raise varieties of Potatoes that shall possess the requisite properties for insuring, as far as possible, an abundant supply of produce of satisfactory quality. All who are engaged in this work, whether from patriotic motives or honourable trade enterprise, are most meritoriously employed, for the vendor of a sterling article of paramount utility cannot benefit himself without benefiting the public too.

During late years great exertions have been made with the object of improving the Potato and increasing its productiveness. That a large measure of success has resulted is abundantly clear. One fact suffices to show this in a very striking measure—namely, that last year, which certainly was not one of the brightest and the best for Potato cultivation, not only were sufficient raised for the requirements of this country, good and cheap tubers being plentiful in the markets, but thousands, if not millions, of bushels have been exported to America to supply the deficiency in the crop of the United States. This is alike gratifying and encouraging, and it is in a large measure due to improved varieties and methods of culture that have been established within a comparatively recent period.

The wonderful produce that has been staged at great Potato exhibitions has demonstrated what can be done by sound culture, and thousands of persons have been induced to try and emulate the splendid results that have there been represented. More new varieties have been raised and tested, while old

favourites have been better cultivated during the past few years than was ever previously known in the history of the Potato, and the outcome of this great Potato-reviving effort is that we have enough and to spare. With old varieties alone and a haphazard system of culture this success could not have been attained. The two useful varieties, Magnum Bonum and Scotch Champion, have, without doubt, contributed to an incalculable extent to the well-being of this and other countries, and without these varieties it is not possible that the Potato supply could have been maintained in the present satisfactory condition. Wisely have endeavours been made to improve on these, and who knows but what some of the many varieties now on trial will not reach the high standard that is sought for? That many will fail to do so is inevitable, since the numbers are so great as to be not a little perplexing, and the more so when soils and localities exercise such an influence on either the weight or the quality of the crops.

Under these circumstances it is not surprising that extreme opinions have been formed on the Potato question—one section of the community denouncing the older varieties as effete and not worth cultivating, and the new alone capable of giving a profitable return; another section ruling diametrically opposite—namely, that only the good old varieties can satisfy the consumer, the new fancy sorts being good enough to look at, but not fit to eat. If we had chronicled all such estimates that have come to our notice the list would have been as formidable as conflicting. Indeed, so strong are individuals in the soundness of their respective views, that we find it scarcely possible to recommend half a dozen varieties without being questioned—on the one hand, for naming some of the good old kinds, and on the other for including the new.

"We want to plant from six to twelve really good and reliable varieties for use; which do you consider the best?" is the substance of letters we have not yet answered. With the object of answering them and anticipating others we have obtained the co-operation of cultivators in all parts of the kingdom, and if there is wisdom in a multitude of councillors we shall have words of wisdom to publish relative to this important subject. From upwards of 160 cultivators we have been favoured with information—105 in England, 26 in Scotland, 17 in Ireland, 13 in Wales, and one in Guernsey. Each has submitted a list not exceeding twelve, or not more than four in each section, first early, second early, and late varieties. The character of the soil is named in each case, also the manure that is employed, and the general method of culture that is adopted; and further, those varieties are particularised that are found the best for growing for market. Thus many suggestive hints and much useful information will be found in the reports we shall publish. These are, however, in the aggregate voluminous, and a few weeks must necessarily elapse before the whole of them can appear. In the meantime, as the varieties named are of the first importance, we give those which have found the most favour with cultivators in the wide field indicated.

As will be seen by the verdict of those growers, neither the advocates of the old nor the patrons of the newer sorts can claim a triumph, and we have another instance of the safe course being the medium between the two extremes. While many of the old favourites have maintained their ground nobly yet some of the newer have surpassed them, and many are rising rapidly in public esteem. It does not follow that those that have only been named by a few individuals are on that account inferior; on the contrary, some of these may eventually rank among the best in their generation, and indeed some of them promise to do so. It is not until a variety is widely and generally cultivated that its merits can be estimated by the greatest number of cultivators. The age of a variety is, therefore, an important factor in determining its merit by the votes it has received. To give one instance: The twenty-nine votes accorded to Reading Hero carry more weight than forty-four registered for Dalmahoy, because the latter is, say ten times older than the former, and has been tested by almost everybody, while experience with the Hero has obviously been much more limited, yet it has risen to a high position with a rapidity that strikingly indicates its worth. Still, whatever position the different varieties occupy, this at least is certain—

every one in the list has been found to possess merit for table use under certain conditions that may be gathered from the reports. Thus each reader can choose for himself those varieties that appear to be most adapted to his circumstances, in addition to others still newer that it is so desirable to test under differing conditions as to locality, soil, and climate. In analysing the lists before us we arrange the varieties in the three groups or divisions above mentioned.

First Earlies.—Considering that no cultivator named more than four varieties it is a little surprising to find that no less than six y-nine sorts have been found worthy of mention by at least some of our correspondents. In this section Myatt's Prolific heads the list, having been recommended by ninety-nine cultivators, Veitch's Improved Ashleaf by eighty-seven, Rivers' Royal Ashleaf by fifty-six, Old Ashleaf by forty-six, Early Rose eighteen, Mona's Pride and Beauty of Hebron fifteen each, Early Coldstream fifteen, Early Hammersmith ten, Early Bird nine, Snowflake, Porter's Excelsior, and Early Racehorse, six each.

The following have also been recommended, but by a less number of cultivators than those enumerated:—Suttons' Fillbasket, French or Early Shaws, Alpha, Covent Garden Perfection, Walnut-leaved Kidney, Flounders, Suttons' First and Best, Extra Early Vermont, Early Sandringham, Early Fortyfold, Gloucestershire Kidney, Suttons' Ashleaf, Suttons' Early Border, Climax, Rector of Woodstock, Carter's Champion, Early May, Fox's Seedling, Grampian, Woodstock Kidney, Lapstone, Prince of Wales, Early Oxford, Early Handsworth, Suttons' Field Ashleaf, Lady Truscott, Ruby, Lady Paget, Union, Triumph, Beauty of Kent, Alma, Uxbridge Kidney, King of the Earlies, Hart's Ashleaf, Paterson's Victoria, Jackson's Improved, Dalmahoy, Cosmopolitan, Huntingdon Kidney, Empress Eugénie, Wilson's Early Frame, Llangollen, King Noble, King of the Earlies, Giant King, Smith's Seedling, Queen of the South, Magnum Bonum, Ice Cream, and Red Kidney.

It is strange to find such varieties as Paterson's Victoria, Magnum Bonum, and Dalmahoy in this list, but strange things are to be expected in a matter of this kind, and if the remarks of the cultivators do not explain the circumstance it must be concluded the names have been inadvertently entered in the wrong list. We must observe that several varieties in this section are also named in the following list.

Second Earlies.—No less than eighty-seven varieties have been recommended in this section, the comparatively new variety Schoolmaster heading the list with fifty-nine votes, followed by Dalmahoy with forty, Covent Garden Perfection twenty-nine, Fortyfold twenty-seven, Woodstock Kidney twenty-five, Snowflake twenty-four, Porter's Excelsior sixteen, Lapstone and Beauty of Hebron fifteen each, Grampian thirteen, Myatt's Prolific, Early Rose, and Gloucestershire Kidney, twelve each, and Prince Arthur ten. The following were also named by a less number of cultivators:—Suttons' Reading Russet, Dawe's Matchless, Radstock Beauty, Climax, Early Coldstream, Early Oxford, Pride of America, International, Yorkshire Hero, Suttons' Early Regent, Fiftyfold, Lady Truscott, American Purple, Rivers' Ashleaf, Racehorse, York Regent, Prizetaker, Early Border, King of Potatoes, Radstock Beauty, Late Rose, Gloucestershire Kidney, Drummond's Prolific, Flourball, White Elephant, Huntingdon Kidney, Lady Paget, Rector of Woodstock, Dunbar Regent, Walker's Regent, Rintoul's Early Don, Jackson's Kidney, Beauty of Kent, Vicar of Laleham, Bresee's Prolific, Breadfruit, Extra Early Vermont, Early Goderich, Ashtop Fluke, Milky White, Edgcott Seedling, Triumph, Fluke, Queen of the South, Daintree's Seedling, Adirondach, Bresee's Peerless, Holborn Favourite, Rintoul's Pink Don, Bedford Prolific, Trophy, St Patrick, Blanchard, Kemp's Seedling, Flounders, Reading Abbey, Manhattan, Gryffe Castle, Striped Don, and a few local varieties; both Magnum Bonum and Paterson's Victoria also found a place in this list.

Late Varieties.—Here we find a great falling-off in the number of sorts, only forty being named. Magnum Bonum has the premier place with 132 votes, thus only thirty out of 162 cultivators fail to name it; 108 recommend Scotch Champion, eighty-one Paterson's Victoria, for y-two School-

master, twenty-nine Suttons' Reading Hero, twenty-three York Regent, fifteen Dunbar Regent, nine each Skerry Blue, Rocks, and Red-skinned Flourball, eight Vicar of Laleham, seven Fluke, and six Grampian. The following were also named, but less frequently, some of the varieties being new:—White Elephant, Fiftyfold, Wormleighton's Seedling, Uxbridge Kidney, Grampian, Pride of Ontario, Brownell's Beauty, Peachblow, Bresee's Climax, Walker's Regent, Rintoul's Don, Late Regent, Lapstone, Late Rose, Queen of the Valley, Prince Arthur, Red Rock, Scottish Queen, Silver Skin, Fortyfold, The Queen, Yorkshire Hero, Rector of Woodstock, and Adirondach.

Such, then, is the selection of varieties found suitable by cultivators for home use and market purposes, and we have no doubt that all these will be more extensively grown during the ensuing season, as the soil and locality may be adjudged suitable, according to the indications that will be found in the remarks we shall publish, while a great number of still newer varieties will, as they should, be tested over the length and breadth of the land.

GRAFTING.

YOUNG gardeners who have not yet learnt the art of grafting will have no difficulty in splicing one branch to another neatly by following the instructions given last week. They may and should practise with portions of any kind of forest tree until they can quickly, smoothly, and accurately accomplish the important work. It must always be remembered that in splice-grafting the bark of the stock and scion must fit closely—not the outer bark, but the inner. In placing a small graft on a larger stock the junction of the bark can only be on one side, and in such a case it is rare indeed that the outer bark of a scion must be flush with

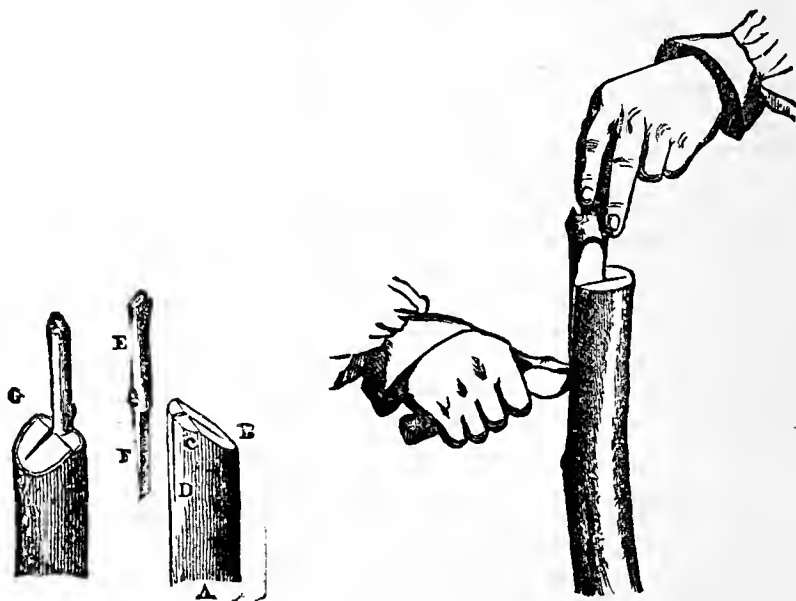

Fig. 37.

Fig. 38.

the thicker outer bark of the stock. A few experiments and attentive observation will enable anyone to perceive this, and provided the inner barks meet no concern need be felt at the relative positions of the outer. Beginners often fail by paying too much attention to fitting the scion to the outer bark of a thicker stock. Other methods of grafting must be learned. Very clear is Baltet on cleft grafting:—

Grafting in a Single Cleft.—We have here a stock (fig. 37, A) of medium size, which we cut obliquely at B, the top, C, of the cut being smoothed horizontally; then with the point of the knife make a vertical split, D, to correspond in length with the cut on the scion, and in such a manner that it will not extend to the opposite side of the stock. When the cleft is made with the instrument in one hand, take the scion E in the other, and there insert it by the upper opening, pushing it down according as the cleft opens (fig. 38), and withdrawing the knife as soon as the scion has attained its proper position. The cut of the scion F, when inserted at G, must have its bark coinciding with that of the stock, without any unevenness. If the stem has a thick bark the scion is to be slightly inclined in the cleft, the top being a little inwards and the base outwards, so as to secure some point of contact between the liber and alburnum of the two parts, for the union is formed by these, and not by the external layers of the bark.

Grafting in a Double Cleft.—The stock (A, fig. 39) being larger will receive two grafts. The cut B is horizontal, and we cut the stock diagonally at C either by pressing down the knife with both hands perpendicularly, or, if the wood is too hard, striking it with a small mallet. The grafts are placed one by one in the mouth, or in a vessel containing fresh moss. When the cleft is two-thirds made, draw out the knife on one side, so that the cleft shall be kept open, place a scion, D, at the other side, and using the blade of the knife as a lever, the scion will be easily inserted in its place. The insertion of the other scion is not more difficult; perhaps it may be again necessary to place the blade of the knife in the centre of the cleft, C, in order to force it open a little, so as the more easily to admit the second scion. If there is any danger of breaking the knife by using it in this way, a small boxwood wedge may be put into the centre of the cleft instead. The two scions can then be put in without making the cleft larger. Tying and the application of grafting wax are likewise necessary.

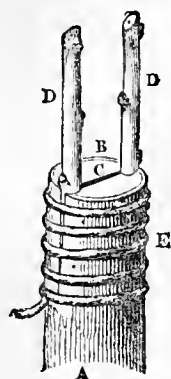

Fig. 39.

Notch Grafting is shown with equal clearness. The scion A (fig. 40) is cut in the form *a'*, taking care to have a bud, *b*, at the

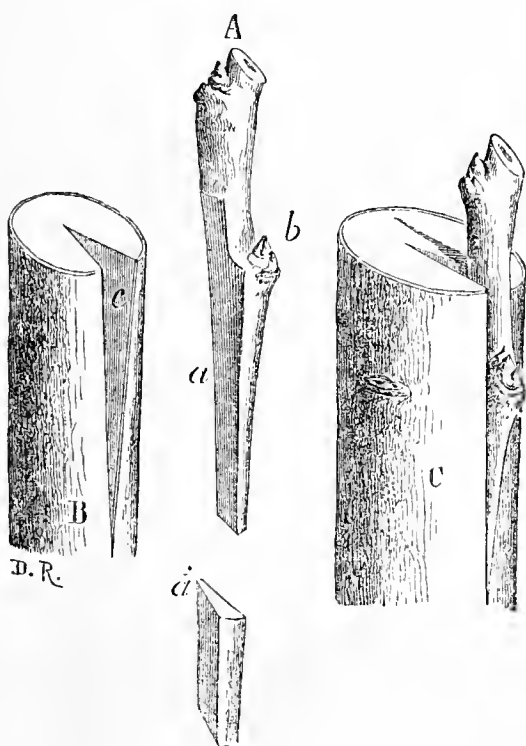

Fig. 40.

back of the slanting cuts. This bud, with the scion to which it belongs, is let into the notch *c*, made in the stock B, as at *c*. The graft is then tied and waxed.

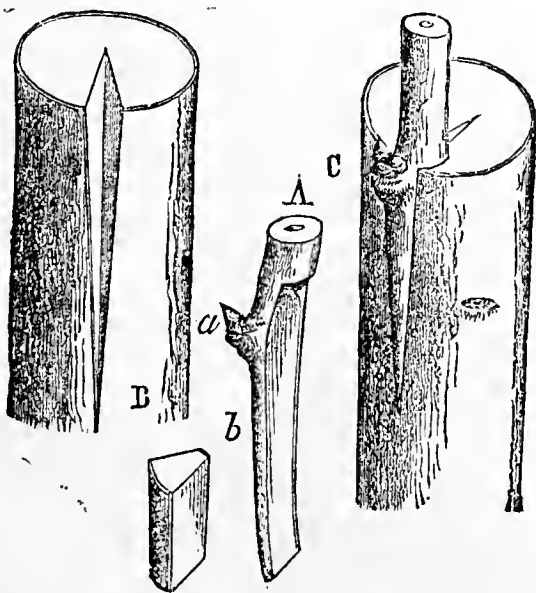

Fig. 41.

Fig. 41 represents a modification of this mode of grafting, differing only in the scion A having a single bud, which is sunk in

the stock in the same manner as in the last example. The scion A is cut slantingly, as at *b*; B is the notch in the stock, and C the scion when inserted in the stock. All that is now to be done is to wax the graft, taking care in doing so not to break off the bud *a*. According to the length of the notch, the bud may be inserted level with the top of the stock, as in fig. 41, or lower down, as in fig. 40. By this mode of grafting, the shoots of valuable or scarce kinds can be made to furnish as many scions as there are buds.

PLANTS FOR A DARK CONSERVATORY.

"A. T." asks on page 67 what climbers and other plants will succeed in a dark conservatory. It must be dark indeed from his description of the building. "A. T." could not do better than procure some plants of *Ficus repens* to furnish his back wall, especially as he has heat at his command. About half a dozen strong plants placed in large pots or tubs would soon cover the wall; and for suspending from the roof I would recommend *Pasiflora cærulea* and *Cobæa scandens*, and the variegated variety. He should certainly erect a bench or a stage of about three steps. The top step or bench, whichever is used, should be about 6 inches below the windows. By this means he will bring his plants to the light much better than when placed on the floor, although a few tall plants at the back would break the flat appearance of the wall. *Ficus elastica* and *F. Cooperi* would succeed, also *Cordyline australis*. For the front of the house I should strongly recommend *Aspidistra lurida*, its variety *variegata*, and some of the greenhouse Palms, such as *Corypha australis*, *Chamærops humilis*, and *C. Fortunei*. *Curculigo recurvata* would also be useful. Many of the fine-foilage *Begonias* would succeed in the summer months. *Isolepis gracilis* might be associated with pots of *Panicum variegatum*, which would form a good edging for a bench. *Agapanthus umbellatus* and many of the Ferns would succeed, such as *Pteris serrulata*, *P. albo-lineata*, *Asplenium bulbiferum*, *Cyrtomium falcatum*, *Davallia capensis*, *D. bullata*, and *Nephrodium molle*. *Selaginella Kraussiana* would grow well in such a house, but I should advise "A. T." not to try flowering plants.—J. P.

FORMATION AND MANAGEMENT OF HEDGES.

A GOOD well-kept hedge is most pleasing to all concerned, while a poor neglected one is an eyesore to most people. If in our travels we go through a district or enter the gardens where all the hedgerows are even and well kept, we arrive at the conclusion that the proprietors take a delight in their property, and are well served by their responsible servants. In many large places the gardener has nothing whatever to do with the preservation of the hedges, but there are innumerable country seats where much of the work has to be performed by the gardeners. Qualified foresters require no advice upon the subject; at the same time there are many employers and gardeners to whom perhaps a few hints may prove acceptable.

In the first place much depends upon laying the foundation for a good hedge. No matter what plants may be employed, unless the ground is well prepared for their reception the probability is they will not make the desirable rapid and even progress. In too many cases, instead of deeply digging the intended site at least three spits wide, and mixing some good semi-decayed manure at the same time, the ground is dug as the planting proceeds, one spit being roughly pressed on the root of the plant inserted in the hole from which the preceding spit was taken. Now the plants employed as a rule are reared in a nursery, the soil of which has long been cultivated and manured, and it is almost inconceivable how anyone could expect them to root freely and grow strongly in a poor and probably shallow uncultivated soil. In Scotland where good hedges are the rule they do not commence planting till all danger of severe frosts are past, and those in more favoured southern counties will do well to delay planting till late in February. Cold saturated ground proves very destructive to newly planted hedgerows, and the plants also experience a check if the roots are exposed for any length of time to cold drying winds. Yet how often are the plants, when had from a distance, allowed to stand about in bundles for days without any protection to the roots.

My plan is to dig the ground slightly in advance of those planting, as the newly moved soil can easily be broken up. If dug some time previous and has become saturated with rain it is difficult to plant firmly and well. If an open ditch is near no other drainage is required, otherwise a drain should be laid near, as few plants will succeed in cold undrained land. It is also necessary to make ample provision for protecting the young hedges for several years from sheep and cattle.

The list of suitable kinds of deciduous plants and evergreens for forming hedgerows is rather limited. A good hedge of Holly leaves nothing to be desired, though unfortunately Holly does not thrive on heavy soils. Hollies ought not to be planted till near the commencement of growth, say late in March or early in April, and a single line of plants 12 inches apart is sufficient. The next best is the common Yew, and both these and Hollies are admirably adapted for forming handsome screens. They grow rapidly, form good bottoms, and can be cut to any shape, Yew especially being often trimmed into most fantastic forms. The common Laurel forms a good hedge, but is not sufficiently hardy to be relied upon. The Colchican is the hardiest. Laurels and Yews transplant readily and nearly at any time, and good-sized plants may safely be planted where immediate effect is desired. I recommend planting in a single row, and close enough to touch on each side. Berberis Darwinii forms a most beautiful hedge, while Berberis aquifolium is suitable for a dwarf and broad hedge, such, for instance, as may with advantage fringe a coach road. Tree Box also is well adapted for a hedge, and this mixed with common Arbor Vitæ is very neat and ornamental.

For surrounding pleasure grounds and plantations, these oftentimes being also game preserves, I prefer a hedge formed with a mixture of Quick Thorn and Beech; they may be planted in a single row, the latter being 15 inches asunder with two Thorns between them. The Beeches eventually nearly or quite overgrow the Thorns, the latter, which perhaps manage to form the point of the hedge, being only required to fill up till such times as the Beeches are sufficiently spread. Beeches unfortunately do not grow well on heavy soils, but under favourable circumstances a good hedge and a good screen is formed by them, as in this position they retain their leaves till the following spring. Thorn alone grows into a good hedge; or mixed with Privet, as it very frequently is, it largely contributes to the formation of a neat if not quite so impenetrable a hedge.

If it is necessary to lay a good foundation at the roots it is equally so with regard to the bottom of the hedge. Here is where the greatest strength should lie, and this is principally secured by frequent stoppings, the required height being gained in a few years. Hollies, Yews, and Box being naturally pyramidal, if well furnished at the bottom need not be stopped in the earlier stages of growth; but Laurels, Privets, Thorns, and Beeches, especially the three latter, should be cut down to near the ground the second season after planting, and be cut back to within 8 or 9 inches of their last starting point for the next two years. Even later on they should not be allowed to run up too rapidly. The ground on each side should for the first few years be annually lightly dug, and the hedges kept perfectly clear of weeds. The common method of training hedges with a wide and either flat or rounded top is quite a mistake, thus rendering them ugly, besides greatly weakening them. The plan adopted, or at all events was some years ago, on the Duke of Hamilton's and other noblemen's Scotch estates, is much the best. There the hedges are wide at the bottom and pointed at the top—that is to say, are wedge-shaped. This hard cutting at the point induces a strong growth at the bottom where most required. There are hedgerows on this estate composed of Beeches and Thorns and trimmed in the Scotch fashion which are about 5 feet through at the bottom and 5 feet in height, and a very creditable appearance they present. They prove impenetrable by either man or cattle, while dogs and game find it no easy matter to get through. Those elsewhere cut to a wide or rounded head are frequently bare at the bottom, and the thickest part is easily split open. Another advantage wedge-shaped hedges have, they smother or prevent any undergrowth of weeds, which in the case of the narrow hedges require to be frequently cleared out, or the hedge is soon injured, besides being unsightly.

Hedges to remain vigorous should not be cut but once during the year, and then in the case of Thorns and other deciduous plants during the winter, completing before the sap begins to rise. If Hollies, Yews, and Laurels are cut before the end of March or early in April there is the danger of the young growth being injured by the spring frosts. Where midsummer trimming is considered necessary in order to insure general neatness, this should be done not later than July, or it is probable the second growth will not be matured. In an unmaturing state it is easily injured by frosts, and failing to break strongly the following spring the consequence will be the commencement of the ruin of the hedge. When only cut once healthy growth invariably results, and the hedge continues to strengthen. Where gaps have been by some means made, after the ground has been cleared, manured, and dug they should be repaired with young plants, these being protected from cattle and other enemies with post and rails or hurdles on each side. Many an old hedgerow would, if cut down to near the ground and protected, break afresh and soon

attain a much improved appearance. Since farmers have employed fewer hands the hedges and ditches have been allowed to go to ruin, and along the roads instead of well-trimmed hedges we now see banks formed by the annual ditch clearings and covered with weeds. Not a few hedges have been spoilt in this manner on gentlemen's estates. It is an easy method of getting rid of the mud, but it rapidly destroys the hedges.—W. IGGULDEN.

HISTORICAL JOTTINGS ON VEGETABLES.—2.

THE PEA.

WISE old Gerard, no mean botanist, herbalist, and gardener—a man who in various things had much more knowledge than his contemporaries generally—spells the name of a familiar esculent “peason,” a word which in the crabbed handwriting of some of our ancestors bears a suspicious resemblance to “poison.” Not long after Gerard's time it got abbreviated to “pease,” then in ordinary usage it lost the final *e*. Evidently the English name was a corruption or modification of the Latin *pisum*. Mr. H. G. Glasspoole remarks that the Pea, like the Bean and probably the Lentil, has an antiquity which we cannot calculate with certainty. One proof of this is that decided remnants of Beans and Peas, not differing greatly from our well-known species, have been discovered in the lake habitations of Switzerland belonging to the pre-historic ages. The Greek name, *pisos*, almost the same as the Italian, seems to have had its origin in a word meaning to “beat” or to “thrash,” suggesting that these ancient peoples—as, indeed, other facts imply—only used Peas dried and removed from their pods. Many allusions are to be found of the cookery of this vegetable by a process of parching or frying. Perhaps the French (for we can but conjecture) were the first to appreciate Green Peas, about the period of the Norman conquest.

It appears the early consumers of Green Peas, with a taste somewhat unrefined, devoured the entire pod, or “peas-codde,” as they called it. Poor Lackpenny, self-styled, in his wanderings about London while the sixth Henry was king, heard this dish cried along the city streets. The next improvement was cooking the pods whole, and then at the table people dipped them in butter, licked out the peas, and threw away the shells. An uncomplimentary reference to the fair sex is made by another of the strolling poets of the olden time:—

“Were women as little as they are good,
A peascod would make them a gown and hood.”

Yet even in the reign of Queen Elizabeth, centuries later, young Peas were esteemed a rarity and fetched high prices. The monks, it is true—diligent experimenters in their convent gardens—to occupy their spare hours would compete to see who could bring the earliest dish of Peas upon the table. Thus at Barking in Essex they could raise Green Peas by the Easter festival when it fell late. How the monks managed to force them is not explained to us. Doubtless they sowed in autumn, and one old author insists this ought to be done while the moon is on the wane. And as far back as the days of Pliny the Greeks sowed Peas in November, but the Romans considered it better to plant after the coldest months of the year had passed away. Evidently the Pea was little cultivated by us English folks until about two centuries ago, though the country people were accustomed to go out and search for the wild Peas, formerly abundant on waste places. This species, *P. arvense*, still occurs here and there, and is presumably a native. A rarer species now, the Seaside Pea (*Lathyrus maritimus*), a perennial, also supplied food of an indigestible nature in the seasons of scarcity once frequent in Britain.

“Dig garden, 'stroy Mallow, now may ye at ease,
And set, as a daintie, thy Runcival Peas.”

So writes Thomas Tusser, giving his versified items of advice for the month of January; and whether it was that the old-fashioned gardeners thought an autumn sowing of Peas served chiefly to furnish food to insects and the irrepressible London sparrow I cannot say; but when market gardens began to increase around London their proprietors for a good while adhered to the plan of Tusser. They sowed their Peas on mild days in January or February, and if these suffered from some early frosts, the crop had the advantage of an April and May more propitious than we now look for in average years. Abercrombie, in his handbooks for gardeners in the reign of George III., recommends the sowing of a few Peas—Hotspurs by preference—in the autumn; the “Marrowfats” and “Runcivals,” with other varieties he specifies, were to be sown on “warm plots” not before the new year. It is to be observed that this author distinguishes these, mentioning “Runcivals” as white, green, and grey, although some have hastily surmised this was merely the original name for the Marrowfat Peas, and rather odd explanations have been given

why they were so called by those who knew not the history of the word. But this particular Pea of large size doubtless got its appellation from the town of Roncevalles in France; for there during the middle ages people exhibited huge bones which were said to be relics of a race of gigantic warriors—hence arose the popular comparison, which transferred the name of the town to these Peas and to other objects specially large or remarkable. It does not seem to be the case that the “Runcivals” were produced in the old French town, any more than that the “Hotspurs” were grown by the famous Harry; and even at the end of last century there was barely a score of varieties of the Pea, which we now might reckon by the hundred.

One author tells us that the price of Green Peas was usually high in the reign of Queen Elizabeth, so that it was worth while to bring supplies from Holland. When contrary winds prevailed these could not have reached the London market very fresh. Towards the end of her reign an advance was made in the culture of Peas near the metropolis, the citizens planting them in several places for their personal benefit. Goodman’s Fields was turned into garden plots about the beginning of the seventeenth century; and that Peas were produced thereabout we conjecture from a Peascod Lane marked upon old maps, and subsequently changed into Prescott Street. The Fulham Pea, says Coles, was a variety that became famous owing to its being a forward kind, at least in that district, though probably the celebrated garden land that laid around the “Neat Houses” between Millbank and Chelsea, on the north bank of the Thames, produced Peas for the Court and the nobles, who lived at Westminster, before crops were raised at Fulham. The soil and situation were very suitable for vegetables, if we can form correct notions of what the district was two hundred years or more ago that we in this era call South Belgravia. Upon the Surrey side of the river Vauxhall and Battersea were of old repute for their Peas, and positively some are still gathered in the latter suburb in spite of the smoke and vapours that environ it; but the market gardens yet remaining in the vicinity of London supply only a small part of its Green Peas. Baskets are regularly sent by rail from many miles off.

An ancient custom, not dead in some northern counties, connects the Pea with the last Sunday but one in Lent, which bears the name of “Carling Sunday.” Grey Peas are soaked for a day and then fried in grease. Some assert the dish is to commemorate the picking of ears of Wheat by the Apostles as they walked through the fields (Matt. xii. 1). Not particularly wholesome so cooked, yet when ground into flour dried Peas contain all the elements of nutrition, rivalling Wheat and Oats. We no longer eat Green Peas entire as our forefathers did, but it should be noted that quantities are gathered for family use and also sent into the markets that have been allowed to grow too large. Even in the best kinds the skin becomes somewhat tough, and, however well masticated, is likely to be injurious to those who have not strong digestive organs.—J. R. S. C.

ORCHIDS AT DAVENHAM BANK, MALVERN.

CHRISTMAS is not the best time for Orchids, but judging from my visit recently there must be always something worth seeing in Mr. J. D. Perrin’s collection at Malvern, for I saw much to interest me, and more than I can detail in these notes. One noticeable fact in connection with the tropical Orchid houses is that they are double-glazed, and Mr. Jacques, the gardener, informed me that before he adopted this system it was almost impossible to maintain a regular temperature in winter. Although at the foot of the hills, the houses are so situated as to be exposed to the cold easterly winds. The first Orchids that attracted my attention was a splendid batch of *Dendrobium nobile*, about fifty plants of different sizes, all showing flower remarkably well: not, as are sometimes seen in collections, with only a few flower buds at the point of the growths, but from top to bottom, as they should be when well flowered. These were raised close to the glass in a Melon house. The earliest would be introduced to heat when the flower buds were sufficiently developed, and so brought along in batches. By so doing the flowering season would be greatly prolonged. There are few or no curiosities grown there, the houses being devoted to plants of sterling merit, many of the most useful species being in quantity. There are many other species of *Dendro-*, such as *D. densiflorum*, *D. thyriflorum*, *D. Ainsworthii*, and *D. aureum*.

Nearly all the *Lælias* and *Cattleyas* are included. *Lælia albida* and *L. autumnalis* are largely grown. They are plants that deserve a place in any collection. The former is far from being the largest species of the genus, but when a really good variety is seen it is indeed very pretty. There are many varieties at Malvern—some small and almost pure white, others varying from

white to light rose, and one variety I noticed in flower which is the best I have yet seen. The flowers individually were nearly 3 inches in diameter, with a deep rose labellum. *L. purpurata* is represented by a number of plants of fine varieties. One house is devoted almost entirely to *Cattleyas*, comprising nearly all the leading species, the plants evidently enjoying the treatment they receive, all being in vigorous condition and making first-rate growth. Unfortunately at this dull season there were few in flower, but several plants of *C. Mossiæ* and *C. Trianae* were showing. In this house a few other Orchids are grown, including a grand piece of *Cœlogyne cristata* (the long-bulbed variety), over 3 feet in diameter, and when in flower it must be well worth seeing. *C. pandurata* was in flower. It is certainly a very curious Orchid, and may by many be considered more strange than ornamental. The sepals and petals are greenish white, the lip being rather peculiar in shape, deeply crested, and marked very prominently with black. *Epidendrum prismatocarpum* is well grown, and Mr. Jacques speaks very highly of the plant. The specimen in question was a large one, nearly 2 feet across, and in admirable condition. I observed some good plants of *Vandas*—viz., *V. tricolor* and *V. suavis*. A large plant of *V. gigantea* was flowering well. Although the latter is pretty when in flower, it is by no means a favourite Orchid in collections. *Phalænopses* are well grown, there being some healthy plants of nearly all the best kinds. *P. amabilis* and *P. grandiflora* are well known and appreciated as elsewhere. *P. Schilleriana* and *P. Schilleriana Stuartiana* are doing well; *P. Lowii*, *P. violacea*, and *P. intermedia Portei* are also included, the latter being highly valued for its free-flowering qualities. *Maxillaria Lehmannii* is a grand Orchid, suggestive of *Cymbidium eburneum* both in shape and colour, but in addition to the yellow on the lip *M. Lehmannii* has a dark streak along the outer edge.

The *Odontoglossums* are numerous, and all in magnificent condition, bearing testimony of the good treatment they receive. Of *O. Alexandræ* there are many grand plants and splendid varieties. Several plants were in flower, and many others with the spikes far advanced, most of which were showing double racemes. One plant with two fully expanded racemes with eleven and thirteen flowers respectively was most beautiful. For symmetry and size of flowers I have never seen a variety to surpass this; the petals were beautifully crisped, and the whole flowers very heavily blotched. A plant of *O. citrosimum* must be a sight worth seeing when in flower; it measured nearly 2 feet across. This plant has made pseudo-bulbs of enormous size, and is in the best possible condition. *O. Pescatorei* was carrying a good branched spike of flowers, with several others showing flower. One plant, *O. Rossii major*, in flower was indeed well named, producing flowers of immense size and well marked, whilst *O. vexillarium* and *O. Roezlii* were in the best possible condition, with other species of *Odontoglossums* and cool *Oncidiums*.

Masdevallias are well grown at Malvern, and flower as freely as could possibly be desired. The plants are not so diminutive as we are accustomed to seeing in some collections, but plants worthy the name. One plant of *M. Harryana* is nearly 2 feet through, and when in flower must be grand. *M. ignea* and *M. Lindenii* are also represented by large masses of good varieties; *M. chimæra*, *M. polysticta*, and *M. tovarensis* contribute largely to the display. The latter is remarkably well grown, and proves to be a most serviceable and useful plant. There was a good large batch of it in flower, the majority of the plants in 48-size pots. The greater part of the scapes were double-flowered, some single, whilst three flowers on a scape were frequently to be seen, and one scape had four flowers. One of the largest plants had sixty expanded flowers. Although the genus *Masdevallia* is a rather large one, and many of the species are showy, useful, and well adapted for exhibition, yet I consider *M. tovarensis* the best and most useful.

Calanthes are well represented in this collection, and *C. Veitchii* especially so, having made bulbs and flower spikes of great size. One variety was particularly fine, being several shades darker than the others, and which Mr. Jacques intends propagating as much as possible. This is a striking illustration of how seedling Orchids vary in colour.

Disa grandiflora puzzles many good cultivators. It appears to be rather an eccentric Orchid, only does well in some establishments, and then only in certain positions. For instance, if a batch of *D. grandiflora* is doing well in a certain position, then by all means let them remain, for if they are removed to another house, or even to another position in the same house, the chances are against their well-doing. Several soils or composts have been recommended for *Disas*, but they succeed best in a compost of peat, sand, and sphagnum. At Malvern *Disas* are perfectly at home. The position they occupy is on a shelf at the end of a

house devoted to greenhouse plants, where on all favourable occasions they receive abundance of air; water is also given freely, particularly in the growing season. I was informed that last year a good proportion of loam was mixed in the potting material, but on examining the plants it was found that not a single root had taken to it, so in consequence it will not again be used. The soil to be used in future is the compost named above. I must say a word or two in favour of a very fine variety of *Angræcum sesquipedale*. I have only on one occasion seen a variety to surpass this in size, and that one was at Messrs. Veitch's. I believe the flower of Messrs. Veitch's variety is fully 9 inches across. The one I saw at Malvern was 8½ inches. The plant is only of medium size, but very healthy, not a spot on the leaves. It is scarcely necessary to say that it is highly prized by its owner, who knows the value of and appreciates really good varieties of Orchids.

The above are only a few of the good plants in this collection, but, as I have already stated, the season was anything but favourable to see them at their best; however, if flowers were scarce plants were plentiful, and it is always a source of pleasure to see Orchids in good condition. In conclusion, I may add that not only are Orchids, flowering, and fine-foliaged plants well grown there, but fruit also, including Vines, Pines, Peaches, Melons, &c. There is also one of the prettiest natural ferneries here that I have seen, most of the Ferns being planted out, including a fine collection of *Filices*. My visit to Davenham Bank will long be remembered, and I have to record my appreciation of Mr. Jacques' kindness on that occasion.—GEORGE WALTERS.



AT the Annual General Meeting of the ROYAL HORTICULTURAL SOCIETY held on February 13th, Lord Aberdare in the chair, the following candidates were unanimously elected Fellows—viz., George Alldred, Robert George Arbutnot, Capt. Robert A. H. Barry, Rt. Hon. Joseph Chamberlain, M.P., Prof. Michael Foster, F.R.S., Mrs. Goddard, John Harman, William Hatch, Miss Margaret Hesse, Mrs. P'Anson, H. Jones, Major A. F. Tandy, H. A. Mangles, Barnard Mitchell, Mrs. Morrison, C. S. Mortimer, Sir P. Cunliffe Owen, K.C.M.G., C.B., C.I.E.; H. J. Robinson Pease, J. G. Rollins, J. S. Smith, Hon. Howard Spensley, Wm. Stevens, Arthur W. Sutton, G. D. Taviner, James Thomson, E. Tredgett, and James Wyatt.

— THE INTERNATIONAL POTATO EXHIBITION will be held in the Crystal Palace, Sydenham, on the 13th and 14th of September next, under the presidency of the Right Hon. the Lord Mayor. The schedule is nearly the same as last year, and the few differences observable are really expansions. In the great class for twenty-four varieties there are six prizes offered. In the classes for eighteen, twelve, nine, and six there are five prizes. The Royal Horticultural Society will generously assist by affording facilities for growing and judging seedlings entered for Classes S, T, U, V, as last year.

— IN reply to the inquiry about CHRYSANTHEMUM FAIR MAID OF GUERNSEY, noticed on page 114, Mr. Brotherston states:—"The tops of a few plants were cut off at the beginning of the year, and the plants kept in a temperature of about 50°. They broke up the stems, and are producing a good crop of flowers. With healthy plants to begin with, good feeding, and a genial temperature, I have no doubt that good blooms could be obtained far into spring by the above means."

— MR. C. F. BAUSE, recently Manager of the General Horticultural Company's Melbourne Nursery at Anerley, and previously propagator at Messrs. J. Veitch & Sons, Chelsea, and in the Royal Horticultural Society's Gardens, Chiswick, is now established in business at the Morland Nursery, Portland Road, South Norwood. He has three useful span-roofed houses, each 85 feet long, already

well stocked with Palms, Ferns, Crotons, *Spiræa palmata*, Roses, and miscellaneous plants all in the most luxuriant health, and there is sufficient space to permit a considerable extension of the glass. Mr. Bause's skill as a propagator is well known, and the great success which attended his efforts to improve *Coleuses* and *Dracenas* gives promise of similar improvement resulting in other genera of plants to which he may devote his attention.

— WE are informed that the second Exhibition of the SUTTON ROSE SOCIETY will be held in the Sutton Public Hall on Friday, the 6th of July next.

— MR. THOMAS WEAVER, The Gardens, Christleton Hall, near Chester, writes:—"For comparison with Mr. Leslie's register of RAINFALL FOR 1882 I send the enclosed, deeming it worthy of insertion in your valuable Journal, which has given me much pleasure in reading for over fifteen years. The greatest quantity of rain which fell in this district during the twenty-four hours was on Sunday, April 30th, when it registered 0.85 inch. January, 2.08 inches; February, 1.56 inch; March, 1.70 inch; April, 3.36 inches; May, 1.86 inch; June, 4.57 inches; July, 3.56 inches; August, 2.89 inches; September, 1.75 inch; October, 2.98 inches; November, 3.95 inches; December, 4.03 inches. Total for the year, 34.29 inches."

— D. A. MILWARD, Esq., Lavistown, Kilkenny, writes:—"I enclose a copy of our RAINFALL HERE FOR 1882. This place is two miles and a quarter from Kilkenny, close to the river Nore. This being a mild and dry locality our rainfall is usually light. January and February in this year have been very wet. January, 1.68 inch; February, 2.34; March, 1.82; April, 3.55; May, 2.01; June, 3.09; July, 4.92; August, 3.05; September, 2.21; October, 3.25; November, 3.18; December, 2.58. Total, 33.68 inches."

— A YOUNG gardener, "G. H.," sends us the following letter, which is creditable to him:—"I read with great pleasure the article in your issue of February 1st by 'Excelsior,' 'THOUGHTS ON GARDENING AND GARDENERS,' especially that part relating to young gardeners living in bothies spending their spare hours in study. I firmly believe one-half of our young gardeners are morally ruined by pernicious habits indulged in in the bothy, such as card-playing and excessive drinking. I would suggest as a remedy for this, for gentlemen who have a bothy attached to their gardens, the formation of a small library to be attached thereto. This would be a great boon to the men, and I feel sure their outlay would be fully repaid by the improvement that would follow in their young men. I have lived in bothies in good places throughout England, but never yet met with one to which a library was attached. I have found in many instances the small wages received by young gardeners entirely preclude the possibility of supplying themselves with books." Another correspondent desires to thank "Excelsior" for his communication.

— GARDENING APPOINTMENTS.—Mr. D. Melville, late head gardener for J. Hornsby, Esq., J.P., Honington Hall, Grantham, has succeeded Mr. H. A. Mann at Mrs. Hornsby's, St. Vincent's New Somerby, Grantham; and Mr. G. Abbey, late of Grinkle Park, has been appointed gardener to Lord Esmé Gordon, Paxton Park, St. Neots.

— A CORRESPONDENT writes:—"I wish to make a suggestion with regard to MR. ADNITT'S PEA PROTECTORS, a description of which appeared some time ago in the Journal, and again in the "Gardeners' Year Book" for 1883. It is, that instead of two boards joined together at the ends with thin iron and covered with moveable pieces of glass, I think that (owing to the drawn state of the Peas when these protectors are kept on sufficiently to protect them from birds) it would be better to have three boards instead of two, with wire netting to cover one space

between, and glass the other. The glass side of the protector could then be lifted off when desirable, and the netting put on; and if some strong wire supports about 6 inches in length were inserted in the bottom of the boards (about three in each side of each protector), they could then be lightly placed over the rows when the Peas are up, and so give them additional head space, and also air at the bottom, but not leaving sufficient room to admit birds. It would often be much better to remove the protector a few inches than all the pieces of glass, and much quicker too."

— "AN ORCHIDOPHILE" writes respecting *CATTLEYA PERCIVILIANA* as follows:—"I am greatly disappointed with this Orchid, as from the descriptions that have been published and quoted in the sale catalogues led me to expect quite a different plant. The only recommendation that it seems to have is its late-flowering character, and some think that this will not prove constant. It is true that at present only comparatively small pieces have flowered, and when some that are fully established produce blooms they will be both larger and of better colour. The centre of the lip is very rich crimson, and the sepals and petals pale purple, and though it has been described as of the *C. labiata* type it is more like *C. Morsiale*. There are so many really beautiful Orchids now that we do not want our houses to be crowded with forms that show no improvement on those we had previously grown."

— FROM Professor J. L. Budd's record of the success attained in FRUIT CULTURE IN RUSSIA it appears, says an American contemporary, that "the whole of the large province of Vladimir, which is east of Moscow, is given to the growing of Cherries. Hundreds of proprietors in this province have each orchards of ten thousand 'bushes.' These fruit trees are not allowed to grow in tree form; the oldest branches are pruned out, it having been found that the best fruit is formed on young shoots, several of which are left to grow from one root. South of Vladimir, near the 56th parallel, where the thermometer sometimes falls to 50° below zero, immense quantities of Plums are raised, many of the varieties being equal to the best German Prunes. Pears and Apples are also a success. The Apple trees, too, are made to grow low and bushy, but they bear abundant crops of excellent highly coloured fruit. The main points ascertained in this method seem to be selection of the hardiest varieties of seedlings, close planting to secure mutual protection, low pruning, the growing of more than one shoot from a root, and retaining only the young vigorous wood."

— RELATIVE to CARBOLIC ACID as an insecticide "C. P. P." writes:—"F. P. D." (page 113) somewhat mistakes my observations about carbolic acid. I merely wished to say that it was decidedly soluble, but that the per-centage of carbolic acid dissolved by soft water varied according to the strength of the acid, many of the samples of commercial carbolic acid used for disinfecting purposes being very impure, and containing a great per-centage of coal tar. There is no need to use glycerine to make a stronger solution, as a saturated solution prepared in the way I described is far stronger than any plant can stand; in fact, only last Friday I put some of the carbolic acid solution into a can of warm water from the boiler, about one part to eight, and used it without doing any harm where only applied lightly, but a plant of *Pelargonium echinatum*, which had some green fly on it, with young foliage, suffered very much because I used the syringe, a jet d'eau, which I use for this purpose, too forcibly, and I found the leaves had shrivelled the next day. I merely write this to warn those who use carbolic acid that it is better to err on the side of using too little and repeating the dose if necessary, rather than to apply it too strong. I should be afraid that, as glycerine is naturally of a glutinous nature, it would fill up the pores

of young foliage too much, which is the objection I have to petroleum."

— THE statistics of the WINE HARVEST of last year, recently published by the French Ministry of Agriculture, show that it was one of the worst ever known in France; and compared with the ten years immediately preceding last year, when the production had been greatly reduced by the phylloxera and bad seasons, there is a falling-off of last year's harvest of a full third. The result to the wine-growers, and indeed to all dependant upon the culture of the Vine, has been very serious, for the area under the Vine in France amounts to 5¼ million acres. The long depression [under which this great industry has suffered has thus seriously diminished the wealth of France, and accounts for the feeling of dissatisfaction that prevails in the country; at the same time there is one favourable feature in the statistics. The Ministry of Agriculture is able to show that last year the acreage under Vines in the departments where the phylloxera prevails increased, suggesting that at last the disease has received a check, and that the wine-growers are recovering courage. The chief cause of the badness of last year's wine harvest was the weather.

ROYAL HORTICULTURAL SOCIETY.

FEBRUARY 13TH.

THE meeting on Tuesday last was well attended both by exhibitors and members of the Committee, the Council-room being filled with a choice array of Primulas, Cyclamens, Rhododendrons, Amaryllises, Cinerarias, and Orchids.

FRUIT COMMITTEE.—John Lee, Esq., in the chair. The following were present:—Messrs. P. Crowley, F. Rutland, G. Lyon, J. Willard, W. Denning, J. E. Lane, G. Bunyard, C. Silverlock, A. W. Sutton, R. D. Blackmore, G. Goldsmith, H. J. Veitch, Thomas Laxton, Sir Charles W. Strickland. Mr. W. Horley, Toddington, Dunstable, sent two seedling Apples. No. 1 was passed, but No. 2, a small yellowish fruit, slightly red on one side, was considered a very useful Apple, a good keeper, and desirable for cooking. Mr. Mann, The Gardens, Denton Hall, Grantham, was awarded a second-class certificate for an Apple named Grantonian, a solid fruit about 3 inches deep, somewhat conical, and greenish-yellow. Mr. Ford, The Gardens, Leonardslee, Horsham, was accorded a vote of thanks for good fruits of Josephine de Malines Pears, which he stated were now in use from trees on an east wall. He also sent fruits of Seckle Pear in fair condition. Mr. Chester, The Gardens, Connington Castle, sent two seedling Apples, which were passed.

Messrs. T. Rivers & Son, Sawbridgeworth, exhibited a collection of home-grown Oranges, Lemons, with about one hundred dishes of Apples and a few Pears, for which a bronze medal was awarded. The Oranges comprised the Silver, White, Maltese, Botelha, St. Michael's, and Tangierine, all fine fruits of good flavour. Amongst the Apples the most notable were Blenheim Pippin, Tower of Glamis, Norfolk Bearer, Golden Ball, Manks Codlin, Melon Apple, Mère de Ménage, Cox's Orange Pippin, Gloria Mundi, Royal Russet, and Northern Greening. The Pears were Marie Benoist, Olivier de Serres, Duchesse de Bordeaux, Beurré de Jonghe, and Glou Morceau.

FLORAL COMMITTEE.—G. F. Wilson, Esq., in the chair. The following were also present:—Rev. G. Henslow, Messrs. H. Bennett, J. McIntosh, J. Laing, W. Bealby, J. Fraser, H. Ballantyne, G. Duffield, J. Dominy, H. Ebbage, J. Wills, J. James, Shirley Hibberd, Henry Cannell, and Harry Turner. A group of Hybrid Rhododendrons and Amaryllises from Messrs. J. Veitch & Sons, Chelsea, was a prominent feature in the Council-room, and deservedly attracted much admiration. The Rhododendrons comprised a number of beautiful seedlings, with scarlet, orange, buff, pink, and white flowers of great size, and borne in large trusses. Several were named and certificated. The Amaryllises also comprised a number of handsome new varieties, the flowers generally being of great size, the petals broad, and rich crimson or glowing scarlet in colour. Some of the plants had two scapes each, and others had four or five flowers in a scape. In addition to the varieties certificated and described below, the following were very noteworthy:—Pallas, dark crimson tipped with white, very large; Argus, neat, bright scarlet; Hera, very dark crimson-scarlet, one of the darkest; and Leander, rich scarlet. A fine group of Cyclamens was also contributed by the same firm, the plants being remarkably vigorous and the flowers abundant, white, purple, and crimson. A silver medal was awarded to Messrs. Veitch for their exhibits.

Messrs. H. Cannell & Sons, Swanley, contributed largely to the attractions of the display, several groups of Cinerarias, Primulas, and other plants being staged. The Cinerarias comprised two magnificent varieties—viz., Victory, a surprisingly handsome crimson form, which was certificated, and is described below. The other was

March Past, which has been previously certificated. The flowers of this are of wonderful size and substance, rich velvety crimson in colour, the florets broad, and white at the base, forming a narrow ring. It is very strong in habit, and the plants shown were in first-rate condition. Small plants of *Cineraria cruenta* were shown with the above for comparison, and a number of single blooms of variously coloured forms were noteworthy. The Primulas were extremely good examples of culture, *alba plena fimbriata* being most profusely flowered in 5-inch pots. Some of these bore a dozen to twenty large trusses of large double pure white flowers. Of the rose-coloured varieties *atro-rosea plena* and *Earl Beaconsfield* were the most noteworthy. Flowers were also sent of several other double Primulas, *Marchioness of Exeter* and *Emperor* being the best. A silver medal was deservedly awarded to Messrs. Cannell for the above-mentioned groups.

Mr. B. S. Williams, Upper Holloway, staged an extensive and handsome group of Primulas and Cyclamens, both in admirable condition; but the Cyclamens were very handsome, dwarf, free, and with large flowers, the dark varieties very richly coloured. White, purple, and red Primulas were the principal varieties, the flowers of good size and the plants dwarf. A plant of *Cattleya labiata Percivilliana* was also shown. A silver medal was awarded for the Cyclamens and Primulas. A vote of thanks was awarded to Mr. George, Putney Heath, for blooms of fine seedling Abutilons, comprising *Lustrous*, *scarlet*; *Emperor*, deep purple-crimson; *Premier*, rose; *Le Grandé*, deep orange; *King of Roses*, bright rose; and *The Bride*, blush. A cultural commendation was accorded to Mr. Lyon, gardener to Sir E. H. Scott, Bart., Sundridge Park, Bromley, Kent, for baskets of Hyacinths, Lilacs, Tulips, and Jonquils, the Tulips and Hyacinths being exceedingly fine. G. F. Wilson, Esq., Weybridge, sent a plant of *Odontoglossum Alexandræ*, which had a spike of twelve flowers from one pseudo-bulb. The flowers were of good size; the petals broad and of beautiful form, and tinted with mauve. A vote of thanks was accorded to Mr. James, Woodside, Farnham Royal, Slough, for some very handsome Cyclamen blooms, white, purple, and deep crimson. Mr. Todman, gardener to J. Connell, Esq., Bushydown, Tooting Common, sent several of his hybrid Azaleas—*Duke of Albany*, dark red; *Miss Nellie Connell*, rose; and *Mrs. John Connell*, pure white.

A vote of thanks was accorded to Messrs. J. Carter & Co., High Holborn, for a handsome group of Primulas, comprising *White Queen*, a very large-flowered variety; *Magenta Queen*, *Holborn Gem*, *Holborn Carmine*, *Holborn White*, *Vermilion Queen*, and *Mauve Queen*, together with the *Golden-leaved* variety and a large basket of *Scilla siberica*. A vote of thanks was accorded to Mr. Heims, gardener to F. A. Philbrick, Esq., Oldfield, Bickley, for a fine variety of *Cattleya Trianae* and a dark-spotted *Odontoglossum Alexandræ*. Messrs. J. Peed & Sons, Roupell Park, sent a plant of *Dendrobium Wardianum grandiflorum* with flowers $4\frac{1}{2}$ inches in diameter, the lip deep yellow and blotched with maroon. W. Vanner, Esq., Camden Wood, Chislehurst, showed a plant of *Dendrobium heterocarpum album*, the flowers white, except the yellowish base of the lip. A cultural commendation and vote of thanks were accorded to P. Crowley, Esq., Waddon House, Croydon, for a very handsome specimen of *Cælogyne cristata*, about 3 feet in diameter, and bearing some scores of flowers. A cultural commendation was accorded to Messrs. Hugh Low & Co., Clapton, for a panful of *Angræcum citratum*, with about thirty spikes of its buff white flowers. Mr. R. Dean, Ealing, sent plants and flowers of *Primroses* and *Myosotis dissitiflora alba*, and several other plants. From the Society's Garden at Chiswick was contributed a large and beautiful group of well-grown double Primulas, representing all the best of the varieties in commerce. Plants of *Chiswick Red Primulas* were also staged in good condition, and a group of Lilacs in pots, with a dozen plants of *Saxifraga ligulata* flowering well.

First-class certificates were awarded for the following plants:—

Calanthe Regnieri (Veitch).—A species from Cochin-China, resembling *C. vestita* in style of flower and form of pseudo-bulbs, and bearing a long spike, the flowers being confined near to the apex. The lip is three-lobed, the centre lobe being deeply cut, pink, with a dash of crimson in the centre; the sepals and petals are elliptical, white, reflexed, the petals having a central faint rosy vein. With this was also shown a similar species—*C. Stevensiana*, also from Cochin-China, the flowers being all white except a blotch of crimson in the centre of the lip.

Amaryllis Acis (Veitch).—A fine variety with large beautifully formed flowers; the petals broad, rounded, deep scarlet tipped with white. The symmetrical form of the flower is very noteworthy in this variety.

Amaryllis Achilles (Veitch).—Remarkable for the great size of the flowers, which are $8\frac{1}{2}$ inches in diameter, the petals broad and dark scarlet. The scape is of moderate height but very strong, and the plant shown had two scapes.

Rhododendron Princess Christian (Veitch).—Flowers of beautiful form, rounded lobes, very pale pink—a most delicate tint, and very distinct. The plant had a dozen flowers on one truss. This and the following were of the greenhouse hybrid type.

Rhododendron Baroness Schröder (Veitch).—Very handsome; flower deep yellow, with red stamens. Free, and of good habit. Eight to ten flowers in a truss.

Odontoglossum Scottii (Wilson).—A grand variety, with flowers of

great size, $3\frac{1}{2}$ inches in diameter, the petals irregularly cut, three-quarters of an inch broad, the lip slightly fringed. The ground colour is pale yellow, with large bold blotches of chocolate. The spike had seven flowers. It is one of the finest of this type, being suggestive of *O. prionopetalum*.

Cineraria Victory (Cannell).—A very fine variety, with exceedingly large flowers $2\frac{1}{2}$ inches in diameter, of good form, rounded, broad florets, and of a rich warm purplish-crimson colour. Most pleasing and distinct.

Odontoglossum crispum aureum magnificum.—This distinct variety was shown by C. Dorman, Esq., Laurie Park Sydenham. It has flowers with undulated margins to the petals, which are pale yellow spotted with chocolate. The plant bore three spikes, each with a dozen flowers.

Phalænopsis leucorrhoda alba (Low).—A variety with pure white flowers of moderate size, the lip spotted at the base with crimson.

SCIENTIFIC COMMITTEE.—Sir J. D. Hooker in the chair.

Melon from under Electric Light.—It appears that the specimen sent to the last meeting was done so inadvertently, as no scientific data had been taken. Dr. Siemens, however, informed the Society that he hopes to test the growth of Melons on a future occasion.

Self-Registering Thermometers.—Mr. Glaisher remarked on the necessity of observers stating whether minimum temperatures are taken by thermometers on the soil or at an elevation above it, and also whether they have been properly compared with a standard. With reference to the Hon. and Rev. J. T. Boscawen's observations, he remarked that his thermometer registered 10° less than that of Truro. This is probably due to the fact that the position is in a valley. He believes that the *Lapageria* mentioned at the last meeting was subjected to only 5° of frost, but that the *Camellias* endured from 16° to 18° of frost, which slightly injured them.

Graft of Helianthus tuberosus on H. annuus.—Dr. Masters exhibited a specimen from Mr. Laxton on which the attempt had been made, but the graft showed only a slight adhesion, but had perished afterwards.

Hypertrophy of Nut and Cabbage.—The Secretary, Rev. J. Henslow, exhibited a sucker from a Nut bush with a mass of buds arising from one spot, and Cabbage leaves with innumerable small foliaceous excrescences from the midrib.

Orobanche (sp.) on Beans.—A specimen was sent from Marsala, Sicily, where it appears to be very destructive.

CARYOTA EXCELSA.

IN a decorative point of view Caryotas are exceedingly ornamental, especially if sufficient space can be afforded them to develop their beauties, and this is not so very difficult; for although some of the kinds become trees with stately stems 50 or 60 feet in height, there are others that never exceed 18 or 20 feet. In a young state Caryotas are admirably adapted for the decoration of the dinner table, and also form beautiful objects distributed throughout the various apartments during the summer months, but during the winter it is not well to keep them in rooms unless these are slightly heated. When larger they may be plunged in the open air in summer, to assist in giving the pleasure ground a tropical appearance.

The species represented in fig. 42 is one of the best of the genus for decorative purposes, and will amply repay any labour which may be bestowed upon it. Whether grown in the drawing room, or in the stove, or used in the open air; in all of these situations it will produce a fine tropical effect, which is always so highly appreciated by lovers of the beautiful in Nature who live in temperate climes.

As a compost for Caryotas use good rich loam and leaf soil in about equal parts, with the addition of a little sharp river sand. The pots should be well drained, and during the summer a liberal supply of water should be given. If the plants are kept in the stove during the winter, still continue to supply them freely with water, but this must be given more carefully if the plants are kept in a low temperature. As a rule Caryotas are not easily propagated except by seeds, but they occasionally produce suckers from the base, which should be removed as soon as large enough, potted in some sandy loam, in as small-sized pots as possible, and plunged in a gentle bottom heat until well established.

WALLFLOWERS AND STOCKS.—We used to grow those grand old double Wallflowers, crimson, brown, and golden yellow, which appear to have almost disappeared from cultivation now, and we have had the fine German importation of Wallflowers; but, good as they are, they do not stand so high in my estimation as the grand old type of the past. There was another grand old race of plants in the Brompton Stock, but I fancy we have not such a strain now. For many years I have been unable to secure such Stocks as we used to have. We pay the same price, but the produce has often proved, to me at least, a grievous disappointment, scarcely having a double flower from packets of the three varieties, and have been obliged to give up their

culture. At the time I am writing of there were no East Lothian or Giant Ten-week Stocks; but, fine as they are, they cannot be compared with the Brompton Stocks of fifty years ago.—E. L.

HORTICULTURAL BUILDINGS.

“R. P. B.” and Mr. Warhurst have both nibbled at a subject on which information is undoubtedly wanted both by gardeners and their employers. When we are told that a gardener fails to grow *Eucharis* or *Dendrobiums* in an old house, and that in a new house he succeeds, we are prone to ask, What was it that was wrong with the old structure? The fact is, too much has been

made of the construction of houses, the exact pitch of the roof, the height, width, &c., and far too little of internal arrangements. Far too much has been made of the peculiarities of this house and of that, instead of studying other conditions altogether. The truth is that when a change of house secures success when only failure was gained before, there is little credit to the man, for it shows that his success or failure depends altogether on accidental circumstances. Far be it from me to underrate the importance of having properly constructed houses, or ignoring the fact that some houses are quite unfit for the purpose for which they were erected, and far be it from me to blame when it is not due; but frequently a new man will do as well as a new house, and when failure comes it is a poor apology to say “it is the house,” or



Fig. 42.—*CARYOTA EXCELSA*.

grudge a successful man his due meed of praise by attributing his success to “the house.” Last spring a gardener was shown some thriving Orchids. “It is the house,” was the remark. He himself had the same species, and when asked, “What is wrong with this and the other thing, they are doing badly with you?” the same reason was again given—“Oh! it’s the house; it does not suit.” Rather a cheap excuse!

Not far from here is a collection of Orchids second to none anywhere in the country for health. I remember saying so to Mr. Thomson of Drumlanrig. “Ah, yes,” he replied, “Mr. F is, I believe, the best Orchid-grower in Britain.” Another who saw them was less generous and less just, for he said, “It must be the house.” A few years ago these same Orchids were in anything but good condition, but the gardener accounted for his non-success by saying “It’s the house.”

“R. P. B.” tells us of an Orchid-grower who is eminently successful in growing many kinds, but cannot grow *Dendrobium nobile*. The “house” fits those which thrive, it seems, but not those which fail. Suppose a change of gardeners, and suppose the new one grew *D. nobile* to perfection and failed with some of those which are now so luxuriant. “R. P. B.” would say it was “the house,” but the truth would be it would be the man.

In my experience I have at one time been able to grow a certain plant well, and then fail with it altogether, and then succeed again in the same house. Some years ago, in the situation which I have just been compelled to resign, a span-roof house 30 feet long, 14 feet broad, and 11 feet high was erected chiefly for growing Melons and a few ordinary stove plants. The pipes were arranged in the ordinary way, top and bottom heat being secured. Some one gave me a very small growth of *Dendrobium nobile*. This

increased at an astonishing rate, and in time produced more plants, which also flourished. These were grown on the north side and under the flickering shade of the Melons. It was determined to fill the house with Orchids, so well pleased was my employer with these and a few others. The side walls which formed the paths were pulled down, the pipes re-arranged near the floor level, and the side stages made to take the place of the pits. These stages were of gratings, supported by handsome iron pillars. The stage facing north was covered with zinc turned up so that it served to hold water. Round the east end and along the south side it was covered with roofing slates. The east end was the boiler end, and, owing to some extra piping passing to a small Melon pit outside, was hottest. The door was at the other end, the path down the centre. The zinc was a plan of our own, and has turned out an important factor in securing a great variety of conditions in a small house.

New plants were obtained, but being small one side was sufficient, and all the Orchids were arranged on the north side on raised pots, boards, &c., and the zinc covered with water. Most grew well and have continued so; but our hitherto flourishing *Dendrobium nobile* in the same house, in the same spot, and apparently under circumstances differing but slightly, instead of more than doubling themselves yearly now began to go back. Had we folded our arms and said it was "the house" the success that ultimately came would not have been obtained. While the house was a Melon house the plants were over a grating, and the dry warm air from the bottom-heat pipes passed round the plants constantly. To counteract the drying influence of this, moss was placed between them and damped two or three times a day, but it dried quickly. Syringing to keep down spider was done, but the plants also dried quickly. Under these conditions they were densely clothed with fine foliage. After the internal alterations this became affected by spot; even the newly formed foliage became affected—in short, before long it was all decaying, and the health of the plants failing rapidly. Next spring, after studying the matter thoroughly, the plants were taken from the west end (over the zinc) and placed at the other end (over the slates)—that is, from being comparatively cool and moist they were changed to warm and dry, the warm air passing through the joinings of the slates. At once they began to regain their health, and are now thriving.

With *Cœlogyne cristata* our experience is just the reverse. Alongside the *Dendrobium* under the Melons it never throve. In the cool moist corner where the *Dendrobium* failed it is now flourishing. It would take too long to tell my experience with a tenth of the plants in that one house, but a few instances may be cited. *Dendrobium Wardianum* in a basket near the roof dwindled and damped on the south side near the west end; in exactly the same position 18 feet further east it grows grandly. At the extreme west end of the zinc side *Cypripedium insigne* shows signs of spot, but only 6 feet further away it luxuriates, while at the further end it grows stunted. *C. Boxallii* is subject to spot alongside of *C. insigne*, but thrives in the middle of the house. In the coolest place *Odontoglossum grande* is grand indeed; a few yards away it will not grow half as well. And so on.

This is like an intuition to some men, but it will always be found to be an intuition born of study. To succeed now, and then to fail with one plant, shows that the grower has not mastered the subject. He wants to know something more of the climatical conditions under which it thrives, and so far as possible to create similar conditions; and with this an angle of 40° or of 50° in the pitch of the roof has far less to do with the matter than has light and shade, humidity and ventilation, which we can vary at will even in one house. One portion of even a moderate house may be much drier, lighter, warmer than another portion, and one set of plants will flourish in the one portion that would not in the other.—SINGLE-HANDED.

(To be continued.)

A CHRYSANTHEMUM ELECTION.

TOO-MUCH-ALIKE VARIETIES.

WHEN we requested the electors to bracket together any varieties they considered too nearly alike to be exhibited in the same stand, we were not altogether prepared for such results as are shown in the accompanying table. It must be observed that though in many cases the varieties named together are certainly synonymous, in the majority they are distinct, but not sufficiently so to render it advisable that they should be shown together in one stand. For instance, in the form returned by Mr. N. Davis of Camberwell these are distinguished as follows:—"Baron Beust and Orange Perfection too much alike in a stand of twelve, distinct in twenty-four, the same remark applying to Baron

Beust and Rev. J. Dix, Mabel Ward and Angelina. White Venus and Isabella Bott are too much alike for either a stand of twelve or one of twenty-four, and with these are associated Mr. Howe and John Salter, Golden Queen and Emily Dale, Mr. Bunn and Golden Beverley, Venus and Countess of Dudley." This will indicate the general object—namely, to distinguish the varieties that resemble each other too closely, and to furnish the exhibitor with a clue as to what would weaken his stand in the opinion of a judge.

The numbers opposite each variety in the right-hand column indicate how many electors bracketed those varieties together.

Mr. Bunn and Golden Beverley	22
Miss Mary Morgan and Pink Perfection..	21
John Salter and Mr. Howe	21
Empress of India and Lady St. Clair ..	13
Empress of India and Mrs. Cunningham..	13
Golden Queen and Emily Dale	13
St. Patrick and Beethoven	12
Refulgence and Inner Temple	11
Mrs. G. Rundle and Mrs. Parnell	8
Mrs. Dixon and Golden George Glenny ..	5
Barbara and Baraba	4
Prince of Wales and Lord Derby	3
Empress of India and Snowball	3
Robert James, General Bainbrigg, and Beauty of Stoke	3
Empress of India and White Globe	2
Golden Empress of India and Emily Dale ..	2
Queen of England and Albert Smith	2
Isabella Bott and Formosum album	2
Prince Alfred and Lord Wolseley	2
Mrs. Dixon and Mrs. H. Glover	2
Princess of Wales and Mrs. Heale	2
Jardin des Plantes and W. H. Morgan	2
Inner Temple and Arigena	2
Empress of India, White Queen, and Mrs. Cunningham	2
Baron Beust and Rev. J. Dix	2

One elector each named the following as too much alike:—

Lady Slade and Lady Hardinge; Venus and Hetty Barker; White Eve and Miss Hope; Mrs. G. Rundle and Mount Edgcombe; Empress Eugénie and Pink Perfection; Queen of England and Queen of the Isles; John Salter and Angelina; Princess Beatrice and Lady Slade; Princess of Wales and Princess Alexandra; Cherub and Canary Cherub; Queen of England and Blush Queen; St. Patrick and Golden Eagle; Mr. Brunlees and Mr. Jay; Empress of India, Virgin Queen, and Vesta; Jardin des Plantes and Mr. Bunn; Princess of Wales, Princess of Teck, Le Grande, Mrs. Heales, and Countess Granville; Venus, Lady Slade, Mrs. Sharpe, and Beauty; Barbara, Mr. Brunlees, and Golden Eagle; Pink Venus, Pink Perfection, and Lady Hardinge; Golden Eagle and Reticulatum; Mr. G. Glenny and Emily Dale; Rev. C. Boys and Inner Temple; Yellow Perfection and Mrs. J. Laing; Queen of England and Princess Royal; Mabel Ward and Angelina; Venus and Countess of Dudley; Baron Beust and Orange Perfection; Oliver Cromwell and Mr. Evans; Golden Eagle and Orange Perfection; Prince of Wales and Mr. Corbay; Lord Wolseley, Incognito, and Mabel Ward; Mrs. Dixon and Aureum multiflorum; Mrs. G. Rundle and Mrs. Naish; Beverley and Mottled Beverley; Mrs. Heale and Madame Fold; John Salter and Baron Beust; White Beverley and Blonde Beauty; Mrs. G. Rundle and Duchess of Manchester; Hero of Stoke Newington and Novelty; Isabella Bott and Empress of India; Refulgence and Prince of Wales; White Venus and White Beverley; Mr. G. Glenny and Guernsey Nugget; Mrs. Rundle and Mrs. Shipman; Mr. G. Glenny and Golden Empress of India; Golden Queen of England and Golden Empress of India; Isabella Bott and Lady Hardinge; Novelty and Beauty; Mr. G. Glenny and Mrs. Dixon.

With regard to the first nine varieties in the above list a surprising unanimity of opinion is shown, and, as they are usually seen, most of the varieties so coupled cannot be readily distinguished from each other, and several of the electors state they have received the same variety under both names. In the case of those which have only been mentioned by one or two growers, it is apparent in several instances that they have not the varieties true to name, for some are bracketed together which are absolutely distinct, and a number of others sufficiently so for all practical purposes. It will be seen that Empress of India has the greatest number of near relatives—Lady St. Clair, Mrs. Cunningham, Snowball, White Globe, White Queen, and Isabella Bott. Queen of England comes next with Albert Smith, Queen of the Isles, Blush Queen, and Princess Royal as too much resembling it. Mrs. Rundle is very near Mrs. Parnell, Mount Edgcombe, and Duchess of Manchester. Golden Empress of India is considered too much like Emily Dale and Golden Queen of England. Emily Dale resembles the two preceding varieties and Mr. G. Glenny, and, according to a few electors, should be excluded from one stand.

No less than twenty-nine varieties are named as too much like those which obtained a place in the first twelve (see page 111, last issue), but these include several doubtful cases; for example, Mr. Bunn and Jardin des Plantes were both elected in the first twelve, yet in two lists they were stated to be too much alike for showing together, which is certainly not correct, as they are readily distinguishable. Again, Princess of Wales and Mrs. Heale were returned by two electors as not suitable for one stand, but we think there would be no more difficulty in determining these than in the previous case.

Beyond all doubt great confusion exists in the nomenclature of Chrysanthemums, and not a few cultivators appear to be

unacquainted with the true characters of some of the varieties; if it were not so how could Angelina be considered too much like both John Salter and Mabel Ward? To the former at any rate it has no resemblance. Another extraordinary coupling is Lord Wolseley and Mabel Ward; indeed, it is doubtful if many competent judges would regard any of the last twenty-six varieties in the list as otherwise than distinct enough for purposes of exhibiting.

In a large number of cases the similar or too-much-alike varieties differ considerably in the relative number of votes they obtained, some having secured a high place in the first twelve, while others have only gained a few second-class votes. To aid in selecting the best varieties, those that have been accorded the highest number of first-class votes are placed first in each pair, triplet, &c.

ROYAL HORTICULTURAL SOCIETY.

THE annual general meeting of this Society was held in the Council room, South Kensington, at 3 P.M. on Tuesday the 13th inst., the President, Lord Aberdare, in the chair; and the following members of the Council were present—Sir Trevor Lawrence, Bart., M.P.; Dr. Robert Hogg; G. F. Wilson, Esq.; James McIntosh, Esq.; J. H. Mangles, Esq.; E. G. Loder, Esq.; J. Lee, Esq.; W. Haughton, Esq. (Treasurer); and Major F. Mason (Secretary).

The proceedings were commenced by Major F. Mason reading the announcement calling the meeting and the minutes of the last annual general meeting. Twenty-seven new Fellows were then elected, and Messrs. Noble and Wooster were appointed the scrutineers of the ballot for the election of officers and Council.

The annual report having been distributed to the Fellows was taken as read, and Lord ABERDARE then briefly reviewed the present position and future prospects of the Society. He said that at the meeting last year the Society was to a certain extent under a cloud, and though there had been an improvement in their finances and an increase in the number of Fellows, still the cost of the litigation incurred on behalf of the debenture holders—viz., £911, was a heavy charge upon them. Fortunately, however, certain exceptional additions were made to their income, and enabled them to pay the whole of the legal expenses. For instance, under the head of Miscellaneous Receipts £126 was accredited to the Society in 1881, but in 1882 under the same head this item had increased to £677 19s. 10d., which in the absence of the law difficulties would have left a balance in favour of the Society of nearly £500, though a large portion of this would have had to be expended upon repairs, which had now been undertaken by the Commissioners.

Referring to the present condition of the Society in reference to the South Kensington garden, the Chairman continued that the Commissioners, having obtained possession of the garden, had let a portion of it for the purpose of the International Fisheries Exhibition to be held this season. The Council had consulted with the Committee of that Exhibition to determine their relative positions during the year, and nothing could exceed the courtesy and liberality with which they had been received. The Fellows of the Royal Horticultural Society are to have the privilege of visiting the Exhibition, and of purchasing tickets of admission on the opening day for 5s. The Society are to receive three-fourths of the entire receipts at the gates on the six days of their Shows, but they will lose the receipts for daily admission during the rest of the year, and will at the same time be relieved of the cost of the gatekeepers. The garden will be maintained in condition by the Society, who will retain the offices, conservatory, and space in the grounds for their summer Show rent free. His lordship concluded by expressing an opinion that the prospects of the Society were hopeful, and would probably steadily improve now the chief difficulties had been removed.

Mr. GUEDELLA, in seconding the motion that the report be adopted, said the Fellows were much indebted to the Council for their efforts to obtain a satisfactory settlement of the Society's affairs, but he desired to know if any proceedings had been taken to determine the future position of the Society in reference to the South Kensington garden.

In reply, Lord ABERDARE stated that a Committee had been appointed by the Commissioners and the Council of the Royal Horticultural Society to consider the matter, but at present, owing to the business in connection with the Fisheries Exhibition, they had not been able to meet.

The report was then formally adopted, and as a result of the ballot it was stated that Sir Charles W. Strickland, Bart., Sir P. Cunliffe Owen, and Colonel Beddome were elected to fill the vacancies in the Council caused by the retirement of Colonel R. Trevor Clarke, the Rev. H. Harpur Crewe, and J. T. D. Llewelyn, Esq. A unanimous vote of thanks to the Chairman then brought the proceedings to a close.

ANNUAL REPORT, BALANCE SHEET, AND REVENUE ACCOUNT, 1882.

THE judgment of the Court of Appeal, which was communicated to the Fellows in a special circular, has necessitated arrangements for the present year which have compelled the Council to modify to some extent the privileges of the Fellows. The Council trust that the Fellows will consider the advantages which have been secured for them in respect of the Great International Fisheries Exhibition a fair compensation for the privileges surrendered. They wish to record

their sense of the friendly and liberal spirit in which they were met by the Executive Committee of the Fisheries Exhibition.

The Council hope to be able to arrange for an evening fête, and possibly for other additions to the programme which has been circulated among the Fellows, and which they have endeavoured to make, from a horticultural point of view, worthy of the Society.

The Council are fully aware of the undesirability of changing the privileges of the Fellows, by whom they are elected and of whose interests they are the guardians. They believe that they have in the recent negotiations with the Fisheries Committee surrendered as little of those privileges and obtained in return as much as was practicable.

In the past year the promenade shows fully maintained the place which they had gained in the estimation of the Fellows and the public, who attended them in larger numbers than heretofore. The lectures, for which the Council feel much indebted, proved generally attractive.

The great show was marred by the absence of exhibits which the Council believe would have been shown but for its length (three days). The Council have in consequence determined to limit the great show this year to two days.

The useful work of the Society at Chiswick has been continued with regularity, and the Council hope that it will prove of permanent benefit to horticulture.

The Chiswick Gardens have been maintained in a high state of efficiency. A greater number of Fellows than formerly have visited them, and have appeared to take great interest in the work of the Society.

The Fruit Committee have had under examination very large collections of Peas and Potatoes, and the season proving favourable, the trials were highly satisfactory. Shallots, Lettuces, and Tomatoes were likewise tested, but owing to the cold it will be necessary to try them again during the present year.

Five of the Society's certificates were awarded to new Peas on account of their improved qualities, and three certificates to new varieties of Potatoes.

Facilities were afforded to the Committee of the International Potato Society for growing and comparatively testing all the new varieties of Potatoes submitted to them.

The Floral Committee trials of the past season included Achimenes, Tydæas, other Gesneraceous plants, Begonias, Lantanas, Pelargoniums, Verbenas, Ceanothus, Single and Pompon Dahlias, and many other miscellaneous plants.

The Tea Roses planted two years ago have made satisfactory progress.

The rockery and the collection of alpine and hardy herbaceous plants continue to interest visitors. The applications by Fellows for plants of this description are steadily increasing.

Nine hundred and eighty-eight Fellows were supplied with plants, &c., as follows:—17,725 plants, 42,803 packets of seeds, 25,271 cuttings of Vines, fruit trees, &c.; 85,799 total distribution.

The sales of garden produce, somewhat in excess of previous years, appear in the accounts.

The collection of Raspberries formed last season is very complete and promises well.

A new collection of all the known varieties of Rhubarb has also been formed, which will this season be examined and reported on.

The collection of Figs planted out in the old orchard house as an experiment a few years ago did not prove a success. It is therefore intended to resume their cultivation in pots.

It is proposed to plant in the old orchard house a selection of the newer American Grapes and other varieties likely to succeed without fire heat.

The crops of outdoor fruit, although below the average generally, were interesting and instructive, a small quarter of young Apple trees on the French Paradise stock being laden with fine fruit.

Strawberries were abundant and very fine; the Strawberry fête held in the Garden being a complete success.

The crop of Grapes in the conservatory was up to the average, and that in the other houses unusually good.

The Second Annual Exhibition of the Chiswick, Turnham Green and District Horticultural Society, under the patronage of the Duke of Devonshire, was held in the Gardens under adverse conditions as to weather, but was nevertheless well attended. A request from the same Society that the Gardens might be used for the holding of an evening fête was granted, and a large number of Fellows attended.

AUDITORS' REPORT.

31st January, 1883.

My Lord and Gentlemen,—We have gone very carefully through the whole of the accounts of the Society, and we have compared all vouchers with the books, and we find them correct and very satisfactory.

The books of the affairs at Kensington are kept in a perfect manner, and reflect credit on Mr. Dick.

There are a few slight improvements still to be made in the books at Chiswick, which we have explained to the clerk there, and which will in future be carried out.

We regret to find a falling-off in the Fellows' subscriptions to the amount of about £150 in the past year.

The receipts for produce sold at Chiswick are maintained with a slight increase.

We think the item of old arrears due by Fellows, amounting to £402, should be written off, as it appears as an asset in the balance sheet which does not exist.

But for the large amount paid in the past year for law charges, the revenue of the year would have been equal to pay all expenses and to leave a balance of £500 in hand.

We remain, my Lord and Gentlemen,
Your most obedient Servants,
JOHN LEE,
JAS. F. WEST, } Auditors.

To the Council of the Royal Horticultural Society.

BALANCE SHEET, 31ST DECEMBER, 1882.

DR.		£	s.	d.	£	s.	d.
To Sundry Creditors		787	5	4			
„ London and County Bank		388	13	9			
„ Special Prize Account, unpaid		3	0	0			
					1,178	19	1
„ Legacies received		1,887	8	9			
„ General Revenue Account—Balance carried forward		1,323	10	2			
					£4,389	18	0
CR.		£	s.	d.	£	s.	d.
By Balance of Capital Expenditure Account } 31st December, 1881		7,111	0	2			
Deduct amount of Freake's Debenture, now become a Liability of the Commissioners for the Exhi- bition of 1851	£5,000	0	0	0			
„ Balance of Life Composition Account	410	0	9				
					5,410	0	9
„ Debtors, viz:—					1,700	19	5
Annual Subscriptions outstanding ..	31st Dec., 1881	402	3	0	214	4	0
Garden Produce		40	19	3	39	4	11
Sundries		30	8	8			
Packing charges					7	11	6
					£261	0	5
„ Great International Fisheries Exhibition					32	18	1
					473	7	11
„ Investments—3 per cent. Consols					293	18	6
„ Petty Cash in hand					767	6	5
					1,892	11	3
					29	0	11
					£4,389	18	0

We have examined the above Accounts with the Books and Vouchers, and we find the same correct—
31st January, 1883. JOHN LEE, } Auditors.
JAS. F. WEST, }

ANNUAL REVENUE ACCOUNT FOR THE YEAR ENDING 31ST DECEMBER, 1882.

EXPENDITURE.		Cash paid.		Debts payable.		Totals.	
		£	s.	d.	£	s.	d.
<i>To Establishment Expenses:—</i>							
Salaries		259	2	8	259	2	8
Wages		161	18	10	161	18	10
Printing, Stationery } and Cards		104	0	5	48	13	10
Postage		63	5	3	15	9	6
Gas		19	19	5	9	10	6
Miscellaneous		131	13	5	33	16	3
Chairs		79	3	4	79	3	4
Law Charges		911	0	4	911	0	4
							1,837
							13
							9
<i>„ Special Expenses in Relation to Horticulture:—</i>							
Lecturer and Demon- } strator on Botany		100	0	0	100	0	0
Plant and Seed Dis- } tribution		162	17	4	162	17	4
Fruit and Floral Com- } mittees		60	15	4	10	7	9
Grants in aid		165	0	0	165	0	0
							499
							0
							5
<i>„ Chiswick Garden Expenses:—</i>							
Rents, rates, taxes, } and insurance ..		235	0	4	57	17	0
Labour		1,028	16	6	1,028	16	6
Implements, Manure, &c. ..		133	5	10	133	5	10
Coal and Coke		166	14	4	23	12	0
Repairs		135	10	0	28	17	3
Trees, Plants, Seeds, &c. ..		23	12	2	6	9	0
Superintendent's Salary ..		150	0	0	150	0	0
Water		14	1	5	14	1	5
Miscellaneous		88	15	4	7	18	6
							2,100
							9
							10
<i>„ Kensington Garden Expenses:—</i>							
Rates, taxes, and insurance		505	7	10	505	7	10
Superintendent's Salary ..		100	0	0	100	0	0
Labour		503	13	7	503	13	7
Repairs		175	10	4	6	11	6
Coal and Coke		50	15	0	16	10	0
Implements and Manure		37	14	3	37	14	3
Water		29	18	0	29	18	0
Reading Room		23	1	9	1	16	0
Bands		34	2	0	34	2	0
Miscellaneous		10	5	9	0	17	3
							1,496
							3
							3

<i>To Exhibitions:—</i>		Cash paid.		Debts payable.		Totals.	
		£	s.	d.	£	s.	d.
Advertising		255	6	0	15	16	6
Prizes and Medals		52	19	9	503	2	6
Bands		100	16	0	556	2	3
Superintendent } Flower Shows .. }		25	0	0	100	16	0
Labour		102	8	5	25	0	
Judges' Fees		16	16	0	102	8	5
Sundries		172	15	8	16	16	0
Police		22	12	4	172	15	8
					22	12	4
							1,267
							13
							2
					£6,413	15	1
					787	5	4
							£7,201
							0
							5

INCOME.

		Cash received.		Debts receivable.		Totals.	
		£	s.	d.	£	s.	d.
By Annual Subscriptions		3,745	7	0	214	4	0
„ Exhibitions		1,019	9	5			
„ Evening Fête		9	18	11	1,019	9	5
„ Daily Admissions		444	14	0			
„ Garden Produce		556	4	1	9	18	11
„ Packing Charges		26	6	0	444	14	0
„ Miscellaneous Receipts		677	19	10	595	9	0
„ "Davis Bequest"—Interest ap- } propriated under provisions of } Trust towards Prize Money .. }		62	6	10	7	11	6
					677	19	10
					62	6	10
					£6,542	6	1
					261	0	5
					6,803	6	6
„ Balance to General Revenue Account					£397	13	11
							£7,201
							0
							5

We have examined the above Accounts with the Books and Vouchers, and we find the same correct.
31st January, 1883. JOHN LEE, } Auditors.
JAS. F. WEST, }

GENERAL REVENUE ACCOUNT, 31ST DECEMBER, 1882.

DR.		£	s.	d.
<i>To Annual Revenue Account:—</i>				
„ Balance for the year 1882		397	13	11
„ „ carried forward		1,323	10	2
				£1,721
				4
				1
CR.		£	s.	d.
By Balance of Revenue Account brought forward 1st January, 1882.		1,721	4	1
				£1,721
				4
				1

We have examined the above Account with the Books and Vouchers, and we find the same correct.
31st January, 1883. JOHN LEE, } Auditors.
JAS. F. WEST, }

MISS NORTH'S ORCHID PICTURES.

FROM all accounts these paintings are remarkably good, and should be seen by all who have the opportunity. I am in the position of a dweller in the far north, and in common with many more who are deeply interested in anything connected with Orchids, and who at the same time have not much chance of being in London, I feel that it would be a great boon to those who cannot visit London if the collection of paintings were exhibited in some of the chief towns throughout the country.

They might remain in their present quarters for a year or two, and then be sent for a few months to several of the leading towns both in England, Scotland, and Ireland. Six months at twelve of our towns would be six years, and I feel certain that many more people would visit the exhibition in that time than would be the case if they remained the same time in their present quarters.

Of course there may be a provision that will forbid such an exhibition of these paintings. I know not. But if there is not, I am sure great benefit would be conferred on many if those who have the management would allow this interesting collection to be shown in the provinces. The taste for Orchids is growing rapidly, and such a display of portraits of so many of these beautiful members of the floral family, as seen growing in their native places, would tend to increase their cultivation. Many people are banishing the idea that has long prevailed, that only those who have great command of heat, and are possessed of some mysterious secrets in regard to cultivation, can grow Orchids satisfactorily. The fact is that anyone who has a love of gardening, and is possessed of a fair amount of intelligence, can grow many beautiful Orchids with a very moderate expenditure for heating without any initiation into particular secrets, and no very great amount of labour. Many gentlemen who only have one or two glass houses, and who spend their spare time in them, are now taking up the cultivation of Orchids, and when once the taste is acquired it develops very rapidly.

The successful cultivation of many Orchids can be attained. Nothing can be more calculated to increase the appreciation of Orchids than the display of so many of them depicted so ably. Gardeners who have all the appliances, and are cultivating, it may be, thousands of Orchids; gardeners who are following in the wake

of their more fortunate brethren, and are growing only hundreds; amateurs and others who have just begun, and count plants only by their tens—all these would, I am sure, welcome the coming of this collection of paintings to such towns as would enable them to benefit by their exhibition. The enormous number of Orchids imported is a sure sign that their cultivation is becoming general. The interest attaching to the flowering of some imported Orchid which is supposed to be something wonderful, the enthusiasm with which Orchid-lovers discuss their favourites, and the generally elevating effect of a pure love for Orchids—all these have of times been remarked, and rightly too.

Long may the taste for Orchids continue to grow! One thing above all others will conduce to this growth, that is the more general display of these Orchid pictures. At least this is the opinion and the hope of one who entertains an unbounded regard for these lovely and exceedingly interesting plants. Others who have more ability to urge the claims of the country generally in this matter would confer a lasting favour on many, I am sure, if they exerted themselves to procure such exhibitions as I have ventured to suggest.—A LOVER OF ORCHIDS.

LADDER FOR CONIFERS.

WHEREVER specimen Conifers are grown and taken a special interest in, some ready means of reaching their tops is very desirable. The accompanying sketch shows an easy mode of doing so. It is simply an ordinary ladder, supported after the manner of common steps by placing a stout piece of wood across, about 3 feet from the top, of a larch pole or similar piece of timber. The top of the pole is put through between the rounds of the ladder at a convenient height, allowing the latter to rest on the cross made, the bottom of the pole being fixed through a piece of wood to prevent the support slipping outwards. When used on sloping ground the pole must always be placed on the highest side. If the ladder is a very long one, the safest plan is to steady it by means of two guy ropes at the top. Shorter ladders may safely be held by one man by means of a light pole fixed to the ladder by a ring, as shown at *a* in our sketch. The ladder is placed with its side to the tree, the bottom branches coming in between the ladder and the support.—R. INGLIS.

AN AMATEUR'S HOLIDAY.

ABOUT ABERDEEN.

I HAD long wished to see some of the nurseries in the far north. Among places to delight the heart of a lover of flowers I would assuredly place in the foremost ranks the establishment of Messrs. James Cocker & Sons, Aberdeen, a name well known to Scottish florists. Two fine days, a feast of flowers, and a hearty reception combined to render memorable a visit which I trust will only be the first of many. How much I regret that, having lost part of a few jottings I made, I must trust chiefly to memory to supply what I saw with so much gratification; but several things are so impressed as to be easy of recall.

In the last "Rosarians' Year Book," so delightful and instructive, even above its predecessors, Mr. Gray in his racy article, with its too-well-deserved strictures on Rose-showing in Scotland, has intimated the difficulties Messrs. Cocker have so triumphantly surmounted in Rose-growing. Let me interpolate that the gross offenders against even ordinary good taste whom Mr. Gray so humorously and so cordially castigates, are not merely, or, if the truth may be spoken, not principally amateurs. At Morningfield, out of upwards of forty acres, Mr. Cocker devotes a large space to Roses. In addition to all the leading Hybrid Perpetuals I saw a full collection of Bennett's Hybrids. Of these, Duchess of Connaught and Pearl were extremely fine; the full flowers and the scent of the former pleased me much. Numbers of Teas on seedling and Briar cuttings were most attractive. Among them Catherine Mermet and Niphotos were already flowering on plants worked that season. I was also shown Etoile de Lyon in bloom within the enclosure, the possession of which, or another such "snuggery," Mr. Gray affirms would be enough to make him "go daft." It would certainly not be easy to secure such another quarter for Teas, and, judging from what has already been accomplished within it, we may look for something worth seeing from this house at our future shows. I saw also Lady Mary Fitzwilliam, a beauty. Blooms of this variety from plants, the parent of which had been obtained somewhat early, had been exhibited at Glasgow, Edinburgh, and Aberdeen.

I was glad to see such a collection of hardy Primroses, Primulas, and Polyanthus as Mr. Cocker has. I had long wished to know where a collection of these was to be met, and here at Morningfield I found them made a speciality. To lovers of these charming

flowers I throw out this hint worth having. Many of our finest Pansies are the production of the same house. I was delighted with those I saw at Morningfield. The northern air appeared to have refined the complexion of the white grounds especially. I pass over the extensive department of forest and other trees to hasten to the grounds of the firm which may now be said to be within the city. At Sunnybank Pansies were again well represented. A fine display of Dahlias was met here, including the Pompons and the single varieties. A very extensive assortment of double Pyrethrums, an usually comprehensive break of Potentillas, another of herbaceous plants—were a few of the attractions. But what most fascinated me was the collection of Carnations and Picotees. I could have spent hours over these alone. It was the best assortment I have seen. To them is attributable the fact that I can say so little about the houses at Sunnybank, as with a look at a small collection of Orchids I hurried over masses of decorative and other plants, which would no doubt have offered great attrac-

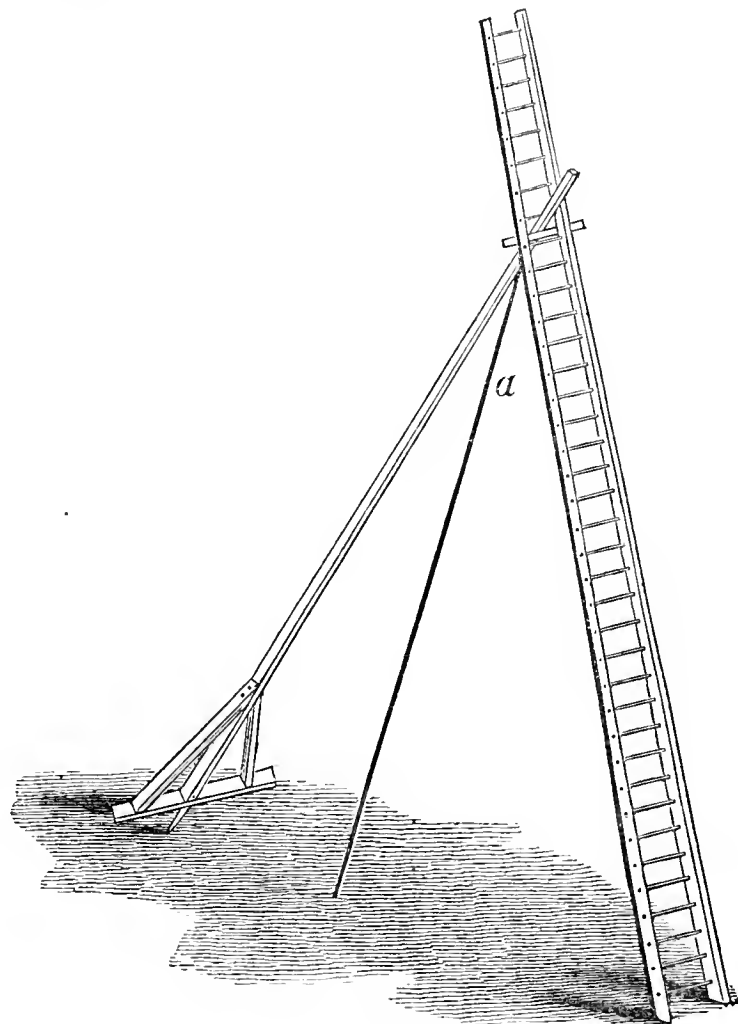

Fig. 43.

tions to many, to return to these alluring flowers. One thing that surprised me was the size and vigour of the plants. A few sent me by a friend did little more than spindle into bloom, and inquiries showed that last season this had been generally the case; but the Sunnybank plants were large, and the vigorous and sturdy "grass" had been successfully layered. The beauty of the varieties I saw, for I was rather late to catch them in general bloom, made a craze for Carnations and Picotees seem the likely terminus of a first attachment. I noted the names of some of the most beautiful sorts, but finding that with Cyprus, Mrs. A. Chancellor, Mrs. Langtry, and Queen of Summer I had reached fully three dozen, I thought it advisable to seek safety in flight. It is somewhat of "a far cry" to Aberdeen when time has to be husbanded, but stern necessity alone will prevent me from again visiting Messrs. Cocker's when next their Carnations and Picotees are in flower.

The Polmuir nurseries of Messrs. William Smith & Son are a little way from Aberdeen. There I saw the Mule Pink Napoleon III., and was struck with it as a bright plant for a mixed border. I believe the principal grounds of the Messrs. Smith are at Kintore, about thirteen miles off, where the collection of herbaceous plants is very complete.

Directly opposite Polmuir is Deemount Nursery, where Mr. J. MacPherson demonstrates what can be successfully achieved in conducting a very flourishing and comprehensive florists' business in moderate space. Discreet arrangement and skilful treatment provide for the accommodation of a stock more complete

than many a one that monopolises a far greater space. In addition to many other good plants, a fine bed of Petunias and another of Pansies and Violas were very attractive. His Carnations and Picotees were select if not numerous, and the fact that on the way home I twice saw consignments of these and Pansies from Deemount would seem to imply that Mr. MacPherson has a name for them considerably beyond his locality. Almost the only Gladioli I met in the north were here, but they were second-rate sorts. On the way out by Ferry Road and at other places about Aberdeen I could not help noticing the extent to which *Tropæolum canariense* is grown. It was really beautiful on the fronts of many cottages and villas.

My impression that human nature is much the same wherever we go, whatever difference there may be for the better being, of course, always on the side of the lovers of flowers, is considerably deepened by my visit to Aberdeen. Whether or not we really are "a' John Tamson's bairns" the experience of anyone who finds the material of the granite city at all emblematic of the hearts of her sons must differ not a little from mine.—A NORTHERN AMATEUR.

P. S.—Relative to the *Richardia*-like plant alluded on page 113, it is a true *Richardia*, as I was careful to inquire, but produces nearly black spathes.—A. N. A.



[By the most skilful Cultivators in the several Departments.]

KITCHEN GARDEN.

EXCESSIVE rain is retarding kitchen garden operations to a greater extent than has been experienced for some years. Sometimes one fine day allows us to dig over some ground for sowing or planting, but heavy rain soon follows, and it is most difficult to get any crop in satisfactorily. Under such circumstances it is better to wait, as it is a great evil to sow seeds or insert plants when the ground is saturated. A few frames and handlights are of the utmost importance in such a wet spring as this, as many young vegetable plants can be then brought forward. A gentle hotbed is a great assistance; but we do not approve of this to any great degree, as, although Cauliflowers, Brussels Sprouts, and Lettuces grow rapidly at this season with a gentle bottom heat, there is always much danger of their being severely checked when they are deprived of this and planted out. Frames placed on the ordinary garden soil in which seeds of different vegetables are sown will afford a batch of hardy dwarf plants for placing out a month or six weeks hence.

Potatoes.—The main crop of early Potatoes should be planted this month. This crop should be confined to south borders. From 20 inches to 2 feet between the rows, and 15 inches from set to set, are suitable distances for most early Potatoes. The earliest Potatoes in frames now require earthing-up. Where the surrounding soil is not sufficient more should be introduced; rough material is much better for the purpose than fine soil. Many of our best show Potatoes are very tender and liable to disease. When planted late and not matured until August or September the finest tubers are generally lost, but if planted in early spring and lifted in June or July they will be found in excellent condition. With this object in view allow the sets to form robust sprouts, and prepare the ground for their reception on the first opportunity.

Carrots.—Seed of French Horn Carrots may be sown in a favourable position. A light soil is most suitable at this season. Where young Carrots are growing in the frames the plants, if thick sowing was practised, may be too close to admit of healthy development, and they should be examined occasionally that the masses may be thinned-out before they are drawn. Carrots which were stored in sheds in autumn are now growing again from the crowns, and to prevent this they should all be turned over, the growths rubbed off, and placed back again in dry sand or leaf soil. Beetroot and Parsnips, Salsafy and Turnips, should be treated in the same way.

Globe Artichokes.—These should now have attention. The earliest heads are produced on plants which have been established for some time. As a rule, however, manure is placed round them during the winter, and this should be forked into the surface. Where plants are scarce the old ones may be taken up, divided, and planted again. They delight in a deep rich soil and an open position.

Rhubarb roots may be treated in the same manner. Old Seakale roots from which a crop is not expected should be taken up, each crown cut away with a piece of root attached and replanted. This is an easy way of securing a fresh Seakale plantation.

Horseneat.—Where this has been growing in the same place for some years it should be dug up. Select the best roots and replant them. We prefer pieces about 12 inches long, as thick as an ordinary walking-stick, and quite straight. Let the soil be rich and deep. Lay in the remainder in a corner to meet demands until the new plantation is ready for use.

Onions.—Those sown in autumn should be transplanted. Just enough should be left in seed beds or rows to form a crop, and all others should be planted in a very rich piece of ground; allow 15 inches between the rows and 10 inches from plant to plant. Place finely sifted ashes over Peas which are coming through the ground, as snails may do them much harm. Earth up and stake those more advanced.

Birds are particularly fond of pulling up young Radish plants, and to prevent this it is often necessary to place a piece of net over them at this season. Admit abundance of air to Cauliflower and other young plants under handglasses and frames. Many of the autumn-sown plants may now be moved to their bearing ground. Close to walls and between rows of Peas which have been lately staked are suitable places for early Cauliflowers. Early Onion seed may be sown in a well-manured border.

Leeks.—Seed may be sown in any corner to supply a few plants for early shows. The soil cannot be too rich for them, but as those sown now will all be transplanted again a reminder of this will be given by-and-by.

The last batch of Asparagus may be put in. It may be had readily now in any house or frame where the top and bottom heat is about 70°. Kidney Beans should now be sown under glass in large quantities. Pot all advancing crops of Potatoes and Cucumbers. In many instances the latter will now be ready for the fruiting bed. Lumpy rich soil and a temperature of 70° will soon produce abundance of fruit.

FLOWER GARDEN AND PLEASURE GROUND.

Herbaceous Borders.—The occupants of these borders seldom receive the treatment they merit. The majority being gross feeders and spreading rapidly, unless frequently manured, occasionally divided, and replanted, inevitably become weakly and flower very indifferently. Probably the best time to reform an herbaceous border is in the autumn, after many of the fibrous-rooted kinds are cut down. At this time and not later all bulbs which are usually intermingled may be moved. Phloxes, Pyrethrum, Anemones, Asters, *Dielytras*, *Fritillarias*, Irises, *Spiræas*, *Tritomas*, *Delphiniums*, *Hemerocallis*, *Potentillas*, *Polemoniums*, *Tradescantias*, and other plants of similar habit may all be and will be improved by being divided at the present time, a plunging fork being best for the purpose. Replant firmly, taking care to well cover the whole of the roots in deeply dug and freely manured ground. Heavy land will be much improved by a good dressing of leaf soil. The bulbs are now well advanced in all borders, and a dressing of short manure or leaf soil may be forked in without any risk. Careless workers and spades ought not to be trusted near herbaceous borders. Pinks and Carnations have been much preyed on by slugs, and the only remedy is to trap the ever-increasing pests. They collect in great numbers on heaps of bran or Broccoli leaves, and may then be destroyed. In drier weather they may be caught easily under pieces of slate laid flat on the ground. A brood of ducks may well be introduced into the kitchen garden, where the herbaceous borders are often disposed, more being hatched to replace them when too large to be either industrious or trusted.

Propagating Bedding Plants.—Many Pelargoniums have damped off during the winter, and it will be necessary to strike a considerable number this spring. At one time autumn-struck plants were much the best for summer flowering, but the varieties now generally grown flower freely when struck in the spring, and the bronze, golden, and silver-variegated sorts are best struck at this time. All our old plants are in a newly started vinery, and when they have commenced growth the tops will be taken off and dibbled thickly in well-drained 8-inch pots, and stood on the staging over the hot-water pipes. Light sandy soil is employed, and no water is given till the cuttings are healed, or about a week; afterwards water is given as required. The Ivy-leaf section and the scented-leaf kinds strike the most readily in heat, and these and the useful small yellow-leaved Robert Fish may thus be rapidly increased, the tops in each instance being allowed to grow till large enough to form other cuttings. We are also commencing to pot all the stronger varieties that were wintered in boxes, these being placed in the vinery above mentioned till esta-

blished. Those who have to propagate and grow their bedding plants principally in cool houses and frames are advised to delay both the propagating and repotting the Pelargoniums till March.

Dahlias, *Salvia patens*, bedding Fuchsias, *Cineraria maritima*, Centaureas of sorts, Marguerites, Gnaphaliums, *Santolina incana*, if introduced into a forcing house, will yield abundance of cuttings, and which will strike readily in heat. As a rule, the beautiful *Veronica Andersonii variegata* strikes badly in the spring; but we have succeeded with it, and those who may have strong old plants should place them in heat, and when the young growth is about 3 inches in length these should be taken off with a heel and struck. Cuttings of it strike more freely in the autumn, and when planted with *Violas* or *Verbena venosa* are remarkably effective. The most simple way to increase *Verbena venosa* is by cutting up the long fleshy roots into short lengths with two joints, dibbling-in these thickly in boxes of light sandy soil, and placing them on a hotbed. When plants are formed they may be hardened off and temporarily planted in cold frames in company with the shrubby *Calceolarias*. Tops of Golden Thyme dibbled-in thickly in pans or pots of light sandy soil and placed in a close frame, root quickly and form neater plants than are obtained by dividing the old roots. *Polemonium coeruleum variegatum*, though not extensively grown, is yet one of the best bedding plants we have. Dryness at the root and heat are most injurious to it, but plants wintered in cool houses and frames are now commencing growth, and at the same time emit roots near each crown. These crowns are detached from the main stem, dibbled singly into 3-inch pots, and placed in a cold frame. Good sandy soil is employed, and this is kept uniformly moist. In this manner handsome plants are soon grown.

PLANT HOUSES.

The Stove.—Eucharises that have flowered can now be potted before their growth is too far developed. Where a succession of bloom is required in preference to a good quantity at one time it is best to grow these plants in 5, 6, and 7-inch pots, placing two, three, or five flowering bulbs in each pot, according to their size. When in these pots, and the plants are prepared to bloom successively, it is preferable to pot them as the various batches cease flowering, instead of going through the whole stock at one time. The liberal supply of water they require while in active growth soon renders the soil unfit for the roots, and on this account they should be annually repotted or liberally supplied with liquid manure and top-dressings. In potting all soil should be shaken from the roots, and the small bulbs removed, and if necessary to increase the stock they can be potted. The pots should be drained liberally, and the soil pressed firmly. The compost should consist of rich fibry loam and sand, to which should be added one 6-inch potful of bonemeal and nearly the same quantity of soot to each barrowful of soil; a little charcoal broken to the size of cob nuts is also beneficial. The foliage should be supported by two or three small stakes and a piece of matting until the roots commence growth, which will be in ten or fourteen days if the plants are placed in a moist heat. Water at once after potting, and keep the foliage continually moist until the roots are growing freely.

Sow in brisk heat seeds of *Gloxinias*, Tuberous *Begonias* for late flowering, *Torenia Fournieri* (a fine plant for the decoration of the conservatory during summer), *Celosia pyramidalis coccinea* and its variety *aurea*, Cockscombs, and *Grevillea robusta*. The whole, except the last-named, should be sown on the surface of the soil in the pans or pots used, which for the three former should be sandy and as even as possible, while the *Celosia* and Cockscomb seed is best sown on the surface of fine leaf soil. The *Celosia* is a valuable plant for decoration, and its coloured foliage useful for associating with cut flowers. It is of easy cultivation, and any quantity can be raised from seed, which should be fairly covered with soil when sown, as it is rather long in germinating. Water with a fine-rose can, and cover with glass and moss laid over it, until the seeds germinate.

Fuchsias that have been at rest may now be pruned, and started by introducing them into a temperature of 50° to 55°. Moisten the dry ball thoroughly, and syringe liberally until they break. As soon as they have fairly started into growth shake the old soil from their roots, and repot in the same or larger pots if necessary. Employ a compost of two-thirds good loam to one of old Mushroom-bed refuse and leaf soil, to which add a good dash of coarse sand. Water carefully for a time after potting.

Cinerarias that are showing their flowers should have weak stimulants every time watering is necessary, and nothing will prove more beneficial than clear soot water; it acts quickly and imparts a dark hue to the foliage. The same applies to the earliest *Calceolarias* that are or should be well established in their flowering pots. Young plants of the former that were raised from seed

sown late and kept in 3-inch pots can, if they are not showing bloom, be placed in others 2 inches larger, and will prove invaluable towards the end of May. Successional batches of *Calceolarias* will also need attention in potting. If success is to be achieved with these plants care must be taken that they do not suffer by the want of root room until after they are placed in their flowering pots. In potting use a compost of two-thirds fibry loam, one of leaf soil, with properly prepared cow manure and sand; the latter should be rubbed through a rather fine sieve before mixing it with the other soil.

THE BEE-KEEPER.

FEEDING BEES IN AUTUMN, SPRING, AND SUMMER.

(Continued from page 81.)

IN our former letters we have spoken of the autumn and spring feeding of bees, and have put great stress on the necessity of feeding stocks in late summer when they are kept in a locality where there is no natural autumn harvest of honey. We wish to be well understood on this point, because not only the utility, but, indeed, the possibility of obtaining late hatches of brood have been called in question by some. Mr. Pettigrew's letter in the *Journal* for February 1st, although at first sight seeming to differ from our opinion, really upholds us in our teaching, for he shows that when bees are sent from a locality in which the season has virtually ended, and where breeding therefore ceases, to the moors where another harvest is to be collected, those bees not only store honey, but "fill their hives with brood from side to side."

Our first thorough examination of stocks which have passed through the present winter again proves the great advantage of autumn feeding. We fed all our bees last autumn until about the middle of September, so that the last brood was not hatched out until the first week in October. They are all in capital condition, but one hive in particular again repeats the lesson so often learnt—viz., that hives entirely deprived of their combs and stores, and fed on syrup and candy-cake in August and September, invariably prove the best of stocks in the following spring. This is of course provided that they are wintered in warm waterproof hives. A friend had a swarm of bees in a very large straw skep. Owing to the dull wet season it did not half fill this skep with combs. We were asked to take the bees, to run out for the owner what honey there was, and to put the bees into a bar-frame hive. We do not consider it worth the trouble to transfer the combs (excepting such as have brood to be hatched out) to the frames of the new hive. We gave full sheets of foundation, and fed the bees as mentioned above. Although surrounded by Heather, no honey was obtained from that source last autumn, owing to the wretched weather prevailing at the time. This stock of bees, therefore, was almost entirely fed upon sugar syrup and pea-meal cake. They increased rapidly after the transfer, and were wintered with six frames of comb. Examining them on the 6th inst. we found them certainly the best stock we have, not only as to strength, but also as to the beautifully clean and healthy appearance of their hive, and breeding had again commenced.

We will now speak of the feeding of swarms. Let some bee-keeper who wishes to prove the utility of feeding swarms have two swarms of about equal weight in separate hives. Should the weather be very fine still, let him gently feed one of the swarms, day and night if he will, but more especially each evening. After the lapse of a week or so let him examine and compare the two hives—the one having been left to Nature, and the other having been assisted. He will without doubt ever after feed his swarms.

Every bee-keeper should become well acquainted with the time and season when the greatest flow of honey usually takes place in his district. In some favoured spots there are two or three harvests; in others only one, and perhaps this must be all collected in the short period of some five or six weeks. We once depended entirely on the white Clover harvest, which was only at its height for a little over three weeks; yet so great was the abundance of honey during that short space of time, that one stock would be working in as many as three or four supers (?) at the time. This was before we knew of sectional supers. On both sides of the brood-nest, behind it, and at the top, we have had receptacles simultaneously filled. But what an enormous colony we required to take all due advantage of this short harvest! and these mighty legions were only to be had by so feeding up our stocks and harbouring their strength against the time when we knew to within a few days the harvest would begin,

Generations of bees had lived and died in the ordinary cottagers' skep, and had been about at their best perhaps just as the time of harvest had passed by.

Driven bees must of course be treated as swarms; but since they are usually obtained late in the summer, and have little chance to store much food from natural sources, they must have sufficient food given them to carry them over to the following spring—from 15 to 30 lbs. of food, according to the strength of the colony. The food should be, as recommended for autumn-stimulating feeding, made with less water than that employed in spring and summer, and all feeding should be discontinued after the middle of October. Should the rescued colony have been taking the food gradually before, when October commences it should be fed rapidly. Should the weather have become cold and wet, and the bees disinclined to take the food, we have brought hives into a warm room or greenhouse, closed the entrance with perforated zinc, and fed rapidly every evening, putting the hive again into its place on fine mornings, to allow the bees to take a flight. All syrup not sealed over by the middle of October is to be extracted, otherwise it might ferment and cause the bees to have dysentery.

A word of warning should here be given to beginners in the art of bee-keeping. The influence of such a mild winter as we have experienced in the south is to cause bees to consume great quantities of food, because they have been constantly on the move; therefore there may be many cases in which feeding, which we term obligatory feeding, may now be required. We would not attempt to stimulate bees to breed largely yet. In our former letter we said that we had learnt to be most careful how we excited our bees too early in the year; but where food is running short, and it will be now in many hives, especially in the best, the healthiest, and the strongest, there we must renew the store, or the garrison will be starved out. The syrup should be given rapidly. It should be warm, and placed over the feeding hole, or at the side chamber of the hive, such as we have recommended. It should be given in the evening, so as to do away with any chance of bees from other hives having knowledge of the operation. What is not taken down during the night should be removed in the morning, and again given warm the next evening. Later on this must be followed by stimulative food. Should there be signs of dysentery in any hives, some warm food should be given in the same manner as explained above, having mixed with it a teaspoonful of salicylic solution to every pound of food. The solution should also be used for spraying the combs, floorboard, and sides of the hive. We copy the recipe from Mr. Cowan's book on bee-keeping:—Salicylic acid, 1 oz.; soda borax, 1 oz.; water, 4 pints. Bee-keepers should keep this solution by them in well-corked bottles, as it is invaluable to cure and prevent dysentery and the germs of foul brood.—P. H. P.

(To be continued.)

“UN-GET-AT-ABLE” HIVES.

A VERY able and respectable correspondent, “P. H. P.,” has lately used this expressive compound word in referring to and in disparagement of straw hives. I rather like expressive words if they are accurate and correct. But probably your correspondent used the word as a figure of speech, not as one conveying his own sober thought, for he must know that hives un-get-at-able are quite unknown in the apiarian world. From every point of view the word in question is inaccurate, and, in my opinion, misleading. I look back half a century, when numbers of bee-keepers I then knew were well informed in the mysteries of bee-keeping. It is true they knew nothing of bar-frame hives, for they never saw one or dreamt of their introduction, and if there was a book on bees in the district I should have heard of it. Yet these men living fifty years ago were in my opinion as well acquainted with the habits and natural history of bees as many of the most advanced experts and professors are now. The wonderful internal workings and doings of bees were unfolded to and well understood by these ancient bee-keepers. And all this knowledge was gained from hives which “P. H. P.” is pleased to call “un-get-at-able.” Large harvests of honey, as well as accurate knowledge and experience, were obtained from these hives, and the difficulty of taking the honey did not trouble these old bee-keepers much.

I come now to notice my experience with and amongst such hives. In my hands they have been well and fairly tested. I like them exceedingly, and better after every year's trial. They have never once failed in a very extensive practice. In them I can get or cause to be bred as many queens as I wish, and from them I have no difficulty in extracting young queens as they arrive at maturity. By turning up a straw hive (and this is easily done), I can examine the internal doings of the bees, see what progress is being made, and learn all that is necessary to know in the management of an apiary. Indeed, I have been able to examine twelve straw hives,

and see all I wanted to see, while those of the bar-frame school have been busy examining one of theirs. Brood healthy and brood unhealthy, queens fertilised and unfertilised, can all be noticed in these hives. I have seen harvests of honey taken from straw hives which I think would please and astonish “P. H. P.” and other modern bee-keepers. Such harvests of honey from bar-frame hives would gratify their owners, and I earnestly hope that such will be obtained. I anticipate that the coming season will be a good one for honey, and that hives of all kinds will be well stored. I have ordered thirty-two straw Stewartons to be made for my swarms. As soon as they arrive other orders will be given for more Stewartons and straw hives. Our respected friends may rest assured that if they be well filled I shall “get at” the honey and send it to market, for it is my intention to keep an accurate balance sheet of the expenses and profits of my apiary this year, and present it to the bee-loving community of Great Britain. Whatever the profits may be will be the outcome of straw hives.—A. PETTIGREW, *Bowdon*.

WINTER BREEDING OF BEES.

AFTER reading the remarks of “P. H. P.” on autumn feeding, I took the first opportunity of a mild day, with the thermometer registering 49°, to examine our bees, thinking possibly they may have been in want of food, as they were not fed in the autumn, and each hive was reduced to six frames. I was rather surprised in two of them to find many young bees, apparently just hatched, also a quantity of brood, some of which were hatching, enough to nearly fill a frame in each of them. In one hive the queen was reared about the end of July, in the other the queen was reared the summer before; and as these were treated in the same way as the other hives with queens of the same ages, I cannot account for so much brood at this time of the year.—J. L.

TRADE CATALOGUES RECEIVED.

Benjamin Pounsett, High Street, Wallingford, Berks.—*Catalogue of Vegetable and Flower Seeds.*

James Yates, 29, Little Underbank, Stockport.—*Catalogue of Flower and Vegetable Seeds.*



** All correspondence should be directed either to “The Editor” or to “The Publisher.” Letters addressed to Dr. Hogg or members of the staff often remain unopened unavoidably. We request that no one will write privately to any of our correspondents, as doing so subjects them to unjustifiable trouble and expense.

Correspondents should not mix up on the same sheet questions relating to Gardening and those on Poultry and Bee subjects, and should never send more than two or three questions at once. All articles intended for insertion should be written on one side of the paper only. We cannot reply to questions through the post, and we do not undertake to return rejected communications.

A Strange Plant (*Halifax*).—“A plant which grows with its roots above ground and all the rest of its growth below” is something quite new to us, and perhaps your friend can furnish you with some further particulars concerning it, which would, we should think, be rather interesting. He must be an extremely observant person, and deserves much credit for his discovery.

Carpet Bedding Plants (*S. J. W.*).—The *Acæna* you name can be raised from seed, or by cuttings inserted in sandy soil in a cool frame, but we doubt if you would be able to raise sufficient stock by hedding-out time. In addition to the other plants you name you might grow *Oxalis corniculata ruhra* and *Ajuga reptans* to furnish the dark colour; both have reddish foliage, the first named being exceedingly dark. The first can be increased by seed and the latter by division of the roots.

Conifer Hedge (*Idem*).—We know of no Conifer that makes a more beautiful hedge than *Thuia Lobbi*. It grows closely without being formal, is very hardy, and retains its bright green colour throughout the winter. You can obtain plants of the height you require from nurserymen who grow Conifers largely. *Thuia occidentalis*, the American Arbor-Vite, is much cheaper, and also forms a neat hedge, so does *Cupressus Lawsoniana*. The Yew hedges are the closest of all, but the colour may, perhaps, be too sombre for your purpose.

Potting Tuberos Begonias (*G. S., Renfrew*).—The tubers should be placed in light gritty compost, surrounding them with silver sand, and just covering them with soil; or, to be more precise, those less in size than a walnut may be covered a quarter of an inch deep, those that are larger twice that depth, and very large ones 3 inches in diameter may be placed an inch below the surface. If the pots can be plunged in a bottom heat of 80° or 85° it will be an advantage in facilitating the growth of the plants.

Peach for Wall (*W. T. G. W., Reading*).—Grosse Miguonne was, we think,

the variety to which you refer. It is one of the best Peaches in cultivation, and you cannot err by obtaining a tree of it for the aspect you name. You will find the protection of nets valuable in such an exposed position.

Pelargoniums Damping (*J. P.*).—The reason the leaves of your plants have withered is the result of their having been potted too late, and had not time to produce roots for supporting the foliage. Had they been potted a month sooner the roots would have been active before winter, and the majority of the leaves would have been kept healthy. You would have done better to have inserted the cuttings in the pots in August, instead of in the open ground and potting so late in the season. You had better keep the house rather close and warm now to encourage fresh growth; a night temperature of 50° will be suitable, applying water and affording ventilation on mild days as heretofore.

Roses for House and Garden (*A. T.*).—The following are suitable Teas for a house:—Satrano, Isabella Sprunt, Duc de Magenta, Niphotos, Catherine Mermet, Abriote, Homère, David Pradel, Madame Lambard, Marie Sisley, Madame Ducher, Madame Margottin, Cheshunt Hybrid, Duchess of Edinburgh, Belle Lyonnaise, Vicomtesse de Cazes, Madame Trifle, Madame Berard, Madame Alexandre Bernaix, Letty Coles, and Marie Van Houtte. Good Hybrid Perpetuals are La France, Comtesse d'Oxford, Jules Margottin, Alfred Colomb, Madame Lacharme, Senateur Vaisse, Duke of Edinburgh, and Général Jacqueminot. The following will be suitable for your purpose in a garden in a smoky district:—Marquise de Castellane, Jules Margottin, John Hopper, Gloire de Dijon, Souvenir de Malmaison, Comtesse d'Oxford, Général Jacqueminot, Prince Camille de Rohan, Duke of Edinburgh, Marguerite de St. Amand, Madame de Cambaères, Elizabeth Vigneron, Cheshunt Hybrid, Madame Clemence Joigneaux, Boule de Neige, Madame Victor Verdier, Maréchal Vaillant, La France, and the common Moss.

Preparing Ground for Lawn (*A. D., Isle of Man*).—By taking advantage of favorable weather for carrying out the plan as described in your letter, we have no doubt you will succeed in your object. We should not think of incurring the great expense that would be involved by the counter proposal. If a week or two of bright weather should occur in March so as to dry the refuse that works to the surface, it would be an excellent plan to rake it in small heaps and burn it, carefully spreading the ashes and an inch or two of the scorched soil below on the land; if you do not do this you will have dark patches of grass where the burning has been done. The surface must be made firm and smooth before sowing the seed.

Lifted Vines (*J. T. S.*).—We can scarcely understand Vines six years old only having rods 4 to 5 feet long. Certainly they will not need shortening. Keep the house cool, so as not to excite growth early in the season, but let them start naturally. The great point is not to exhaust the sap from the rods before root-action quickly follows to maintain the supply. You had, therefore, better retard them now, even if it may be requisite to afford fire heat in the autumn to ripen the wood. When growth commences remove the weaker buds, and when the bunches are seen again thin out a portion of the growths by rubbing them off if needed. The laterals to remain should be at the least a foot apart, 15 inches being preferable, along each side of the rods, and they should not be allowed to carry more than half the crop this year that they finished last year before being lifted. Has not drip from the roof caused the Aloe to canker? If this is not so the root-action is probably defective, and a top-dressing of rich soil might be beneficial. On this, however, we cannot advise, since you afford us no data to guide us in the matter. If you write again please state the size of the plant and the pot in which it is growing, with such other particulars as you think desirable, to enable us to comprehend its condition.

Repotting Lomarias (*Reader*).—It is not easy to answer your question without knowing more intimately the actual condition of the plant. We have treated old Ferns in the manner you suggest, and improved them considerably. We have also benefited them greatly by digging out a portion of the soil from the pots, and top-dressing with a compost of turfy loam and manure, and when this has become permeated with roots giving clear soot water once or twice a week. A rim of zinc placed round the pot will enable you to repeat the top-dressing if you adopt this method of re-ovation. If, when you turn the plants out of the pots, the roots have a black dead appearance carry out your project, but if they are fresh we should prefer the alternative of top-dressing and liquid manure.

Euphorbia splendens (*Idem*).—It is true, as you say, that this good old plant will flower continually if kept in a warm house, but a rest occasionally is beneficial. This you may give at any time by placing it in a house where the temperature does not exceed 45°, and keeping it comparatively dry at the roots for a month or two. If you then remove a portion of the surface soil, add fresh rough rich compost, and place it in a warm house having a genial atmosphere, it will flower profusely. In August it is a good plan to place the plant outdoors near a south wall for a month or six weeks, but shading the pot from the sun. After that flowers will be plentiful throughout the winter if required, but the finest trusses are produced in early summer after a rest afforded at the present time.

Gardenias in Border (*C. B. B.*).—It is utterly impossible for anyone who has not seen the plants to say "how much water they ought to have." So far as we can judge from your letter your gardener is treating them correctly. The temperature is right, also the syringing, and when we find a man right in two things we seldom find him far wrong in the third. Until the roots have taken possession of the soil frequent applications of water will not be needed, still it must never be allowed to get really dry. As soon as it approaches dryness—that is, when a little that is dug up with a stick from a few inches below has a tendency to crumble, sufficient tepid water must be given to penetrate the entire mass. As the season advances and plants increase in size and activity, they will require more than twice the quantity of water that will suffice now. Whenever it is given it must be applied copiously, as there is a danger in having the border too moist on the surface and too dry below; at the same time it must not be saturated now, or the roots will not extend freely. Once they thoroughly permeate the soil it is not easy to give Gardenias too much water in a well-drained border.

Protecting Fruit Trees (*F. J.*).—One thickness of the canvas, a sample of which you have sent, would exclude several degrees of frost and not materially impede the action of the sun and air. As a permanent covering we should only use one thickness; but very sharp frosts occasionally occur for a night or two which destroy the blossoms under a thin covering, and against this contingency we should have sufficient of the material at hand to place over the other on any night when the frost threatened to be unusually severe. The thin covering should remain on the trees until the fruit is fairly set. You may apply lime at the rate of 1 lb. to 2 lbs. per square yard in your fruit garden; if the soil is very rich and adhesive the latter quantity will not be too much. Whether plunging material should always be kept damp depends on what you

want to plunge in it; as a rule it should be for all plants in active growth, yet too much moisture injures the flowers of some plants at certain seasons.

Improving Tennis Lawn (*Various*).—According to your statement the ground must be very wet, and instead of having two we should prefer four drains 18 inches deep, with two or three inch pipes connected to another drain to conduct the water away. Over the pipes place some rubble. After removing the old turf and spreading on the hard rough material you propose you must cover it 2 inches deep with fine soil, making all smooth and firm. If you can procure wood ashes or charred vegetable refuse for surfacing this will induce a quick growth of the grasses, and the charring would moreover destroy worms and the seeds of weeds that are often so troublesome in new lawns. If you send the size of the ground to those who advertise lawn seeds in our columns, and state you want to sow liberally, they will supply you with the proper quantity of a suitable mixture. By sowing in suitable weather towards the end of March and early in April we have seen close lawns in two months, and tennis played on them throughout the season. In these cases the seed was sown thickly, and light rich soil carefully sifted over it, so as just to cover it and no more, then rolling lightly. The first two or three mowings should be with a very sharp scythe, just removing the tips of the grasses, afterwards a machine may be used, but not set so low as to shave off the grass close to the ground. Everything depends on good management in producing a lawn quickly, both in preparing the soil and giving good after-attention to the herbage. Birds are often very troublesome after the seeds are sown, and unless you are watchful they may do much harm before you are aware of their depredations.

Peas for Succession (*Idem*).—If you sow the varieties you name "three weeks after each other" you will have a succession, but certainly a "break" in the supply. By sowing Day's Sunrise, Telephone, and Ne Plus Ultra at the same time they will succeed each other in bearing as you require, and when the plants of the latter are fairly visible sow more of the same variety or Omega, and continue the process till the middle of June. You may then expect an uninterrupted supply of excellent Peas throughout the season.

Trees and Shrubs for the Seaside (*A. C. Wilkin*).—We have never seen any of the trees you mention in a flourishing condition near the sea. The best of all Fir trees for such a situation is *Pinus maritima*, the Pinaster, which thrives admirably in an exposed place, where we have seen hundreds of it 80 feet high. *Pinus austriaca* has thriven so well on your coast that preference is given to it there. Ilex, Sycamore, Beech, Turkey Oak, Spanish Chestnut, Black Italian Poplar, and common Silver Fir (*Picea pectinata*) all answer well and grow to a large size if the land is tolerably fertile and well drained, but none of them are suitable for a swamp. If you have a swamp try Alder; we have found it thrive where Willows have proved a comparative failure. Plant thickly, watch the growth closely, thin judiciously year by year as the trees become large enough to require it, clearing sufficiently around the permanent trees to admit sufficient air and light to induce a free, strong, healthy growth, and you will eventually gain thorough shelter and fine timber. Of shrubs Holly is the only one thriving by the sea that bears shade and drip well, but for open places away from the trees Japanese Privet, Tamai, Box, and Mahonia may be planted with the Holly, and they would make excellent cover for game. *Euonymus* also answers well by the sea, but unfortunately rabbits are very fond of it, and the Snowberry (*Symphoricarpos racemosus*) makes a good undergrowth in plantations in damp positions.

Heating Vinery—Grapes Shanking (*J. M.*).—Unquestionably the best mode of heating the house would be by hot water, and we should not consider such a house complete without an apparatus for this purpose. Two rows of 4-inch pipes taken round the house, except across the doorway, would answer. As you would have to sink the boiler so that the top of it would be below the doorsill, a low or rather flat terminal saddle would probably suit you as well as any. A flow pipe from the top of this passing below the doorway, then rising to the height required and conducted with a very slight incline, say a rise of about 3 inches to the doorway at the opposite end, returning from thence back to the bottom of the boiler, would heat one side of the house, and a similar arrangement along the other side would complete the work. You would require a T piece in the flow to which to connect the pipes, and an air pipe at the highest point of each flow, which would be near the doorway at the end of the house opposite the boiler. Your present flue might possibly act as a smoke-shaft. You can ascertain by measurement the length of pipes required, and if you order them from a respectable firm they are sure to be "good." Ordinary socket pipes will answer, and if you wish to have them so that they can be easily removed at any time, put them together with indiarubber rings. As you appear to have had little, if any, experience in work of this kind, you will find it advantageous to employ some competent person or firm to do what you require, as a mistake in setting the boiler or arranging the pipes would end in failure and consequent loss. If the roots of your Vines are confined to a border 3 feet wide and 2 feet deep, in all probability they do not receive sufficient support, and this alone would cause the fruit to shank. All the varieties you name will ripen in a house heated as we have suggested.

Cucumbers in Greenhouse (*H. S. P.*).—As you appear to have succeeded in producing satisfactory crops last year, you cannot do better than to pursue the same method of culture this year. As to the failure of the other plants, in some respects the fault was your own, in others it must be attributed to the unsuitability of the house. You ought to be able to grow Gloxinias, Maiden-hair Ferns, and to a certain stage Tuberous Begonias in a house with Cucumbers, as the temperature and moisture would be suitable for all; but Pelargoniums and Lilliums need much more light and air, and a cool frame would be far better after the middle of May for them than a close warm house, also for the Begonias after they were fairly started into growth. If you desire further information and will state your requirements as clearly as possible, we are quite willing to supply it; but no one can grow satisfactorily all the plants you name in a house that appears to be chiefly devoted to Cucumbers. You will find lists of French and other continental seedsmen, &c., in the "Horticultural Directory," which you can obtain through a bookseller, price 1s., or by post free from this office price 1s. 3d.

Roses for Garden and Pots (*J. G., Nottingham*).—Assuming that the soil is good the exclusion of the sun at mid-day will not seriously interfere with the growth of any Roses that succeed well in your district. During hot seasons we have had the finest Roses from plants growing on a north border, but they had the benefit of the sun for a few hours in the morning and again in the evening. This, we presume, will be so in your case, and you may therefore plant such varieties as you prefer. In repotting Roses the size of the pots can only be determined by the size of the plants and the condition of their roots. Unless the pots are quite crowded with roots we should not repot Roses now, but remove an inch or two of the surface soil, at the same time digging out any portion from near the sides of the pots that can be done without injuring the roots materially; then add a top-dressing of rich compost, such as two-thirds

of turfy loam with one-third of manure, and a fifteenth part of the entire bulk of bonemeal. With sufficient water, yet judiciously applied, and eventually liquid manure, large plants can be kept healthy in comparatively small pots. When you ask for the maximum size of pot we must again reply, That depends wholly on the size of the plant. We have seen many plants 3½ feet in diameter and 2 feet high bearing from twenty to thirty fine blooms in 8-inch pots, and we have seen Roses in pots 15 inches in diameter, but the specimens were about 8 feet high by 5 or 6 feet in diameter at the base just above the surface of the pot, these grand examples each bearing from two to three hundred blooms. Any Roses can be trained to a trellis, but it depends entirely on the size of it as to which would be the most suitable varieties. A suitable distance for training the growths would be 3 or 4 inches, but we do not admire the plan to which you allude. It would have been better if you had stated your object and conveniences for growing Roses in pots, with the size and condition of the plants on which you desire information.

Croton Culture (Ignorant).—These plants require a warm stove temperature, a moist atmosphere, abundance of light, and generous soil to grow them quickly and of good colour. A night temperature of 75° is not too much, with a rise to 85° or 90° in the day with sun, a bottom heat of 85° being desirable but not indispensable. The plants should be repotted whenever the pots are fairly filled with roots, and these are protruding through the drainage, until they are in the size in which they are intended to be exhibited. Handsome specimens can be grown in 8-inch pots. In a small state a compost of a little more than half of rather light turfy loam, the remaining portion to consist of peat and leaf soil, with sand and crushed charecoal to render the whole porous; when transferred to 6-inch pots the peat and leaf soil may be reduced and a little decayed manure added, and at the next shift a 5-inch potful of bonemeal mixed with a peck of the soil will be of great service. It is important that the pots be filled with roots as early in the summer as possible, or the foliage will not colour well. Light, heat, and an abundance of water are essential for this. Throughout the season the plants must be syringed freely, and occasionally the leaves should be sponged with soapy water, especially on the under sides, as a preventive of thrips, as it is impossible for you to grow Crotons if they are not kept clean. If huge specimens are required the growths must be topped, but very fine medium-sized plants with splendid foliage can be grown without topping, and such plants in brilliant colour would be preferred by a good judge to specimens of three the size with comparatively small and colourless foliage. When the pots are crowded with roots soot water is a safe and excellent stimulant. You ask for the best "var." Whether you mean the best variety or varieties is an open question. Following your abbreviation strictly we should name one, but as you probably need more we name six that are equally good for home decoration and exhibition, at the same time not being so costly as some of the newer varieties:—Queen Victoria, Prince of Wales, Weismann, angustifolius, undulatus, and Disraeli. If, however, you wish to exhibit this number you should have one plant extra, in case all the others should not succeed, and you may add Evansianus. If you will state which Tradescantia you mean, or send us a leaf, we will answer your other question. There are numbers of species, some hardy and others tender, and you will therefore perceive you have not made the matter clear for insuring a satisfactory reply.

Cattleya Percivilliana (Disappointed).—We have heard many others besides yourself express their disappointment with regard to this Orchid, which has by no means proved so handsome as was expected. However, it has never been eulogised in these pages, and probably you will hear more in its disparagement than otherwise. It appears to vary considerably, the lip differing in the richness of the colouring, though the flowers are generally small. It may improve to some extent, but it is doubtful if it will ever gain much favour with Orchid-growers.

Names of Plants (W. H.).—*Begonia Weltoniensis*. (R. S.).—1, *Asplenium viviparum*; 2, *Dendrobium nobile*; 3, *Cœlogyne cristata*; 4, *Odontoglossum Alexandræ*. (N. X.).—1, *Adiantum cuneatum*; 2, *Doodia aspera*; 3, *Blechnum brasiliensis*.

Moving Bees (W. E., Waltham).—As there will be little activity amongst your bees for some time we think you will lose few, if any, of them if you remove the hives at once. If the weather should be very mild, and the bees show a disposition to leave the hives, you might close the apertures during midday for a short time, but probably this will not be necessary.

COVENT GARDEN MARKET.—FEBRUARY 14TH.

THE Market remains very quiet. A fair supply of early forced vegetables continue to reach us, but good samples of late Grapes are short at previous quotations.

FRUIT.

	s. d.	s. d.		s. d.	s. d.
Apples.....	½ sieve	2 0 to 7 0	Grapes	lb.	2 0 to 5 0
".....	per barrel	20 0 40 0	Lemons	case	10 0 20 0
Apricots.....	doz.	0 0 0 0	Melons	each	0 0 0 0
Cherries.....	½ sieve	0 0 0 0	Nectarines.....	dozen	0 0 0 0
Chestnuts.....	bushel	10 0 12 0	Oranges	100	6 0 10 0
Currants, Black..	½ sieve	0 0 0 0	Peaches	dozen	0 0 0 0
" Red.....	½ sieve	0 0 0 0	Pears, kitchen..	dozen	1 0 2 0
Figs.....	dozen	0 6 1 0	dessert	dozen	1 0 2 0
Filberts	lb.	0 0 0 0	Pine Apples, English	lb.	1 6 2 0
Cobs.....	100 lb.	0 0 0 0	Raspberries	lb.	0 0 0 0
Gooseberries	½ sieve	0 0 0 0	Strawberries	lb.	0 0 0 0

VEGETABLES.

	s. d.	s. d.		s. d.	s. d.
Artichokes.....	dozen	2 0 to 4 0	Lettuces	score	1 0 to 1 6
Asparagus, French	bundle	25 0 30 0	Mushrooms	punnet	1 0 1 6
Beans, Kidney ...	100	1 0 0 0	Mustard & Cress ..	punnet	0 2 0 3
Beet, Red.....	dozen	1 0 2 0	Onions.....	bushel	2 3 2 6
Broccoli.....	bundle	0 9 1 6	Parsley.....	doz. bunches	3 0 4 0
Brussels Sprouts..	½ sieve	1 6 2 0	Parsnips	dozen	1 0 2 0
Cabbage.....	dozen	0 6 1 0	Peas	quart	0 0 0 0
Capsteams.....	100	1 6 2 0	Potatoes.....	cwt.	6 0 7 0
Carrots	bunch	0 4 0 0	" Kidney.....	cwt.	6 0 8 0
Canliflowers.....	dozen	2 0 3 0	Radishes.....	doz. bunches	1 0 0 0
Celery.....	bundle	1 6 2 0	Rhubarb.....	bundle	0 4 0 0
Coleworts.....	doz. bunches	2 0 4 0	Salsafy.....	bundle	1 0 0 0
Cucumbers.....	each	1 6 2 0	Scorzonera	bundle	1 6 0 8
Endive.....	dozen	1 0 2 0	Seakale	basket	1 0 2 0
Fennel.....	bunch	0 3 0 0	Shallots	lb.	0 3 0 0
Garlic	lb.	0 6 0 0	Spinach	bushel	3 0 0 0
Herbs	bunch	0 2 0 0	Tomatoes	lb.	1 6 2 0
Leeks.....	bunch	0 3 0 4	Turnips	bunch	0 2 0 3



POULTRY AND PIGEON CHRONICLE.

INDICATIONS OF FERTILITY OR BARRENNESS OF SOILS.

THIS is, and always will be, a subject of the greatest importance in agriculture, and was deemed of great consequence by the Royal Agricultural Society of England, for in 1844 the Council offered their prize for the best essay upon this subject, and in the Journal of the Society issued in 1845 two essays appeared, both of which treated the subject with great practical intelligence and experience. Since that period chemistry in connection with agriculture has made great progress, having opened up the value of certain productive qualities of land as well as its barrenness, for the rescarches of such gentlemen as Dr. Voelcker, Sir J. B. Lawes, and others have added much to the means of obtaining by analysis the quality of soils. To the young men and those who are students in agriculture it is a most important fact, that irrespective of analysis of soils their productive quality has been characterised to a great extent by the experience given by practical farmers, &c., who judge by the colour, consistency, position, and aspect, as well as the various weeds and plants indigenous to the land, and other peculiarities which have been noted by observant men. Notwithstanding all this practical knowledge the most observant readily admit that they have learned much from the chemical professors in agriculture, and as this is the fact, is it not sufficient to induce the young men to consider the opportunities which they now possess by a combination of practice and theory?

It appears surprising that the natural indications of barrenness and fertility should have been so much neglected by our forefathers. We fear that at an early date knowledge of this subject was deemed unworthy of notice by farmers, and that it was quite sufficient that the most practical men as land agents and valuers, who have had so many opportunities of noticing the indications of the value of land, was sufficient to guide them.

During the past thirty or forty years, and since education has extended amongst all classes of the community, the aspirants for agricultural fame amongst the young farmers and landowners have perceived the value of practice with science in any attempt at successful agriculture. This has induced them generally to acquire a knowledge of the nature and value of land and its capabilities, the ground and basis of which they have made the understanding of the capabilities of the soil by its appearance, called indications of fertility or barrenness. Nor could they have better preceptors than the experienced land valuers and agents, combined with the scientific acquirements of such men as Sir J. B. Lawes, Dr. Voelcker, and others too numerous to mention, but who have for a long period laboured zealously to enlarge the minds of those who were willing to learn by publishing the result of their experiments.

The knowledge extended to agriculturists by botanists has also gone a long way to indicate those plants which, being indigenous to certain soils, show them how to distinguish the character of the land by its herbage, which may be seen at any time during the spring and summer months, and thereby enable them to decide whether the soil is productive or otherwise for certain farm produce. At the present era of agriculture, through the

experience of practical men cleverly laid before them, young men of perseverance and industry can now obtain in a few years that which formerly occupied the attention of a long life in its acquirement. As, however, we have stated facts which are not disputed, we shall turn our attention to those illustrations which are available at present, through the writings of those best informed upon the subject, and in doing so we shall endeavour to give some observations of our own which may clear up some doubtful points.

In speaking of indications of barrenness we will take first the colour of the herbage of pasture land, for this upon infertile land nearly always exhibits a brown or reddish brown colour, as it seldom appears green either in the spring, summer, or winter. Nearly all grass land that produces rough, coarse, and unpalatable grass which the stock refuse, and, unless compelled by actual hunger, will not eat, and has the appearance of half-made hay, may usually be said to be barren. Still we have some exceptions, which we will name in order that persons lacking experience may not be deceived. We refer particularly to some fine pastures in the vale of Aylesbury and certain parts of Leicestershire and Somersetshire, where good grazing pastures have been quite neglected; the bunches or tufts of grass of a coarser sort have been allowed to prevail, and are called tussocks. Now, these at all times give a rough and brown appearance to soils, which may easily be mistaken for indications of barrenness, whereas it chiefly represents bad management and neglect. This can be easily altered by careful arrangements—cutting up root and branch with turf-cutters all objectionable tufts, and burning them for the benefit of the land whereon they grew. Again, in the case of pastures which grow rushes and sedge grass, these undoubtedly in their origin represent a wet soil if not always barren, yet after draining we have found that rushes with running roots just under the surface will remain for many years after the land has been properly drained upon strong clay soils; but those which are termed bunch rushes and grow in tussocks will also exist after draining the land, but may easily be eradicated by the same means as the tussock grasses.

(To be continued.)

WORK ON THE HOME FARM.

Horse Labour.—The time for sowing winter varieties of Wheat is now past; we must therefore consider the comparative advantages of growing spring varieties, or what is called by this name, such as Talavera, and upon those farms on which it has been found to answer it may be tried again. We, however, ignore it entirely, except in some of the western counties where the rainfall is continued longer into the spring, for as a rule in the eastern and south-eastern districts it is much inclined to blight, in which case its fine quality as a milling sample is lost, and the straw likewise has often proved very inferior, in any sort of Wheat which has been injured by blight. There is a variety called April Wheat, which if sown in March, and the land moist enough to vegetate the corn at once, it will be forward enough to give a good yield in any average season, although it is a strong grain and yielding but little flour, usually if sold to the miller making about 6s. per quarter less than the best brown Wheats. It is a bearded sort growing very great crops of straw of a strong wiry nature, and is in consequence more valuable than ordinary growths for various purposes, such as thatching ricks, barns, and other buildings. It is much in favour with stable keepers in towns, and at the prices which straw has been selling at makes it worth more for growing than ordinary Oats. It is, however, the least valuable as a feeding straw. In its growth it is by no means subject to blight, and with a full crop of straw yields a large quantity of grain in favourable seasons. We have been particular in making these statements in order to give the home farmer the opportunity of considering under various conditions which pay best, late Wheat or early-sown good varieties of Oats or Barley.

In deciding upon which is best as a profitable crop, Oats, or Barley, or drege, the soil, climate, and condition of the land must be considered; as a rule, however, on strong cold soils quarters of Oats may be grown instead of sacks of Wheat. On light lands, after roots fed off, we do not approve of Barley, but like the white Victoria Oat, as they yield enormous crops of straw of high feeding value, and they come to harvest ten or twelve days before winter-sown Wheat, which has been a matter of no little consequence in the English and Scotch climate in years gone by, especially as the quality and weight of the grain is usually first-rate. On some cold late soils the new variety of White Tartarian Oat is much approved for admixture with Barley, the straw, too, being very valuable, and is seldom attended with loss by shedding in the field, and is in consequence very valuable for growth on the seacoast and districts where heavy autumn gales prevail. As they ripen late it is preferred to Barley, and can be harvested with little or no damage in almost any season.

Hand Labour.—As the season proceeds this will be more in request. Forking out couch, docks, &c., may still be done before the sheep feed the root crops, and also upon the land which was autumn-ploughed before planting Potatoes, Mangolds, Carrots, &c., as we cannot afford

the delay consequent upon horse labour to clean land before the early vegetable and root crops are seeded for.

BACON AND HAMS.

HOME-CURED bacon and ham are justly held in high repute. The former is relished as a breakfast rasher, while the slice of cold ham is a cheap and wholesome article of diet, of which every home farm should afford an abundant and continuous supply. How to obtain it is a matter of such importance, often but little understood, that a few of the chief details of the process may prove useful to many of your readers.

Famous as York hams undoubtedly are, yet I do not consider it at all an indispensable necessity to have either the large or small Yorkshire pigs to obtain good hams, or the Berkshire or Essex pigs for bacon. If a Berkshire sow can be had easily, by all means have one, cross it with the best breed of the locality, and pigs of a compact chubby frame will be the result. But excellent sows of local breeds, of medium length, level-backed, and with full rounded quarters, may be met with everywhere by the exercise of a little care in selection, and the pigs from such sows always fatten quickly, and are ripe for the butcher in from thirty to thirty-five weeks from the farrowing, when they should weigh that number of stones of 8 lbs., a stone a week, or rather more than 1 lb. a day, being the weight of a well-bred hog of that age if it has been fed judiciously—that is to say, with ordinary food sufficient to maintain a kindly healthy-growing condition for about twenty-two or twenty-four weeks, and with barley, pea, or oatmeal and milk during the remaining six or eight weeks.

Feeding is altogether a relative matter—a question of ways and means rather than a process of weight and measure. “Milk-fed hogs are not to be excelled” is a popular creed in which many good people have unshaken faith, yet last year three porkers fed entirely with boiled potatoes and wash beat three others of the same age fed with milk and pollard. Care, watchfulness, and painstaking are the principal things; a well-fed hog kept in a very cold and dirty sty will not thrive so well as if in a clean warm cosy one. If possible avoid buying any of the food; a well-managed home farm should always have enough arable land to afford an ample supply of corn for all feeding requirements, with the exception of maize—quite an indispensable article of diet for poultry, and good for pigs occasionally.

If very large hams are required the pigs must be kept proportionately longer, but for all ordinary purposes pigs of the age mentioned afford hams of full 20 lbs. weight when cured, and I find hams of this weight preferable to any other.

Two pigs are killed at the same time at intervals of a month, that being the most convenient arrangement for the means of curing the pork here. They are left hanging in the slaughter-house twenty-four hours to cool thoroughly, then they are cut in halves, the heads and hams cut off, and the sides and chaps taken to the pickling tray for salting, 1½ oz. of saltpetre and the same quantity of common soda being mixed with the salt for every 14 lbs. of bacon. Sides of moderate substance are well rubbed and turned in the tray daily for three weeks, or a week longer if very thick, and are then put in separate bags of cotton or thin sacking material for smoking. For the hams we have a special formula, which is so excellent that I give it in full. For uncured hams of 30 lbs. weight 1 lb. common salt, 1½ oz. saltpetre, 1½ oz. bay salt, 1½ oz. shallots pounded, ½ oz. coriander seed, ½ oz. juniper berries bruised, ¼ lb. beef suet, 2 lbs. treacle. A pickle is made of this, and the hams put in it in deep earthen pans, and turned daily for a month, especial care being taken to keep them quite covered with the pickle the whole of the time. They are then put in bags and suspended in the wide farm-house chimneys, where they remain for three months, and are then ready for use. No coal is allowed to be used, oak logs being the staple article of fuel, and oak sawdust being put upon the fires at night. No fir tree sawdust is ever used, as it imparts an unpleasant flavour to the bacon. Modern farm-houses have no chimneys suitable for this purpose, but a separate drying or rather smoking-house need not be expensive, four walls with a chimney wide and high enough for the requisite quantity of bacon being all that is required, a fire of oak sawdust being kept up upon the floor in the centre of the apartment.

More hams than sides of bacon are always wanted. Advantage is taken of this to obtain a supply of lard, all the fat pork being cut into small pieces, boiled and pressed, the liquid fat running off into earthen crocks, and when it is cool the lids are put on, and it is used as required, keeping perfectly sweet and wholesome for a year. This is really the most profitable way of turning the surplus fat to account, for the dealers will not give more than 4s. a stone of 8 lbs. for it offered to them as pork, and there is always a large consumption of lard in such households as the home farm has to supply.—EDWARD LUCKHURST.

POULTRY AND PIGEONS

POULTRY NOTES.

WE have often remarked on the extension of the poultry fancy on the continent. Certain departments of France have long been famous for table poultry, but purity of breeds has been little thought of in that country. The starting of a new weekly paper devoted to the subject of poultry and Pigeons is evidence that at last French breeders are alive to the need of intelligence and care in the cultivation of their stock. The new paper is entitled *Le Poussin*, and is intended to be a somewhat cosmopolitan organ of fanciers. A German article has appeared in one of the earliest numbers, and this is to be followed by articles in English as well as French from the pen of an English fancier.

THE prolonged wet is telling very prejudicially on poultry, especially where the soil is heavy. For one thing, wherever their dusting places are not thoroughly well covered above and raised below they are sure to be flooded, and so become worse than useless. The unfortunate birds, whose nature it is to bask on dry sunny banks, are too often doomed to wade in mud. All that can be done to remedy these discomforts should be carefully attended to. Where the dusting place is gone or wet, dry soil or ashes should be put on the floors of the roosting house, and the birds should all be examined to see if they are plagued with vermin; if so, flour of sulphur or insect-destroying powder should be dusted into their feathers.

WE hear of another pest among poultry, arising, we fancy, from the prolonged rains—viz., a diphtheric affection in the mouth and throat. In its earlier stages cankerous specks are found about the mouth, not unlike the beginnings of canker in young Pigeons. These should at once be touched with caustic, and the complaint may be arrested. In its later stages the diphtheric growth fills up the windpipe and the bird perishes from weakness and inanition. In even slight attacks plump birds will in two days lose all their flesh and condition. We are as a rule strongly averse to stimulating foods; but this is just a case in which we think a little spiced meal is useful. It will tempt a fowl to eat when otherwise it might refuse to do so. The only way to get poultry safely through such maladies is to keep them well fed and very warm. The disease is a severe drain to the system, which can only be borne if extra nutriment is supplied.

SOME time ago the formation of a society for the breeding and exhibition of German Toy Pigeons was announced. It is more than a year since Mr. Morton of Newent, Gloucestershire, invited admirers of these birds to send in their names to him. Rules for the society were forwarded to us, and after the lapse of a year we saw some voting papers for the formal election of divers officers of the said Club. Now it appears to have died its natural though early death, or at least if it exists it conducts its proceedings with much secrecy.

WE understand that the entries for the Hereford Poultry and Pigeon Show to be held to-day (February 15th) closed with nearly eight hundred pens. Considering the prizes offered this is a large number, and confirms the opinion we lately expressed, that such shows just now find much favour in the west of England.

WE have before us the schedule of a Poultry Show to be held at Melton Mowbray on March 8th. There are twenty-one classes for poultry with four prizes in each, and six for Pigeons. The time of year is hardly favourable for the exhibition of birds which ought to be breeding at home.

MANAGERS of shows should for their own sake, as well as that of exhibitors, have every alley well watched, especially in the evenings. We hear that immense trouble has been caused to exhibitors at the late Yeovil Show, as well as to the managers of it, by the changing of several pens of Pigeons, which must have been done by either dishonest or mischievous people.

WE wrote lately about the points of form of Japanese Bantams, though we did not then go into the question of their colour. At the Gloucester Show we remarked a cock of the breed exhibited by Messrs. Eteen of a very unusual colour—viz., golden, with black spangles on the breast. Whether he was a pure Japanese or crossed with some other similar race we could not feel sure.

WE hear that the whole of Mrs. Lane's stock of Houdans, which she has bred and shown with so much success, have passed into the hands of Mr. Wingfield-Stratford of Addington Park, Kent.

THE Columbarian Society in its series of "standards" for fancy Pigeons is about to issue one for Turbits. The Chairman of the Committee deputed to draw it up is Mr. F. Esquilaut, and the Secretary the Rev. W. F. Lumley.—C.

THE POULTRY CLUB.

A MEETING of the Committee of the Poultry Club was held on Friday, February 9th, at the Charing Cross Hotel, at 2 P.M. There were present Mr. S. Lucas (in the chair), the Earl of Winterton, Viscount Grimston; and Messrs. T. W. Anns, R. A. Boissier, A. Comyns, and G. H. Wood.

ANNUAL ACCOUNTS.—The accounts for 1882 were examined and confirmed. They will shortly be published as provided by the rules.

PRIZES FOR TABLE POULTRY.—A proposal that prizes should be offered for table poultry at some leading show this year was made. It was resolved to offer prizes on the following conditions, subject to any alterations which may be made hereafter. 1, The prizes to be competed for in the month of November or December next at some leading show to be hereafter named. 2, The prizes to be of the following amounts—viz., 1st, £5; 2nd, £3; 3rd, £2. 3, The birds to be cockerel and pullet or capon and poulard of some pure breed, or first cross between two pure breeds. In the latter case the breed of both parents to be stated. 4, Price to be limited to £1, Poultry Club to have first option of purchase. 5, The whole or a proportion of birds selected alive as most likely for prizes and commendations to be killed and trussed by a qualified poulterer after being first exhibited alive. 6, The prizes to be finally awarded to the dead poultry.

SHOWS UNDER CLUB RULES.—Some correspondence with the Secretary of the Gosforth Show was read, and a subscription in aid of its funds granted.

NEXT MEETING.—The date of the next meeting was fixed for March 9th at the Charing Cross Hotel, at 2 P.M.—ALEX. COMYNS, *Hon. Sec., 47, Chancery Lane, Feb. 13th, 1883.*

OUR LETTER BOX.

Rye Flour (*Reader*).—We have forwarded the address you have obligingly sent to our correspondent who sought information on this matter.

Roup (*J. P.*).—Your birds have roup. Treat as follows:—Begin with a dose of castor oil, afterwards wash the face and nostrils frequently with Labarraque's solution of chlorinated soda diluted with twice its quantity of water. The house where the birds have been should be thoroughly disinfected. Procure from Mr. Cook, 2, Park Road, West Chislehurst, a packet of his roup powder with directions for its use. We have found this act well. If there are any other symptoms than those you have described write again, and we will advise you as to further treatment. We cannot understand the blindness of the recovered birds. Do you mean that one eye remains closed, or that the sight of one eye is destroyed?

Turkey Cock (*J. P.*).—As the young bird is such a fine one we should certainly advise you to keep him unless the stock have been much interbred already. We do not gather from your letter that this is the case.

Concrete Floor (*Old Subscriber*).—You cannot do better under the circumstances than concrete or asphalt the floor of your fowl house, but you must keep the floor covered at least half an inch deep with sand, ashes, or dry earth.

METEOROLOGICAL OBSERVATIONS.

CAMDEN SQUARE, LONDON.

Lat. 51° 32' 40" N.; Long. 0° 8' 0" W.; Altitude, 111 feet.

DATE.	9 A.M.					IN THE DAY.				Rain.
	Barometer at 29.3 and Sea Level.	Hygrometer.		Direction of Wind.	Temp. of Soil at 1 foot.	Shade Temperature.		Radiation Temperature.		
		Dry.	Wet.			Max.	Min.	In sun.	On grass.	
1883.										
February.	Inches.	deg.	deg.		deg.	deg.	deg.	deg.	deg.	In.
Sun. 4	30.052	38.8	33.5	S.W.	39.3	49.4	33.2	79.2	31.7	—
Mon. 5	30.238	41.6	40.7	S.	39.5	49.6	33.3	74.8	31.9	—
Tues. 6	30.121	34.5	34.2	E.	39.4	44.6	32.2	64.7	25.6	0.184
Wed. 7	29.865	38.7	38.0	S.S.W.	38.7	41.9	33.5	43.3	23.1	0.179
Thurs. 8	29.620	43.2	42.8	S.E.	39.2	53.3	37.9	56.3	35.3	0.690
Friday 9	29.795	39.5	39.5	W.	41.0	52.4	37.2	74.9	33.2	0.268
Satur. 10	29.543	48.1	43.4	S.W.	41.3	49.4	33.8	50.2	35.6	0.553
	29.893	40.6	39.7		39.8	48.7	36.3	63.3	32.3	1.784

REMARKS.

4th.—Fine, bright, and calm throughout.
 5th.—Dull at first; fine bright day.
 6th.—Fine throughout.
 7th.—Rain early; cold damp day.
 8th.—Dull, with rain; heavy at night.
 9th.—Rain at first; fine bright day.
 10th.—Stormy and wet; fine and starlight 7 P.M. till midnight, afterwards heavy rain.

A mild week, the early part fine, the latter windy and very wet, the rainfall of the last three days being alone more than usually falls in the whole month.—G. J. SYMONS.



22nd	TH	Royal Society at 4.30 P.M.
23rd	F	Quekett Club at 8 P.M.
24th	S	Royal Botanic Society at 3.45 P.M.
25th	SUN	3RD SUNDAY IN LENT.
26th	M	
27th	TU	
28th	W	Society of Arts at 8 P.M.

DESTROYING INSECTS ON FRUIT TREES.

DUBTLESS one of the greatest among the gardener's many great troubles is the plague of insects which come every season as regularly as the seasons themselves. I should just like my readers to recall to mind how they have battled in former springs and summers with the hosts of insects on their outdoor fruit trees—how the shoots of the Cherries were covered with black aphides, the Peaches and Plums with green fly in variety, and the Pears with quite a collection of entomological curiosities! Just picture them at the present time, and consider whether you would like to have them that way again when every minute is doubly engaged, and you are obliged for self-protection to shut your eyes to some of the evils around you.

No insects are visible now, and some of our old-fashioned friends will tell us that they will not come till the east wind brings them. We have it on the highest authority that the east wind was once guilty of such things; but that was a long time ago, and although the wind in the east still is said to be "good for neither man nor beast," the insects are sure to come be the wind where it will, unless we take the trouble to prevent them.

Perhaps the most detestable of insects on our outdoor fruit trees is the black aphid which infests our Cherries. It seems to come so suddenly, and squeeze, syringe, and dip as you will, nothing will prevent disfigurement of the trees nor partial loss of the crop. As I am more interested in the movements of my enemies than those of my friends, I have watched this pest rather closely, and can always find it in the form of the tiniest black spots on a sunny day just when the bloom buds are about one-third expanded. It is hardly larger than the point of a pin, and to the naked eye cannot be seen to be alive; but leave it a few days, and it will not only be seen to be alive itself but to have a very flourishing family. It is quite possible to destroy it when the small black specks are first seen, and at any time before the bloom buds are more than half expanded; but the surest and most economical plan is to destroy it before it can be seen: and with wall trees, at least, this is a very easy matter, as I have proved for two successive seasons.

Petroleum is cheap enough. It is certain death to all insects when used in a thorough-going manner, and before the buds are much expanded it is perfectly harmless to the trees in comparatively strong doses. My fruit walls are very old and full of holes, so that

there is plenty of harbour for insects; but by thoroughly syringing them all round twice in early spring, with an interval of a week or ten days, and repeating the dose in the autumn after the leaves are hardened, insects are comparatively no trouble.

The petroleum mixture for syringing the walls and trees before the buds burst, and also after the leaves are hardened in autumn, is used at the rate of 2 ozs., or about an ordinary-sized wineglassful, to the gallon of water. The method of using it has been often described in this Journal by various writers, but as new readers are being constantly enlisted, and the inquiries on this subject are still very numerous, it may be worth while to repeat it here in the plainest language at my command.

The oil is not soluble in water, and will float on the top, consequently when applying the contents of the vessel to the trees we may draw one syringeful entirely of water and the next entirely of oil, the effects of which would be very disastrous. But although the oil is not soluble in water we may, by keeping it constantly agitated, divide it into very small particles, and distribute it equally through the water. Applied in this condition at the proper strength the mixture is harmless to the trees and destructive to the insects. Where a large space of wall has to be operated on it is well to have two men with two syringes, one to keep drawing from the vessel and returning the contents of his syringe with as much force as possible, the other to keep on applying a very gentle spray, light as dew itself, to every portion of the trees and wall. The lighter the application the greater will be the quantity of liquid held by the trees, in the same way as they hold much more moisture from dew than they do from heavy rain. When only a small space has to be done with one pair of hands, one syringeful must go into the pot and one on to the tree alternately. The mixture is used indiscriminately on all kinds of fruit trees, and no syringing with clear water is practised at any time of the year.—WM. TAYLOR.

NOTWITHSTANDING all the remedies that are provided insects appear to cause as much trouble as ever both to fruit trees and flowers during the summer months, and insecticides are brought into disrepute if they do not clear off all the pests at once and leave the trees and plants clean and healthy. The truth is that nearly all insecticides will accomplish their purpose. It is certain that tobacco water, quassia water, Gishurst compound, nicotine soap, and petroleum will, when properly mixed and applied, destroy insects; but it is not fair to any insecticide to allow the pests to increase and cover the shoots and foliage in crowds before the remedy is applied, as then in many cases the insects protect each other.

The true course to pursue is to endeavour by every possible means to prevent the attacks of insects, and this may be in a great measure done by syringing fruit trees just before the blossoms expand and the wood buds are starting into growth. If no insects are visible then, so much the better; still they are certainly not far off, and preventive measures should be adopted.

Petroleum has become a favourite remedy with many cultivators, but there is a difficulty in mixing it with water. My employer, who does not occupy an obscure position in the scientific world, has tested carefully every method that has been advanced of incorporating

the oil and water, and has found the following plan to answer admirably. Four ounces of soft soap and a lump of washing soda the size of a walnut are dissolved in a gallon of boiling water; then 4 ozs. of petroleum is well stirred in, three more gallons of rain water added, stirred again, and the four gallons stored in a stone jug. As many jugs are filled as will contain the season's supply. It is used just as poured from the jugs, neither shaking nor alternate syringings into the pot and on the trees being adopted, because not needed.

For applying the insecticide to plants and Roses a spray-diffuser is used, which is better than a syringe, and less of the solution is wasted. For convenience of filling the reservoir of the diffuser a quantity of the mixture is kept in clean champagne bottles and stood on the shelf of the garden house, and, as can be plainly seen through the glass, there is no curdling; but the liquid is perfectly uniform throughout, and the oil does not rise to the surface. It has a thin, pale, milky appearance, destroys insects, and neither injures nor stains the foliage to which it is applied. This method was published in the *Journal of Horticulture* a few years ago, and is submitted as the best mode of preparing petroleum for the purpose in question.—A GARDENER.

ODONTOGLOSSUM ALEXANDRÆ.

(Continued from page 44.)

POTTING is best done just after the plants have commenced growth early in the spring. We generally commence potting towards the end of February, but leave those which are not ready for a week or ten days longer. I do not advocate large pots for *Odontoglossums*, and unless the plants have rooted abundantly they are again placed in the same size pots after the old material is carefully removed from their roots. When larger pots have to be used I give the smallest shift possible. The pots should be thoroughly clean, and be one-third filled with clean potsherds, the larger at the bottom and the smaller over them, and then covered with a layer of sphagnum moss. The plants should be well raised above the rim of the pots, and the compost pressed as firmly as possible and close to the base of the pseudo-bulbs, so that the roots when emitted from the new growths will enter it at once.

I find that the roots grow more freely amongst the fibre from which the small particles have been shaken than when the peat is used in lumps, however good it may be, in which state it is more liable to become sour from the enormous quantities of water these plants require. When the fibre only is used it will last a greater length of time, and there is no occasion to repot the plants annually unless they require larger pots. The sphagnum must be sorted, and all grass and rubbish removed, the finest green portions being selected, placed in pans, and kept well watered. These are used for top-dressing whole, as I think they commence growing more quickly and better than when cut very small. Charcoal is broken moderately fine, and about a seventh mixed with the peat fibre and sphagnum, which are used in nearly equal proportions, allowing the latter to predominate. Until two years ago I used a much greater per-centage of peat and less sphagnum, but the plants did not succeed so well as they have done since more moss was employed.

The supply of water is important—not that they require the care necessary for hardwooded Heaths, but they must never in any stage suffer from an insufficiency. Many fail to grow these plants satisfactorily through keeping them too dry and in too dry an atmosphere. During the summer while they are in active growth, if in moderately small pots and in the open compost recommended, the plants will need a good soaking of water every morning. The bed upon which they stand and every portion of the house should be well moistened several times during the day, and in the afternoon the plants should be lightly syringed. There need be no fear of the young

growths damping if the house is freely ventilated night and day. In winter so much water will not be needed. The object during summer from the time the plants are potted should be to encourage the moss to grow, which will require clipping once or twice if the plants are properly treated.

Ventilate freely on all favourable occasions night and day, as upon this depends the sturdy compact growth of the plants and the strength of the flower spikes. During the whole of the summer from the end of the month of May until September no fire heat will be needed during the day; indeed, it is often difficult to keep the temperature sufficiently low. If drying winds prevail outside I prefer that the temperature rise considerably, rather than allow the plants to be dried quickly by admitting air. There are several opinions regarding the temperature necessary for these plants during the winter months. Some merely exclude frost, while others consider 40° to 45° ample. They will succeed in these temperatures, but it is questionable if they make such rapid progress as they do when kept warmer. I always endeavour to keep the house as near 50° as possible. In frosty weather the temperature is allowed to fall a little, and on mild nights it often rises to 55°. One thing is strikingly evident—by keeping them moderately warm in winter, with ventilation day and night when the weather will permit, the plants start earlier into growth in spring, and have in consequence a longer season to make their growth and solidify their pseudo-bulbs, which is the secret of obtaining large spikes and fine flowers. The plants will be benefited by being arranged moderately near the glass, and a low house is much the best for them where they can stand upon some moisture-holding material, such as fine gravel.

Shading is necessary, but moveable blinds should be employed, so that they can be drawn up during the night and on dull sunless days. The material used should be light, so as to break the strong rays of the sun but not darken the house. Although these plants enjoy shade in bright weather, the inexperienced often err in shading too much, and the foliage becomes long, with scarcely sufficient strength to support itself, instead of being dwarf, stout, and sturdy.

The insects that attack *Odontoglossum Alexandræ* are various, and the slugs that are imported with the moss are perhaps the worst enemy they have. These must be sought at night after the plants have been repotted or any fresh moss used. We are generally troubled with these for a time in spring, but soon destroy them by diligent search. Woodlice are very destructive amongst the newly formed roots and young growths. Constant applications of water they do not like, and will soon remove to some drier place. A small yellow thrips is also troublesome, and can be kept down by watering the plants over the foliage and sponging them with a weak solution of nicotine soap. This thrips generally attacks the young growths in the centre or well down in the leaves, whence it is impossible to remove them with the sponge. A little of the mixture applied to these parts with a small camel's-hair brush will soon destroy them. Tobacco powder is also invaluable for this purpose. A small green fly will also establish itself upon the plants, especially during the winter when the flower spikes are appearing, but it can be removed by sponging. Fumigation with tobacco should not be attempted, as the plants will soon be injured by its application.—W. BARDNEY.

GARDEN STRUCTURES.

IN reply to Mr. B. W. Warhurst's remarks upon this subject (page 88), I will first state the reason why, in my opinion, the range of houses referred to in my article (page 21) proved a failure so far as plant-growing was concerned. It may be premised that the range was erected primarily for supplying cut flowers during the winter season and for growing decorative plants for rooms. Some of the houses were narrow spans, some of them lean-to structures. Their sides to the level of the plant stages were of brick; above that to the eaves, which were 6 feet from the ground level, were fixed glass sashes, the ventilation being from the ridge of the roof alone. Fancy a gardener having to flower *Pelargoniums* through the winter in such structures, or to produce *Lily of the Valley* therefrom in January or earlier. Had these structures been erected to

further the production of thrips and red spider no doubt the object would have been accomplished.

With regard to the kind of structure I would recommend for the cultivation of commonly-grown plants, I can only repeat that "the most useful plant structures will be found to be low flat buildings 12 or 13 feet in width, with a central path and two side beds on benches." Anyone who has had experience with structures of a low pitch of roof for plant-growing as against those that are more or less steep in the pitch, will agree that the low-angled form is the best in all ways. Here are details of a structure in course of erection here now, and intended for the production of Tea Roses during the winter months. At the same time the number of plants which would fail to succeed in such a house are very few indeed, while Melons, Cucumbers, and Tomatoes would do equally well. It is partially sunk beneath the ground level, and in some other ways has been slightly modified to suit its environments. Its outside width is 12 feet 9 inches; the side walls are of 9-inch brickwork up to 28 inches below the eaves; at that height a 4½-inch wall is carried up 15 inches, the remaining 13 inches being made up of ventilators and necessary fittings, the ventilators themselves being made of boards. The roof is supported on 2-inch tee iron rafters placed 7 feet apart; those are battened into stones built into the side walls. At 2 feet from the ridge on each side of the roof the rafters are tied together with pieces of 2-inch tee iron, to which they are secured with bolt and nut. The outer ends of the end cross-pieces are battened into the end gables, which are of 9-inch brickwork. In addition to tying the rafters together, these cross-pieces also act as supports to the roof in an immediate manner, each "astragal" being screwed to them at the point of intersection. Rigidity is secured by supporting each rafter on each side with a bar of 1-inch tubular iron secured at one end to a stone at the side of the pathway wall, at the other being bolted to the rafter it supports. The roof is formed of a continuous sash on each side, the top side of the two sashes meet and form the ridge. These are 4 inches wide by 2 inches thick. The bottom plate of each sash is 4½ inches by 1½ inch. The astragals are each 2 inches deep by 1½ inch wide, every sixth one being 2 inches square. This lies on the iron rafter, to which it is secured with screw nails. The glass is in squares of 19 by 13 inches, bedded in putty, and each held down by two triangular pieces of zinc. A clear space of three-sixteenths of an inch is left between the lowermost pane and the sill on which it rests: this allows much condensed water to escape outwards. No ventilation is supplied from the ridge. The inside of the structure is furnished with a central pathway 27 inches wide, the floor being about 7 feet from the ridge. Its sides are formed of 4½-inch walls 3 feet high, these with the side walls forming a bed 4 feet wide for staging purposes. Heating is effected by three rows of 4-inch piping round the sides of the house, the uppermost pipe being about level with the bottom of the ventilators. A tank to hold 250 gallons of water is constructed at one corner by making one of its ends out of a portion of the gable, one of its side out of a portion of the outside wall, the other side being a portion of one of the pathway walls, the second end being built across the bed for that purpose. The bottom is lined with bricks, and the entire inside of the tank covered with cement an inch in thickness. The doorway is at one end of the building. Coal ashes level with the lowermost pipe form the bed on which plants are to be staged. The angle of the roof is 16°. All the material employed, with the exception of the woodwork, is practically indestructible.

Modifications in the internal arrangements of this pit would make it suitable for growing greenhouse plants, for cool Orchids, for decorative Ferns, and other purposes. We are constantly seeing comparatively expensive structures attached to villa residences, which, instead of being a saving to their owners, are on the contrary a continual expense to keep furnished with fresh plants. The writer of the articles on "A Suburban Garden" seems to have learnt the difference between a house built for "show" and one built to produce flowers. The remarks on this subject in these articles are worthy the attention of gardeners as well as amateurs.

As to fruit houses, what Mr. Warhurst states regarding

the pitch of Peach houses as determined by the majority of gardeners, is surely incorrect. "A steep pitch of 50° to 60°" might be recommended in the case of "wall-cases," but for a Peach house proper either 12 or 18 feet in width I can hardly imagine to be the fact. A pitch of 35° I would consider a fair one, 40° at the outside. As to the height of fronts, we have a new Peach house here with a 6-foot front, specially built so; it allows for the back wall being covered with trees, and a trellis in front as well, while there is space in the centre for plant-growing. For ordinary purposes, however, a front of 4 feet would be more suitable. As to the height of back walls, they would be a serious item were roofs of 60° angle a necessity. In practice, however, such an angle is not required, indeed would be otherwise than beneficial were houses thus constructed. I may, however, point out a system, the best example of which may be seen at Drumlanrig, whereby walls may be heightened cheaply. This object is gained by placing the top ventilators, not on the top of the house, but between the ridge and the wall when that happens to be too low for the size of house to be constructed.

Flat-roofed houses have this disadvantage compared with those of a steep pitch—the former in damp weather do not throw water off the roof so thoroughly as do the latter, which is against the lasting qualities of the erection. They have, however, the compensating advantages of being stronger, requiring less material in their construction, and are consequently cheaper, and suit plants better than those of a steep pitch. The examples given by Mr. Warhurst would lead us to believe that there is a prevailing ignorance amongst gardeners concerning a part of their daily work which reflects on us as a class in a very uncomplimentary manner. This is a question particularly worthy the attention of young men, who, as a rule, have advantages during the period before they obtain head places of obtaining a fair knowledge of the best kinds of structures for different kinds of plants.—R. P. B.

THE CHRYSANTHEMUM ELECTION.

AS a lover of the Chrysanthemum accept my best thanks for the very spirited manner in which you have carried through the election of the incurved varieties. Such things are not undertaken without great cost and labour, but I think it worth all the trouble, for it settles a long-disputed point. I must confess I was surprised in looking through the returns at the result of the election.

Queen of England I should have thought good enough to have headed the poll, and two others that are in the second twelve good enough for the first, but the majority of electors think differently, and I consider the selection excellent. I hope we shall next have an election of the Japanese varieties, for I think the returns of these will be more interesting than the incurved. Being, comparatively speaking, new compared with the incurved, it is often very perplexing to those who intend growing a few to obtain a reliable list of the best, as writers seldom recommend the same varieties. I shall be very happy to assist.—C. WARING, *Prince's Park, Liverpool*.

I WAS extremely pleased to see the very satisfactory result of the Chrysanthemum election. It cannot fail to be of much service to all interested, and still more to those who are seeking information relative to this deservedly popular flower. I notice, however, that Beverley and White Beverley are registered as two varieties, whereas they are the same. I elected White Beverley in the second twelve as "Beverley," which I believe is the original name. If we add the votes accorded to Beverley (10) to those of White Beverley (21) it will place this fine variety in the first twenty-four, a position it well deserves. I am also of opinion that the comparatively large number of first-class votes accorded to Mr. Howe were similarly intended for John Salter, which would also result in placing that well-known variety in a more prominent position.—A. R. COX, *Elm Hall, Wavertree, Liverpool*.

I BEG to draw your attention to the result of the polling for the best forty-eight Chrysanthemums. White Beverley stands at No. 30 on the list, with eight first-class votes and thirteen second-class votes—total twenty-one. Beverley stands at No. 47 on the list, with ten second-class votes. As an old grower I do not know any difference between White Beverley and Beverley as usually called. If identical, which I believe them to be, the ten second-

class votes of Beverley should go to White Beverley, bringing that variety up to twenty-three second-class votes added to the eight first-class ditto—total thirty-one votes, displacing Mr. G. Glenny and Princess Beatrice.—THOS. HOBBS, *Lower Easton, Bristol.*

THAT the election of incurved Chrysanthemums, as far as the first twenty-four varieties are concerned, is a decided success very few will dispute, and that, considering there is this number of distinct sorts of nearly equal merit, it was to be expected that there would be some little difference of opinion in selecting the best twelve. Yet the selection of any twelve does not discard many of the others from being of equal merit, though they have been placed with second honours. Slightly different tastes in arrangement of colours, &c., have no doubt had much to do with the result of the election, as, for instance, in respect to my own ideas. I am of opinion that white being the principal colour, there should be at least three whites in the first twelve. This opinion I find lost me a point. Then, again, we are at a loss to select the best bronze. Some, like myself, would prefer Bronze Jardin for its size and substance, others prefer Barbara for its fine build. So that, looking at these little differences in this light, there is a remarkable unanimous agreement among those who really know anything about incurved Chrysanthemums; and no one knows more than those who have to cater for the growers what the value of such an election is, for many of the lists given from time to time by correspondents in the various gardening papers are anything but reliable. I cannot see why a florist should be obliged to keep two hundred incurved varieties when a hundred would suffice.

Though the success of the first two selections is all that could be desired, I think many will agree with me that the remaining selections are far from being satisfactory. The fact is there are numbers of varieties scattered among a multitude of growers who think none like their own. They at once suppose the few they possess are the best to be had. The number of names given to make up the remaining twenty-four (and I understand that several of them have been put down for the first selection) is marvellous. We are told there are 156 sorts mentioned to make a selection of forty-eight. Many of these sorts are altogether forgotten or else never heard of; some are little larger than Pompons, others are purely reflexed varieties, as Hermione and Countess of Granville.

However, we have a list of sixty-two names enumerated. In the first place we must look at the various synonyms, and see how materially these alter the list. For instance, Miss Mary Morgan has twelve votes, Pink Perfection has nine; these have to be added together, and the one variety, for such they are, finds its proper place. White Beverley, and Beverley too—surely these should be added. Next we find Emily Dale with sixteen and Golden Queen with twenty. These may or may not be exactly identical, yet I venture to say most electors have treated them as alike, so that the one variety loses its position through being divided. Again, Mr. Howe and John Salter are certainly of equal substance and merit; in fact they are so much alike that they cannot be well placed in the same stand of twenty-four, yet look at their positions—John Salter, fifty-two votes; Mr. Howe, fourteen. Angelina surely deserves a better position. I consider it a decided acquisition for its colour, whereas we could dispense with its parent, Lady Slade, for colour, and yet we find thirty-two points' difference. I can only put these (what I would term irregularities) in the list, either from the varieties being divided by synonyms, or else, as in the case of Angelina, not sufficiently well known.

There are a few varieties which well deserve a place of honour which seem to have been quite lost sight of, among which I would mention Album formosum, Lutcum formosum, Rev. J. Dix, James Laing, and Hercules. They are mentioned among the sundries, but all have a place in forty-eight.

In conclusion, I think we have to thank the Editors for their valued labours in bringing about such an election, which will no doubt induce criticism from others besides myself, which will all tend to the mutual benefit of the many lovers of these beautiful flowers.—N. DAVIS, *Camberwell.*

SPRING FLOWERS.—Our Hellebores are beautiful now; Daphne Mezereum is also showing its pretty flowers. That charming winter flowerer Erica carnea, often wrongly called Erica mediterranea, will soon be in full beauty; it makes a fine edging in the spring garden. Winter Aconites (*Eranthis hyemalis*) are now in bloom. Snowdrops are opening their flowers. Arabis alba is showing its beautiful white flowers. The double Daisies (*Bellis perennis plena*) are advancing. Jasminum nudiflorum is always beautiful, and Forsythia

viridissima is producing its yellow flowers. Myosotis dissitiflora is blooming, and soon we shall have others to follow.—VERNA.

WATERING PLANTS.

I HAVE read with interest Mr. W. Taylor's article on this subject. Most gardeners will agree with him on many points; but I expect many like myself will pause at one of his paragraphs, and that is where he says—"Were I able to attend to a houseful of plants myself I would have the pots both glazed and without a hole for drainage." I was very much surprised on reading it, as he is so particular about drainage for his Vines. I have often heard it mentioned that not one young gardener in a hundred knows how to water a plant; and I have never seen anyone so particular in watering plants as my father. I have often heard him say that when he waters a plant he liked to always see the water pass freely away through the drainage, and I expect he has grown as good Ericas and Lisianthus Russellianus as any man in the country. I mention these plants as they require careful watering to keep them in good health. Mr. Taylor also mentions "that he has frequently with advantage corked the bottom of a pot after it had become full of roots." Has he corked up the bottom of a pot from the first of a plant's existence? as after it had become full of roots it would not be likely to suffer so much; or if the pot was porous (and not glazed) it may evaporate through the pot. I have heard growers of delicate Heaths say that during the winter months they rubbed the sides of the pots to see if there was moisture in the soil. If the pot became damp it was a sign there was, if not it was dry; but of course the pots used were very porous.—A. YOUNG.

CYPRIPEDIUMS.

(Continued from page 118.)

GREEN-LEAVED SPECIES.—Next in interest to *C. Spicerianum*, which has already been referred to, is *C. Stoneanum*, one of the most handsome in the whole genus, and is more frequently seen under the name *C. Stonei*; but the former termination is, I believe, the correct one, as the plant was named in honour of Mr. Stone, gardener to Mr. J. Day of Tottenham, who neither introduced nor raised it. The species is a native of Borneo, and was sent to England from Sarawak about thirty years ago, first passing into the hands of Messrs. H. Low & Co., and thence to Mr. J. Day, by whose gardener it, amongst many other Orchids, was exceedingly well cultivated. For some years it continued scarce, but fresh importations soon reduced the price, and plants of moderate size can now be purchased at most establishments for half a guinea, a comparatively small price for such a beautiful Orchid. It has narrow green leaves and spikes of two to four flowers, the sepals of which are white, the dorsal sepal being broad, somewhat heart-shaped, and streaked on the back with purple. The petals in the ordinary form are narrow, yellowish, with purple spots, and the lip, which is of good size and finely formed, is bright shining rosy purple veined with a darker shade. This, the original type, is, however, far surpassed by the magnificent variety *platytanium*, the broad-petaled form of *C. Stoneanum*, which is perhaps the most handsome of the genus, as it is unquestionably the most valuable. It first flowered in Mr. J. Day's collection sixteen years since, and was probably received with plants of the ordinary form, but when its flowers were produced it created quite a sensation amongst Orchid growers. It is chiefly distinguished from the species by its much broader petals, which are beautifully spotted with dark purple, the dorsal sepal being also finely streaked with purple. There are few plants of this variety in cultivation, and it will doubtlessly continue scarce for some time yet, though every effort will be made to increase so valuable a plant. When Mr. Day's Orchids were sold in 1881 two specimens of this variety were included, one of which was purchased by Sir Trevor Lawrence for 140 guineas, and the other, I believe, by a London nurseryman for 20 guineas less. Neither of these were of great size, the last mentioned only having two shoots and seven leaves; and yet the purchasers did not obtain these prizes without experiencing sharp competition, as the prices indicate, and that given for the first plant is said to be by far the highest sum that has ever been paid for a single Orchid. It has now enriched the Burford Lodge collection, and will always possess an historical interest, even when other plants of the same variety shall be readily obtainable for as many shillings as that cost pounds.

Several other varieties of *C. Stoneanum* are seen in collections which greatly surpass the common form in size of flower and richness of colour, but none equals that described above. One of the largest specimens and the best variety that I have seen is that in Mrs. Torr's collection at Garbrand Hall, Ewell, which has been

shown by Mr. Child on several occasions at the Royal Botanic Society's shows, Regent's Park, and at the Royal Horticultural Society's exhibitions. On some occasions I have seen it with two dozen flowers, or four to each of the five spikes. A high price has been refused for this plant.

Nearly related to *C. Stoneanum* is another attractive species—*C. laevigatum*, but they are, however, readily distinguished. The latter has flowers similar in shape to *C. Stoneanum*, the dorsal sepal being broad and heart-shaped, white or yellowish, but it is regularly streaked with purple on the front surface instead of the back, the petals being narrow, 5 to 6 inches long, pale yellow with heavy marginal spots of purple, and the lip is also of a yellowish hue. When well grown this is scarcely less attractive than *C. Stoneanum*, and like that it requires a high temperature to succeed with it. Plants were first introduced by Mr. J. G. Veitch, who found it in the Phillipine Islands, and particularly abundant on the coast of one small island, where it was growing in large masses upon the roots of *Vanda Batemanni*.

C. Lowii is one of the oldest species of the green-leaved group,



Fig. 44.—*Cypripedium Lowii*.

having made its appearance in England in 1847, when it was introduced from its native home, Borneo. Though less beautiful than the two preceding, it possesses attractions of no mean order, and is included in most large collections. The accompanying woodcut (fig. 44) shows the form of the flowers very faithfully, and one of the chief distinguishing characters, the spatulate form of the petals, will be at once noticed. These are narrow and greenish yellow at the base spotted with yellow, and gradually widen to the tip, which is suffused with a rosy tinge; the lip is purplish green, the dorsal sepal being also greenish and purple at the base. This is a free-growing species, but it never flowers so abundantly as it is said to do in its native home, where plants have been observed bearing spikes of six and seven flowers each.

C. villosum can only be considered to rank next to *C. insigne* as a useful garden plant that is easily grown and flowers freely. This fine plant is a native of India, being found in Moulmein at considerable elevations, usually upwards of 4000 feet above sea level, and has been well known in cultivation for ten years or more. It is of free growth, and is remarkable for the length of time its flowers last in good condition either cut or on the plant. Fine specimens are readily obtained, and it is one of the chief favourites for exhibition, as it bears transit well, and a plant will often continue in flower throughout April and May. The blooms are large, 5 or 6 inches in diameter, the sepals and petals similar in colour, which is very peculiar—a bright yellowish brown with

a distinct purplish tinge, the lip being also brown, and the whole surface of the flower has a shining appearance as if it had been polished. This is often seen at exhibitions, and some of the finest examples in cultivation are those in Mr. B. S. Williams' nursery, Upper Holloway, where amongst many other useful Orchids they are admirably grown.

There is one member of the genus which scarcely needs describing, so widely is it known and so generally is it cultivated—namely, *C. insigne*, and where one Orchid only is grown this is nearly certain to be the favoured selection. Whether in Orchid houses proper, stoves, vineries, or even greenhouses, this plant seems to thrive nearly equally well if we except the last mentioned, though I have occasionally seen healthy plants in as low a temperature as that. In a vinery, however, the plant succeeds admirably, and this is a great advantage where there is no special accommodation for Orchids. However, I would recommend those doubtful respecting the culture of this *Cypripedium* to peruse the concise notes upon the subject by Mr. W. Bardney, page 111 of this Journal, February 12th, 1880.

Several varieties of this species have made their appearance, but undoubtedly the best is *C. insigne Maulei*, which has a more highly coloured flower as regards the petals and lip, the dorsal sepal being large, and the upper half is pure white. *C. insigne Chantinii* is very similar to the above, and indeed in many cases plants under the two names are identical; but I have seen a variety, said to be the true one, which differs in the growth and foliage from *Maulei*. The species is one of the oldest of the exotic *Cypripediums*, exclusive of some American species which were introduced at the close of last century. *C. insigne* and *C. venustum* are the only two Asiatic species mentioned in Sweet's "Hortus Britannicus" (1827), the latter having been obtained in 1816, and the other in 1819, both having been introduced through Dr. Wallich. The earliest figure I have seen is in the "Botanical Magazine" for 1836 (fig. 3412), which represents a flower of good size, but with much more green in it than we ever see it now.

In my previous notes upon the Marble-leaved *Cypripediums* the charming little species *C. niveum* was inadvertently omitted. It should have been named with *C. concolor*, as they are alike in habit and form of the flowers. The leaves are prettily spotted, the flowers being very neat in form, with ovate or elliptical sepals and petals, nearly equal in size and form, soft white, the petals dotted with crimson near the base, and the sepals stained with a similar tint on the back. The lip is egg-shaped and pure white. It is a native of some small islands between Singapore and Borneo, whence it was imported about twelve years since by Mr. W. Bull, and it has also been found on the coast of Siam. An excellent figure of the species was given in this Journal, page 339, May 11, 1871.—L. CASTLE.

(To be continued.)

POTATOES FOR TABLE AND MARKET.

■ In the following notes the figures 1, 2, and 3 indicate first early, second early, and late varieties; the months the time of planting; and the asterisks those varieties that are considered the best for market purposes by the respective cultivators.

BEDFORDSHIRE.—1. First week in March. *Hammersmith Kidney, Old Ashleaf, and Veitch's Improved Ashleaf. Soil.—Heavy. 2. Middle or end of March. *Myatt's Prolific, Schoolmaster, and *Suttons' King. Soil.—Heavy. 3. April. *Scotch Champion, Magnum Bonum, *Dunbar Regent, and Paterson's Victoria. Soil.—Very heavy. Manures and Application.—Stable manure from old hotbeds for early garden Potatoes. Farmyard and Odams' manure for field Potatoes. Ground dug for garden planting; ploughed for field planting.—CHARLES BUTTERS, *Luton Hoo Park Gardens*.

BERKSHIRE.—1. February and March. *Suttons' or Rivers' Ashleaf (equally good), Suttons' First and Best, Early Border, Fillbasket. I tried a seedling raised by Mr. Fenn, who called it Sulhampstead Abbots; it will be sent out next year by Messrs. Sutton. It proved one of the finest earlies I ever grew. Soil.—I always select the driest and lightest borders, which are made lighter with the soil or manure added in the drills thickly. 2. March. Reading Russet, *Lady Truscott, *Fiftyfold, Suttons' Early Regent. Soil.—This is made to a medium soil, although naturally heavy, resting on strong clay. All soils of a light nature are brought to the Potato quarters, or we could not grow Potatoes here, it being so very stiff. 3. March and April. *Magnum Bonum, *Reading Hero, *Scotch Champion (for field), Paterson's Victoria. Soil.—The same as the preceding. Manures and Application.—Old Mushroom beds and leaf soil with soot and salt added. The manure is placed in drills a foot wide, both under and on the sets, and placed thickly; for by giving plenty of room to the sets it is almost impossible to overmanure with the materials as stated above. Salt and soot are used according to the quantity of leaf soil and Mushroom-bed material. General Cultural Remarks.—All Potato ground where possible is dug

up roughly early in the autumn, no manure being then added. In the spring, when planting time comes, it is again dug and planted as the work proceeds. The sets, according to the kind or height, are given plenty of room, so that they are never crowded. Dwarf kinds are planted 26 inches from row to row, 15 inches apart in the row; medium growers are 30 inches from row to row, 18 inches in the row; tall kinds, such as *Magnum Bonum* and *Reading Hero*, 3 feet apart each way. I generally plant the sets not more than 4 inches under the soil, but earth up well; the last time one man follows another, and presses the soil up well to the stems with his hands. I have tried many kinds of Potatoes, and for seven years have had most of new kinds as they have been offered to the public, and in every kind tried have found the manure I name to answer the best, but so much would not answer on lighter soils and in dry weather. I must also say that for quality those raised by Mr. Fenn of late years are the finest, excepting the *Ashleaf* section. I never plant sets with more than two eyes, and for exhibition only one.—CHARLES LOTT, *Wokefield Park, Mortimer*.

1. First week in February. *Early Handsworth*, **Rivers' Royal Ashleaf*, **Veitch's Ashleaf*, *Myatt's Ashleaf*. Soil.—Light. 2. Third week in February. *Suttons' Woodstock Kidney*, **Suttons' Fiftyfold*, **Suttons' Reading Russet*, *Suttons' Early Border*. Soil.—Light. 3. First week in March. *Paterson's Victoria*, **Suttons' Reading Hero*, *Magnum Bonum*, **Scotch Champion*. Soil.—Light. Cultural Remarks.—Garden Potatoes.—We lightly manure our Potato land in the autumn and ridge it, fork it over in February, and plant with a pin, allowing 3 feet from each row and 2 feet from each set. Field Late Potatoes.—Field Potato land is dunged in the autumn, about eight loads to the acre, ploughed early in the autumn, and again ploughed in the spring the reverse way, and well harrowed when the land is dry enough. Distance between the rows 2 feet 6 inches; 1 foot 6 inches between the sets.—WILLIAM MEADS, *Beckett Park*.

1. Fourth week in March. **Kentish or Mona's Pride*, *Myatt's Ashleaf*. Soil.—A medium soil will suit the above-named varieties the best. 2. Fourth week in March. **American Purple*, *Early Rose*, *Schoolmaster*, **Reading Russet*. Soil.—A light soil will be found the best for the above. 3. First week in March. **Paterson's Victoria*, **Magnum Bonum*, **White Elephant*. Soil.—A rather poor medium soil is most suitable for these. Manures and Application.—I recommend manuring the previous season and cropping it with green vegetables before cropping the land with Potatoes, and if wood ashes can be obtained I lay the sets in the trench and cover them with the ashes. Cultural Remarks.—I have grown a great number of varieties of Potatoes, but have found very few that are really good for table. I grew about forty varieties last season. The *American Purple* I grew to be the best, as when cooked it is snow white and very floury. It is a heavy cropper when grown on a light soil.—WILLIAM SKARROTT, *Woolley Firs, Maidenhead Thicket*.

1. First week in April. *Hammersmith Kidney*, *Mona's Pride*, **Myatt's Ashleaf*, *Porter's Excelsior*. Soil.—Light gravelly loam, resting on a sibly subsoil. 2. First week in April. **Snowflake*, *Lapstone*, *Dawe's Matchless*, **Dalmahoy*. Soil.—Soil the same as for first earlies. 3. End of March. **Paterson's Victoria*, *Magnum Bonum*, **York Regent*, *Reading Hero*. Soil.—A fine productive loam of medium texture on a subsoil of chalk. Manures and Application.—Our first and second earlies generally have a good dressing of spent hotbed manure forked in at time of planting. Late varieties receive a dressing of well-decomposed farmyard manure, ploughed in about the middle of January. Cultural Remarks.—We generally rely upon the old standard varieties, as a great many of the newer introductions do not give satisfaction, although I think *Reading Hero* will prove an exception. As a first early *Hammersmith Kidney* is all that could be desired with us. I find early planting is a great mistake, especially with us, as we are situated in a valley close to the river Thames.—S. MORTIMER, *The Gardens, Purley Park, Reading*.

1. Early in March. *Veitch's Improved Ashleaf*, *Early Coldstream*. Soil.—Heavy, with a chalk subsoil, and is the same in both the following cases. 2. End of March or early in April. *Woodstock Kidney*, *Radstock Beauty*, *Lapstone*. 3. Early in April. **Magnum Bonum*, *Scotch Champion*, *Reading Hero*, *Paterson's Victoria*. Manures and Application.—No manure is given when the tubers are planted, but they are planted where the ground was manured one year previously. No artificial manure is used, as we have plenty of stable manure here, and the quality of the tubers is not so good when too much manure is employed. Cultural Remarks.—The earliest Potatoes are laid singly to sprout some time before planting, and are planted 2 feet apart between the rows, and 1 foot from set to set, the two early kinds mentioned being of very good quality. The later kinds are planted at various distances apart from 2 to 3 feet between the rows, according to the strength of the haulm. *Magnum Bonum* is a first-class Potato for field culture in this neighbourhood. *Vicar of Laleham* is a wonderful cropper, but does not eat well grown on our heavy soil. *Suttons' Prizetaker* cropped well, and the tubers when cooked were of first-rate quality. *Suttons' Reading Hero* cropped well, and was free from disease and of good quality when cooked. I think these two kinds worthy of extensive cultivation, but have not yet seen them tried for field culture.—JOSHUA ATKINS, *Lockinge Gardens, Wantage*.

1. The two first in frames in January, in open ground the middle of April. *Suttons' Selected Ashleaf*, *Suttons' Early Border*, *Suttons'*

Field Ashleaf, *Suttons' Lady Truscott*. Soil.—A fair sound gravelly loam is the nature of my soil. The middle of April, as a rule, is the most suitable time for all the early sorts in the open ground, for if planted earlier they are in too much danger of being cut off by frost. 2. Middle of April. *Suttons' Woodstock*, *Suttons' Early Regent*, *Suttons' Prizetaker*, *Suttons' Reading Russet*. Soil.—Same as for first earlies. 3. The *Fiftyfold* and *Standard* middle of April, *Hero* and *Magnum* the middle of March if the weather is dry and the ground suitable. *Suttons' Standard*, *Suttons' Fiftyfold*, *Suttons' Reading Hero*, *Suttons' Magnum Bonum*. Soil.—If a low-lying, stiff, cold soil defer the planting till April. An extensive trial of autumn-planted Potatoes, with their exact prototypes, planted last April, was carried out at the Messrs. Suttons' trial grounds, and, with the exception of *Early Border* and *Fenn's Graft Hybrid*, every sort turned out quite one-third less in produce from those which were autumn-planted. Manures and Application.—I never was an advocate for raw manures—viz., farmyard or other dungs, at planting time. I use these for other crops a year previously, and I may say, for my experience, I have used but little of the artificial manures. Dissolved bones mixed with road grit, ditch cleanings, and matters of this sort, cannot be used amiss at the time of planting, more or less, according to the stamina of the soil. Quicklime is good for stiff loam or on clay, and wood ashes are always acceptable to me. Cultural Remarks.—I may say that I now grow Potatoes on a much larger scale than was my wont years ago, and I cannot adopt the nicety of cultivation that I then took so much pleasure to write about. I do not depart, however, from the advice I gave in the old *Cottage Gardener* in regard to very early produce—viz., by selecting the seed when the crop is dug, preserving it in shallow layers where they can be easily covered in case of frosts. Under this management the tubers will have made strong sturdy shoots by the beginning of April. When young Potatoes are required for early market purposes they should be planted by the beginning of April, and then quite three weeks in precocity may be calculated upon; but the young growing tops must be carefully watched for, and covered or earthed over to prevent injury from frosts.—ROBERT FENN, *Sulhamstead Abbots, near Reading*.

BUCKINGHAMSHIRE.—1. As early in February as the state of the weather will permit. **Early Bird*, **Veitch's Ashleaf*, and *Ruby*. Soil.—Mostly planted on borders, which are of a light rich loam. 2. Middle of March. **Myatt's Ashleaf*, *Dalmahoy*, **Prince Arthur*, **Paterson's Victoria*, *Schoolmaster*. Soil.—Moderately heavy loam. 3. Middle of April. **Magnum Bonum*, *Scotch Champion*, **Dunbar Regent*, *Vicar of Laleham*. Soil.—We have medium and heavy loam used for this crop. In dry autumns the heavy loams produce best results. Manures and Application.—The *Aylesbury Native Guano*, wood ashes, stable manure, and charred garden refuse. Manures are dug in the ridges in the autumn, native guano and wood ashes strewn in the bottom of the ridges, and mixed with the soil before planting. Cultural Remarks.—All the ground intended for Potatoes is ridged early in autumn; for late varieties 3 feet apart, early varieties 2½ feet apart. The sets are planted between the ridges and slightly covered with the loose soil on the sides of the ridges. As they grow the soil is kept drawn up to them, and sometimes the soil between the ridges is forked over. I have grown here over forty varieties of Potatoes, but at present our main crops are of the above varieties. I am growing *Reading Hero*, but cannot form an opinion of it at present.—J. SMITH, *Mentmore, Leighton Buzzard*.

1. First or second week in February. *Veitch's Ashleaf*, *Lady Paget*, *Early Bird*, *Union*. Soil.—Light and rich, in which the *Ashleaf* section does remarkably well. 2. *Early Rose*, *Covent Garden Perfection*, *Climax*, *Early Coldstream*. Soil.—Light and rich. Intermediate crops lifted early are excellent in all respects. 3. *Schoolmaster*, *Magnum Bonum*, *Paterson's Victoria*, *Champion*. Soil.—Light, rich. Late kinds produce too much haulm, but yield abundantly. Cultural Remarks.—Potatoes are chiefly grown in the kitchen garden, which from good cultivation has naturally become very rich, and requires no manure for the Potato crop.—GEO. THOS. MILES, *Wycombe Abbey Gardens*.

CAMBRIDGESHIRE.—1. About 14th of February. *Myatt's Ashleaf*, *Veitch's Ashleaf*, *Early Rose*. Soil.—Very light and sandy; gravel subsoil. 2. About 15th of March. **Late Rose*. 3. First week in April. **Magnum Bonum*, **Scotch Champion*. Manures and Application.—I always use well-decayed farmyard manure, digging in a good dressing at least six weeks before planting. Cultural Remarks.—In planting I draw drills in preference to using a blunt dibber, as it does not leave a hard bottom for the sets to rest on. I keep them well hoed, and as soon as ripe take them up, and do not leave them in the ground, as often seen, choosing dry weather for the operation, and they will cook floury.—F. ORCHARD, *The Gardens, Abington Hall*.

1. From the middle of March to the first week in April, except for extra early, which I plant in the latter end of February. **Myatt's Prolific Ashleaf*, **Suttons' Fillbasket*, *Triumph*, *Beauty of Kent*. Soil.—From light to stiffish loam. 2. About the middle of March. *Woodstock Kidney*, **Covent Garden Perfection*, **Dalmahoy*, *Pride of America*. Soil.—From light to stiffish loam. 3. As early in March as I can get the land in order. **Paterson's Victoria*, *Reading Hero*, **Suttons' Magnum Bonum*, *Schoolmaster*. Soil.—From light to

stiffish loam. Manures and Application.—Stable manure, pig manure, and slaughter-house manure, including blood, to which I add about half a hundredweight of salt and 1 bushel of soot, and mix all together. The quantity of salt and soot is for about a ton. I use about 8 tons per acre. Cultural Remarks.—I dig the land a spit deep early in the autumn, and leave it as rough as possible; and as soon as the frost sets in I place the manure on the land in heaps, and as soon as it breaks up I spread the manure as evenly as possible, and then fork the land over, well mixing the manure with the soil and breaking all lumps, and as soon as the land is fairly dry I draw drills for the early sorts 2 feet apart, for the late 2 feet 6 inches apart, and cover as lightly as I can. They are hoed until they are fit for earthing, which I do as soon as they are about 6 inches high, and then again in about three weeks I draw some more soil to them, and have all weeds removed.—JOSEPH BUTT, 17, Ruby Street, Wisbech.

1. February. Myatt's Prolific Ashleaf, Rivers' Royal Ashleaf, Beauty of Hebron. Soil.—Heavy, and is similar for the two other sections also. 2. End of February. Early Oxford, Snowflake, Excelsior, Dalmahoy. 3. Second week in March. Schoolmaster, Magnum Bonum, Scotch Champion, York Regent. Manures and Application.—Apply plenty of garden refuse, burnt, mixed with well-decayed leaf soil. At the time of planting give a good dressing of soot, also on a rainy day before earthing up. Cultural Remarks.—I always like to dig and plant at the same time, in fine weather if possible. If not fine I have a board to run the barrow on with the mixture, as before stated. I have lines 2 or 3 feet apart according to the sorts I am planting. Cut down straight with the spade about 5 or 6 inches deep, put about 3 inches of the prepared soil in, and then put the set on it and fill up with the mixture, continuing till finished. That is the way I have to do with my heavy soil.—WILLIAM HUMPHREYS, Wimpole Gardens, Royston.

GRAFTING.

CROWN GRAFTING.

THIS is a very simple and useful method, and is adapted to stocks of different sizes, and to all kinds of fruit trees. It is done in spring as soon as the bark rises freely from the alburnum, but care must be taken to prepare the scions as has been previously described. The upper half of the scion should have two or three eyes,

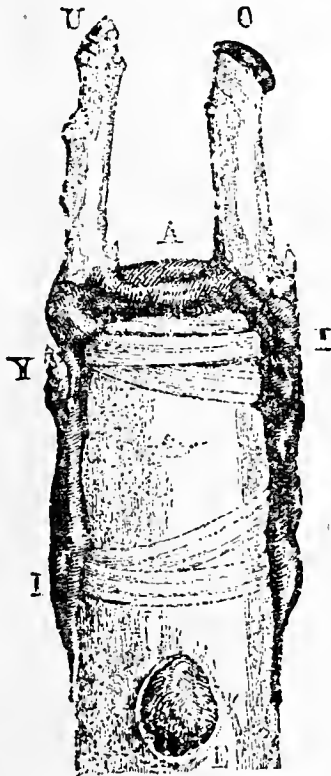

Fig. 45.

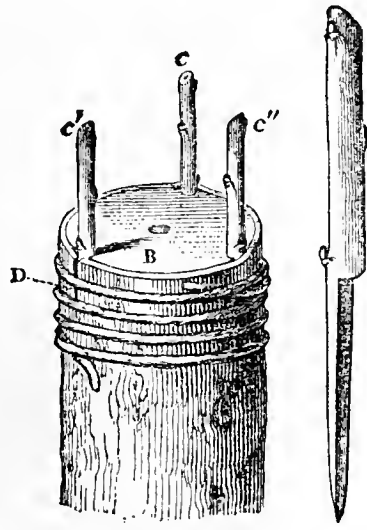

Fig. 46.

and its lower should have a long slanting cut, beginning opposite a bud and terminating in a thin point. A small notch or shoulder at the upper part of the cut is useful, as it keeps the scion as if seated on the stock. The insertion of the scion is in the head of the stock on the cut between the bark and the wood, and both sides of the point of the scion should be cut thin to facilitate its sliding in, and that point is often moistened between the lips. A small instrument of wood or ivory, wedge-shaped at the point, is used to raise the bark and to facilitate the introduction of the scion, which is slipped in between the bark and the wood. The introduction of the scion is simplified in most cases by the circulation of the sap, which separates the bark from the alburnum. However, it happens that scions of a large size threaten to tear the tissues; to avoid this take off a slice of bark from the stock

corresponding with the cut on the scion, and apply it. The larger a stock is the more scions will be put on the top of it. To render the union more complete, a space of 2 inches should intervene between them. A ligature, not too close nor too tight, is necessary after the insertion of the scions. Wax or clay is applied, and the adherence of the wax is facilitated by wiping off the sap issuing from the amputated parts.

Fig. 45 represents a crown graft tied and waxed. The wax is spread on the amputated part (A) of the stock, on the wound (E) at the junction of the scion with the stock, and on the top of the cut scion (O). The terminal bud (U) is not covered, nor the embedded bud (Y) in the incision. Crown grafting is, therefore, indispensable when operating on large trees, and a great number of branches can be produced to correspond to the nourishment supplied by the roots.

ORDINARY CROWN GRAFTING.—Given a stock (fig. 46, B) headed down, three scions (*c c' c''*) are inserted upon it in proportion to its diameter. It would be difficult to place many scions without splitting the bark at least in only one part. The tension produced by the inoculation of many shoots will end in rending the cortical layers. That accident can be prevented by a longitudinal incision (D), which not only facilitates the sliding of the scion *c'*, but permits the others (*c* and *c''*) to be at ease, and not to threaten the splitting of the bark of the stock. When tied, then wax the crown of the stem, the top of the scions, and front and back on the bark of the stock.

GROWING DWARF LUCULIAS.

IN last week's Journal "J. J." asks for any information bearing on the cultivation of dwarf plants of *Luculia gratissima*. That such can be grown successfully I have proved, and plants rooted at this season will, if liberally treated, give good heads of flower in November. The chief difficulty is in propagating the plants. If "J. J." has a propagating case with a good bottom heat, and can procure good cuttings—that should not be too hard—he need not fear the result. The shoots produced behind last year's flower heads are the best for the purpose. These should be taken off with a good heel and inserted singly in thumb pots of very sandy soil, water them, and plunge them in the case. Keep the case close till the cuttings are rooted, and only give sufficient moisture to prevent flagging. When the cuttings are rooted they should be carefully removed from the propagating case, taking care that they do not flag after removal. When the thumb pots are filled with roots the plants should have a shift into 5-inch pots, employing rich compost, and when established they must be placed in a light position in a cool stove or intermediate house. The plants must be kept free from red spider, and on no account be allowed to flag, as they soon lose their leaves if at any time the soil becomes dry. Treated in this way few of the plants will fail to produce good heads of flowers.—E. B.

MAKING AND RENOVATING LAWNS.

(Continued from page 68.)

It has been already advised to have the lawn gently sloping from the building or principal point of view, and it should slope from the line of vision about 1 foot in 25, so as to give the effect of a plane surface to the eye of the spectator. When the ground undulates naturally it will be desirable to preserve as much of this surface as possible. Even in the immediate proximity of the mansion much may be done to give the appearance of a plane surface by planting the acclivities, which will show the trees or shrubs to best advantage; and this, whilst continuing to extend the plane surface of the lawn, will be more economical than levelling the hills to fill up the hollows, which is often done to the permanent injury of the natural features of the place. If the situation be flat it should be relieved by planting rather than attempting to form mounds of earth to represent hills in miniature, which are never more out of place than on a flat surface. We not unfrequently see lawns disfigured by raised beds with sharply inclined turf down to a level lawn planted with shrubs which have an incongruous appearance. For mounds trees or shrubs of dependent habit only should be chosen.

The foregoing remarks apply to the individual bed, clump, or specimen isolated or detached from the clumps or screens forming the margin of the lawn, with its specimens in the immediate foreground, for there is no objection if the ground be naturally so disposed; or if there be any refuse soil at command it may be deposited there to form a mound, first removing the good soil and laying it on one side so to cover any accumulated matter not favourable to the growth of trees or shrubs. The rough portion

should be placed at the bottom, then the more adhesive portion, and the good soil at the top. In the form of these anything approaching to abruptness must be avoided, especially where the ground is naturally flat or only marked by gentle undulations. The diversity of the mounded surface will admit of a different planting, and this judiciously effected will produce an agreeable and variable result, especially where the ground is moderately undulating in the foreground, increasing more in the distance, the sky view being bounded by hills; but with a flat open country mounds should not be introduced. If introduced at all in such a scene it should be at the side or back of the building, to which they may be made to contribute considerably in effect, as well as for their utility where it is undesirable to continue the view in that direction.

The front view we have alluded to before, and it will now be necessary to treat of the sides in a manner different from the foregoing. With a similarity of view on the side as in front, there ought not to be any attempt at changing their contour from that presented in the foreground, but the lawn must be continued and planted where it joins the park or other scenery so as to harmonise therewith. But should the sides be of an entirely diverse nature, then so much only should be made to harmonise with the front view as will be taken in from the principal point of vision, and be made to blend with the changing scenery. This will appear as a distinct feature, and every effort must be made to insure that, whilst harmonising with the foreground or front, it should be as varied as possible. If the ground rise from the point of view, then no better position could be chosen for a display of Conifers, disposing them in groups, with isolated specimens, as shall best display them in wavy outline.

Much can be done to give variety and effect if a small stream of water can be led through the lawn, and if it can be brought in flowing over a small cascade or issuing from some figure it will be better, and then conducted to a pond for gold fish and aquatic plants, and at some distance it may be widened to afford an apparent necessity for a bridge, which may be thrown over it in association with rockwork, on the sides of which climbers or creepers may be introduced. The shrubbery should be arranged at the boundary with a properly disposed walk leading through it, and beds of flowers placed on its margin in the openings, and a few clumps of shrubs or small trees dotted upon the grass. A rustic erection in the walk covered with climbers, and a recess in the centre furnished with table and seats, may be appropriate. Flowers may also be introduced with effect, especially if placed in the neatest part of the grounds. Vases may be used with good effect, especially by the wall and near the house.

In the matter of terraces these should have corresponding slopes, and have a base twice that of the perpendicular height, so as to allow of their easy ascent or descent, and the reader keeping them in order by the mowing machine. Very steep slopes in grass are difficult, and entail great labour to keep them in order, and are more liable to suffer from drought than those with less gradient.—G. ABBEY.

(To be continued.)



"D., Deal," states that the following ROSE SHOW FIXTURES have already been arranged:—Cardiff, June 27th; National Rose Society's Southern Show (Southampton), June 28th; Canterbury, June 29th; Reigate, June 30th; National Rose Society (South Kensington), July 3rd; Bath, July 5th; National Rose Society (Sheffield), July 12th; Leek, July 17th; Darlington, July 20th (?).

— AT a recent meeting of the Committee of the GARDENERS' ROYAL BENEVOLENT INSTITUTION Edward Tidswell, Esq., of the firm of Bollen & Tidswell, of No. 3, Wood Street, Cheapside, was unanimously elected the Treasurer of the Institution in the room of the late Robert Wrench, Esq.

— IN reply to a question put by Sir T. Lawrence in the House of Commons last Monday in reference to the EARLIER OPENING OF KEW GARDENS, Mr. Shaw Lefebvre stated that Sir

Joseph Hooker had promised that at the commencement of the financial year the Gardens will be opened one hour earlier than usual—namely, at noon instead of at 1 P.M. We presume that visitors will be admitted to the houses at the usual time.

— WE regret to learn that MR. T. SNELLING, of the Middle Temple Gardens, died very suddenly on Tuesday last, the 20th inst. When passing along Fleet Street about half-past 11 A.M. he was observed to fall to the ground insensible, and when conveyed to King's College Hospital he was found to be dead. He was 45 years of age, and was appointed gardener at the Middle Temple about four years ago, previous to which time he held the position of head gardener to H. Rodwell, Esq., Ampton Park, Bury St. Edmunds. The display of Chrysanthemums at these gardens, it will be remembered, attracted many visitors last year, a great improvement having been effected as compared with preceding years' shows.

— A YOUNG GARDENER writes that he read with great pleasure "Excelsior's" article upon "GARDENING AND GARDENERS," page 87, but thinks that head gardeners might often do very much to encourage their young men in acquiring knowledge, and also that there is great room for improvement in the construction and conveniences of the majority of bothies, which might well receive the attention of both gentlemen and gardeners.

— WE have received a copy of the rules of the BRIGHTON HOVE AND SOUTH OF ENGLAND CHRYSANTHEMUM SOCIETY, which has been recently started and is receiving good support. It is intended to hold an exhibition in November next, but the date and place are not yet decided upon. A meeting will be held at the Odd Fellows' Hall, Queen's Road, Brighton, on Thursday, March 1st, which it is hoped will be attended by all locally interested in the project. The Secretary is Mr. M. Longhurst, 111, Western Road, Brighton.

— THE schedule of the GHENT INTERNATIONAL HORTICULTURAL EXHIBITION that takes place April 15th to 22nd of the present year is now issued, and gives full particulars of the classes, prizes, and conditions under which the Exhibition will be held. Two hundred and ninety-two classes are enumerated, of which two hundred and sixty-eight are for plants, the remaining classes being devoted to various useful and ornamental articles employed in gardening. Three prizes are offered in each class—gold medals framed and plain, silver-gilt medals, and silver medals of first and second values, the gold medals ranging in value from 300 to 100 francs. In two classes, however, Mr. W. Bull of Chelsea offers three silver cups value fifteen, ten, and six guineas each for twelve new plants sent out by him since 1880. Abundant provision is made for new plants, Orchids, Palms, Ferns, Cycads, Rhododendrons, Azaleas, Camellias, bulbs, with miscellaneous flowering and fine-foliage plants. There are no less than ninety classes devoted to particular genera or species of plants, exclusive of those appropriated to whole families, like the Orchids, Ferns, &c.

— THE following GARDENING APPOINTMENTS have recently been made through John Laing & Co., Forest Hill —Mr. James Ford, recently gardener to Horace Barry, Esq., Bush Hill House, Winchmore Hill, has been appointed gardener to W. R. Arbuthnot, Esq., Plawhatch, East Grinstead; Mr. James McHardy, late gardener to M. S. Riach, Esq., Silverton Lodge, Upper Norwood, succeeds Mr. Ford at Bush Hill House, Winchmore Hill; and Mr. John Bissett, late foreman to Mrs. Lyne Stephens, Lyndford Hall, Norfolk, has been appointed head gardener to Lady Charles Wellesley, Conholt Park, Andover.

— MR. W. MELVILLE, Glenlee, New Galloway, Kirkcudbrightshire, writes:—"Seeing reports of RAINFALL in the *Journal*

of *Horticulture* from various parts of the country, and thinking it might be interesting for sake of comparison, I send you the rainfall measured here for the past year, 1882. January, 4.32 inches; February, 7.23 inches; March, 5.44 inches; April, 3.79 inches; May, 1.68 inch; June, 3.25 inches; July, 8.09 inches; August, 3.79 inches; September, 4.57 inches; October, 5.96 inches; November, 7.99 inches; December, 4.80 inches; total, 60.91 inches. The greatest rainfall in twenty-four hours was 1.64 inch on the 1st September.'

— THE schedule of the ROYAL HORTICULTURAL SOCIETY'S ARRANGEMENTS FOR 1883 is now issued, and gives full particulars of the exhibitions to be held during the approaching season. Promenade Shows will be held on March 27th, April 10th, and May 8th. At the first two medals will be awarded for groups of bulbs and miscellaneous forced plants, and at the latter for groups of Orchids. The National Auricula Society's Southern Show will take place on April 24th, when the usual prizes will be competed for. The Summer Show will be held on Tuesday and Wednesday, May 22nd and 23rd, when, in addition to thirty-two classes for plants, flowers, fruits, and vegetables, in which valuable prizes are offered, twenty classes are also provided for implements and garden structures, silver and bronze medals being offered in each class. In the Orchid classes an important stipulation is appended—namely, that the judges will consider whether the plants are single specimens or made-up plants, and that any specimen containing more than one distinct variety will disqualify the collection. Sir Trevor Lawrence, Bart., also offers a special prize of £10 for the best collection of twelve exotic Orchids, distinct species and single plants. The Pelargonium Society's Show will be held on June 26th, but the schedule has been previously noted in these pages. The National Rose Society's Exhibition takes place on July 3rd, and the National Carnation and Picotee Society's Show on July 24th, which will be referred to again at a later date.

— A NUMBER of SPECIAL PRIZES will also be offered at the shows and meetings of the above Society, comprising the following:—March 27th, for seedling and named Amaryllises by a Fellow of the Society, and by Messrs. Sutton & Sons for seedling Cinerarias. May 22nd, the Veitch Memorial prizes for specimen plants and Grapes; for Calceolarias and Cucumbers by Messrs. Sutton & Sons; and for Blenheim Orange and Emerald Melons by Messrs. Carter & Co. June 26th, for Tuberoses, Begonias, Gloxinias, Peas, Lettuces, and Endive by Messrs. Sutton & Sons, and for a collection of vegetables by Messrs. Webb & Sons. July 3rd, for a collection of vegetables by Messrs. Sutton & Sons, for new Peas by Messrs. Carter & Co., for a collection of Roses raised at or introduced from Waltham Cross by Messrs. W. Paul & Sons, and for examples of the best methods of packing fruits for market by Messrs. Webber & Co. July 24th, for six dishes of Tomatoes by Messrs. Carter & Co., and for Cabbages and Potatoes by Messrs. Sutton & Sons. December 11th, for new Onions and a collection of vegetables by Messrs. Carter & Co.

HYBRIDS OF GLADIOLUS GANDAVENSIS.

CIRCUMSTANCES have prevented my referring earlier to the interesting garden notes of your correspondent "D., Deal," on this subject a short time since. As I am thus late I shall confine myself to one point alone. But first I must express my regret that such an experienced grower as "D., Deal," should, even in a qualified manner, consider success and the perpetuation of the corms almost if not wholly unattainable. No doubt there are difficulties to be met and care is necessary, maturation and winter storing being too frequently neglected; but those have often been stated in your columns. At present, as your correspondent referred to the losses of Mr. Banks within his vicinity—as many as fifty thousand 'tis said—I want to know (if there is no objection to answer the question), Is it not a fact that that gentleman left his choice hybrids of *Gladiolus gandavensis* out during the

winter? I hold a letter in my hand to this effect from a gentleman who should know, in the south of England; and can only say, if the question must be answered in the affirmative, those who through the horticultural press for months past have made this the text for decrying the growing of *Gladioli* in future, should have stated this important fact if it was known to them. I am only referring now to your excellent correspondent "D., Deal," because of his having lived in the locality of Sholden.—W. J. M., *Clonmel*.

COLLECTIONS OF SEEDS.

WE would at once assure your correspondent "C. T. H." (page 109) that we had no desire or intention to misquote his remarks. We see, however, the writer of the letter has inadvertently altered somewhat the sense of the latter portion of the paragraph. We would also thank your correspondent for the suggestion as to the numbers of varieties there should be of such a leading article as Peas. The position of "C. T. H." is evidently an exceptional one, because he admits that as a rule "enough Beans of all sorts are annually saved here for seed, as well as Onions, Parsnips, Melons, Tomatoes, Cucumbers, and Marrows; Spinach he does not care about." We can therefore quite understand there would be no economy in his purchasing a guinea box of seeds; but with ninety-nine other purchasers, even in a favourable season, the trouble and expense of properly harvesting the most desirable selection from each variety of crop would soon tire them of the operation when they remembered what a liberal assortment of seeds of a quality everyone admits to be good could be obtained for the sum of one guinea.

If any definite suggestions of a practical character can be obtained with regard to improving the composition of our boxes of seeds, as we have said before, we shall be glad to consider them. At the same time the fact still remains, that where one desires an alteration in the construction, a hundred purchase them in their integrity. We are afraid also that our intention in regard to these boxes of seeds is misunderstood. These collections were never intended to supply a want of the professional gardener, but they are calculated to meet a great want felt by thousands of amateurs and moderately experienced gardeners who are positively unacquainted with the varieties of seeds, and to whom these boxes, admitted, as they are, to contain in every instance varieties of standard excellence, must come as a great boon—as enabling them to obtain a knowledge of varieties that they could not otherwise obtain.

We are afraid the remarks of your correspondent with regard to early orders and "own selections" read better than the suggestions would operate in practice, and for this reason. All seed-growers know that in every harvest they get larger crop returns of some sorts and varieties than others. Thus where the selection is left to the seedsman what would he do? He would make up the assortment from those varieties which most abounded.

The remarks of your correspondent relative to the quality of our goods are very gratifying, and we can only say if he will sketch his ideas of what he considers would make a guinea box that would meet with more general approval, and forward the same to us, we will give it our most earnest attention.

In conclusion, we repeat that although the demand for these boxes increases greatly every year, it is surprising they are not purchased by "every amateur."—JAMES CARTER & CO.

NORTHWARDS—DRUMLANRIG.

WHEN at the Edinburgh Show in September I found that some of the visitors from England had called at Drumlanrig on their way to the Exhibition; others, and perhaps the majority, paid a passing visit to Mr. Thomson on their journey home. Amongst those who had spent a few hours there before reaching the Show was the head of one of the finest gardening establishments in Britain, and one of the most skilful cultivators of the day. The result of his visit was an attack of Pines—Pines on the brain. "Have you been to Drumlanrig?" asked my afflicted friend. "No," was the response. "Are you going, then?" was the next question, and without giving time for an answer observed, not in the most gentle of tones, "if you don't go you will deserve thrashing; you never saw such a house of Pines in your life as you can see there. I have been thinking and dreaming about them ever since. The Black Hamburgs are grand, but the Pines are magnificent." "Oh, if you want to see Grapes," remarked another fine representative of the craft, "you must go to Clovenfords." Expressing a fear that that was out of my route, he very quickly retorted, "Oh, you daren't go; you have been to Longleat and said there are no such Vines in the Queen's dominions, but I tell

you there never was such a crop of Grapes at Longleat as you may see at Clovenfords now, and if you don't go we shall know the reason why." To be told that I should "deserve thrashing" if I did not go to one place and to be adjudged a coward if I did not go to the other was not quite pleasant, so I resolved to visit both. Of Clovenfords I had intended saying something long since, but opposing circumstances have been too powerful, and it has happened that, though Drumlanrig was visited last, it falls to be noticed first. Considering its magnitude and commanding importance from a gardening point of view, this notice will be very brief—a few jottings from memory of the prominent features.

Soon after leaving Thornhill station the Castle is seen standing in solitary grandeur on a spur in the bosom of a wildly beautiful valley surrounded with majestic hills. Viewed from a distance it is a picture of loneliness, and if old records express the truth this isolation was the means of its first owner uttering a more curious than terrible invocation, which might only have been meant to alarm the builders, but is capable of wider application. It has, however, no deterrent effect on visitors, who appear to have ready access, not even a gate from the main thoroughfares opposing the way. But to this curious invocation. It is thus embodied in an old gazetteer:—"This great pile occupied ten years in building, and was finished in 1689, the year after the revolution. William I., Duke of Queensberry, celebrated in civil history as a statesman, and in the annals of the Covenanters as an abettor of persecution, planned and completed it, and he expended upon it such enormous sums of money, and during the only night of his residing within its walls was so exacerbated by the inaccessibility of medical advice to relieve him from a temporary fit of illness, that he abandoned it in disgust, and afterwards, in the unpolished language of the period, wrote upon the artificers' bills for erecting it—"The devil pike out his een that looks herein." Drumlanrig Castle was the principal residence of the family of Queensberry, but on the death of Charles, the third Duke, in 1777, without male issue, it passed along with the Queensberry titles to William, Earl of March, and upon the death of the latter in 1810 it went by entail to the Duke of Buccleuch." So much historically for this huge square pile and noble patrimony of some 250,000 acres, practically unfenced, all being open, grand, and free. From the gardens, some fifty acres of pleasure grounds, and a paddock or two the deer are excluded, but that appears to be all in the way of restriction on this great demesne.

Yet in this wildness there is comfort for the Duke's dependants, excellent dwellings being provided for all. Typical of these is the gardener's house (fig. 47), which is represented as a model of its kind; and no one more hospitable is to be found than the accomplished gardener who has for so long dwelt there—Mr. David Thomson, the cordial welcome he extends to visitors being proverbial. This pretty cottage stands on the steep hill side of a lofty range that extends along the west side of the garden and dressed grounds, a commanding, almost a bird's-eye view, being had of the former from the windows and terrace. At our feet is the herbaceous garden, gay with a variety of flowers in summer and rendered cheerful by neat shrubs in winter. On the right, forming the southern boundary of the garden, is the remarkable span-roofed fruit range exactly 498 feet in length without any division, and 18 feet wide. This house is as good as it is great, being neat in appearance, substantial, admirably adapted for its purpose, and excellently furnished with thriving trees of well-selected fruits. The trees are trained to wires 16 inches from the glass, and as viewed from the end this long tunnel-like arch has a remarkable appearance. The structure is, moreover, profitable, as, being efficiently heated with 3000 feet of piping, heavy crops of fruit are insured, which could not be produced outdoors in this dull and wet locality. A broad cast-metal path runs down the centre of the house, and the side curbs act as metals for a railway wagon for conveying materials in and out of the house. The trees are planted in the side borders, and although they have only been there about four years they quite cover the trellises and bear heavy crops of splendid fruit—Figs, Peaches, Nectarines, Plums, and Pears. The Pears are mostly grown as cordons trained 2 feet apart, the others being fan-shaped. The Peaches consist chiefly of Dr. Hogg, Violette Hâtive, Stirling Castle, Sea Eagle, Bellegarde, Walburton Admirable, and Princess of Wales; the Nectarines of Lord Napier, Elruge, Pitmaston Orange, Humboldt, Pine Apple, Prince of Wales, and Victoria. Thus a long succession of fruit of the first quality is provided; and as in most cases a tree of each is planted on both sides of the house—north and south—the season of each is thus prolonged. It is not necessary to dwell on the merits of all the varieties, as they are mostly well known; but it may be stated that Lord Napier Nectarine is only really fine during a warm season—a hint that may be given to northern planters, and that

Humboldt, judging by the splendid fruit and its high quality, is not sufficiently known. Pine Apple was extremely fine, and the Sea Eagle Peach is esteemed as a late variety for its large size and excellent flavour. This imposing and most serviceable structure is one of the prominent features of this fine garden; but there are other ranges of glass, and something in every house worthy of note. No pretence, however, will be made to particularise half of what was seen during a fine day in September.

"There is not so much glass at Drumlanrig as I expected to see," observed a gardener, who evidently went with great expectations, further remarking, "there is a nice bit I grant, yet I looked for more, but the culture is first-rate." Well, this "nice bit" of glass amounts to 51,000 superficial feet, 14,000 linear feet of piping being employed in heating. How many men are engaged in the houses I am not able to say; but there are eighteen in the young gardeners' rooms, the term "bothy" being quite inadequate to this excellent and very complete building. Everything appears to have been arranged for the comfort of the occupants—separate bedrooms, bath-room, &c.; in fact, the building resembles a small barracks of the most approved construction, and, convenient to the fires, a huge subterranean chamber, containing large cruciform boilers (Meiklejohn's Improved), for heating the various structures, the smoke being conducted to a shaft half a mile away among the tree-clad hills.

Parallel with the fruit range above noticed, forming the southern boundary of the walled kitchen garden, an enclosure of six acres, is a large, broad, and lofty lean-to range on the north side, of the same length as the other, and of course facing the south. In this range there was much demanding notice; but the Black Hamburg house was the great centre of attraction. The crop was wonderful alike by the size of the bunches, ranging from 4 to 8 lbs., and the high finish of the berries. It is not too much to say—and I say it without hesitation, and in full consciousness that these notes will be read by some of the best judges of the matter—that fifty bunches of Black Hamburgs, and probably a hundred, could have been cut from this one house that would have surpassed the best examples of the same kind that were staged at Edinburgh. Assuming that this assertion will not be contradicted, not another word is necessary to indicate that this was a splendid example of Grape culture. As evidence that I am not disposed to bestow indiscriminate and too fulsome praise on everything in this ducal establishment, I have next to say that many finer crops of Muscats have been seen than in the house adjoining, not that it was a bad crop, the bunches small and the berries faulty; on the contrary, it was such as many gardeners would be proud to own, but it was too near the Hamburgs to show to advantage. The soil would appear to be too cold and wet for Muscats; at any rate they lacked the wonderful vigour of their black neighbours and of a Gros Colman in the Muscat house. The crop on this Vine was all that could be desired, and more than could have been expected a Vine could carry and finish so well, the rods being crowded with fine bunches and large berries covered with thick purple bloom. And what about the Duke? A great part of the crop had been cut, but there was what may be termed a large sprinkling left—fine, regular, full bunches, with huge berries almost without spot or blemish. Wherever this, the most abused and most praised of Grapes may have failed, and failed it has in too many instances, it beyond doubt succeeds at Drumlanrig, and it cannot be seen and tasted as it is there produced without commanding emphatic approval. It is, in truth, a magnificent Grape, and not a few who did not succeed in their first attempt at growing it are now giving it another trial. I have more to say both about the Duke and Gros Colman in connection with their culture in the Tweed vineyards, and now pass on.

A few Vines fruited in pots at Drumlanrig merit notice. They are grown for dinner-table decoration, and only on a table and in a room of more than ordinary size could such examples be appropriately placed. The Vines are grown in ordinary large pots; but before starting the canes are drawn through 7-inch pots, which stand almost on the soil in the others, the surfaces of the smaller pots being covered with Selaginella. The smaller pots become filled with roots by the autumn; the stem is severed from the original roots, the pot placed in a suitable receptacle, and the freshness of the Vine maintained as long as is needed. The canes of these Vines are not taken with a clean stem and twisted so as to form a hoop, from which the bunches depend. Such Vines are no doubt handsome, but here they are grown in the most natural manner possible, the cane being secured to a stake, and the laterals take their own course, being thinned and stopped at such distances as the cultivator deems best for attaining his object. When ready for table they are open pyramids about 5 feet high, and with a maximum diameter of about 2 feet. Each lateral bears a bunch of Grapes, and as there are eight or ten of them, fine, well-

coloured fruit, and as all are visible, their effect, mingled with the tinted foliage in autumn as represented on the table spread for a shooting party, cannot fail being imposing.

Now to the Pines. The above-quoted verdict of one of the fruit judges at the Edinburgh Show—namely, “the Black Hamburgs are grand, but the Pines magnificent,” must be sustained. The house of plants as seen just on the eve of the fruits ripening will not soon be forgotten by those who had the pleasure of witnessing it. Plants dwarf and sturdy, fruits large and regular, crowns neat and even, were the characteristics of this remarkable collection. Large plants with fine fruit I always know where to find, and large plants with small fruit are too plentiful; but such small plants with such large fruit as those under notice I venture to say have rarely, if ever, been seen. Scores of fruits of the Smooth-leaved Cayenne must have approached 8 lbs. in weight, and the base of not a few of these were only 9 inches from the surface of the pots. Charlotte Rothschilds were equally fine, and Hunter's Lady Beatrice, a taller grower, was perfecting magnificent fruit. This variety is highly esteemed at Drumlanrig, not only for its noble appearance, but equally so for its superior quality,

and quite a large stock has already been raised. Long ranges of pits are filled with succession plants and suckers, and here again the dwarf habit cannot but be recognised. Evidently the high temperature and steaming process is not practised here, as nothing but what may be termed a medium temperature, with all the light and air possible, could have produced such results—small, thick, crisp leaves and huge well-fed fruits. These Pines were mostly fruiting in 10 and 11-inch pots, none larger, and probably not more than eighteen months had elapsed since they were inserted as suckers. I am tempted to linger over this masterly example of Pine-growing, but must take a cursory glance of some other departments of this fine garden.

Passing Palms, Ferns, and hardwooded plants, all well and largely grown, we pause at the Orchids, as who could help pausing at upwards of twenty plants of the Dalkeith variety of *Vanda tricolor*, ranging from 3 to 4 feet high, with *V. suavis* in tubs five or six plants grouped together, all growing luxuriantly. A gigantic form of *Zygopetalum Mackayi*, with stems and flowers twice the size of the ordinary kind and more distinctly marked, commanded attention. Is this the Trinity College Botanic Garden

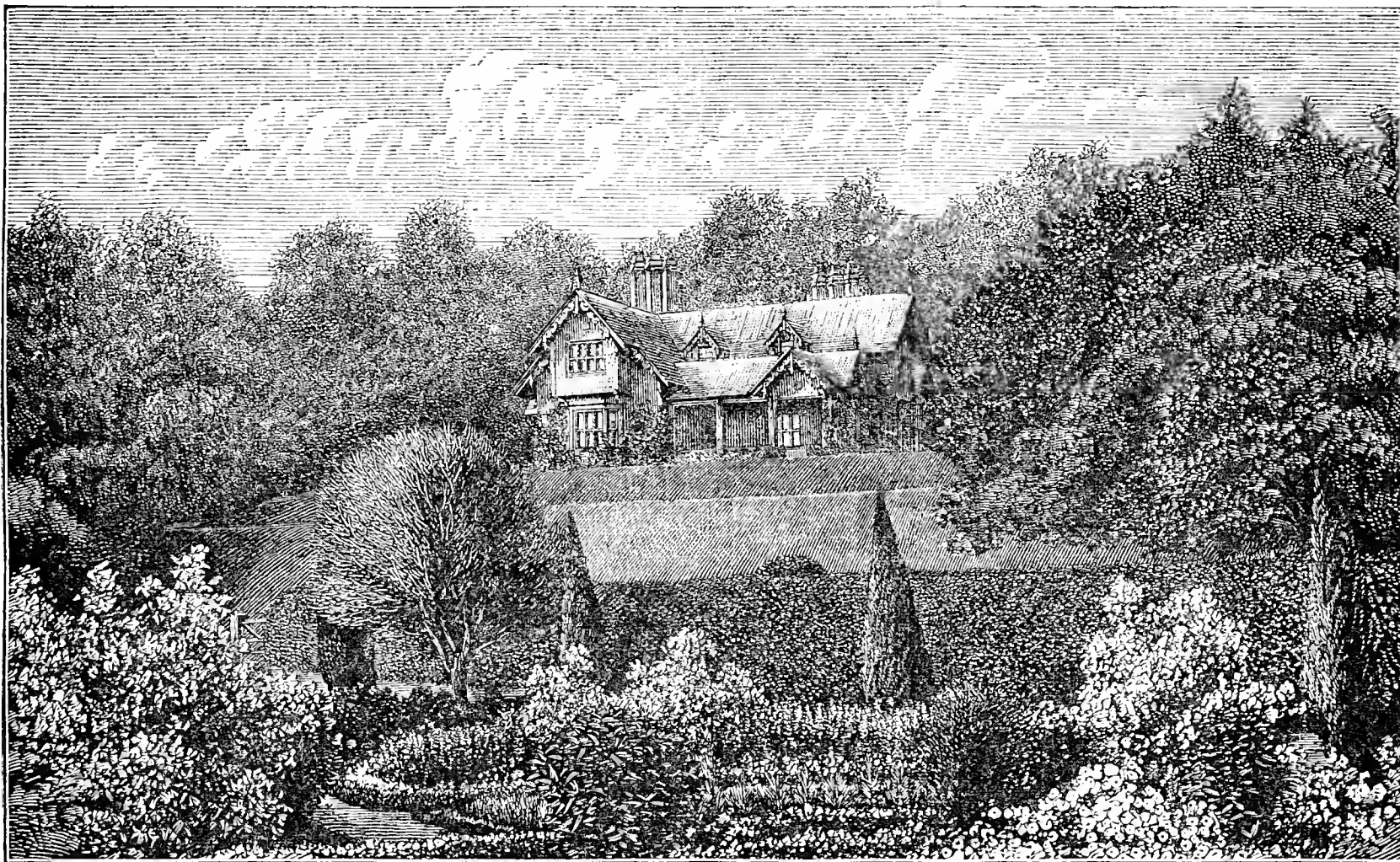

Fig. 47.—THE GARDENER'S HOUSE AT DRUMLANRIG.

variety in charge of Mr. Burbidge? Perhaps he can tell us; certain it is it far excels the species that is generally found in gardens. Not less attractive, but of a different type of beauty, is the elegant *Dendrochilum filiforme*, of which a hundred spikes are sometimes cut at once for room-decoration. *Cypripedium Maulei*, *Sedeni*, *Dominii*, *caudatum*, *Boxalli*, *villosum*, *Lowii*, *Harrissianum*, and others of this grand genus appear to grow like *Agapanthus*—huge specimens with grand foliage, the sure precursor of correspondingly grand flowers. *Odontoglossums* are most vigorous, *O. Alexandræ* producing spikes like *Asparagus* shoots, two from each pseudo-bulb, some of the varieties being of great merit and of particular excellence. *Cattleyas* and *Masdevallias* are equally at home, thriving and prosperous.

Anthuriums appear to receive special attention, and deserve it. *A. Andrcanum* was growing vigorously in a 12-inch pot, and producing large spathes; and of the varieties of *Schertzerianum* were *Patersoni*, *Wardi*, both fine, and *Verschaffelt's* or *Knight's* variety with red stems and very rich spathes. These are plants of sterling worth, and we must travel far to find them in better condition. The fine-foliaged varieties are also represented—

Warocqueanum, with leaves 4 to 5 feet long, *Veitchii* similar, and *crystallinum* in superb colour. *Nepenthes* grow as if in their native wilds, and we must leave them to luxuriate. *Crotons*, too, can only be mentioned—a fine collection of huge plants of the leading kinds; but a small plant, because new. *Thomsoni* was very beautiful; it was raised here, certificated at Edinburgh, and has a future before it both as an exhibition and home-decorative plant. The same may be said of *Sir Garnet Wolseley*, also raised here; it is of the trilobed or *Disraeli* type, and was singularly glowing in colour, but has not yet been certificated. And now we leave the houses and all their contents, pass a forest of *Phloxes* old and young, a young plantation mixed with *Gladioli* having a beautiful effect, and take a rapid walk across the flower garden.

Crossing a burn or small river which has dashed for centuries along its rugged bed, the great expanse of lawn, pleasingly diversified with trees and shrubs, spreads out before us—the grass as smooth as velvet, the walks in perfect order, and great masses of flowers in the distant beds, and we reach the old terrace wall studded with *Trichomanes*, in places ablaze with the *Flame Tropæolum* (*T. speciosum*). In one place is trained a *Maidenhair*

Tree (*Salisburia adiantifolia*), another a Magnolia, and so on ; but more curious is the effect of Rubuses and Laurustinus that have sprung as seedlings out of the wall 10 feet from the ground, and now, as trained to the wall, they appear as if stuck on the face of the masonry. On the top of this terrace is the great gravel promenade and another garden of Phloxes and hardy plants, and on a still higher terrace stands the Castle. The view from this standpoint across the grounds below—the striking sand and Heath garden near—the bright flower beds, Violas, Tuberous Begonias, and other telling masses further distant, and the heavily wooded wilderness heights beyond—is beautiful in the extreme, and tempts us to linger and admire a scene that cannot be adequately described.

We now climb the opposite tree-clad range by twisting walks, reach the grassy drives, of which there are 45 miles—soft silent carriage drives through the woods, kept like lawns—and meander along the ridge, with the beautiful Nithsdale spread below us, the river gliding through the green pastures and losing itself in the distant mountain passes, we arrive again at the point from which we started—the pretty cottage on the steep hillside, rest, refresh, step into Mr. Thomson's wagonette, and leave (there was quite a little party), I fear reluctantly, a place which, both by its magnitude, diversified character, and high keeping, has few equals in this country.—J. WRIGHT.

GARDENERS AS SERVANTS.

THE following decision in reference to the liability of employers to be taxed for gardeners and garden workmen was recently given in the *Times*:—

“At Marylebone, Captain Aubrey Lisle Patton, of Alpha House, Alpha Road, St. John's Wood, was summoned for keeping a male servant without a license. Mr. Powell appeared to support the summons. Michael Jamieson, an officer of Excise, said on August 23rd last he saw a man, apparently a gardener, working in a greenhouse on the defendant's premises. The witness subsequently called on the defendant and spoke to him on the subject. He said he claimed exemption as the man did not live in the house ; he was only a common day labourer, not a servant. The defendant said he employed several men, and urged that in this case it could not be held that the man was a servant within the meaning of the Act. Two of the men employed by the defendant were called, and it was shown that they were engaged by the day, and received their money weekly. They were not regularly engaged every day, and when employed at odd times they were paid by the hour. Mr. Cooke said the matter was one of great importance, and the point had not yet been decided. The fifth clause of the 39th Vic., cap. 16, was especially enacted to meet the case of youths and men who were partially employed in different gentlemen's houses during the day. That, in his opinion, settled the point, though it did, no doubt, inflict great hardship in certain cases. He should decide that when a person was employed for the whole day he did absolutely become a servant of the person employing him. He had no doubt as to the accuracy of Captain Patton's statement with regard to his men, but he must hold that the man referred to was a servant within the meaning of the Act. He should inflict a nominal penalty only of 5s. Captain Patton asked how many of his men he was to put down on the schedule, as he had as many as sixteen employed at one time. Mr. Cooke said he thought under the Act each of them would have to be paid for if he was employed an entire day. He should not be sorry if his decision was appealed against.”

[As we were somewhat surprised at this decision we have carefully looked up the statutes bearing upon the point at issue in so far as they concern gardeners, and we must say that we are entirely at a loss to see how the learned Magistrate arrived at his conclusion. The “Customs and Inland Revenue Act, 1869” (32 and 33 Vic., cap. 14) provides that a sum of 15s. for every male servant shall be paid annually upon licenses to be taken out under the provisions of the Act by the person who employs the servant. The Act defines a male servant—“Any male servant employed either wholly or partially in any of the following capacities—that is to say (*inter alia*), Gardener, under-gardener, or in any capacity involving the duties of any of the above descriptions of servants by whatever style the person acting in such capacity may be called.” The “Customs and Inland Revenue Act, 1876” (39 Vic., cap. 16) by Sect. 5 amended the first-mentioned Act as follows : “The term male servant as used in the Act 32 and 33 Vic., cap. 14, shall not include a servant who being *bonâ fide* employed in any capacity other than the capacities specified or referred to in provision No. 3 of Sect. 19 of the said Act” (the part of the Act from which we have quoted) “is occasionally or partially employed in any of the said capacities so specified or referred to, and shall not include a person who has been *bonâ fide* engaged to serve his employer for a portion only of each day, and does not reside in his employer's house.”

The learned Magistrate stated that the fifth clause of 39 Vic., cap. 16, was specially enacted to meet the case of youths and men who were partially employed in different gentlemen's houses during the day ; that, in his opinion, settled the point. It may be that the latter portion of the section was enacted with this object, but the

first part of the section seems to us to have been rather enacted with a view to meet such cases as that actually before the Magistrate—namely, those in which labourers or others habitually employed by a person were occasionally employed in the capacity of gardener, under-gardener, or some other capacity named in the original Act.

It also seems to us that the duty imposed, being an annual one, indicates that it is only intended to be imposed in cases where the male servant, gardener, or otherwise is regularly employed, and that the mere hiring of an additional man to assist in the garden for a week or a month would not come within the spirit of the Act.

In any case the matter seems to us to be one which should be settled one way or the other, and we trust Captain Patton will appeal from the decision of the Magistrate.]

PHLOXES FOR LATE FLOWERING.

Now is the time to divide and replant Phloxes for late flowering. The division of this flower has fallen into disrepute, and propagation by cuttings takes the place of the more simple though perhaps less scientific system of increase. I have tried both ways, and for garden decoration, or perhaps for any other purpose, plants from division I find are quite as good as those from cuttings. I have always strong plants to propagate from, two years being the longest period they remain in one place ; but I conceive if good cultivation is allowed, there is not much fear of the results. Our plan is to lift the old plants which the preceding season had about five strong shoots ; the stools are broken up, one strong growth having as a rule sufficient young shoots at its base to make a good plant. Above everything the plants like rich soil. Given that, and planted now with due care throughout the summer as regards routine work, and a display of this lovely autumn flower three or four weeks later than ordinary plants will be produced.—R. P.

NOTES FROM MY GARDEN IN 1882.—No. 2.

AURICULAS.

AFTER some years of vexation and disappointment in the cultivation of what I must look upon as my first love in horticulture, the beautiful and refined Auricula, I am at last beginning to “see daylight,” not that my collection is what it was or what I would wish it to be ; but it does not present that woe-begone appearance it did two or three years ago, and I hope, if nothing unforeseen occurs, to have enjoyment out of it this season. I have still the woolly aphid, but not in any way like what I had ; and while I cannot for one moment agree with those who think that is not injurious to the plants, still less with those who consider it positively beneficial, I am inclined to agree with those growers who do not think it so hurtful as was once supposed. I remember Mr. Horner's graphic description of the Auricula infested by it some years ago, but where it comes to that I imagine there is something else than the aphid at work. It has produced, probably, a weakness in the plant which has made it susceptible to other adverse influences ; but where it has been detected and has not been allowed to go undisturbed, there its injurious effects are not so great. One of the most amusing things connected with its history is that a writer in a contemporary actually made the assertion that it was beneficial to the plants, and brought forward the authority of some of the Yorkshire growers, who told him that they had never had their plants healthy until they got it amongst them ! I imagine his informant must have been “coming Yorkshire o'er him,” and quietly winked to himself when he was imparting the information to a “soft southerner.” I do not see how we are to get quite rid of it, for I find it, or something which looks very like it, on the roots of Lettuces, Sow Thistles, and other plants in my garden. Fir-tree oil decidedly finishes it for the time and does not injure the root or foliage of the plants.

Amongst other experiments, I tried last year the planting of a number out in a frame. The frame was half filled with broken brickbats, pots, &c., and then a few inches of good loam placed on the top without any admixture whatever. The plants were planted in it about 5 inches apart and left until the autumn exposed to all weathers. The frame being in a north aspect, in October the light was put on and air given on all suitable occasions, and now in February I find the plants looking healthy and well. A few have vanished, but it has been from some of that horrible plague of snails and slugs which I have experienced like many others, and which this wet and mild winter has so greatly encouraged, and as the frame stood under a hedge it was more liable to invasion. Walled gardens possess an advantage both in this way and in the matter of weeds. No matter how clear I might keep my garden, the hedges and ditches around me are full of weeds, and they easily scatter themselves in mine and my neighbours' gardens and come up in all unlooked-for situations.

I am now just stirring the surface, and shall leave the plants there at any rate until potting time, when I may perhaps take them up and pot them, putting in their place a fresh supply of younger plants. Of course leaving them in this way exposed in the summer is very different to leaving them in pots exposed to all weathers, for then a stoppage of drainage or a soddened condition of soil is sure to tell injuriously on the plants. Even although they may for a time look healthy, like the brilliant colour of a consumptive patient it is the sure presage of decay.

I have not during the past season removed my plants from the position they have had since May last under a hedge facing north. There seem to me several advantages in this. It is a great saving of trouble—no small matter where one has to look after them oneself. Then, as most of our heavy rains come from the S.W., from which wind the frames are sheltered by the hedge, there is not so great a likelihood of the rain beating into the frames or of drip, while it is much more easy to give air in windy weather. I have one frame of Picotees facing south, and during one of our late severe gales the light was lifted clean off and deposited on a bed of Tea Roses without, strange to say, breaking one pane of glass, but considerably damaging the heads of the Rose plants. In the more sheltered position of the Auricula frames this would not have happened. Moreover, I think that the plants are kept in a more equable condition, as when exposed to the south warm sunny days are apt to in some way stimulate them, and they require much more watering than when left in a place where they are not so exposed to being dried out.

This unfrequent watering is facilitated by the use of the glazed pots, against which there was an outcry as being subversive of all the theories about porous pots, and it was said that it would be useless to grow them in such hermetically sealed receptacles. I can testify that they grow well in them, that the plants do not require nearly as much water, while no green matter accumulates on their outsides; while the contrast between the dark colour of the pot, and the mealy foliage of some kinds and the bright green of others, is very pleasing to the eye, and this particularly struck me when looking at the fine collection of my late friend Mr. Woodhead, who used nothing else. By-the-by, I noticed lately that Mr. Thomson, the accomplished gardener at Drumlanrig, stated that he used nothing else in his Orchid house (I think it was): we shall therefore probably hear no more of the unscientific character of such a proceeding, and, as far as my present experience goes, I should like to have all my collection in glazed pots.

In the matter of top-dressing I must confess to having made a change from the old-established traditions of former days. We used to be told to take out as much as we could of the old compost and fill it in with fresh; but when I find so experienced a grower as Mr. B. Simonite questioning the desirability of top-dressing at all, and saying that at any rate he should only remove just the very surface, that the roots proceeding from the neck never care to root into the fresh material, it was time to think of altering "the rules of procedure," and I do not think that I have had any cause to regret having done so. Here again will be a great saving of trouble. I believe that instead of, as the older growers used to advise, putting richer compost, it is better to use more loam and less manure than in that in which they were potted.

I have been greatly puzzled by the manner in which Heap's Smiling Beauty has deceived me. The plants I had have grown smaller, and this is, I find, the case with some others. Now this opens up a question which I should like to have ventilated in a quiet and reasonable manner—whether there is such a thing as strains in Auriculas; whether from some cause or another certain persons obtain a decidedly better strain of some varieties than of others. Where, for instance, did the green-edged variety of Oliver's Lovely Ann originate? It came out as a grey edge, and is most frequently seen in that class, but as a grey it is not comparable to the green-edged variety. Then is there not something peculiar in the strain of Lightbody's Richard Headly which my friend Mr. Tymons possesses? I believe at any rate he is forced to consider that there is, from the number of applications for plants that he has had. Then, again, the strain of Col. Taylor, held by Mr. Wilson of Halifax, seems to be superior to most others. I myself had a strain of an old, and indeed indifferent, flower—Poppewell's Conqueror, which was far superior to anything I had seen elsewhere, and at times really gave a respectable exhibition truss. Mr. Simonite has, he believes, a peculiarly fine strain of George Lightbody; while I have heard another grower complain of its doing badly with him, as if he had an inferior strain.

Next to the pleasure of looking at our own collection is that of looking at others. This pleasure I have had twice lately in seeing Mr. Simonite's at Sheffield, extensive and excellent, with

all its treasure of seedlings, and that of my friend Mr. Robins of St. John's near Lewisham. This is remarkable for the large number of varieties grown—160, and as one of the few cases in which the love of the flower has appeared in the metropolis. His collection looked in excellent health. The plants were all in small-sized pots and gave promise of future excellence. There was, unhappily, a cloud hanging over them, for Mr. Robins expected to have to leave them shortly for a little trip to Vancouver's Island, and would consequently not be here to see them in flower. To a lover of the Auricula this is a great trial, but "business is business," and to it Auriculas even must give way; but his small back garden is now very interesting, and shows that where there is a real love of the flower it can be cultivated, and well cultivated, even in the midst of a densely crowded neighbourhood.—D., *Deal*.

VINES IN LIME RUBBISH.

PROVOKED by my brown Hamburgs and the timber and crops of the Tweed Vineyard, and your and Mr. Thomson's advice, I must try to surprise you. In 1862, when building my house here on 1000 feet of mere gravel, with 2 feet of light soil above, I ran a pit due south from it 90 by 16 feet, and 6 feet deep, for a vinery, span-roof. I filled up, say, 2 or 3 feet at the bottom with stones and foundry rubbish that would defy water to trouble the roots above them. To level this quarry the mason removed all his freestone chips and lime rubbish, and spread them over it, and then I laid in the best soil I could get and planted my Vines. Now I have dug out all the original soil to replace it with imported strong soil and old turf that would delight any Grape-grower, running a trench in the centre of the house down to the bottom rubbish, and carefully disentangling all the Vine roots for their new soil.

We were astonished to find few roots in what we considered our best soil near the surface; but by-and-by we cut through about 4 inches thick of lime and freestone chips about 3 feet from the surface, and I am sure had any gardener seen how all but the whole Vine roots were packed into and protruded from this layer of lime rubbish—standing out from it like a brush into the central cut through the vinery bed—he, like us, would have "sucked the finger of astonishment." All these twenty years gardeners had wasted their brains and backs mixing up in the Vine borders (all the roots are inside) everything imaginable—bone dust, soot, and sewage—to coax the Vine roots to near the surface, and now these ungrateful wretches have dived down through all our tasty and superior soils and been living in that layer of lime rubbish! Now we regretted not having a photo made of the brush protruding through the lime. Seeing is often the only proof of a story. However, we have got from a burned-down house many cartloads of apparently exactly the same lime and chip-stoned rubbish that my Vines loved so dearly, and mixed it freely with the heaps of old turf and grand strong loam, and if the roots do not soon revel in this I shall call them ungrateful.

Long ago I led a branch of a Hamburg from the vinery into the adjoining conservatory as a roof shade for my flowers; and though you may forget your explanations why my Hamburgs in the conservatory were blue-black and their brothers with only glass between them were whitey-brown in the vinery; and while the roots of the conservatory Vine are being relaid in the vinery, and only a heat of 40° or so kept in the conservatory, the Vines there have shoots 3 and 4 inches long to-day to our amazement, whatever Vine doctors like you may think of such proceedings. I do not believe one Vine root has moved as yet. "Now to grow Vines without roots," is the Vine sap so condensed in the old stems that there is enough of it to send out the shoots 3 or 4 inches long ere the roots are of the least use as feeders? It is all botheration to your old *attaché*.—J. MACKENZIE, M.D.

[Vines usually produce more than 3 or 4 inches of growth before root-action commences.]



[By the most skilful Cultivators in the several Departments.]

HARDY FRUIT GARDEN.

Protection.—The fickleness of our climate ought to induce more attention to protection of the trees in early spring than has hitherto been given to it. High walls, fences, and belts of trees do much, but cold north-eastern winds swoop over them upon every

detached tree in the open squares, and destroy the blossom so frequently, that a really abundant fruit crop is an exception. Standards and other unpruned trees must be left exposed to this risk of failure, but closely pruned bushes, pyramids, and espaliers should be protected by every means in our power. Now is the time to prepare for this important work, and there are few gardens without some materials for rough-and-ready shelter. For espaliers there is nothing better than thatched hurdles. Straw, rushes, heather, green Broom, branches of Box or Yew—all or any of them answering for "thatch," provided the thatching is well done. Pack the material used so thickly upon the hurdle that wind cannot blow through it, and take especial care to fasten it securely by means of bean stakes or thatching rods laid upon it and tied to the hurdles. Buds are already swelling, and protection will probably be required early this year. Put a row of thatched hurdles upright, with the lower ends thrust into the soil, a foot from the trees on the north or east side; put another row of hurdles upon them, leaning forward sufficiently to project over the tops of the espaliers, fastening the top hurdle securely to the lower one with string, and supporting the top with poles driven into the ground in front of the espaliers, and you will thus give shelter from frost, and break the force of the wind sufficiently to save the blossom from injury. Diagonal cordons out in the open can also be protected by this means, and a single row of hurdles driven into the ground aslant and fastened to stakes will suffice for the lower horizontal cordons.

Dwarf bushes and pyramids should have a skeleton framework of poles driven into the ground and tied together at the tops for a

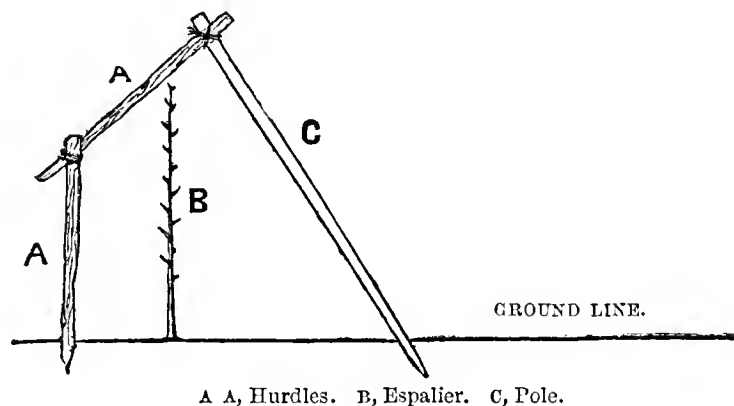

A A, Hurdles. B, Espalier. C, Pole.

Fig. 48.

covering of mats on the cold north and east sides, or any other contrivance with materials ready to our hands. In thus advising an elaborate use of every means of protection, in fairness to gardeners it should be mentioned that it will involve much extra labour at a busy season of the year, and where there are many trees extra assistance should be allowed.

FRUIT-FORCING.

Peaches and Nectarines.—Disbudding in the early house should be completed by the time the fruit commences swelling freely, but if this has been delayed it must at once have attention. As a rule the gross foreright shoots should be removed first, as otherwise they would rob the weak ones formed at the base of the bearing wood and intended to give next year's supply of fruit. Disbudding, if deferred until the fruit commences swelling, must be done very gradually, taking off a few shoots daily, together with any small fruit at the under side of the trellis, or otherwise badly placed for receiving light and air. A little stimulus may now be given weakly trees by mulching with short sweetened horse manure, and occasional dampings of the borders and paths with liquid manure. Syringe twice a day. Trees in the house started early in the year will have set their fruit, and when this is completed syringing must be commenced, and they must be disbudded as advised for the earliest trees. In the earliest house maintain a temperature of 55° to 60° at night, 5° more by day, rising to 80° from sun heat with a free circulation of air, and close at 70° with a copious syringing.

The trees in succession houses are coming strongly into bloom, and where this is abundant a portion of it should be removed by drawing the hand the reverse way of the growth on the under side of the trellis. Attention where it is considered necessary must be given to fertilisation. Although it is inadvisable in most cases to syringe the trees when in flower, yet the borders, floors, and walls should be damped two or three times a day, except when the weather is very wet. Late houses should be well ventilated, every means for retarding the blooming being adopted. Water the borders thoroughly.

Pines.—For the plants in pots soil will need to be prepared in

quantity, as during this and subsequent months the plants that have been wintered in small pots must be transferred to a larger size. Plants in 7 or 8-inch pots should be shifted into pots 10 or 11 inches in diameter for Queens, and 11 or 12 inches in diameter for the more robust-growing kinds. As the operation must be carried out without much further postponement, a sufficient quantity of materials should be housed at once, in order that it may become drier, reducing the sods to pieces about 2 inches square, discarding the small and retaining the fibrous portion only. In potting ram the soil firmly around the old balls of soil, water at once thoroughly, and replunge into a brisk bottom heat of 90° to 95°, keeping the top heat at 60° at night and 65° by day from fire heat, and 70° to 80° from sun heat, it not being desirable to encourage top growth until external conditions are more favourable. Make provision for potting the suckers which are to be started next month, and, if space will admit, it is advisable to keep them on the stools until they are wanted for starting. In the fruiting department early plants will be rapidly approaching the flowering period, and should be wetted as little as possible, as the sun has not sufficient power at this season to evaporate the moisture which settles at the base of the flower, and is the cause of the discolouration which exists too frequently at the base of the pips, spoiling the appearance of the fruit. Maintain a steady temperature of 70° at night, 75° to 80° by day, and 80° to 90° from sun heat. Ventilate at 80°, and close with moderate moisture at 85° to 90°.

Figs.—Continue the treatment recommended for early trees in pots, avoiding a high night temperature until the days are longer and brighter, when all that is now apparently lost will be gained by the increased vigour of the trees and rapid advancement of the fruit by judicious management in early closing with plenty of sun heat and moisture. If the roots fill up the space left for watering, place a rim of lead inside the pots about 3 inches deep, and fill this with rich mulching. Syringe twice a day in fine weather, but moisten the paths, walls, and surface of the bed only when dull, as it is important the foliage be dry before nightfall. Stop gross shoots a few at a time, following as far as space admits the extension principle, and remove a few of the badly placed fruits if too thickly set, as will be the case with well-managed trees in pots allowed to rest early in the autumn. Continue the temperature at 55° to 60°, mulching and watering freely as a means of keeping the roots near the surface, and so securing the fertility of the trees. Complete the pruning of trees in the latest houses, the shoots being regularly thinned and trained over a trellis 16 to 18 inches from the glass, and when the bearing wood reaches the extremity of the trellis it should be cut away to make room for the most promising successional shoots, which produce an abundance of young fruits on ripe wood ready for development in the spring.

PLANT HOUSES.

Stove.—*Ixoras*, *Franciseas*, *Tabernæmontanas*, and other similar evergreen plants will now need attention, and should be repotted if they require it. They will flourish well in peat, loam, or a mixture of both, but the former with a good quantity of coarse silver sand is preferable, as it does not become sour so quickly as loam or a mixture of both, which is a decided advantage in the cultivation of these plants. In potting the roots of the old balls must not be disturbed, merely removing the crocks from amongst the roots at the base and the loose soil from the surface of the ball. No attempt should be made to liberate the roots with a pointed stick, as they are often much injured in that way. Press the new soil firmly into the pots round the old balls, and there need be no fear of the roots entering freely into the fresh soil. The old balls before potting should be moist, so that no water will be needed at the roots if liberally syringed for at least a week after completing the operation, which will give the roots a chance of recovering from the injury received in potting. These plants will bear hard cutting back if they have become straggling. The *Ixoras* should be pruned and allowed to start again before repotting. The other two can be potted and then cut back after flowering, by which time they will be well established in the new soil.

Cuttings of *Ixoras* and *Tabernæmontanas* will now root freely if inserted in small pots and placed under a bellglass in brisk heat or in the propagating frame. The first-named are invaluable for decorative purposes in small pots, bearing one or two fine trusses of flower. *Franciseas* root freely when the young wood is employed for cuttings, taken off with a small heel after flowering.

Anthurium Schertzerianum that has been resting in a temperature of 50° to 55° can now be brought into the stove, and will quickly start into growth and produce its fine scarlet spathes.

This plant should be grown in quantity where the stove is required to be gay through the spring and early summer months, as it can be brought into flower at a time when the stove would otherwise be rather short of flowers. This is one of the best plants that can be grown for producing a long succession of flowers. It can be pushed forward, and delights in brisk moist heat while making its growth, or will bear retarding. When the roots commence advancing top-dressing or potting can be done, as this plant will not long continue healthy with sour soil about its roots. Every alternate year the whole of the compost should be removed from amongst its roots and renewed with fresh, using fibrous peat from which the small particles have been shaken, and sphagnum moss in equal parts, with the addition of charcoal and coarse silver sand. The pots or pans employed must be a little more than three parts filled with drainage, and the plants well elevated above the rim and surfaced with a good layer of sphagnum, which should be encouraged to grow.

Greenhouse.—Show and Fancy Pelargoniums. The most forward batch of these plants, if required to come into flower as early as possible, should, if not already done, be placed in their flowering pots. The shoots must not be pinched again after this date, but staked so that they will not draw up weakly. Keep them near to the glass in a night temperature of 50°. After potting keep them close for ten days until they commence rooting into the new soil, and then ventilate liberally when favourable, and slightly at night also when the weather is mild. Succession batches should receive attention in the potting from time to time as they require it, and take out the points of the shoots when they have made about four joints. Keep these plants in a temperature of 45°, and give the same treatment after potting as advised for the early batch. Use a compost of rich fibry loam, a seventh of decayed manure, a little soot and sand. Press the soil firmly into the pots, which will cause a firm stocky growth and assist in keeping the plants dwarf, which in due time will produce abundance of bloom. Any of the old stock plants that have become leggy may have the cuttings taken from them and be thrown away. Cuttings inserted singly in small pots and placed on a shelf in a temperature of 60° will root freely. When rooted pinch out the point of the plants, place them in 5-inch pots, and valuable plants for late flowering will be produced. Water these plants carefully for some time after potting; if kept too wet at the roots the foliage becomes spotted, and in consequence much injured. Supply the early batch with clear soot water when the pots are full of roots. Destroy aphides by fumigating with tobacco paper as soon as they appear.

THE BEE-KEEPER.

FEEDING BEES IN AUTUMN, SPRING, AND SUMMER.

(Continued from page 144.)

NOT only now, but sometimes in the height of summer, feeding is obligatory. Every experienced bee-keeper can well remember seasons when swarms have starved to death in their hives during June and July. The swarm is hived and placed on its stand to shift for itself. A succession of wet days sets in, and the poor bees, left to their fate in an empty house, are found by the ignorant or careless owner a mass of corruption on the floor-board. Even during favourable seasons there are periods of great scarcity of food in most neighbourhoods, and if the bees are not fed during such seasons breeding will quite or nearly cease, and the hive will be going back just at the time when the accumulation of strength is most needed to be ready to take advantage of a succeeding honey harvest. Notably between the flowering of the fruit trees and the Clover harvest there is a dearth of food, and the man who wishes his bees to do their best will carefully feed them over that trying and depressing interval. A few pence spent on sugar, and a little extra trouble, are amply repaid by the honey stored by the bees hatched out during the two or three weeks of gentle feeding. In districts where Heather is expected the harvest will begin from the latter part of July to the middle of August, and with fine weather last until late in September. In the south the former date will hold, and in the north of England and in Scotland the latter period will be near the mark.

Another season of dearth usually is experienced between the end of the hay harvest and the opening of the Heather flowers. This interval is in some districts filled by crops of other kinds and by the Lime trees, but often the bees find little food between the two great harvests mentioned. Here is another occasion for feeding; and to

the man who means to get as large a harvest of honey as his bees are capable of collecting for him, it is an occasion of obligatory feeding. So long as sufficient honey is in the hive to supply all the wants of the bees gentle stimulative feeding will suffice, or even the occasional uncapping with a sharp knife of a small portion of sealed stores. The bees in removing this uncapped treasure and re-storing it in another place cause that excitement in the hive which is necessary to induce the queen to continue laying. But it will be said by some, "If you keep up such constant work in the hive the queen will soon wear out." And such is truly the case. A queen must certainly have the power only to deposit a certain number of fertile eggs during her lifetime, and if we put on such high pressure she must fulfil her life's duties and complete her complement in a shorter period. For this reason queens should not be allowed to remain at the head of a colony much over two seasons. A hive should always be set apart, and that the best hive in the apiary, for supplying young queens, and these young queens should at favourable opportunities be put in the place of queens advancing into their third year of work.

There is one other case of obligatory feeding which must be noticed, and that is winter feeding. This, with proper management, should hardly ever be necessary, except through the effects of some accident. During a violent gale and snowstorm some years ago a bar-frame hive was completely overturned and buried under the snow. We dug it out, finding many bees killed, the frames in wild confusion, and the mass of bees huddled together under a comb at one corner of the hive. Little life was apparent, but they were brought into a well-warmed greenhouse, a new hive placed at their disposal, and their combs (at least those remaining whole) were cleaned and re-adjusted in the new hive. In a short time the mass showed the good effects of the warmth, and movement began. Warm food was first gently sprinkled over them, then when they got active given by the usual method through a feeding stage, and the stock was saved, a little thinned in numbers, but soon making up in the following spring for the loss. We only mention this as an example how to act in such an emergency, and accidents will happen in the best regulated apiary. Whenever food is absolutely required in winter it should be given warm and in a warm place.

Our subject of feeding is not yet exhausted. We hope to call attention at a future time to the methods of preparing and giving other food than syrup as substitutes for the nitrogenous foods which bees require before they can rear brood. Water also is an important requisite, and much bee life is often saved by the artificial administering of water to the bees. We wish that other evidence had been forthcoming from experienced bee-masters regarding autumn feeding. We know of many who are authorities on the subject who would hold the same ideas as we have attempted to explain.—P. H. P.

BRITISH BEE-KEEPERS' ASSOCIATION.

THE annual General Meeting of the members of this Association was held in the Board-room of the Royal Society for the Prevention of Cruelty to Animals, 105, Jermyn Street, on Thursday, 15th inst. There was a large attendance of members, the chair being taken by the Baroness Burdett Coutts, the President of the Association. In moving the adoption of the report and balance-sheet for the past year, her ladyship congratulated the members upon the success which had attended their efforts to promote and extend the knowledge of bee-keeping throughout the United Kingdom. She considered great thanks were due to the Committee, and more especially to the Honorary Secretary, for their labours to make bee-keeping a great national industry.

Votes of thanks were accorded to the retiring officers, and the following were re-elected for the ensuing year—viz., President, the Baroness Burdett-Coutts; Treasurer, W. O. B. Glennie, Esq.; Auditor, W. A. Kirchner, Esq.; Librarian, Mr. G. Henderson; Honorary Secretary, Rev. Herbert R. Peel. In returning thanks for his re-election, the Honorary Secretary called attention to the benefits which could be derived from the establishment of a Bee-keeper's Club in some central part of London, where meetings might be held, and the Association's library be deposited. A large increase in the present amount of subscriptions must, however, take place before this project could be realised.

The acting Committee of the Association is elected annually by voting papers. The following gentlemen have been elected for the ensuing year:—viz., Rev. E. Bartrum, Hon. and Rev. H. Bligh, Capt. C. D. Campbell, Thos. W. Cowan, Esq., J. M. Hooker, Esq., H. Jonas, Esq., Rev. G. Raynor, Rev. F. T. Scott, D. Stewart, Esq.

The Secretary reported that communications had been made with the several railway companies for the purpose of obtaining a reduction in the rates charged for goods and for exhibitors' fares to and from the various county bee and honey shows held annually throughout the United Kingdom, and announced that the matter would be taken into consideration at a conference of the managers of the several railway companies to be held in April next.

An animated discussion ensued upon the following motion, proposed

by the Rev. W. E. Burkitt (Wilts), and seconded by Capt. Campbell (Surrey):—"That it is desirable for the British Bee-keepers' Association to publish a 'Penny Guide' to the management of bees in straw skeps." The motion, having been amended as follows, was passed unanimously:—"That it is desirable for the British Bee-keepers' Association to publish small pamphlets to the management of bees for the special use of cottagers, including one on the most profitable use of straw skeps."

SMALL SECTIONS—BEST BEES.

We are a great people, but, withal, a little eccentric; and I think I never saw the latter characteristic crop out more prominently, at least in bee-keeping circles, than in the half-pound section business.

Because two or three honey-producers, who believe in the grand principle of ever marching forward, and who like to experiment and indulge in novelties, put a few half-pound sections of honey in nice shape on the market, and found a good sale for it; why, about half of the bee-keeping fraternity seem to have gotten half-pound sections on the brain!

It is contrary to good judgment to expect the half-pound sections to ever become universally in demand; for there are a few who always seem to think that acting ridiculously is the displaying of wisdom. The majority of honey-consumers will prefer to buy just as little wood as possible, at from 20 to 30 cents per lb. The Irishman said that he wanted just as much whisky as possible and as little quinine in his prescription as would make it legal. So the most of the honey-buyers will want as much honey as possible and as little wood for the money.

In view of this fact I think the majority of bee-keepers had better stick to the 1 lb. and 2 lb. sections, for awhile yet at least. I know one that will at all events.

I have looked on with very much interest in the discussion as to the merits of the different varieties of bees, that has been indulged in with so much ability and warmth by some of the apicultural gladiators in our country; and the result of the discussion, to my mind, has been a complete routing of the three-band advocates. While the thorough-bred Italians with their beautiful yellow bands are, as a rule, very docile and always pleasing to the eye of one who loves the beautiful, I am fully persuaded that for honey-gathering the dark-coloured (or hybrids, if you please) are much superior, as a general thing, to the golden beauties. While this seems to be the experience of a majority of our experienced apiarists, it is most decidedly mine. That this is true I very much regret, for if there is anything that I love to look upon it is a colony of beautiful yellow bees.

Now, while what I have said as to the superiority of the dark bees as honey-gatherers, I am much inclined to think there is a remedy for it, and that is in the selection of the good honey-gatherers from among the yellow bees as breeders, and the merciless beheading of every queen whose progeny prove to be indifferent workers. No difference if her bees have forty gold bands, let her go to the "block," unless the bees are good for business. I am quite certain that it is the in-breeding of the American Italians for bands instead of for workers that has wrought the mischief in the ranks of yellow bees. If the yellow bees are expected to keep abreast of their more homely and irascible neighbours as business insects they must be judiciously selected.

There are good workers among the most beautiful yellow bees I know, and if the breeders of these would breed from nothing but such there would soon be less to say about the yellow bees being inferior to the dark as workers. The trouble has been, that if a queen-breeder of Italians had a golden queen whose progeny were a beautiful yellow, she was valued very highly, without reference to the business qualities of her bees at all. All this must be speedily changed if the golden-banded beauties are to hold a place in the affections of our best apiarists.

Dr. F. A. Grove of Kirksville seems to have the right notion about keeping bees for profit. He keeps bees, poultry, a little other good stock, raises a little small fruit, and cultivates a good vegetable garden. I am quite certain this is better for the majority of bee-keepers than to keep bees alone. My advice to all beginners is, Go slowly, and learn as you go. He who rushes into a business up to his eyes, of which he knows comparatively nothing, is apt to get his profits all on the debtor side.—Dr. J. R. BAKER (in *American Bee Journal*).

TRADE CATALOGUES RECEIVED.

Harkness & Son, Bedale, Yorkshire.—*Catalogue of Florists' Flowers*.
Cranston's Nursery and Seed Company, King's Acre, Hereford.—*List of New Roses for 1883*.

Wrench & Sons, Ipswich.—*Catalogue of Horticultural Buildings and Heating Apparatus (Illustrated)*.



* * All correspondence should be directed either to "The Editor" or to "The Publisher." Letters addressed to Dr. Hogg or members of the staff often remain unopened unavoidably. We request that no one will write privately to any of our correspondents, as doing so subjects them to unjustifiable trouble and expense.

Correspondents should not mix up on the same sheet questions relating to Gardening and those on Poultry and Bee subjects, and should never send more than two or three questions at once. All articles intended for insertion should be written on one side of the paper only. We cannot reply to questions through the post, and we do not undertake to return rejected communications.

Addresses (E. P. C. B. France).—If you write to Messrs. J. H. Wagner, Riga; Damman & Co., Portici, Naples; Besson & Son, Turin, you will probably obtain what you require. Seed of the shrubs last mentioned, we think, can be had from Vilmorin & Co., Paris.

The Type of Apples (R. B.).—Neither climate nor cultivation nor cross-fertilisation between varieties can change the type of a fruit, and to this rule the Apple is not an exception.

Garden Map (E. B. B.).—We do not think there is any work such as you describe published now, nor do we think such a compilation would be of substantial value. It would be more fanciful than serviceable, and it is for that reason probably that it was not continued.

Quassia Water and Soft Soap (W. J. J.).—If you boil 4 ozs. of quassia chips for a quarter of an hour in a gallon of soft water, strain off the chips and add 2 ozs. of soft soap, and stir until it is dissolved, you will have a solution that will destroy the aphides on your Cucumber plants. You will do well, however, by timely syringing to prevent the attacks of the insects.

Peach Trees Injured (W. T. Kent).—Galvanised wire is undoubtedly injurious to Peach trees, in smoky districts especially, and some kinds of this wire are injurious to the growths anywhere. You will find the records of some experiments, and much that will interest you on this subject, in our issue of January 13th, 1881. If you do not possess that number it can be had post free from this office for 3d. Two or three coats of paint generally render the wire quite safe for use.

Position for Flower Beds (Amateur).—The position will be quite suitable for the flowers you name; but whether you will produce "first-class blooms in size, form, and quality" will depend entirely on the excellence of the varieties from which seed was saved, and the culture to which the plants are subjected. You will find mulching the soil in summer of great advantage, and a dressing of heavier compost, with manure, will also be requisite. Let the Asters and Verbenas have the coolest position, as neither of them thrives in sandy soil, and especially if the summer proves hot and dry.

Messenger's Valve for Hot-water Pipes (Inquirer).—We have not

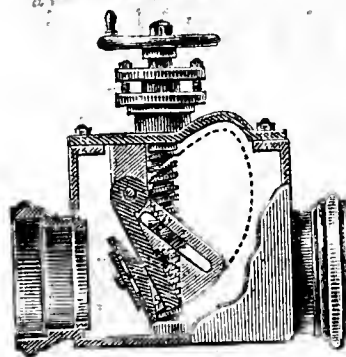

Fig. 49.

used the valve to which you allude, but we have no doubt it is good or it would not have been awarded a silver medal by the Royal Horticultural Society. It is described by the makers, Messrs. Messenger & Co. of Loughborough, as possessing the following advantages:—When open it gives a perfectly free water-way of the full bore of the pipe; it can be closed easily against any pressure, and when closed is perfectly tight. The spindle and working parts are made of brass. By unscrewing four nuts the lid can be taken off, withdrawing the whole of the working parts, and a new rubber can be placed on the valve and the lid replaced without disturbing joints of the pipes. Repairs can be done in a very few minutes. It is direct-acting, and works with but little power. This is also made as a double valve, forming a syphon in the body when closed, and is then used for

connecting two systems of heating, as the water will syphon through the valve when it is closed.

Select Phloxes (F. J. B., Coventry).—Several lists have been published since the time you name, including the following, but you appear to have overlooked them:—Twelve good curly-flowering varieties are Pearl, Mrs. Hunter, Cicerone, Mrs. Shanks, Vulcan, Marquis, Mrs. Morrison, Oberon, Mrs. McLellan, Mrs. Garrett, Mrs. Taylor, W. W. Platt. Good late-flowering varieties are Brilliant, Miss Wallace, Gladstone, David Thomson, Coccinea, Madame Bonneau, Madame Verrier, Princess of Wales, Splendour, Virgo Maria, Walter Ware, York-and-Lancaster. If you happen to possess these varieties and will send us a list of what you have, we will name some others that you will find worth adding to your collection.

John Downie Grape—Arnott's Stove (H. S.).—We have seen this Grape and tasted the fruit, but more experience is needed before the questions you ask can be satisfactorily answered. The variety is not yet in commerce. There is no method of heating so good as a boiler and hot-water pipes. An Arnott's stove is serviceable for excluding frost, and its merits consist in its slow combustion and fireclay lining, which absorbs the heat from the fuel and diffuses it steadily and for a long time.

Melon House (Reader).—If you place on the slabs an inch of gravel or ashes and cover with turves grass downwards before introducing the soil the bed will answer quite well, provided you apply water sufficiently, yet judiciously, to keep the soil at the bottom of the bed moist. Your second question you have not made clear. Melons cannot be profitably grown during the winter, but with good management a second crop can be had from the same plants. If you cannot accomplish this we should grow the successional plants in pots plunged

in the old heds, preparing the plants in another house or frame so as to be strong and ready for placing in the fruiting pots immediately the first crop is removed. Any of the early varieties will answer, some persons preferring green, others scarlet-fleshed kinds. We are not at all certain we have comprehended you letter, which is very obscure, as in one part you say the crop cannot be cut till August, and in another you ask how you can turn the house to good account in June. We often feel that if correspondents were to exercise the same care in asking questions that we do in answering them, they would obtain information that would be more useful.

Insects in Mushroom Bed (B. T., Bradford).—It will be very difficult to destroy the insects in the bed without injuring the Mushrooms. You might try the effect of salt, dissolving from 1 to 2 ozs. in a gallon of tepid water and applying it to the bed. This, especially if the material is rather dry, will improve the Mushrooms and possibly destroy many of the insects. If this fails you might try the effects of quassia water, an ounce being hoiled in a gallon of water for twenty minutes and poured on the bed between the Mushrooms, not on them, as it will turn them bitter. A small work on Mushrooms that will suit you is now ready for press and will shortly be published.

Ventilating a Pine Stove (F. C.).—If you examine the roof you will probably find that the spaces between the panes of glass vary considerably. It may possibly, under the circumstances, be desirable to putty up a few of the laps, but we should not stop many of them. It will only be during very cold weather that you have a difficulty in maintaining the heat at the requisite figure, and a comparatively low temperature for a time when the pipes are hot will do no harm. It will not be necessary to open the front sashes at any time, except to prevent the temperature rising above 85°, and it would be very undesirable to open them at this season of the year.

Various (Inquisitive).—When you allude to a circulator boiler we presume you allude to a boiler for heating a glass structure of some kind. If such a boiler leaks to any great extent it will obviously soon be inoperative. We have stopped leakages with a mixture of red lead and iron filings; an iron cement can also be obtained at foundries and from some ironmongers that is useful for this purpose. There is no harm in allowing a bunch of Grapes on the leading shoot of a Vine, the rod of which reaches to within 3 feet of the top of the house, provided the Vine is not overcropped. We do not know the name of the Apple that is known in Cheshire as the Long Keeper, perhaps some of our readers can supply the information.

Grubs on Fruit Trees (W. C., Stroud).—The two caterpillars you describe appear to be (1) that of the small ermine moth, *Yponomeuta padella*, (2) that of the winter moth, *Cbeimatobia hrumata*. Little can be done, as you remark, with either species when the caterpillars have begun to form their webs except by actually picking them off—a tedious process. In the case of the worst of the two pests, the winter moth, it is found of benefit to search for the patches of green eggs, which are tolerably conspicuous upon the bark of fruit trees; also there is advantage in drawing a line of some sticky mixture round the foot of trees, so that the moths cannot ascend in the winter to lay their eggs. This plan is commonly pursued in Germany, where the insect is very mischievous. The moths of the small ermine species, although small, are conspicuous, and many of them may be destroyed by shaking trees or bushes into a sheet at the period of their emergence. See also notes on preventing insects on the first page of this Journal.

A Strange Plant (Salburn).—That a plant may be induced to grow in the way you suggest—namely, by hurrying the branches in the earth and having the roots in the air, is well known, but it is almost as unnatural for a plant to exist in such a position as it would be for you to stand upon your head when taking your meals, though if you are as tenacious of life as the plant mentioned you might continue to exist for some time.

Planting Roses (J. B.).—The most important matter to be attended to at this season of the year is to take care that the roots do not become dry by exposure to the air. There is no doubt the seedling Briar will succeed as well as any other stock on your strong soil. You may safely shorten the roots, removing all jagged or otherwise injured portions with a sharp knife; and we do not think that removing half their length would injure them in the slightest, the tops to be closely pruned at the same time. By all means place some lighter soil round the roots; this will greatly expedite the emission of fibres, and bone-meal would afford food for the plants. As to the depth of planting, you do not afford us the requisite data for deciding the point. If the huds have been inserted quite close to the roots you can scarcely avoid covering the worked part, and in such a case we should have no hesitation in covering it; while, on the other hand, we should not place the roots too deeply for the sake of covering the parts where the Rose is attached to the stock. As to its being fatal to Roses on seedling Briars planted so as to cover the union, we can only say we have had no evidence of this, but we have seen hundreds of plants so planted grow satisfactorily.

Vines too Luxuriant (E. T., Norfolk).—The portion of lateral simply enclosed in a letter was crushed almost to pulp, only a small portion of the bunch remaining uninjured. In all probability you placed the manure on the border rather too soon, and possibly it may have been too hot. Still we do not think much damage has been done, and by selecting the more sturdy bunches you will produce good Grapes. The one sent is not satisfactory; but you say it is not one of the best, and as we have seen many worse than this, we consider you have no real cause for alarm. The dull weather has not been favourable for early Vines, and several days of sun, which are certainly overdue, will work wonders. Thin out the laterals so that the leaves on those retained are fully exposed to the light, stopping at one or two leaves, according to space, beyond the bunches, removing all sublaterals promptly at the first leaf. This stopping should be done the moment you can handle the points of the shoots with your finger and thumb, and you ought to be able to put all the portions removed at once into your waistcoat pocket. Do not damp the house during dull weather, and open the top ventilators, even if only slightly, very early in the morning. When you remove the manure spread a mixture of fresh loam and lime on the border and make it quite firm, as the soil is possibly too light as well as too rich. Half a peck of lime to a large harrowful of soil will not be too much. We are glad to hear you have profited so much by what you have read on Grape and Mushroom culture, and we wish you further success.

Treatment of Tuberos Begonias (L. M.).—Presuming that the tubers were potted in a good compost of turfy loam, sand, leaf soil, and well-decayed manure, they can be now brought steadily forward in a temperature of about 55°. If the pots can be plunged it will be an advantage, as that will decrease the necessity for frequent supplies of water. In any case as the growth advances the soil must not be allowed to become dry, and if the pots are well drained there will be little danger of giving too much water in fine weather later in the season. Weak liquid manure can be supplied at intervals previous to the expansion of the flowers, and if judiciously employed it will increase the

vigour of the growth and the size of the flowers, also deepening the colours. A light position must be provided, and not too far from the glass, as it is important to secure a sturdy growth. Syringe lightly occasionally until the flowers expand, when it should be discontinued, and at all times be careful to avoid a superabundance of stagnant moisture either in the air or the soil. Ventilate freely as the weather becomes warmer, and shade slightly when the sun is very bright. No stopping or training will be needed if the plants are grown strongly, but a few stakes may be required by weaker growers, and also when preparing the plants for exhibition, so as to avoid injury in transit. The flowers, too, should then be carefully enveloped in soft tissue paper.

Cucumbers and Melons in Pots (R. H. R., Westmoreland).—We never saw Cucumbers grown better in pots than at Eastnor Castle, nor out of pots either in a less quantity of soil. The plants were being prepared for winter, but the same method of culture with proportionately more water would answer equally well for summer culture. The soil was extremely rough. In its roughness indeed consisted its chief excellence. It was turf, no doubt, pared from good soil, yet simply turf, and used just as it was dug in large square junks. It is surprising how little of such soil is required to grow Cucumbers when it is rightly used. There overhead was a large trellis quite covered with shoots and foliage of the most satisfactory kind; below a narrow ridge of turves, the roots protruding through them in all directions asking for another thin casing of the same sustaining and enjoyable food. Periodical layers of turves, and liquid manure when the plants are heavily worked, are all the food required by Cucumbers. All they ask for is to have the turfy soil "little and often," and rough. In the next house, a succession house, the plants were in very large pots and the growth had nearly covered the trellis. The large pots are placed on a layer of "good stuff" over the hot-water pipes. Roots are not only encouraged to the surface of the pots, but over them. They are enticed over them by rich rough food. Turves are then packed round the pots, water being regularly poured in, and down the roots will go to the heat, moisture, and food below, gathering sustenance as they descend their moist, warm, dark, rugged path, and liquid manure freely given do all that is needed. That is what Cucumbers like—aerated food. What they do not like is a huge mass of close soil given all at once and done with. They do not like alternations of heat and cold, dry draughts and cold fogs, nor especially to be heavily cropped when young. Melons may have firmer soil. Temperature and pruning are the same whether the plants are grown in pots or beds.

Soil for Vine Border (Idem).—You have done quite right in adding the lime, and you would in all probability further improve the soil if you could add some of a heavier nature, as we presume the land is light. Burning or charring a portion would render it additionally fertile for Vines.

Culture of Dipladenia Brearleyana (C. B. B.).—The best compost for Dipladenias is a mixture of equal parts of peat and light turfy loam, with a small proportion of sand, leaf soil, and old well-decayed cow manure, thoroughly draining the pots, and if the loam is inclined to be heavy add a few small pieces of charcoal. During the spring and summer a temperature of 65° to 70° will be needed, with a still further rise to 80° in the afternoon when the sun is bright. At starting and afterwards the plants will be greatly assisted if they can be plunged in a bed having a bottom heat of 80°. During the winter—the resting period—a much lower temperature is required, about 60° to 65° being sufficient. Abundant moisture must be distributed about the house whilst the plants are growing, and frequent syringings will then be beneficial, but be careful in supplying water to the roots, never allowing the soil to become excessively wet, or the plants will suffer considerably. In winter scarcely any water will be needed. Thoroughly clean the shoots when training them and before growth is much advanced, and if that be well done there will be little difficulty in keeping them clean afterwards if they are liberally syringed. The Stephanotis will succeed with the above, and under similar treatment as regards temperature and moisture, though it will also grow and flower well in a temperature as low as 60°. It flowers in spring and summer, but by having a succession of plants introduced into heat at intervals of a month it can be had in flower all the year round. The supply of water should be reduced when the growth is matured, and during the winter very little will be required.

Names of Plants (A Young Subscriber).—1, *Asplenium furcatum*; 2, *Asplenium dimidiatum*; 3, *Polypodium pectinatum*; 4, *Insufficient*; 5, *Verbascum nigrum*. (C. Z.).—1, *Gymnogramma chærophylla*; 2, *G. calomelanos*; 3, *G. chrysophylla*. (W. R.).—1, *Tradescantia zebrina*; 2, *Begonia maucata*; 3, *Asplenium viviparum*; 4, *Adiantum macrophyllum*. (O. P.).—1, *Odontoglossum Alexandræ*; 2, *O. Pescatorei*; 3, *Phalænopsis Schilleriana*.

COVENT GARDEN MARKET.—FEBRUARY 21ST.

TRADE quiet, with forced vegetables somewhat lower. Hothouse Grapes firm, good samples in advance.

FRUIT.

	s.	d.	s.	d.		s.	d.	s.	d.			
Apples.....	½	sieve	2	0 to 7	0	Grapes	lb.	2	0 to 6	0		
"		per barrel	20	0	40	0	Lemons	case	10	0	20	0
Apricots.....	doz.		0	0	0	0	Melons	each	0	0	0	0
Cherries.....	½	sieve	0	0	0	0	Nectarines.....	dozen	0	0	0	0
Chestnuts.....	bushel		10	0	12	0	Oranges		100	0	10	0
Currants, Black..	½	sieve	0	0	0	0	Peaches	dozen	0	0	0	0
"	½	sieve	0	0	0	0	Pears, kitchen ..	dozen	1	0	2	0
"	½	sieve	0	0	0	0	"	dozen	1	0	2	0
Figs.....	dozen		0	0	0	0	Pine Apples, English	lb.	1	6	2	0
Filberts.....	lb.		0	0	0	0	Raspberries	lb.	0	0	0	0
Cohs.....	100	lb.	0	0	0	0	Strawberries	lb.	0	0	0	0
Gooseberries	½	sieve	0	0	0	0						

VEGETABLES.

	s.	d.	s.	d.		s.	d.	s.	d.			
Artichokes.....	dozen		2	0 to 4	0	Lettnces	score	1	0 to 1	6		
Asparagus, French	bundle		25	0	30	0	Mushrooms	punnet	1	0	1	6
Beans, Kidney	100		2	0	0	0	Mustard & Cress ..	punnet	0	2	0	6
Beet, Red.....	dozen		1	0	2	0	Onions	bushel	2	3	2	6
Broccoli.....	bundle		0	9	1	6	Parsley..... doz.	bunches	3	0	4	0
Brussels Sprouts..	½	sieve	1	6	2	0	Parsnips	dozen	1	0	2	0
Cabbage	dozen		0	6	1	0	Peas	quart	0	0	0	0
Capsicums.....	100		1	6	2	0	Potatoes	cwt.	6	0	7	0
Carrots	bunch		0	4	0	0	"	cwt.	6	0	8	0
Cauliflowers.....	dozen		2	0	3	0	Radishes... doz.	bunches	1	0	0	0
Celery	bundle		1	6	2	0	Rhubarb	bundle	0	4	0	0
Coleworts.....doz.	bunches		2	0	4	0	Salsafy.....	bundle	1	0	0	0
Cucumbers.....	each		0	9	1	3	Scorzoneria	bundle	1	6	0	0
Endive.....	dozen		1	0	2	0	Seakale	basket	1	0	2	0
Fennel.....	bunch		0	3	0	0	Shallots	lb.	0	3	0	0
Garlic	lb.		0	6	0	0	Spinach	bushel	3	0	0	0
Herbs	bunch		0	2	0	0	Tomatoes	lb.	1	6	2	0
Leeks.....	bundle		0	3	0	4	Turnips	bunch	0	2	0	3



POULTRY AND PIGEON CHRONICLE.

INDICATIONS OF FERTILITY OR BARRENNESS OF SOILS.

(Continued from page 147.)

WE seldom find a whole field of 20 acres without variations in the subsoil as well as the surface soil, but especially so in the case of gravel, sand, or clay. Chalk, however, is more uniform in the subsoil, but varying also like the others on the surface. The same may be said of stone and marl soils, for frequently we find that these subsoils of stone or marl are very different, not in colour alone, but in their mixed composition, and contain gravel, sand, or limestone particles. It is well known, and we clearly see in arable land, that the composite veins of soil each exert a peculiar influence on crops. On pastures, although the influence may still exist, the grass does not allow us to discern those differences which are so clearly seen in farm crops. It is therefore on pasture land chiefly where the novice will find the most difficulty in ascertaining the soil and its variations. If, however, there is a growth of timber such as exists in various districts, there is no better indication of the hidden subsoil than the kinds of timber which flourish most, upon which matter, however, we shall have to enlarge in another place, for these more properly come under notice as illustrated indications of subsoils generally.

On irrigated pastures we find fewer indications of either fertility or the reverse; nor is it so essential, because the flood water brings with it deposits every year with but little variation if the water is judiciously laid on and carefully regulated, so as to feed the surface with the deposits from the highlands. Still there are some peculiar features connected even with irrigated meadows, for if well cared for the greenness and abundance of the produce may be equal, yet the best subsoil will yield the sweetest and best herbage, making frequently 20s. per ton difference in the value of the hay produced. As an illustration of this, there is no more productive land as to quantity of hay grown than that produced on peaty soil when judiciously flooded with water from the hills. Still the best and most valuable irrigated produce when converted into hay is obtained from a good sound brown or grey loam when watered by springs and floods derived from the foot or base of the chalk hills wherever they may be found.

We cannot leave our subject without referring to the extensive tracts of meadow lands, especially in certain enclosed districts where clay land predominates, for they are mostly composed of a peat soil for a considerable depth, and buried in these soils we have often seen the bodies or trunks of large trees. Although these and meadows consisting of peat subsoil are frequently much abused and neglected by the farmers, and therefore in an undrained state yield grass of an inferior quality either for dairy cows or young cattle, yet in our practice we have known these peaty meadows brought into excellent condition by a surface-dressing of clean fine gravel fresh out of the pit, or any earthy matters obtained from the borders and ditches of fields, for we find that after being completely drained these are extremely productive, especially in dry seasons.

On the chalk hills in various counties we find a considerable extent of poor pastures called downs. Although a large extent of them was broken up and converted into arable during the last

fifty years, those remaining are for the most part of inferior soil, which cannot always be properly characterised in consequence of the general practice of feeding sheep on them so continuously that very little produce is obtained. Store sheep in a poor and hungry condition not only eat the grass produce as close as that eaten by rabbits on a warren, but they also eat out the crowns and buds of certain plants and grasses, which under better treatment would become useful pastures. As at present fed the indications represent barrenness only, and superficial observers call them the poorest of grass land. But under superior management we have met with downs in several of the southern counties where the surface has been dressed with kainit, and the sheep kept from continuous grazing, and only allowed to feed when a good bite of grass has been grown, and even then only within a fold moved daily, and then left until another good bite of grass had sprung up, have greatly improved. Under this management, especially if the animals get such food as cotton cake extra, the pasture will improve yearly, and the difference of the pasture in the latter case may greatly deceive an inexperienced observer as to the nature of the soil in comparison with that so badly cared for under constant feeding and depreciation without manure, more particularly when the sheep carry off by custom all they get on the downs to a deadfold every night on the cultivated land. When, however, the grass is folded off and the sheep well fed, and leave their droppings both night and day, the turf may be considered as in an improved condition, although the nature of the soil may be the same in both systems of management.

The consideration of indications noticeable on cultivated soils now merits attention, and it opens up a wide field for observation and remark. But colour, although not entirely so, is one of the chief indications of barrenness, yet it embraces most all shades that can be mentioned, some of which are also indications of fertile land, frequently on account of the aid which is derived from the subsoil. However, barren soils are generally of a brown or black, but also of fox colour, fawn, pale red, and whitish yellow; a deep yellow is also a certain indication of barrenness. Soils having the following colours and appearances are barren:—Thin chalk soil which is nearly white, diluvial soils which contain a dead white gravel near the surface, moors and bogs which are nearly black to a considerable depth if not well drained, and the same kind of soil with a white sand under it, or with white gravel near the surface; soils principally composed of white silvery sand, white clay, blue clay, yellow clay, and pink clay. Most extraordinary exceptions, however, occur in the case of yellow clay formations, for on our property part of three fields of a yellow clay of a precisely similar appearance throughout all the fields which were inferior generally, yet the best parts were, in fact, so superior in production that the crops had been most abundant for a period of sixty years without the application of any manure during the whole time; but especially so of Wheat, Clover, and Beans, the two latter having produced respectively on certain occasions three sacks per acre of Broad Clover seed, and twenty-eight sacks of Beans per acre, the last-named being the produce of the harvest of the year 1812 as harvested by our predecessors on the farm. We have known something very like this vouched for in different parts of the kingdom. Such exceptional results are not to be discovered except by the actual produce, there being no indications beyond that of ordinary fertility in the appearance of the soils. Nor would chemistry aid us in ascertaining the value of such land as the three fields alluded to, except the most productive portions had first been discovered through cropping. Much land in this country, therefore, cannot, as a rule, be said to be properly estimated except under cultivation, and the variations of crops under ordinary circumstances.

Gravelly soils are barren in cases where a red scum rests on the surface of the water in the ditches of a ferruginous appearance, and shining bright like the bloom on a Plum or Peach. Such is the appearance of water in or near to bogs. In this case, however, it occurs through the iron ore, traces of which are frequently found in the dark red sort of concrete gravel in the subsoil, and this will vary much in some localities, for we know fields adjoining each other the surface of both being a kind friable gravel, but it is the subsoil gives the character or value to this soil. For when the gravel is loose at the bottom as well as on the surface it is moderately productive. When, however, the subsoil is almost as hard as iron as we have frequently noticed it, land is comparatively barren, and will show the ferruginous scum in the adjoining ditches, because the soil is completely impervious. Such land as this is doubled in value by steam-cultivating the subsoil, because it allows water to percolate freely, instead of being, as previously, too wet in the winter and too dry in the summer, there being little or no capillary action in the subsoil.

(To be continued.)

WORK ON THE HOME FARM.

Horse Labour.—This has been seriously delayed for a long time. Even those who were intending to make up the deficiencies in the autumn seed-time by sowing spring Wheat have been quite unable to execute the work in a decent husbandlike form, as the rains have been so heavy and so constant, that even upon the driest soils the work has been badly done. As, however, a heavy seed time is best for spring Wheat, we will hope that the result may be better than the present appearances indicate. Preparation should now be made for seeding both Beans and Peas either separately or mixed, but the latter is the safest, for both are seldom attacked with the aphides (their great enemy) in the same season. The land will this year be very heavy indeed. This, however, does not signify for Beans if the work can be done, and there is a small drill made to be attached to the plough which will deposit the seed in the furrow; otherwise we like the drill attached to a presser, so that the seed may fall into the grooves made by the rings of the presser at such distance apart as may be required. So much time has been lost, and this may still continue, in which case the carting of chalk or lime may be attended to, for on all our loamy soils there is a very serious deficiency of carbonate of lime in the soil generally; therefore the drilling of screened chalk should be done instead of using ashes in the drill or otherwise in addition there. Twenty-five bushels of chalk per acre will save the root crop from clubbing of the roots. Lime, however, in the absence of chalk should be used, and brought to the farm at odd times when the ordinary work of the farm is delayed. The mode of preparing lime for application is so important, that as soon as it reaches the farmer's land, and is deposited thereon in the shape of stones or shells from the kiln, in due time it should be spread as dry powder; but in the interval between depositing and spreading it should not be permitted to become wet, though rain may fall daily. We will advise that a field in preparation for Potatoes or other root crops, and ready to receive its quota of lime: the ground is marked off into points, two poles apart, and thus there are forty points per acre. The carts laden with shells are drawn on, and half a bushel is deposited on each point; the shells are then covered with some of the surrounding earth. In a few days the lime begins to protrude, and bursting through its earthy covering, and when it is slacked to admit of mixing. The heap is then broken down, and the lime and earth are mixed, and again made up into a conical heap; the lime is then considered safe, and its virtues secured. In a day or two it may be spread, after which no fall of rain can injure it, and it may remain the farmer's convenience as to ploughing in. As soon as the land becomes sufficiently dry where the Wheat is thin and has only partially vegetated, the surface should be dragged with Howard's self-lifting drag; this will not only improve the growth of what has come up, but it frequently admits the air, so that other grains may vegetate.

Horse-feeding and stable management is of the utmost importance. We never drive more than two horses to the plough at any time, and in summer only two to the double-furrowed plough, as it is heavy work on some land. The horses should be upstanding and heavy, and be well fed, in which case their actual weight will assist in the work and make it comparatively easy. Our allowance of corn has been 80 lbs. of Oats, with 2 cwt. of Clover hay, and about 70 lbs. of Carrots or other roots per horse per week all through the winter months, and until the Trifolium or other grass is ready for cutting in May.

Hand Labour.—Draining work required should be set out as soon as the land is white dry on the surface, for then the dark spots show exactly the wettest parts and the direction for placing the drains; and our plan, as previously stated in these columns, is still the best—viz., placing the drains down the incline of the land at distances in accordance with the wetness of the land. If, however, the land is wet from bird's-eye springs, then the drains should be cut across above the spring, in order to cut the water off before it reaches the surface. Women now should be constantly employed in such work as preparing roots for the cutter before the sheep, and also in looking over the ground, forking out any bunches of grass, &c., before the hurdles are set up for the folding. The ploughing-in of roots should now be done where the sheep cannot eat them, or where the plan is adopted to avoid keeping sheep, with the view of ploughing-in the crop for Lent corn. This is best done by two women pulling the roots and striking them together to free them from earth, and cast them greens and all into the Gardner's cutter, one man grinding them, and another spreading the cut roots. These men take turns in grinding and spreading. In this way about 12 or 13 tons of roots will produce as fine a crop of Oats as when the roots have been fed with sheep eating cake, hay, &c., and in fact it is too high-farming for Barley, when the land is in good cultivation in other respects, and yields so much straw as to frequently injure the sample for malting purposes.

Live Stock.—The home farmer should now consider his position as regards his ewes and lambs, for the position is really such as we have never known it before—five millions of sheep short in the kingdom as compared with ten years ago. Sheep for years to come, in accordance with general calculations, must be dear to buy for feeding, therefore the breeders will have the most profit where an average growth of roots and grass occurs. Why should the lambs be sold at light or usual weights, say 10 or 12 lbs. per quarter, when, in case they are fed until they reach 20 lbs. per quarter, they would realise 75s. or 80s. each? No part of their life will they pay more money, nor can sheep

of any age be bought to pay so much as the lambs kept on until they reach the above-named weight. In fact, it is now a complete reversal of circumstances, the breeder obtaining the chief advantage. Let the farms which have usually been grazing farms during the past now change over and save all the lambs until they reach heavy weights, also reserving as many ewes as possible for future breeding. We must now refer to breeding swine. We prefer to rear cross-bred animals by mating the Berkshire sow with a large white Yorkshire boar of the largest kind we can obtain, as weight for age and early maturity are best obtained by this cross, and at the same time the Berkshires make the best mothers and bring large farrows as to number, and they come into use not only very early, but yield the greatest proportion of lean to fat of any breed or cross with which we are acquainted.

There is another point in favour of cross-breeding, for the offspring are usually more healthy than when animals are continually bred on the farm without change of blood. We keep our breeding sows in yards of small extent, with a small shed attached, and feed them for the most part with green vegetables and a few beans or peas twice a day. The yard is fenced with iron cattle hurdles and floored with earth, the long horse dung being spread over the yard as fast as it arises at the cart-horse stables, and allowed to accumulate. This is found to make excellent and roomy accommodation for the sows, which are constantly treading down the dung and adding to its value by their own droppings and consolidating the mass, which would deteriorate more or less under ordinary circumstances. When the sows are about to farrow they are removed to a comfortable pen of about 10 feet by 10 feet under cover, and the like space in the open, fenced by ironwork, the manure being allowed to accumulate in the outside space. Here they remain until the young pigs are weaned, when they return to the yard again, as they are found to breed well, but would bring but few pigs in numbers if kept in close pens without exercise.

HOGG & WOOD'S ANNUAL SEED REPORT.—Messrs. Hogg & Wood of Coldstream observe in their report that of English Red and Welsh Red Clovers and Cowgrass really good examples are scarce and will be dear; medium seeds are not plentiful. Of foreign Reds, the crops on the continents of Europe and America are much under the average, and will, to a large extent, be required for sowing abroad. France will be able to send us some good seeds, but at a high price. White Clover on the whole is an average crop. Both fine and medium qualities will be fairly plentiful, but owing to the failure of the crop of Alsike prices will be higher than those of last year. The home crop of Perennial and Italian Rye Grass seeds is a fair average, and prices are considerably lower than those of 1882. Of foreign Italian there is an extremely poor yield, and prices are high. The natural Grasses are under an average crop, and for pure clean samples prices rule high. Of Turnip, Mangold, and other root seeds we have had a good yield of excellent well-matured seed of strong growth. The cost of Turnip seeds is nothing as compared with the difference between a good and bad crop, and it is a fact now pretty well known that a good stock of Turnip or Mangold seeds will produce several tons more weight per acre than an inferior stock.

WEBBS' FARM SEED CATALOGUE.—This work is noticeable as containing excellent original articles on the Turnip fly and finger-and-toe in Turnips, with illustrations showing the insects in their various phases as attacking the plants above ground, and the fungus which affects the roots and often seriously injures the crop. Remedies are proposed and means suggested for averting the attacks in question.

POULTRY AND PIGEONS

EGGS AND THE HATCHING SEASON.

"It is an ill wind which blows nobody any good." So says the old proverb, and we think we might add "and an ill rain." The late rains have indeed been disastrous alike to man, beast and bird, but we have already observed one advantage from them—viz., that eggs are hatching remarkably well. The effect which a damp atmosphere has upon the development of the germ within the egg is somewhat mysterious, but all observation has led us to think that a certain amount of damp is necessary to keep the thin skins which encircle the contents of the egg in such a condition that the chick when fully developed can with ease twist itself round in the shell, and so break its way out of it. Old henwives always complain that during east winds many chickens are "dead in the shells." The meaning of this somewhat strange phraseology is that chickens, which up to the hatching point had duly developed, are unable to extricate themselves, and so die unhatched. We have observed in incubators, even where there are the most careful precautions taken to keep up a moist atmosphere, that many fully developed chickens do not hatch, and that, in the shells of those which do hatch, the

aforsaid fine skins are harsh and dry, and not like those found in eggs hatched in a natural manner. All this points to the fact that moisture drawn either from the ground underneath or from the atmosphere is necessary for the due development and hatching of the chick. We have sometimes been inclined to think that this moisture must necessarily come from the ground under the nest, but our experience this spring leads us to think it can be equally well supplied from the atmosphere. We have had hens sitting in particularly dry places, but still every fertile egg (and nearly every egg has been fertile) has hatched.

During the last few days three birds set in dusty dry places have brought out thirty-five chickens from thirty-five eggs, a thirty-sixth having been clear. We never before remember like success, and believe that we have to thank the incessant and otherwise disastrous rain for it. The lesson to be learnt from this is, that where Nature can be followed and the hens can be allowed to sit out of doors, there, as we all know, will be the best broods. All hens are not, however, sufficiently hardy so to sit, and all premises are not sufficiently safe for them to be exposed: where, then, they are set in houses these should not be kept too dry. Many people continually sprinkle eggs under incubation with water; save in very hot weather we think the practice risky and likely to cause chills, and much prefer a sitting-house with a generally damp atmosphere.

There is another point of importance at this season. Thousands of eggs are annually bought and sold by fanciers for sitting. It is commonly thought that an egg is an egg, and that as long as it arrives unbroken it must be "good." Indeed, we have known otherwise sensible people who have bought eggs quite incensed with the vendor if every one has not produced a living chick, and declare that they have been taken in. Many things are necessary to insure the successful hatching of eggs which have travelled. To begin, the germ of life must be strong. There are different degrees of strength in the latent life of an egg depending upon the health and strength of the parent and other circumstances, just as much as there are different degrees of strength in the newly-born offspring of a viviparous animal. A weak germ of life in an egg, which if incubated when laid may come to real life, will not do so if the egg is shaken about. Then the egg must be fresh; in a quiescent state, especially if the egg be daily warmed by the return of the hen to lay again, the germ of life may lie dormant for many days, even for weeks; but for anything like the successful incubation of eggs which have travelled far it is absolutely necessary that they be set while still fresh. Why this should be so we do not pretend to say. Again, they must be thoroughly well packed, so as not to be jarred in transit. We have often related our method of packing, which is by no means an original invention of our own. Each egg is wrapped in newspaper; then a whisp of hay is twisted round it, and turned over the ends; thus encased, the eggs are placed on end (on which end we really care little, but generally put the large end downwards) in a basket. They must not be so loosely packed as to shake about, nor so tightly as to lose the benefit of the elasticity of the hay. We prefer baskets to boxes for various reasons. They are less easily jarred, and less liable to be thrown violently down on the ground, if they have, as all egg baskets should have, handles. A layer of hay should be put in the bottom of the basket, and another over the eggs at the top. The lid should then be carefully sewn on and sealed. The latter precaution is particularly necessary. All will have been done that possibly can be done by the sender if these directions be fully carried out. Even this care will not absolutely insure success. We have known cases in which there has been the strongest proof possible that fresh eggs sent in every way as we have directed have arrived off a journey in such a state that it would have been useless to set them. We had once superintended the packing of some, and knew all to be fresh. They went to no ignorant or inexperienced person, but to a lady fancier skilled in all poultry matters, who at once found that the contents of some absolutely rattled. Let not, however, our readers be deterred by these warnings from sending eggs even long journeys. These accidents are the exception, not the rule. Thousands of eggs every day safely travel long distances. We once sent twenty-four Golden-pencilled Hamburg eggs over one hundred miles; necessarily they were not all fresh, for we had but two hens. They were conveyed by country carriers at each end of the journey, by three rails, besides that most perilous of all conveyances, a transfer cart through London, and yet twenty-four strong chickens emerged from them. We have merely mentioned the possibility of even the best and best packed eggs being damaged in transit, because we know much of the unreasonable complaints which purchasers make if every egg does not hatch. As a rule, those who buy eggs are not the most experienced fanciers, and when failure follows, we believe it in three cases out of four to be the result of bad management in their incubation.

We will briefly state the points which must of necessity be observed. 1, Eggs which have travelled must be set under hens

and not in incubators. No seller can possibly be responsible for the non-hatching of eggs which have travelled and then been incubated artificially. Why this should be so we cannot entirely explain; experience has taught us the fact. Probably eggs of strong vitality will bear one non-natural process, not two. 2, They must be unpacked immediately on arrival and set in twenty-four hours. We believe this to be better than to set them at once. 3, They must be set under a quietly established hen in a clean nest. 4, A really good brood can only be expected if the nest be in a damp atmosphere or on the natural ground. In spite of many perils from careless porters, jolting carts, and rattling luggage vans, we believe that if senders and receivers of eggs would alike attend to these little *sine qua non* conditions, it would be possible conveniently to exchange eggs even with friends in the New World. We have known cases in which eggs have crossed the Atlantic safely and hatched well on the other side.—C.

OUR LETTER BOX.

Drumhead Cabbage and Thousand-headed Kale (M. D.).—These are so distinct that they can scarcely be placed in comparison in the manner you propose, any more than the Scotch Kale can be compared with the garden Cabbage. The Thousand-headed or Jersey Kale does not form "heads." It grows tall, produces large leaves, and an abundance of side growths that render it profitable; it is also hardy, and freely eaten by cows and sheep. You had better try it yourself, sowing the seed in March, and inserting the plants when large enough the same as you do Cabbages. Drumhead Cabbage seed we sow about the middle of August for the early summer crop, and the end of the present month or early in March for the autumn crop, in both cases transplanting the seedlings when they are large enough. We have large heads from both sowings, but autumn-raised plants usually attain the largest size. To have fine Cabbages the soil must be deep and fertile. If you obtain an ounce from each of a dozen houses you may have a very interesting trial, and gain experience that may be serviceable to you. According to your letter you can lose nothing by the experiment suggested.

Alderney Cow Calving Prematurely (F. S.).—A cow, after calving three months before her time, may, if she has always been a good milker when going her full time of pregnancy, will continue, if carefully milked, in profit by yielding a good supply of milk without becoming dry earlier than usual, if she has been milked previously up to the time when she was due to calve again in due course. If, however, she had been allowed to go dry for some months before calving again, and which any great milking breed never ought to be allowed to do, she will probably go dry earlier in consequence of giving premature birth. With respect to her being likely to again give premature birth in the future, much will depend as to whether it has happened on this occasion through any accidental cause which can be vouched for; if not, she should not be trusted to breed from again, as some cows give premature birth inherently or from some constitutional tendency.

Coltsfoot in Pasture (A. B.).—It is very difficult to eradicate without breaking up the turf; and even then, if a few small pieces of the root were left in the land, it would increase similarly to the growth of Horseradish in gardens. It is worth a trial regardless of cost to take off the turf and dig out the roots, and then relay the turf. Applications such as salt would kill the turf if enough was applied to kill the Coltsfoot. Gas lime the same, but these are the two best applications to destroy the weed. Your land probably requires draining. Folding sheep on the ground in spring has sometimes a beneficial effect, as their continued trampling crushes the young growths and crowns of the plants, and so weakens them considerably.

METEOROLOGICAL OBSERVATIONS.

CAMDEN SQUARE, LONDON.

Lat. 51° 32' 40" N.; Long. 0° 8' 0" W.; Altitude, 111 feet.

DATE.	9 A.M.					IN THE DAY.				Rain.
	Barometer at 33 rd and Sea Level	Hygrometer.		Direction of Wind.	Temp. of Soil at 1 foot.	Shade Temperature.		Radiation Temperature.		
		Dry.	Wet.			Max.	Min.	In sun.	On grass.	
1883.										
February.										
Sun. 11	29.589	39.8	38.0	W.	42.3	48.0	38.9	80.0	36.4	—
Mon. 12	29.573	48.4	42.9	S.W.	42.1	49.4	40.2	61.6	34.2	0.267
Tues. 13	29.833	41.7	39.3	S.W.	42.0	48.0	38.3	82.4	32.2	—
Wed. 14	29.948	46.3	44.3	S.W.	41.1	47.4	40.7	49.5	35.3	0.166
Thurs. 15	29.985	47.5	46.2	S.W.	42.3	53.3	45.0	75.2	40.6	0.104
Friday 16	30.481	31.1	34.7	N.	42.0	48.5	31.8	82.3	26.9	—
Satur. 17	30.401	39.9	37.6	S.	40.4	46.2	29.3	67.2	24.4	0.452
	29.973	42.8	40.8		41.7	48.7	37.7	71.2	32.9	0.980

REMARKS.

- 11th.—Rain in early morning with high wind; day fine and bright.
 12th.—Fine at first; wet dull day.
 13th.—Fine generally, with bright sunshine; hail at 11 A.M.
 14th.—Fine early, afterwards squally with rain.
 15th.—Showery, with very bright intervals; lunar halo at 6.45 P.M.
 16th.—Fine with bright sunshine; mist in evening.
 17th.—Fine throughout. The heavy rain entered against this date fell chiefly between 4 and 7 A.M. on 18th.

Another wet and warm week; very nearly an inch of rain fell, and already nearly 3½ inches have fallen this month, and nearly 5½ inches this year, or as much as usually falls up to April 10th. The temperature also continues much above the average.—G. J. SYMONS.



1st	TH	Royal Society at 4.30 P.M.
2nd	F	Linnean Society at 8 P.M.
3rd	S	
4th	SUN	4TH SUNDAY IN LENT.
5th	M	
6th	TU	
7th	W	Society of Arts at 8 P.M.

CROSS-BREEDING PRIMULAS AND AURICULAS.

DARWIN'S dictum that "Nature abhors self-fertilisation" is so generally accepted that it may almost be regarded as a truism, although unbelievers lay much stress on the few exceptions, which, however, only prove the rule. Applied to plants, cross-fertilisation commonly means the fertilisation of the ovules through the stigmas of one plant by means of pollen from another individual of the same species. There are, however, in some cases individual species, and in others whole orders, to which the general rule does not fully apply, and prominent among the latter is the Primulaceæ.

Raisers of Auriculas have ignored this. The pollen from one florists' variety is taken to fertilise the stigma of another variety, and the result is called a cross. In the scientific—that is to say natural—sense of the term it is not a cross, and the actual result from one point of view is even worse than self-fertilisation would be in ordinary cases. For instance, Melons, Vegetable Marrow, or Cucumbers fertilised with blooms from the same plant, which in their case is as near self-fertilisation as can be, do not show any degeneracy in the offspring; at least it is not marked. But in the case of Primulas the fertilisation of thrum-eyed flowers with pollen taken from thrum-eyed flowers of the same species, no matter how distinct the varieties may be, is always attended with partial failure as well marked, or even more so, than in the case of inveterate haters of self-fertilisation when self-fertilised.

When all the ovules of a seedpod become perfect seeds the amount of seed is said to be normal, when below that it is abnormal. Now in the case of plants which "abhor self-fertilisation" the number of seeds produced in self-fertilised flowers are always abnormal more or less, varying from a slight deficiency to nothing at all; and this is accompanied by lessened vitality, which generally diminishes from generation to generation if the evil practice is continued. This is the cause of the recognised evil of what is called "in-and-in" breeding among domestic animals. The affinity of species is often tested in this way: When species are crossed, and the produce is normal or nearly so, species are considered to be nearly related; when very few or no seeds, and these of low germinating power, are produced, they are considered not so nearly related, although there are decided exceptions to this as to every other rule. In this instance varieties and species

differ, for the more distant the variety (it may even be a sub-variety, or variety of a distinct race, such as Brussels Sprouts and Scotch Kale) the likelier we are to have a full complement of seed, that seed of the plumpest type, and the progeny of the most vigorous nature, surpassing in most cases the vigour of either parent.

Primulas of all kinds, *P. Auricula* and *P. sinensis* in particular, when crossed artificially—that is, on florists' principles—show by the very great diminution in the quality of the seed, its low germinating power, and in the want of vigour in the progeny—all the evils of self-fertilisation. Those who have bought seeds at half a crown a packet, and found comparatively few seeds for their money, that even these germinated badly, and that such seedlings as did appear were very weakly. But the real fact is that seed is only obtained with great difficulty, in small quantity, and of by no means the best quality, when raised from Show or Alpine varieties when Nature's principles are thwarted in its raising.

But florists will point to their very highly refined flowers, and, while admitting that a little more vigour in the plants might be desirable, will confidently ask if the results attained do not justify their mode of crossing. We admit they have produced flowers of exquisite beauty, and are deeply indebted to them for so doing, for they have produced what we may call strains of great merit, whereby we, taking Nature as our guide and florists' flowers for a beginning, may speedily produce a race of robust hardy plants which will reproduce all the beauty of colouring, greater numbers of flowers, and much of the refinement of florists' flowers, and, after all, this recognised refinement is itself regulated by an artificial standard. It is not intended that florists should learn from this, for possibly they know better, but a hint may serve even their purpose. Whether by adopting Nature's plan equal results can from a florist's point of view be obtained we will not venture to say. Greater results might be obtained; certainly greater vigour in the plants would be secured; and if the per-centage of flowers produced possessing the properties necessary be less, the much greater quantity of seed produced may make up for this, and it is not too much to suppose more.

Perhaps a word on fertilisation may be acceptable in this place to those who may not be familiar with the subject. Nature provides for cross-fertilisation in a variety of ways. A very common one is that the stamens and stigmas in any flowers are not in condition at the same time. In some cases the pollen cases have burst, and the pollen been distributed by the wind or by insects, before the stigma becomes receptive; in other cases the stigma has been fertilised before the pollen has become ready. In a large number of instances most wonderful mechanical contrivances exist to prevent self-fertilisation. Darwin in his work on "The Fertilisation of Orchids" has shown what a variety of amazing arrangements exist in even such a small number of plants as British Orchids to prevent self-fertilisation. Even when the stigma is receptive, when the pollen is ripe, and when no special contrivances exist to prevent self-fertilisation, in a great number of cases foreign pollen—that is, pollen from another flower or another plant, is prepotent.

Hybridisers wishing to cross a large species with a

smaller have often failed, and then come to the conclusion that too great a gap existed between the two to admit of the one fertilising the other; but later experiments have proved that mere botanical affinity is not everything. For instance, we will suppose we have a tiny *Rhododendron* and we wish to cross it with a strong-growing one. If we take pollen from a large one at random, failure will likely be the result; but if we carefully select the weakest shortest stamens we can find, success will in all likelihood attend our efforts. Why is this? It is because the size and strength of the pollen grains have a distinct relation to the length and strength of the stamens. Now, strong pollen when applied to a stigma emits strong pollen tubes—tubes, in fact, which naturally grow as long, more or less, as the stamens on which the pollen was matured. Now, when these pass down a short-styled pistil and reach the ovules, instead of stopping as they should, they grow on, endeavouring to reach their natural length; but this progress is fatal to the ovules, which are ruptured and destroyed. But when pollen from a weakly short stamen is taken, it often happens that this very weakness secures success to the operator not otherwise obtainable. On the other hand, when pollen from a small flower with small stamens and small pollen grains is applied to the strong style of a large species the chances are that the tubes will never reach the ovules; and should any find their way thus far and actually fertilise an ovule or two the resulting seeds are weakly, and as often as not fail to germinate. This has been repeatedly proved.

Let us examine a *Primula* flower, keeping the above facts in mind. Here is a thrum-eyed flower, in which will be seen a pistil attached to an ovary, but very short. The stamens, however, are very long, for they reach to the top of the tube, though they appear to spring from the top of the tube. Thrum-eyed flowers therefore have long stamens and short styles. The reverse form cannot be found in the frames of the florists, but must be sought in the open border. There are no stamens visible in this form, but there is a pistil exactly where the stamens in the other flower were. Cut open the tube, and it will be seen that the stamens are also just the length of the pistil in the other. The first flower is the thrum-eye, and the second is the pin-eye of the florist.

Let us again, in the light of what we asked our readers to bear in mind, see the consequence of thwarting Nature as the florist does. First let us examine Nature's operations. She employs simply the wind in many cases, but in this she employs insects. Watch a bank of Cowslips on a still evening. The humble bees are busy. One has alighted on a thrum-eyed flower, and, thrusting down his proboscis for the honey at the base, he smears his head with pollen. He flies to another flower, which may be a pin-eye, and his dusty head is rubbed on the stigma as he again plunges his proboscis down to the bottom of the tube, and the flower is thus fertilised. But the bee does more. His proboscis is smeared with pollen from the short stamens, and just at the spot fitted for coming in contact with the stigma of the short pistil in the next long-stamened flower he visits. The result of this is that both kinds are fully fertilised with the proper pollen and bear a full complement of vigorous seed that will produce healthy plants. If we desire a similar result we must do likewise: indeed in the case of the Chinese *Prim-*

rose seed of any kind can hardly be had any other way. Even when properly fertilised—which it seldom is by private growers, hence the high price of *Primula* seed—it seldom bears a full complement of seed, which has caused some to suppose it a hybrid, this being an almost invariable character of hybrids.—SINGLE-HANDED.

(To be continued.)

EXTENSIVE FRUIT FARMING.

LAND-OWNERS have for several years past been directing their attention to other means of utilising their estates than by letting them for ordinary farming purposes, and amongst the various projects advocated and tried none has so far yielded such satisfactory results as fruit culture where judiciously carried out. This matter continues to increase in importance, and numbers of proprietors are awakening to the fact that under good management far greater profits can be obtained than from the same land employed in the ordinary routine farming. American supplies of grain are fast rendering it an almost hopeless task for home growers to compete with them, and their disadvantage is still further increased by the exceptionally unfavourable seasons that have been experienced in recent years. At the present time there are scores of unoccupied farms in England, comprising thousands of acres, that are being worked by the proprietors, and not always profitably; the present season, too, appears likely to increase the evil immeasurably. The matter, therefore, is of national interest, and any method that gives a good promise of success deserves careful consideration.

Fruit-farming is attracting the notice of many land-owners in England, and some of the more spirited have already set admirable examples in this mode of utilising suitable land. Fruit plantations have been established in many districts, particularly in the southern counties, and some are now yielding handsome profits—a success which has encouraged more extensive trials of the system, and with proportionately satisfactory results. Some grow the fruit for marketing fresh, others preserve it whole or pulped for the jam manufacturers, and still others convert it into jam themselves; but all alike who have conducted the business in a rational and practical manner speak very highly of the returns. We have also recently had several treatises upon the subject, which show it in a most favourable light, notably those by Mr. Whitehead and Mr. G. Bunyard. These and the articles in the gardening press generally, such as that by Mr. J. Wright a few years ago in this *Journal*, in reference to the fruit plantation at Barham Court, Maidstone, have done much to awaken public attention, and have aided greatly in the advance of this most important branch of commerce.

Probably the most extensive fruit farm in Great Britain is that recently established by Lord Sudeley on his estate at Toddington in Gloucestershire, where 500 acres have been planted with fruit trees, bush fruits, and Strawberries. This is at present young, the trees having only been planted two years; but the bush fruits are advancing very fast, and the other trees are equally promising, the soil being a good substantial loam, and the district one of the most favourable in England for fruit cultivation. The number of trees and bushes required to plant this extent of land appears at first sight incredible, but the following particulars will give an accurate idea of the subject. The standards, such as the Apples, Pears, Plums, and Cherries, are planted 16 feet apart in rows that are the same distance asunder, and which in some cases extend to a length of three-quarters of a mile. The land between the rows is planted with Currants, Gooseberries, and Raspberries, some forty acres being specially devoted to Strawberries, and a still greater space of pasture has been broken up, and is now being planted with the same fruit. Of Pears 852 trees have been planted, representing twenty-one varieties—Beurré d'Amanlis, Louise Bonne of Jersey, Jargonelle, Beurré de Capiaumont, Easter Beurré, Bishop's Thumb, and Doyenné d'Été forming more than half the total. About 3000 Apples are grown, which include 700 trees of Lord Suffield, 300 of Cox's Orange Pippin, and 100 each of King

of the Pippins, Keswick Codlin, Grenadier, Cellini, and Warner's King. 1383 are pyramids, and the others standards.

Plums are very largely grown, over 20,000 having been planted of no less than 44 varieties. The most approved sorts, however, head the list; for instance, there are 2919 trees of Victoria; Diamond, 1654; Early Orleans, 1650; Pond's Seedling, 1506; Greengage, 1382; Early Prolific, 793; Old Orleans, 825; and Autumn Compôte, 800. Of Damsons 8845 have been planted, comprising 4610 of the Cluser, a variety which is also known as Crittenden's, and described in Dr. Hogg's excellent "Fruit Manual" as "the best of all Damsons;" 3260 of the Prune, a fine variety for preserving and jam-making; 700 of the common Damson, 200 of the Cheshire, and 50 of the Late Black. Cherries are represented by 532 trees of nine varieties. Of Bigarreau Napoleon, an extremely rich-flavoured variety, there are 100 trees, and the same number of Black Heart, a prolific and good-flavoured variety. There are also 50 trees each of Frogmore Early, one of the Bigarreau type, with juicy pleasantly flavoured fruits, Bigarreau Noir and Flemish, a variety similar to the well-known Kentish Cherry.

The small fruits are very abundant, Black Currants heading the list with 167,000 bushes, the produce of which in a few years' time will be enormous. Of Baldwins and Black Naples together there are nearly 100,000 bushes, thus forming considerably more than half the total. These varieties are much alike, very prolific, and bearing large berries of a pleasant flavour. The chief other varieties are Black Grape, or Ogden's Black, which has smaller fruits than the preceding, but of good quality; Lee's Prolific, one of the most freely fruiting varieties, and with very large berries; and Prince of Wales. 10,000 Red Currants are grown—5000 each of Raby Castle and Scotch Red, the first being a well-known excellent variety. Of Raspberries 5000 stools have been planted, all Carters' Prolific, except 1000 of Semper Fidelis; and of Gooseberries no less than 93,000 bushes, the last-named comprising fifty varieties. Of these the principal are Crown Bob, 38,450; Whitesmith, 14,550; Lancashire Lad, 9000; Warrington, 8000; and Lancashire Prize, 1000, which may be relied upon to produce good crops of useful fruit.

About forty acres are devoted to Strawberries, the variety being Stirling Castle Pine, which is said to be of excellent quality for preserving purposes. A large additional space of land is, however, being planted with a small-fruited variety that is a great favourite with the growers in the neighbourhood of Isleworth, and known to them as the American Scarlet, but which is very similar in qualities to the Grove End Scarlet. The fruits though small are very regular in size, of fine bright colour, which is not destroyed in preserving, and the flavour is rich and sugary. About 20 tons of runners of this variety have already been dispatched to Toddington for planting. The first-mentioned variety, Stirling Castle Pine, is not much known now, still it has been in cultivation over thirty years, though when it was raised or by whom does not appear; but in M. J. Decaisne's *Jardin Fruitier* it is said to have been introduced to France by Vilmorin in 1851, and it is mentioned in lists published in the *Cottage Gardener* about that time. In the earlier editions of the "Fruit Manual" the variety is thus described—"Fruit large, ovate or conical, pointed, even and regular in shape. Seeds small, not deeply embedded. Skin of a bright scarlet colour, becoming dark red as it ripens. Flesh pale scarlet, brisk and of excellent flavour." Decaisne described the plant as very hardy and fertile and one of the best for preserving, which is no doubt due both to its colour and flavour. The other appears to be that described by Mr. C. McIntosh in his "Book of the Garden" as the Old Scarlet, and known also as the Scarlet Virginian, Early Scarlet, and Old Bath Scarlet, and was at one time greatly valued by confectioners for preserving. The preceding, with 100 Cob Nuts, 100 Scotch Firs, and 10,000 Poplars for sheltering purposes make a grand total of 338,400 trees.

As further explanatory of the method of planting adopted, it may be observed that the space has been strictly economised in the market garden style, the standard trees, as already stated, being 16 feet apart each way, and the ground between planted with bush fruits. By far the greatest portion of the

land is occupied with Plums and Damsons, and on the west side of the estate 167 acres are devoted to them; two Red Currant, Black Currant, or Gooseberry bushes being planted between each pair of standards in the lines, and the rows between the lines at equal distances. In some places Raspberries also are placed between the bushes, but this will only be a temporary arrangement until the latter need more space, when the Raspberries will be removed. On rising ground near the above also are 38 acres of standard Plums and Damsons, with Black Currants between them, and there are 48 acres planted with Raspberries, Black Currants, and Strawberries in rows without standards. The space between the Apples and Pears is chiefly planted with Red Currants. Such close cropping as this will of course necessitate considerable thinning in the future, but in the meantime the bush fruits will be yielding large and useful supplies.

The produce of this wonderful fruit farm in a few years will be simply prodigious, and it might be pertinently asked how Lord Sudeley intends to dispose of it. This may be explained in a few words. An agreement has just been settled between his lordship and Mr. T. W. Beach of Ealing Road, the latter to take the whole of the produce of the 500 acres, and to dispose of it either fresh or preserved. Mr. Beach has had long experience as a fruit-grower and preserver, and he has found there is sufficient demand for pure jams to induce him to confidently expect the most satisfactory results both for Lord Sudeley and himself. A correspondent of a commercial journal recently stated that he had seen a manufactory from which a compound of Turnips, flavoured and coloured with extracts of coal-tar, was being produced for sale as jam, and if such injurious substances can command a sale it may be reasonably expected that a wholesome compound of good fruit and pure sugar must find plenty of purchasers. The farm buildings on the estate are now being fitted up for the purpose of preserving fruit on a very large scale, and every effort is being made by Lord Sudeley to render the establishment as complete as possible.—L. CASTLE.

CULTURE OF AMARYLLISES.

THESE beautiful plants are not grown so extensively in many gardens as they deserve to be, for they are amongst the most useful and brilliant flowering plants we possess. With a good stock of bulbs it is not difficult to have them in flower during every week in the year, but they are the most valuable when grown to flower during the winter and spring, and are very effective when arranged amongst other flowering plants. To display their beauty to the most striking advantage they should be well elevated. Their flower spikes in the majority of instances are produced before the foliage has made much progress, and they are invaluable for the decoration of rooms, and can be used in these positions without the slightest injury. There is a great diversity in the colour of their flowers; and good seedlings are almost as fine as many of the named varieties, the colours varying from white to the richest crimson, others being striped, while the flowers of some are of a great size and very fragrant. Some varieties are very free, and produce as many as three spikes from a bulb.

Amaryllises are of easy culture, as they can be stored under the stage in any cool dry position after growth is completed and the bulbs thoroughly matured. Some cultivators maintain it is advantageous to keep these plants in the same pots and allow them to become thoroughly root-bound, as they then flower better than when periodically potted. There can be no doubt they follow a much wiser course than those who shift on the bulbs until they have them in 10-inch pots, as practised in many gardens. They certainly increase more rapidly with abundance of root room than when confined, but I think the system is erroneous. Potting is generally recommended after the bulbs have flowered, but this I consider too late, as the roots are then active, and however carefully the operation performed it is impossible to do it without injuring them. From careful observation I found when the bulbs have been properly matured and gradually rested the whole of the thick fleshy roots and fibres remain in a healthy condition during

the resting period, and are active before any flowers are expanded.

I repot our plants annually, not at any given time, but as the bulbs are picked out after resting to be placed in heat. Most of the old soil is shaken from the roots and the bulbs repotted in 5 and 6-inch pots, according to their roots and the size of their bulbs; these sizes I have found large enough for single bulbs. The soil employed is rich fibry loam, one-seventh of decayed manure, a little broken charcoal, and coarse sand, which is used liberally. The pots are well drained, and the soil pressed firmly into them, leaving the bulbs when finished well above the soil.

By the time the plants have finished flowering their roots are extending freely in the new soil, and are ready to develop their growth. They should have an intermediate temperature in which to complete their growth, and a position close to the glass. The object is to have the foliage dwarf and sturdy, as when grown in a close atmosphere a good distance from the glass it has not sufficient strength to support itself. When the season has advanced a slight shade may with advantage be given at the middle of the day, but light must not be excluded from the plants. After the growth is thoroughly developed they can have cool treatment, a shelf in a cool house being a good position for them, where they can be fully exposed to the sun. Thorough ripening after the growth is completed is the most essential point in their cultivation.

While growing liberal supplies of water should be given, which must not be diminished until the foliage shows signs of ripening, and then it must be carefully and gradually withheld, or the roots will suffer, and the bulbs in consequence brought prematurely to rest. If the supply of water in their last stages of growth is properly administered the roots will be ripened by the time the bulbs are, and remain healthy and fresh. If the water supply is abruptly discontinued the majority of the roots will be found dead at starting time, instead of being ready to start again into growth as soon as moisture is supplied.

These plants are subject to thrips and red spider, which can be kept down by a free use of the syringe during the growing season.—W. BARDNEY.

ADNITT'S PEA PROTECTORS

I NOTICED in the Journal of the 15th ult. a correspondent makes a suggestion with regard to these Pea protectors, but I do not think his plan a good one, for they would be cumbersome and heavy to move without any better result. Probably, too, the birds would be very likely to eat the peas through the wire netting. I have never during my experience found any difficulty in giving head space, or of giving air at the bottom, for when the peas reach the glass I draw the earth up to the peas on each side. I do not at this stage press the protectors into the soil, but lay them on lightly so that air may circulate under them. When first the idea occurred to me I thought of top ventilation, and made provision for that by making the grooves so that one piece of glass would slide over the other; but I have never yet found it necessary to do so, as sufficient air passes in at the end of each protector and the pieces of glass, which need not fit close together.

About the middle of last December I sowed a row of Peas 33 yards in length. Thirty yards I protected with my Pea guard. Every plant appears to have grown, and they are now 4 inches in height, strong, with foliage close to the ground. Saturday last I removed the protectors to draw earth to the Peas. I was very pleased with the appearance of the plants, as they are very even and of a healthy colour. I attribute this to the glass covering shielding them from the heavy rains, and carrying the water to the sides of the protectors, and so leaving the row comparatively dry. The soot that I sprinkled on the top of the row was nearly dry. I find the birds would attack the Peas when they are staked, but I adopt the plan that was advocated in the Journal fourteen or fifteen years ago—that is, to stretch three lines of stout thread saturated in coal tar on each row, one on the top and one on each side. The seed that was unprotected has not germinated.—S. ADNITT.

DRESSING CHRYSANTHEMUM BLOOMS.—While the above subject is being discussed in your columns I wish to ask a few questions. I should like to know the points by which the different classes of cut blooms are judged, also the means employed to bring the flowers to

the requisite standard after they are grown. I had, or thought I had, a few good flowers (incurved) last autumn, which I ventured to exhibit at a show in the south, and having no cups, as well as being in ignorance that cups were necessary, they were staged flat on the board. There were nine competitors in the class, and I was left out, but I could not see how I was defeated. I asked some exhibitors the cause of this, and they stated it was because I had not employed cups. Can any of your correspondents give me a few hints on the above subject?—SUBSCRIBER.

GARDENING AND GARDENERS.

I READ with pleasure the article on the above by "Excelsior," but I cannot allow the letter of "A Young Gardener, G. H." (page 134) to pass unnoticed, in which he says half of our young gardeners in bothies are ruined by excessive drinking, &c. This I strongly deny, having as a subordinate spent over ten years in bothies in England, Wales, Scotland, and Ireland; and I can honestly say that during that time it was not my lot to meet with companions such as "G. H." would have us believe are the young gardeners of the present day. As a rule I have found them to compare most favourably, as regards their drinking habits, with any other class of men. Head gardeners of the present day would not tolerate drinking habits amongst their men. Perhaps "G. H." will be surprised to hear that there are gardeners who keep a supply of books for the young men; and what is the result, of some of them at least? In a letter I have before me from a nobleman's gardener and well-known writer he says, "Some of my men have never asked to see a book of those I keep for their use, although I have pressed them on them;" and where libraries are not attached to the gardens there are often some within easy reach where books may be procured for a small sum by those who have the will. Young gardeners have the matter in their own hands. Their chief aim at the present time is to get into the houses as soon as possible; after that very few take but little interest in outside work. In my own case everything in the kitchen garden is labelled with dates, when sown and planted; but how rare it is to see one of the young men taking notes of the cropping. It arises, not from drinking habits, but for the want of giving their mind to their profession. If men will not try to help themselves they cannot expect their employers to do so.—HEAD GARDENER.

POTATOES FOR TABLE AND MARKET.

(Continued from page 155.)

In the following notes the figures 1, 2, and 3 indicate first early, second early, and late varieties; the months the time of planting; and the asterisks those varieties that are considered the best for market purposes by the respective cultivators.

CHESHIRE.—1. March and April. Veitch's Improved Ashleaf, *Myatt's Prolific Ashleaf, Rivers' Royal Ashleaf, and Early Rose. Soil.—Light. 2. April. *Schoolmaster, *Dalmahoy, International, and Snowflake. Soil.—Medium. 3. Early part of May. *Magnum Bonum, *Paterson's Victoria, *Champion, and *Regent. Soil.—Medium. Manures and Application.—Farmyard manure, moderately decayed, applied in garden ground when winter digging.—ROBERT MACKELLAR, *Abney Hall Gardens*.

1. February. Myatt's Prolific Ashleaf, and a variety of the same called *Captain White's, which is a little earlier, and Beauty of Hebron. Soil.—Soil is light, taken generally; sandy subsoil. 2. March. Covent Garden Perfection, *Snowflake, and Yorkshire Hero. Soil.—Light. 3. March, end. *Late Rose, *Magnum Bonum, and *Scotch Champion. Soil.—Light. Manures and Application.—I prefer as a manure some well-decomposed stable dung and leaves mixed, such as an old hotbed, and prefer cropping the ground with some green vegetables previous to planting Potatoes, particularly in the case of those of American origin. On some parts of the ground this would not apply. Cultural Remarks.—I am of the opinion that if cultivators of the Potato were to plant earlier than is the general rule with many of them, particularly the latest varieties, it would tend to arrest considerably the progress of the disease, as this early planting would be conducive to earlier maturation of the growth of the same, and would allow of the ingathering of the crop before the heavy rains. I am also of the opinion that all persons in giving animals the diseased tubers, even in a cooked state, are acting unwisely, as the resting spore, even after it has passed through the animal, still retains its vitality.—HARRY WARD, *Oulton Park Gardens, Tarporley*.

CORNWALL.—1. Middle of February. Suttons' Early Ashleaf and *Myatt's Ashleaf. Soil.—Medium. 2. First week in March. *Rivers' Royal Ashleaf and *Gloucestershire Kidney. Soil.—Medium. 3. Second week in March. *Scotch Champion and *Magnum Bonum. Soil.—Heavy. Manures and Application.—Stable manure, dug-in

in the autumn, ploughed in with guano.—JAMES SIMMONS, *Carclew, Perranarworthel.*

CUMBERLAND.—1. 1st of March. Mona's Pride and Royal Ashleaf. Soil.—Light, gravelly subsoil. 2. Beginning to end of March. Myatt's Prolific Ashleaf, Racehorse, and Regents. 3. First week in April. *Magnum Bonum, *Scotch Champion, and Skerry Blues. Manures and Application.—Farmyard manure, applied at the time of planting. Cultural Remarks.—The plants are kept free from weeds until the haulm covers the ground. On a suitable soil the Magnum Bonum is the best late Potato in cultivation. It resists the disease as well as the Scotch Champion, and when grown on light soil, the same as here, it is of excellent flavour. It has also the advantage of being free from deep eyes, and to those who have to purchase Potatoes this is of much importance, as it prevents waste when the Potatoes are being prepared for cooking. When grown on heavy soils, however, the Magnum Bonum cooks rather "soapy."—J. HAMMOND, *Brayton, Carlisle.*

1. March. *Rivers' Royal Ashleaf, Old Ashleaf. Soil.—Heavy. 2. March. *Myatt's Prolific Ashleaf and Schoolmaster. 3. April. *Scotch Champion, Paterson's Victoria, Dalmahoy, and Magnum Bonum. Cultural Remarks.—The ground is well manured and dug in the autumn, leaving it in 2-foot ridges. Before planting the ground is well forked over, breaking the soil as fine as possible, planting the Potatoes as we go on, the first and second earlies in rows 2 feet apart and 1 foot from set to set, adding to each set sufficient leaf soil and old Mushroom-bed refuse for the young tubers to swell in. The late varieties are treated just the same, with the exception of being planted from 3 feet to 3 feet 4 inches between the rows.—FREDERICK CLARKE, *Lowther Castle Gardens.*

DERBYSHIRE.—1. As early in February as the weather will permit. Veitch's Improved Ashleaf and Myatt's Prolific Ashleaf. Soil.—Heavy, retentive. 2. As early in March as the weather will permit. Schoolmaster and Beauty of Hebron. 3. Early in March. Magnum Bonum and Paterson's Victoria. Manures and Application.—There are many manures that may be advantageously used in a mild form for our stiff soil. We find spent hops, dissolved bones, lime, salt, and well-decayed farmyard manure dug in early in the autumn and just before earthing-up, a little soot, wood ashes, or guano sown over the surface, taking care not to touch the leaves, otherwise the stems will be injured. Where it can be procured well-decayed seaweed is an excellent manure. Cultural Remarks.—We usually give all the new introductions a fair trial. Some years ago we had over one hundred varieties, but after a few years' trial we find these six kinds to be the most reliable for all purposes. Nothing enjoys fresh soil more than the Potato, but as we have to grow them in old cultivated gardens manures must be resorted to. We also find it best to give them plenty of room, select good sets, and plant early about 5 inches deep. Magnum Bonum are the heaviest croppers. Plenty of sets yield 10 lbs. of good tubers under quite ordinary culture of such kinds as Magnum Bonum, Beauty of Hebron, and Schoolmaster; Myatt's, 7 lbs.; Veitch's, 4 lbs. per set.—J. H. GOODACRE, *Elvaston Castle Gardens.*

DEVONSHIRE.—1. End of February. Veitch's Improved Ashleaf, Myatt's Prolific Ashleaf, Rivers' Royal Ashleaf, and *Early Rose. Soil.—Light and sandy. 2. Middle of March. Prince Arthur, *Dalmahoy, Drummond's Prolific, and Fortyfold. Soil.—Light loam. 3. Beginning of April. *Magnum Bonum, *Scotch Champion, Paterson's Victoria, and Red-skin Flourball. Soil.—Strong heavy loam. Manures and Application.—For early crops a mixture of horse droppings and leaf soil. For second and general crops a mixture of well-decayed cow manure and leaf soil.—DONALD MACKAY, *Maristow House, Roborough.*

1. January, or as early in this month or February as the weather permits. The Ashleaf varieties. Soil.—Light garden soil; on south borders, or on the warmest sites in kitchen garden. 2. March, not later than Lady-day. Fortyfold, Flourball, *Early Rose, and *Beauty of Hebron. Soil.—For these and the following medium, red loam, resting on rock of volcanic origin, other parts of the same field on the red sandstone. 3. March, not later than Lady-day. York Regents, *Scotch Champion, *Magnum Bonum, and *Reading Hero. Manures and Application.—Common stableyard manure and the refuse of the pleasure grounds—viz., grass, leaves, &c., decayed and mixed with fresh lime, well mixed back when slaked, and allowed to remain for a considerable time. The above manure and mixture are used in alternate years, one year the manure and the next the compost. Cultural Remarks.—The field culture is done deeply by the plough, and well-dragged, rolled, &c., until of fine tilth. The manure ploughed down as early in the year as the weather will allow, the cultivation being only proceeded with in fine weather. When got to a fine tilth we plough in the general crop on a dry day from 2½ feet to 3 feet apart, and 7 inches deep, and let it remain until they are about coming through the surface of the soil. The field is then well harrowed on a sunny drying day. This acts as a thorough check to all small weeds. They are afterwards horse-hoed between and hand-hoed in the rows as required. The Regents are dug in August, early or later as the season may be. It is necessary to lift this sort at once as soon as the disease attacks it, as, although it is of the best quality,

it suffers much more than the other late sorts. They are left until the haulm dies. As our soil is naturally perfectly drained, we plant the sets 7 inches deep, and do not earth up. The first leaves are therefore fully developed, instead of being buried with the soil, and thereby shortening the season.—JOHN GARLAND, *Killerton, Exeter.*

1. End of February. Wood's Ashleaf, *Veitch's Improved Ashleaf, and *Myatt's Prolific Ashleaf. Soil.—Medium. 2. About the middle of March. Beauty of Hebron, Dalmahoy, *Paterson's Victoria, and Schoolmaster. Soil.—Medium. 3. End of March. *Scotch Champion, *Magnum Bonum, and Fluke. Soil.—Medium. Manures and Application.—I never use any manure for planting. I prefer planting on sand that has been manured for a previous crop, and use plenty of lime at planting time. We have about 2 feet depth of soil on the lime rock. I find the more manure used the more diseased are the tubers.—WILLIAM WOOD, *Bishopstowe, Torquay.*

DORSETSHIRE.—1. At intervals during February and March. Turner's Early Bird, Ashleaf, and Veitch's Improved Ashleaf. Soil.—Light. 2. Middle of March. Gloucestershire Kidney and Lady Paget, a good variety of the Lapstone section. Soil.—Medium. 3. First week in March. Schoolmaster and Scotch Champion. Soil.—Medium. Manures and Application.—We plant in drills and cover them in with old lime rubbish, with a liberal dressing of soot or burnt refuse. Cultural Remarks.—We plant early varieties 2 feet apart, and the later ones 2 feet 6 inches, and 1 foot from set to set. We never use fresh dung on land intended for Potatoes, as I believe it helps to spread disease. In addition to those already named we grow a collection of the leading varieties for experimental purposes.—W. G. PRAGNELL, *Castle Gardens, Sherborne.*

1. Plant in frames in January and February for succession, and outdoors in March for general crop; earth up and preserve from frosts. Early Bird, Veitch's Improved Ashleaf, *Coldstream or Smith's Early, and *Myatt's Prolific Ashleaf. Soil.—Light and rich; leaf soil, sandy loam, and well-decayed dung for pit or frame Potatoes. Choose a sunny well-sheltered border for the first outdoor crop; if the soil is heavy lighten by the addition of lime, burnt clay, or ashes. 2. March, about the middle of the month, or later if soil is wet. *Flourball, *Gloucester Kidney, *Yorkshire Hero, and *Huntingdon. Soil.—Sandy loam or sandy peat is the best for most kinds of Potatoes; to secure good crops of well-flavoured tubers the soil must be light and porous. 3. Any time after March 1st when the soil is in good working order. *Schoolmaster, *Magnum Bonum, *Paterson's Victoria, and *Scotch Regents. Soil.—Some of the more hardy kind, such as Rocks or Scotch Champion, may do in medium strong soil, care being taken to plant shallow and to frequently stir the soil, and earth up the growing crop. Manures and Application.—Ordinary farmyard manure spread upon the ground and dug in or ploughed in the autumn, frequent sprinkling of guano or Brinkworth's Potato manure strewed along the drills will encourage vigorous growth. Bonedust is also a first-rate manure. Cultural Remarks.—The varieties named are the best I know for general use in various localities. I have found them good croppers, good flavour, and hardy sorts. From many years' experience in different parts of the country I find that success in Potato-growing is due to local causes, such as soil, situation, and well-matured tubers. The past year was most unfavourable for maturing the tubers, consequently they are watery and destitute of flavour. It is generally admitted that change of seed, say every three years, is necessary for success in Potato-growing.—P. DAVIDSON, *The Gardens, Iwerne House, Shaftesbury.*

DURHAM.—1. End of February or beginning of March. Mona's Pride, Myatt's Kidney, *Alma, and Veitch's Improved Ashleaf. Soil.—Heavy. 2. March. Gloucestershire Kidney, Dalmahoy, *Regent, and Schoolmaster. 3. March and beginning of April. Champion, *Paterson's Victoria, and Fluke. Manures and Application.—Farmyard manure, not too much decomposed, applied mostly in autumn. Cultural Remarks.—The plan I generally adopt is to crop with Potatoes in quarters that were used for Peas the previous season, give a good manuring, and throw up in ridges roughly the exact width I purpose planting the following year. When the planting season arrives I level the soil between the ridges, plant the Potatoes, and fork soil over them.—JOHN SHORT, *Hummersknott, Darlington.*

1. Second week in February, second week in March. Veitch's Improved Ashleaf, *Myatt's Ashleaf, and Rivers' Royal Ashleaf. Soil.—Light, on a sandy bottom. 2. Last week in March. *International, *Late Rose, and King of Potatoes. 3. Third week in April. *Magnum Bonum, *Schoolmaster, and *Scotch Champion. Soil.—These we plant in the field, the soil being medium on a clay bottom. Manures and Application.—Having a good supply of stable manure I use no other. For garden crops I prefer spreading it on the surface, and digging it in for other crops to follow as soon as the early Potatoes are lifted. The second earlies I plant in rows 4 feet apart; this allows plenty of room for one row of Brussels Sprouts or Broccoli in between the Potatoes, which I find do very well.—JOHN BIRCH, *Windlestone Hall, Ferry Hill, Co. Durham.*

1. November to March and April. Veitch's Improved Ashleaf, Rivers' Royal, and Myatt's Prolific Ashleaf. Soil.—Medium on limestone. 2. November to April. Schoolmaster, Fortyfold, and Dalmahoy. 3. November to April. Lapstone, Regents, Victoria, and

Rocks. Manures and Application.—Chiefly horse manure and vegetable matter. Cultural Remarks.—As to culture, I find no difference as to whether the manure is dug in autumn or at the time when planting if the ground is dry any time through the winter. I prefer to plant early, before the tubers begin to grow.—R. DRAPER, *Seaham Hall, Sunderland.*

ESSEX.—1. February as early as weather permits. Myatt's Prolific Ashleaf, Uxbridge Kidney, and *French Shaws. Soil.—Light. 2. Early in March. *Dalmahoy, Schoolmaster and *Dunbar Regent. 3. End of March or early in April. *Victoria, *Magnum Bonum, *White Elephant, and *Champion. Manures and Application.—All our Potatoes receive farmyard manure and guano occasionally. We place the early Potatoes for the garden one layer thick in shallow boxes, and place the boxes in a cool vinery or similar structure. The field culture consists of farmyard manure and guano, 3 cwts. per acre. Cultural remarks.—Various artificial manures have been tried, and we have always come back again to guano. Good crops have been obtained by sowing the ground with Rye and ploughing it in before the Rye is ready to cut.—JAS. DOUGLAS, *Loxford Hall, Ilford, Essex.*

1. First or second week in March. Old Ashleaf, *Myatt's Prolific Ashleaf, Rivers' Royal Ashleaf, and Early Rose. Soil.—Light sandy loam. Plants in ridges 2 feet apart, and 18 inches from set to set. 2. Last week in March. *Snowflake, *Rector of Woodstock, Porter's Excelsior, and Paterson's Victoria. Soil.—Medium loam. Ridges 2 feet 6 inches apart, 20 inches from set to set. 3. First week in April. *Dunbar Regent, *Victoria Regent, *York Regent, and Schoolmaster. Soil.—Medium loam. Manures and Application.—Old tan, leaf soil, or old hotbeds, or any other light substance placed over the sets. It is very desirable that the ground should be well worked and kept in a light state previous to planting, as that will assist early ripening, and the earlier the Potatoes are harvested the better, as there is less chance of disease.—ROBERT CASTLE, *Orsett Hall, Romford.*

PANICUM PPLICATUM.

FOR those who are not overstocked with small Palms and wish for a plant with handsome and graceful foliage I would recommend *Panicum plicatum*. It is a Grass of the easiest culture, the usefulness of which for decorative purposes can scarcely be over-estimated. A pinch of seed sown in August in a warm house and pricked off, five in a 6-inch pot, made what looked like single plants 3 feet high and as much through by December, and when used for decoration in the mansion was very much admired. Its leaves are about 2 feet long, and 3 inches broad in the widest part, beautifully plicated or folded lengthwise, and bent sickle-shape, so as to fall gracefully all round the pot. The folds in the leaves make it appear to have several shades, varying from a very light to a dark green colour. It is, I think, best treated as an annual, and sown in successional batches. I intend growing it by hundreds. It seems to me not very particular about temperature, but a friend living in Co. Meath who recommended it to me, says he tried it outside there during the last summer, and it was not satisfactory. It is, however, worth a trial in sheltered situations in the south of England.—WM. TAYLOR.

CULTURE OF SOLANUM CAPSICASTRUM.

THESE most useful plants are not so extensively grown as they deserve to be. I think that no other plant appears so bright in the conservatory during the dull winter months. I once saw some plants that had been grown in pots all the summer months, and in winter they had very few berries or leaves. In March they should be pruned, but not very closely if large specimens are required. At the beginning of April they should be planted out in a sunny border that has been dug and manured. Allow them room according to their size, for if planted too thickly together they will lose their leaves. From this time until they are lifted they must be well supplied with water, and occasionally with liquid manure. About the middle of September they should be lifted, taking care not to shake more soil off from the roots than is necessary, or probably they will lose their foliage. In the potting they should have good drainage, because they require abundance of water, using a compost of good loam and leaf soil. They should be placed by the side of a south wall for three weeks, sprinkling them when the sun is bright, not allowing them to flag. When the frosts commence the plants should be removed to a shelf in a cool house where the berries can ripen, which will occur by Christmas or before. They can easily be obtained by seed, but I prefer cuttings, because they make the dwarfiest and most bushy

plants. Cuttings may be obtained by pruning a few plants back and placing them in heat, and they will produce abundance of cuttings. They will strike freely in bottom heat without a bell-glass. If encouraged and attended to they will make fine plants by winter.—C. STEPHENS, JUN.

A LIGHT TREE-MOVING MACHINE.

WHEN about to commence moving some shrubs a few years ago we were considering the best means of conveying them to their new quarters, when we remembered an old mowing machine, which was at once utilised. The machine was one of a very old pattern, made thirty or forty years ago, the rollers of which, to our advantage, are a few inches higher than they are made at the present time. In the first place we stripped the machine of everything but the handles and rollers. A square piece of sound oak was secured with binding wire across the front of it, just above where the front rollers had been removed. Two 15-foot mason's planks were then laid on the top of the machine, resting on the piece of wood at the front, and nailed to it, and on the cross bars of the handles behind. At the end they were secured together by nailing a piece of wood across to form handles to hold and guide it by.

The sketch (fig. 50) is a side view of machine as now used. We find the planks are too heavy, and mean some day to get a stout larch pole fitted up something similar to that represented in outline. Two cross pieces and a 9-inch board, laid

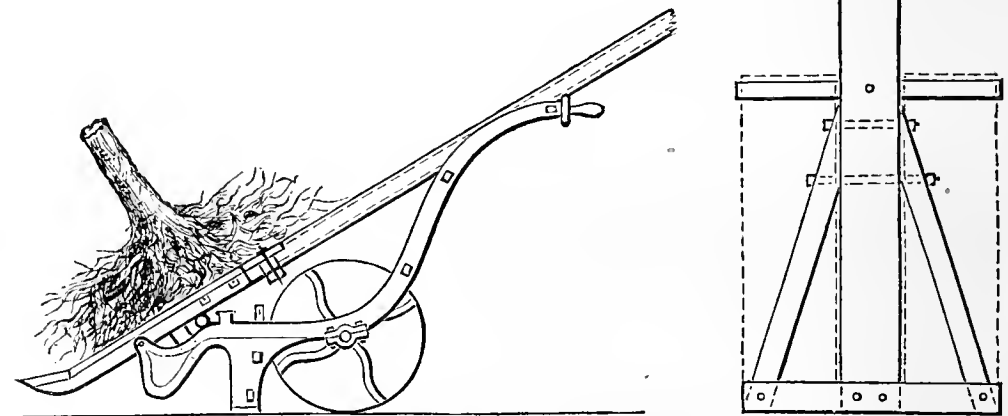

Fig. 50.—A Light Tree-moving Machine.

parallel to and level with the top side of the pole, will form a stage sufficient to carry the ball of soil. The thick end of the pole should be roughly squared to make it lie better and to facilitate the fitting of the stages.

Anyone having an old mowing machine, and having planting to do, cannot possibly turn it to better account than use it for this purpose. Last autumn two men and a lad moved some shrubs from 8 to 10 feet high with less loss of time and labour than could have been done by any other plan I have yet seen tried. The shrubs are prepared in the ordinary way, only keeping the loose soil clear of one side of the plant. The ball is then tilted back on its side, the machine is brought forward with the rollers close to the edge of the hole, slipping the end of the stage under the ball by raising the handles. The ball is then brought back on to the machine. If the ball is sufficiently heavy to balance the top it may be carried to its destination in an upright position, simply sliding it along the planks (after having raised it to a horizontal position) till the man at the end of the pole can balance it. If the tree is a tall one, its head is brought back and lashed to the pole, which generally brings the weight about right. The shrub is deposited in the new hole with the same ease, by bringing the rollers to the edge of the hole in the same way. The moving from one place to another is easy, whether on road or turf, a rope being attached to the front part of the machine to draw it by.—R. INGLIS.

EARLY FLOWERS.

QUITE a large posy may now be picked from shrubs and plants in the open air. *Erica carnea* is in full beauty, its bright rosy pink flowers brightening the garden more than any other plant just now. We have planted it by the hundred in many places—in bold masses among the collection of hardy Heaths, in perennial

flower borders, among shrubs, and in rock beds. All have done fairly well, but those growing among the rocks are remarkable for a vigour and beauty greatly exceeding all the others; for there the single plants have become huge cushions upwards of 2 feet in diameter, each being now a mass of blossom that is very striking. *Erica codonoides* is equally beautiful in its way; the tall tapering cones of lively green, so soft, full, and compact, are charmingly crowned with thousands of pretty pink and white flowers, and the general effect is so refined that it would prove no unworthy associate of the best Cape Heaths. *E. mediterranea*, on the contrary, though its flowers are fully open, has become so loose and straggling in appearance, and the colour of its flowers is so tame, that they only attract us by the sweet scent, which is certainly an important redeeming property.

Berberis Darwinii and *B. japonica* are both in flower, the first partially, and the other fully. *Andromeda floribunda* has many of its pretty white Heath-like flowers open; *Mahonia*, too, is almost in full bloom. *Rhododendron Nobleum coccineum* has a few open flowers, which are comparatively dull-looking beside the brilliant carmine hue of the unopened flowers. The colour of the outside of its petals is so brilliant that it is very attractive when the flower buds become prominent. I have recently made a special nook for this and some other early-blooming varieties. *Ceanothus rigidus* is fast bursting into bloom; some of the *Ribes* are almost as forward, and among flowers of lowlier growth there are Wallflowers, Cowslips, Primroses, and *Omphalodes*, while *Gentiana acaulis* has also actually a few flowers nearly fully developed.

These results of the mild winter, which I observed on February 13th, appear sufficiently remarkable to be recorded in the Journal. We that live in the south, with all our benefits of climate, do not often enjoy such immunity from frost and snow as in the present winter; even the aquatic plants are already starting, the Arrow-head being especially remarkable for its half-grown leaves, and there are several perfect flowers of *Aponogeton* in one of the ponds.—EDWARD LUCKHURST.



WE have received a communication from "Delta" for the information of Mr. Elwes, to the effect that "the FAILURE IN GLADIOLI is not a matter of the last few years only, it has been going for the last twenty years. As far back as that I had nearly my whole collection swept off, and had almost abandoned their culture, while very many whom I have known to have for a time grown them have been forced to abandon them owing to their heavy losses. It is possible the exceptional seasons we have lately had may have aggravated the failure, but it is not a thing of yesterday."

— MR. B. S. WILLIAMS of Upper Holloway sends us flowers of *PRIMULA SINENSIS FIMBRIATA ALBA AND RUBRA*, two very fine strains, distinguished by the great size of the blooms, the purity of the white, and the richness of the purple variety. The plants are also of good habit, as we have frequently seen them.

— THE schedule of the ROCHDALE AURICULA SOCIETY announces that the Exhibition this year will be held in the Public Hall, Baillie Street, Rochdale, on Wednesday, May 2nd. Fifteen classes are provided for all the different sections of Auriculas, Show, Alpine, and Fancy, together with Polyanthus.

— MR. H. G. SMYTH, 17A, Coal Yard, Drury Lane, is now sending out the beautiful BORDER CARNATION MARY MORRIS, which was awarded a first-class certificate by the Royal Horticultural Society on the 22nd of August last year. This variety has large but neat, clear, rose-pink flowers, which are produced in great freedom, and a bed of plants we saw last year was literally "a mass of blooms," so abundant were they. Either for cutting or as a border plant it is most valuable.

— MESSRS. J. VEITCH & SONS have now a fine display of

ORCHIDS AT CHELSEA, a large number of handsome species and varieties being in flower. Particularly attractive are the Phalaenopsids, some scores of spikes of the grand *P. Schilleriana* producing an unrivalled effect in one of the houses, *P. grandiflora* and *P. Stuartiana* being also in good condition, and contribute to the beauty of the display. With these may also be noted the free-flowering *Angraecum citratum*, which in small pots and pans are bearing abundance of spikes of creamy white flowers. This is unquestionably one of the most useful members of the genus, though not so striking as *A. sesquipedale*, which is also flowering well. Amongst the Dendrobies very noticeable is the charming *D. splendidissimum*, the Chelsea hybrid, which is so closely related to *D. Ainsworthii*; indeed, it appears that there is no perceptible difference between *D. Ainsworthii roseum* and *D. splendidissimum*, both are alike distinguished by the rich crimson lip and their free-flowering qualities. A new Bornean species, *D. Curtisii*, is worth a note, the flowers being small, white, with an orange spot on the lip, and produced on very slender growths. It is very distinct, and of dwarf habit.

— A NUMBER of superb varieties of *CATTLEYA TRIANÆ* are flowering, ranging from pure white to some with the richest crimson labellums. This grand Orchid is one of the most useful of the genus, and is especially valuable for winter flowering. The new *C. labiata Percivaliana* is also represented, some of the flowers being highly coloured. *Cypripediums* are in strong force, those of the *Sedeni* type, *C. calurum* and *C. porphyreum*, being very fine. The last named is a beautiful hybrid, with deep rosy lips and shorter petals than *C. calurum*, which has also more green in the dorsal sepal. *C. Boxalli*, with its dark-blotched shining flowers; *C. marmorophyllum*, with its deep purplish-tinted flowers; and *C. vernixium*, a hybrid between *C. villosum* and *C. Harrisianum*, having purplish petals, greenish sepals, and a pale brown lip, are all well displaying their respective characters. Amongst the cool-house Orchids *Odontoglossums Alexandræ*, *Pescatorei*, *triumphans*, *Cervantesii*, *Rossii*, *blandum*, *cirrhosum*, *prænitens*, and *maculatum* are represented by diverse and handsome varieties, with several *Oncidiums*, *Masdevallias*, &c. Remarkable, too, is *Sophranitis grandiflora*, of which one of the largest flowered and richest coloured varieties is growing on a small block a few inches square, and suspended from the roof of the house.

— IN order to stimulate the production of new early Peas and high quality, and also to test the value of Mr. Laxton's latest effort in this direction, MESSRS. HOOPER & CO. OF COVENT GARDEN offer the following special prizes to be competed for at the Royal Horticultural Society's Meeting at South Kensington on May 22nd next—viz., "for two dishes of early Peas, one of them to be Laxton's Earliest of All, first prize, £3; second, 30s.; third, 15s. Each dish to consist of twenty-five pods, and the trade mark of the seed packet of Earliest of All must be placed on the exhibit as a proof of its genuineness. Intending exhibitors will please make a note of this announcement, as it is not inserted in the Society's schedule."

— RELATIVE to the WINTERS IN AMERICA, a correspondent writing to us from the State of Wisconsin on the 5th inst. remarks:—"We are having a very severe winter. The thermometer has for some time past been ranging between 10° and 35° below zero. This morning it is 28° below zero."

— MR. EDWARD MAWLEY, of Addiscombe, Croydon, has issued the annual edition of his work on the WEATHER IN THE NEIGHBOURHOOD OF LONDON. It contains seventy-five pages of clearly printed tables and miscellaneous observations for every day in the past year, comprising barometric variations, temperature, wind, and rain, compared with those of an average year. These are accompanied by a novel diagram showing the variations of the

weather during 1882, barometric temperature, proportion of cloud, humidity, rainfall, and, together with the increase or decrease of general mortality in London, zymotic diseases and diseases of the respiratory organs. The work contains much information useful to all interested in meteorology. It is published by Mr. E. Stanford, Charing Cross.

— THE schedule of the GLASGOW AND WEST OF SCOTLAND HORTICULTURAL SOCIETY is issued, and announces the Spring Show for March 28th, and the Autumn Show for September the 5th. At the first prizes will be offered in sixty-three classes, chiefly for forced and spring-flowering plants, while at the other 135 classes are provided for plants, flowers, fruits, and vegetables.

— RELATIVE TO ORCHIDS AT DRUMLANRIG, a correspondent informs us that the remarks on page 159 were not too commendatory, as since the visit of Mr. Wright a spike of *Odontoglossum Alexandrae* has flowered. "The spike was 3 feet in height, and bore thirty-four flowers, ranging from $3\frac{1}{4}$ to $3\frac{1}{2}$ inches in diameter, the variety being of great excellence. The next largest of the same form was the Trentham example with twenty-seven flowers." We have learned that the splendid spike referred to was sent to Mr. Henry Stevens to be photographed.

— THE following circular, which we readily insert, will shortly be issued by Mr. E. S. Dodwell relative to holding a supplementary CARNATION AND PICOTEE SHOW AT SLOUGH during the ensuing summer:—

"Stanley Road, Oxford, Feb. 24th, 1883.

"Dear Sir,—It has been suggested to me that as the Supplementary Exhibition of the National Carnation and Picotee Society, held in this city last year, was a mark of attention to myself, a similar Exhibition should this year be held on July 31st in the grounds of the Royal Nursery, Slough, as a recognition of the work and worth of Mr. Turner. The suggestion has been submitted to Mr. Turner, and I am happy to say accepted by him, and I have now therefore very respectfully to beg your aid and co-operation in making the meeting worthy of the place and the man. Thirty-four years since (1849) Mr. Turner commemorated his entrance into occupation of the Royal Nursery with the largest and finest display of Carnations and Picotees I had up to that time seen, besides providing funds for a competition in which he took no part. In the next year the first of the celebrated trial exhibitions (northern *versus* southern-raised flowers), instituted to dispel the vain notion then promulgated that there was a cardinal difference in the flowers of north and south respectively, took place in the same grounds; and in the year thereafter (1851) the first exhibition of the National Carnation and Picotee Society itself. I aspire to make the proposed meeting worthy of its predecessors, and hope, though the competition be confined to Carnations and Picotees, the friends gathering together will not be limited to the growers and admirers of those flowers only, but will include the much larger number who have known, admired, and sympathised with Mr. Turner's work. A subscription list has been opened for the purpose of providing funds for the needful prizes, and any aid you may give will be gratefully appreciated. Begging an early reply, I am, dear Sir, your faithful servant, E. S. DODWELL."

The following subscriptions have been already promised:—John T. D. Llewelyn, £5 5s.; C. Turner, £5 5s.; E. S. Dodwell, £5 5s.; J. McIntosh, £3 3s.; J. Douglas, £1 1s.; Shirley Hibberd, £1 1s.; H. M. Hewitt, 10s. 6d.; Samuel Brown, 10s. 6d.

— THE thirty-second annual Exhibition of the OXFORD ROSE SOCIETY will be held at Headington Hill Park, Oxford, on Tuesday, July 10th.

— THE Council of the Meteorological Society having determined upon holding at the Institution of Civil Engineers, 25, Great George Street, S.W., on the evening of March 21st next, an EXHIBITION OF METEOROLOGICAL INSTRUMENTS which have been designed for or used by travellers and explorers, the Exhibition Committee invite co-operation, as they are anxious to obtain as large a collection as possible of such instruments. The Committee will be glad to show any new meteorological apparatus invented or first constructed since last March, as well as photographs and drawings possessing meteorological interest. Anyone willing to forward exhibits are invited to submit within fourteen

days a list of the articles and an estimate of the space they will occupy to Mr. William Marriott, Assistant Secretary, 30, Great George Street, Westminster, S.W.

— AMONG the smaller kinds of epiphytal Orchids the little Madagascar rarity, *ANGRÆCUM CITRATUM*, is, indeed, a gem. Two plants of it are at present in flower in the College Botanic Gardens, Dublin. The little plant is of a very dwarf habit; the gracefully curving flower scape is from 12 to 15 inches long, which, for the greater portion of its length, is furnished with a symmetrically arranged double row of pure white flowers, each with a proportionally long spur, the double row of spurs below corresponding with those of the flowers above, and enhancing the beauty of the flower scape. The plant is a native of Madagascar, from whence it was introduced by Messrs. Veitch & Son. It is as yet rare in collections; but no choice collection of these plants should be without it. Mr. Burbidge's plants are growing and flowering in extremely small, shallow pans suspended from the roof.—(*Irish Farmers' Gazette.*)

— WE have received from Messrs. Cassell, Petter & Galpin a packet of their serial publications—Part 10 of the *Illustrated Book of Canaries and Cage Birds*; Part 30 of *Paxton's Flower Garden*, containing good plates of *Cattleya pallida* and *Cantua buxifolia*; Part 48 of *Familiar Garden Flowers*; and Part 71 of *Familiar Wild Flowers*.

— THE monthly meeting of the METEOROLOGICAL SOCIETY, held on the 21st inst., Mr. J. K. Laughton, F.R.A.S., President, in the chair, Rev. W. R. C. Adamson, R. P. Coltman, W. F. Gwinnell, Capt. C. S. Hudson, T. Mann, F. G. Treharne, and W. Tyson were balloted for and elected Fellows, and the following papers were read:—1, "Notice of a Remarkable Land Fog Bank, 'The Larry,' that Occurred at Teignmouth on October 9th, 1882," by G. W. Ormerod, M.A., F.M.S. The "Larry" is a dense mass of rolling white land fog, and is confined to the bottom of the Teign valley, differing therein from the sea fog, which rises above the tops of the hills. It appears about daybreak, and has an undulating but well-defined upper edge, which leaves the higher part of the hill sides perfectly clear. The author gives an account, illustrated by photographs, of the remarkable fog bank that occurred at Teignmouth on the morning of October 9th. 2, "Barometric Depressions between the Azores and the Continent of Europe," by Capt. J. C. de Brito Capello, Hon. Mem. M.S. The author gives the tracks of several depressions from the Azores to Europe, and shows that if there had been a telegraphic cable nearly every one of them could have been foretold in England. 3, "Weather Forecasts and Storm Warnings on the Coast of South Africa," by Capt. C. M. Hepworth, F.M.S. 4, "Note on the Reduction of Barometric Readings to the Gravity of Latitude 45°, and its Effect on Secular Gradients and the Calculated Height of the Neutral Plane of Pressure in the Tropics," by Prof. E. D. Archibald, M.A., F.M.S.

— IN supporting a resolution for the abolition of EXTRAORDINARY TITHES at a recent meeting at Greenhithe, Mr. Albert Bath described this tithe as an obnoxious burden which pressed severely on farmers, especially in Kent and Sussex, as the more capital they expended on fruit, hops, and market garden grounds, the more tithe they had to pay. The Anti-extraordinary Tithe Association proposed abolition of this tithe by three to seven years' purchase, but he found some difficulty in that way. There was capital to raise, also value in different parishes to estimate. He would suggest that they go back to the settlement at the time of the commutation of 1836, ascertain the amount of extraordinary tithes charged in each parish at that time, and spread the total amount over the whole of the land in the parish, and in this manner get out the field apportionment of the ordinary tithe,

and levy the extraordinary tithe at so much in the shilling, so that poor land only bore a fair proportion. The extraordinary tithe would then cease to exist, it being merged in the ordinary tithe. It should then be compulsory on the part of the landowner to pay ordinary tithes, which would be in accordance with the intention of the Commutation Act, of course having due regard to existing leases. The resolution was carried unanimously.

THE YEW AS A HEDGE PLANT.

IN "Work for the Week," on page 99, February 1st, of this Journal, is an account of planting hedges, and mention is made of the above shrub or evergreen. I can fully endorse what is there said as to its adaptability "for formal hedges in the pleasure ground." At Holme Lacy, Hereford, such hedges may be seen, and are considered the finest of their kind in the country. Some of the hedges are upwards of two hundred years of age, and others of from ten to fifteen years, and the latter have been for years models of beauty. If strong plants can be procured it does not take very long to make a good hedge.

The system there practised is to grow the young plants on from the first, preparing them, as it were, for the future hedge. The tops are never cut back, but the side growths are cut in to make the plants compact. When the plants have grown to about 4 or 5 feet high they are taken to their final place, and there planted in a single row, planting them so that they touch each other, as it is found the best hedges are formed by planting in single rows. Be they Yews or Hollies, the ground is well trenched for their reception. They are left to grow on, and the tops are not cut until they reach the desired height, but the straggling side branches are cut back before growth commences in the spring. The permanent hedges are trimmed once a year, commencing the first or second week in August. The Yew is a very accommodating plant, as if any hedge has been left to grow wild for years the branches may be cut close in to the main stem, when they will start afresh and form a close wall of green.—A. YOUNG.

AN AMATEUR'S HOLIDAY.

DUNDEE.

ON the way south from Aberdeen I stopped at Dundee, and at the warehouse of Messrs. Laird & Sinclair I learned from a friend the whereabouts of a few nurseries in the vicinity. The very large trade done by the firm in Hyacinths, Tulips, and other spring flowers was evident from the unusual quantities of bulbs then displayed in the shop. I afterwards went to Broughty Ferry, where the smaller of the two nurseries of the firm is situated. There I saw some good Dahlias and Hollyhocks; one or two seedlings of the latter were fine. There was also a very promising collection of Chrysanthemums, and in one of the houses a healthy batch of Primulas. I believe the main purpose of this limited enclosure is the supply of small plants and cut flowers for the city. The principal grounds of the firm are at Monifieth, five miles from Dundee. I walked on to these, and on the way enjoyed a visit to the two nurseries afterwards noticed. The grounds at Monifieth, but for the usual intimation over the entrance, I would at first sight have almost inferred to be those of a private residence. Neatness in arrangement and good order prevailed throughout all I saw. Of the twenty acres a large space is occupied by forest and fruit trees. There was also an extensive lot of Roses and a select assortment of herbaceous plants, among which I observed *Campanula nobilis alba* with large blooms and of dwarf habit. I was particularly pleased with a fine collection of summer-flowering Chrysanthemums, many of which were very beautiful.

The nursery of Messrs. John Stewart & Sons adjoins Broughty Ferry, and extends over fifty acres. The trade in forest trees, Rhododendrons, and ornamental shrubs is very large. In the houses were large collections of table plants and Ferns. Pelargoniums for cutting were grown in great numbers, and single Dahlias in pots to supply cut blooms a month or two later. There was also in the grounds a large break of show Dahlias in very good flower, and spring-flowering plants are extensively grown. Under the name of W. & D. Stewart at Ferndown Nurseries, Wimborne, the same firm carries on a large business in the exportation of forest trees to America, where a representative is permanently kept, and where Mr. Stewart himself, I understand, mainly resides.

Through these grounds I pushed on to Dalhousie Nursery, that of Messrs. D. & W. Croll. Here I found Roses very largely grown; to these in the various forms a large part of the ten acres in the nursery is devoted. The 15,000 for next supply were in fine condition; the growth in many cases very vigorous. Magna

Charta, for instance, had shoots upwards of 7 feet in length. The seedling Briar is a favourite stock. I saw a very large collection of Teas, and there they seemed to thrive well in the open air. I also noticed in a house one of those glass partitions which I formerly mentioned as having been generally adopted at Fedall. I was very sorry that I could not devote more time to these three establishments, where there was much more to interest than I have indicated.

PERTH:

Through the Carse o' Gowrie I reached Perth. During previous visits to St. Johnstone I had been unable to look in on a place well known by name, and was resolved on this occasion not to miss the nursery of Messrs. Dickson & Turnbull. My visit gave me much pleasure, as I there found many plants to my taste. Special attention is directed to Conifers, American and deciduous plants and shrubs, in which an extensive business is done. The Palms and Orchids in the houses were glanced at to devote the hour at disposal to the outdoor departments that more attracted me. I can merely enumerate a few where so many were extensively grown. Spring flowers were largely represented, such as Primroses and Polyanthus in variety, Hepaticas, including a batch of the double blue, and breaks of spring bulbs. Carnations, Picotees and Pinks, double Pyrethrums, and the fullest stock of Pœonies I have seen; Lilliums, Saxifrages in great numbers and numerous varieties, a very exhaustive collection of alpine and rock plants combined to entice to another and a more lengthened call. Here again I saw *Campanula nobilis alba*, a variety to be kept in mind. In conformity with present taste single Dahlias could not be overlooked, and a number of seedlings were in capital flower. Much more admired was the collection of Roses, mainly on Manetti and seedling Briar. The Teas in pots were really good. There was also a large space occupied by the true old Scotch Rose, now seldom seen to such an extent. I was not in the least surprised to find a collection of Gladioli. But of all that I saw nothing pleased me more than the large collection of hardy Heaths. Many of the sorts were new to me, and I was delighted with their beauty and varied forms. For the foreground of a mixed border nothing could, in my opinion, be more desirable.

I reserve allusion to two other places I visited, as they bear more especially upon a topic on which I may before long ask leave to make some remarks. The memory of uniform kindness experienced during my last holiday is brightened yet more by the genial welcome accorded in this my last visit to such establishments as that of Messrs. Dickson & Turnbull. To all whom I was privileged to meet, for privilege I deem it, to come in contact with gentlemen such as, let me assure "Excelsior," I met everywhere, in hope that we may meet again, sincere thanks are once more gratefully tendered by—A NORTHERN AMATEUR.

THE CHRYSANTHEMUM ELECTION.

TOO-MUCH-ALIKE VARIETIES.

A CHRYSANTHEMUM election is not only novel in itself, but it is to be hoped that it may prove useful in removing the confusion which exists in the nomenclature of the varieties. In the following notes I give my opinion, founded on a long experience, of the varieties bracketed in your returns. I trust others of experience will do the same, and during the forthcoming season especially note the varieties; so that if the Editor will only ask for another election next year we may then be able to show that a clearer understanding exists. One great cause of so much confusion is no doubt due to the readiness of one grower to assist another, and who sends a collection of cuttings through the post; the labels get confused, and so the mistake is perpetuated. Sometimes vendors are not to be relied upon, but it is to be hoped that the analysis and the subsequent papers which must of necessity follow will do much in clearing up this matter. The word "petal" is used here instead of "florete," as it is more generally understood.

Mr. Bunn and Golden Beverley are very distinct in colour and formation of petal. The former has the colour of *Jardin des Plantes* with the petals of Mrs. Dixon. The foliage of Mr. Bunn and Golden Beverley are precisely the same, Mr. Bunn being a much-improved sport from Golden Beverley. Miss Mary Morgan and Pink Perfection are identical in both flower and foliage. John Salter and Mr. Howe are also identical, and the same may be said of Empress of India and Lady St. Clair, Empress of India and Mrs. Cunningham. Golden Queen and Emily Dale are too closely allied to be admitted on the same board. St. Patrick and Beethoven, Refulgence and Inner Temple are identical. Mr. G. Rundle is coupled with Mrs. Parnell, but the last variety I do not know. Mrs. Dixon and Golden George Glenny are identical. Mrs. G. Rundle first produced a primrose sport, which was named

Mr. G. Glenny; in the following year a golden sport, which was named Mrs. Dixon, and is still known in some parts as Golden Mr. G. Glenny. Barbara and Baraba: this last I have never grown, but I have found that the early buds of Barbara differ in colour from the later flowers, and perhaps the names have been applied to the different stages. Prince of Wales and Lord Derby are very distinct in foliage and build of flower. Empress of India and Snowball are identical. Robert James, General Bainbrigge, and Beauty of Stoke: the first-named I have never grown, but the last two, as I have grown them, are distinct. Empress of India and White Globe are very distinct both in flower and foliage. Golden Empress of India and Emily Dale are distinct. Prince Alfred and Lord Wolseley are distinct in colour; the latter is a sport from the former, but not yet in commerce, and ought not to have been named.

Princess of Wales and Mrs. Heales: if these two are distinct, they are so closely allied in every particular that they ought not to be admitted in a stand of twelve varieties; in fact two flowers have been known to have been cut from the same plant and shown under both names. Inner Temple and Aregina are distinct, but the last has frequently been sold under the former name. Empress of India, White Queen, and Mrs. Cunningham are identical. Lady Slade and Lady Hardinge are very distinct in habit of growth, form of flower, and colour. Venus and Hetty Barker are distinct. Mrs. G. Rundle and Mount Edgcumbe: the last-named I have not grown, but it is singular that Mrs. G. Rundle was raised very near Mount Edgcumbe. Empress Eugénie and Pink Perfection are quite distinct. John Salter and Angelina are very distinct in form and colour of flower, as well as in foliage and habit of growth. Princess Beatrice and Lady Slade are quite distinct. Canary and Canary Cherub are identical, as are also Queen of England and Blush Queen. St. Patrick and Golden Eagle are distinct. Mr. Brunlees and Mr. Jay are very distinct; the last has quite a quilled petal.

Empress of India, Virgin Queen, and Vesta are all distinct, the last-named being reflexed. Jardin des Plantes and Mr. Bunn are distinct in size and shape of flower and foliage. Princess of Wales, Princess Teck, Le Grande, Mrs. Heales, and Countess of Granville are all distinct, except the first-named and Mrs. Heales. Venus, Lady Slade, Mrs. Sharpe, and Beauty are all distinct in both colour of flowers and foliage. Barbara, Mr. Brunlees, and Golden Eagle are all distinct from each other. Pink Venus, Pink Perfection, and Lady Hardinge all distinct in form of flower and foliage. Mr. G. Glenny and Emily Dale are very distinct. Rev. C. Boys and Inner Temple are distinct, but the first is sometimes sold for the latter. Mabel Ward and Angelina are perfectly distinct; the first is a sport from Eve, the latter from Lady Slade. Venus and Countess of Dudley, Baron Beust and Orange Perfection are all distinct. Oliver Cromwell and Mr. Evans, Golden Eagle and Orange Perfection are identical. Prince of Wales and Mr. Corbay are distinct in colour of flower, the last-named a sport from the first. Lord Wolseley, Incognito, and Mabel Ward—a strange combination—are all distinct; as also are Mrs. Dixon and Aureum Multiflorum.

All the following are distinct:—John Salter and Baron Beust, Mrs. G. Rundle and Duchess of Manchester, White Beverley and Blonde Beauty, Hero of Stoke Newington and Novelty, Isabella Bott and Empress of India, Refulgence and Prince of Wales, White Venus and White Beverley, Mr. G. Glenny and Guernsey Nugget, Mrs. Rundle and Mrs. Shipman, Mr. G. Glenny and Golden Empress of India, Golden Queen of England and Golden Empress of India, Isabella Bott and Lady Hardinge, Novelty and Beauty, Mr. G. Glenny and Mrs. Dixon.

That seventy-seven electors should have named seventy-seven varieties as worthy of a place in the first twelve is astonishing, and if space could only be spared in some future issue it would be interesting if the lists of the best twelve from each elector could be published. The high position that Jardin des Plantes attained is surprising. Its colour is magnificent, but the form is generally bad, and is rarely seen in a collection of twelve varieties. It is curious to note the relative positions of Princess Teck and Hero of Stoke Newington—two varieties only differing in colour of the flower. The first-named only received twenty-seven first-class votes, while the latter received forty-one; yet with the second-class votes thirty-nine and twenty-one respectively. Princess Teck has a total of sixty-six to sixty-two, or four more than her parent. The colour of Hero of Stoke Newington is most desirable, but I have a weakness for the daughter, Princess Teck, and named her instead. This, together with my reluctance to place Mrs. Heales on the same stand as Princess of Wales, places me in a minority as to naming the best twelve varieties.

Mr. Bunn received fifty-six votes and Golden Beverley nineteen, and yet in the too-much-alike varieties twenty-two electors

bracket them together. This is singular. White Beverley received twenty-one votes and Beverley ten, but they are only one variety. The same remarks apply to Venus and Pink Venus, the term "pink" being merely added by some to more readily distinguish them from the other sports from the same parent. In conclusion, the thanks of all growers are due to the Editor for the trouble this election has given him. All will benefit by its results, and a better system of nomenclature must necessarily be obtained.—J. W. MOORMAN.

GLADIOLI.

NOTHING can be further from the truth than the statement vouchsafed to "W. J. M." (see page 157), that Mr. Banks's Gladioli were left in the ground all the winter. Indeed, as I have seen those initials in the Journal for a number of years, the owner of them might have remembered that some years ago I gave a sketch of the very excellent stand which Mr. Banks had invented for storing his roots; and I can only add that I have never seen except in France corms so carefully harvested as his—indeed they were exactly like Souchet's in the silkiness of the outer skin, so that this finely built theory falls to the ground.

Assuredly had Mr. Banks left his bulbs in the ground all the winter I should have said so: but perhaps "W. J. M." will recollect that this has been the advice tendered by some of our best gardeners, although I do not think the advice is sound.

Fight against it as we may, I fear that my conclusions, whether it be disease, exhaustion, or degeneration, are none the less correct; that the growing of the choicer varieties of this beautiful flower are simply vanity and vexation of spirit; and that those who indulge in it must make up their minds to a somewhat costly and disappointing hobby.

I have lately received letters from two gentlemen who live in Somerset—Mr. Dobree, who has always taken the chief prizes in the shows of the west of England, and Mr. Marshall of Belmont, Taunton, a very enthusiastic and successful horticulturist, and they both agree with my own experience. The former gentleman says that two years ago he expended £20 on them, and that he has hardly any of them left; the latter, after buying all the new varieties for several years, has abandoned the practice, and he threw those he had into mixture, planting them in the borders, but with the same result, and that he has now hardly any of them left. Now in neither of these cases can ignorance be put down as the cause; nor can it be climate, which is supposed to account for the success of Mr. Kelway's culture, for they are but a few miles from Langport.

The idea has been hazarded by Mr. Elwes, who as a grower of bulbs and all kinds of garden plants is well entitled to be regarded as an authority, that we are to account for these losses by the exceptional character of the last few seasons. I fear that this cannot be regarded as sufficient reason, although wet autumns may tend to aggravate the malady; but it is nearly twenty years since I lost almost entirely a collection of about three hundred bulbs of the then best named varieties, and the loss of many bulbs in the collections of all whom I have known has been a matter of yearly occurrence.

It has been a matter of considerable pain to me to write as I have felt compelled to do on this subject. I greatly admire the flower and think it far superior to the Dahlia or Hollyhock, and as a florist would do all I could to encourage the growth of any flower, but I feel none the less that the whole truth ought to be told about it. The Hollyhock has in the same way been affected by a very fatal disease. Did Hollyhock growers hide the fact, even although it led to the discontinuance of their cultivation by a great number of persons? No: they were fain to confess their losses, to tell of the remedies they had tried, and to deplore the condition of their favourite flower; so I have felt with regard to the Gladiolus, and I must leave it to others to judge of the correctness of my views. My motives are, I am sure, simply those of one who wishes well to all lovers of our favourite pursuit.

I have just been placing in pots a quantity of spawn of some of the leading sorts. These I look upon as the *spes gregis*, and believe that some of them will give me good blooms during the ensuing season. This, as I have already stated, I believe to be the only way in which one can hope to keep up a collection, buying in if necessary good varieties which are sold at a moderate price, for I dare not look for a time when I should cease to grow this lovely autumn flower.—D., Deal.

ZYGOPETALUM MACKAYI.

IN reference to the true variety of this handsome Orchid mentioned on page 159, last issue, Mr. F. W. Burbidge, Curator of

the Trinity College Botanic Gardens, Dublin, writes as follows :—
 “The true large-flowered variety of *Zygopetalum Mackayi* has flowers $4\frac{1}{2}$ inches in diameter across the lower sepals. The lip is $2\frac{1}{2}$ inches to $2\frac{3}{4}$ inches across, the pseudo-bulbs very large, the leaves 18 inches to 2 feet 6 inches in length. The spike is 2 feet 6 inches long, and bears about eight flowers. It was originally introduced to the Trinity College Botanic Gardens, Dublin, about 1825, and was named after Dr. Townshend Mackay, the founder and first director of that garden. It is the finest of all the varieties under the name, and no doubt the Drumlanrig plants are true.

The woodcut, fig. 51, represents a plant of the Dublin variety, and will convey a good idea how much superior it is to the forms commonly seen under the above name.

CHRYSANTHEMUMS FROM NOVEMBER TO FEBRUARY.

IN compliance with your wish I send you a few lines as to the method of culture I adopted during the past season, by which *Chrysanthemum* flowers were produced from the last week in November to the first week in February, when some flowers sent to



Fig. 51.—ZYGOPETALUM MACKAYI, DUBLIN VARIETY.

you were noticed in the *Journal of Horticulture* as being remarkably bright and fresh. I see also in the same number of the *Journal* a notice of a bloom sent by Mr. R. P. Brotherston, which is the first the plant has produced, so we are in a fair way to having *Chrysanthemum* flowers all the year round. I grow about fifty varieties, comprising some of all the sections, and including some of the earliest as well as the latest sorts, and all receive the same general treatment.

At the end of last March I put in the strongest cuttings I could get in 4-inch pots, about six in each pot, and placed them in a frame on a slight hotbed, and as soon as growth commenced I pinched out the tops, removing the pots to a cold frame as soon as the side

shoots appeared, gradually inuring them to the air. Before the roots in the cutting pots had become matted together the plants were potted singly in 4-inch pots, and kept close for a few days, and as soon as the pots were filled with roots the plants were shifted into 6-inch pots, each plant having three or four shoots, which were then pegged down and stopped at the rim of the pots. By the end of June the plants had from eight to ten shoots each, and they were then shifted into 8-inch and 11-inch pots, the former for the small-growing sorts and the latter for the larger kinds, but not stopping the shoots. The soil employed was good loam, horse droppings, leaf soil, and sand, four parts of the former to one part each of the three latter, using rather more leaf soil in the earlier stages. As

soon as the shoots became a foot in length, four sticks were placed round the sides of each pot and a piece of twine run round, which made all safe till the end of August, when it could be seen what length the sticks would be required, and then they were permanently staked. Liquid manure, composed of sewage and soot, was given when the flower buds appeared, and as often as the plants wanted watering, which, owing to the continuous rain, was not often, and sometimes it was given when the soil was already wet enough. The plants grew very tall and the buds were thinned according to the variety, some of the Pompons having little or no thinning. They were left out of doors till the end of October unprotected (though if there had been much frost they would have been laid down and covered with canvas), and were then removed to the conservatory, continuing the use of the liquid manure till a good number of flowers were open, which was the case by the end of November. The plants were well furnished with leaves down to the pots, and the last flowers were cut and the plants removed on the 13th of February. My Chrysanthemums are always required late, but this year they came exceptionally so, which I attribute to the low situation, late striking, much rain, late housing, and not to late pinching as some might suppose.—C. C. C.

REVIEW OF BOOK.

Vines and Vine Culture. By ARCHIBALD F. BARRON. London: 171, Fleet Street.

MANY works have been written on Vine culture, and, excellent as the majority of these undoubtedly are, there has been ample room for a larger and more complete volume on the "prince of exotic fruits;" and the person of all others in the best position for accomplishing this greater work is the experienced Superintendent of the Royal Horticultural Society's Gardens at Chiswick. No gardener in the kingdom has had equal facilities for acquiring information on so many varieties of Grapes, and for testing various methods of culture, as Mr. Barron has in the great experimental garden that has been for so many years under his charge; and being observant in habits, patient in the conduct of experiments, a skilful cultivator, and essentially practical, he was not likely to produce a work otherwise than of great excellence. A perfect work on a subject that has to be regarded in so many phases it is not in the power of any individual to produce, by a first effort at any rate; and while the work before us does not attain the practically unattainable standard of being absolutely faultless, we certainly do not agree with the author that it contains "many imperfections," and is characterised by "omissions" of any substantial importance. A few imperfections, or such as appear so to us, will be pointed out with the object of their being considered in view of future editions, for a work of this kind will insure much more than a mere ephemeral popularity, and successive generations of gardeners and others interested in the Vine and its culture will avail themselves of the knowledge that is compressed in its pages.

In scope, the author has embraced the widest possible range, for he commences with Noah and ends with "John Downie," (the new Grape of 1882), and thus covers a period say of 4240 years. "A great deal has happened" during that time in connection with the Vine, and a great deal is recorded in the 240 pages under notice. The historical chapter of eight pages is a model of condensation—the early cultivation of the Vine in Egypt is referred to, and the ancient historians, Plato, Pliny, Theophrastus, and Strabo have been laid under contribution. The Grapes of Damascus "as large as pigeon's eggs, and bunches of 25 lbs. and 40 lbs." are cited, the introduction of the Vine into England by the Romans, the establishment of vineyards, that are enumerated, and the number of varieties recorded at different intervals are included, the subject being pursued until we find the Emperor Augustus, A.D. 10, linked with Mr. Thomson of Galashiels over a bridge of 1863 years.

The cultural portion of the book naturally commences with propagation, the different methods being clearly described, and in most cases illustrated. Raising Vines by layers, cuttings, and from eyes, all have due attention, and full and sound instructions for budding, grafting, and inarching are given.

As we have had many inquiries of late (and, in fact, some are awaiting answers) on grafting Vines, we cannot do better than let our author answer them. On page 22 of the work is the annexed illustration (fig. 52), accompanied by the following remarks:—

"The process of grafting may be performed in various ways, which it will be unnecessary to allude to here. The simplest and best is that represented by our figure—common whip-grafting. It does not matter how large the stem of the Vine may be, for, the graft being prepared, a corresponding portion of the stem is made bare, the requirement being to make as much inner bark fit to inner bark as possible, so that the sap or formative matter immediately below may mingle and become united. In this way it is that the union is effected, not by the fitting of bark to bark or wood to wood, however carefully they may be joined together. The scion being affixed should be tied on tightly with matting, and covered up with some mastic or grafting wax. Mastic l'Homme Lefort is the best material we have ever used. Clay and moss are objectionable, for this reason, that there being much moisture in the house, the graft, instead of

forming an organic union, emits roots into the clay, &c., and so never unites with the stock. In about ten or twelve days after grafting, if the operation has been successful, the bud will have grown somewhat. The shoots left on the stock beyond the graft should now be checked and kept in subjection to the graft; and in about a month's time the matting and wax should be removed, and the shoot treated as established. Vines grafted in this manner on strong stocks will grow 20 to 30 feet the first season, and produce the strongest possible wood; and Vines of any size or of any age, if in a healthy condition, may be so operated upon. It is a capital plan of introducing a new variety into an established house."

As will be observed, the stock is permitted to grow somewhat freely before the scion is attached. The figure now given and method described show the thoroughly useful and practical nature of the work before us.

The chapter on hybridising and raising Vines from seed shows with great clearness how the work of fertilisation must be performed, the magnified figures of the flower of the Vine being of great assistance in this respect; at the same time a suggestive hint is given relative to "varieties of Grapes sent out as distinct, which ultimately prove nothing but old sorts"—namely, a little more vigour, which is inherent to a seedling Vine, and hence it produces larger fruit "for a time," and the chances are "a hundred to one against anything new being obtained," except by careful and proper fertilisation.

The author's views on border-formation, soils, &c., are generally sound. As might be expected, he has no elaborate formula to submit which can be considered in any way indispensable, but in a few words states what he considers to be the best compost, and advises the cultivator to "get as near it as possible," and not to despair if he cannot obtain the best turfy loam, as good Grapes can be grown in ordinarily fertile garden soil. The size of borders, inside *versus* outside borders, drainage, raised borders, and heated borders are discussed, and not many persons will quarrel with the conclusions arrived at; but on the matter of aerating borders with drain pipes it is a question if the author's pupil, Mr. W. Taylor, has not almost exploded this method of sweetening and purifying the materials. See "Vines at Longleat," page 5. The reference to covering Vine borders with fermenting materials is fully too brief, seeing that so much injury has resulted both by covering too early and uncovering too soon. No exception can be taken to what is stated, but a dozen lines might be added with advantage. The observations on mulching, watering, and renovating old Vines are clear, concise, and satisfactory.

Structures for Grape-growing are dealt with in the next chapter, and illustrations given. Mr. Barron attaches very little importance to particular angles, but observes with truth that very steep lean-to vineries are "extremely sensitive" to changes of temperature, and require great care in ventilation; still, the houses should be adapted to the special requirements of each case, and these are indicated. In the chapter on heating Hood's table for determining the length of piping for heating a structure is submitted, as affording, however, "only an approximative idea." Very approximative indeed is our remark on this, and quite as likely to mislead the inexperienced amateur as to aid him. Even the example quoted has a tendency in the former direction, because the data of an external temperature of 32° and a pipe temperature of 200° are not safe. A much lower external temperature must be provided against, and this, too, without heating the pipes so highly. No mistake, however, can be made if readers ignore the table and follow the author's instructions in the last half dozen lines of the chapter.

The chapters devoted to the planting of Vines and the general management of vineries, including forcing, temperature, ventilation, and moisture, are as good as can be written in the space they occupy, and here we may observe one of the merits of the book is its pithiness. Exception may possibly be taken by some readers to the suggestion that "a temperature of about 60° will be sufficient until the Vines have started into growth," not in the sense of denying that sufficiency, but, on the contrary, that temperature will be considered needlessly high by not a few. It is above the orthodox standard; but heterodoxy in this matter is not always dangerous, as a famous gardener in one of the leading establishments in the kingdom habitually starts his Vines at the least 10° higher than the temperature above indicated. Perhaps it amounts to the same thing as travelling by express or ordinary train, the one being quicker than the other, but both equally safe.

Under the head of Pruning and Training, the different systems of training Vines are adverted to. The methods of pruning are represented by several figures executed in outline, which will be useful to the uninitiated, and certainly not less so will some others that cannot fail to make the important matter of stopping the growths in summer clear to all. The remarks on shortening the young canes the first season after planting "as low as you can, as leaving a good long rod on a young Vine is in many cases the commencement of the road to ruin," will not find universal acceptance; but bearing in mind the qualifying words "in many cases," the assertion is true. The chapter on disbudding and summer dressing is one of the best in the book; in fact, we should find it difficult to point out any treatise where so much sound and valuable matter is conveyed in such few words.

The necessary conditions for setting the fruit are plainly stated, high night temperatures being considered of less importance than a high sun temperature under otherwise suitable conditions, such as

early ventilation for drying the pollen as soon as possible for insuring its dispersion; artificial aids for effecting this are also noted.

The author has left us little to find fault with thus far, but we are quite unable to pass the chapter on thinning the fruit with unqualified approval. With the author's remarks we find no fault whatever, but we cannot regard the figure on page 93 of the volume as representing a "properly thinned" bunch. This being an educational subject we are bound to point out the faults of this specimen. It is impossible for a bunch so thinned to be well furnished and well balanced. In the first place too many berries are removed from the upper side of the top shoulders. This is a common mistake. It is there, if anywhere, that the Grapes have room to swell, and sufficient should always be left to curl back, as it were, and hide the stalk as

much as possible, as in plates i. and vi. of the work. It is impossible that this desideratum can be accomplished by the removal of so many "top berries." Again, while the two upper shoulders are of the same length in the engraving, and originally contained an equal number of berries, in one shoulder they are reduced to four, while on the other six are retained. This may appear to some persons a small matter to mention, but if we look at the branchlets immediately below we find the one under the shoulder with four berries only contains two, while on that under the shoulder with six berries five are left; or together six are shown on one side of the bunch and eleven on the other. Such a bunch cannot be evenly and well shouldered; and the lower part is also faulty, as one side, the light-shouldered side by the way, contains—from the two top branchlets indicated to the

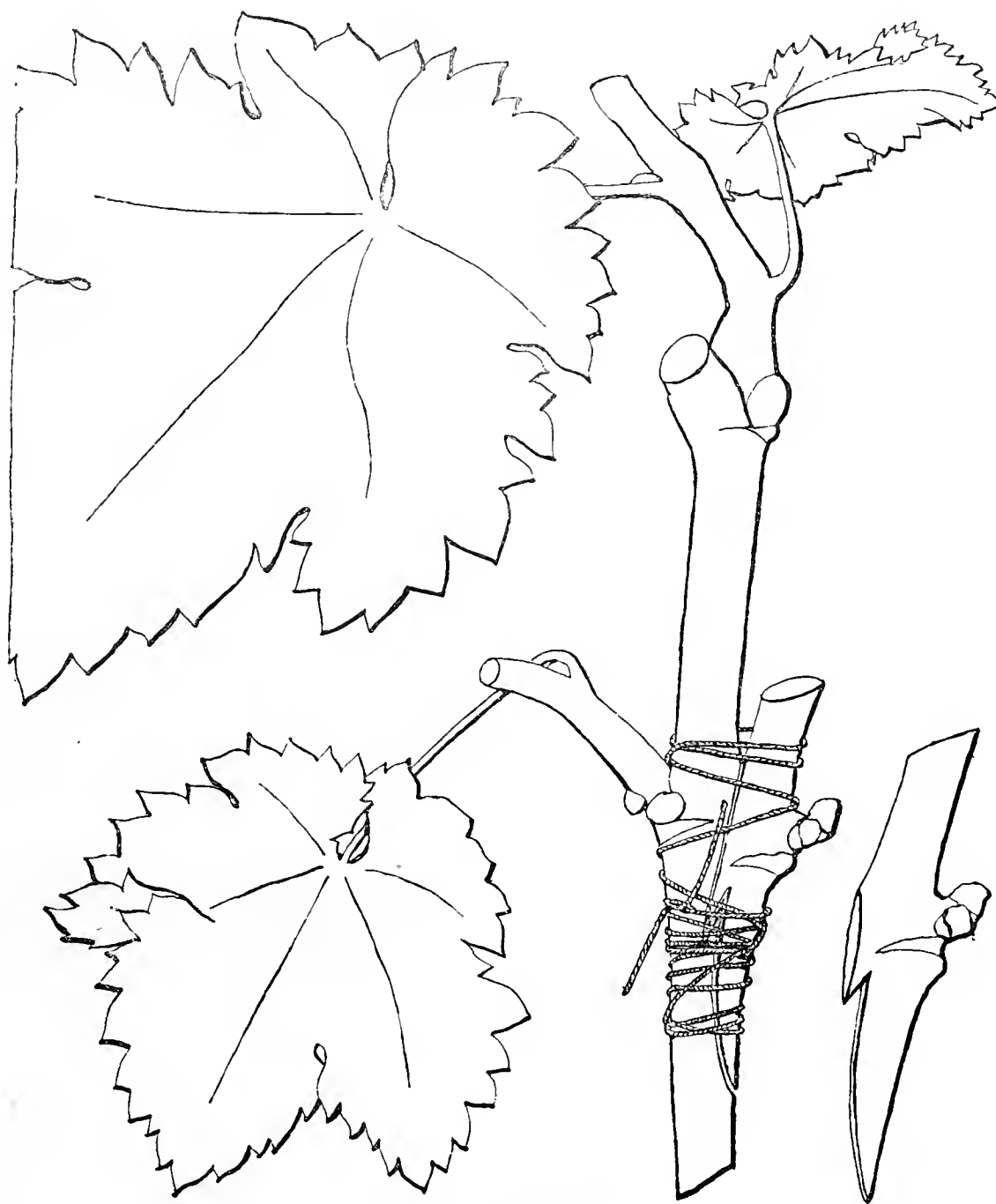

Fig. 52.—VINE-GRAFTING.

point—eleven berries, while on the opposite side from the same point there are only seven. This method of thinning can have only one result—an irregular bunch, and the work is also shown as roughly performed. All the figure does is to give an idea of the number of berries that should be removed. In this respect it is suggestive, and we can only say that those who have Grapes to thin should endeavour to improve on the example shown as much as possible. The bunch has evidently been hurriedly thinned, has not been well selected, nor has the figure been well executed for the purpose it was designed to serve.

An illustrated chapter is devoted to keeping the fruit, followed by one on packing Grapes for market and exhibition. The requisite details are given on growing, fruiting, and forcing Vines in pots, an illustration being furnished of a handsome example for table decoration grown by Mr. Sage; and a method is submitted of growing "Tom Thumb" Vines in small pots for the same purpose.

The experience recorded on the effects of grafting in the large

vinery at Chiswick are interesting, and the chapters on Vines on open walls and in ground vineries will be useful to many.

The diseases and injuries to which Vines are liable are fully yet concisely treated, their causes and prevention suggested, and remedies provided. These apply to rust, spot, scalding, warts on the leaves, bleeding, shanking, and mildew on the roots and berries. The various insects attacking the Vine are also clearly illustrated, this being the concluding chapter on what may be termed the practical part of the book, and not the least instructive in this valuable work.

The remaining pages are occupied with selections of Grapes, a classification of Grapes, and a comprehensive series of descriptive, historical, and cultural notes on the varieties of European Grapes. All the leading varieties are further admirably figured on tinted paper, the bunches being shown one-third of their natural size, with separate full-sized berries of each accompanying them. In the selections lists of varieties are compiled for pot culture, for the open

air, for a greenhouse, for market or sale purposes, for exhibition, for late keeping, for early forcing, for high quality, for producing large bunches, and for yielding large berries, to all these being added a list of Grapes of "peculiar interest."

In his classification of the varieties of Grapes Mr. Barron divides them into—1, European Grapes; and 2, American Grapes—which is a very natural and intelligible division, seeing the two are so distinct as to belong to two different species. The first he subdivides into—1, Sweetwater Grapes, or varieties with a sweet, sugary, or saccharine flavour, the juice thin but pleasant, varying in sweetness; skin generally thin and tender. Here are included Black Hamburgh, Trencham Black, Duke of Buccleuch, and Royal Muscadine. 2, Muscat Grapes, which, of course, include the Muscats and Frontignans; but we observe that he also places Mrs. Pearson in this division, which we have never met with possessing a distinct Muscat flavour. 3, Vinous Grapes, which are described as varieties with a strong vinous, somewhat harsh, semi-saccharine flavour, and a thick skin, mostly requiring a considerable amount of heat and time to ripen. Here he places Alicante, Dutch Hamburgh, Lady Downe's, West's St. Peter's, &c. It is questionable how far it will be possible for people generally to discriminate the distinction between a Sweetwater and a vinous Grape so as to make it a characteristic for classification. We once knew a man who professed to be able to detect a glass of '34 port if it were blended in a bottle of '47, but such feats are not common, and we suspect that Mr. Barron's division of Grapes into Sweetwater and vinous flavours will lead to mistakes when we consider how "tastes differ."

Mr. Barron is creditably correct in his nomenclature. We detect a few errors which we are sure will be corrected in another edition. The proper spelling of Chavoush is Chaouch. It is a Turkish word, and the Grape is supposed to be a Turkish variety. Mihaud de Pradel should be Milhaud de Pradel, and his reference of Black Champion as a synonym of Mill Hill Hamburgh is an error. Black Champion is a very distinct Grape, with an oval berry and with a fine dark colour. It was introduced about forty years ago by Sir John Mordaunt, and is probably identical with San Antonio.

We have dealt with this work fully, freely, and, we think, fairly. Its importance merits this attention. It is the most complete, as it will be accepted as the standard, work on the Vine. Everyone interested in the subject on which it treats should possess it, and it should be added, as no doubt it will be, to the collections in all public libraries. Its production has necessarily been costly, and its price will be beyond the means of many young gardeners; but not a few of these may soon possess this admirable text-book by placing aside 6d. a week until they accomplish their purpose. This will be tantamount to "taking it in in parts," but better, and their savings will be well invested.

We must add that the greater portion of the matter originally appeared in the "Florist and Pomologist." The author also recognises his indebtedness in the frankest possible manner to all others who have aided him in the production of the volume on which he has been for so many years engaged, and which is in every respect finished so well—paper, letter-press, illustrations (in most cases), and binding being of uniform good quality.

GARDEN STRUCTURES.

I MUST hasten to say in reply to "R. P. B.'s" remarks, that I do not impute ignorance to gardeners, though "Single-handed's" remarks would bear that construction. If ignorance is to be imputed it should be to the Jack-of-all-trades men, who "put up" the so-called conservatories to villa residences and fruit or plant houses in country gardens sometimes. The examples I gave as fair specimens of what I am continually receiving, and do not vary more than the practice of those same men would in matters of cultivation.

The details given of a structure now being built are interesting, but such a mass of ironwork battened into stones would cost as a rule (south of the Trent) as much as the remainder of the house. In Scotland and in other places where labour is cheap, or the labourers on the estate are pressed into the service of the carpenter and their wages or time is not computed, the building of such span-roof pits will seem less costly than the finished work of a regular builder, but I could give proofs that the economy is only in cases where certain men have to be kept on and work must be found for them to do.

I will say nothing on the absence of top ventilation in "R. P. B.'s" structure, so strongly insisted on by my old employer Sir Joseph Paxton (gardeners, like doctors, differ), nor will I attempt to connect this with the quantity of condensed water that space had to be provided for specially; but would like to mention an incident that came under a builder's notice lately. The windows of a bedroom in an old house were rather loose and rattled in windy weather, so the good lady of the house ordered new heads to be had and the sashes fixed quite tight. Three weeks after she complained of stuffiness and the water which covered the windows every morning; it was suggested that ventilation was needed. Oh, no! that meant a draught; but the

carpenter quietly bored half a dozen holes in the top rails of the sashes out of sight and said nothing. Since that time no water has been seen on the glass, except after two or three very cold nights.

As to pitch of roofs, I could refer to more *new* Peach houses over 45° than under that angle—not wall cases, but houses over 11 or 12 feet wide against walls 13 to 15 feet high, with trees trained in front half way up the glass so as not to obstruct a single ray of sunlight from trees on the wall, the fronts only 2 feet high. I may say that the short back sash is generally used to give more room to get at the trees high up, and that it is better to slope upwards from the wall, so that no shadow is cast on the wall from the junction of the two sashes.

Flat roofs require stronger timbers or supports underneath in their construction than a moderate pitch of 30° to 35° would do, especially in Scotland, because snow will lie on the former, which would shoot off the steeper pitch. If "R. P. B." had made his ridge 6 or 9 inches higher and his fifth "astragal" or rafter an inch deeper he would have needed no 2-inch T iron rafters unless his width had been double that named.—B. W. WARHURST.

CULTURE OF THE COCKSCOMB.

THE Cockscomb is a beautiful plant, but is not often seen in good condition. It is most useful for conservatory decoration for the late summer months. It is of the first importance to obtain a good strain of seed, as some of the strains are worthless; and the next thing is to provide a good dung frame, as they will not do at all well in a hot-water-heated structure. The seed should be sown the first week in March, and plunged in the frame, which should have a minimum temperature of 70°, and the plants must be kept in this temperature all through their growing season. After the seeds have germinated place the pots near the glass to prevent the young seedlings from becoming drawn. When strong enough transfer the plants into 60-size pots, placing the stems as low as possible, in a compost of two parts turfy loam, one of leaf soil, and a little sand. Keep them plunged close to the glass until they have finished growing. Keep them in these pots until the flower heads appear, and then repot into 48-size pots in the following compost: Two parts turfy loam, one part leaf soil, and one part well-decayed cow manure, with a liberal sprinkling of charcoal and sand. After they have filled these with roots transfer them into 8 or 9-inch pots, which must be well drained. When the plants are well rooted supply them with warm liquid manure until they have attained their full size, when they should be hardened and removed to the greenhouse.—A. YOUNG.



[By the most skilful Cultivators in the several Departments.]

KITCHEN GARDEN.

MARCH is always a busy month in the kitchen garden, and it is to be hoped the weather will allow seasonable operations to be put well forward. In many instances I fear the quarters will as yet be empty, and when suitable weather occurs a general cropping may take place. Seeds of all vegetables may now be sown with advantage. The main crop of Onions should be sown as soon as possible. The ground should be deeply dug and heavily manured, and the drills should only be opened for sowing on a dry day, the best way being to sow the seed in rows 12 inches or 15 inches apart. A heavy, sound, well-matured crop cannot be had in any shady place, and the most sunny part of the garden should be chosen for them. If the Onions and all other seeds can be covered with some old dry soil from the potting shed it will be found to assist a free germination of the seed. A good batch of second early Peas should be sown at once. Broad Beans may also be sown in quantity, and Carrots of the Horn section. Brussels Sprouts, Cabbage, Cauliflower, and Lettuce seed may be sown in the open border. Good patches of them may be sown broadcast on a rich soil and covered to the depth of half an inch. Parsley may be sown as a main crop. This we never like to have confined to one spot, but prefer it in two or three places in the garden, as when one fails the other may succeed. There is no crop more liable to be destroyed by grub, and precautions must be taken at sowing time to avert this. We have tried soot, salt, and gas lime

in our Parsley ground, and now prefer the salt. It is applied as a sprinkling and dug in.

Asparagus.—The beds now require attention. In many cases they may have had a mulching during the winter, and this should be drawn from the crowns and forked in around the roots. Deep digging or forking must be avoided, as this injures the roots and weakens the produce. Stimulants are of the greatest benefit at this time, and a good dressing of salt and soot, or salt and guano mixed together, is always applied at this season. A sprinkling of it is forked in now, and another is thrown on the surface and washed in with the rain later on.

Cauliflower plants which have been wintering in frames and handlights should now be taken out to the open borders. In this case we only thin out the plants and allow some of them to remain, as they head earlier than those transplanted now. Jerusalem Artichokes have all been lifted and replanted again singly 2 feet from row to row, and 18 inches from set to set. We find a deep rich soil gives the finest tubers. It is a crop which merits more extensive culture than it receives.

Peas which were sown a month ago in small pots have been hardened, and they will now be planted in the open borders. A drill is opened as if for seed, but deeper, and potfuls are planted in this about 6 inches apart without breaking the ball. As they are 4 inches high, a few small twigs are placed in to hold them up as planting goes on, and this also affords them shelter, which is sometimes wanted in March.

Potatoes, Carrots, and Radish in hotbeds are now growing freely, and abundance of air should be admitted to them on all favourable occasions. When kept too close top growth is rapidly developed, but the roots do not form in proportion, and may partially fail from this cause. Some of the early Cauliflowers sown in boxes under glass a month ago are ready for transplanting. Where a very slight hotbed can be formed, with a frame and a little light rich soil on the surface, an excellent place will thus be secured for dibbling out young plants. They root fast in such a position, and can be easily hardened previous to putting in the open quarters. Celery should, if possible, be treated in this way, and the earliest crop should have attention of the kind at once. Our earliest spring Cabbages, which will be ready for cutting in a month hence, or at Easter, are now having any weeds and dead leaves taken from them, and the soil is afterwards broken up between the rows and put to the stems as an earthing-up with the fork. This is the best of all stimulants for spring Cabbages. More Cabbages may also be planted. Plants raised from seed sown last autumn are the most suitable for planting now. Our plan is to plant all the largest in autumn, leaving the smallest in the seed beds to plant now. Sow more Kidney Beans, Tomatoes, and ridge Cucumbers, and keep all vegetables under glass well supplied with rich materials, plenty of water, and a genial atmosphere.

FRUIT-FORCING.

Vines.—When thinning the earliest Grapes has been completed and the inside borders have been watered with liquid manure at a temperature of 80° the berries will swell rapidly until they reach the stoning period; but any unfertilised berries, as will be indicated by their not swelling freely, should be removed before this stage is attained, and after tying up the heaviest shoulders a few more may be removed, if necessary, to allow of the berries attaining their full size without becoming wedged. At the same time calculate the weight of Grapes each rod is likely to finish, and, if there be any fear of the crop being too full, the removal of a few of the worst bunches will give much more satisfaction in the result than an excessive crop. The strongest spur shoots being tied down and stopped at two or more joints beyond the bunches, the leaders and laterals should be allowed free run until every part of the trellis is filled with foliage, having room for its development and full exposure to light, after which keep them closely pinched to one joint. Encourage succession Vines by closing the houses early, with sun heat and plenty of moisture well charged with ammonia from the mulching and the liberal use of liquid manure about the paths and walls; but avoid a close moist atmosphere, also a high night temperature, giving, if necessary, a little top ventilation on mild nights. As the most promising shoots elongate disbud by degrees, and endeavour to obtain close-jointed growths and thick leathery foliage.

The treatment advised for early and succession houses may now be applied to Lady Downe's and other late varieties intended for keeping through the winter, it being better to apply fire heat in the spring, if these Grapes are to become thoroughly ripened and to keep without shrivelling until the following May, than to run the risk of a cold sunless autumn, when hard firing becomes absolutely necessary and the close atmosphere necessitated only aggravates the evil.

Cherry House.—Continue 50° to 55° as the temperature from fire heat through the day, and dispense with it entirely at night, only the temperature must be kept from falling below 40°. The trees will be in flower, when the ventilation should be free upon all favourable occasions, and the blossoms fertilised; but if bees abound it will be accomplished by them, otherwise artificial means must be resorted to during the time the house is freely ventilated, commencing to do this at 55°, giving it plentifully at 65°, and closing for the day at 55°. Moderate moisture should be maintained by damping available surfaces as they become dry.

Melons.—These are making good growth, which should be encouraged by maintaining a bottom heat of 85°, not allowing the plants to suffer from insufficient or excessive water at the roots. Maintain a genial atmosphere in the house by sprinkling the plants and the house on bright mornings and afternoons. Ventilate at 75°, close at 85° and rise to 90°, with a night temperature of 70° or 65° on cold nights. Attend to stopping and tying, also thinning the young shoots, and fertilise the blossoms on fine days when the pollen is dry. Stop the shoots at one joint beyond the fruits, which, when they have set and have commenced swelling, should be thinned, leaving three or four of the best and most even fruit on each plant, distributed as regularly as possible. Succession plantings and sowings must now and for the next two months be made in accordance with the requirements of establishments.

Cucumbers.—Apply tepid liquid manure to plants in bearing, and syringe them gently twice a day. Ventilate early, but avoid keen winds, as these are very injurious to the young growths. Keep the bottom heat at from 80° to 85°, maintaining the night temperature at 65° to 70°, ventilating a little at 75°, closing at 85° and rise to 90°, and keep the evaporation troughs filled with liquid manure. Attend to tying and removing any superfluous fruit or shoots. Young plants making vigorous growths must be trained regularly, but not too closely, over the trellis. A little soil must be added to the ridges or hillocks as the roots protrude until the allotted space is filled. Make successional sowings to meet the demands of the establishment, and attend to the linings of hotbeds, having fermenting materials in preparation of making fresh beds.

FLOWER GARDEN AND PLEASURE GROUND.

Pruning Shrubs and Conifers.—The weather being favourable for other gardening operations we find it advisable to commence this work earlier than usual, and thus liberate the men later on, when planting and cropping may be resumed. A certain amount of trimming, thinning, and shortening is advisable in all shrubberies, as this, if judiciously practised, enhances the beauty of many specimens and improves the general appearance of the whole. The majority of Conifers are naturally of pyramidal habit; but in the case of younger specimens, and sometimes of the older ones when injured, it is necessary to either select and stake up a leading growth, or to shorten back other leading shoots when more than one are formed. Occasionally one or more horizontal branches outgrow the remainder, and these again should be freely cut back. Well-furnished and comparatively neat specimens are thus obtained, which are more pleasing than unshapely trees. Common Laurels where allowed to grow unrestricted, and are not injured by severe frosts, soon become irregular and unsightly, but if cut down to near the ground they will shoot up again this season, and soon fill up the blanks again. It is better, however, to prune annually, and thus avoid this renovating process. The Portugal Laurel also breaks freely, however hard they may be cut back, and so, too, do Yews. Laurustinus where not quite killed during the severe winter of 1880 and 1881 started vigorously from the old stumps, and are now healthy handsome bushes. Others freely cut back are also greatly improved in appearance, and the owners of tall ragged specimens should also shorten these back considerably, or cut them down to the ground. *Arbutus Unedo* does not like pruning; but Box, Hollies, Aucubas, Rhododendrons, Lilacs, Escallonias, Berberises, Cotoneasters, Viburnums, Sweet Bays, Euonymuses, Indigoferas, *Buddlea globosa*, Weigelas, Spiræas, Robinias, Acacias, Ribes, Mock Orange, *Leycesteria formosa*, Hydrangeas, Hibiscuses, Genistas, Forsythias (after flowering), Thorns, Dogwood, flowering Cherries, Plums, Peaches, Privets, Maples, Almonds, will all bear pruning, and in several instances be much improved.

Large branches should always be sawn off, and the edges of the cuts rounded with a knife. Where the billhook is used the cuts should be made in an upward direction. This in each instance insures a clean cut, which heals more quickly and with a greater certainty than jagged reckless cuts. The trimmings may be burnt and the ashes preserved for manurial purposes.

Propagating Bedding Plants.—Succulent plants now figure very prominently in the flower garden every summer, and in carpet beds especially are very effective. Echeverias and Sempervivums are best known, and both may be easily propagated by seed. This being small should be sown on the surface of pans of moist sandy soil, covered with glass, placed in heat and shaded. The seedlings when large enough to be pricked off in pans of light sandy soil and kept in heat till of good size. Where there is a stock of plants it is preferable to increase them by leaves inserted in sand. Echeveria Peacockii is a handsome improvement on E. secunda glauca, and, like that good old variety, may be increased by offsets, and the latter remark applies to the useful E. metallica. Old plants of E. metallica and Pachyphytum bracteosum should have their tops taken off with about 2 inches of stem attached, any disfigured leaves removed, and to be dibbled singly into the centre of 3-inch pots previously well drained and filled with light sandy compost. They should be placed on a shelf in a warm house, and receive little or no water till rooted, after which they may be watered when dry and gradually hardened off. It is advisable to keep the old plants rather dry at the roots for a few days prior to topping them, neither should they receive any water till breaking afresh. Strong old stems introduced into a forcing house will each yield several side shoots, and these may be taken off and rooted before bedding-out commences. Small leaves laid on shelves or dibbled into pans of sandy soil root and form plants. The tall-growing or tree section of Sempervivums may be rapidly increased by cuttings in moderate heat, placing these in pans of sandy soil. The dwarf-growing Sempervivums are principally increased by offsets and seed. Kleinia repens is particularly effective in lines or groups in the carpet beds, and at this time the tops of all the shoots may be rooted in heat, grown quickly, and again topped and struck, while the older plants may be shaken out and divided. Kleinia tomentosa may also be readily struck in heat. Agave americana variegata is easily increased by suckers; these, if slow-growing, are serviceable and effective. Mesembryanthemums, of which the most popular is M. cordifolium variegatum, are rapidly increased by cuttings in heat. Succulents of all kinds should not be watered when first dibbled in, and in the case of the strong growers the tops should be laid on a dry shelf for the cuts to heal. None of them should be shaded, warm sunny shelves being the best position in which to strike them, If the centres of a few strong plants of Sempervivum tabulæforme are taken out this will induce the formation of a number of side shoots, which may be taken off, rooted, and grown for next season's bedding-out.

THE BEE-KEEPER.

THE ART OF BEE-KEEPING.—No. 8.

(Continued from page 122.)

SURPLUS HONEY ARRANGEMENTS.

THERE has been a great advance made in recent years in the methods adopted for securing the surplus honey that goes to reward the bee-keeper for his expenditure of money and time. Formerly the only way was to destroy the bees of certain hives and then take the whole remaining contents. Then came the more humane method of driving the bees, and either uniting them to other stocks, or feeding them so as to have fresh combs built and stored with food before the winter. In either case there was much needless waste, owing to the loss of good combs, which were really of much more value than the small quantities of wax obtained from them. The pollen stored in the combs was also entirely lost; and in districts yielding this but sparsely, and with no substitute then known, this loss was a real one. Much also of the honey then obtained was necessarily of inferior quality.

Modern bee-keepers never, if they can avoid it, break up combs that have been bred in for the sake of their honey. If liquid honey be wanted it is taken from the combs by the aid of the honey-extractor, which we shall refer to at another time. Special means are also taken in such a case to obtain the largest possible quantities of extracted honey by supplying the bees with clean empty combs greatly in excess of their requirements for breeding purposes. These extra combs are either hung in the ends of the single-storey hive, where this is constructed with sufficient capacity, or else in a second hive to be used as an upper storey. If ten frames be considered sufficient for breeding purposes, at least other ten will be required for extracting from. The best results are, however, obtained when at least two upper storeys filled with comb are available; for when

the first has been filled it requires some time to ripen thoroughly, which may be known by its being nearly all sealed over. During this time the bees will, if honey is coming in freely, be storing in the breeding box, and thus cramping the laying powers of the queen at a season when these should have full scope. It is of great advantage, therefore, to have a spare hive full of combs which may be put on as a temporary third storey. Indeed, in extra good seasons, especially when the bee-keeper is pressed for time to extract, even a fourth and fifth storey will be found very useful. Our American friends, who work on this principle, tell us of results, well authenticated, but almost too wonderful to be believed. When we learn, however, that owing to the usual great mortality among their stocks in wintering they generally have enormous stocks of spare combs for extracting purposes, and when we know that hives will frequently gather over 10 lbs. of honey a day, we need not wonder so much after all. It ought to be the ambition of every bee-keeper who uses the extractor to have a large stock of spare clean combs. Drone comb is even better than worker comb for the purpose, and all are the better for having been bred in for one or two seasons.

Those who have no extractor, or who may have too few stocks to render it worth its cost to them, and yet prefer honey in the liquid form, may obtain many of the benefits of this method of working by filling the upper storeys with frames full of comb foundation. When full, the new combs may be broken up and cold-drained after the common fashion. After the most of the honey has drained out the combs may then be put into a dish and set in the oven to melt. On again cooling, the wax will be found separated in almost a pure state, and a quantity of honey will still be found below scarcely inferior to that obtained before. As more wax will be obtained by this method than the weight of comb foundation used originally, it will be found nearly to balance its cost. These methods are pre-eminently suited to those who have little time to attend to their bees in the height of the season, as with so little trouble greatly increased capacity is given, and the trouble of taking the honey can be deferred to any convenient season. Bees thus treated seldom attempt to swarm, which is another advantage.

Most persons prefer honey in the comb, even though they may have to pay 50 per cent. more for it. They consider it less likely to be adulterated, it has a more attractive appearance, and many think it has a more refined flavour. It may be argued, on the other hand, that it is about as easy to pass off sugar-fed comb for honey-comb as it is to sell glucose or any of its admixtures for extracted honey; that extracted honey in its purity, when put up in neat white glass jars and nicely labelled, is comely enough to please most tastes; that if properly treated it is as richly flavoured as any comb honey, and that it is certainly more wholesome. But while endeavouring to educate the public taste, bee-keepers must take it as they find it, and endeavour to make the most of the product of their hives. It is not the less for their interests, however, they should endeavour to push extracted honey into the market rather than comb. The former is cleanly to handle, easy to pack, and safe to keep for any length of time; while the losses in handling the latter must average a considerable sum year by year. The writer has had many lamentable evidences of such losses in connection with exhibits sent to the various honey shows. Cases of from 10 to 120 lbs. have arrived in all stages of wreck, rendering them unfit for exhibition, and lowering their value by half at least. The fault in every case has been mainly with the packing, but evidences were not wanting of rough handling by the railway officials; yet I last season sent several hundreds of pounds to London without a single comb being hurt; indeed I have never lost anything from such a cause. But it is almost impossible to get average bee-keepers to understand the mysteries of safe packing. The sad experience of one year seems to produce no improvement the next. On such account we strongly urge the fostering of a public taste for extracted honey, say in 1 lb. or 2 lb. glass jars.

Meanwhile we must consider how we can best meet the demand for comb honey in an attractive form. The disgusting spectacle of eut combs exposed for sale covered with dust and flies is fast giving way to an attractive array of virgin comb in straw caps, boxes, and single-comb sections, generally protected by glass, and attractively ornamented as most shop goods are now-a-days. A study of the requirements of the trade leads us to recommend that this variety, in the size and nature of the cases in which comb honey is stored, should be kept up to some extent, in spite of the tendency in some quarters towards the uniform section. The larger dealers still prefer to have the bulk of their honey in cases of from 10 to 20 lbs. each, and find these readily saleable. We therefore urge the use of such cases, especially as the bees will store a larger weight of honey in them in the same time than they would do in separate sections. For convenience in securing the combs for transit by placing paper pads between, and in cutting out a comb for use without mutilating the others, the combs should all be built on straight guides of comb foundation

placed about 2 inches apart. When straw supers are used this is rather difficult to accomplish, and many prefer guides of clean white comb, which may be fastened by being first dipped in hot wax, and then quickly applied to the place where they are to remain. We prefer, however, to have our straw supers worked with flat wooden tops, in which case the strips of foundation are more easily fastened. Boxes present no difficulty, provided they are, as they should always be, quite shallow, not over 4 inches in depth. These are most attractive when made to take separators of glass. For this purpose the sides next the ends of the proposed combs are to be grooved with a saw before they are nailed together at intervals of 2 inches or rather less. The separators are dropped into these grooves after the box is made and guides fastened, and are pinned in so as to allow a quarter of an inch travelling space above and below. An additional beauty and means of safety are given by the use of bottom rails of glass about $1\frac{1}{4}$ inch wide. One of these is placed under each guide, and fastened either in a groove or on a ledge put in for the purpose. The usual travelling space should be left below these bottom rails, in which case it will generally be found that the bees bring their comb quite down to the glass, leaving scarcely any passages, and that they store their honey right against the glass so that its beautiful tints may be clearly seen. A still further advantage in these beautiful boxes consists in having the sides cut almost through just opposite the separators, and the top made of bars $1\frac{1}{2}$ or $1\frac{3}{4}$ inch wide, thus leaving passages for the bees where more than one box is used. By the aid of the saw cuts mentioned, and the passages between the top bars, the whole case can, if required, be cut up with a penknife into sections of one or more combs as may be required. The most attractive cases of honey we ever saw were in boxes of this description, from 14 to 16 inches square, and from 3 to 5 inches deep.

Bell-shaped glasses for honeycomb are now almost entirely discarded, except by those who keep bees chiefly for pleasure. They are difficult to guide, afford no foothold to the bees in clustering, troublesome to keep warm enough, and almost unsaleable when finished, owing to the cost of the glass. We do not therefore recommend their use to beginners. If variety be wanted, there is endless scope in the variations of straw, wood, and glass, singly or combined, and of shapes to please any fancy. But the principal efforts of the commercial bee-keeper will be in the direction of the now well-known sections. A few hints as to their manipulation will occupy our next paper.—WILLIAM RAITT, *Blairgowrie*.

(To be continued.)

TRADE CATALOGUES RECEIVED.

George White, Paisley.—*Catalogue of Florists' Flowers*.
J. O. Manson, Harford, U.S. America.—*Catalogue of Flower and Vegetable Seeds (Illustrated)*.



** All correspondence should be directed either to "The Editor" or to "The Publisher." Letters addressed to Dr. Hogg or members of the staff often remain unopened unavoidably. We request that no one will write privately to any of our correspondents, as doing so subjects them to unjustifiable trouble and expense.

Correspondents should not mix up on the same sheet questions relating to Gardening and those on Poultry and Bee subjects, and should never send more than two or three questions at once. All articles intended for insertion should be written on one side of the paper only. We cannot reply to questions through the post, and we do not undertake to return rejected communications.

Rainfall (*G. S., St. Austell*).—We cannot publish your record, as it is incomplete and does not give the total for the year, January being omitted.

American Tomatoes (*J. O. Manson*).—The new varieties of which you have sent seeds shall be grown during the present season, and their merits when ascertained will be recorded in our columns.

Peas for Prizes (*An Amateur*).—In matters of this kind it is better to communicate directly with the firms in question, and no doubt any suggestion that is made will be duly considered.

Petroleum (*G. S., Renfrew*).—The so-called paraffin oil is what is referred to under its proper name of petroleum when used in reference to destroying insects. A syringe would be far better than a watering-can for applying it against the Onion fly, both as insuring greater force and not using so much of the solution, an excess being injurious.

Horticultural Shows (*Primrose & Co.*).—The fixtures of the Royal Horticultural and Royal Botanic Societies' Shows have been published in our

columns—those of the former and also some Rose-show fixtures in our last issue. The fixtures of many large provincial shows have not been announced, and the only method of obtaining the earliest information would be by writing to the Secretaries. A list of Botanical, Horticultural, and Floral Societies is published on page 217 of the "Horticultural Directory," which can be obtained from this office, price 1s. 3d., post free.

Vines Bleeding (*E. D'O.*).—Late pruning is the primary cause of an escape of the sap. When the Vines are very luxuriant and commence bleeding in the spring it is often very difficult to stop the outflow of sap. Dry the ends of the canes at once as well as you can, and dress them with painters' knotting. This is one of the best remedies we know. If any of our readers know of a better mode of stopping the bleeding of Vines, we shall be obliged if they will send us the particulars for publication.

Invigorating Roses (*Anonymous*).—We do not know what the recipe was to which you allude, nor have we much faith in fanciful prescriptions that are compiled to "catch the eye" in ephemeral publications. If you can make the real state of your Roses intelligible to us, and the character of the soil, we think we can give advice that will at least be as useful as that in the "Companion" to which you allude. The potash in wood ashes is undoubtedly of service as a manure, but something more is needed in the majority of cases where Roses fail to grow satisfactorily.

Work on Gardening (*L. H. M.*).—The work to which you refer, we believe, can now only be obtained secondhand, and is also to some extent out of date, scores of Orchids having been introduced since it was published. It is satisfactory so far as it goes. There is no modern work of the kind obtainable. (*J. L.*).—The book most suited for your requirements is "Fruit Culture under Glass," by Mr. D. Thomson, published by Messrs. Blackwood & Sons, Edinburgh and London, price 7s. 6d.

Trees for Damp Situation (*W., Surrey*).—We doubt if any tree would grow so quickly under the conditions indicated as the Black Italian Poplar. The White Poplar (*Populus alba*) would also succeed. Willows would grow well, and the weeping kind planted towards the margin of the clump would have a pleasing appearance. The Hemlock Spruce (*Abies canadensis*) would probably flourish. For undergrowth the Alder would grow quickly, perhaps too luxuriantly, while Mahonias, Japanese Privet, Snowberries, and Tamarisk would, we think, make satisfactory progress.

Disbudding Vines (*H. Stone*).—Assuming the rods are about 3 feet apart, and the Vines moderately vigorous, the fruit-bearing laterals should be from 15 to 18 inches distant from each other on each side of the rods; but the removal of the superfluous growth should be gradual, and the final thinning should not be done until you are certain that those intended to remain are quite secure, as if one of them should be broken a blank would be made that would be difficult to fill. Are you sure a palmette stove would answer your purpose? If you have quite satisfied yourself on that point we will endeavour to aid you, but we may remind you that no method of heating is equal to boiler and pipes.

Amaryllis Culture (*Constant Subscriber*).—You will find notes on the cultivation of these plants on another page, which we presume will meet your requirements. If they do not, and you will state more precisely the state of your plants, with the means at your disposal for growing them, we will readily give you additional information. We have many times stated, and we are surprised you have not observed it, that it is impossible for us to recommend dealers. You can obtain what you require from any florists who advertise in our columns.

Fuchsias for Window (*H. J. G.*).—At the present time and onwards until the sun becomes powerful, the plants will succeed with otherwise good treatment in a window facing the south; but in the summer such a position would be too hot and dry for them. A window facing east, or indeed any aspect instead of south, would be better for them after the middle of May. If they must remain in the south window slight shade will be requisite after that time when the weather is bright. If you sow your Gladioli seed in very fine soil in early May, cover with a handlight, and afford shade to keep the soil moist until the seedlings appear, you ought to succeed in your object.

Grafting Vines (*A South Wales Amateur and D. L., Bradford*).—You will find in another column a method described by Mr. Barron as the "simplest and best;" he also describes a method of bottle-grafting "excellent and certain." For particulars of a remarkable example of successful practice see No. 617 of the *Journal of Horticulture*, the issue of January 23rd, 1873. A few copies of this are still in print, and can be had for 3½d. each, post free from this office. Both the modes we have found good, and you cannot err by trying them too.

Cleaning Stone Pillars (*E. Y.*).—You will find nothing better than muriatic acid for cleaning your stone pillars. The acid should be diluted with water, but if the green has become thoroughly established on the stone you had better use the acid almost pure at first, which will destroy the whole of the green, and the pillars in a few minutes can be washed white. If the pillars are not very badly affected equal parts of the acid and water will clean them thoroughly; but this entirely depends upon the stone, whether of a hard or soft material. If hard the acid must be used stronger than is necessary when the stone is of a soft nature. The diluted acid can be applied with an oil scrubbing brush, but care must be taken that it does not get upon your clothes, or it will burn and destroy them. Chloride of lime mixed with water will also clean stone, but when it is of a hard nature it is not so effectual, besides leaving an unpleasant smell for days afterwards, which is not the case with muriatic acid.

Crops for Shaded Position (*J. S.*).—There are few, if any, vegetables that could be profitably grown in the border you describe, especially as, we presume, it is not only shaded with trees, but the ground is permeated by their roots. Jerusalem Artichokes would probably do as well as anything, and such tubers as are not required for culinary purposes will be readily eaten by poultry. Onions for pickling might also, perhaps, be grown, but it is almost impossible to say without knowing more particulars about the extent of shade and the nature of the soil. If the ground is not too poor and dry Black Currants or Raspberries would probably answer better than vegetables. We have seen good crops of those fruits, and also Gooseberries, grown under orchard trees, but everything depends on the fertility of the soil.

Culture of the Dove Plant—*Peristeria elata* (*Idem*).—This Orchid requires a temperature of 65° to 75° during the growing season, and the heat should never fall below 60° as a minimum. Supply water liberally as the growth advances, an occasional application of weak liquid manure being beneficial. After growth is completed withhold water and give the plants a thorough season of rest. Perhaps the cause of your non-success is that the soil is unsuitable, a compost of fibrous turf, leaf soil, and well-decayed manure being the best for it, well draining the pots and elevating the plants. It is not necessary to remove the offsets unless you wish to increase the plant, and with due attention to the above hints you ought to succeed in flowering it, though it does not bloom

so freely as many other Orchids. An excellent article upon the culture of this plant appeared in this Journal, page 297, April 15th, 1880.

Planting Vines (J. J.).—Five rods will suffice for covering the roof, but you may have six if you choose, two to be 15 inches from the glass at the ends of the house, the others equidistant between them, which would be about 2 feet 6 inches apart. We have seen very fine Grapes grown with the rods even closer than that, but care was exercised in dishudding and thinning the laterals. We presume you only want the Grapes for table use, not for exhibiting. Planting should be done after the growth has started. The method of planting has been frequently described. Shake them out of the pots, spreading out the roots quite straight, covering them 4 or 5 inches deep in free gritty loam, and apply water at a temperature of 100°, afterwards maintaining a genial atmosphere and a night temperature of 55°. You can either plant three Vines or six as you choose, but they ought to have been procured and cut back to the height required long ago, as has been advised repeatedly in our columns. To prune them now hieeding would probably ensue; you had better, therefore, simply rub off the buds from the upper portion of the canes, and cut off the cane so denuded of buds in the autumn. The lower the cane is divested of buds the better will the growth be during the summer. If you apply the lime with care as you suggest it will do no harm whatever. For your horder, will not a line of *Lobelia pumila compacta* suit you? If you want something dwarfer sow *Ionopsidium acaule* towards the end of the present month or early in March.

Uncovering Vine Borders (Norwich).—As you appear to be cognisant that the practice of covering may be beneficial or the reverse, it is a little surprising you did not state the condition of your Vines and the nature of the materials, whether fermented or not, placed on the horder. We can only say generally what we have said before, that when fermenting material has been on a Vine border for some months its removal must be effected with great care, and should not be done until the weather is warm and settled. It is often injudicious to remove the whole of the covering, as the roots may have penetrated it, and if not they are, or ought to be, quite close to the surface, and consequently especially liable to be injured by hail or drought. A layer of the manure surfaced with turfy loam, wood ashes, and bones would afford not only protection to the roots, but sustenance of great value for the Vines. We have known instances when the injudicious removal of the covering material has resulted in Vines being in a worse condition than they would have been if the borders had not been covered at all. Placing fermenting materials on Vine borders is often advantageous, but it must not be placed on too soon, nor removed too soon, as there is assuredly danger in both these extremes. If the covering has not fermented, and the Vines are not in a forward state, remove it as you suggest, and then as the summer advances give a dressing of manure if the Vines need additional support, and for keeping the roots near the surface. They will certainly dive down into the horder if the surface is loose and dry.

Hot-water Circulation (H. Cox).—The water will no doubt circulate but its movements will be slow. Instead of the cistern the ends of the pipes should be connected with a simple elbow or syphon, and for supplying the boiler a small cistern should be placed above it on a level with the highest part of the pipes, an inch pipe from the cistern entering the return 4-inch hot-water pipe close to the boiler. An air pipe should be fixed on the top of the flow-pipe at the part you have shown entering the cistern, on the highest point of the pipes in the house. If you require the cistern for supplying warm water, connect the pipes in it by a syphon as suggested.

Cut Flowers in Covent Garden Market (Inquirer).—Large numbers of the cheaper flowers seen in Covent Garden Market and about the London streets at this time of year, are sent there from France. You may frequently see sales of these, comprising Violets, Roses, Hyacinths, Snowdrops, and other flowers, which realise very moderate prices, and are largely purchased by hawkers and others. The flowers arrive in shallow boxes or baskets, no packing material being used, and the moisture of the foliage appears sufficient to preserve them in good condition, for they are often as fresh as if they had only been gathered a few hours.

Names of Fruits (J.).—The Pear is Knight's Monarch undoubtedly. It is not easy always to name fruit from single specimens. To make sure of increasing this variety you might take grafts from your tree and insert them in another tree now.

Names of Plants (J., Cheshire).—*Sisyrinchium grandiflorum*. (Subscriber).—1, *Ilex Aquifolium*, var. *laurifolium*; 2, *Thuja Lohli*; 3, *Cupressus Lawsoniana*; 4, *Abies nigra*; 5, *Abies excelsa*; 6, *Abies canadensis*.

COVENT GARDEN MARKET.—FEBRUARY 28TH.

THERE is no alteration in the character of business, and prices remain substantially the same as last week. Trade quiet.

FRUIT.

	s.	d.	s.	d.		s.	d.	s.	d.		
Apples.....	½ sieve	2	0	7	0	Grapes	lb.	2	0	to 6	0
"	per barrel	20	0	40	0	Lemons	case	10	0	20	0
Apricots.....	doz.	0	0	0	0	Melons	each	0	0	0	0
Cherries.....	½ sieve	0	0	0	0	Nectarines..	dozen	0	0	0	0
Chestnuts.....	bushel	10	0	12	0	Oranges	100	6	0	10	0
Currants, Black..	½ sieve	0	0	0	0	Peaches	dozen	0	0	0	0
" Red.....	½ sieve	0	0	0	0	Pears, kitchen ..	dozen	1	0	2	0
Figs.....	dozen	0	0	0	0	dessert	dozen	1	0	2	0
Filberts.....	lb.	0	0	0	0	Pine Apples, English	lb.	1	6	2	0
Cobs.....	100 lb.	0	0	0	0	Raspberries	lb.	0	0	0	0
Gooseberries	½ sieve	0	0	0	0	Strawberries	oz.	1	6	2	0

VEGETABLES.

	s.	d.	s.	d.		s.	d.	s.	d.		
Artichokes.....	dozen	2	0	4	0	Lettuces	score	1	0	to 1	6
Asparagus, French	bundle	25	0	30	0	Mushrooms	punnet	1	0	1	6
Beans, Kidney	100	2	0	0	0	Mustard & Cress ..	punnet	0	2	0	3
Beet, Red.....	dozen	1	0	2	0	Onions	bushel	2	3	2	3
Broccoli.....	bundle	0	9	1	6	Parsley.....	doz. bunches	3	0	4	0
Brussels Sprouts..	½ sieve	1	6	2	0	Parsnips	dozen	1	0	2	0
Cabbage	dozen	0	6	1	0	Peas	quart	0	0	6	0
Capsicums.....	100	1	6	2	0	Potatoes	cwt.	6	0	7	6
Carrots	bunch	0	4	0	0	Kidney.....	cwt.	6	0	8	0
Cauliflowers	dozen	2	0	3	0	Radishes....	doz. bunches	1	0	0	0
Celery	bundle	1	6	2	0	Rhubarb	bundle	0	4	0	0
Coleworts.....	doz. bunches	2	0	4	0	Salsafy.....	bundle	1	0	0	0
Cucumbers.....	each	0	9	1	3	Scorzoneria	bundle	1	6	0	8
Endive.....	dozen	1	0	2	0	Seakale	basket	1	0	2	0
Fennel	bunch	0	3	0	0	Shallots	lb.	0	3	0	0
Garlic	lb.	0	6	0	0	Spinach	bushel	3	0	0	0
Herbs	bunch	0	2	0	0	Tomatoes	lb.	1	6	2	0
Leeks.....	bunch	0	3	0	4	Turnips	bunch	0	2	0	3



POULTRY AND PIGEON CHRONICLE.

INDICATIONS OF FERTILITY OR BARRENNESS OF SOILS.

(Continued from page 166.)

ALL clay soils, as a rule, unmixed, are too tenacious to be fertile; all unmixed silicious soils are too loose and hollow to be fertile; and all unmixed chalk soil—that is, a soil of carbonate of lime only, is too pure to be fertile. Many persons, without due consideration, may suppose from these simple observations that a mixture also of the three before-named soils would not be fertile; yet a mixture of certain proportions of these kinds of soils before named constitutes the medium by which the fertilising properties contained in them are rendered active. The mixture for all practical purposes becomes a new soil, possessing new powers of absorbing and utilising moisture, and all which is requisite is to apply a quantity of both animal and vegetable matter in a decomposed condition, and in the future to carefully return as much of fertilising matter as are removed in the growth of our crops. Fertile land usually shows that its consistency is of a medium nature between sand and clay, or between chalk and alluvium, with sufficient adhesiveness to retain moisture, and sufficiently porous to allow such moisture when excessive to pass freely away into the subsoil.

In viewing cultivated districts the appearance of the surface may be deceptive and often deemed barren, especially in the case of useful and productive land when too wet, therefore no man can fully estimate the actual capabilities until draining has been effectually carried out. General bad management, not only as regards the deficiency of manure, its foulness with couch, but also the tillage of the land conducted during unseasonable weather and imperfect tillage in various respects, are damaging factors in estimating the value of the soil for rental or purchase. We have often seen lands really fertile, which, when badly managed, have baked on the surface like cement, and the crops in consequence by no means representing the natural power of the soil.

All mere surface appearances are liable to fluctuation from sundry causes, such as temperature, drought, too great a rainfall, lack of manure, and cultivation; they scarcely ever remain the same for a few weeks together. On the contrary, if a man takes into consideration the description of the herbage, knows what it is when he sees it, and can name it, and at the same time knows from experience that it indicates a productive soil under unfavourable circumstances, or *vice versa*, he can with greater confidence rely on the opinion he finally forms, and which may be accepted as the nearest approach to a certainty. We always make it a practice when inspecting land for the purposes of valuation to make remarks respecting the herbage, the plants, weeds, and grasses, where they have elected to grow spontaneously, as the best indications usually at hand to represent either barrenness or fertility under ordinary circumstances in the case of pasture or meadow land. As we have now reached a point in our subject when the knowledge of botany steps in to guide us to a certain extent; and although we have before us the means of laying before our readers the botanical names as well as the commonly accepted names by cultivators of the soil as given by John Bravender, Esq., F.G.S., land surveyor, of Cirencester, in his prize essay, published in the Royal Agricultural Society's Journal in 1845, we must refer them to this capitally illustrated list of names

of plants, herbs, wild flowers, &c., and natural grasses, which are indications of barrenness where they have grown spontaneously, and where the grasses have usurped the greater portion of the surface of pasture lands. The list of these contains over seventy, and they cannot be given in these columns; we must, therefore, refer our readers to the essay. There is still another list of some of the weeds on arable land which are troublesome to the cultivator, and frequently occupy so much of the surface as to render the produce of the farmers' crops of but little value. The list of these contains forty-four varieties, amongst which we find the following names as some of the most damaging and mischievous on our cultivated land:—The Cockle, Corn Bindweed, Corn Poppy or Redweed, Coltsfoot, Corn Marigold, Corn Mint, Charlock or Wild Mustard, Broad and Narrow-leaved Docks, Surface Twitch, and Common Ragwort, with many others. These are, with few exceptions, found on all kinds of soils, and the only indication worthy of notice being the difference in the habit of growth, for they will appear more luxuriantly on fertile than on barren soils. They are introduced here as temporary indications of not only barrenness, but of neglect in cultivation, with the view of encouraging the home farmer in a continual warfare with them, until he finally extirpates them from his soil altogether.

The next quotation we have to make is the names of plants, herbs, flowers, &c., and of natural grasses, which are indications of fertility where they are indigenous to the soil. These are but few, not more than twenty in number, but consisting of such as Milky Thistle and Cow Parsley. But again we have a long list of natural grasses as indications of fertility by reason of their electing to grow on all the richest, best, and most fertile pastures in England, and by their dominating all others on the surface. These are about twenty in number, some of which may be enumerated, such as the Sweet-scented Vernal Grass, Meadow Foxtail, Cocks-foot Grass, Perennial Red Clover, Creeping Vetch, and White or Dutch Clover, these latter being found in the best of all the grazing lands in the various counties, the last-named in particular being quite indispensable as a component of every valuable pasture, but is frequently lost or destroyed through the close grazing of sheep instead of cattle.

Space forbids our making more lengthened quotations under these headings. We cannot, however, refuse to refer to the most important, as well as the most easily recognised indications of soil, and give a list of a few of our timber trees, with the kinds of soils whereon they flourish most, and in consequence their appearance, presence, and condition may readily be accepted as decided indications of fertility or barrenness. The Oak we find chiefly on deep, strong, fertile land, with clay subsoil. The Elm likes deep, rich, dry loam, and grows with special luxuriance near to farmyards, where liquid manure reaches their roots, and the trees are valued for the shelter they furnish. The Beech grows best on the elevated calcareous soils in woods and hedgerows. The Ash is found on the light soils inclined to be sandy, but flourishes most on a fertile soil. The following indicate boggy or inferior soils: the Alder, the Willow, and the Birch, the last-named is found to flourish as well as the Larch and Pines on the light sandy and rocky soils. Those who enter or travel through districts previously unknown to them will find in recognising the trees enumerated an unerring guide as to the value of land agriculturally in an off-hand way, although they may be travelling by the fastest railway train. If, therefore, we only get a bird's-eye view of a district, it serves to give us a good general idea of the character of the soils. Again, even in looking over property as a matter of valuation or for business purposes generally, the first objects should be the trees, as a short and ready way of estimating the general character of soils. In conclusion, we wish to observe that our subject is almost without limit if we sought to follow out and give in detail explanations of the various points raised in our review of the subject, but lengthy details are not and cannot be adapted to the limited space at command in these columns, besides which other subjects of vast importance in practical agriculture demand our attention.

WORK ON THE HOME FARM.

Horse Labour.—We cannot recollect a season in which so much time has been lost up to the present time in respect of horse labour on the farm, including the early seeding period. If the weather proves favourable Oats may now be sown, especially of the Black Tartarian variety, for they are much more hardy than the White varieties. The seeding of Beans on the strong lands as well as Peas should now be done, the sooner the better, if the land can be made to work freely; to our mind there is no better way than to plough, press and drill under one operation, for not only is the seed sure to be buried with little horse labour, but when the weather proves changeable there need be no delay in finishing off the land. We do not like the ordinary drill nearly so well for pulse seeding, as the seed is not

always buried sufficiently deep. White Oats such as the Victoria, Poland, or Canadian, in fact all the early sorts, may be sown about the middle of the month, for they require the land to be kinder and lighter than the other sorts. The White Waterloo sort are a first-rate sort to sow as drege, for when mixed with about one-fourth of Barley, the Barley is sure to be a good malting sample, whereas if the land is sown with Barley alone, and especially after roots fed off, it is nearly impossible to obtain an evenly gown sample of best quality. We prefer the Waterloos for the mixture with Barley, because they are thin in the sample and will more easily pass through the screen, especially if properly hummelled, than any other sort, leaving the Barley for sale to the malster. Boby's screen does the work of separation very well, but there are screens by several parties—Barford, Perkins, and others, which will do the separating very expeditiously, but it requires care and should only be entrusted to workmen who have been used to the work. It has frequently been asked why the Barley should yield a plumper and fuller grain when grown with Oats than when grown alone. We think it is in consequence of there being two sorts of grain, each rooting in the land in a different way, and not interfering with each other during growth, more especially as the Barley comes into ear before the Oats; but no doubt the Barley having more room than when it is sown alone makes some difference, for it is found, if drilled at 12 inches apart with only two and a half bushels of seed per acre, that the sample will prove stouter and more regular in berry than when drilled close with the usual quantity of seed. When Barley is grown after Wheat of the previous year, it will often require a little manure which should be applied by the drill or otherwise sown just behind it, so that the manure should fall into the coulter grooves with the Barley; about 1 cwt. of nitrate of soda mixed with 2 cwt. of mineral superphosphate will be the best quantity of manure either for Oats, Barley, or drege.

Hand Labour.—This has also been much delayed, still we have been able to fork out lumps of couch from the land intended for Lent corn where there was but little. Anything requiring horse labour must wait until the weather is dry enough to use the Howard's self-lifting drag and comb out the couch before the ploughing, seeding, and drilling takes place; in fact, if a little couch should show up where the Oats are up, this may be forked out without injury to the corn, and where there is but little hand labour is more effectual, and is done at the least cost compared with horse or steam power. Hedge-trimming has been completed lately during wet weather.

Live Stock.—We find many farmers on the vale farms who buy all their sheep in the autumn agree with us, that instead of selling their lambs at light weights it will be better to hold them on and sell them as tegs after being shorn at such weights as are required most by the butchers. Again, why should the ewes be sold fat and fed at an enormous cost for food and expenditure in other ways, when if held over they will prove more valuable at Michaelmas next than anything which can be purchased? There can be but little doubt of the breeders of sheep on the hill districts of the various counties obtaining the most advantage at present prices. The foot-and-mouth disease is unfortunately spreading fast in many counties, and the farmers must continue to suffer serious losses until the importation of live animals for the butcher are entirely prohibited. The consumers would then derive their supply of meat entirely in the same way, as much is now imported from America as quarters of beef and carcasses of mutton; in this way only can this and other diseases be kept out of the country.

FORMATION OF PERMANENT PASTURES.

IN the form of a supplement to their "Farmer's Year-Book and Grazier's Manual," Messrs. Sutton & Sons of Reading have published what they term "A few Practical Remarks on the Formation of Permanent Pastures," which are worthy of the attention of those who are interested in the subject. In addition to much interesting matter, especially on Rye Grass, those who contemplate laying down land to permanent pasture are reminded of some of the more important considerations which need to be observed, namely, "What are the characteristics of the soil, physically, chemically, and with regard to situation? Is the surface soil stony, brashy, clayey, marly, loamy, sandy, moist or dry, drained or undrained? Is the subsoil porous or a retentive clay, sand, chalk, or gravel? What does an analysis show the soil to be deficient in, or to have an excess of, as regards its chemical constituents? Is it near the sea or far inland? at the top of a hill or down in a valley? in the dry eastern counties or in the west of England, Ireland, or Scotland? The proper choice of seed depends upon all these considerations.

"Again, what is the object in view? Is it wished to have a fine close turf like that which brings to perfection the Southdown sheep? Or is a firm turf no requirement, and the desideratum a coarse rank herbage, such as that in the Fens, which will keep the greatest head of stock? Is it desired to lay away to grass land which is foul with couch, thoroughly out of heart and condition, and which will no longer grow corn profitably? Or is the field in first-rate order, full of heart, and fit to grow anything? Is it intended generally to mow, or generally to graze? Is the

grass to be fed by sheep, or by bullocks, or by horses, or by all three? Is it for a special purpose, or for general purposes?

"The finer Fescues, which form the turf of the Sussex Downs, would be wasted if largely used to form pastures for fattening bullocks. A large proportion of Cocksfoot, so valuable for these latter, would in turn be the ruin of pastures to be mown for hay which is intended for use in hunting and military stables. The strong-growing vigorous Grasses necessary to overcome couch, and thrive on poor hungry land, would be thrown away and be taking up the place of more valuable varieties if sown on good land, clean and in high condition.

"If a pasture is generally to be mown for hay, then varieties of Grasses should be chosen which come to their greatest perfection at the haymaking season. If, on the other hand, the field is to be generally grazed, a selection should be made which will insure a continuation of feed throughout the whole year. Pastures for sheep should be formed of finer close-growing varieties than those to be fed by cattle, and bullock pastures may contain many varieties which it would be useless to sow on a trainer's paddock."

POULTRY AND PIGEONS

A NEW POULTRY PAPER.

WE had intended this week to present the readers of the *Journal of Horticulture* with a large supplement devoted to Poultry, Pigeons, Cage Birds, and Rabbits. In preparing for this work such a hearty response was made by our friends, that it was ultimately determined to issue this supplement also as a distinct publication at a very low price. At the last moment we find the postal arrangements preclude our enclosing the new paper in the Journal; but we will readily send a copy, post free, to anyone sending their address. The new paper, "POULTRY," will be published every Friday, price One Penny, and may be had from newsvendors, at the railway bookstalls, or direct from this office.

ENGLISH AND FRENCH POULTRY KEEPERS.

THERE are in France hardly any large egg-producing establishments. The greater proportion, if not the whole, of the eggs imported into this country are the produce of a large number of raisers, collected from week to week by a middleman, who receives a small commission from central houses, who export to this country the result of the different collections. The districts in France from which large numbers of eggs are collected and exported to England are Normandy, Picardy, Artois, and Brittany. In each of these districts a different system of production and of collection is in force; but in all the districts the same attention to egg-producing is paid by the farmer or cottager, the same care is taken to obtain the largest quantity of eggs at the smallest cost, and the result is attained—viz., a profitable poultry-yard, be it large or small. In Normandy and part of Brittany, where small holdings of a few acres are to be found in great numbers, the small farmers and cottagers are every one of them raisers of poultry, and derive a fair profit from their yard. Near every small farmyard, or adjoining it, is a small enclosed orchard, to which the poultry have access, the roosting-place being generally close to a cow-shed, or to the stables, for the sake of warmth in winter. The fowls are fed twice a day, close to their roosting-place, so that they may always be induced to come back to lay there, although a careful search is always made in out-of-the-way corners.

In every village in Normandy, and in the southern part of Picardy bordering the former, every man has a poultry-yard, large or small, according to his means or in proportion to his plot of land, and the great reason of the success of these people is to be found in the fact that they work for themselves and neglect nothing to obtain a satisfactory result. The farmers and graziers of Normandy, while paying due attention to their cattle and horses, and farming their land to the best of their ability, do not neglect their poultry-yard, as they well know that with proper care and attention it is as profitable a branch of farming as any, that under their supervision, and without any extra labour, their cowman or the dairymaid can attend to the poultry department, and that they are ultimately well repaid for their outlay of food by the price of the eggs sold. Their fowls, however, are fed with regularity, with neither too much nor too little,

and are not, as in the English farmyard, left to pick up their food as best they can.

The great contrast between this state of things and that existing in England deserves to engage the attention of the British farmer. Advanced agriculturists have long ago seen the necessity for the British farmer to consider his poultry-yard as a part of his farming business that can and ought to be made a paying one. The late Mr. Mechi pointed out one of the causes, perhaps the chief, of the failure of poultry-farming in this country. "Farmers will not," he said, "systematically feed their fowls, and, instead of careful superintendence, just leave them to themselves, like gutter children." He very pertinently added: "A farmer will readily turn a large flock of sheep to trample on, drag down, and devour a fine field of clover or grass, but he would be annoyed to see half an acre eaten by his wife's poultry. He will give his pigs barley and beans by the sack, but objects to the poultry helping themselves to kernels. A farmer never grudges barley by the load for his pigs, and cake and corn for his other stock: why should he regret feeding his poultry? In some cases that I know of one of the farm hands receives a pint of beer when the governor is at market, to carry in a sack of barley on the sly for the poultry, so as not to shock the farmer's excessive and unreasonable prejudices." Mr. Mechi went on to show that properly managed poultry cost less to produce, weight for weight, than beef or mutton, while selling for considerably more, but, he added, "a poultry-breeder must understand the business as much as the breeder of other farm creatures."

We have here the whole matter in a nutshell. In France large or small farmers and cottagers understand the business, take an interest in it, work for themselves, and neglect nothing to obtain a satisfactory result. In England the farmers' wives even hardly ever do this, while their husbands look upon the poultry-yard with contempt. Were the breeding and feeding of cattle, sheep, and pigs left to chance, and without the supervision and direction of the master, were half the milk lost or stolen, were the lambs left to themselves to seek for the roots that are not given to them, or the calves left to graze on the scantiest of herbage, neither of them would pay. Is it, then, surprising that poultry, being left to breed indiscriminately, being fed in the way we have mentioned, and the hens being allowed to lay away where one-third of the eggs are lost and another third stolen, are found not to pay; and, being so found, have all kind of food begrudged to them, while simply as scavengers and worm and slug destroyers they are such useful friends to the farmer? We again quote Mr. Mechi's words *à l'appui*:—"It is a well-admitted fact by all my labourers that my best and thickest crops are in immediate proximity to the fowl-house, commencing at only ten yards' distance. No doubt there are times when you ought to protect your shallow-sown seeds, and, in my case, I sometimes employ a boy for a fortnight immediately after drilling close to the fowl-house; but, even if I have not done so, I have rarely been inconvenienced if the grain was properly deposited by the drill. There is no surer sign of imperfect tillage than when you hear of birds or game getting out the seed." Poultry graze equally as do sheep or cattle, and it is essential that a piece of pasture should be near the fowl-house, otherwise they will naturally appropriate young Cabbage, Turnip, or Mangold plants.—(*The British Trade Journal.*)

METEOROLOGICAL OBSERVATIONS.

CAMDEN SQUARE, LONDON.

Lat. 51° 32' 40" N.; Long. 0° 8' 0" W.; Altitude, 111 feet.

DATE.	9 A.M.				IN THE DAY.				Rain.	
	Barometer at 32 nd and Sea Level	Hygrometer.		Direction of Wind.	Temp. of Soil at 1 foot.	Shade Temperature.		Radiation Temperature.		
		Dry.	Wet.			Max.	Min.	In sun.		On grass.
1883.	Inches.	deg.	deg.		deg.	deg.	deg.	deg.	In.	
February.										
Sun. 18	29.977	41.0	40.2	S.E.	40.2	46.8	38.8	73.4	36.6	0.053
Mon. 19	30.113	35.7	34.7	N.N.W.	39.8	42.9	31.7	52.0	27.9	—
Tues. 20	30.283	41.0	39.8	S.W.	39.7	48.2	34.8	51.9	30.5	0.074
Wed. 21	30.460	46.8	45.7	W.	41.0	53.3	34.8	61.4	39.3	—
Thurs. 22	30.417	50.5	49.3	W.	42.8	55.4	46.3	76.1	43.6	—
Friday 23	30.854	39.0	37.0	N.	42.8	51.8	33.3	87.0	29.3	—
Satur. 24	30.708	38.4	38.0	W.	41.3	52.5	33.2	79.6	28.8	—
	30.402	41.8	40.7		41.1	50.1	36.1	68.8	33.7	0.132

REMARKS.

18th.—Rain at first; afterwards fine.
19th.—Fine throughout; moonlight night.
20th.—Dull, with cold rain.
21st.—Rather dull, but fair throughout.
22nd.—Fine spring-like day; bright moonlight night.
23rd.—Fine and bright sunshine.
24th.—Fine.

A fine week, temperature still considerably above the average, and during the latter part of the week very high barometric pressure. Very little rain.—G. J. SYMONS.



8th	TH	Royal Society at 4.30 P.M.
9th	F	
10th	S	
11th	SUN	5TH SUNDAY IN LENT.
12th	M	
13th	TU	Royal Horticultural Society, Fruit and Floral Committees at
14th	W	Society of Arts at 8 P.M. [11 A.M.]

LIFTING VINES IN MARCH.

WHEN old Vines are unsatisfactory we are frequently advised to clear them out and plant young ones. This was said to me in relation to a house of old Vines exhausted from overcropping and a saturated border; in fact the roots were in a very bad condition. I did not clear them out, however, and preferred for several reasons to improve them if possible instead of planting young Vines, and well have they repaid the time and labour necessary for carrying out the operation. They have improved each year since they were lifted, now five years ago, and it is questionable if young Vines would have produced finer fruit, and I certainly should not have obtained from them half the weight of Grapes the renovated Vines have produced.

It was towards the end of February when I decided to lift them, and I had then to consider the best time for doing the work. I wanted a crop of Grapes from these Vines if possible, and this made me hesitate at first to lift them in the spring; yet I did not like the idea of waiting until autumn and thus lose a season; besides the crop, anticipating they would produce one, would have to hang upon them for weeks, or even months, after the usual time for lifting in autumn. It was early in March before suitable soil could be found, and the work was commenced by clearing out about 4 yards of the old border from one end of the house, the border being inside. The new border, about 2½ yards wide, was made and the roots laid into it before the remainder of the old border was disturbed. Another portion was then removed and replaced as before, and so on until the whole was completed. The strong fibreless roots were remarkable for their black unhealthy appearance. These were shortened considerably, yet every healthy fibre possible was preserved. The Vines had many dead roots, especially near the bottom of the border, and the principal fibry roots they possessed were near the front and had evidently started from the collar one or two years previously. The soil the new border was composed of was fully too moist, and the Vines in consequence had no water for a long time after lifting.

They were allowed to start into growth naturally, and it was thought best not to apply fire heat until the roots had commenced advancing. The Vines started fairly well, and the house was closed early in the day while the sun was upon it and with a moist atmosphere. The time between the lengthening-out of the shoots and the action of the roots is not long in the case of

healthy Vines, but these in question did not advance for two or three weeks; they flagged in spite of syringing when the sun shone upon the house, and the small leaves nearest the stems turned yellow and fell off. Anxiously I watched the Vines day by day going back, and even made preparation for raising young Vines by pegging one or two small Vines I possessed of suitable varieties into the turf of the border, as I concluded the few bunches—fifty to sixty in all—would, like the small leaves, eventually turn yellow and fall. At last I hopefully discovered the deeper shade of green making its appearance near the footstalk of the leaf; flagging became less frequent, and in a very short time lateral growths made signs of pushing—all satisfactory indications that the roots had commenced to do their duty. These lateral growths were encouraged until they filled the entire roof, crowding being avoided. At the base they were encouraged until the border was almost covered and the top resembled a thicket. What about the bunches? some may ask. A few turned yellow and fell, but fifty finished well and were conspicuous for their large berries. These Vines are by no means handsome when pruned, for we have never studied the orthodox system of spur-pruning with them, and they have yearly improved in the number and size of the bunches and quality of the fruit.

The general desire, of young gardeners especially, is to root out old, or what we may term old, Vines if they are not quite satisfactory, and plant young ones, as from them something gigantic is anticipated. The first thing, then, to be considered is the requirements of the family a gardener serves. In many instances giant bunches, however startling they may be, are not so serviceable as those of a moderate size. When large a Vine cannot carry so many bunches, and in consequence Grapes for dessert fail long before they would if the Vines bore a greater number of smaller bunches. My advice, then, is, where the production of large bunches is not the primary object do not be in a hurry to destroy old Vines. These in many cases when properly renovated are capable of yielding after one year a full crop of Grapes. If the fruit for one year on exhausted Vines could be sacrificed they have a much better chance of recruiting themselves, and would in all probability go on with judicious treatment and moderate cropping for an indefinite period.

Some contend the best time to lift Vines is just before the foliage falls. It may be; but rather than disturb them with a crop of Grapes hanging I would prefer doing the work in spring some time before the roots commence growing. If the roots are entirely outside and there is no means of protecting the new border from heavy rains, especially in wet low-lying localities, the spring is decidedly preferable to late autumn for lifting. I do not condemn autumn lifting if it can be done while the foliage is fresh, the crop cleared from the Vines, and the border either inside or well protected outside, for they would make roots in autumn before the foliage faded, which would assist them materially the following spring when starting into growth. It is not always a question of doing this kind of work at the season regarded as the best, for such operations have frequently to be done when circumstances will allow, and the cultivator can procure fresh soil and find a favourable opportunity.

Where practicable it is a good plan to clear out a

good portion of the exhausted soil at the front of the border, add fresh compost, and then peg down the Vines, in which they will produce a good quantity of healthy roots. These need not be disturbed when the lifting of the remaining roots is done, and will assist wonderfully in sustaining the Vines after the lifting has been completed. Where the renovation of old Vines is contemplated and the entire border cannot be renewed for a season or two, the plan of pegging down the Vines as suggested is worthy of consideration. It may be carried out now, and in all probability will well repay for the time and trouble devoted to the work.

Whatever may be urged against the extension of lateral growths in Vine culture, it will be found that a liberal growth of the laterals is one of the best systems that can be practised with newly lifted Vines, or of Vines pegged down prior to lifting as described. Without a good development of foliage it is impossible to obtain abundance of roots, which are of vital importance in recruiting the energies and restoring the lost vigour of exhausted Vines. It is not difficult to achieve successful results in renovating old Vines if only the work is carried out with care and the after treatment conducted judiciously and intelligently.—W. BARDNEY.

GARDENERS AS SERVANTS.

SOME correspondence which has appeared in the morning papers since we last wrote upon this subject a fortnight back seems to indicate that the revenue authorities are endeavouring to exact the uttermost farthing in the matter of taxing male servants.

The question is by no means a new one. As far back as 1854 and 1855 it was debated whether the terms of the Act then in force (16 and 17 Vic., cap. 90) included labourers occasionally employed as gardeners in the tax imposed on gardeners or under gardeners.

Several decisions bearing upon the point will be found in vol. xv. of the *Cottage Gardener*, page 387. The Commissioners of Land and Assessed Taxes and the Judges differed as to the construction of the Act above mentioned.

On the 3rd of March, 1856, the Chancellor of the Exchequer, in reply to a question put by Col. Harcourt, stated that "he understood that the construction which had been adopted by the revenue department was this, that persons who were regularly employed for a whole year, and who were under the direction of a head gardener, should be regarded as under gardeners; but that persons who were only casually employed, and who were engaged in such duties as might be performed by common labourers—as, for instance, in mowing grass or in keeping gravel walks in order, were not to be deemed under gardeners."—(*Times*, March 4th, 1856).

This construction would seem to have been the reasonable one upon the wording of the old Acts, and it is in accord with our opinion expressed in our issue of 22nd Feb., page 160, as to the true construction of the new Acts, the first of which (the Customs and Inland Revenue Act, 1869) in fact repealed the old Act as to gardeners, and brought them within the general definition of persons taxable as male servants.

The more we consider the matter the more we are surprised that such a decision as that arrived at by Mr. Cooke on Capt. Patton's case should have been given. If that decision be correct, anyone employing a person even for a day to assist in a garden is liable to have proceedings instituted against him for not having procured a license.

This is absurd upon the face of it. Having suburban gardens put into order occasionally would become an expensive operation if, in addition to the wages paid for the man employed, it were necessary to procure a 15s. license before the two or three days' work could be legitimately undertaken. This can never have been intended, and if Mr. Cooke's de-

cision be good law we can only commend the matter to the attention of the legislature, and express an earnest hope that a short Act will be passed as soon as possible, clearly defining the position of employers of labour in this respect.

We trust that a decision of the Court of Appeal to which Capt. Patton's or some similar case will doubtless be taken ere long, will be such as to render any further legislation upon the subject unnecessary.

SINGLE DAHLIAS—RAISING THEM FROM SEED.

SO-CALLED double Dahlias have long been favourites with the florists, and their beauty has added greatly to the attractions of many a horticultural exhibition. It is not, however, my intention to consider the history of these now, as that was fully discussed last year in the *Journal* (page 315, vol. iv.), and I now propose referring to the single forms. Fashion threatens the dethronement of the double forms to some extent in popular favour and to patronise the single Dahlia in their stead. We do not, however, desire to see, neither do we anticipate, a marked decline in the cultivation of the double varieties. Both are worthy the cultivator's care; and if, as we may hazard the prediction, a more extended growth of the single kinds may lead eventually to the production of double flowers with flat imbricated florets, we shall hail their advent with satisfaction.

Until a comparatively recent date single Dahlias were to be found almost exclusively in botanical collections, and their merits as decorative plants easy of cultivation have not been recognised or sufficiently appreciated either by professional gardeners or amateurs. They are now fully to the fore, and amongst those who have taken a more than ordinary interest in their cultivation, and who have been successful in raising new varieties of merit, I may mention the worthy Curators of the Oxford and Chelsea Botanic Gardens. In the former garden most of the oldest kinds have been in cultivation since the date of their introduction, and where numbers of plants we could mention, supposed to have been lost to cultivators, have been found, much to the satisfaction of eminent botanists. The groups of *Dahlia coccinea* that have for many years adorned a series of circular beds in the Oxford garden with their profusion of richly coloured flowers have well illustrated the fitness of this class of plants for more general use, especially where cut flowers are in demand. The kinds that I have noted here, from which large numbers of seedlings have been raised, are *D. Cervantesi*, *D. mexicana*, *D. gracilis*, *D. Merckii*, *D. alba*, *D. scapigera*, and *D. Paragon*, as well as a few others that it is not necessary to mention.

The seedling plants obtained from *D. gracilis* are characterised by the elegant foliage and neat habit of growth of their parent, and can be thus readily distinguished from the offspring of any of the others, but the range of colours produced from this sort so far is only limited. This latter remark also applies to those of *D. Cervantesi* and *D. mexicana*, both of which produce medium-sized flowers, having for the most part broad well-rounded florets. The old and generally admired *D. Paragon*, in addition to being a sportive kind, has established its fame as a prolific parent of purple or maroon-coloured flowers of many beautiful hues. Of *D. scapigera*, an exceedingly pretty and moreover very distinct sort, there are two or three forms, all having small florets of somewhat diaphanous texture, which are slightly cupped, and are of a delicate mauve tint shaded with purplish lilac; the most desirable, as we think, being the one with flowers measuring $1\frac{1}{2}$ inch in diameter, and notable as being of the deepest colour.

D. alba and *D. Merckii* are varieties that should not escape the attention of those who do not already possess them. They both produce pure white flowers, which render them most attractive objects in the flower garden, and their cut blooms are invaluable for table decoration. The former variety appears to have been so far an especial favourite as to have acquired from different growers several other names, while the latter is a comparatively scarce sort. Considerable interest, it will be seen, is centred in these two Dahlias, when we mention that it is from them that Mr. W. H. Baxter has succeeded in raising seedlings that are the parents of many of his most beautiful

varieties. So successful has he been in producing single Dahlias from seed, that it is due to him to place on record the satisfactory results that have attended his efforts. By way of illustration I may mention that in a bed of this year's seedlings a large proportion of the flowers possessed the qualities to be found in the best named varieties both as regards the form of their flowers as well as in their rich diversity of colours.

With a pleasing remembrance of these flowers as I write, and with a prospective view promising the fulfilment of greater expectations, I cannot but urge the opinion that care should be exercised by growers in selecting only such seedlings for naming as are of superlative merit. To those contemplating saving seed of single Dahlias with a view to obtaining varieties of merit, we may observe that the flowers are in a high degree susceptible to chance impregnation through the agency of the wind, as well as by the insects by which they are always more or less infested. It is, therefore, important to state that they should not be planted too close to the double varieties if the cultivator's object be to obtain single flowers.

To those who are not aware how easily this class of plants can be grown we offer the following remarks. To insure their flowering the same year seed should be sown not later than the month of March, for if sown later, unless the season be very favourable, they will yield but few flowers: however, the tubers from those that do not happen to flower the same season may be stored as customary with other kinds, and will amply repay in the following year the little trouble that such a course involves. Choose flower pots or pans of a convenient size, and after placing sufficient crocks in the bottom of each to insure good drainage cover them with a thin layer of moss, and then fill with a compost of sandy loam and thoroughly decayed leaf soil, distribute the seed thinly on an even surface, and slightly cover them with fine soil; they should then be placed in a bottom heat of 60° or 65° Fahr., and when the young plants have become sufficiently strong remove them to a cooler temperature and harden them gradually for planting out, as early in May as practicable.

If sown thinly as here recommended they need not be potted singly, as this practice—no matter how carefully performed—tends to weaken the young plants, from which state it takes time for them to recover. If they receive similar treatment to that generally bestowed on raising half-hardy annuals, such as Ten-week Stocks, Asters, and Phlox Drummondii, they will in most cases fully answer the grower's expectations. It will be necessary to use some care in separating the roots of the seedlings in removing them from the seed pans for planting out, which should be effected if possible in showery weather. If planted in lines or groups a distance of not less than 3 feet should be allowed between the plants, and they ought to be afforded some protection until they are established. There is not much advantage to be gained by the process of disbudding, as this only tends to increase the size of the flowers, which in most cases cannot be considered desirable. In conclusion, the value of single Dahlias planted with a view to producing the most pleasing effects in combination with other popular garden plants is suggested as deserving of consideration.—S. P. E. S.

POTATOES FOR TABLE AND MARKET.

(Continued from page 174.)

In the following notes the figures 1, 2, and 3 indicate first early, second early, and late varieties; the months the time of planting; and the asterisks those varieties that are considered the best for market purposes by the respective cultivators.

GLoucestershire.—1. Middle to end of March for gardens; a week later for exposed situations. *Rivers' Royal Ashleaf and Myatt's Prolific Ashleaf. Soil.—Deep light loam on gravel subsoil. 2. Same as first early. *Early Rose and Beauty of Hebron. 3. Beginning of March for gardens, fortnight later in exposed situations. *Magnum Bonum and Reading Hero. Manures and Application.—In gardens I apply a moderate quantity of farmyard manure in the autumn or a moderate quantity of artificial manure in the spring at the time of planting. In fields I have used ordinary manure, also bone dust in moderation at the time of planting, without any injurious consequences as regards disease, but a large quantity of manure increases the disease very much. General Culture.—It is found by some cultivators that the crop of Potatoes is very much increased by the use of large quantities of manure both ordinary and artificial, and

as the expense of cultivation, rent, &c., continue very much the same there is more margin of profit. There may be no objection to this if the produce is all consumed, but the use of Potatoes grown in this manner for seed cannot be too strongly condemned. They have the mycelium of the fungus largely developed in them, and cannot fail to reproduce it on an extended scale the following year; in fact the Magnum Bonum is the only Potato up to the present time which has not broken down under such treatment. Specially prepared tubers should be grown for seed. The planter should send to a nurseryman for his stock of tubers for planting, or devote a special plot of ground on his farm for raising seed tubers for use the following year.—FREDERICK BRAVENDER, *The Firs, Cirencester*.

1. From the 1st to 20th of March. *Veitch's Improved Ashleaf, Rivers' Royal Ashleaf, and *Myatt's Prolific Ashleaf. Soil.—Light soil and in sheltered situations. 2. Latter end of March or beginning of April. Gloucestershire Kidney and *Rintoul's Early Don. Soil.—Medium. 3. First and second weeks in March. *Magnum Bonum, *Scotch Champion, and *Paterson's Victoria. Soil.—Medium. Manures and Application.—Well-decayed farmyard manure and coal ashes are freely used, the latter especially where the ground is inclined to be heavy; road scrapings and leaf soil are found to be of great service.—WILLIAM NASH, *Badminton Gardens*.

1. February and March. Veitch's Improved Ashleaf. Soil.—Light. 2. March. *Prince Arthur and *Gloucestershire Kidney. Soil.—Light. 3. April. Schoolmaster and *Magnum Bonum. Soil.—Rather heavy, considering it is resting on the old red sandstone formation. Manures and Application.—Leaves, stable dung, and garden refuse, &c., well incorporated together forms the principal manures used here. General Culture.—We never apply manure direct for Potatoes, but rather stimulate about the time of earthing up with dry wood ashes, a little soot, and Peruvian guano mixed together and left in a heap twelve hours before using.—THOMAS SHINGLES, *Tortworth Gardens, Falfield*.

HAMPSHIRE.—1. February. *Rivers' Royal Ashleaf, Myatt's Prolific Kidney, Veitch's Improved Ashleaf, and *Extra Early Vermont. Soil.—The soil is a light stony loam resting on a gravel bottom. 2. March and first week in April. *Schoolmaster, *Paterson's Victoria, Woodstock Kidney, and Covent Garden Perfection. Soil.—These are planted in a soil consisting of loam, leaf soil, and vegetable manure. 3. Third week in February and first week in March. *Magnum Bonum, *Scotch Champion, *Dalmahoy, and Lapstone. Soil.—Medium loam, and consisting principally of peat with sand. Manures and Application.—I apply to the soil in which the first earlies are planted a good quantity of well-decayed leaf soil with a small proportion of soot. The second earlies are planted in a compost of stable manure and guano in small quantities. For the late varieties I add to the soil before planting a good share of farmyard manure. General Culture.—Plant the tubers in rows from 2 to 3 feet apart according to the haulm they make; the Magnum Bonum and other varieties make such a vigorous growth that I allow them 3 feet between in the rows, and the tubers 2 feet apart. They are frequently hoed and kept clear of weeds when growing. As soon as they are fairly up they are earthed. Last season I had very few diseased tubers.—HENRY CHARLES OGLE, *Chilworth Manor Gardens, near Romsey*.

1. Middle of February. *Myatt's Prolific Ashleaf, Suttons' Fillbasket, and *Coldstream. Soil.—Very light sandy loam, trenched deeply and manured with vegetable (leaf) soil every year. 2. Middle of March. Woodstock Kidney, Lapstone, and *Covent Garden Perfection. Soil.—Similar to the last, and trenched every year, but it is manured in alternate years only. 3. First week in April. *Reading Hero, *Magnum Bonum, and *Paterson's Victoria. Soil.—A loam of medium texture, which is trenched every alternate year, and long stable manure worked in. General Culture.—The early and second early kinds are planted in drills 4 inches deep, 2 feet apart, and 15 inches from set to set, and are covered in with the hand; and as soon as the tops are above ground are earthed up in the way Potatoes usually are earthed when about a foot high. This protects them from frost, and no other earthing up is needed. The late kinds are planted with broad-pointed dibbers 4 inches deep, and are earthed when the tops are about 9 inches high.—W. WILDSMITH, *The Gardens, Heckfield Place, Winchfield*.

1. As soon after March 1st as the ground is found in good condition. *Early Hammersmith, *Myatt's Prolific Ashleaf, Rivers' Royal Ashleaf, and Mona's Pride. Soil.—Old garden soil; originally heavy clay, now moderately light and full of vegetable matter. 2. End of March. *Snowflake, Woodstock Kidney, *Covent Garden Perfection, and Lapstone. Soil.—Same as for first earlies. 3. From 1st to 20th of April. *Suttons' Reading Hero, Scotch Champion, *Paterson's Victoria, and Dalmahoy. Soil.—Heavy clay. Manures and Application.—In rich garden ground I have obtained the best results from the use of wood ashes and charred rubbish strewn rather thickly over the sets when planted. Heavy dressings of rich manure usually predispose to disease; but on ordinary farming land manure is necessary, but ought to be applied and ploughed-in in the autumn. General Culture.—Potatoes once planted only require to be kept free from weeds until fit to be earthed up. Peruvian guano is strewn between the rows at the rate of about 2 cwt. per acre just previous to that operation being performed.—JAMES BELL, *Stratheldsaye, Winchfield*.

1. First week in November or first week in February. Rivers' Royal Ashleaf, Myatt's Prolific Ashleaf, King of the Earlies, and Porter's Excelsior. Soil.—Grey sand on sandstone or limestone subsoil. 2. End of February or first week in March. Dalmahoy, Daniel's White Elephant, Walker's Improved Regent, and Rector of Woodstock. Soil.—Hazel soil on gravel subsoil. 3. From the middle of March to the middle of April. Magnum Bonum, Scotch Champion, Paterson's Victoria, and Schoolmaster. Soil.—Sandy loam on mild brickearth or marl subsoil. Manures and Application.—For application in the autumn farmyard or stable manure or green vegetable crops such as late Turnips or Mustard dug or ploughed under. For the spring, artificial manures 5 cwt. of Peruvian guano and 4 cwt. of German kainit, applied in admixture with damp ashes in the trench or furrow with the sets at planting time. We have found when guano formerly contained 14 per cent. of ammonia, that 5 cwt. alone proved superior to any amount of other kinds of manure which we could apply, and this was the case on all soils to all varieties of Potatoes under our experiments. General Culture.—Autumn cultivation must be done either by the spade or plough 12 inches in depth, or to be effected by a cultivating implement or subsoiler with tines only immediately after harvest or earlier. Any couch or weeds to be forked out first week in November, and again before the last digging or ploughing the first week in February. Plant whole tubers of medium size not less than 9 inches deep either in the autumn or spring, in the first case to avoid frost, in the latter to avoid disease, for we have noticed that the soundest tubers always lie deepest in the soil in those seasons when the disease appears. Early sorts of Potatoes to be planted 18 inches in the lines and 22 to 24 inches between the lines; the second earlies at 30 inches between the lines and 20 inches in the lines. The late sorts are planted 3 feet apart between the rows and 2 feet apart in the lines. In earthing at the wide distance the deeper the furrow the better.—JOSEPH BLUNDELL, *Land Agent, Southampton.*

HEREFORDSHIRE.—1. Veitch's Improved Ashleaf, Rivers' Royal Ashleaf, and Mona's Pride. 2. Lady Paget, Coldstream or Smith's Early, and Covent Garden Perfection. 3. Lapstone, Snowflake, and Schoolmaster. Field.—Scotch Champion and Magnum Bonum. General Culture.—I have not grown twelve kinds of Potatoes, consequently I cannot undertake to name that number of varieties which shall eclipse the endless new sorts now bewildering the public; but I grow the following, and find them suitable to my soil and requirements. I never use animal manure when planting. I plant early in February and March, place the tubers or sets on the surface of the ground, then dress with a mixture of charred earth, lime, and well-pulverised soil from old Vine borders. Ridges 9 inches high are then formed over the rows of sets, and the work is finished until the young growths begin to push through. Our soil being cold and heavy, I find surface planting favourable to quick growth and early maturity. Of the two varieties named for field culture, Champions are fast gaining upon Magnum Bonum, as they are superior in quality and command the best price in the market. Neither of them is disease-proof.—W. COLEMAN, *Eastnor Castle Gardens, Ledbury.*

HERTFORDSHIRE.—1. From the middle of February. Old Ashleaf, Veitch's Improved Ashleaf, and Myatt's Prolific Ashleaf. Soil.—Light, on gravelly subsoil. 2. March. Smith's Early or Coldstream, Rector of Woodstock, *Schoolmaster, and Dalmahoy. 3. From the middle of March to the middle of April. Paterson's Victoria, Scotch Champion, and *Magnum Bonum. Manures and Application.—No manure is used unless ground is in poor condition, when stable manure is preferred. General Culture.—For first early Potatoes I usually select some good tubers of the old Ashleaf, laying them singly on the fruit-room floor or any light cool place until the first week in May. They have then made shoots from 3 to 4 inches long, and are planted on a warm sunny border in rows about 20 inches apart, laying them in the trenches as the ground is being dug, protecting with boughs if weather is frosty. These are ready for table a fortnight earlier than those planted in February.—RICHARD RUFFETT, *Panshanger.*

1. 1st to middle of March, and the same time for the second earlies. Veitch's Improved Ashleaf, *Myatt's Prolific Ashleaf, Beauty of Hebron, and *Paterson's Victoria. Soil.—These Potatoes are invariably grown here in the gardens, and generally follow crops which have been previously dressed heavily with farmyard manure. The soil has only been under cultivation for six years, and is chiefly of a medium texture resting upon a gravelly subsoil. The soil is the same for the second earlies. 2. Prince Arthur, the *Schoolmaster, Huntingdon, and Covent Garden Perfection. 3. Middle to end of March. *Scotch Champion, *Magnum Bonum, and Wormleighton Seedling. Soil.—These are always cultivated on the farm, and the character of the soil is of a light, free, open texture 1 to 1½ foot in depth, resting upon a coarse gravelly substratum. Horse manure is chiefly used for field cultivation ploughed in about the beginning of October at about eighteen loads per acre, and when planting we prefer using a sprinkling of Clay's fertiliser before covering the sets with the plough. General Culture.—For the early varieties grown in the gardens the soil is thrown up into ridges 2½ feet wide, remaining in this state all the winter; when planting the sets are placed between

them and the ridges levelled. When sufficiently advanced the Potatoes are earthed up again and kept clean. The late varieties grown in the field are planted after the plough, setting the plough so that every third furrow is seeded, using medium-sized sets 1 foot apart and 2 feet 9 inches between the rows. When ready the horse hoe is applied between the rows, and they are ultimately earthed up.—J. MYERS, *The Grove, near Watford.*

HUNTINGDONSHIRE.—1. Middle to the end of February. *Myatt's Prolific Ashleaf, Extra Early Vermont, Hammersmith Kidney, and Alpha, very early. Soil.—Medium loam, and if possible a south-west aspect; well drained. 2. Beginning of March. *Paterson's Victoria, Matchless, Snowflake, and York Regent. Soil.—Soil inclined to be rather heavy. 3. The end of March and first week in April. *Magnum Bonum, Red-skinned Flourball, Champion, and Bresee's Climax. Soil.—Generally rather a heavy loam. Manures and Application.—For early crops, half-decomposed leaves applied under and over the sets makes a good manure. The Potatoes come out clean, and generally of good quality. For later crops, spent hotbeds and stable litter I sometimes use. By incorporating them with the soil in the autumn before planting, and a little guano, not more than 4 cwt. an acre, sown over the drills at the time of planting before covering the seed, will both increase the quantity and improve the quality of the crop. General Culture.—The soil here is generally of a tenacious character and clay subsoil, so that named is what we use from necessity, not from choice. A plan that I find succeeds well is—In the autumn after applying the manure, dig deeply, and ridge up as roughly as possible in 3-foot ridges, thus leaving the soil well exposed to the atmospheric influences, which causes it to pulverise and work much better in spring. Before planting level the bottom of the ridges with the prongs of a fork or a rough iron rake, then plant the sets and cover with the soil, then the seed is all surrounded by soil that has been well exposed to the weather. I have obtained larger crops from Potatoes planted in the middle of November than from those planted alongside in spring, even after standing the severe winters of 1879, 1880, and 1880-81; but it is seldom that ground under crops can be secured in condition to carry it out on a large scale at the proper time.—WILLIAM KENNEDY, *Kimbolton Castle.*

1. If the land is in good order the middle of March. *Old Ashleaf, *Rivers' Royal Ashleaf, Beauty of Hebron, and Suttons' First and Best. Soil.—Good deep loam on clay. 2. Middle March. Schoolmaster, *Reading Russet, *Prizetaker, and Suttons' Fillbasket. 3. Beginning of March. *Magnum Bonum, Reading Hero, *Scotch Champion, and Paterson's Victoria. Manures and Application.—Stable manure for the early kinds, with a dressing of soot and Amies' manure or guano; soot and Amies' manure for late kinds after a crop that has been well manured the year before. General Culture.—Land should be dug or ploughed early before Christmas, and the oftener it is moved when dry the better. Plant early varieties 2 feet apart in the rows and 1 foot from set to set. Late kinds 3 feet apart and 1½ foot between the rows, and thin them when well up, only leaving the two main shoots; earth up twice.—ROBERT STOWE, *Kimbolton.*

1. Last half of February. *Veitch's Improved Ashleaf, *Myatt's Prolific Ashleaf, *Early Shaw, and Coldstream. Soil.—Loam, medium texture, resting on gravel. 2. March. Lapstone, *Early Rose, *Dalmahoy, and Schoolmaster. 3. March. *Magnum Bonum, *Paterson's Victoria, *Scotch Regent, and *Fluke. Manures and Application.—Stable and farmyard manure, well decayed, should be applied in the autumn, and if possible the land to be dug before Christmas and left rough. General Culture.—In planting the sets I prefer drills drawn 6 inches deep instead of dibbling, the first earlies 2 feet apart, the second and late varieties 30 inches. The sets should be at least a foot apart in the drills. When the plants are up two hoeings are beneficial before earthing to extirpate weeds and promote growth. A position fully exposed to the sun is essential for Potato culture, and the late kinds should not be dug until the skins are well set, and choosing, if possible, dry weather for harvesting them.—A. HARDING, *The Gardens, Orton Longueville.*

KENT.—1. Early in March. Veitch's Improved Ashleaf and Beauty of Hebron. Soil.—Heavy in all cases. 2. March. Schoolmaster. 3. End of March. *Magnum Bonum and Champion. General Culture.—No manure is used here for Potatoes. Schoolmaster is a first-class Potato, but with us is very liable to disease. Magnum Bonum and the Champion are of the finest quality if left in the ground till October; some were not lifted till November last year, owing to the wet, and no Potatoes could be better. Schoolmaster, owing to its liability to disease, will not be grown again.—R. GRAY, *Chevening, Sevenoaks.*

1. Early in March if the ground is suitable. Old Ashleaf, Veitch's Improved Ashleaf, and Myatt's Prolific Ashleaf. Soil.—Light soil. 2. Middle of March. Woodstock Kidney, Jackson's Kidney, Beauty of Kent, and Schoolmaster. 3. For all varieties. Magnum Bonum, Paterson's Victoria, Vicar of Laleham, and Champion. Manures and Application.—I chiefly use horse manure applied in the autumn; but if the ground is very wet turn it up roughly, and throw the dung on the top with the ashes from all the burnt rubbish, and fork it in in spring.—FREDERICK MILLER, *The Gardens, Northdown, Thanet.*

1. Second or third week in March. Hart's Selected Ashleaf, Beauty of Hebron, *Climax or Early Goodrich, *Early Rose, and *Kentish Invicta. Soil.—Light and chalky land. 2. Covent Garden Perfection, *Pride of America, *Beauty of Kent, and *Woodstock Kidney. 3. *Late Rose, *Magnum Bonum, Reading Hero, and *Adirondac or Schoolmaster. Soil.—All of these are good on light and medium soils. On bog land Schoolmaster is the best, and I have found it for four years quite free from disease; but it is of no use for general field culture, being perhaps the most ill-shaped tuber in cultivation. Manures and Application.—There is nothing like good farmyard manure kept over a year and turned several times. I have used this for the past eight years in growing my show Potatoes for the International Exhibition. I have tried some chemicals, the best of which I have found has been Amics'. General Culture.—To insure a good crop have the land turned up roughly during the winter months, and though it may seem an expensive matter, I think that we should find that to dig the ground for Potatoes would be the way to insure larger crops. Another great secret is in keeping the soil well worked amongst them till the haulm is strong. I usually plant the sets 2 feet apart for Ashleafs and early kinds, 2 feet 6 or 9 inches for strong-growing kinds, but I always have a second crop to come on in them, either Savoys, Brussels Sprouts, Kale, or Purple Top Mammoth Turnip, and this year I tried a small piece of Swedes, but the soil was too poor.—FRED. T. HART, *Faversham*.

(To be continued.)

ZYGOPETALUM MACKAYI AND ITS VARIETIES.

OF what are known as "good all-round" Orchids the true old *Zygopetalum Mackayi* is certainly not the worst, blooming as it generally does during the dull winter months, when flowers are scarce and flowers with a summer-like fragrance most valued. But what is the true *Z. Mackayi*? Well, you can look at the figures in the "Botanical Register" for 1844, or in Loddiges' "Botanical Cabinet," 1136, where a form of it is figured as *Z. intermedium*; then in the latter work, t. 1674, is *Z. Mackayi*, so also in Paxton's "Magazine of Botany," vol. iii., t. 97; in Lindley's "Sertum Orchidaceum," t. 7, as in "Botanical Magazine," t. 2748. Perhaps, having looked at all these portraits, you will be "a bit fuzzy," as is the description applied by plain Yorkshire folk to a man in that state when he can swear to "two moons at once." At any rate, none of these figures, good as they may be, do full justice to the plant dedicated to the memory of J. Townshend Mackay, LL.D., the first Curator of the Trinity College Botanical Gardens at Dublin, and figured in this Journal last week,

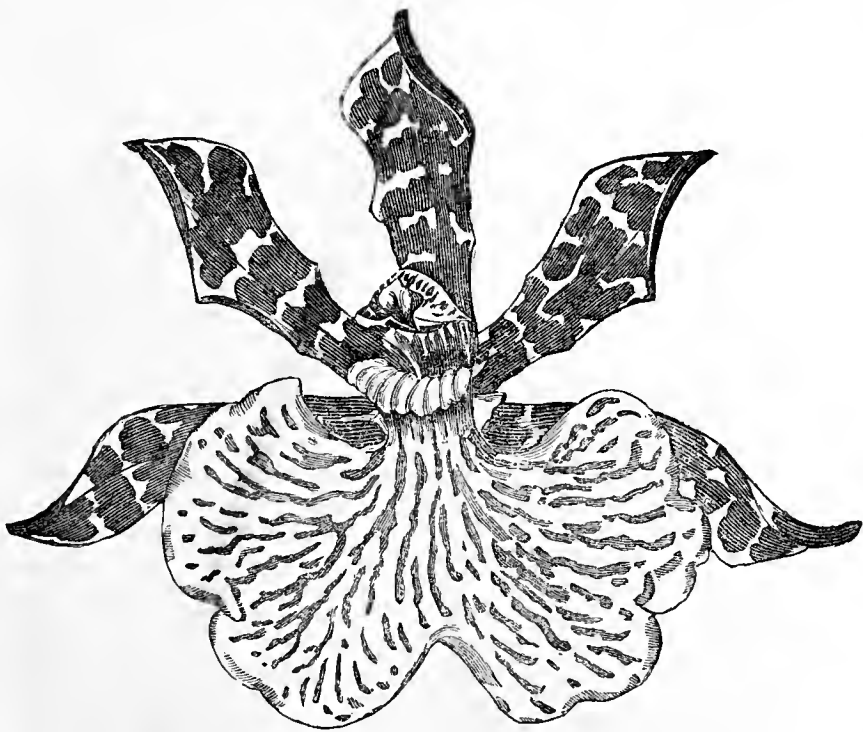

Fig. 53.—*Zygopetalum Mackayi*, var.

page 179. The fact is, in going about pretty frequently from one good garden to another one becomes convinced that this "grand old man" amongst Orchids is very variable also, there being indeed a sliding scale of these variations from *Z. Mackayi* minor, a pretty little thing with flowers an inch or so in diameter, up through the forms known as *Z. intermedium* or *Z. velutinum* of Loddiges', until, having ascended a "Jacob's ladder" of seven or eight steps at the least, we find size and beauty and fragrance all combined in what we call the true old *Z. Mackayi*, but which is often known as *Z. Mackayi giganteum* in the few gardens where it is to be found.

We have prepared a few figures of the most distinct of the variations which, apart from present interest, will, we hope, be valuable for future reference, for among other of our daily experiences we find that, however often anything is settled in the gardening press we represent, the same question is certain to crop up again, and in questions of this peculiar kind figures are so much

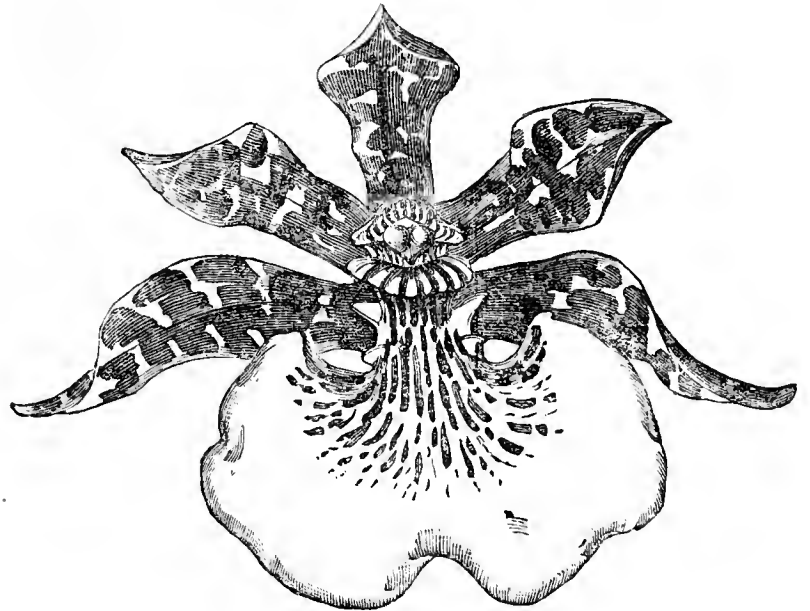

Fig. 54.—*Zygopetalum intermedium* type.

more eloquent than any amount of merely descriptive matter. Fig. 53 represents *Z. Mackayi* as often seen, but it is a variety smaller and paler in colour than the true species. Fig. 54 is *Z. intermedium*, Loddiges' type; and fig. 55 (page 195) a distinct variety of the same. Most of the controversy relating to newly introduced Orchids and other plants might be prevented by a good figure being given as soon after its introduction as may be. If an importer knows for certain what his plants really are he can readily get a good and faithful likeness of it, and if he does not know the less "descriptive matter" he indulges in the better. This much *en passant*; but now we must return to our text. If possible "first catch your hare"—that is, procure a plant of the true old *Z. Mackayi*; if not that, then secure the best variety you may. It is easily grown. Although Brazilian it makes grand growth in a cool airy house during summer. The largest growths we ever saw were made in a cool, moist, airy, and partially shaded Odonoglossum house. Everyone admired them, but, alas! they did not flower, and one's employer is apt to fancy "nothing but leaves"—no return for cultural expenses. The Mexican-house temperature was next tried: 90° on hot days, no shade, no fire heat at night, when the temperature fell to 45° or 50° very often. So grown the bulbs were smaller, the leaves shorter, and almost yellow rather than green, but the growths were sturdy and vigorous. Some gave two spikes, each spike bearing seven to nine flowers. Once in flower the blossoms are deliciously fragrant, and endure fresh for five or six weeks. Singularly enough the flowers lose their odour as night approaches—a curious contrast to those of the *Angræcums*, *Nicotiana affinis*, and other plants, which only become fragrant as darkness approaches. A compost of fibrous peat, sphagnum, and broken crocks is most suitable, and abundance of water when growing should be the rule.—ZYGOS.

EARLY AND LATE-FLOWERING CHRYSANTHEMUMS.

SEEING inquiries in the Journal about late-flowering Chrysanthemums, I beg to state my experience in securing a supply of blooms from the middle of November to February 19th from about eighty varieties. The first to come into flower were Mrs. Dixon, Gluck, Jardin des Plantes, Emily Dale, Mrs. Geo. Rundle, White and Golden Beverley, Mrs. Cunningham, Queen of England, Mrs. Huffington, Empress of India, and many others in succession. About Christmas I had a quantity of fine blooms to cut from. On Friday, 19th of January, I was requested in particular to cut a tray of Chrysanthemum blooms for a ball, the following being the varieties:—Cherub, Novelty, Julia Lagravère, Mr. Astie, Golden Cedo Nulli, Peter the Great, St. Michael, General Brainbridge, Aregina, White Cedo Nulli, Lady Slade, Miss Hope, Miss Mary Morgan, Faust, Guernsey Nugget, Blonde Beauty, White Eve, Lady Hardinge, Elcanor, Mr. Howe (which I consider to be one of the best), White Christine, Duke of Edinburgh, and a few others. After that I received orders from my employers to save a few blooms if possible until the middle of February, as they

should like some for a wedding, and on February 13th I again cut a quantity of blooms from the following varieties:—Robert Bruce, Elaine, Golden Christine, Hero of Stoke Newington, Fair Maid of Guernsey, Jewess, White Venus, Bronze Jardin des Plantes, Rev. R. T. Briggs, Lady Margaret, Pink Venus, Marabout, Model of Perfection, Rosinante, Countess of Dudley, Mr. Gladstone, Princess Louise, Ethel, and George Sands.

I have had Mr. Barns, a Japanese variety, this last four years, and have not succeeded in flowering it. I should like to hear if any of your readers have found it satisfactory.—T. B., *Kynsal, Audlem.*

WATERING AND DRAINAGE.

THE remarks of Mr. Young (page 152) about my notes on watering are both timely and reasonable. I am always glad to have my notice properly called to anything I write which may appear inconsistent with something in former articles. It is quite true that I attach great importance to thorough drainage of Vine borders, and in my treatise on the subject it is stated that a depth of 8 or 10 inches of rubble was placed under the soil; but it is also distinctly stated that letting off the superfluous water was not the only, nor even the principal, reason for placing it there. Two other reasons are given, and as I do not know that I can state them plainer I will quote them:—"The subject of aëration is a very important one, and possibly not fully understood; but this much we know, that the roots of plants cannot live without air, that air follows each supply of water given to the border, and that the system of drainage which allows a great quantity of water to be applied necessarily gives abundant aëration."

Another reason given is that "brickbats and similar material have some effect on the temperature of the soil above them, not only from the warmth contained in themselves, but from the body of air contained in the interstices, and which, being cut off from direct contact with the atmosphere of the house and that outside, must vary but very slightly;" and this is emphasised by adding that, "I consider that those who insert drain pipes vertically through their borders to connect the air of the drainage with that of the ordinary atmosphere make a mistake and neutralise to some extent the good offices of the rubble, because they make it possible for a circulation of air to take place otherwise than through the border."

I do not undervalue the importance of allowing means of exit for superfluous water; but supposing I had the means of ascertaining exactly how much water it is necessary to give the borders merely to keep them sufficiently moist, I certainly should not at any time give them more than that quantity; but as no instrument is yet invented for ascertaining the amount of moisture contained in the soil at a depth of 2 or 3 feet, we are obliged to guess to some extent the quantity of water necessary, the only guide being the success or failure attending former applications. But as in the case of the Vine a very large quantity of water is necessary, we are more likely to err by giving an insufficiency than by the reverse. We, therefore, practise drenching our borders thoroughly at intervals; and as there is provision made for the exit of all beyond what the soil can hold in suspension, perhaps the only disadvantages are a certain amount of wasted labour and wasted manure. These are evils for which there is no remedy at present as far as I know, but in the case of plants confined to pots with a comparatively small amount of soil it is altogether different.

The question of aëration has not now to be taken into account, unless it may be to prevent too much of it, as we do occasionally by plunging the pots, and the same may be said with regard to temperature, the extremes of which are to be guarded against.

There then remains simply the question of supplying and retaining sufficient moisture; and we have the plant in a pot so entirely open to observation as to its wants in this respect, that it becomes a very simple matter to gauge them by some of the various methods known to and practised by those who water carefully; and could I attend myself to a house of plants, I certainly should not be afraid to have the pots glazed and without a hole for drainage. I do not say that I should commence my experiments with "delicate Heaths" or *Lisianthus Russellianus*, but I have recollection of an event which partly bears on the subject as regards the last-named plant.

The best lot I ever saw of this beautiful plant was grown in such a manner that no superfluous water could run away, and none was ever given. The pots containing them were placed in saucers, and the only water they ever had was poured into these saucers, the surface, I believe, being never once wetted from above during their whole existence. When I state that the said plants

were grown at Shrubland Park by a namesake and valued tutor of my own, who also used to be known some thirty years ago in the neighbourhood of Streatham Common as a successful plant exhibitor, there will be many of your older readers who will remember him with kindly feelings. I think I never saw more beautiful objects in my life than those plants were, and Mr. Taylor, who suffered no one but himself to attend to them, was well repaid for his trouble.

I do not say that this case proves the correctness of my theory, but it goes some way to prove that a good plant cultivator long ago recognised the evils attending the washing and drying system of plant-growing.

Mr. Young rightly says that after a pot had become full of roots a plant would not be likely to suffer so much from having the drainage stopped, and asks if I ever corked up the bottom of a pot from the first of a plant's existence. I am not sure that I ever have done so. But when we see plants in cottage windows growing very fairly in old earthenware teapots, meat tins, baking powder boxes, blacking bottles, and even glass bottles with the necks knocked off, and with no provision for the escape of water, as well as in painted flower-pots, we ought not to fear the result of competition with the cottagers under similar conditions.

The only question about the matter is knowing when to give water, and how much to give. Over-drainage is often nothing but a precaution we are obliged to take in order to prevent saturation and souring of the soil at the hands of unskilful or unloving attendants.

With some exceptions our choice is only between having our plants dried up and drowned, and as the former evil is the easiest to detect we prefer it of the two.—WM. TAYLOR.

NOTES ON AURICULAS.

WE have just been examining and attending to our stock of Auriculas, and amongst your numerous readers there may be some who desire a few particulars at this time. First, the soil my plants are growing in is a pure loam mixed only with cow manure. To diminish the tendency to flower out of season as much as possible I have adopted a system of keeping the soil in the pots dry throughout the winter months. This past winter, in order to obviate as far as possible any ill effects to the plants from this course, the pots were placed on a layer of fine sand. This has so far succeeded that on turning out some of the plants in the beginning of February (up to which time no water had been given them since the end of November preceding), the plants, though perfectly quiescent, had fine healthy roots. The plants have been kept moist since, for with the fresh growth of foliage and flowers new roots will be produced, and dryness in consequence is now mischievous in its effects. The practice of surface-dressing the soil every spring has been said to be of little if any benefit to the plants. With the kind of soil at our command I find that surface-dressing is beneficial, though cases doubtless occur where this practice may not be necessary. The compost we employ is one-half of good loam to one-half of cow manure. Though the way I use the latter material has been explained before, it may not be amiss to restate its preparation here. Fresh but dry dung is selected—dry enough to rub down into fine flaky particles. This is incorporated thoroughly with the soil, which is also moderately dry, and the compost is ready for use. In preparing the plants the soil is allowed to become rather dryish. With a label or a pointed stick the surface soil is worked out from amongst the roots therein, at the same time removing any offshoots ready for doing so. The amount of fresh material required is packed firmly in the pot, which with the others is again returned to the frames, where they are watered in the same manner as any other plant. I have tried forcing some into flower, but it is not an experiment which can be commended. Offsets, however, I invariably keep in a slight heat until they are well established and ready for a larger pot. A weakly offshoot under this treatment will throw a good truss the first year. Liquid manure is useful when cautiously applied. The only stimulant I have used is sulphate of ammonia, which supplied in a weak state once a week three weeks running while the trusses are being produced, and provided the plant is well rooted, I have found to advantage. It is especially useful, as it causes other manurial ingredients of the soil to act more freely.

As many persons purchase Auriculas at this period of the year, I have made the following list select, as so many of the kinds grown are really not worth the trouble. There is a new one, John Simonite (Walker), which I believe is very good, but it was not to be obtained last season. John Morris is new and very good.

Green-edged Varieties.—Admiral Napier (Campbell), Admiral Wisbey (Headley), Colonel Taylor (Leigh), Excellent (Trail),

Imperator (Lytton), Lycurgus (Smith), Mrs. Clark (Trail), and Prince of Greens (Trail).

Grey-edged Varieties.—Acme (Read), Alexander Meiklejohn (Lay), Charles E. Brown (Headly), George Lightbody (Headly), John Morris (Meiklejohn), Lancashire Hero (Lancashire), Marie (Chapman), and Richard Headly (Lightbody).

White-edged Varieties.—Ann Smith (Smith?), Catherina (Summerscales), Glory (Taylor), Ne Plus Ultra (Smith), Smiling Beauty (Heap), Sophia Dumaresque (Lightbody), True Briton (Hepworth), and White Rival (Trail).

Self-coloured Varieties.—Blackbird (Spalding), C. J. Perry (Turner), Duke of Argyle (Campbell), Garibaldi (Pohlman), Eliza (Sims), Lord Clyde (Lightbody), Lord of Lorne (Campbell), Meteor Flag (Lightbody), Pizarro (Campbell), Ruby, Topsy (Kay), and Vulcan (Sims).—R. P. B.

As a lover of the Auricula, I with many others am very glad to see our friend "D., Deal," again penning some useful hints with regard to the flower itself and also its culture. The planting-out in a frame that he speaks of I can corroborate as a very useful proceeding, especially with one or two sorts that do not seem to do well in pots. I had some very fine green-edged flowers last year from plants standing in a sheltered border and covered

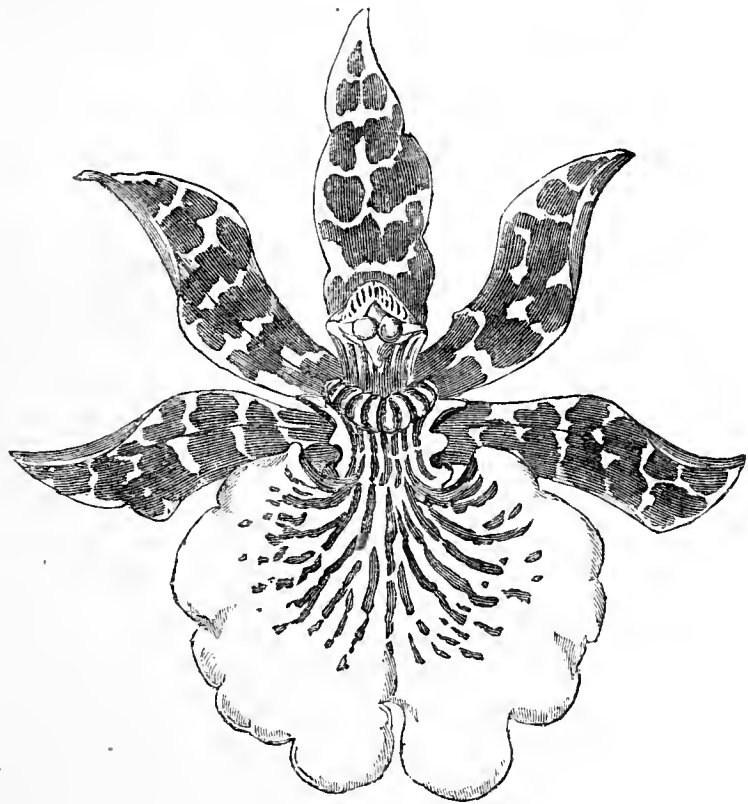

Fig. 55.—*Zygopetalum intermedium*, var. (See page 193.)

in with a long glass light belonging to my frame, which I could easily remove on fine days.

With regard to top-dressing, I am inclined to think it not so needful as some growers insist on, as I am sure no one could tell the difference in some plants of the same kinds when placed side by side that I had in flower last season, and as my time is much occupied I am omitting it with some plants this season.

But most of all am I glad to see the subject of "strains" in Auriculas discussed. One question forces itself on us at the outset, How are these strains produced? By cultivation, soil, treatment, climate, or what? If any light can be thrown on this it may perhaps tend to help some cultivators with whom certain sorts seem never to do well. With green and grey edge varieties I have no difficulty, but I have only one or two white edges that do well with me. I have now a plant of Taylor's Glory, which when I first had seemed to do as well as the rest, but for the last three seasons it has become "smaller by degrees and beautifully less," until now I have turned it out of my frame and intend to try it in the border above mentioned. White Rival, too, sorely puzzles me, producing long leggy growth, but no increase in size. Lee's Earl Grosvenor is this year serving me the same as Glory. All have the same treatment. One thing has always forced itself on me—that is, that certain sorts have produced seedlings exactly like their parents, and from these better or stronger-growing plants have come. I have tried this with General Niel, and have seedlings that cannot be distinguished from the parent, but several of these do not produce offsets to anything like the extent of the original. Is this so with others? If our friends will give their

experience in this it may tend to throw a little light on the subject. If such be not the case I wonder how the demand is met for sorts that produce scarcely an offset.—J. LUCK.

VINES BLEEDING AND MELON STEMS SPLITTING.

POWDERED alum rubbed on the cut or wound will stop the bleeding of Vines even in serious cases, and heal the wounds in the stems of Melons. I made the discovery last summer.

First, I had some Melon plants in pits, Blenheim Orange and the Best of All Melons. The plants had set a good crop, and the fruits were swelling well for nearly a fortnight. I then discovered the stems badly split and the sap exuding like boiled pulp. As I gave them up as ruined, I resolved on drastic measures, kill or cure. I purchased some alum and crushed it, then applied it to all the affected parts thickly, then covered the places with sulphur, and I was agreeably surprised to find that the plants finished one of the finest crops ever grown. One fruit of each of the varieties was sent to a local show; one was too ripe, and the other, almost perfect, was stolen, I suppose in envy for the fruit and seed conjointly.

Secondly, I cut down two main rods of Black Hamburg Vines just above where I had run up new rods. The old rods were about sixteen years old. I cut them in October as soon as the Grapes were removed, doing this early to help the young canes. Two days after the sap was streaming from the first, the other was not so bad. I rubbed the alum on, and then dusted it thickly over with more, and the dressing proved thoroughly satisfactory.—J. E. WAITING.

THE CHRYSANTHEMUM ELECTION.

THE numerous readers of the Journal, whose pleasure or duty it is to make the cultivation of the Chrysanthemum one of the many studies arising from their calling, cannot but feel grateful to the Editor for having originated this election, if only to give, by the aid of the discussion that is sure to follow, such information to beginners as will go far to remove the confusion which exists in the names and synonyms of the Incurved section especially. The result of the election illustrates the old saying that "a little knowledge is a dangerous thing," for it is evident some of the returns fell into the hands of a few whose knowledge of the varieties is not very deep. When we see as a fact seventy-seven varieties quoted as worth a place in a leading stand of twelve the result must be received with a certain amount of caution. My first impression was that Jardin des Plantes was in a false position. As a decorative variety in colour it cannot be surpassed, hence its popularity throughout the country; but as an exhibition variety, its ragged sub-divided petals and somewhat flat form precludes it from a first-class exhibition stand, and it is very rare that we see in the metropolitan district a first-rate flower shown. In Mr. Bunn we have a good substitute of better form altogether, although the colour is not so rich. Then, again, in your tabulated list of sixty-two names I find there are only fifty-eight varieties, and if the names of the following—Venus and Pink Venus, Beverley and White Beverley, Pink Perfection and Miss Mary Morgan, St. Patrick and Beethoven, had been bracketed together and the total votes added they would have been in a different position. But, apart from this, the list is a good guide to the relative estimation the different varieties are held in throughout the country, and no one can deny but that it contains the best of the Incurved section. No doubt several varieties that have been mentioned but once or twice would have had a higher place had they been better known, and consequently more generally grown. Princess of Wales and Empress of India I consider are fully entitled to their premier positions in the first twelve; and if the extra votes that were accorded to White Queen, Lady St. Clare, and Mrs. Cunningham had been added to the latter, to which beyond a doubt it was entitled, it would have placed Empress of India at the top of the list.

As regards the second list (page 138), containing the too-much-alike varieties, I must confess to being as much amused as I was surprised, for there is as much difference between some of the varieties bracketed as alike as there is between Général Jacqueminot and Gloire de Dijon Roses, and it shows how many there are distributed throughout the country under wrong names. I interpreted that you only wished for those varieties that were well known to be in existence under more than one name, and was therefore surprised to see that some electors had given names of certain varieties that were too near alike as regards colour to be shown in the same stand of twelve, although distinct enough in all other points, and might have been included in a stand without fear of disqualification. This I think might have been very well

left to the taste or selection of the exhibitor, and varieties only bracketed together that is well known to be synonymous, and that would lead to disqualification in case they were exhibited together. I would suggest to the trade to take the hint and avail themselves of the opportunity to obtain the information, and exclude all synonyms or bracket them together in their lists, thereby bestowing a great boon, and preventing much confusion in the future. I am quite prepared to be told that there are varieties about which the best judges differ. Without exception this is only in the case of varieties that have thrown a sport of another shade of the same colour, as, for instance, John Salter and Mr. Howe, Golden Queen of England and Emily Dale. Barbara and Baraba, Princess of Wales and Mrs. Hcales, are counterparts of each other except in the shade of colour. No doubt if we have the sport true there is a difference in all these, more especially in the two latter, which with me are very distinct; but there is no certainty that at any time in varieties where the shade of colour is so near they may not break back to the original, though, taking Chrysanthemum sports generally, it is rather the exception than the rule.

My advice is, when you have once got a true stock of an uncertain variety keep it if possible, and do not rely on anyone else unless you are certain it is right. But as regards the other question, I recollect the time when, I think it was, Mr. A. Forsyth, late of Stoke Newington, sent out Miss Mary Morgan, and many were disappointed to find it turn out identical with Pink Perfection, and I thought it was more generally known that they were alike, and also that Inner Temple is no other than Refulgence under another name, and that Mrs. Dixon and Golden George Glenny are the same. But there are many in the list, as you have pointed out, that are totally distinct both in habit, foliage, petals, and colour. I think most growers will agree with me that neither White Globe nor Isabella Bott should be associated with Empress of India. I should have no hesitation in showing all three in a stand of twenty-four without fear of disqualification. There are many more in the list that I should like to have mentioned, but I fear I have already taken up too much space. I was surprised to find Mr. Bunn and Golden Beverley bracketed by so many, as they are certainly distinct. I can speak with a little authority on that point. A few years ago Mr. Halstead, an enthusiastic amateur in connection with the Borough of Lambeth Society, who then had the sport, asked me to try it and report on it. I did so, and found it very distinct in colour and petal from its parent, Golden Beverley; but it was some little time before its merits were recognised. Now there is no doubt many can substantiate my opinion. Messrs. Jackson & Sons of Kingston-on-Thames had a number of plants amongst their fine collection, and were much impressed with it. The fine form and colour gained much favour, the petals being cleaner, and not coming cross-petalled like its parent.—C. ORCHARD, *Coombe Leigh, Kingston-on-Thames.*

As a grower of Chrysanthemums let me add my thanks to those of your other correspondents for the kindness and trouble you have taken in the election of the Incurved varieties. I also quite agree that an election of the Japanese varieties would be useful and highly appreciated, but it will require great care on the part of the electors. Many, however, have been able to grow the Incurved varieties for years, but have not had the same experience with the Japanese, as these are of far more recent introduction, and it is impossible for one grower to have them all. Some of the new varieties are both beautiful, distinct, and very large when well grown, and the same may be said of many of the older varieties. Before the election is begun, however, would it not be as well to mention whether they are to be elected for exhibition or decorative purposes? as some that are suitable for the first are not the best for the latter purpose. Many of the varieties, too, differ greatly as to their time of flowering; and as many small growers have not the knowledge in selecting the kinds, or the indoor convenience with heat, &c.—namely, for forwarding some and retarding others, their time of flowering generally should be specified.

In referring to Mr. Davis's letter, I certainly must disagree with him in classing Hermione or Countess of Granville as reflexed varieties. The former is white tipped pink, has incurved florets from the first time it begins to expand, and makes a medium-size, compact, incurved flower when at its best; after that, through the petals being of slight texture, they will reflex, as will many of our first-class varieties. My idea of a reflexed flower is that the petals reflex from the centre from the very first, such as is the case with the three Christines, Dr. Sharpe, Beauté du Nord, Emperor of China, Chevalier Damage, &c. Countess of Granville is one of the very best late whites we have for cutting purposes, though an old one; the petals, being rather stiff, keep fresh for a long time. This has been considered to be like Duchess of Teck, but it is two shades purer white. The former will make a fine

exhibition flower, which the other will not.—WM. ETHERINGTON, *The Gardens, Manor House, Swanscombe, Kent.*



WE have received from the Science and Art Department, by direction of the Lords of the Committee of Council on Education, a *précis* of a communication which has been received by that Department from the Foreign Office, relative to an INTERNATIONAL HORTICULTURAL EXHIBITION to be held at MARSEILLES on the 19th May next, of which the President requests full publicity and that facilities be afforded to intending exhibitors.

— RELATIVE TO GLADIOLI FAILURES, "J. W. M., *Clonmel*," sends us his authority for suggesting, on page 157, that Mr. Banks left his "choice hybrids out in the winter;" and on this letter our correspondent was quite justified in founding his remarks, which were penned in good faith, and as the matter now stands he accepts "D., *Deal's*," negative (page 178) on the point in question.

— CROYDON HORTICULTURAL SOCIETY.—We are informed that the Summer Exhibition and Rose Show of this Society will be held on Wednesday, June 27th.

— AN Ipswich correspondent sends us blooms of CINE-RARIA CLIPPER, a handsome variety, which is remarkable for the rich purplish-crimson colour of the large flowers. These are also of good form, though not quite so symmetrical as some that have been obtained in recent years, and the florets are very numerous, giving the bloom a full appearance.

— MR. CANNELL has sent us a box of PRIMULAS, and asks "what we think of them?" We think very highly of the flowers before us, which in size, form, substance, and variety of colours we have not seen surpassed. There are twelve distinct varieties, ranging from white, yellow, blush, lilac, rose, pink, crimson, to the rich Swanley Red. Such flowers could only have been produced by high cultivation.

— WE referred last week to large consignments of CUT FLOWERS FROM FRANCE which are now being sold extensively in London. Messrs. Collins Brothers and Gabriel, 39, Waterloo Road, S.E., have sent us a sample of what they are receiving. These comprise Anemone fulgens, which is the brightest flower in the market now, a double variety, neat and attractive; and a primrose-coloured Bulbocodium, *Corbularia citrina*. This is extremely pretty, its colour being soft and pleasing, and we are not surprised that it found so much favour in the market. The flowers do not keep so long in water as the Anemones do, which are as fresh and bright as when we received them a week ago.

— MR. DODWELL writes as follows from Stanley Road, Oxford, under date March 3rd:—"With reference to the proposed Carnation and Picotee Show to be held in the grounds of Mr. CHARLES TURNER, The Royal Nursery, Slough, on July 31st, will you be good enough to permit me to supplement my letter you gave publicity to last week by saying large subscriptions are not sought? If everyone who has known and admired Mr. Turner's work will kindly send me a postal order for 1s. I shall have a fund ample for all needs, and I would far prefer one thousand shillings to fifty subscriptions of £1 each."

— THE thirteenth Exhibition of the BRISTOL CHRYSANTHEMUM AND SPRING SHOW SOCIETY will be held in the Victoria Rooms, Queen's Road, Bristol, on Wednesday and Thursday, March 14th and 15th. Prizes are offered by the

Society in twenty-seven classes for bulbs, miscellaneous plants, flowers, and fruits, which include a four-guinea silver cup for the best collection of plants in bloom, and the Royal Horticultural Society's bronze Knightian medal for a group. In addition to these special prizes are offered in twenty classes by gentlemen and ladies residing in the neighbourhood of Bristol, and a Royal Horticultural Society's silver Knightian medal is offered for the best twelve Hyacinths in any class.

— MR. E. R. CUTLER writes:—"I have had an interview with Mr. Alderman Cotton, M.P. for the City of London, and he has most kindly consented to preside at the fortieth anniversary dinner of the GARDENERS' ROYAL BENEVOLENT INSTITUTION in aid of the funds of this institution, and has named Wednesday, the 4th July, for that purpose. The Alderman stated that he will do all in his power to promote the interests of the Society; he will be very disappointed if he does not receive assistance from the trade generally."

— A PAMPHLET of fifteen pages on the CULTURE AND EXHIBITION OF THE CHRYSANTHEMUM has been published by Mr. W. Jupp, gardener to G. Boulton, Esq., Torfield, Eastbourne. Ten pages only are devoted to the history and culture, which are, therefore, treated very briefly, the remaining five pages giving lists of varieties. It is fairly accurate, but does not treat the subject so fully as is desirable.

— RELATING TO PEARS ON THE CONTINENT, Dr. Mackenzie writes to us:—"Looking over my journal in Lombardy in 1859, I see frequent mention of 'fine large Pears nearly as good as Peaches at Florence, Bologna, Mantua, Milan, and Turin in March and April at 1*l.* each,' such as 1*s.* each would not obtain from Covent Garden at that time of year. They were in quantities on street barrows and shops—a plain, light brown, ordinary large pear-shaped fruit, needing caution if bitten, lest 'fileing ains claes.' What is that Pear's name?" It is the Winter Bon Chrétien, but will not succeed anything likeso well in this country.

— PLANTING FOREST TREES IN IRELAND.—Dr. Lyons, M.P., having suggested that employment might be found for considerable numbers of the Irish people who are in distress if the old forests could be restored to the country, liberal gifts of young trees have been offered for the purpose. Messrs. Little and Ballantyne of Carlisle offer twenty thousand trees; Messrs. Dixon & Son of Cheltenham follow this with a promise of fifty thousand; Messrs. Hogg & Robertson of Dublin and Scotland, forty thousand. Several thousands are also promised by Messrs. Bell & Sons of Hexham, and Mr. O. H. Higgins of Clonmel.

— RELATIVE TO THE IMPORTATION OF VEGETABLES, "Land" says:—"By the opening of the St. Gothard Railway this country seems to be benefiting hardly less than those more immediately affected. Early fruit and vegetables are now conveyed without transshipment from all parts of Italy to Ostend, Antwerp, and Rotterdam, whence they are brought by fast steamers to London and other British ports. We understand that the Great Eastern Railway alone has within a few months brought over six thousand tons of such produce."

— MR. WILLIAM TAYLOR, Longleat Gardens, Warminster writes:—"I send a sample of what I consider a perfect SUBSTITUTE FOR MAIDENHAIR FERN. What is your opinion? It consists of selected growths from a vigorous plant of the common Red Cedar (*Juniperus virginiana*). The small piece with matting tied on it is a sample of unsuitable growth from the same kind of tree. It will keep fresh a long time out of water." We consider it admirable for the purpose, and have frequently seen it employed in a similar manner, the only objection to it being that the green is rather dark and dull, not so fresh and bright as Maidenhair Fern fronds. Readers will understand that the growths employed are

those with very diminutive scale-like leaves which are pressed closely to the slender branchlets; the unsuitable portion is that which produces normal leaves. There are some species of *Frenela* or *Callitris* which produce even more graceful and slender shoots than the *Juniperus*; but they are comparatively scarce, and as the other is so readily obtained it might often be employed when Fern fronds are scarce, or to increase the diversity of foliage in stands.

— A DAILY paper says—"The EXPORTATION OF MAIZE from the United States will receive a severe check now that a commencement has been made with the manufacture of glucose sugar; for, unless many more acres of Indian corn are cultivated, there will be little maize to spare. A factory is nearly completed in Chicago which will consume about twelve thousand bushels of maize daily, and produce about thirty thousand tons of sugar yearly. Maple sugar and sorghum are unequal to the demand, but besides mere sugar there is the manufacture of alcohol, a liquid which enters into so many of the arts of the present day, and which in the United States can be produced as cheaply from maize as from any other starch-containing substance. In the far west maize has been a "drug" for years, so much so that it was actually cheaper to burn it for fuel than to buy wood or coal; but as the Chicago factory is only the forerunner of others, there is smaller chance of cheap maize coming to this country."

— A CORRESPONDENT sends the following note in reference to A LAND OF PEACHES.—"In the neighbourhood of Sydney, Australia, such fruits as the Peach, Nectarine, Apricot, Plum, Fig, Grape, Cherry, and Orange are as plentiful as Blackberries. The orangeries and orchards of New South Wales are among its sights; and in the neighbourhood of Sydney and round Port Jackson there are beautiful groves of Orange trees, which extend in some places down to the water's edge. Individual settlers have groves which yield as many as thirty thousand dozen Oranges per annum. One may there literally 'sit under his own Vine and Fig tree.' If a Peach stone is thrown down in almost any part of Australia where there is a little moisture a tree will spring up, which in a few years will yield handsomely. A well-known botanist used formerly to carry with him, during extensive travels, a small bag of Peach stones to plant in suitable places, and many a wandering settler has blessed him since. Pigs were formerly fed on Peaches, as was done in California, a country much resembling Southern Australia; it is only of late years they have been utilised in both places by drying or otherwise preserving. A basketload may be obtained in the Sydney markets for a few pence. The summer heat of Sydney is about that of Naples, while its winter corresponds with that of Sicily."

— THE *American Gardeners' Monthly* gives the following on WET WEATHER AND THE GROWTH OF TREES:—"It is said that some scientific society has instituted a series of experiments to find out in the far away past which were the wet and which were the dry seasons, by having examined the thickness of annual growths of wood in old trunks. It is surprising that any intelligent body in these days should not know better than this. Wood is not plastered over the old series, as a painter would put one coat on the coat which had gone before, but is an act of vital power proceeding from the cells of wood of the preceding year or season's growth. The amount of wood deposited depends very much on the food to be had in the vicinity of the little cells which have to make the new mass. If, say, at 10 feet from the ground there be a little branch with leaves having a chance to make food, the annual ring of wood will be thicker just below than at 2 or 3 feet lower down. In fact if we cut a trunk across at half a dozen places, and take any one side of the trunk for examination, we shall find the 'annual ring' of any one year varying in thickness. One section would tell us it rained that

year like a deluge, while another section of the same tree would tell us that particular year was the driest on record. However, if this is not sufficient, it may be as well to add that Sir Herbert Christison, the great Scotch chemist, has made some curious observations on the effects of a cold wet season in diminishing the normal growth of trees. He found on careful measurement that, comparing 1879 with 1878, eleven deciduous trees—not Oaks—made on an average 41 per cent. less growth in the last year than in the year before. Of seventeen Pine trees the average deficiency was 20 per cent., so that heat appears to have more to do with the making of wood than moisture has. It is strange that the growth of the Oak, which drops its leaves, seems less dependent on heat than that of the Pine, which we usually associate with very cold regions."

CULTURE OF CINERARIAS.

THE Cineraria is one of the most useful, showy, and at the same time easily managed plants in cultivation for the embellishment of the conservatory and greenhouse during the winter and spring months; and as it is a plant that comes within the reach of everyone possessing a couple of ordinary garden frames and a greenhouse from which frost and excessive damp can be excluded, a few cultural details respecting its management, and which if followed will lead to success, may not be unacceptable to those of your readers who hitherto have not succeeded so well as they could have wished in its cultivation.

A packet of seed from a good strain should be obtained and three sowings made of it—viz., one the middle of March, another the middle of April, and the third a month later. These sowings will supply a succession of plants. The seed should be sown in light fine soil, which has been previously made firm in the pot, covered lightly with fine sandy soil, over which place a piece of glass and damp moss, and then stand or plunge the pot in a Melon or Cucumber frame. As soon as the seedlings appear through the soil remove the moss, and when large enough to handle prick them out in pans or boxes and return them to the frame, where a look-out must be kept for slugs, which are very destructive to seedlings of this description. Bearing this in mind, and that "prevention is better than cure," it will be advisable to make a line of fresh soot and lime round the pans and boxes containing the seedlings, which, by repeating the application twice a week, will keep the pests at bay. The young plants should be well shaded from sunshine until their roots have taken to the soil.

Potting.—As soon as the seedlings are established into useful little plants in the pans or boxes into which they had been transplanted, take them up carefully by the assistance of a stout label, with as much soil as possible adhering to their roots, and pot them off singly in 3-inch pots in a compost consisting of three parts light loam and one of leaf soil, and a good dash of sharp sand, which should be pressed moderately firm, keeping the stems of the plants the same depth out of the soil as they were before; and I may here remark that this is a point, and a very essential point too, that should be observed every time the plants are being potted, as the cause of the plants frequently "going off" is to be attributed to their having been potted too deeply. The plants when potted should be placed on sifted coal ashes in a frame near the glass, watered through a fine rose to settle the soil about the roots, and shaded for four or five hours on bright days, as the plants are very susceptible to injury from bright sunshine. As soon as the plants have partly filled the 3-inch pots with roots they should be shifted into 5-inch pots (a useful size for furnishing purposes), ramming the soil between the sides of the pot and the ball of the plant with a flat stick; and if large specimens are aimed at the plants should have two more shifts—viz., into 7-inch and again into 9-inch pots, always bearing in mind that after the plants have produced their flower-spikes there is no use in giving them larger pots with the object of increasing their size, and that where large plants are desired the latter should not be allowed to become root-bound before being placed in their flowering pots. The pots should be properly drained by placing a large piece of potsherd over the hole in the bottom of the pot, then several pieces of smaller ones, and finish off by filling-in the chinks with pieces which have been through a quarter-inch sieve, altogether a little less than one-third the depth of the pots, and over all place a handful of sphagnum moss, which will prevent the soil coming in immediate contact with the drainage.

Watering the Plants.—This is an operation that should be carried out (like every other cultural detail that has for its object success) with judgment—that is to say, the operator should know

when to apply water and withhold it from the roots of the plants, and when they have had enough to thoroughly moisten the balls of earth and roots; and again, that pots full of roots require more water than those only partly filled; also that plants which have filled their pots with hungry roots will be considerably benefited by being watered alternately with diluted liquid manure. If the plants are, as they should be, thoroughly moist at the roots when being shifted into larger pots they will not require to be watered for several days afterwards—not until the roots have pushed into the new soil and nearly absorbed the moisture therefrom. But at this stage of their growth the plants—which, as I have already hinted, and on account of their soft watery growth require more shading than most other plants—should have the shading put on earlier in the morning and left on longer in the afternoon for a few days, and when removed the plants should be dewed with the syringe—a procedure that may be repeated with advantage to the plants every bright afternoon during the summer months.

Air-giving and Situation Suitable to the Plants.—The Cineraria in every stage of its growth may be termed a fresh-air-loving plant, but does not like it when admitted in currents. Our own practice during the months of June, July, and August is to leave plenty of air on all night; indeed, when the nights are quite still and fine overhead we draw the sashes off altogether, tilting them again in the morning.

If the frames—which should be placed facing the north during the months of June, July, and August—are deep, a platform, upon which should be put a couple of inches of sifted coal ashes, should be raised so as to bring the plants near to the glass, lowering it again as they require more headroom; sufficient of which they should have every way and at all stages of their growth to properly develop themselves.

The Cineraria, provided the cultural details are properly carried out, will, during the winter and spring months, flourish in any light structure where the plants can be kept near the glass (to prevent their being drawn), and from which excessive damp, which would cause mildew to attack them, and frost can be excluded. The plants, especially so if they are subject to forcing, and to which process they do not readily respond, are liable to the attacks of green fly; and to eradicate this they should be fumigated lightly with tobacco paper a couple of nights in succession, syringing the plants next morning and ventilating them freely, weather permitting.

Seed-saving.—When the plants are in flower the cultivator should save seed from the most distinct colours and best formed flowers, and in this way, by judicious selection every year, he will in time become the possessor of a good strain. Thus grown, we have had this spring several hundred plants of Cineraria, ranging from 1 to 2½ feet through, and furnished to the base with luxuriant foliage, above which are fine heads of flowers of various shades of colour. They are in houses in which the temperature ranges from 35° to 50° at night. In a cut state, especially when intermixed with the feathery flowers of *Spiræa japonica*, and garnished with the beautiful Fern-like foliage of the latter plant, the Cineraria is admirably adapted for the embellishment of vases, &c., as the flowers, in addition to the variety of pleasing colours which they supply, keep well in water.—H. W. WARD, *Longford Castle*.

THE HORSE CHESTNUT.

A DISCUSSION has recently been held at our gardeners' meeting as to the origin of the above name as applied to the well-known tree, but without any decision being arrived at, and it was suggested that I should write to you on the subject; also I am desired to ask if there is a Chestnut having flowers as double as a Hyacinth, as opinions were about equally divided on that question.—SECRETARY.

[As to the first question, Gerarde may have been right, who wrote about the period when the tree was first introduced here, when he said it is called "Horse Chesnut, for that the people of the East countries do with the fruit thereof cure their horses of the cough, shortness of breath, and such-like diseases;" but we rather think that the prefix "horse" was merely employed to denote harshness and powerful flavour, as in the case of Horseradish. As to the second question, a figure is submitted of a spike that was grown at Sawbridgeworth several years ago. The variety is of continental origin, and is grown in most nurseries.]

NEPENTHES.

THESE plants are very useful for decorative purposes, and not at all difficult of culture, the wonder is they are not more generally grown. The present is the time to attend to their requirements, no plants better repaying for the attention given them. *Nepenthes*

in small baskets are unique for table since plants can be had in those 6 inches square, and fine specimens in others 12 inches square, the depth being proportionate to the size of the baskets—about 4 inches

for the smaller size and 6 inches for the larger size. Teak is the most suitable material for making the baskets. Strips half an inch square for the smaller size, and an inch square for the larger,

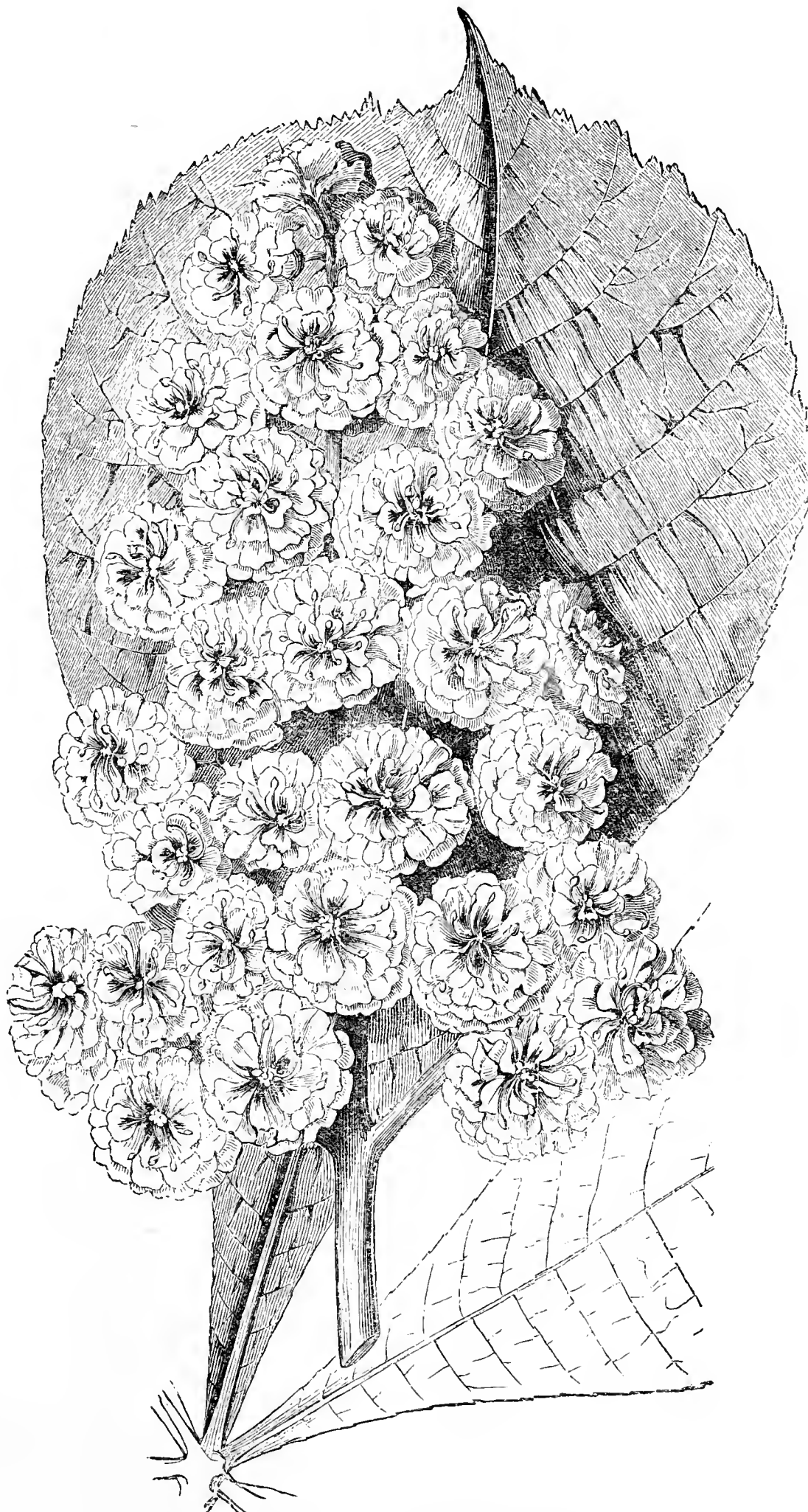

Fig. 56.—THE DOUBLE-FLOWERING HORSE CHESTNUT.

the edges in each case being bevelled. The plants do well in peat alone, pulling it in pieces, rejecting the coarse roots and small

particles, using the more fibry parts only. They may also be grown in fibrous peat, chopped sphagnum, and crocks and

charcoal—one-third each of the two former, and the two latter combined in similar proportions. If grown in pots good drainage is essential. Plants in small baskets or pots may have a shift into larger, but avoid too much root space. Those in large baskets or pots should have all the old sour fibre removed and fresh supplied, yet there must not be any attempt at disrooting.

Nepenthes like a strong heat, plenty of atmospheric moisture, and shade from powerful sun, otherwise keep them well up to the glass. A night temperature of 70°, and 75° by day from fire heat, and 80° to 85° from sun heat, will suit them well. The best pitchers are produced on young growths, and to get new growths from the base and additional shoots most plants will require to be shortened back, as they break freely from the ripened growth. This gives the plants a fresh appearance, keeps them dwarf, and is the way the best pitchers are obtained. The tops removed may be made into cuttings—*i.e.*, the ripe brown parts, but the green unripe soft tops are of no use. Three joints are ample, cutting them transversely below the lowest, and removing the leaf and shortening the others to economise space, or tie them up loosely. These may be inserted singly in thumb pots in cocoa-nut fibre refuse or sphagnum and small crocks. Plunge in a propagating frame where there is a brisk heat until rooted, which requires some time, as they do not root very quickly, and ventilate a little so as to prevent too great an accumulation of moisture. When rooted remove them, but not to a dry atmosphere, and after they have been inured to the temperature and atmosphere of the stove they may be placed in peat fibre in small baskets or a larger size of pot, and allowed to make as much growth as they will the first year, and afterwards be cut back to induce branching from the base.

For decorative purposes *N. Chelsoni*, *N. Hookeriana*, *N. Rafflesiana*, and *N. sanguinea* are admirable. *N. ampullacea vittata*, *N. albo-marginata*, *N. Domini*, *N. hybrida maculata*, *N. intermedia*, *N. gracilis major*, and *N. Sedeni* are very useful. *N. distillatoria* succeeds in an intermediate temperature. For furnishing damp walls *N. ampullacea*, *N. hybrida*, *N. laevis*, and *N. phyllamphora* are well adapted. Amongst the new forms *N. Mastersiana* is especially promising, and will undoubtedly become a great favourite. Thrips are their greatest enemy, which is best kept under by affording plenty of moisture. In order to keep the pitchers fresh as long as possible, those fully developed should have a little water in them, as if allowed to become dry they sooner become brownish.—G. ABBEY.

CROSS-BREEDING PRIMULAS AND AURICULAS.

(Continued from page 170.)

LET us look now for a moment at the florist at work. He wishes to raise nothing but thrum-eyed flowers; but Nature will not be so coerced, for although he employs only thrum-eyed flowers, Nature struggles to restore the balance necessary to the natural perpetuation of the species, and for all his care pin-eyed flowers appear. But he obtains a few seeds, because he takes pollen from long stamens to apply to short pistils. He obtains some seed because the strength of pollen grains varies greatly, and occasionally weak grains, throwing out weak tubes, too weak to burst the ovules, furnish the operator with a scanty return, which produce weakly plants that have to be coddled and petted in frames and in pots, and often at last fall victims to insect enemies, dwindle, and die. When such seed is sold to the ordinary lover of flowers, who is no florist, who wants beautiful flowers and plenty of them, but has no time for growing Auriculas in pots, or even no frame, he is greatly disappointed. He little knows the trouble with which good seed is raised.

But why should not all such grow border Auriculas? The answer is that these, though they are attractive enough, want the brightness and beauty of the beautiful Alpine varieties seen at shows. Then we ask, "Why not grow Alpine Auriculas without frames, but outside in beds and borders?" Those who have tried will probably answer that they are not hardy enough, that they die in winter, and besides grow so weakly and produce such unsatisfactory flowers that the game is not worth the candle. Their price, too, is a drawback.

Auriculas may be produced from fine florists' kinds possessing all the beauty of the Alpine section, with all the robustness and all the floriferousness of the very hardiest border kinds, if only some pains be taken to raise seed, not according to the artificial plan followed by the florist, but by Nature's plan, which produces vigour and hardiness. "But," the reader may ask, "is not this theory only? Has it been done? can a really hardy robust race be raised from such tenderlings?" The writer of this has produced such results, and he feels confidence in promising anyone else the same, and really good Auriculas are such beautiful plants that it

will repay the trouble of anyone who will undertake to produce them.

Convinced of these facts, but not having proved them, and enamoured of the beauty of Alpine Auriculas as seen in a good collection, but having neither plants nor frames at his disposal, the writer some years ago bought a half-crown packet of Alpine Auricula seed from a well-known firm in order to try what could be done. The packet was small and the seed germinated badly, so much so that some dozen or so weakly plants was the result. These, by careful nursing, flowered the spring after sowing. One was discarded because of its washy colour, and one or two because the stems were so weak that the weight of the truss bent them over, thus allowing the flower to be spoilt. The others, all different, were as bright in colour as any named Alpine, if not so exquisite in form. Some were thrum and some were pin-eyed, and all produced seed freely. Anxious to improve their constitutional vigour, and not trusting wholly to natural fertilisation for that result, all weakly pods were removed from each truss, and the plants supplied with a little weak liquid manure. The result was about half a teaspoonful of clean plump seed, not at all like the almost invisible grains we bought. This was sown in heat in the following spring; the plants pricked off as soon as they had four leaves, using light loam, leaf soil, and sand; finally planted out 3 or 4 inches apart in a bed well enriched with thoroughly decayed manure forked into the surface only, and protected by a frame light, shaded when necessary till June, and then left to take care of themselves till the following spring. The winter was exceedingly severe, the temperature falling more than once below zero, but not a plant was injured. Every plant flowered, and there were hundreds of them, and hardly one had to be discarded. They were all the shades imaginable, and the individual trusses and pips were extremely large, much larger than are ever seen in named varieties. About one half were thrum, and the other pin-eyed, and so good were the former that none but a florist could have pointed out in what they were inferior to the others. The pin-eyes would have all been rejected, but we are bound in truth to say that in brightness and beauty they were not a whit behind any named Alpines ever seen, while in floriferousness and vigour they were far before them.

Selection on the same principle as before was carried out, and the chosen one planted in a border prepared as the bed had been. There they grew amazingly—so much so as to both delight and surprise us. The following winter was wet, and this district is an exceptionally wet one, and sometimes very frosty. The border was fully exposed to all weathers, but not one succumbed, and when spring came each plant produced from six to twelve trusses, producing such a show as was never seen in any collection of named Alpines. As there were two or three hundred plants an enormous amount of bloom was the result, and there was enough for glasses, for friends, and to spare.

Again seed was selected, again sown, again the plants flowered the year after being sown, and again with the same satisfactory results—indeed even more so, for an even greater variety was produced—shades and shaded flowers of rare beauty, such as we had never seen before, and all possessing a constitutional vigour surpassing any ordinary border varieties (these latter we have now wholly discarded). Having now hundreds to choose from our selection became severe, and many flowers, more beautiful than at one time was hoped for, combined with hardiness and vigour, were given away, for very numerous were the applications that were made for "one or two plants." These a florist, a possessor and lover of florists' varieties, saw when in bloom, and was constrained to say that never out of doors had he seen such fine Auriculas. This we took to be real praise, for so fond of them is the individual referred to, that he has made pilgrimages hundreds of miles to see famed collections.

About two tablespoonfuls of seed was saved last summer from our best varieties, and this my late employer has kindly allowed me to do what I like with; he has enough and to spare of fine plants, he says. This seed I intended to sow, and secure if possible still greater improvements, but this, owing to my illness, I am afraid I shall not be able to do. Auricula seed does not keep well, and as it is now fresh, and perhaps some of your readers fond of Auriculas, but without time or appliances to grow the more delicate named varieties, may be inclined to begin where I left off. I shall be glad to forward packets on the terms mentioned below to all who may apply for them as long as the supply lasts; and I may add, Now is the best time to sow, and by all means in heat, as the plants are all the more likely to flower next spring; in fact, are certain to do so if properly treated. When no heat is at command they may be sown under a handglass in April; but they will come in quicker under glass, even though it should only be a greenhouse. Sow in a box, the soil becomes dry less quickly than

in a pot. Never allow the soil to be dry, and to prevent the necessity for frequent waterings shade with thick paper till the seedlings appear.

They will thrive anywhere in the northern counties, but in the southern they are greatly benefited by being shaded from the mid-day sun. Copious waterings in very hot dry weather are of great advantage.—SINGLE-HANDED.

[In consideration of the severe and protracted illness of our esteemed correspondent, who is now in a public institution, we shall be glad to distribute this seed for him, and will forward packets containing one hundred seeds for 1s., or three packets for 2s. 6d., in the rotation that the letters of applicants are opened, returning the stamps, less one for postage, to those who may send them after the supply of seed is exhausted. We should prefer, however, that an extra stamp be sent for defraying the postage of the packets, and we presume those who apply will be glad to send it. Some wonderfully vigorous trusses and richly coloured flowers of this excellent strain of Alpine Auriculas were sent to us last year. We may add, in answer to inquiries, that although "Single-handed" is, we trust, steadily recovering, some time must elapse before he will be able to resume his employment; but if he cannot wield the spade, it is a satisfaction to observe he can "lift the pen."]

SO-CALLED LARGE BUNCHES OF GRAPES.

I READ and reasoned over the article by "Druid" on this subject, which appeared on page 53. He begins by announcing that he does not propose to deal with the question whether they are genuine and *bonâ fide* single bunches, and is found a little further on remarking on the "sore dissatisfaction" which

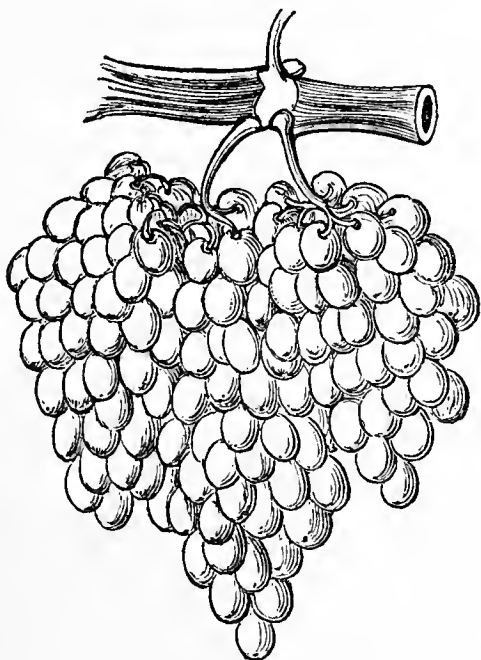

Fig. 57.

past exhibits of large bunches have caused, and "justly so, too, in many cases." This last quotation makes "Druid" deal with the question in a manner that leaves no doubt on the mind—at least on mine—that he considers many of the past exhibits of large bunches to have been the reverse of *bonâ fide*. The cluster of Grapes figured on the page quoted does not appear to me a so-called bunch, but in reality *one* bunch. What I consider constitutes *two* bunches is when they come direct from the lateral without joining, as in fig. 57.

I cannot gather from "Druid" if he manipulated the bunch figured in the way he says can be done so easily. A little clearer information on the matter would be acceptable to me, and I dare say to others who have in times past shown large bunches which were not subjected to the splicing treatment which "Druid" says can be so easily practised. I, for one, entirely fail to see that "Druid" has proved anything by his writing and the bunch figured; it is neither more nor less than one bunch as it appears in your paper, having only one stem proceeding from the lateral that bears it. Trusting "Druid" will make himself clearer on the subject, so that there may be a chance of comprehending him.—A GROWER.

[What our correspondent alludes to as the "stem," is really the lateral bearing two distinct bunches so close together as to form one cluster. There is no splicing, and the only manipulation required is to stop the lateral after two bunches have been formed,

and remove the foliage. What is termed by "A Grower" the "lateral" is really a sub-lateral induced by the stopping and defoliation of the original, and is encouraged to form the leading shoot. Perhaps "Druid" can make the matter more plain.]

A SUBSTITUTE FOR PEAT IN ORCHID CULTURE.

AS good Orchid peat is now very difficult to be obtained, this being proved by what Mr. Harry Veitch states in a letter to me received last week—viz., "Orchid peat has been a great difficulty with us lately on account of the excessive rainfall, which has made it difficult to procure. I fear it may be weeks, if not months, before we could send you any; it becomes scarcer every season."

Under these circumstances, and as a substitute, I am going to try the outer shell of the Cocoa-nut chopped up into pieces suitable to the size of the pot. Will other growers give this a trial and let us know the result?—ALEX. PATERSON, M.D., *Fernfield, Bridge of Allan.*

THE INSECT ENEMIES OF OUR GARDEN CROPS.—No. 2.

WHEN they are regarded in their general aspect, it will be agreed that the fruit crops are of less importance to the nation than are the vegetable crops. The actual nutriment afforded by fruit is below the average of that obtainable from vegetables, I should say, even if we leave the cereals out of the question; and several fruits largely cultivated in this luxurious age serve rather to gratify the palate than to sustain life or invigorate the body. Hence we have less reason, perhaps, to regret the fact that our fruits inflict upon the growers, small and large, various disappointments that do not occur in the culture of vegetables. With many of our garden vegetables a few months embrace the whole period of growth, and if one crop fails another can frequently be raised to succeed it; while in the dull season there is little to be done by way of precaution against insects, except to watch against enemies lurking underground. But fruit-bearing trees and shrubs require attention of a special kind during their period of rest, when they are liable to the attacks of minute and crafty insect foes. Changes of weather, cold winds, drenching rains, lack of sunshine, also affect unfavourably the fruits more than they do the humbler products of our gardens; and the insects by which they are haunted during the summer season are sometimes of gregarious habit, so that by their numbers and activity they are apt to baffle all the gardener's efforts.

In the preceding article an attempt was made to sum up briefly those insects that are chiefly destructive to garden vegetables. A few of them are also injurious to the leaves or roots of shrubs and trees, those I shall not here recapitulate. Then there are cases where an insect in its mature state does harm to our fruit, while as grub or larva it had previously attacked our vegetables. Some of the insects found upon fruit trees have no special liking for them, but the moths or other species during their flight lay eggs promiscuously upon the leaves or twigs that may come in their way. It is for this reason an objection has been raised to the familiar Hawthorn hedge, because sundry caterpillars feeding upon it, as also upon the Blackthorn, Ash, Elm, and Lime, soon make themselves at home upon such trees as the Plum, Pear, Apple, or Peach. But it might be argued on the other hand that the presence of a variety of trees may draw off some of the enemies of our fruits.

As amongst the vegetable produce the Lepidoptera, comprising the butterflies and moths, may take the lead, for not less than thirty species of these can be reckoned upon the list of the foes to fruit. Beginning at the root, every part of a tree or shrub has its regular or occasional enemy; in some cases, however, the harm done is but slight, amounting merely to disfigurement of the foliage. And again, concerning several tiny caterpillars and grubs which bore into and so destroy a percentage of the buds or fruit trees almost every year, it has been suggested that their office is, within certain limits, a useful one; they remove part of the bloom to give the remainder a better chance of maturing into fruit. It is possible for them to be too abundant, and then the ministry of insect-eating birds comes in; but it is the fashion now, both in Britain and on the Continent, to discourage some of our best friends of the feathered race. We have not a butterfly that is harmful to fruit, though the Black-veined White was formerly complained of. Of the moths the two largest attack the wood of trees and not their fruit; these are familiarly called the Goat and the Wood Leopard. Their caterpillars, which live many months, live unseen for the most part until their destructive labours are finished. Possibly a portion of the trees they infest

have an unsoundness previously which invites such attacks. The Currant Clearwing, a little fly-like species, tunnels in the Currant pith; and its relative, the Red-belted, performs upon the Apple, Pear, and rarely on the Apricot. Our Gooseberries have their caterpillar, in some seasons a great pest to them, and also to the Currant. The leaves of the trees in our orchards and upon our walls are seldom free from the traces of the jaws of caterpillars, and if undisturbed, one or two such prolific species as the Little Ermine and the Winter Moth may spoil our success for years. Others prefer, as already noted, the buds or flowers, or they enter the fruit like the Codlin Moth in its larval stage, and the red grub of the Plum.

The beetles, or Coleoptera, are represented by more than a dozen species prejudicial to fruit. The majority of these belong to those curiously snouted fellows, the weevils. There is a weevil that frequents the blossom of the Apple, and the Pear has a similar species which feeds upon the leaf as well as on the flower buds. Several species in the genus *Otiorhynchus*, especially the insect called the "black weevil," are injurious to the Vine, the Strawberry, and various fruit trees. One or two of the weevils have a fancy for the young leaves of Peach and Plum. The Apple bark beetle, a *Scolytus*, does not kill, but probably weakens the trees it visits, and the notorious *S. destructor* is credited with the destruction of some old trees that would still be good fruit-bearers if let alone. There are beetles which in their larval state feed upon the roots of various plants, and they—the Rose Chafer is an example—may lurk beneath the Currant bushes or in our Strawberry beds. A number of beetles, hitherto deemed beneficial, as carnivorous by habit, have now got a bad repute because they have been detected feeding upon Strawberries, perhaps through scarcity of their natural food. Every season the Nut Weevil takes its share of our crop of Filberts, for its attacks cannot be guarded against.

When we come to the order Hymenoptera we are at once reminded of the hornet and the wasp, species fond of fruit, yet also killers of a variety of other insects. Far worse enemies are the grubs or larvæ of some of the sawfly family. One of the very familiar species swarms upon the Gooseberry in certain (or rather uncertain) seasons. The Plum and Pear have also their species. Yet more disgusting, if less injurious, are the slug worms of the genus *Selandria*, and it is very difficult to remove them from trees, although we may clear the bushes and saplings of the insects and their slimy deposit. We have not much to say against the Diptera or two-winged flies, but of course they will visit ripe fruit. Some of them, like some in the preceding order, are parasites upon caterpillars, and so they check the increase of troublesome garden species.

A formidable yet minute array of disagreeable insects is presented by the Hemipterous order. Here belong the aphid hosts, the so-called "American blight," nearly allied to them, all of prolific habit and given to sucking, whereby more harm is done to vegetation than by the simple act of biting or nibbling. Then there are the scale insects, very pertinacious if less abundant than the aphides. Against the Vine bug (*Coccus Vitis*) there is need of careful precaution in our houses; and the grubs of the *Psyllæ*, which occur on various parts of the Apple and Pear, make their visitations more troublesome by clothing themselves with patches of a downy substance. Amongst the wingless insects the centipedes, although predatory at times, like to enter stone fruit; especially is this the case with the smaller kinds. The red spider, as it is popularly termed, is a spinning mite or *Acarus*; with sundry species of its tribe it holds a place intermediate between true insects and spiders. Other *Acari* occur on fruit trees; one or two species appear to feed sometimes upon the scale insects. Some of the insect enemies of our fruit and vegetables also haunt flower beds or greenhouses; but in the present imperfect condition of our knowledge it would be difficult to give a summary grouping the foes of floriculture.—ENTOMOLOGIST.



[By the most skilful Cultivators in the several Departments.]

HARDY FRUIT GARDEN.

Filberts and Nuts.—The pink fruit-producing blossom is now open and is abundant on all kinds of Nuts, but the crop will probably prove a failure, for the catkins that should now be

yellow with pollen have all been destroyed by the wet winter, with the exception of a few of Pearson's Prolific, which may afford sufficient pollen to insure a crop of that valuable and very hardy Nut. We have repeatedly recommended it as a sure and abundant cropper of robust sturdy growth, thriving perfectly in soil where the delicate Red Filbert will hardly exist, and this year it appears likely to confirm our high opinion of it.

The pruning of all sorts of Nuts should be proceeded with forthwith. The best form for the trees is that of a shallow basin, which is imparted by pulling the branches downwards and outwards with strings fastened to pegs driven into the ground, and by pruning the top of each branch to a bud on the under side the lateral growth is pruned closely to spurs, an occasional shoot bearing plenty of catkins being left 6 or 8 inches long to afford pollen. This unfortunately cannot be well done this year. Strong young growths crowding the interior of any trees must be cut clean off close to the base, and all suckers be removed carefully without injury to the roots, a few of the most promising being selected for the nursery to make trees for future requirements.

Protecting Fruit Blossom.—Have the materials for protection at hand when required, but do not use them till the blossom begins to expand. Full exposure now tends to retard the swelling buds, and every day so gained adds to our prospects of a crop of fruit. A little extra care and pains now in sheltering the blossom from cold wind and late frost may crown the labours of the past twelve months with success, and make all the difference between scarcity and abundance. Sorts of fruit which naturally flower late are of especial value from their immunity from the risk of harm to which earlier kinds are so liable. Much valuable knowledge of this important matter may be gained by close observation at this season of the year. For example, we observe now among pyramidal Pear trees that the buds of Nouvelle Fulvie, Duchesse d'Orleans, and Beurré Duhaume are all white and full to bursting, while close by Knight's Monarch, Urbaniste, and Pitmaston Duchess have hardly a sign of animation; and of espaliers side by side the buds of Beurré Hardy are quite dormant, but those of Beurré d'Anjou are just bursting open. So, too, among Apples and Plums in the open, and Peaches and Nectarines on walls, the same difference is perceptible. Blossom is also tender only in degree, that of some varieties bearing exposure to cold much better than others. All this, of course, applies to ordinary seasons, and not to weather of such exceptional severity as we experienced last spring.

FRUIT-FORCING.

Peaches and Nectarines.—Thinning in the earliest house must be proceeded with gradually, removing a few of the least promising fruits daily, avoiding as far as possible sudden changes; and as bright powerful sun may now be expected, air should be given early and gradually, and be reduced in the same way, as the Peach and Nectarine suffer more from sudden fluctuations of temperature than most fruit trees. It will be necessary for the present, and until after the stoning is completed, to maintain a night temperature of 55° to 60° according to external influences, with a rise of 10° to 15° from sun heat. Syringe the trees twice on fine days, but not when the weather is dull, as the foliage should always be dry before night. The drying influence of fire heat may be counteracted by damping the walls and sprinkling the floors with tepid liquid manure before dusk. Secure a good set in succession houses by distributing the pollen on fine days with a camel's-hair brush, and use little water until the fruit is safe, when directions laid down for the management of the early house will need attention. See that the soil of inside borders is kept thoroughly moist, as the crop is liable to be lost or much injured through these being kept too dry at any time.

Pines.—The short, dark, sunless days of the winter season have a tendency to make the foliage of these plants tender and susceptible of injury from sudden outbursts of sunshine, such as we often experience at this time of year, which will necessitate great care in ventilation. Attend, therefore, to this matter early in the morning by admitting a little air at the top of the house where shading is not employed, so as to dissipate the moisture on the plants before the sun is very powerful. The temperature advised in our last calendar should still be maintained, and the potting of plants referred to therein should still be carried out, no further delay being permitted. See that the heat at the roots is not too powerful, as the heat in the fermenting beds rises rapidly at this season, and the new roots are quickly damaged by too much heat. Pay particular attention to watering, as in this lies the secret of success, the plants being examined at least once a week, and well supplied with tepid guano water as occasion require. Superfluous suckers on fruiting plants should have their centres removed, and an abundant supply of moisture should be provided when

the house is closed in order to counteract the dry atmosphere likely to arise from highly heated pipes. When the beds are heated by means of hot-water pipes, and from being shallow become very dry, take advantage of a suitable opportunity to give the plants and bed a good soaking of tepid water, which will be highly beneficial.

THE FLOWER GARDEN AND PLEASURE GROUND.

Roses and other Climbers.—These are starting into growth much earlier than usual, and the attention they require in pruning and nailing ought at once to be bestowed upon them. Roses especially are growing rapidly, and if not already pruned as previously advised, and early blooms are desired, they need only have all weakly growth removed with superfluous shoots, those retained to be lightly pruned and carefully secured. As most nurserymen can supply all climbing Roses in pots, they may yet be procured and planted in preference to planting in hot positions any that may be lifted from the open ground. A varied and suitable selection consists of Cheshunt Hybrid, Gloire de Dijon, Maréchal Niel, Charles Lawson, Triomphe de l'Exposition, Général Jacqueminot, Duchess of Sutherland, Climbing Devonensis, Madame Berard, Safrano, Souvenir d'un Ami, Du Luxembourg, Triomphe de Rennes, Brennus, Chénéolé, and the white and yellow Banksians. Previous to planting these or other climbers break up the ground where possible two spits deep, and work in a liberal quantity of half-decayed manure and leaf soil. If the balls are then carefully loosened, some of the roots spread out, and the whole firmly covered with good soil, a strong start will be made. Newly planted Roses ought not to be laid-in to their full length and flowered to their full extent, but should either be shortened back freely or disbudded in order to secure vigorous growth; neither should these and other newly planted climbers be nailed to the walls till the ground has settled somewhat, or hanging will result. Such wall plants as evergreen and deciduous Magnolias require little or no pruning, but should have all fastenings made good, and these should be strong, or heavy winds will break the growths. Strips of leather are recommended to be used. Ivies should have all loose growth removed, and this on well-established plants may be pulled off in preference to trimming off with a knife or shears, and the old leaves may be cut off where at all unsightly. A bountiful crop of young leaves will soon improve the appearance of the wall. Lay in the leading growths of Chimonanthus fragrans where required, and cut back all lateral growth, Pyrus japonica to be treated similarly. The branches also of Crataegus pyracantha, Escallonia macrantha, Hibiscuses, and Loniceras should annually be shortened, or they will soon become unsightly and devoid of bloom. Jasminum nudiflorum, and the somewhat similar, though later blooming, Forsythia viridissima, should, after blooming, have all side shoots cut back to near the main branches, and this will result in abundance of flowering shoots for next season's display. All the foregoing climbers, with the exception of the Magnolias, if allowed to become thickets will be greatly improved by being cut down near to the ground, care being taken to properly train the strong young growths that will be produced subsequently. Wistaria sinensis and Bignonia capreolata should have all lateral growths spurred back to the main branches, and the latter properly secured. Similar treatment will be necessary in the case of the common Jasminum and the half-hardy Passion-flowers. The early-flowering Clematises produce blooms on the ripened growth only, and should only have this thinned out and dead growth removed. Included in this section are C. cærulea, montana, azurea grandiflora, Lady Lanesborough, Miss Bateman, and Albert Victor. The later-flowering varieties, of which C. Jackmannii is the best known type, bloom on the current year's growth, and therefore should be freely shortened back as well as thinned out, the aim being to secure the production of strong growths, which will insure a more lengthened supply of large flowers. Among this section such varieties as Gipsy Queen, lanuginosa, Lady C. Nevill, Mrs. G. Jackman, Robert Hanbury, Tunbridgensis, and Velutina purpurea may well be grown.

PLANT HOUSES.

Stove.—Potting in this department may now be advanced with all possible speed. Do not disturb the old balls of such plants as Crotons, Dracænas, Dieffenbachias, Cyanophyllum magnificum, Sphærogyne latifolia, and other similar plants when transferring them into larger pots. The first mentioned can be well grown in rich fibry loam, to which is added a little soot and bonedust. The second and third require a lighter soil—peat and loam in nearly equal parts, with a seventh of decayed manure will suit them. All peat is preferable for the last two, as it does not become sour so quickly. Fibry peat and charcoal should

form the compost for Marantas, which will now require attention. Remove carefully a good portion of the old soil from amongst their roots, and drain the pots in which they are to be placed liberally, as these plants require abundance of water when in active growth. After potting they are benefited by the application of bottom heat, and should be shaded from strong sun until they commence rooting freely. In repotting Alocasias remove the whole of the old compost if in any way decomposed or sour, or they will not long remain healthy. It is a good plan to remove every particle of soil from the plants every alternate year. They require a compost of fibry peat, sphagnum moss, and pieces of charcoal. The pots should be more than half filled with drainage, and the crowns well elevated above the rim. They can be increased by cutting the root stem into lengths, and if plants of good size are required a number of these can be placed together in one pot, placing a little sand round each portion.

Anthuriums, such as A. Warocqueanum and A. crystallinum, require a similar compost to Alocasias, and should have liberal drainage. A. Andreanum does best when more than half the material used for potting is sphagnum moss applied in a living state, and encouraged to grow on the surface. A liberal quantity of coarse sand should be added to the whole of the different composts given above. Before potting see that the plants to be operated upon have a proper supply of moisture at the roots, so that water will not be needed for some days after potting. The temperature should now be raised to 65° at night, and the house kept close for the next fortnight, and sooner than admit air draw down the blinds for a few hours when the sun is bright.

Ferns.—These generally should now be attended to and all old and disfigured fronds removed, repotting and dividing where necessary. It is a good plan to carry out these operations before many of the young fronds are produced, or they are liable to be checked, and in consequence injured. The majority of Ferns do well in a mixture of peat, loam, and sand, the former predominating in the case of dwarf-growing varieties, while a greater quantity of loam can be used for those of robust growth. The small peat that has been shaken from amongst the fibre for several stove plants will do well for all grown in small pots, as well as others of a larger size, if a quantity of rough half-decayed leaf soil is mixed with it. The roots of the plants need not be disturbed where larger pots are needed and the plants are intended to attain a specimen size. Adiantums, Davallias, and others required for cutting and decoration should be grown in as much light as possible, and liberally ventilated when the fronds are attaining maturity, or they will be soft and useless. Where quantities of small Ferns are in daily request for decorative purposes sow spores of Adiantums, Lomarias, Pterises, and others most suitable on the surface of pots and pans filled with a similar compost to that recommended above. Water, after sowing the seed, with a fine-rose can, and place over them a square of glass, and then stand the pans in a moist shady place in a temperature of 55°. Perhaps the best plan to maintain a constant supply of seedlings is to place under the larger plants small squares of turf, and allow them to remain for a time undisturbed until the spores have commenced falling from the plants, and in due time they will be one mass of tiny Ferns. Pteris serrulata spores germinate very freely, and is one of the best and most useful Ferns in a small state that can be grown for furnishing purposes. Keep all Ferns that require heat in a temperature of 50° to 55° at night, those excepted that require stove treatment, for they should be kept at least 5° warmer. Selaginella Brownii, S. densa, and other low-growing kinds should be replanted in pans or other positions in which they are grown annually, or they are very liable to damp off if this precaution be not taken.

THE BEE-KEEPER.

FEEDERS FOR BEES.

THE time has come with some, and ere these lines are in print will come with all bee-keepers, when stimulative feeding should be the rule. Is it still a question how best to accomplish this desirable object? I presume that we are all agreed that it is best to feed from the top; but so far as my small experience goes, a *perfect* feeder is yet a desideratum.

What, it may be asked, are the necessary qualities of a "perfect" feeder? It appears to me that they may be summed up in—first, the power easily to give our bees as much and as little as we please at any time; secondly, the power to prevent robbery during

eeding; thirdly, ease of application. So far as my experience goes, there is the ordinary method of a short wide-mouthed bottle turned up on a piece of perforated vulcanite—the feeder in use at the Hampshire Bee Farm—a complicated yet easily managed affair. It is, in fact, a round tin box with a round hole in the bottom, which hole goes over the aperture in the quilt. Inside is a perforated tin or zinc chimney leading up from the aperture in the bottom, which chimney is surrounded by a piece of wood, and the chimney and piece of wood are covered over by a tin cover with glass top going to the floor of the feeder. The syrup is poured into the open space round this tin cover with glass top. A large cover fits over the whole. There is yet another feeder, that of Mr. Blow's, the expert of Welwyn, Herts; a very ingenious feeder it is in theory, but it has not proved so useful with me in practice. In this feeder a wooden stand goes over the feeding aperture, having the central portion covered with zinc, in which a semicircular piece is cut out. The zinc cap that fits most accurately on the bottle is pierced by twelve holes in a semicircle which, when the bottle is turned over in the frame, fits the slit cut in the zinc. The cover has also a point in the centre, as it were a nail, which fits in a hole in the zinc floor; this forms a pivot on which the bottle turns round, and a point in the cover of the bottle points to figures on the wooden frame agreeing with the number of holes open.

The ordinary bottle and vulcanite fulfils the first condition very satisfactorily. If the vulcanite is pierced with a dozen holes at one end, and with two at the other, any rapidity of feeding can be carried on; but it does not prevent robbery, for if there be any aperture in the cover of the hive, my experience is that wasps will discover it and rob with rapidity. With all my love for the bee, I am free to confess that I agree with Sir J. Lubbock in some things, although I think he rates our pets much too low. I agree with that enthusiastic worker in thinking that the wasp works harder and keeps longer hours than the bee. I fancy, too, that its powers of scent, or the means by which it discovers food, are more developed; and I think I must go a step further and say that I think it shows more sagacity. For instance, how often does a wasp discover this small aperture and find its way in and out, feeding at the feeder intended for the bees? Never in my recollection have I found a wasp dead under the cover, but many a bee; the latter do not appear to me equal to the difficulty of getting out again. To guard, then, against robbing here, I frequently cover my bottle and vulcanite with a bellglass, and so defeat the attack of the wasp. This method of feeding has, too, the merit of economy, it costs but little. The only trouble is the filling and placing. A little tin shovel is the easiest help; but a piece of glass or zinc, or even paper, may be easily made to do duty for the shovel.

The Hampshire bee-farm feeder is, as I have said, easily managed; it is proof against robbers; you can feed as fast as you please, but I cannot see that you can feed slowly and continuously. The orders with it are to feed only at night; but is this a better plan than feeding slowly all the time? The cover of this feeder is not made sufficiently loose. When pushed home it ought to be lifted easily without any shaking of the lower portion. This it does not do, and unless care is taken to hold down the lower portion, it is lifted up and the irritated bees escape: the inside rim, as it appears to me, should be made much smaller, so as not to stick. The inside of the tin-work becomes rusty in spots. Can this have any injurious effects on the bee? for it is difficult to remove, and I have fancied that the bees do not care to take as much then. Its price, 3s., must be a bar to cottagers using it. When it is once filled there is no way of stopping the supply without imprisoning numbers of bees, saving letting the bees finish the amount that has been given.

Lastly, we have Mr. Blow's. The numbers on the wooden frame are not marked sufficiently plain, and the spilling of syrup and moisture resulting from the same have soon obliterated the figures in those I have used. I expected great advantages in this feeder; the bottle is large, the theory of working is capital, but when I turned off one to 0°, which means "no holes open," it seemed to me to lessen, and on careful marking there was no mistaking that it did. Experiments with my other feeders on the same principle all proved a similar result, and I am forced to the conclusion that wherever the index may be the rate of feeding is always the same, dependent solely on the number of bees feeding. The explanation is this: Any person placing a few drops of syrup on pierced vulcanite over a feeding hole may watch the bees sucking through the holes; the tongue of the insect is laid along flat on the vulcanite; this is particularly the case when the supply is scanty. When the supply is shut off (as supposed) by placing the index at 0°, the tongue of the bee is inserted between the two surfaces of zinc, and the syrup is taken just the same. The rate of feeding may be more rapid with the index at twelve holes, but I doubt if it be any faster than with it at 0°. I think this result will be the same in whatever

position the holes may be placed; in fact, it is the flaw in the theory. Capillary attraction will keep the syrup always at the margin, and the bees "all along the line" will do the rest. I hear Mr. Blow has lessened the number of holes. I doubt the success of this alteration. If once the two plates have become moist with syrup the bees will do the rest, and I am not certain that it would not drop slowly of itself were the syrup thin.

At present, then, my experience leads me to the conclusion that as the sheet of vulcanite and ordinary bottle forms the cheapest feeder, so for all purposes it is also the best.—Y. B. A. Z.

TRADE CATALOGUES RECEIVED.

Sutton & Sons, Reading.—*Farmers' Year Book and Graziers' Manual (Illustrated)*.

J. Carter & Co., High Holborn.—*Catalogue of Farm Seeds (Illustrated)*.



* * All correspondence should be directed either to "The Editor" or to "The Publisher." Letters addressed to Dr. Hogg or members of the staff often remain unopened unavoidably. We request that no one will write privately to any of our correspondents, as doing so subjects them to unjustifiable trouble and expense.

Correspondents should not mix up on the same sheet questions relating to Gardening and those on Poultry and Bee subjects, and should never send more than two or three questions at once. All articles intended for insertion should be written on one side of the paper only. We cannot reply to questions through the post, and we do not undertake to return rejected communications.

Books (H. S., and Others).—The price of Mr. Barron's book "Vines and Vine Culture" is 10s.; post free, 10s. 6d.

Cineraria Blooms (C. F., Ipswich).—The flowers sent are fine, and the colour is particularly rich. It is a handsome variety, and well worth cultivation.

Camellias (F. T.).—Concise instructions on the cultivation of Camellias are given in our "Greenhouse Manual," which can be had by post in return for 10d. in stamps. We shall shortly publish an article which will contain information that may possibly be of service to you. The treatment requisite for Camellias, however, depends greatly on the condition of the plants, and if what you find does not apply exactly to yours we shall be glad to give you further advice on our learning their condition.

Pump Water for Plants (Harborne).—You cannot do better than expose the water to the air in an open tank or waterpots for some hours before using, the longer the better. We have often seen plants watered with pump water in better condition than others to which pond water was applied, simply because greater judgment was exercised in the former case than the latter. Even if you fill your waterpots one day, standing them in the house, and use the water the next, you will probably find it answer your purpose if you use it judiciously. Well water varies considerably, some being quite suitable for plants if not applied in a very cold state.

Quilled Cineraria (W. S., Ferry Hill).—You ask if the Cineraria is a novelty and worth saving. It is not particularly novel, but is certainly worth saving, for its beautiful bright shaded blue colour must render it effective for decorative purposes. The character of the flowers may not be exactly the same next year—the flowers may indeed be better on plants raised by offsets, and we advise you to preserve it with the object of testing its merits another season.

Bulbs Failing (F. J.).—If all the bulbs were of the same kind, in the same condition, and planted similarly, yet in one bed they refuse to grow, although the soil is good and the subsoil satisfactory, we should be inclined to think they had been subjected to some interference, either by underground enemies or mischievous individuals. Have you examined the bulbs carefully? This would be the natural thing to do, yet you do not mention it. With the data before us we can afford no solution of the mystery.

Pelargonium Marechal MacMahon (Ignorant).—We are always quite willing to answer all inquiries if questions are framed in an intelligible manner, but yours is very incomplete. You ask, what is "the colour of the flower of Marechal MacMahon?" and without any further information we can only surmise that you refer to Pelargonium President MacMahon, one of the Zonal type, with white flowers, having a pink centre. There is, however, a golden bronze-leaved variety named Marechal MacMahon, which has large rich-coloured leaves. The name Pteris is pronounced teris.

Temporary Vines (R. H. R.).—We quite understand your arrangement. You will obtain heavier crops of fruit, both this year and next, by planting the Vines; and if, as we presume is the case, the roots of your permanent Vines have access to an outside border, there is no objection to your planting them; and even if the border is wholly inside it is not very likely that the permanent Vines would be injured by planting the others. In a case of this kind, however, we should prefer to make the border in sections. A width of 3 or 4 feet along the front would be ample the first year, and further additions of 3 feet yearly would afford the Vines abundant support. If you do not plant you cannot err by following Mr. Bardney's practice of repotting them, provided you can give them the same skilled attention that he gives those under his charge. If you simply stand the pots on the border the probability is that you will only obtain one good crop of Grapes from the Vines.

Begonia Leaves Eaten (H. S.).—We cannot of course say what has eaten your plants, but we think if they were under our charge we could find out the depredators. If you have satisfied yourself that the injury is not done by slugs you may well turn your attention to cockroaches. These pests are very fond of Begonias, and we have known plants injured similarly to those you have sent. Various methods are adopted for destroying cockroaches, phosphor paste being found one of the most effective at Kew. It is spread on pieces of bread and even paper, and placed in their haunts. We have been informed that Dalmatian powder spread in houses or frames infested by cockroaches either kills or banishes them, but we have not tried it. Both these insecticides can be had from chemists. The fact of your Marguerites "suddenly" losing their green colour may perhaps be the result of an overstrong dose of liquid manure. The method you have adopted of making it is correct, but it should be used weak and clear—as bright as pale sherry and of the same colour.

Fertilisers for Plants (Idem).—Nitrate of soda is a very active stimulant, more quick than durable, and must be used only in small quantities; a small thimbleful spread on the soil in a 6-inch pot is ample, or from a quarter to half an ounce in a gallon of water. Bonemeal is less quick in its action but more continuous, and twice the quantity may be used as a top-dressing. It is not soluble in the same sense that the nitrate is. It is good for mixing in the soil for such plants as Pelargoniums, Chrysanthemums, Fuchsias, Begonias, and such others that require support over a long period. A pound, more or less according to the plants, may be mixed with a peck of soil.

"In the Garden" (G. H.).—We are unable to congratulate you on your production, which in its present form is not suitable for publication in any paper, and we think you can occupy your time more profitably than in attempts at writing poetry. We have had several so-called poems sent to us from time to time, but this we think is the most unsatisfactory of all of them. It is weak in language and faulty in rhythm—in fact is not poetry at all, but a jingling conglomeration of incongruities. Ten years hence you will thank us for this reply if you do not thank us now.

Gardenias and Fern Fronds (L. I. K.).—We do not approve of covering Gardenias or any other cut flowers with dry cotton wool, as we know from the condition in which flowers so packed arrive at this office that wool extracts the moisture from the petals. If you cut the Gardenias as soon as expanded and place the stalks in tepid water, then if you wish to take or send the blooms to London secure a little damp moss round the stalks and pack in a close-fitting tin box, they will arrive perfectly fresh, and continue so longer than when dry wool is placed over them. In growing Adiantums for affording fronds for cutting, the plants should have a light sunny position. The fronds will not be so large nor of such a bright green as if grown in the shade, but they will last much longer when cut, selecting those that are mature, not the young soft fronds, and immersing them in water for an hour before using in bouquets. We are unable to say from whence Hyacinth and Orchid seeds can be obtained. You ought, however, to have no difficulty in raising the former, as the plants seed with great freedom, and it matures in a light greenhouse, frame, and as the season advances in the open air. Orchid seed is much more scarce, and much skill and patience are needed for raising plants when seed is obtained.

Cypripedium spectabile (T. Mason).—You have not been misinformed as to the easy culture of this hardy Orchid, nor has its beauty been over-estimated, as it possesses merits which should make it a general favourite; and when its perfect hardiness is taken into consideration with its present inexpensiveness there is no reason why everyone should not possess one of the very best perennial Orchids. The plant is easily distinguished from all others. It grows from 1 to 2 feet high, the stems being more or less covered with leaves of a light green colour, and conspicuously veined. The flowers, which are borne singly, or from two to four on the stems, are very showy; the sepals and petals are spreading, ovate in form, the petals being much the widest, pure white in colour; the lip is very much inflated, of a rich rose colour, sometimes nearly crimson. The soil best suited for it is good peat and coarse sand, with some sphagnum chopped up fine and mixed with the peat. If grown in pots several should be placed in a large pot and kept plunged in moss or fibre in a shady place. When well grown it is a most beautiful plant for exhibition purposes, and it can be readily forced. It can be equally well grown if planted outside in peat and sand in a shady place or on the rockery, where it is quite at home with many of the Primulas, Dodecatheons, and Ferns. It forms a lovely companion for Ferns. The stems springing up from among the light green fronds of the Lady Fern are exceedingly attractive, and the plant thoroughly enjoys such a home. We have had it planted in old stumps, when it seemed to be peculiarly happy.

Thrips on Azaleas (A. S.).—The leaves you have sent indicate pretty clearly that your plants have been seriously infested with thrips, and there are either insects or eggs on the plants now, although we do not observe any on the few leaves before us. Thrips are not difficult to destroy, but one application of any insecticide is quite inadequate for keeping the plants clear. They require syringing periodically with a solution of nicotine soap, Gishurst compound, or soft soap and tobacco water. Any of those ingredients prepared at a strength of 3 ozs. to a gallon of water, in the case of soft soap adding a pint of tobacco liquor, will destroy thrips, and so will petroleum prepared and applied as stated on page 149. The plants should be dipped if not too large; if they cannot be dipped lay them on their sides on a mat, or hold them over a tub, for catching the solution, and syringe them forcibly, turning them round so that the under side of every leaf is thoroughly wetted. Do this once a fortnight, and in the meantime syringe them daily in fine weather until they flower, and again afterwards when making their growth, at which time the insecticides may be further diluted for using occasionally. Remove the surface soil from the pots, and add fresh compost. When we find plants in the condition that yours are we usually find also that they have in other respects been neglected or mismanaged in watering. Be very careful in this respect, never permitting the soil to be really dry before water is applied, then giving it copiously. If the pots are very much crowded with roots a teaspoonful of Standen's manure or a little more of bonemeal spread on the surface of a 6-inch pot once a week and watered in will be beneficial.

Tropæolum Buds Withering (Idem).—As your plant is healthy the flowers will in all probability expand as the weather improves if you assign it a light position in your greenhouse. Baking the compost will improve rather than injure it, and all worms will be destroyed.

Vines Unsatisfactory—Abortive Bunches (J. A.).—Undoubtedly the practice you have described, if we understand it rightly, of steaming the house at night and charging the air with ammonia by the excessive use of guano in the evaporating troughs, is faulty. This with the fumes of petroleum, that appear to have been the result of an accident, would account for the flower buds turning brown "as if burnt," but would not account for their non-formation, and on one of the bunches you have sent no buds have formed. No guano

whatever should be placed in the evaporating troughs of your vinery until the Vines are in vigorous growth, say after the berries are swelling freely after the stoning period. We know it has been used before Vines have reached that stage without any injury resulting, but, on the contrary, with apparent benefit; but it was by gardeners who thoroughly understood what they were doing. In your case we repeat emphatically that it ought not to be used before the period indicated, and you will do well to insist on its disuse at once. Even without the guano such an excess of moisture and an absence of ventilation is injurious, and, except in very bright weather, we would not have a drop of water in the troughs. So far as we comprehend the condition of your Vines it would have been better if there had been no troughs on the pipes. The finest of Grapes can be grown and are produced without them, and, as used by some persons, evaporating troughs do far more harm than good in vineries. To return to the abortive bunches. While, as we have said, they have been injured by the practice alluded to, the initial cause of the curled budless tendrils is immature wood, and this in turn is the result of too much moisture and too little ventilation. When wood is unripe there is no food, or very little, stored in the Vine for sustaining the growth in its early stages, and before supplies are furnished by active roots and prepared by developed foliage. The stored-up sap is thin and watery, and its virtues are soon exhausted, the embryo buds then wither, and flimsy foliage only is produced, which in turn cannot perform its functions, though it endeavours to do so by enlargement and extension, producing a large surface with little substance or texture. Thus persons are deceived as to the condition of their Vines. They point to their luxuriant growth and large leaves as indications of health, whereas they really indicate disease, and such Vines are no more in condition for work—fruit-bearing, than animals are that are unnaturally fed, that are flabby, not firm, and comparatively immovable. Your Vines need more air and less atmospheric moisture, and you will not err by leaving the top ventilators open to the extent of an inch all night, a temperature of from 55° to 60° being maintained, the floors, pipes, and every part of the house to be dry by twilight. As the heat increases in the morning so should the ventilation and moisture, until the maximum day temperature of 80° to 85° by sun is reached. Very little moisture should be afforded with a decline of temperature, and no syringing or damping should be done after the sun has left the house.

Vines in Pots (W. H. P.).—The pots must not be exposed to the full action of the sun, or in all probability they will be of little value for planting after hearing a crop this season. Mr. Bardney has had great success in shifting his fruiting Vines into pots 4 inches larger than those in which they arrived from the nursery. This repotting is done carefully, only removing a portion of the soil and not materially disturbing the roots, the time for the operation being when the canes have fairly commenced growth, yet the shoots not so far advanced as to endanger their being broken off. The soil, both in the pots and that to be employed, is moist without being decidedly wet when the shifting is done. The latter, turfy loam and bonemeal, is pressed very firmly round the other, and water is applied cautiously for a time until root-action is active, which will be known by the foliage changing from a light to a deeper green. From that time the supply must be ample—that is to say, immediately the soil shows signs of crumbling when pressed water must be applied copiously. As the season advances, and the fruit swells freely, water must be given whenever it enters the soil freely. No signs of dryness of the soil must then be permitted, at the same time avoid saturation. If you cannot repot the Vines they will require still more water, with top-dressings of fresh loam and manure, and also liquid manure occasionally after the Grapes have stoned. It will be well to cite what the cultivator named has written on this subject. Such results as he has recorded could not have been attained if the Vines had not been repotted. "Many growers fruit Vines in the pots they were grown in; but I have satisfied myself that this is not the best or most satisfactory system. However good and rich the soil may have been, the young Vine must have exhausted it by the end of the season. Rich top-dressings of soil and manure will certainly help them, with a free use of stimulants every time watering is done, but even this is not sufficient. When the fruit commences colouring liberal quantities of stimulants should be discontinued, or the fruit may possess but little flavour; but aid is actually discontinued under the above system at a time when the Vine requires liberal treatment, and the berries in consequence are comparatively small. I have failed at least to produce Grapes as good in berry and quality generally under the system described as I have by shifting the Vines into pots 4 inches larger than those they were grown in after they were well started into growth. The fresh soil given them will be ample to sustain them until the fruit is ripe, which will be of a superior quality. I have read in reference to Vines in pots, 'Fruit once, and that heavily.' Now the question arises whether it is wise to do this or retain them for a longer period than one year. If cropped heavily they are useless after the first season. If cropped fairly and retained a second year they will produce better Grapes than in the first instance; but to accomplish this successfully they should be planted out in narrow borders of good soil. Experience proves to me that this is by far the most satisfactory system. Some Vines transferred from 10 to 14-inch pots early last year carried an excellent crop of well-finished serviceable fruit. The Vines had six bunches each, the produce of one Vine weighing a few ounces less than 10 lbs. These Vines made fine wood, and were this season planted out in a narrow border of loam, to which was added a little fresh lime and a few small bones. The laterals were about 1 foot in length when the Vines were planted, and extra care was taken that they did not suffer by the want of water. The produce was again weighed from the same Vine, which this year carried the same number of bunches, weighing in all 11 lbs. Other Vines carried a greater weight of Grapes this year than the one alluded to, while none had less than 8 lbs., the number of bunches throughout varying from five to seven, according to their size. The berries were larger than last year, and would have been finer still if we had thinned them more liberally; but from the first swelling we concluded the berries would not be large, but were agreeably mistaken when the roots were fairly established in the new compost. The wood made this year is superior to that they produced last year, is well ripened, and the Vines will, I do not fear, produce some excellent early Grapes again next year."

Names of Plants (J. H.).—The Heath is *Erica carnea*, the Grass is a form of *Poa pratensis*, an extremely useful Grass for pastures. (*G. Hillier*).—We have many times stated that we do not undertake to name varieties of flowers, but only distinct species. Varieties are far too numerous, and many of them too closely resembling each other, to enable anyone to name them with confidence without comparing them with the flowers in a large collection. We can only say that of the Camellia blooms you have sent, No. 1 resembles *eximea*; 2, *delicatissima*; 3, imperfect, possibly *alba plena*; 4, *Beauty of Hornsey*; 5, *Bealif*; 6, *Valtavaredo*.

Removing Bees (W. Henshaw).—Late in the afternoon will be the best time for transferring the bees and removing the hive. If you do this during

the present cold weather, the hive may be placed at once in the required position.

COVENT GARDEN MARKET.—MARCH 7TH.

THE bulk of the late Grapes now coming are very inferior, and prices are unusually low, good examples also being much below their value. Market quiet, with little arriving.

FRUIT.

	s. d.	s. d.		s. d.	s. d.
Apples.....	½ sieve	2 0 to 7 0	Grapes	lb.	2 0 to 6 0
"	per barrel	20 0 40 0	Lemons	case	10 0 20 0
Apricots.....	doz.	0 0 0 0	Melons	each	0 0 0 0
Cherries.....	½ sieve	0 0 0 0	Nectarines..	dozen	0 0 0 0
Chestnuts.....	bushel	10 0 12 0	Oranges	100	6 0 10 0
Currants, Black..	½ sieve	0 0 0 0	Peaches	dozen	0 0 0 0
" Red.....	½ sieve	0 0 0 0	Pears, kitchen ..	dozen	1 0 2 0
Figs.....	dozen	0 0 0 0	dessert	dozen	1 0 2 0
Filberts.....	lb.	0 0 0 0	Pine Apples, English	lb.	1 6 2 0
Cobs.....	100 lb.	0 0 0 0	Raspberries	lb.	0 0 0 0
Gooseberries	½ sieve	0 0 0 0	Strawberries	oz.	1 0 0 0

VEGETABLES.

	s. d.	s. d.		s. d.	s. d.
Artichokes.....	dozen	2 0 to 4 0	Lettuces	score	1 0 to 1 6
Asparagus, English	bundle	12 0 0 0	Mushrooms	punnet	1 0 1 6
Asparagus, French	bundle	25 0 30 0	Mustard & Cress ..	punnet	0 2 0 3
Beans, Kidney	100	2 0 0 0	Onions.....	bushel	2 3 2 6
Beet, Red.....	dozen	1 0 2 0	Parsley.....	doz. bunches	3 0 4 0
Broccoli.....	bundle	0 9 1 6	Parsnips	dozen	1 0 2 0
Brussels Sprouts..	½ sieve	1 6 2 0	Peas	quart	0 0 0 0
Cabbage	dozen	0 6 1 0	Potatoes.....	cwt.	6 0 7 0
Capsicums.....	100	1 6 2 0	Kidney.....	cwt.	6 0 8 0
Carrots	bunch	0 4 0 0	Radishes....	doz. bunches	1 0 0 0
Cauliflowers.....	dozen	2 0 3 0	Rhubarb.....	bundle	0 4 0 0
Celery	bundle	1 6 2 0	Salsafy.....	bundle	1 0 0 0
Coleworts.....	doz. bunches	2 0 4 0	Scorzoneria	bundle	1 8 0 0
Cucumbers.....	each	0 9 1 3	Seakale	basket	1 0 2 0
Endive.....	dozen	1 0 2 0	Shallots.....	lb.	0 3 0 0
Fennel.....	bunch	0 3 0 0	Spinach.....	bushel	3 0 0 0
Herbs	bunch	0 2 0 0	Tomatoes.....	lb.	1 6 2 0
Leeks.....	bunch	0 3 0 4	Turnips	bunch	0 2 0 3



POULTRY AND PIGEON CHRONICLE.

THE POLLED BREEDS OF CATTLE.

THERE are two distinct breeds under this name, one being by tradition and history described as belonging entirely to certain districts and counties in Scotland, the other having been located and peculiar to the counties of Suffolk and Norfolk in England. In order to show how distinct these races of animals may be considered, it is no more than we may expect when we know the great difference in soil and climate which prevails in these districts and their actual position in the kingdom. To enable us, therefore, to treat the subject fairly and do equal justice in describing the qualities and peculiarities of each breed, we propose to notice first the polled cattle of Scotland, which have an origin, rise, and progress distinct from the other breeds of cattle now known in Great Britain. These, however, may be described as two breeds—the Galloway, and the Aberdeen or Angus. We shall, however, give our principal attention to the latter as being the lineal descendants of the ancient polled cattle of the north-east of Scotland—the “Doddies” of Angus, and the “Humlies” of Buchan.

In Youatt's well-known work on “Cattle, their Breeds and Management,” written in about 1835, we find the following statement:—“There have always been some polled cattle in Angus; the country people call them Himlies or doddied cattle. Their origin is so remote that no account of their introduction into this country can be obtained from the oldest farmers or breeders. The attention, however, of some enterprising agriculturists appears to have been first directed to them about 1770 or 1780.” This celebrated authority gives a full description of the Angus Doddies as he found them, and details at length the doings of the first great improver of the breed, the late Hugh Watson of Keillor. All the early writers on the agriculture of Aberdeenshire speak

of the Buchan cattle—those occupying the lower part of the county known as Buchan—as a distinct breed, but in no work dated before the present century have we found it stated whether they were polled or horned, but some writers give a description of the breed, yet make no mention of horns. It is stated by Keith in his “Diocese of Aberdeen,” dated 1730, that the thanedom of Buchan, which originally extended from the river Don to the river Deveron, was so named because it abounded in old pasture and paid its rent in cattle, for the word in the Irish means “cow tribute.” In the recently issued “History of the Highland and Agricultural Society,” Mr. Ramsay gives an extract from the communication he had received from Mr. George Stodart, “lately farmer in Culter-Cullen, Foverham, now (January, 1879) in his ninety-seventh year, and who made his first purchase of cattle in 1801.” Mr. Stodart says—“There were at that time both polled and horned cattle in Buchan, but the horned cattle were mostly in the highlands of Aberdeenshire.”

The writer of some interesting notes on the early history of the polled breeds, which appeared in the *Banffshire Journal* in the spring of 1880, gives much evidence in reference to the existence of the polled breed in Aberdeenshire. He says, “That the late Mr. Marr, Cairnbrogie Tawes, commenced to breed Buchan polled stock in 1810, and exhibited animals of this breed at the Highland Society's shows at Aberdeen in 1834, and Dundee in 1843. The improved polled Aberdeen and Angus cattle are the lineal descendants of that native breed. The two strongholds of the native polls were Angus in Forfarshire and Buchan in Aberdeenshire, the fact being that they are the descendants of one well-defined race—the ancient polled cattle of the north-east of Scotland. In this part of Scotland the lion's share of the farm work now accomplished by horses was done by oxen down to a comparatively recent date—in many parts far into the present century. The native breeds were, however, found to be too small for working-oxen; animals were obtained from the south of Scotland, the Lothians, and from Fifeshire. From this time a cross-breed was sought and obtained for working purposes through the union of the large handsome Fife bulls and the thick low-set native cows, which produced a class of cattle combining the size and power of the former with the excellent beef-producing properties of the latter. They were, however, designated the black horned cattle of Aberdeenshire, and well suited for farm work.

The great improvement of the black polled cattle must be dated from 1808. In that year Mr. Hugh Watson, tenant of the farm of Keillor, Meigle, Forfarshire, laid the foundation of what in his skilful hands became a widely celebrated herd of pure-bred polled cattle. Hugh Watson was a man of much intellect, great perseverance, and correct judgment; and in various ways presenting a striking resemblance to his great prototypes in the Short-horn world, the brothers Collings, who had commenced the systematic improvement of their favourite breed just twenty-eight years (in 1780) before the famous Keillor polled herd was founded. It may be therefore remarked with truth, that what the Collings were to the Shorthorns, Hugh Watson was to the polled Aberdeen and Angus breed. He was the first great improver of the breed, and no one has ever grudged him the credit of that honourable distinction. In the year 1808 Hugh Watson succeeded his father in the farm of Keillor, and among the stock left him were six cows and a bull of the native polled breed. Not satisfied with these as a foundation for the herd he had decided to build up, he in the same year went to a fair at Trinity Muir, near Brechin, and there he purchased ten of the best polled heifers and the best polled bull he could find. It is stated that with these sixteen females and two bulls he founded the celebrated herd of Keillor Doddies.

Of the great success which Hugh Watson achieved as a breeder

of polled cattle we have, perhaps, in the words of the late Mr. William McCombie of Tillyfour, the best testimony; he says, "We all look upon him (Hugh Watson) as the first great improver, and no one will question his title to that distinction, for there is not a herd in the country which is not indebted to Keillor blood." Mr. Dixon in "Field and Fern," says Hugh Watson kept in his eye as models "'Bracelet' and 'Charity,' and one or two more of the pure Booths;" and that "he never scrupled to say that his best cattle showed much of the Shorthorn superiority in hair and touch." His motto would seem to have been, "Put the best to the best, regardless of affinity or blood." He bred from none but the choicest specimens at his command, and did not hesitate to follow the example of Collings, the Booths, T. Bates, and other celebrated Shorthorn breeders in mating animals closely related to each other. It is evident that he practised in-and-in breeding to a considerable extent. It is also clear that he aimed at building up particular lines or families, and that to some extent he bred each of these families within itself. Probably the truest description that could be given of his method of breeding is, that he bred from none but the best—those that came nearest to his ideal—and that he did not care whether these were closely related or not. He, no doubt, discovered that under his improved system of breeding, which may truly be called a system of "selection," and under it he could raise better animals than could at that time be found anywhere else. Now we have quoted largely from the essay by Mr. James Macdonald on the origin and early history of the polled Aberdeen and Angus cattle, as published in the Journal of the Royal Agricultural Society of England in 1881. Although with our long experience in attending the Cattle Shows of the Royal Society, as well as the Fat Cattle Shows of the Smithfield Club when it was held in Baker Street many years ago, and reported the results of various contests amongst the breeders and feeders of the best Scotch polled cattle, and although having acted upon our opinions and estimates, formed as the result of our observations in our own farming practice, yet we could find no more useful style of laying before the home farmer the practice of the best breeders than the source from which we have quoted. We always prefer to quote the best authorities, believing them to be the best guides in connection with our own experience, as the best and safest guide to the home farmer, and also for the benefit of young men studying agriculture, for whom we write, but at all times endeavour to give history credit when it is deserved.

(To be continued.)

WORK ON THE HOME FARM.

Horse Labour.—We finished sowing White Suffolk Wheat the last day of February. This is too late generally, but the land worked close and heavy, which is much in favour of an average plant and produce with late-sown Wheat if the summer is propitious. If the land had been light and free-working, like Barley tilth, we would not have sown Wheat after the 1st of February, for when the soil is light and dry on the surface the Wheat-seeding is never favourable. When, however, it is heavy working, like the usual condition in the month of November, it generally answers. The disadvantage connected with a dry and free-working condition is that the land is not close enough for the roots to hold on well; besides which, it is sure to be more damaged by weeds during the summer, unless it is drilled at 10 or 12 inches apart, so that the horse hoe can be freely used to destroy them; in fact, in a fallow preparation for Wheat the crop is never safe unless the corn is drilled, leaving room for the horse hoe. All sorts of seeds—such as Cabbage, Broccoli, Kohl Rabi, &c., for planting in summer, should now be drilled at 15 inches apart in the lines, on well-prepared and manured beds. The hoeing may then be done, also the pulling of plants, without injury to the remainder. We like to obtain the best and truest seed possible, instead of purchasing plants, for we never can be sure of the sort and purity when they are grown on purpose for sale; besides which, it is a good plan to grow the plants on a well-prepared plot or headland in the field whereon they are intended to be grown. Drege is now more sown than ever, and it is a good plan to sow 2½ bushels of White Waterloo Oats and 1 bushel of Barley, because they can be separated, leaving first-class malting Barley and fair quality of Oats. Barley is now seldom grown alone after roots fed off by sheep, it being almost impossible to secure a good malting sample.

The Beans and Peas have nearly all been sown. The Early Dun or white boilers are best for early crops, and are much in request now, because Early Stone Turnips or Mustard may be grown after early Peas are carted. Spring or summer Tarcs are now being sown. Some farmers recommend mixing the seed half winter and half summer varieties, as they are more proofy for sheep-feeding; but where a heavy crop is expected, a little Rye or winter Barley is mixed with the Vetches to hold them off ground, which is beneficial either for cutting for horses or cattle or for feeding by sheep on the land. We are now preparing land after Potatoes for the White Victoria Oats. As soon as the land has been scarified and the little couch picked off, the land will be ridge-ploughed and sown with these earliest variety

of Oats, the object being an early harvest and full crop. We grew nineteen sacks of this sort last year per acre. It is also favourable for the growth of early Turnips sown between the stooks as fast as the Oats are cut. In some cases, however, we shall seed with red Clover, for we have found that in favourable seasons we can obtain a good autumn crop for cutting up and soiling horses and cattle if the Oats are cut above the Clover. Still it is very rarely the case, as the Oats become ripe before the young Clover seeds get strong.

Planting Potatoes should now be prepared for, having the manure in store ready for mixing, 4 cwt. of Peruvian guano mixed with 4 cwt. of kainit in our experience we find sufficient to insure a full crop and equal in manuring power to any amount usually applied of town or stable dung. The artificial manures are very inexpensive in their application, for our custom is to strew the manure along the furrows in which the Potato sets are planted. Much of the Wheat land being in such a wet state in the autumn that the yard manure, &c., could not be applied, it must therefore now get a liberal allowance of artificials as a top-dressing about the second week of April, of 1½ cwt. of nitrate of soda, 2 cwt. of bone superphosphate, and 2 cwt. of Peruvian guano per acre. This will cost from 60s. to 63s. per acre if genuine, and will be sufficient if the land is clean and in fair condition either after lea or fallow. We have advocated enough dressing for cereals to produce a full crop of straw, which answers well, because the straw alone will more than pay for the manure in most situations.

Hand Labour.—Men will now be required in preparing, mixing, and sowing hand manures; also preparing and cutting the Potato sets, hedge-cutting and tying, also making dead hedges with clean rods and bushes, also cutting and clearing all the hedgerows where cut for hurdle wood, &c., has been going on, also turning and preparing the yard and stable dung intended for the Mangold ground.

Live Stock.—Sheep are now beginning to thrive better, for the weather has been sadly against them where feeding off roots in the open field during the past winter. Good Down mutton is still worth 1s. per pound, and is likely to continue at high prices, the stock is so short in numbers. Beef has paid better than usual for feeding during the past winter, and is now worth from 6s. per stone of 8 lbs.; still the stock if not bred on the farm was bought in at a high price. The lambing time has proved about an average produce of lambs, but rather more than usual have died whilst young. Taking the lambing season as a whole, for the Down and cross-bred flocks it has been better than was anticipated, because of the rainy winter. The lambing of the long-wooled sheep is now going on, but it is too early to say what the result will be; but we hear that many ewes after lambing look extremely thin, and it is expected that some of the flocks in the midland and western counties are suffering from flukes in the liver. If such is the case they will show it more further on in the spring, and large numbers must be lost. We find a great controversy going on as to treatment of sheep when they have flukes in the liver, and we believe that there is no cure; but there is a preventive by judicious management, to which we have often alluded in these columns.

GOAT FARMING.

I HAVE been much interested in the articles you recently published under this head. My object in addressing you is to offer a few words about the Angora cross, and to correct—if I may be pardoned for so doing—a slight mistake. On page 84 it is stated that "those Goats should be selected having the longest hair, as in crossing these nick better with the Angora ram for the growth of mohair." Now a similar idea once prevailed in my own mind; but Mr. Evans, the breeder of mohairs at the Cape already referred to in your columns, informed me that the contrary was the practice there, and for this reason—by crossing with short-haired Goats the wool in the coats of the progeny preponderated over the hair, which was not the case when long-haired she goats were used; thus the shortest-coated animals were selected. Crossing is now, however, very little practised at the Cape, as the pure specimens are much more common.

The Duke of Wellington possesses at Stratfieldsaye herds of both the indigenous Cape Goats and the Cape Angoras, but keeps the two varieties quite apart and distinct, preferring not to cross them. With the clip of these Angoras, and some I sent him from an imported ram I had a year or so ago, His Grace had a quantity of material made, several yards of which he gave me. (A sample enclosed).

Whilst staying at Stratfieldsaye House last year I had an opportunity of inspecting these herds, both of which were doing well and adapting themselves to the climate, but particularly the Angoras. I believe they are still thriving and increasing in number, so that there is no reason why, after all, these Goats should not be bred in England for their fleece, and, if necessary, crossed with British varieties, as suggested in your Journal, to combine fleece and milk. For this purpose no better selection could be made than "Brown Kate," mentioned by the writer of the articles.

I am happy to add that some attention is now being paid to

this subject at Bradford, where a prize for the best mohair or cross-bred mohair Goat is to be offered at the next agricultural show there by a leading manufacturer.—H. S. HOLMES PEGLER, *Hemel-Hempstead, Herts.*

[The sample referred to is silky in appearance, strong in texture, and appears to us a dress material of considerable importance. We have received also the second edition of Mr. Pegler's manual on Goat farming, which should be read by all who are interested in the animals on which it treats.]

PERMANENT PASTURES.—We have received a copy of the thirteenth edition of Mr. Martin H. Sutton's work on "Permanent Pastures," which was originally published in the Royal Agricultural Society's Journal, and has been enlarged to render it still more useful. That so many editions should have been called for is sufficient indication of the merits of this little work, which we have referred to at greater length on previous occasions.

SUNFLOWER CULTURE.—The importance of cultivating the Sunflower as a valuable adjunct to other crops on a farm has been recently mentioned by the press. I am quite willing to make the experiment; but before doing so I should be glad if any of your correspondents would give their experience of the way in which the seeds, flower, and stem are utilised, and also how and when the seed should be sown, and the nature of the soil that suits it best.—C. A. HANBURY.

POULTRY AND PIGEONS

THE DORKING CHALLENGE CUP.

"C." writes hopefully in the *Journal of Horticulture* (page 105) about the Dorkings. I am glad he feels so; would that I did. He notes that there is a falling-off in the Dorking entries. This I take it arises from several causes. One is the craze for size, by which the big mongrel, coarse as he is, wins over the finer-quality bird. Another reason is, that the colour that those who act as judges prefer is much disliked by many, and, therefore, those who do not care to keep the almost black varieties do not exhibit; but the worst of all is, and there is no denying the fact, that dark-legged birds are given the prizes often and often. With unfeigned disgust I have seen this to be the case. There being such a fast-and-loose way of judging people will not send, and if they wish for prizes, as some do, they will scarcely care to keep the breed at all. I have heard such expressions used more than once. Then, again, those who buy prizewinners very frequently find their stock much injured by getting sooty-legged birds. Again I say, as I have said before, "There is no hope for the Dorkings *judged as they now are.*" There are plenty of true, good fanciers who would work the breed up no doubt, but it is not worth their while when the prizes are taken by dark-legged mongrels. I have bred many pure white-legged birds with white toe-nails, and very good table fowls they were. I had one to-day, good in breast, white in flesh; but he would have been "nowhere" under the present way of judging.

There are no doubt places where the old breed is still in existence, and since I last wrote I heard of one, the lady telling me the same breed had been kept on the farm as long as she could remember. I intend going to see them.

"C." says they were more delicate. In this he is in error. I have kept them, and know they were not more delicate than the present so-called Dorking. Also the lady in question told me that she had just been looking at a fine brood of chickens numbering thirteen, and, to use her own words, she said, "It was a pretty sight; they were all so bright and strong." It is not what the judges know about the Dorking; it is how they judge them. They do not judge them to the Standard of Excellence, and, therefore, the Dorking fancy is on the decline, and must be so. No one who happens to have the true breed would, I should think, be foolish enough to buy prize birds at shows now-a-days. I did once, but I do not think I shall ever again. I may; but I must be in a far different frame of mind as regards the exhibition Dorking than I am at present.

There is but one chance, to my thinking, for the Dorking, and that is to judge them by the old "Standard of Excellence." Let there be *coloured* Dorkings, not only Dark Dorkings, and do not let so much as a dark toe-nail be on a prize bird, and let quality be taken into consideration before mere size, and I venture to say that

soon there will be more entries and much finer table fowls when the Dorking fancier knows he can rely on the judges, which most decidedly he cannot now.

When such is the case I for one will be most happy to put down my guinea towards a challenge cup for the Dorkings.

I heartily thank "C." for the courteous reply to my notes, and feel grateful to him for keeping the matter before the poultry world. At the same time I also thank those who have written privately to me on the subject, and I wish to inform them that I shall still do my utmost to put the Dorking breed on its right footing.—HARRISON WEIR, *Brenchley, Kent.*

TABLE POULTRY.

Hints on Fattening and Cooking Fowls. By HENWIFE. James Bolton, 39 and 40, St. George's Place, Knightsbridge.

We have received a copy of a very interesting little work by "Henwife" on the subject of table poultry. The authoress states in the introduction that she pretends to offer neither a poultry book nor a cookery book, but merely a few practical remarks on those portions of both subjects which are most interesting to herself.

"Henwife" is well known as a writer upon subjects connected with practical poultry keeping, and she has devoted special attention to the matter of table poultry. The following is an abbreviated account of her method of fattening, as described by herself. For further particulars we must refer our readers to the pamphlet itself. Should they desire to fatten birds for their own use in really first-rate style they cannot do better than implicitly carry out "Henwife's" instructions.

A separate chamber is devoted to the birds for fattening, so that they may not see other birds at liberty. Each bird has a separate coop, 24½ inches by 16½ inches, with a barred front and a projecting ledge to hold the food troughs. Disinfectants are freely used and cleanliness strictly observed, and when first put up the birds are fasted for a whole day. Those unaccustomed to soft food are broken into the régime by being first given boiled grain. The windows of the fattening house are furnished with curtains, which are drawn closely between each meal, so that the birds spend the intervals not devoted to eating in sleep.

They are fed three times a day, no water is given, and the food is as much varied as possible. The duration of fattening for a bird weighing when put in 5 lbs. should be from one and a half to two and a half months, for larger fowl from three and a half to four and a half months. Large birds should be put in at 7½ lbs. weigh 9½ lbs. to 10 lbs. at the end of their time. The troughs should be soaked in clean water all night to keep them free from sourness.

The pamphlet also contains some interesting notes upon the Paris Exhibition of 1882, with some useful recipes for the cooking of poultry in various ways.

METEOROLOGICAL OBSERVATIONS.

CAMDEN SQUARE, LONDON.

Lat. 51° 32' 40" N.; Long. 0° 8' 0" W.; Altitude, 111 feet.

DATE.	9 A.M.					IN THE DAY.				Rain.
	Barometer at 32s and Sea Level.	Hygrometer.		Direction of Wind.	Temp. of Soil at 1 foot.	Shade Temperature.		Radiation Temperature.		
		Dry.	Wet.			Max.	Min.	In sun.	On grass.	
1883										
February.										
March.										
Sun. 25	Inches. 30.702	deg. 45.0	deg. 43.2	N.W.	deg. 41.4	deg. 50.8	deg. 37.4	deg. 57.8	deg. 37.0	—
Mon. 26	30.665	38.4	38.4	W.	42.6	47.2	37.3	61.8	38.4	—
Tues. 27	30.568	40.3	39.1	N.W.	42.2	49.3	36.8	78.8	33.2	—
Wed. 28	30.513	48.1	47.2	N.N.W.	42.6	57.3	39.8	100.8	39.2	0.130
Thurs. 1	30.447	47.0	45.1	N.	43.5	52.4	41.3	72.2	40.3	—
Friday 2	30.657	39.7	37.5	E.N.E.	43.5	46.9	39.1	80.9	39.2	—
Satur. 3	30.703	38.2	36.9	E.N.E.	42.5	48.7	32.0	82.7	27.4	—
	30.600	42.4	41.1		42.6	50.4	38.1	76.4	36.4	0.130

REMARKS.

25th.—Fair calm day.

26th.—Damp misty morning; fine day.

27th.—Cloudy morning; bright pleasant afternoon.

28th.—Dull morning; bright mild afternoon.

1st.—Dull day, occasional indications of rain; few gleams of sunshine in morning.

2nd.—Overcast morning; cleared about 11 A.M.; fine afternoon and evening.

3rd.—Fine and bright, with cold N.E. wind.

A very fine week, temperature still above the average, and barometer extremely high.—G. J. SYMONS.



15th	TH	Exhibition of Horticultural Appliances, Agricultural Hall, [Islington].
16th	F	
17th	S	PALM SUNDAY.
18th	SUN	
19th	M	Liverpool Spring Show (two days).
20th	TU	
21st	W	

CAMELLIAS.

WHAT Roses are amongst deciduous shrubs Camellias are amongst evergreens—the most handsome and admired of all. They are no doubt less gorgeous than Rhododendrons, but with these they cannot properly be compared, as the latter are essentially grown in the open air for summer decoration, while Camellias are in most districts exclusively flowered under glass in winter and spring. In some favoured localities they thrive in the open air, and are doubtless as hardy as common Laurels. They are too valuable, however, to be subjected to such risks as commoner shrubs, therefore for all practical purposes Camellias are greenhouse and conservatory plants, and undeniably of the first order of merit. They are, in fact, indispensable wherever high-class decorative plants are grown. They are adapted, too, for glass structures of all sizes, attaining on the one hand the character of trees, yet retaining their youthful vigour; while, on the other, they flower in quite a small state as freely as do the older and larger specimens. They are alike suited, therefore, for furnishing the grandest of conservatories and the most unpretentious of amateurs' greenhouses. The plants are withal of easy culture; but before alluding to this more particularly a few condensed botanical and historical notes on this fine genus will not be unacceptable.

The species of *Camellia* in cultivation are few, not exceeding eight, and some of these are comparatively unimportant and very rare, being grown more as curiosities than for any other reason. All are natives of China and Japan, but it is only the varieties of one species that form such beautiful ornaments of our conservatories and greenhouses. As regards the position of the *Camellia* in the vegetable kingdom, it may be stated for the information of our younger readers that it is included in the family *Ternstroemiaceæ*, which contains amongst other genera *Thea*, *Caraipa*, *Cochlospermum*, and *Eurya*, but the nearest relative to the genus under special consideration is the first named, *Thea*, to which, indeed, several of the species of *Camellia* are referred by some authors.

Taking the *Camellias* in the order of their introduction, the first demanding attention is *C. japonica*, which has given rise to the very numerous varieties now grown in gardens. This was known to several of the old botanists, and was described by Linnæus, Kæmpfer, and Thunberg in the eighteenth century. The form that first appeared in this country was the "Common Single Red variety," which was obtained by Lord Petre

in 1739, other forms being introduced at intervals until at the commencement of the present century there were about a dozen in cultivation—a striking contrast with the two or three hundred which are now enumerated in catalogues. Three of the earlier varieties—the double white, double red, and double striped—are supposed to have been introduced by Mr. Main, who was sent out to China as a collector by Mr. Slater of Leyton in 1792. There is, however, some uncertainty as to the number introduced, for Mr. Slater died previous to Mr. Main's return, and the collection had been dispersed. Some cases had, however, been sent to Kew and private gardens, and it may be safely asserted that these were amongst the first of the double forms that reached England. In the second edition of Aiton's "*Hortus Kewensis*," published in 1810-13 eleven varieties are enumerated, comprising the single, semi-double, and double Red, Middlemist's Red, the Myrtle-leaved Red, Anemone-flowered, Pæony-flowered, Double Striped, Blush, Buff, and Double White, most of which are figured either in Curtis's "*Botanical Magazine*" or Andrews' "*Repository*." To these a twelfth, the Pompon *Camellia*, is added in Edwards's "*Botanical Register*" for 1815. It was then a novelty, and though its white double flowers tinged with crimson at the base of the petals are pretty, they cannot be compared with the symmetrical and delicately tinted varieties we have now in such abundance.

The number of forms was gradually increased, and in Don's "*History of Dichlamydeous Plants*" (1830) twenty-four varieties are described as having been introduced from China, and fourteen as seedlings raised in Britain. From that time there has been a continual steady advance, the continental growers—particularly in France and Italy—having given much attention to the raising of new varieties, until the total has become almost formidable, and the amateur cultivator who desires only a few select forms is at a loss what to choose where so many are good. Comparatively few additions are, however, now made; and, in fact, there is little room for them, unless they take a step in the direction of the much-coveted "blue *Camellia*," which, like the blue *Dahlia* and blue *Rose*, has yet to be obtained.

Turning to the other species, the next in chronological order is *C. Sasanqua*, which, by the way, is considered by many writers as belonging to the genus *Thea*. This is described in Thunberg's "*Flora Japonica*" (1784), and an illustration is given which fairly represents its characters; and in the "*Botanical Register*" for 1818 is also a very good figure. It was introduced in 1811 from China through the East India Company, and first flowered in Sir Joseph Banks' conservatory at Springrove. The flowers are small, 1 or 1½ inch in diameter, with irregular pure white petals and small lance-shaped or ovate bright green leaves. In Sir George Staunton's description of Lord Macartney's embassy to China the following interesting particulars are given of this plant:—"A plant very like the Tea flourished on the sides and tops of the mountains, where the soil consisted of little more than the fragments of stone crumbled into a sort of coarse earth by the joint action of the sun and rain. The Chinese call this plant *Cha-whaw*, or Flower of Tea, on account of the resemblance of one to the other, and because its petals, as well as the entire flowers, of Arabian *Jessamine* are sometimes mixed amongst the

Teas in order to increase their fragrance. This plant yields a nut from which is expressed an esculent oil equal to the best which comes from Florence. It is cultivated on this account in vast abundance and in situations fit for little else." The double-flowered variety of *C. Sasanqua* was imported for the Royal Horticultural Society by Captain Drummond in 1823, and first flowered three years after. It is even prettier than the single form, the flowers being neatly semi-double, with rounded substantial white petals.

Passing several other species of little importance, *C. reticulata* is the next worthy of notice. This handsome *Camellia* was introduced by the London Horticultural Society through Mr. J. Parks in 1824, but the first flowers were produced by plants in the conservatory of Mr. J. C. Palmer at Bromley. It is of similar habit to *C. japonica*, but is distinct from it in the more lanceolate and tapering neatly serrated dark green leaves and the large crimson flowers, the irregular petals of which are veined with a darker shade. A large specimen of this fine species is particularly handsome, and such a one as that formerly at Bank Grove, Kingston, is seldom seen. Mr. Donald describes this in the *Cottage Gardener* for 1853 as "the Lion of Surrey," and states that "it was purchased by Sir John Broughton about the year 1835 from Mr. Smith, the celebrated *Rhododendron* crosser of Norbiton, along with *fimbriata* and *Woodsii*. He had them planted in a house by themselves, this house being the middle one of the range; the width in the centre is 22 feet, and the length along the wall 20 feet. The Lion of Surrey now occupies the whole of this space, so that we cannot pass along the circular paved walk in front without being partially shaded by the upper branches." He further states that the plant was 24 yards in circumference, and had nine hundred flowers open at one time, about three thousand having expanded during the season.

Referring to the culture of *Camellias*, it is scarcely necessary to enter into details of propagation, as ninety-nine out of every hundred private growers purchase plants. We have both raised stocks from cuttings and attached to them, by grafting, the best varieties; but it is, as a rule, far better to let nurserymen who have special conveniences for the work establish the plants, especially as they can do this without any great outlay, and healthy examples of good varieties are consequently the reverse of costly. Briefly it may be said, for the information of those who desire a little knowledge on the subject, that cuttings of matured growths with a heel of the previous year's wood emit roots the most freely. They are inserted as closely together as possible in well-drained pots of sandy soil in September, placed on ashes in a cool pit or frost-proof frame, shaded as needed and kept moist. There they remain until the spring, and there they may remain until rooted, though they are often placed in a little heat after growth commences. Eventually they are potted singly, and when established and growing freely they are partially cut down. Scions are attached to them by taking a slice off the bark of both stock and scion, fitting the two together, securing them with matting, and covering with moss or grafting wax, and keeping them in a close propagating case until the union is complete. The growth of the stock is then gradually reduced and shortly removed down to the scion, which now and onwards appropriates the whole of the supplies of the roots. This is propagation in a nutshell;

but, as before observed, it is better to purchase established plants.

Are home-raised or imported plants the most desirable to purchase? is a question often asked. The truth must be told on this matter. Healthy free-growing plants raised in English nurseries are far more likely to succeed in the hands of the majority of amateur cultivators than imported plants are. The latter plants are often luxuriant, yet almost as often deteriorate when placed in English greenhouses. The change of treatment and locality is too sudden and great for them. After these plants have been prepared for a year in our nurseries, acclimatised, they do very well afterwards; but cheap imported *Camellias* are often dear in the end. In purchasing *Camellias*, then, the safe course is to obtain established plants from home nurseries, giving preference to those raised there, provided—and this is important—they are free and kind, a stunted home-raised plant being decidedly inferior to a free yet sturdy acclimatised foreigner.

It has been said that *Camellias* are easy to grow, and they certainly are when the plants are healthy to begin with; but stunted, scraggy, half-starved plants with brown-blotched leaves, dry and harsh, are not easy to manage, and cannot quickly be restored to health and vigour. Many of such plants can be improved without doubt, and even some be transformed into handsome specimens; but time and skill are requisite for effecting this desideratum.

But what is the reason of so many *Camellias* being in the unsatisfactory state indicated? The initial cause in not a few cases is commencing with immature strong-looking but really weak, because plethoric, plants, and then treating them wrongly. They have had generous treatment, specially prepared soil, pots packed with roots, so as to endure any amount of water, liquid manure periodically, and a very moist position, either in pits or shaded places in the open air, and too often have been so drenched and saturated in the autumn as to cause incipient decay of the roots. Place such plants on an open stage in a dry and draughty greenhouse, and note the results. The very life of the plants evaporates through their great broad leaves; pale brown blotches appear, which spread, the edges of the leaves curl back, and eventually the foliage withers and falls, and as there is no stamina in the plants they cannot put forth fresh strong growths. This is the treatment accorded to the majority of such plants by amateurs, and it is wrong. If they re-pot the plants as soon as they arrive, as many do, this makes matters no better, but rather worse; for they disturb the roots and have no compensating advantage, for the roots will not move under those conditions. Such soft pampered plants, which have been treated almost as semi-aquatics, must not at first be placed on lattice-work stages in dry houses, but have a sojourn on moist ashes in a pit or frame, and be very gradually inured to the differing conditions under which they are intended to be grown. It is not suggested that all foreign *Camellias* arrive in a half-succulent state, but vast numbers are in the condition described, and it is well to know what to do and what to avoid under the circumstances.

Now to another class of plants—those that were healthy once but are now unsightly. What is the cause of the change? Overpotting, with over-watering immediately afterwards, have together formed the first

step on the road to ruin of hundreds of plants. Camellias are water-loving plants undoubtedly—their white, fleshy, Hyacinth-like roots tell us this, but stagnancy they abhor. Even a Hyacinth will not grow in mortar, and a Camellia's roots are far more sensitive. If there is a suspicion of saturation or sourness they are poisoned, turn brown at once, lose their absorbent power, and the plant starves surrounded with plenty.

In potting a Camellia let the pot be as small as possible—only just large enough to admit the roots, with the necessary space for pressing down the soil. This is the safe course to pursue. Let the soil be moist when used, but not decidedly wet, that already surrounding the roots to be in exactly the same condition. Press the new soil as firmly as the old, and do not bury the stem too deeply. Syringe the plant and pot three or four times a day if needed, shade it, do everything to retard the first watering, yet do not permit the soil to be dry. The object should be to induce the roots to move before water is applied. This secured, the rest will be easy. Apply water judiciously, yet increasingly, as the growth and season advance, and when the pot is filled with roots and the drainage ample, as it must be, the supplies can scarcely be too copious. The soil, then, must always be moist—not sometimes only, but constantly, even if water has to be given twice or thrice a day; and if something more is needed top-dress with soot and bonemeal alternately for sustaining or enriching the colour of the foliage. This is better than constant shiftings from pot to pot. There is no fear of saturation in the growing season if the pot is crowded with roots and the drainage thoroughly efficient, but it never will be full of roots if the plant is first overpotted and the new soil is rendered stagnant at once. This is the real root of the matter, and should not be overlooked.

The importance of a moist atmosphere for Camellias making their growth is not sufficiently recognised. In the great Camellia house in Messrs. W. Paul & Sons' nursery at Waltham Cross, the gravel over which the plants are arranged is often almost in a state of puddle, and there is not a dry stage in the house. Under these conditions they luxuriate, and by subsequently ripening the wood they flower profusely. This is a school of Camellias, and its teachings as to varieties useful to all who may visit it before the season is over. Notes on varieties and other matters pertaining to Camellia culture must be deferred.

BOOKS AND READING.

HARDLY any other profession, perhaps none, has such a number of periodicals devoted to its interests, and few, if any, can show such a number of books as have been written to further its progress, as horticulture. This being so, readers may wonder what literary wants there can be; indeed it seems as if the literature of gardening had been, in some directions at least, overdone. In some instances this is really the case, and we want a weeding-out of books on some subjects.

It is time that everyone was impressed with the fact that the day of encyclopædias is gone. It is impossible to teach anything more than the merest outlines of gardening between the boards of one book. Half a century ago it might be done, but the subjects are now so very varied, and gardening has assumed so many phases, that it is now impossible. Nor is it desirable, even if it were possible, for the young possessor of such is too often deceived into believing he has under one title all he need know of gardening as far as books can teach. If in practice he really finds it so he will either remain far

down the gardening scale, or he will be such a genius as gardening has not yet produced, and is every day less likely to do. It is far better to form a library of "one subject" books, for these exhaust the subjects they treat on. Moreover, when only one book on one subject is had at a time that subject is likely to be thoroughly studied; but when books giving only the outlines on many subjects are purchased nothing is studied or everything is devoured, and the result is disappointing. Then, suppose a special subject requires special study. Suppose the young man is suddenly required to supply Mushrooms or Tomatoes or Strawberries at seasons that he has hitherto not been accustomed to supply them. He turns to his one-and-a-half or two-guinea volume and finds it fails him; he already knew as much or more than he finds there. Then he finds that it is better to spend 1s. or so on manuals detailing the routine of men exactly in his position. He finds he can learn more of the Vine in Barron's, Taylor's, Thomson's, or any other good manual; of Orchids in Williams' manual; of hybridising and propagating in Burbidge's "Cultivated Plants;" of fruit in Hogg's manual, and so on. And then he only buys what he wants, and, above all, studies, as we have said, only one subject at a time.

If we cannot advise young men to possess themselves of encyclopædias, because we think they can do better, still less can be said in favour of epitomes. For those who are content to "know a little of everything" they may do, but for the would-be successful gardener they are worse than useless—they deceive. He must know "everything of something," and that something is gardening, and this he will never learn from epitomes.

There is another class of books that we dislike. They are what may be called catalogue-books—a few pages of general encyclopædia-like instructions are given, and the bulk of the volume is merely a tradesman's catalogue amplified; indeed in some respects it is inferior to such, for every year makes it less complete. A real catalogue is acceptable, but a catalogue in disguise commends itself to few.

While epitomising is condemned the value of condensation is not ignored. Much information is buried among "padding;" many books are quite needlessly bulky. They may be like undressed heaps of grain—there may be nothing but grain—but much of it is light and might have been separated from the heavy with advantage—nay, much is positive chaff. This is partly owing to the fact that the most valuable gardening works are by men who are gardeners first and literary men afterwards. But some gardeners are gifted with much literary ability, and deliberately put in the chatty chaff to swell the volume to a little more than pamphlet size. When this is in the catalogue form it is not only useless but unutterably dull, for this is the resort of the literary nobody. Even when it is interesting chat it is still useless, and worse for those with small incomes, for it is expensive, having to be paid for. While, then, epitomising is condemned, condensation is urged; it is only when overdone that the latter can be objected to. It is well not to ignore details; it is not well to introduce side issues or foreign matter.

The price of gardening works is often complained of; the great expense of getting up a really valuable work is forgotten by such complainers. They forget that authors have to be remunerated, and that publishers have to be recouped for their outlay and get a profit beside. When it is otherwise books will cease to be issued, writers will cease writing, and publishers publishing. Still, cheaper gardening works, if sound, would prove a boon, for gardeners' purses are small, and it is only by much self-denial that the young gardener can form a fairly good library; but this self-denial is itself of the greatest value, and knowledge can never be valued by *£ s. d.* Were the demand greater possibly good books might be cheaper, but beware of trash.

Libraries in gardens are clamoured for. That such may sometimes do good is undoubted, but the book from the library is seldom valued at its worth; and it is seldom studied—it is read once and replaced on the library shelf, and another taken down. This is itself an evil. John Ruskin insists that his books shall not be sold cheap, if they were they would be less valued. There is much in this. The book that is saved for

is sure to be studied, and the book that is our own is sure to be read and re-read till its contents become part and parcel of one's self. While, then, we are sure that the young man who acquires a library slowly, and studies slowly but surely, is sure to become well informed and reap the full harvest in due time, it is also certain that the bookless truster to libraries will have scant information, and that of a vague confused sort that will avail him nothing.

Are libraries for gardeners, then, useless? By no means; indeed, we very much wish there were a central library to which gardeners could subscribe and have the chance of perusing books otherwise quite out of reach. Ordinary works should have no place in such, for the reasons given. But what a boon if from such rare and costly works on scientific subjects bearing on gardening, as well as works not to be had in the trade, could be procured. Though any gardener may form a really useful library, and by its means become possessed of knowledge quite invaluable, even from the money now wasted in tobacco, beer, and other indulgences (even books of not a useful kind), yet it is impossible that even the most careful and the most studious gardener can get all the books he would like. The writer is just in that position for one, and he and doubtless many others would gladly contribute a moderate sum to a library formed for such a purpose.—SINGLE-HANDED.

CAULIFLOWERS AND BROCCOLI.

To think of writing anything original on a subject of this kind would appear to savour of presumptuousness, seeing that they have now been cultivated in our gardens for two or three centuries. Be that as it may, and divesting myself of all thoughts of being able to write anything which is not already known, perhaps a gentle reminder or a few useful hints to the younger members of our craft may not be thought to be out of place. Although botanically speaking the Cauliflowers and Broccoli are regarded as being distinct varieties of the same species, they are so much alike in all points, except perhaps in degree of hardiness, that it is difficult for anyone other than a strict botanist to avoid thinking that one name might do for both. With this, however, cultivators have little to do and need not concern themselves, as it is sufficient for them to know that in the Cauliflowers and Broccoli they have vegetables which in usefulness are probably second to none, seeing that by a proper selection of sorts and timely forethought in sowing the seed they may be had every month in the year. Not only may they be had in every month, but an enthusiast might go further and have them every day in the year; it is only a question of numbers and a little management in lifting and affording protection in severe weather.

The Cauliflowers we will take first, and may say that for an early supply—say May and June—there is no longer any necessity with existing varieties for autumn sowing and wintering in frames, a practice which was followed by those who have gone before us, and indeed is still adopted by the great majority of practitioners of the present day. First on the list of early varieties stands Veitch's Early Foreing. Sow seed in heat the first week in January, and when they have formed their leaves prick out the seedlings in boxes; harden them when large enough, and plant out on a warm south border towards the end of March from a foot to 15 inches apart each way, protecting with Spruce branches on frosty nights until they have taken well to the soil. The latter to produce good heads cannot well be made too rich. By planting out an equal number of the largest and smallest plants from this sowing—or indeed succeeding ones—a succession may be had for the best part of a month. To succeed the above make a sowing of Early London and Walcheren at the same time, also in February, and a last one in March on a south border; these will continue the supply till July. For a further supply in August—a month in which Cauliflowers are sometimes scarce—sow Autumn Giant in heat at the same time as Early Foreing, and treat in the same way. Successive sowings of the same variety made at the end of February, in March and April, will satisfy demands to the end of November, and the following month the Broccoli will be ready for use.

With these we need not enter too minutely into details, a selection of one or two varieties for each succeeding month till June being all that is really requisite, beyond saying that two or three successive sowings should be made in April and May. For cutting in December and January the following can be relied upon:—Veitch's Self-protecting, Osborn's Winter White, Snow's and Backhouse's Winter White; for February and March Dilcock's

Bride, Adams' Early (an excellent sort when true to name), Cooling's Matchless, and Purple Sprouting. In April, May, and June we have the undermentioned—Suttons' Protecting, Cattell's Eclipse, Wilcove White, Carters' Champion, and Model. Were I to state all I think of the latter variety I am afraid some of your readers would think me guilty of undue flattery; enough for me to say that with us it has never suffered any injury from frost, and that it maintains the supply well into June.—ET CÆTERA.

GLADIOLUS CULTURE—HYBRIDS OF GANDAVENSIS.

I MUST confess I should have been better pleased as an ardent admirer and grower of the Gladiolus to have found (*vide* page 178), that Mr. Banks of Sholden, near Deal, had lost his enormous stock of so many thousands through having them injured by frost, because the remedy would have then been easy. "D., Deal," has, however, snatched away that crumb of comfort, and says the cause must be sought elsewhere. As communicated to the Editor I made the statement on excellent authority, in fact I received a second note to this effect—"I have noticed 'D., Deal's,' reply to your inquiry, page 157. . . . I must repeat, I visited Mr. Banks's garden some three years since. He kindly showed me his system of propagating the choicer hybrids of *G. gandavensis*, and remarked, 'Unfortunately I have lost a large number of my choicer Gladioli through the severe frost coming on before I had lifted the bulbs.'" Losing "some" and losing "all" are, however, different things, so that all may be right in a sense.

It has been suggested to me, as this is the planting season, that I might be able to do more service towards extending the culture of this glorious autumn flower by referring to whatever measure of success I had last year, and the system of growth by which it had been attained, than by a useless and discouraging discussion of "failure." I only hesitate because I have often done so before, and will now only premise that I do so without any intention of setting my opinion or experience in opposition to any older or better grower.

The finest spikes I had last year were from Lord Newport (Kelway). The spike, or stem rather, came double, and one opened after the other. This corm that did so well was comparatively small, not more than one-fourth the size of Dr. Hogg, which only gave one middling spike, and half that of Armide, which I lost. The next best was La Quintinie, kindly presented to me by a French grower with others of less merit, had three spikes—not usual—two of them double, and with twenty and twenty-one perfect blooms. If I were to name another almost equal it should be Cherub, if I remember rightly one of Kelway's. I do not so much notice those of the crimson or scarlet type like Meyerbeer, that always do well and are ever increasing; but others, like Flora, Sir Massey Lopes, La Fiancée, Acme, and that rich favourite Mr. Derry, often capricious, were almost as tall and very effective. I was fairly pleased with my results so far, as the season was not as favourable as usual, until I went up to the Royal Horticultural Society's Autumn Show at Dublin. The silver-cup stand here contained some magnificent spikes. I had to run across to England that evening and took no notes, but I believe I am correct in saying from memory—in the absence of any report in the gardening journals—that this belonged to J. F. Lombard, Esq., South Hill, Rathmines, near Dublin. I have no hesitation in saying several of the spikes equalled the best I saw at the International Show at Manchester the previous year, and (again quoting from memory), among those were Duchess of Edinburgh, which I am trying this year, and Rhamnes.

So much for some of the more satisfactory results, but there are also failures, but still unaccountable. Mr. Thornton declined to move at all; Agrius would only stir after being taken up, potted, and put on a hotbed at first; while Armide and Madame Desportes bade me a long farewell. I do not know if other growers find, as I do, a greater mortality among white and shades of white; but these are small losses, and should only increase the enthusiasm of a real lover of the Gladiolus. I must, however, say a few words on culture before closing. There is no time now to debate as to manuring and preparing the ground in autumn. If the soil is loose and friable bury a quantity of old decomposed manure a few inches beneath the corm, put a handful of sharp river or road sand on this, or with some rich loam or old cow manure pulverised. I always have sand of this kind above and below the corm for with ordinary garden soil, and though many say to bury the corms 6 inches, I consider 3 or 4 amply sufficient. I believe many of the more delicate hybrids are buried so deeply that they cannot mature. Now this question of imperfect maturation to my mind contains the secret of the so-called degeneration. The commoner practice is to enjoy the flowering and take no further care. Twenty

seed pods, say, are allowed to fill, though no seed may be wanting, and growers complain of exhaustion. Of course it is exhausting, and the wonder would be if it were not so with this treatment. I feed all the better hybrids at least once a week with liquid manure, not merely during flowering, but during subsequent growth, and I remove every seed pod I do not want, and never leave more than one on each spike. Hundreds can be thus attended to in a few minutes a few times each week. If they are not worth this care, then there should be no complaints if there are failures. If there are trees to shade them, then there can be no proper maturation of the foliage, nor consequently of the young corm.—W. J. M., *Clonmel*.

EURYA LATIFOLIA VARIEGATA.

AMONGST ornamental-foliage greenhouse plants that adorn our glass structures, few, if any, deserve a place in any garden more than the subject of this note. It is easily propagated and grown, and anyone possessing a plant would, I am sure, soon be tempted to increase their stock. For room-decoration and mixing with flowering subjects for the conservatory it is invaluable. Through the summer months there is never any difficulty in finding ornamental-foliage plants for the conservatory, but such is by no means the case through the winter, as many conservatories are not kept sufficiently warm through the winter to admit stove plants to be introduced. In such cases the *Eurya* is very useful. *Euonymus* can be, and are, used rather extensively for winter work, and are well adapted for the purpose, but the more the variety the greater the attraction.

Well-grown plants of *Eurya* are very telling arranged amongst other foliage and flowering plants, the habit being compact, foliage large and beautifully variegated. The groundwork of the foliage is green, occupying more than half of the entire leaf, running irregularly on each side of the midrib towards the outer edge. The margin of the leaves are a beautiful creamy white running irregularly towards the midrib, the outer edge being invariably spotted with bright pink. Cuttings strike readily, selecting the half-ripened wood in autumn, and potted in a peaty soil with plenty of sand. The cuttings should be placed in bottom heat and kept close for a short time. In about three months or a little more the cuttings will be well rooted, and may be placed into large 60-size pots, using plenty of peat in the soil. When the pots are well filled with roots the plants can have another shift, and so grown on to the desired size.—G. WALTERS.

POTATOES FOR TABLE AND MARKET.

(Continued from page 193.)

In the following notes the figures 1, 2, and 3 indicate first early, second early, and late varieties; the months the time of planting; and the asterisks those varieties that are considered the best for market purposes by the respective cultivators.

KENT.—1. February. *Old Ashleaf, Rivers' Royal Ashleaf, Jackson's Improved, and *Covent Garden Perfection. Soil.—Good friable rich loam, subsoil pure yellow loam. 2. End of March or first week in April. Woodstock Kidney, *Beauty of Hebron, Pride of America, and Suttons' Reading Russet. 3. First week in May. *Magnum Bonum, *Schoolmaster, *Scotch Regent, and Suttons' Reading Hero. Manures and Application.—The only manure I use is well-decayed horse and pigs' dung, with a good sprinkling of ashes from burnt rubbish. The manure is applied early in the autumn, and dug-in in dry weather where practicable. For late strong-growing sorts no manure is applied. General Culture.—Magnum Bonum is one of the best late Potatoes in cultivation, keeping in a sound condition up to the middle of June; but it is not thought much of by many as a garden Potato owing to its producing so much haulm. I find they do much better when planted late after the Broccoli comes off, and without any manure. I find the crop much better; they are a much cleaner sample, the quality of the Potato is improved, and they keep better. These remarks have reference only to the garden. Reading Hero was planted last year in the same way, when it produced a fine crop of first-rate quality; but planted the previous year in March on well-manured ground the crop was almost useless for the table, and nearly spoiled two other varieties that were planted on each side of the row through the haulm growing over them.—J. MATTHEWS, *The Gardens, Woodstock Park*.

1. First week in March. *Myatt's Ashleaf, *Veitch's Improved Ashleaf, and Porter's Excelsior. Soil.—Medium. 2. End of March or first week in April. *Schoolmaster, Beauty of Hebron, Late Rose, and Vicar of Laleham. Soil.—Medium. 3. First week in April. *Magnum Bonum, *Scotch Champion, *Dunbar Regents, and *Paterson's Victoria. Soil.—Heavy. Manures and Application.—Farmyard manure with a coating of lime or soot. General Culture.—The farmyard manure is applied as a winter dressing in the kitchen garden. Lime and soot are dusted in the drills at planting time with the sets, and carefully forked in with a two-pronged hoe. The two latter not only act as a stimulant, but help to keep down insects, and the tubers

turn out much cleaner. Magnum Bonums, Scotch Champions, &c., are planted 15 inches asunder in rows 3 feet apart. Veitch's Ashleaf and Schoolmaster are planted 1 foot asunder in rows 2 feet 6 inches apart. The above distances I find are not too great, as it is well known that where close planting is practised and the haulm becomes crowded the disease is sure to appear, and the crop in many cases are completely ruined. I plant most of mine 3 feet 6 inches apart and the above distances asunder to allow for winter vegetables to be planted between; in this way the Potatoes do remarkably well, as also do the Brassicas.—R. PHILLIPS, *The Deodars Gardens, Meopham*.

LANCASHIRE.—1. March from 7th to 20th. Old Ashleaf, Mona's Pride, and Veitch's Improved Ashleaf. Soil.—Light, resting on a red sandstone formation. 2. Last week of March to the first week of April. Rivers' Royal Ashleaf, Myatt's Prolific Ashleaf, Snowflake, and Bresee's Prolific. 3. From 20th to the end of April. Schoolmaster and Magnum Bonum. Soil.—Medium and heavy land; the former being very good in the garden on light soil. Manures and Application.—The manures used for first and second earlies are old Mushroom beds, half-decayed leaves, wood ashes, and old potting soil well mixed when sufficient; if not, cow and horse manure mixed and dug into the ground before planting. For the early kinds the above mixture is placed in the trenches, and the sets laid amongst it. For late varieties, cow, horse, and sawdust manure are mixed together and placed in the drills previous to planting the sets. General Culture.—The early varieties are planted in sheltered warm positions and well grown before planting, which applies to all except the late varieties. When the shoots are above the ground they are protected until frost is past, generally by placing the soil over them or clean straw. The sawdust manure is considered very good, and liked much on the farm here where the late varieties are grown where they have to be planted on heavy land.—WILLIAM BARDNEY, *Norris Green, West Derby, Liverpool*.

1. Middle to end of March, and the same for the second earlies. *Myatt's Prolific Ashleaf and Mona's Pride. Soil.—Heavy. 2. International, *Schoolmaster, Dalmahoy, and *Gramplan. 3. As early in April as possible. *Scotch Champion, *Magnum Bonum, and Paterson's Victoria. Manures and Application.—The manures are leaf soil and wood ashes mixed, and applied with the sets at the time of planting (for the garden). The late sorts are planted in the usual way with foldyard manure. General Culture.—Our soil is so very heavy that none but the strongest varieties are grown. Scotch Champion and Magnum Bonum are largely grown by farmers for the Liverpool market; the later sort procures the highest price.—THOMAS ELSWORTHY, *Court Hey, Liverpool*.

LEICESTERSHIRE.—1. Middle of February. *Early Hammersmith, Veitch's Improved Ashleaf, and Rivers' Royal Ashleaf. Soil.—Medium. 2. The last week in February if weather and soil are suitable. *Early Rose, *International, and Woodstock Kidney. 3. The first week in March. *Suttons' Magnum Bonum, Schoolmaster, Bresee's Prolific, and *Paterson's Victoria. Manures and Application.—Farmyard manure. All ground intended for Potatoes is manured during the winter and thrown into ridges the width required for planting, or as near as it can be done. The Potatoes are planted between the ridges and covered with the soil from the ridges. For the strong growers, such as Magnum Bonum, the ridges are made the same distance apart as for the earlies, about 20 inches, and they are planted between alternate pairs of ridges. The manure I formerly used, and which I prefer for heavy soils, but which I am unable to get now, is a mixture of leaf soil and soot. The leaves were gathered in the autumn and brought to a large heap in a cart with high side boards, and trodden firmly; to each of these was put one sack of soot. These were turned twice during the winter and well mixed at planting time. This was placed along the bottom of the trench and the Potatoes set on it and covered in the usual way. I usually have the Potatoes earthed-up as fast as the growths advance in the spring. The first named in each class are by far the best Potatoes here in all points. I have some other varieties that I think may prove better than those mentioned when they have been thoroughly tried.—JOSEPH LANSDELL, *Barkby Hall*.

1. From March to May. *Myatt's Prolific Ashleaf and Mona's Pride. Soil.—Light and medium. 2. York Regents. 3. *Champion, Regents, Magnum Bonum, and Paterson's Victoria. General Culture.—The ground is double dug, and farmyard manure is placed along the second spit. The drills are drawn 36 inches apart, and the sets laid in 18 inches asunder. I consider Champion the best Potato because it has the best flavour. Magnum Bonum will however, I think, be the most profitable to grow for market purposes because it is more generally liked. Magnum Bonum can be hoiled with their "jackets on," whereas Champions are best peeled before cooking and steamed. There is certainly more waste in paring Champions, but then they are always less in price, so that when put upon the table they are quite as cheap as Magnums, drier, and more mealy.—THOS. PICKWORTH, *Loughborough*.

LINCOLNSHIRE.—1. First week in March. Myatt's Prolific Ashleaf. Soil.—Light. 2. From March 20th to April 6th. *Magnum Bonum and Scotch Regent; both also excellent for main crop. 3. From March 20th to April 6th. Champion. Manures and Application.—

I use kainit and any manure containing nitrogen, which is cheap, according to quality, and farmyard manure as much as I can spare. On light lands I prefer deep ploughing.—ISMAEL FISHER, *Scawby, Brigg*.

1. Middle of February. Walnut-leaved Kidney, *Mona's Pride, Myatt's Prolific, and Rivers' Royal Ashleaf. Soil.—Old kitchen garden soil of a light character. 2. Middle of March. *Early Rose, Breadfruit, Lapstone, and Covent Garden Perfection. 3. Middle of April. Schoolmaster, Paterson's Victoria, Magnum Bonum, and *White Rock. Soil.—A medium yellow loam resting on limestone. Manures and Application.—For first and second earlies farmyard manure is dug in during winter, and at planting time ashes are placed in each trench or row. For late varieties farmyard manure is ploughed in fresh in autumn. At planting time the land is drawn into ridges with a ridging plough. Malt dust is then applied at the rate of a ton and a half to the acre. General Culture.—Malt dust has been used here for a number of years for the late Potatoes, and with such good results, both as regards crop and quality, that I feel satisfied a better manure for this crop cannot be easily found.—WILLIAM WRIGHT, *The Gardens, Bransdon Hall*.

1. End of February, on south borders. Early Bird, *Veitch's Improved Ashleaf, *Mona's Pride, and Rivers' Royal Ashleaf. Soil.—Good garden soil. 2. Middle of March. Myatt's Prolific Ashleaf, *Covent Garden Perfection, *Extra Early Vermont, and Grampian. Soil.—Medium. 3. Beginning of April. *Champion, *Magnum Bonum, Dunbar Regent, and Paterson's Victoria. Soil.—Light medium. Manures and Application.—For garden cultivation ashes from refuse are mixed with a fourth part of lime, sprinkled in drills before planting. For field culture 12 tons of old farmyard manure and 3 cwt. superphosphate per acre are applied to the drills before planting. General Culture.—Early Potatoes are kept during the winter in shallow boxes or on shelves. In a cool place I plant medium-sized whole tubers, which I consider better than very large or small sets. For field culture the same remarks apply. Early Potatoes are planted in rows 2 feet apart, 1 foot between the sets. Medium and late varieties are planted 3 feet between the rows, and 1 foot between the sets. I grow over one hundred varieties, and I do not find any of the new varieties equal to our well-tried Potatoes for quality and quantity.—DAVID LUMSDEN, *Bloxholm Hall, Sleaford*.

1. Middle of March. Veitch's Improved Ashleaf, Mona's Pride, Porter's Excelsior, and Dalmahoy. Soil.—Light loam. 2. Middle of April. Gloucestershire Kidney, Yorkshire Hero, Snowflake, and Fortyfold. 3. Middle of April. Paterson's Victoria, Schoolmaster, York Regent, and Magnum Bonum. Manures and Application.—Half-decayed farmyard manure, and used as dry as possible at the time of planting.—J. GARDNER, *The Gardens, Elsham Hall, Brigg*.

MIDDLESEX.—1. March 28th. Myatt's Prolific Ashleaf, Suttons' Fillbasket, *Early Rose, and *Shaw. Soil.—Medium; subsoil heavy, well drained. 2. March 22nd. Woodstock Kidney, Covent Garden Perfection, *Beauty of Hebron, and *Dalmahoy. 3. March 15th. *Reading Hero, *Magnum Bonum, *Schoolmaster, and Red-skin Flourball. Manures and Application.—I find horse manure the best, dressing it in the autumn, laying the ground rough that it may be well pulverised. Cultural Remarks.—I prefer drawing drills with the hoe, the distance apart varying from 2 to 3 feet according to the growth of the varieties, choosing medium-sized tubers for planting, leaving one eye, or if large cutting them to single eyes. I prefer shallow planting and forking between the rows before earthing the tubers, for planting ought to be laid out thin in an airy place that their shoots may not be drawn up weakly.—PHILIP C. CORNISH, *The Shrubbery, Enfield*.

1. Second or third week in March. *Veitch's Improved Ashleaf, Myatt's Prolific Ashleaf, and Beauty of Hebron. Soil.—Medium. 2. Third week in March. *Prince Arthur and *Magnum Bonum. 3. Third week in March or first week in April. *Paterson's Victoria, Schoolmaster, and *Dunbar Regents. Manures and Application.—I plant all the Potatoes between ridges that have been made for about four months. When I level the soil between the ridges to the depth of 6 or 7 inches and plant my sets 3 feet wide, 15 or 16 inches from set to set, I then place long stable manure on the top of them, and cover them in with the hoe. General Culture.—I plant my late Potatoes on land that has previously been trenched for Peas, which I plant 7 feet apart from row to row, with a row of Spinach along the centre. I then plant Broccoli 2 feet apart each side of the Spinach, and as I take off the Peas a row of Broccoli is placed in. I take those up about the end of October and lay them in to be protected during winter. I then ridge up the ground. At the end of March or first week in April level the soil between the ridges. My sets are then planted, those about the size of an egg uncut, in 3 feet, in width 15 or 16 inches from set to set, I then put a little long stable manure on them. I have the best crops on a change of seed. I would change seed every year if possible.—DANIEL SNELLING, *The Gardens, Laleham House, Staines*.

1.—From the middle of February to the middle of March. Veitch's Ashleaf, *Cosmopolitan, Huntingdon Kidney, and Myatt's Ashleaf. Soil.—Our earliest Potatoes are grown on a piece of old garden that has been under cultivation nearly fifty years. The soil is thoroughly pulverised with constant cultivation, and liberal dressings of leaf soil and light manures. In this soil the tubers grow quickly, and they

are always good in quality. 2. Middle to end of March. *Covent Garden Perfection, Woodstock Kidney, Beauty of Hebron, and American Purple. Soil.—The soil in our largest garden is rather heavy, and stands on a bed of clay. Ground intended for Potatoes we dress with fine ashes, and turn it up roughly in ridges during the winter. At planting time we give the ground a light dressing with lime, and then fork down the ridges, thoroughly blending the lime and soil as the work proceeds. 3. Second week in March to end of first week in April. *Paterson's Victoria, Schoolmaster, and Vicar of Laleham. Manures and Application.—I am not an advocate for applying rank manures in the cultivation of the Potato. On our soil I find nothing to equal lime, wood ashes, and sand for giving clean tubers of good quality. General Culture.—In the cultivation of the Potato I attach more importance to well-worked land and wide planting than all other cultural details. At planting time the ground should be as light as it is possible to make it, and the tubers should be covered very lightly, and before the final earthing the whole of the ground between the rows ought to be carefully forked over to bring it into proper condition for placing round the stems of the Potatoes.—J. ROBERTS, *Gunnersbury Park, Acton*.

MONMOUTHSHIRE.—1. March. Veitch's Improved Ashleaf, Early Hammersmith, Dwarf Top Ashleaf, and Early Bird. Soil.—Light. 2. March and April. Covent Garden Perfection, Stratton's Seedling, King of the Potatoes, and Myatt's Prolific. Soil.—Light. 3. April. Rector of Woodstock, Magnum Bonum, Scotch Champions, and Paterson's Victoria. Soil.—Medium. Manures and Application.—Farmyard manure is employed.—A. S. WOODS, *The Gardens, Tredegar Park, Newport*.

1. End of March. *Veitch's Improved Ashleaf and Early Shaw. Soil.—Heavy, subsoil marl, and the same for all the sections. 2. Early in April. Gloucestershire Kidney, Flourball, and Rector of Woodstock. 3. Early in April. Fluke, *Schoolmaster, and *Magnum Bonum. Manures and Application.—Stable manure for the preceding crops, with lime and burned rubbish previous to planting. General Culture.—We select plots of ground for the main crops of Potatoes, which have been double dug and heavily dressed with stable manure the preceding season for Peas, or some other similar summer crop. As soon in the autumn as these crops are cleared off the ground is again double dug, and left exposed to be pulverised by frosts during the winter and early spring months, until a short time previous to the planting season, when it receives a dressing of unslaked lime and charred rubbish, which is hacked into the surface. At planting time the ground is dug in the ordinary manner and well broken, and as the digging proceeds the Potatoes are planted in rows, the early varieties 2 feet apart, the later and strong-growing stools are allowed 6 or 9 inches more, and all kinds are covered with about 4 inches depth of soil.—THOMAS COOMBER, *The Hendre Gardens*.

NORFOLK.—1. March. Old Ashleaf and Veitch's Improved Ashleaf. Soil.—Medium loam. 2. April, first part. Porter's Excelsior, Early Goderich, Schoolmaster, and White Elephant. 3. Latter part of April. Magnum Bonum and Scotch Champion. Manures and Application.—A good coat of farmyard manure in the autumn, 20 loads per acre applied to ordinary agricultural land the first season; 20 bushels of soot per acre, and 3 cwt. of Horsfield's Mangold manure applied just before earthing up. General Culture.—We have the last two or three years grown for first crop and forcing the old type of Ashleaf. We had lost it for several seasons, but fortunately secured a true stock of it again, and believe now there is nothing amongst newer kinds to surpass it, especially for flavour, when new. It is also very productive. Porter's Excelsior is a real acquisition, excellent in every way; very free from disease. For the farm this season we shall only plant Magnum Bonum. We secured last year a very fine crop of handsome tubers of first-class quality. Scotch Champion, on the other hand, is not so productive; it makes too much top, and exhausts the soil before the tubers are formed. We dress our Potatoes with soot and Mangold manure just before earthing up, after the horse hoe has been through twice, as by this time the haulm is well developed and the tubers forming, in preference to sowing it in the rows at planting time; as these stimulants, if applied at that stage, force an abnormal growth of haulm. We always find we get a heavier crop of sound tubers when the sun can shine between the rows.—WM. ALLAN, *Gunton Park*.

1. Middle of February. Mona's Pride, Old Ashleaf, and Myatt's Prolific Ashleaf. Soil.—Light, black, sandy soil; cold, wet, sandy subsoil. Dry very quick in summer. 2. Middle of March. Extra Early and *Vermont. 3. From middle to end of March. Late Rose, *Schoolmaster, and *Magnum Bonum. Manures and Application.—As a rule I never apply manure for Potatoes, but plenty of manure from linings of pits, &c., is dug in the bottom spit when bastard-trenching for other crops. General Culture.—Crops generally are large but never quite free from disease. The old-fashioned plan I adopted more than a quarter of a century ago I still practise. I plant whole sets, large ones, a yard each way apart, these grow the largest crops.—HENRY WRIGHT, *The Gardens, West Harling Hall, Thetford*.

1. March. Early Ashleaf and *Myatt's Prolific Ashleaf. Soil.—Light. 2. March. Woodstock and Ashtop Fluke. 3. April. *Magnum Bonum, Schoolmaster, and *Walker's Regents. Manures and Application.—Farmyard manure is applied at the rate of 30 cubic

yards per acre, well dug in about December or January, and a little wood ashes sprinkled in the rows when planting.—W. SHINGLER, *Melton Constable*.

NOTTINGHAMSHIRE.—1. March. Rivers' Royal Ashleaf, *Beauty of Hebron, *Early American Rose, and Early Racehorse. Soil.—Light, black. 2. April. Covent Garden Perfection, *International, *Late Rose, and Porter's Excelsior. Soil.—Medium. 3. April. *Magnum Bonum, Schoolmaster, Suttons' Reading Hero, and *Red-skinned Flourball. Manures and Application.—Last year I used soot as a fertiliser. This was applied by hand between the rows just before earthing up. The quantity so applied was a moderate sprinkling, and as a result we had an exceedingly fine crop of sound tubers. This year I am using lime. I applied this in January, and I may add I have no doubt the results will be equally satisfactory. General Culture.—The preparation of the sets is a very important matter, for upon this depends in a great measure success or failure. It is my practice to pick out what sets I think will be required as early as convenient after the tubers are lifted. The set thus secured is placed in single layers in a dry room where frost can be excluded, the object being to secure strong sprouts by planting time. I never sprout seed Potatoes. Indeed, with such treatment it is not necessary. The next most important matter is the time most suitable for planting. Providing the seed is, as it ought to be, in good condition, nothing is gained by planting too early. Again, the soil here is so various, as it undoubtedly is in most gardens, that to attempt to grow Potatoes in some of it would be folly. In planting my mode of procedure is as follows:—To begin with the early ones. These are planted in lines, the lines being and the sets 18 inches apart. We make a trench with the spade and place the sets carefully into it, covering the same about 2 inches in depth with the soil out of the next trench. The later sorts are treated in the same manner, with this exception—the lines and the sets are placed further apart. This varies of course with the sorts of Potatoes grown and the kind of soil they are to be grown in. Magnum Bonum, for instance, requires with me 2 feet 6 inches between the lines, and 2 feet between the sets. Champion and other large haulm-producing sorts require even still more room. The after-treatment consists in keeping them free from weeds, and earthing up when sufficiently advanced in growth.—JOSEPH RICHARDSON, *The Gardens, Calverton Hall*.

A NOTE ON HOLLYHOCKS.

It is not yet too late to propagate these, the best way by far being to graft the young growths on to pieces of roots. Cuttings will strike, but at this season the process is a very slow one and failures are common. A point of importance is to keep the young plants from becoming root-bound in small pots. When healthy, Hollyhocks are vigorous root-producers and will require, if strong, to be transferred into 7-inch pots before they are planted out. The compost should be of strong loam enriched with a third part of cow manure and a sprinkling of half-inch bones. The compost can hardly be rendered too firm. A cold frame is the best place to keep the plants, giving them protection in cold weather, and in warm weather allow them plenty of air. From the middle to the end of April is a good time to plant them out, protecting them on cold nights by placing a large flower pot over each.

The disease (*Puccinia malvacearum*) was very destructive during the past year, though in the previous season we had the plants clean. Dry hot weather is apparently a suitable atmospheric condition for the propagation and extension of this destructive fungus. I know of no cure or means of lessening its effects on the plants.

For those who wish to grow a collection of named varieties a short list is appended of the best:—Alba superba, Cygnet, Flora Macdonald, Hercules, In Memoriam, J. M. Lindsay, Mrs. Downie, Memnon Improved, Octoroon, Perfection, Purple Prince, Queen of Buffs, Queen of Whites, Queen of Yellows, Stanstead Rival, Tecoma, William Thomson.—R. P. B.

CHOICE HARDY PLANTS IN FLOWER.

Scilla bifolia and Varieties.—This is an extremely pretty species, coming in a little before *S. sibirica* outside, and is perfectly hardy, while the simple means by which it may be well grown are points in its favour. It has one-sided spikes of bright blue flowers, not so large as those of *S. sibirica*, and more open. Some distinct forms I have now in flower are particularly showy and worthy of mention. Alba is similar to the type, but the flowers are quite white, as its name implies; this is very desirable. *Atrocærulea* produces numerous flowered spikes of a deep cerulean blue colour, and is very striking; *rosea* has rose-pink flowers, and resembles the type in disposition; *grandiflora* resembles the normal form in the floral arrangement, but the individual flowers are very much larger and brighter in colour; and finally, *corymbosa* pro-

duces copiously flower corymbs of deep blue flowers, and is very handsome, as, indeed, all of them are, and outside, even in the untoward climate of Cheshire, they are thriving remarkably. As I intimated above, they are most easily grown, requiring only to be planted in moderately light and rich soil. In clumps they look extremely pretty, but I have some of them planted in crannies and nooks of the rockery, and they materially assist to enliven it during the month of February.

Sisyrinchium grandiflorum.—A very charming little plant, apparently as hardy as any of our indigenous species, as I have known it stand in most exposed situations even through severe winters. Of course the beauty of the plant is retained for a much longer period if a sheltered position is found it, free from driving winds and heavy rains. It has Grass or Rush-like foliage about 9 inches high, and the flower stem is usually rather taller, one or two-flowered. The flowers when expanded are about 1½ inch across, with six equal divisions of a clear purple colour, more or less oblong, and shortly acuminate at the apex. The divisions of the white-flowered variety (*alba*) are lanceolate without the distinctly formed apices of the typical form, in all other respects it is similar. They are both beautifully in flower now, although rather early for this part of the country. Their precocity has undoubtedly been accelerated by the exceptionally mild winter we have experienced and the spring-like weather of the last two or three weeks. There is no difficulty attending their cultivation, as they thrive with the same treatment afforded *Scilla bifolia*. Planted in masses they look very pretty. To produce the most charming effect they should be planted together, so that the distinctly coloured flowers intermingle.

Muscari Heldreichii.—The first Grape Hyacinth to bloom with us here, and a very pretty one it is. The flower spikes are about 1 to 2 inches long, thickly set with small pitcher-shaped flowers; the dilated portion of a bright sky-blue, while the slightly spreading limb is pure white, the contrast being striking and pleasing. The Grape Hyacinths are favourites of mine, and as they expand I shall make a few remarks upon them for the Journal. *M. Szovitzianum* will be the next in bloom, and it is also pretty.

Chionodoxa Lucilia.—A most beautiful bulbous plant and deservedly popular. I enjoyed a rich feast at the end of February of seeing some thousands in flower at Messrs. James Dickson and Son's nursery at Chester, and understood there was no difficulty attending its cultivation. In my experience the bulbs improve greatly after being planted a year or two. I have some bulbs which were imported in 1881, and have been in the ground ever since, have now eight, nine, and one with ten flowers on single spikes; while those bulbs imported in the autumn of 1882 produce but one or two, rarely three, flowers: and the individual flowers of the former are very much larger and of a better colour than the latter, so we may hope it will be a bulb which will improve with us. It is most easily raised from seed, which should be sown so soon as it is ripe, and it may germinate the same year; but the following spring the plants will come up thickly, so do not introduce your seed pans to the rubbish heap if your patience is worn out, as a crop is certain. Some pans of seed sown last June are now filled with young plants as thickly as they can exist without inconvenience. It enjoys a light rich soil with a sunny aspect, when it will produce a very charming effect yearly.

Galanthus Elwesii.—I have had a large number of this elegant Snowdrop in flower this season, and to my mind it is the best of them all. Of one thing I am certain—it is the most variable, for there have been some most remarkable forms among an importation of last year, as well as among some bulbs obtained from Asia in 1881—flowers with very narrow petals; in fact, I have seen every intermediate form of perianth division, from the spherical characteristic type of the species to one not more than an eighth of an inch in diameter, and one bulb produced flowers with the three outer divisions sharply reflexed like those of *Narcissus triandrus*. This I hope to watch another season, and if the same peculiarity is revealed it will indeed be a most desirable deviation. However much the form of the flower varies, there is always the distinct band of green at the base of the inner divisions of the perianth, intercepted by a white band from the blotches of green near the notches at the top of the divisions. Out of several hundred bulbs I have only one bulb which has produced what I regard as the typical flower of *G. Elwesii*, and by which Mr. Baker characterised the species, and this came to me by accident among *Chionodoxas*. In outline the flowers are almost globular, while the outer divisions are nearly round, contracted sharply at the base. In this form it is most distinct.

G. Redoutei, or what is really *latifolius*, has large deep green leaves, with small *nivalis*-like flowers of a very thin texture.

G. plicatus, the Crimean Snowdrop, has *nivalis*-like flowers in form, but larger, and the green of the inner perianth divisions

extends from the top to the base without interruption, while the margins of the leaves are distinctly folded, as its specific name implies. It is remarkable that the green colouring of the inner division should be so constant in each species, differing in each. I have examined a large number of flowers in each introduced species, and found them all constant in this respect, however much they varied in other details.

Hepaticas.—These are amongst the most beautiful of early spring flowers, and are admirably adapted for borders, rockeries, and spring bedding, and it is a marvel that we do not see them more frequently. They are really old-fashioned flowers, and there are many old country gardens where they exist in abundance. The forms of *H. triloba*, red, white, and blue, are all very pretty. The double forms of the former and latter are most useful, although the double blue is rather scarce. There is, as far as I know, no duplex white variety, which is a pity. Barlow's single blue is large and of good substance, with broad petals, but there is an endless variety of colour in them, particularly among collected species from their natural habitats. *H. angulosa* is really the best blue. The flowers are much larger than those of *H. triloba*, resembling a miniature Clematis, of clear sky blue colour, and very lasting. The plant is floriferous and hardy—points which render it a favourite with all who see it.—CESTRIAN.



NOTES AND GLEANINGS.

WE are glad to find that the ROYAL HORTICULTURAL SOCIETY is about to resume its PROVINCIAL SHOWS. An invitation has come from the Mayor of Birmingham for the Society to hold a great show there in July next, and with the assurance that a complete guarantee against loss would be raised. The matter was submitted to the Council on Tuesday last, and the invitation accepted, a committee being appointed to conduct the arrangements with the Birmingham committee. We are rejoiced to see the Society again turning its attention to national horticulture, in which alone its mainstay is to be found, and by which its greatest prestige is to be maintained. The Show will be held in the Lower Aston Grounds, as on the former occasion in 1872. These Grounds are now in the occupation of Mr. Reeves Smith, and the facilities for the transmission of goods and passengers are now very much increased to what they were before, when the Grounds were occupied by Mr. Quilter.

— AT a General Meeting of the ROYAL HORTICULTURAL SOCIETY held last Tuesday, Maxwell T. Masters, Esq., M.D., F.R.S., in the chair, the following candidates were unanimously elected Fellows—viz., Professor Allman, F.R.S., Wm. Cornwall Cowley, William Fish, Joseph Fromow, W. Ferdinand Hensley, Charles C. Laing, Arthur H. Lancaster, Donald Larnach, Mrs. Edward Lushington, Joseph Marten, Mrs. Frances Mitchell, Hugo Müller, M.D., F.R.S., James O'Brien, George Paul, J. T. Rogers, Dr. C. William Siemens, F.R.S., Harry Smith, Joseph Stevenson, B.A. (Secretary Agri-Horticultural Society of Madras), Edward William Thompson, Mrs. James Walker, Thomas Walker, F.L.S., R. E. Webster, Q.C., Coventry A. Woodhouse.

— THE FARNINGHAM ROSE SHOW is fixed for Thursday July 5th of the present year.

— MR. JOHN NUNNS writes—"In your last issue I read with great interest the article on lifting VINES in March. I compliment Mr. Bardney on his success, and should be glad if he would kindly state the age of the Vines at the time of lifting."

— MR. G. SUMMERS, The Gardens, Sandbeck Park, Rotherham, sends us a box of unusually handsome blooms of MARIE LOUISE VIOLETS, which he states were gathered from a cold frame covered with 6 inches depth of snow. The flowers were exceedingly fine, indeed we have never seen better, and we should

be glad if Mr. Summers would describe the system of culture which has produced such satisfactory results.

— WE are not over-sensitive on the question of the ABSTRACTION OF ARTICLES FROM OUR PAGES and inserted in other papers without acknowledgment, and it is only in a flagrant case of this kind that we make any reference to the matter. This week we have answered a correspondent on another page in a manner in which we think no exception can be taken by unprejudiced readers, and there we had intended the matter to end. Since, however, that reply was given our attention has been drawn to another paragraph in the same issue of the *Garden* that has undoubtedly been obtained from our columns, page 12, vol. iv., the issue of January 5th, 1882, yet not acknowledged; and still another half column appears from an article originally published by us in our issue of January 4th of the present year, and the author's MS. of which is in our possession. Having regard to the extraordinary fact that all these extracts should appear in one article in another paper, we are justified in asking "F. W. B." why one paragraph extracted from a contemporary should be acknowledged, while for three which he takes from our pages for making up the same article no acknowledgment is vouchsafed?

— MR. CHARLES BATESON, writing in an answer to a question about DESTROYING INSECTS ON MUSHROOM BEDS, observes—"If sugar and plaster of Paris are mixed together in any proportion, strewn about an inch high all round the top of the bed, the insects will speedily disappear, at least I have found this simple mode very efficient. They eat it for the sake of the sugar, and I suppose the plaster of Paris must harden in their stomachs and so kill them."

— MRS. E. MILES, the widow of the late Mr. W. Miles of The West Brighton Nurseries, who died on February the 4th last, has issued a circular stating that she intends carrying on the business as before with the assistance of her son and daughters, retaining the services of the whole of the principal men as foremen, shopmen, clerks, &c.

— MESSRS. KAY & SON have sent us a sample of INDIAN MUSLIN, which appears a very suitable material for shading in summer and protecting the blossoms of fruit trees in spring. For the latter purpose it would not require to be rolled up, as, while it would afford shelter against ordinary spring frosts and sharp winds, it would also admit light and air to the trees. Though very light it appears strong, and is worthy of a trial in gardens.

— AT a meeting of the Kingston-on-Thames Chrysanthemum Society held last week, the question of the NOMENCLATURE OF CHRYSANTHEMUMS was under discussion, and the following resolution was agreed to:—"This meeting resolves that a sub-committee of six members and the Secretary, Mr. Jackson, be appointed as a conference to discuss the nomenclature of the incurved varieties of the Chrysanthemum, with a view of settling the confusion which now exists, and that invitations be sent to the *Journal of Horticulture*, *Gardeners' Magazine*, and the *Gardeners' Chronicle* to send representatives on that conference; and that the Editor of the *Journal of Horticulture* be asked to furnish copies of the election and subsequent correspondence which has appeared in that paper for the use of the members of the conference." The members elected on the sub-committee are Messrs. Beckett, Croxford, Hinnell, Lyne, Moorman, Orchard, and Shepard. Mr. Moorman to represent Mr. Jackson as Secretary of the Conference. This is a step in the right direction, and it will be well if it leads to the publication of an authoritative descriptive catalogue of Chrysanthemums, which is quite as much wanted as was the catalogue of Roses of the National Rose Society, and would be equally well received by admirers of the popular autumn flower.

— THE LONDON ROYAL BOTANIC SOCIETY'S EXHIBITIONS for this year will be held in the Botanic Gardens, Regent's Park, as follows:—Spring shows, March 28th and April 25th; summer shows, May 16th and June 13th. Evening Fête and Exhibition, June 27th, and a special show of Roses by Messrs. W. Paul & Son, Waltham Cross, May 2nd to 10th. Botanical lectures will be held on Fridays in May and June at 4 P.M., and promenades on Wednesdays in May, June, and July at 3.30 p.m. Liberal prizes are offered at all the shows, the provision for Orchids, Pelargoniums, stove and greenhouse plants, Roses, and fine-foliage plants being especially good.

— WE have received the following communication in reference to A NEW PUBLIC PARK AT BEDFORD. The Corporation of Bedford, having recently decided to appropriate 61 acres of land adjoining the cemetery for the purpose of forming a public park, offered a prize of twenty-five guineas for the best set of plans for laying out the same. The Park Committee met on Friday last, and unanimously decided to adopt the plans of Messrs. Barron and Son of Elvaston Nurseries, Borrowash. The site is admirably adapted for a public park, the ground sloping gradually to the south. The prize plans provide for a piece of ornamental water in the south-east or lower portion of the park about three acres in extent. Large open spaces are devoted to cricket, football, and parade ground. The two main entrances are at either end of a new road 100 feet in width, which the Corporation propose to construct along the southern boundary of the park. A refreshment pavilion surrounded by a flower garden occupies a conspicuous position, leading from which is an avenue of Lime trees terminated by a fountain. Tennis lawns, bowling green, archery ground, and a gymnasium are provided, also designs for an entrance lodge, band stand, rustic shelters, &c.

— RELATIVE to the distribution of AURICULA SEED on behalf of "Single-handed," we found that to have sent the seed in the order in which the letters were opened would have placed applicants in distant parts of the country at an unfair disadvantage, as the letters of many, even if sent immediately on receipt of the Journal, could not possibly reach us the same week. We determined, therefore, to distribute the seed as equitably as possible on Tuesday night, returning stamps to those to whom we could not send the number of packets desired. The demand has very far exceeded the supply, and we have been compelled to return the whole of the stamps, less one in each case for postage, that reached us on Wednesday morning.

— WE learn from the schedule to hand that the MANCHESTER NATIONAL HORTICULTURAL EXHIBITION will be held in the Botanic Gardens, Old Trafford, from May 11th to 18th of the present year, when the usual liberal prizes will be offered in seventy-nine classes for plants, flowers, and fruits. Orchids are well provided for, eight classes being devoted to them, the prizes ranging from £16 to £2, one class being for ten *bonâ fide* specimens, in which "made up" specimens will disqualify the exhibitor. Stove and greenhouse plants, fine-foliage plants, Pelargoniums, hardy plants, and miscellaneous collections all have special classes devoted to them. There is an announcement in the schedule to the effect that a new exhibition house one-third larger than the old one has been erected, and the Council are desirous that the first show held in the new building shall be a very fine one; they therefore invite exhibitors to aid them as much as possible.

— DURING the past week THE WEATHER has been unusually severe, and has seriously interfered with garden and land work generally. Low temperatures, keen winds, and several falls of snow have had a most injurious effect upon the advancing vegetation, though probably the results would have been worse a week or two hence. Around London the fruit trees appear to be scarcely sufficiently advanced to suffer much injury, though the

bracts surrounding the Pear buds have been much browned in several cases. This is very observable in the Royal Horticultural Society's Garden, Chiswick, where also a few early Peaches seem to be in danger. The effects, however, cannot at present be accurately estimated. At Chiswick the lowest temperature registered was last Thursday and Friday, when the thermometer fell to 21° Fahr. As, however, will be seen from the following notes, much lower temperatures have been experienced.

— MR. W. TAYLOR of Longleat Gardens writes:—"We are having a veritable winter here, and coming when the Peach trees are in bloom it is rather awkward. Our minimum temperatures 4 feet from the ground from the 7th to the 12th inclusive have been 26°, 25°, 24°, 17½°, 18°, and 22°. On the grass it was 24°, 22°, 21°, 11°, 12°, and 17°. Ice is 1¼ inch thick; we purpose carting some to-morrow should the present weather continue. There was ice inside the glass of all our hothouses on the 10th, and some shoots of Vines almost in flower in an old-fashioned house, where the trellis is too close to the roof, were frozen to the glass. A few of them which the sun touched early have the appearance of being scorched, but they are not so much hurt as I imagined they would be. The thermometer in this house did not go below 54° during the night."

— MR. G. ABBEY, Paxton Park Gardens, St. Neots, also writes as follows respecting THE WEATHER—"On the night of March 10th 15° of frost were registered here, the temperature falling to 17° Fahr. The last few days have been very cold and the ground covered with snow; on the 8th it lay 4 to 6 inches deep. The sun has much reduced the depth of snow, but in the shade frost has prevailed throughout the day."

— MR. F. TAYLOR writes from Welbeck—"The thermometer registered 7° at eleven o'clock on Friday night, the 9th. At five o'clock on Saturday morning the 10th, 2° or 30° of frost. This is 3° more frost than we have had any time during this winter, and to assist in its work of destruction the sun came out bright and powerful, registering 67° by ten o'clock—a rise of 65° in five hours. I believe all the bloom of early-flowering shrubs is completely destroyed. The buds of Lilac, Ribes, and young growth of Roses to all appearance are as bad as if they had been baked in front of a fire."

— MESSRS. COLLINS BROTHERS & GABRIEL write to us as follows on ANEMONE FULGENS AND CORBULARIA CITRINA—"Anemone fulgens blooms are not sent to Covent Garden as cut flowers, but varieties of coronaria and hortensis. The flowers sent you were for your opinion as to quality, they were sent over from France to us cut from our roots. The Narcissus corbularia citrina is a rarity scarcely known in English gardens, and very difficult to procure even in their native habitat, the south of France, and we do not suppose a single blossom has ever been sold in Covent Garden." [We did not mention Covent Garden, and the term "market" was employed as we were under the impression that the flowers in question were sent to this country for sale, and that Messrs. Collins & Gabriel had a market for them. Having grown all the Anemones mentioned, some of them for thirty years, we claim some acquaintance with their relative characters, and we cannot say how many times we have seen all of them sold in Covent Garden Market. We never saw more richly coloured flowers than those sent to us, while those of the Bulbocodium were charming, and plants ought to be grown in all gardens where dwarf early spring flowers are cherished.]

— MR. F. W. BURBIDGE, F.L.S., Curator of the Trinity College Botanic Garden, Dublin, recently delivered a lecture on DOMESTIC GARDENING under the auspices of the Rathgar Sanitary and Health Association. There was a crowded attendance, and the chair was taken by Mr. J. F. Lombard, J.P. The lecturer,

after some introductory observations, said that all plants had their uses and their beauty. Of all decorative arts gardening was the most useful. Flowers were beautiful and interesting everywhere, but in towns their value and beauty were most to be appreciated. Nothing could be more delightful than the effects of window gardening properly carried out. Plants as a decoration were essentially true and real. In art the poor man had to be content with the cheap print or imitation painting—the proof before letters with the engraving were reserved for the rich; but a Lily in the garden of the artisan was a true masterpiece, a sterling coin from the universal mint. The proposition so energetically made to plant with trees suitable districts was one that deserved to be supported. In the first place it would be the means of giving employment, and it would add wealth to such land as was at present practically worthless. Dr. Lyons' scheme recommended itself on economic grounds, for whenever a tree was properly planted in suitable soil the machinery of Nature was set in motion on our behalf. The lecturer alluded to the advantages Dublin possessed for plant culture as compared with towns in England. Dublin had the advantage of a land breeze and of a sea breeze. He described a simple plan originated by Matthieu Williams, F.C.S., and described by him in a lecture before the Society of Arts, London, by which, with the aid of a kind of cheap rough canvas, a species of greenhouse could be at a trifling cost erected. He thought that the principles of elementary horticulture should form a subject of instruction in the public schools of countries that depended so much on the products of the land. The lecture was listened to with the greatest interest, and was loudly applauded.

— THE *Warwick Advertiser* of March 10th gave the following particulars of a PRESENTATION TO MR. W. GARDINER OF ETTINGTON PARK GARDENS.—“On Tuesday last an illuminated address and a purse of sovereigns were presented to Mr. William Gardiner on giving up the charge of Ettington Park Gardens. The address was as follows—‘To Mr. William Gardiner. Dear Sir,—We, the undersigned friends and well-wishers, beg to present you with a purse of sovereigns as a slight token of our respect and esteem for you, on relinquishing the charge of Ettington Park Gardens, which you have held with so much credit for nearly twenty-five years. We venture to express a hope that you may long be spared to enjoy health and happiness, and we remain, Sir, yours faithfully.’ The address was beautifully illuminated. The presentation was made by Mr. Greenfield, the Hon. Secretary, and Mr. Evans, Treasurer of the fund, on behalf of the subscribers, and Mr. Gardiner acknowledged the receipt of the testimonial in suitable terms.” He has been succeeded by Mr. J. Haylock, late foreman at Apley Castle Gardens, Salop.

SO-CALLED LARGE BUNCHES OF GRAPES.

THE letter of “A Grower” in your last week's issue on the above subject, in which he avers that I have failed to show how these bunches are produced, and in which he rather dogmatically asserts that the bunch figured by you was neither more or less than one bunch, proves the desirability of a little friendly discussion on the subject, which I took the liberty of inviting in the notice taken exception to by “A Grower,” and which I hope may result in clearing up the perplexity that “A Grower” seems to have fallen into.

My object was simply to state the fact that large bunches were easily produced in the manner there described, and not to discuss the question of whether bunches so produced were *bonâ fide* or not. This would have been entering on debatable ground, which in that notice I had no desire to do; but I sufficiently indicated my belief that bunches so produced were not, in my opinion, single bunches in the sense generally accepted among gardeners. I simply give this as an opinion, with no thought whatever, as your correspondent insinuates, of blaming past exhibitors in the matter.

It is said that a grain of help is worth a bushel of sympathy. So with the hope and desire of enlightening “A Grower,” you

will perhaps kindly send the two Vine shoots to him which I herewith send you. On the most forward shoot, where the berries are set and thinned, you can see very plainly that two bunches have been converted into one cluster, which to the uninitiated would be difficult to distinguish from a single bunch. The second shoot is, as you see, showing two bunches; and with the object of making the two bunches into one cluster I take off the point of the shoot, leaf and all, close to the second bunch, which at once accomplishes the object in view; and I take it that “A Grower,” as a candid and practical man, will at once admit, without too much “reading or reasoning,” that this is an easy and expeditious way of converting two bunches into one, if I may use the term.

As a matter of course, after the close stopping of the shoot it makes no further growth from the point, but generally a lateral starts from the axil of the leaf behind the first bunch, which is encouraged to grow and to become the leading shoot to the bunch, and the part of the original shoot between the two



Fig. 58.—*Phalaenopsis Esmeralda*.

bunches becomes a stalk to the united bunches. It was so in the cluster figured by you.

I claim no merit whatever in having discovered this way of making large clusters. It has been practised by some for many years; but as one always willing to learn, and glad of information on any matter appertaining to gardening, I thought the matter might by chance interest some of your readers.—DRUID.

[We have forwarded the samples to our correspondent “A Grower.”]

TWO PHALÆNOPSIDS.

THE accompanying woodcuts represent the flowers of two comparatively new Moth Orchids, and both are well worth the notice of Orchid growers. *P. leucorrhoda* is a native of the Philippine Islands, whence it was introduced in 1875, and it has been considered by some to be a natural hybrid between *P. Schilleriana*, which it resembles in its leaves, and *P. amabilis*, to which it is related in its floral characters. The flowers are white slightly tinged with purple, the base of the lip being yellow with purple spots. The variety shown in fig. 59 is a remarkably handsome one from Mr. Brymer's collection, Ilington House, Dorchester, and is probably the finest in cultivation both in size and form.

P. Esmeralda (fig. 58), is a native of Cochinchina, and was introduced thence by Mr. Godefroy Lebeuf in 1877. It is a small-

growing species, with marbled leaves about 8 inches long and 2 broad. The scape is a foot high, with a few rose-coloured flowers near the summit. The woodcut, which was prepared from a plant in Messrs. J. Veitch's nursery, faithfully portrays the chief characters of the plant, which, though not so handsome as some of its allies, is yet pretty and neat, if only for the sake of the contrast it presents with such large-flowered forms as *P. grandiflora*.

It might be added that *P. Esmeralda* is named after the heroine in M. Alexandre Dumas's "Notre Dame de Paris."

AMARYLLISES AT CHELSEA.

A THOUSAND heads of *Amaryllis* flowers form an exhibition which can only be considered as unique, and the magnificence of such a

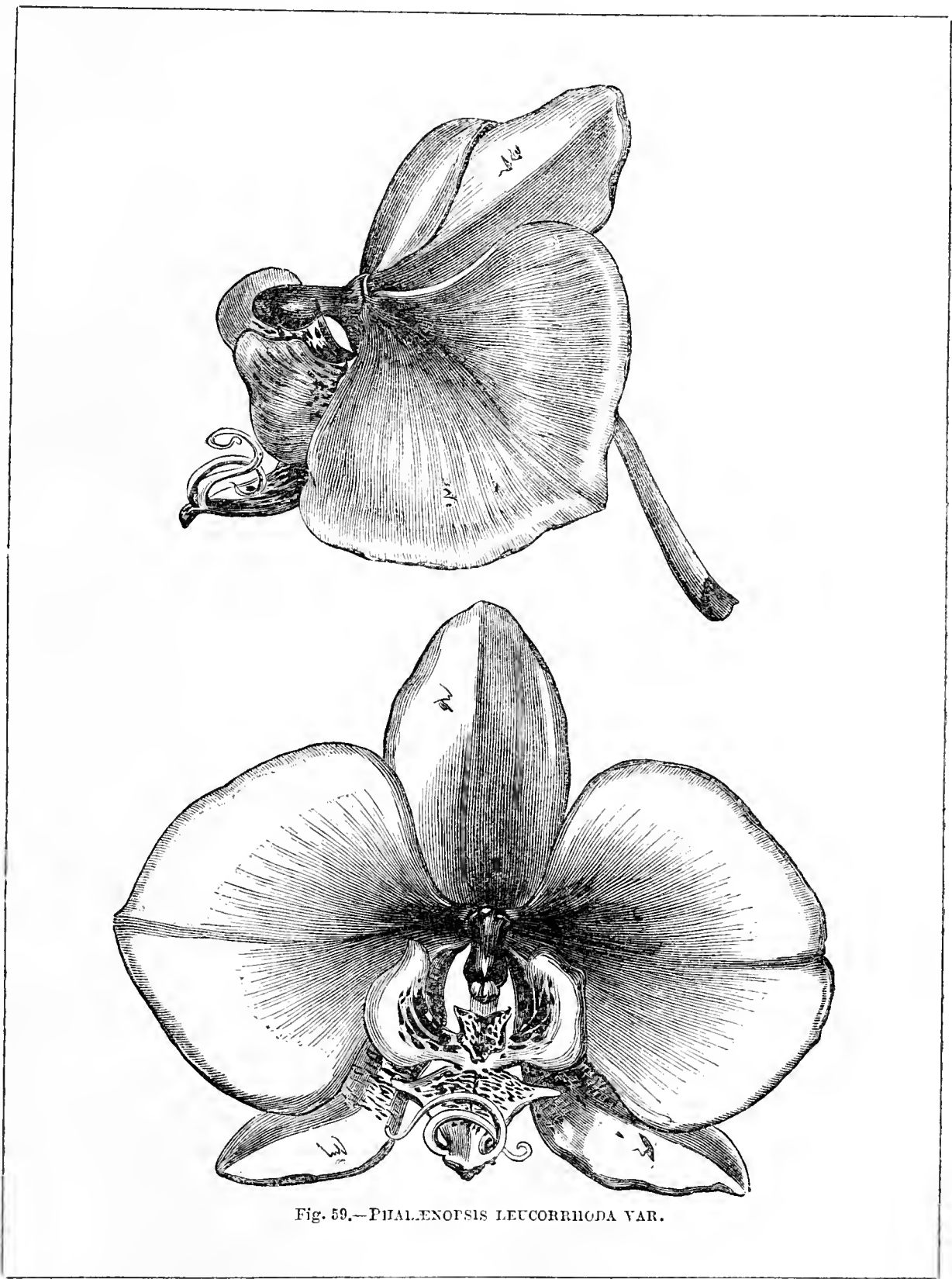

Fig. 59.—PHALLENOPSIS LEUCORRHODA VAR.

display can be better imagined than described. Visitors to Messrs. J. Veitch & Sons' Chelsea nursery, however, have now the opportunity of inspecting such a grand show as has been rarely seen even there, and all who can should call there during the next week. The improvement that has been effected in these plants since the attention of the firm was specially directed to them is astonishing. Not only have the flowers been greatly increased in size, but the form has been rendered more symmetrical, the petals are broader, more rounded, and the general contour of the flower

more pleasing than the earlier types. The colours, too, have been more diversified; rich crimson, scarlets of numerous shades, from the darkest tint to the brightest orange hues, delicate pink and rose, are similarly represented, the last chiefly in the form of veining or reticulations on a white ground.

The vigour of the majority of the plants arranged in the span-roof house devoted to them is very noteworthy, a large proportion of them bearing two spikes each, and some three, the stems of such varieties as *The Giant* being fully 2 inches in diameter, and

producing two to five flowers. A large number of the plants are seedlings resulting from careful crossing, and now flowering for the first time, but a fair proportion of the older varieties are also included, though the demands for these last year nearly exhausted the supply of flowering bulbs. There are, however, many thousands of offsets and seedlings advancing, and in a year or two the collection will be enormous.

It is almost impossible to enumerate all the varieties now in flower, but a few of the best may be briefly noted, commencing with the novelties. Perhaps the most remarkable amongst these is *Carminata*, which has flowers of great size, 8 inches in diameter, and the petals 3 inches broad. It is finely rounded and comparatively flat, the tube being very short, and the petals spreading, streaked and veined with soft delicate pink on a pure white ground. *Dr. Hogg* is another fine variety, with deep rich scarlet flowers of good form, and borne four in a head. *Sir Evelyn Wood* has large rich vermilion flowers, two in a head, the petals slightly recurved and darker in the centre. *Pallidiflora* is more curious than beautiful, the flowers of neat form, with a creamy ground colour streaked with red. With regard to these four varieties it is remarkable that they were all obtained from one pod of seed, the result of crossing Mrs. Baker with Virgil, both varieties that are well known. *George Gordon* is a very distinct and beautiful variety, the petals broad, slightly recurved, bright scarlet, with a white central streak. *Mrs. Wynne* has rich crimson flowers of good form, the centre of the petals streaked with white. It is a handsome and finely coloured variety. *William Goldring* is a striking variety, the flowers large and of good form, the petals rich scarlet, with a central band of white. It is very vigorous, the plant bearing two spikes, one with three and the other with four flowers.

Baroness Henry Schröder is one of the grandest of the novelties, the flowers 9 inches in diameter, white, with crimson streaks. *Mrs. John Freeman* is another superb form, very distinct, the flowers large, excellent in form, white, with rosy-crimson streaks, and light tips to the petals. *Mrs. L. Castle*, a neat variety of the Leopoldi type, the petals broad, rich crimson, tipped with creamy white. *Duke of Cambridge*, a noble variety, flowers rich scarlet, four in a head, vigorous and striking. *Princess Christian*, of the Leopoldi type, bright crimson, the petals tipped with white. *Zephyra*, remarkable for the fine shape of the flowers, the petals 3 inches in diameter, warm crimson, the tips white.

There are many other handsome varieties which we shall have occasion to notice in another issue, but two of the older varieties demand a word now—viz., *John Heal*, which bears the name of Messrs. Veitch's foreman who has charge of these plants, and who has contributed so greatly to their improvement, and the other is *Empress of India*. *John Heal* is probably the finest of the Leopoldi section, having rich crimson flowers tipped with creamy white, the petals nearly 4 inches in diameter and of great substance. *Empress of India* is surprisingly vigorous, one plant having three strong spikes, on one of which five flowers are expanding, and when these are fully out the plant will be magnificent in the extreme.

ROYAL HORTICULTURAL SOCIETY.

MARCH 13TH.

THE exhibits at this meeting were not very numerous and were confined to the Council-room, the groups of Abutilons, Cinerarias, and Primulas constituting the most prominent features. The Fruit Committee's duties were unusually light.

FRUIT COMMITTEE.—Harry J. Veitch, Esq., in the chair. The following members were also present—Messrs. Philip Crowley, S. Lyon, J. Willard, J. Burnett, J. Roberts, W. Denning, Wm. Paul, Arthur Sutton, C. Silverlock, John Lee, George Paul, and R. D. Blackmore.

R. Warner, Esq., Broomfield, Chelmsford, sent samples of a new Apple named *Warner's Seedling* of flattened form, dull yellow, with a few russet dots; the eye hasin moderately deep and puckered; the stalk short, with a large protuberance on one side. A first-class certificate was awarded for it. Mr. W. Allan, gardener to Lord Suffield, Gunton Park, Norfolk, sent a box of handsome Strawberries, the variety being *Vicomtesse Hericart de Thury*, which well merited the cultural commendation awarded for them.

FLORAL COMMITTEE.—G. F. Wilson, Esq., in the chair. The following members were also present—Messrs. J. T. D. Llewelyn, W. Bealhy, H. Ridley, T. Moore, H. Bennctt, G. Duffield, H. Eckford, H. Turner, J. James, H. Ballantine, C. Green, J. Wills, H. Cannell, W. B. Kellock, James Hudson, J. Douglas, and H. Ebbage.

Votes of thanks were accorded to all the following exhibitors. Messrs. H. Cannell & Sons, Swanley, Kent, exhibited a group of well-grown double white Primulas most profusely flowered; a number of new Cinerarias, some of which were remarkably fine; and a group of the new *Fuchsia Mrs. Rundell*, for which a first-class certificate

was awarded, and which is described below. Stands of richly coloured Cineraria blooms and double white Primulas were also contributed. Mr. Hill, gardener to Sir N. M. Rothschild, Bart., M.P., Tring Park, Herts, sent flowers of *Phalænopsis Sanderiana*, said to be a hybrid between *P. Schilleriana* and *P. amabilis*. The flowers are nearly as large as *P. grandiflora*, white, with a very faint crimson tint in the petals. Mr. George, Putney Heath, had a large and beautiful group of Abutilons, comprising many seedlings of great merit. Some of the best named varieties were Brilliant, bright scarlet, very free; Lustrous, shining scarlet, good form; Emperor, deep purple; Enchantress, rosy pink; Cloth of Gold, bright clear yellow; Striatum splendidum, yellow veined with rose; Purpureum, rich purple; Future Fame, very dark red, shining surface; Silver Bell, white with few rose veins, very pretty; Compactum Vivid, very dwarf, rich scarlet; Scarlet Gem, similar, smaller flowers; Compactum Pink Gem, bright pink, dwarf and free. Mr. Waterer, Knap Hill Nurseries, Woking, exhibited a plant of *Andromeda japonica*, which has long pendulous spikes of small wax-like white bells, the stems being reddish, as also is the calyx.

Messrs. Paul & Son, The Old Nurseries, Cheshunt, had a pretty group of *Rosa polyantha hybrida*, named *Parqueritte*, which has neat small double pure white flowers that are produced in great abundance. With these were associated Lilacs, Clematises, and small specimens of *Staphylea colchica*, a useful plant for forcing, as it produces its white flowers very freely. Mr. J. Child, gardener to W. J. Bell, Esq., Garhrand Hall, Ewell, showed a collection of very handsome white, purple, and crimson Primulas. The white varieties were uncommonly fine, the flowers large, and the form symmetrical. Mr. H. Eckford, gardener to Dr. Sankey, Boreatton Park, Shrewsbury, sent plants of seedling Primulas—*Empress*, rich crimson; *Grandeur*, bright crimson; and *Perfection*, pale purplish pink, blooms large and distinct, of fine form. J. T. D. Llewelyn, Esq., sent plants of *Primula denticulata*, its varieties *erosa* and *cashmeriana* for comparison. The species has light blue flowers in a close umhel, *cashmeriana* being similar, but with deep purplish blue flowers, and the variety *erosa* has loose umhels of pale lilac flowers. Mr. James of Farnham Royal, Slough, sent a box of very handsome Cineraria blooms, crimson, purple, maroon, pink, and blue; and G. F. Wilson, Esq., Weybridge, contributed a small collection of flowers, comprising Irises, Primulas, and Narcissuses.

Mr. H. Bennett, Shepperton, showed some seedling Roses, named *William Francis Bennett*, a rich crimson Tea, very neat in the bud state; and *Mrs. George Dixon*, a Hybrid Perpetual, with bright pink flowers, rather loose, but attractive. Mr. R. H. Vertegans, Chad Valley, Birmingham, exhibited a group of fine double Cinerarias, plants of the elegant *Sisymhrium millefolium*, and a very large-flowered *Cyclamen* named *giganteum maximum*, the petals of which are white, crimson at the base. Mr. R. Dean, Ealing, showed a basket of hardy Primulas of diverse colours, very pretty, and fine blooms of *Doronicum austriacum*, an early-flowering yellow Composite, useful for cutting. Mr. Todman, gardener to J. Connell, Esq., Bushey Down, Tooting Common, for Azaleas Duke and Duchess of Albany and cut blooms of seedling pink and white Azaleas. Mr. A. Waterer, Knap Hill, Woking, Surrey, was awarded a medal for a large collection of hardy Primulas of many colours, white, yellow, crimson, maroon, purple, and magenta. A pan of *Lachenalia Nelsoni* was sent from the Society's Chiswick Gardens; about thirty spikes were expanded, the flowers being large and bright yellow. A fine specimen of *Imantophyllum miniatum superbum* was also sent, bearing six large trusses of rich orange-scarlet flowers.

First-class certificates were awarded to the following plants:—

Amaryllis George Gordon (Veitch).—Very neat and distinct; flowers bright scarlet, with a central band of white on each petal.

Amaryllis A. F. Barron (Veitch).—Flower deep rich scarlet, the petals broad and slightly reflexed. A vigorous variety, bearing four flowers in a head.

Amaryllis Dr. Hogg (Veitch).—A handsome variety. Extremely dark scarlet-crimson, centre white, petals broad.

Dendrobium nobile var. *nobilius* (Salter).—A magnificent variety, distinguished by the great size of the flowers, which have rich purple sepals and petals, the lip being tipped with a similar shade.

Dendrobium Wardianum var. *Waddellianum* (Mr. Ward, gardener to G. Waddell, Esq., Stony Stratford).—A white variety of this well-known species, which is similar to one grown under the name of album. A well-flowered plant of the species was also shown, and a vote of thanks was awarded for it.

Pescatorea Lehmanni (Pollett).—Flower very large, the sepals and petals elliptical, white, veined and striped with deep violet-purple.

Zygopetalum crinitum var. *giganteum* (Pollett).—Flowers much larger than the ordinary form; the lip white veined with purple, and the greenish sepals and petals blotched with chocolate.

Azalea Deutsche Pearle (Turner).—A handsome double white variety; the blooms large, full, and the petals beautifully rounded.

Cineraria Captain Edwards (James).—Flowers of great size and excellent form; broad rounded florets, very bright crimson, and white at the base, forming a central ring.

Cineraria Colonel Clarke (James).—Flower of wonderful size, about 2½ inches in diameter, very rich crimson, of fine velvety surface, the florets overlapping.

Fuchsia Mrs. Rundell (Cannell).—A distinct variety, with large elliptical leaves coarsely serrated, the flowers being large; the tubes

2 inches long, white, with a reddish tinge, and large bright scarlet corollas; the petals rounded and closely imbricated.

SCIENTIFIC COMMITTEE.—Sir J. D. Hooker in the chair.

Tulipa Clusiana.—Dr. M. Foster made some remarks on the eastward extension of this species, stating that it had been found in South Persia, further east than had been recorded.

Lachenalia Nelsoni.—He also exhibited flowering spikes of a *Lachenalia* named *aurea* × *rosea*, which appeared to be the same as *L. Nelsoni*. It had a red rim to the edges of the petals, and some features resembling *L. tricolor*. What "*rosea*" referred to appeared doubtful.

Frost at Lamorran.—The Hon. and Rev. J. T. Boscawen stated that the frost last Friday was 12° Fahr. in a valley, the thermometer being on the ground and fully exposed. It was 10° of frost less on the higher and more open country. Mr. Loder said he had recorded — 3° on the same night at Weedon, at an altitude of 300 feet above the sea.

Potato Disease.—Dr. Masters read a portion of a paper on this subject forwarded to him by Mr. A. Stephen Wilson, and having special reference to the "sclerotia" which Mr. Wilson had discovered in nearly all the organs of the adult plant as well as in the seedlings and tubers. The sclerotia are supposed to germinate and lie in a state of incubation in the haulm; ultimately they give rise to the conidial threads. The conidia form according to circumstances either (1) zoospores, (2) plasm granules, or (3) secondary conidia. These are succeeded by oospores and a non-parasitic mycelium, from which latter, as it creeps through the soil, are thrown out "floats" and specks of the seminal plasm. The seed tuber comes into contact with the plasm in the soil, it is absorbed and becomes developed in the shape of sclerotia, and thus the life cycle is completed. From the tuber or seed to the conidia is the parasitic arc; from the conidia to the tuber is the non-parasitic arc. The author illustrates his position by what happens in the case of cereals, wherein the plasm, say of rust, is absorbed by the cells of the scutellum or cotyledon, passes through a period of gestation, and then germinates. Mr. G. Murray observed that a microscopical examination of certain specimens did not clearly reveal any organic connection between the sclerotia and the Peronospora mycelium, and he thought that possibly they might prove to be glandular bodies of some kind belonging to the Potato itself. Moreover, they could not be true sclerotia in the fungoid sense, as the latter are a compact mycelium.

PLANTS EXHIBITED.—A hybrid between *Carica cundinamarcensis* and *C. erythrocarpa*. Fruit and foliage of this plant were brought by Mr. Green, gardener to Sir G. Macleay. He observes that the fruit of this species is borne all the way down the stem, and is much smaller than that of *C. Papaya*, the "Papaw tree" of tropical America, which is borne in a cluster at the summit of the tree. The fruit was devoid of seeds.

Retinospora pisifera and *R. plumosa*.—Mr. Noble contributed a specimen showing the foliage of these two supposed species on one and the same plant.

Juniperus chinensis.—Mr. Noble also sent a male spray taken from a female tree, growing from an altitude of 14 feet from the base of the latter kind.

Garrya elliptica grafted on Aucuba japonica.—He also sent a young plant showing the two together. Mr. Henslow remarked how this was an instance where physiological affinity corroborated morphological, in that while Endlicher placed *Garrya* between the Hop and Plane tree, Bentham and Hooker assigned its position next to *Aucuba*; but the discovery of its power of grafting on *Aucuba* was a purely accidental attempt by a gardener in Mr. Veitch's nurseries.

Primula "Miss Eckford," exhibited by the gardener of Dr. Sankey of Shrewsbury, was a curious instance of an attempt at dialysis of the petals, which were very deeply cleft, somewhat in imitation of the Ragged Robin (*Lychnis Flos-cuculi*).

Primula sinensis, Seedling.—A supposed hybrid between *Auricula* and *Primula* was sent by Mr. Roberts of Rose Hill House, Ipswich. The pedicels and calyx were of a pinkish hue, the corollas white, but with no trace of "mealiness," the foliage closely resembling an ordinary *P. sinensis*.

Primula denticulata.—Six very fine varieties of this species from Nepal were sent by Mr. J. T. D. Llewelyn.—(*Bot. Mag.* 3959.)

Phajus maculatus.—Mr. Boscawen exhibited a fine spike of this Orchid, which he described as being nearly hardy.

LECTURE.—Dr. M. T. Masters in the chair. Mr. Henslow first called attention to a fine collection of *Primulas* of the Polyanthus type exhibited by Mr. Waterer, as well as a collection of finely flowered double white ones by Mr. Cannell, and a series of six varieties of the Nepal Primrose sent by Mr. Llewelyn. It was at one time thought that the common Primrose, which has given rise to so many excellent types under cultivation, was the same species as the Cowslip, the probable origin of all our older Polyanthuses, and that the Oxlip is a hybrid between them; but Mr. Darwin was inclined to think them distinct, as their habit of growth and time of flowering do not agree, as well as that they differ in the details of their flowers. The fine Polyanthus forms exhibited by Messrs. Waterer, Dean, &c., however, all result from various crossings of *Primula vulgaris* (the Primrose), the usual flowers of which—though apparently growing singly from the rootstock—really rise from an abbreviated peduncle, which elongates under cultivation. The *P. nepalensis* is very like

our English *P. farinosa* of Yorkshire, and this again closely resembles *P. magellanica* of the extreme point of South America. It was originally introduced by Mr. Veitch, and is figured in the "Botanical Magazine" for 1842, plate 3959. The double forms of *Primula* are acquired in the usual way of conversion of stamens into petals; but the specimen showed a tendency to "dialysis," or separation of its petals. This is not unknown to take place in *Campanulas*, *Convolvulus*. He then compared this process of "doubling" with the hose-in-hose variety of *Azalea*, the normal condition of *Canna* with several stamens more or less "petaloid," and *Cineraria*, where the result arose from the change of form of tubular flowers into strap-shaped.

Sisymbrium millefolium, a European species with finely divided leaves, suggested remarks upon an allied species, *S. Irio*, or London Rocket, which appeared suddenly after the burning of London, and in the Oxford Botanic Garden after burning weeds, &c. It was suggested by Dr. M. T. Masters that it might be specially due to the increase of the quantity of potash and other salts, which stimulated the dormant seeds into life, similar results arising after burning forests in America.

Lilacs.—Mr. Henslow alluded to the practice of forcing coloured Lilacs in the dark to develop white-flowered sprays, and remarked on M. Bert's experiments with plants grown in high latitudes, and which bore more brilliantly coloured flowers than when grown in the neighbourhood of Paris, the colour not depending directly on light, but on the supply of nutriment supplied by means of the foliage. Hence Hyacinths and Crocuses will bear blossoms of their normal colour in the dark, but the Lilac, not having sufficient nutriment in store, cannot perfect the colour when forced in the dark.

Mr. Henslow described the *Juniperus* and *Retinospora* mentioned in the report of the Scientific Committee, while Dr. Masters added the observation that the spinescent form of foliage represented the young state, while the adpressed foliage was characteristic of the adult condition. There was a difference, the microscopical structure of the foliage corresponding with their form, and which seem correlated to a corresponding difference in the vigour of growth.



[By the most skilful Cultivators in the several Departments.]

KITCHEN GARDEN.

EARLY Potatoes when producing their shoots above the ground they should be covered lightly with soil. This is a good way to protect them, as where there is a large quarter covering with branches is not practicable. Peas should be earthed up and staked as soon as they are well above ground. Main-crop kinds for June and July should be sown at once. A deep soil and plenty of manure will assist them to withstand the drought and prolong their time of bearing. Broad Beans should be earthed up, and the main crop of these may also be sown. Large pods for exhibition are not to be obtained from crowded plants, but to have the pods 12 inches long the plants should be grown singly, or not closer than 3 feet apart.

The earthing of autumn-sown Cabbages should now be completed. Many do their best to have "new Cabbage" by Easter, but general crops will hardly be in by that time this spring. Backward plants, however, may be brought rapidly forward by shaking a small handful of nitrate of soda around the stem of each. This is a quick-working stimulant for all vegetables. Radish seed should be sown fortnightly in small quantities. Small seeds generally may now be sown. Good soil and a sunny sheltered spot has advantages for them at all seasons.

In February last the ordinary seed-sowing was so retarded that we had two or three dozen protectors made in the form of small boxes 18 inches square, 6 inches deep, and without top or bottom. These were placed between the Potato mounds at the bottom of a south wall, and after placing fine dry soil in them to the depth of 3 inches, we sowed our Lettuce, Cauliflower, Leek, Parsley, and other seeds in them with good results, as we never had a finer lot of young plants at this season than we have now in these little cheap protectors. Besides affording shelter to the young plants they proved a barrier to the slugs and snails. Now we are sowing again in these boxes, and the plan might be generally practised with advantage in the spring months.

All Broccolis, Brussels Sprouts, Savoys, &c., should be cleared off the ground as soon as they cease to be of use. Manure or lime the ground according to requirements, and dig and plant with Potatoes. Having the rows 3 feet apart, and filling up between them by-and-by with autumn or winter greens, is

a profitable way of dealing with such things. Double-cropping should be practised on every possible occasion.

Herbs are in constant demand in every kitchen, and a regular supply should be secured in every garden. Fresh stock can easily be raised from seed, but it is yet too early to deal with this; only old plants should be attended to now. Any which have been wintered under a heavy mulching of manure should have this removed, and part or the whole of it forked in between the rows. Old growths which are never likely to be of much service should be cut back close to the ground, that fresh shoots may push from the bottom. This applies to Sage and Thyme in particular. Mint if top-dressed in autumn may be allowed to sprout through this, but where it had no manure in autumn a layer about 2 inches thick should be spread over the surface now. Spring-sown Cucumbers under glass are now in a fruitful state, and require constant attention in training and stopping—superfluous wood or leaves should never be tolerated. Thinly trained short-jointed growths are the most fruitful. All fruits are cut off immediately they gain their full size: attention to this is the only way to secure a long succession of fruits. Tomatoes are showing bloom, and as all the early varieties are fruited in pots they have been transferred into 10-inch pots. Loam in a very rough state with two or three handfuls of old Mushroom manure and one handful of Thomson's Vine manure is the compost we use for fruiting them in. Large quantities of Kidney Bean seed should now be sown in pots. Give those in fruit plenty of heat and moisture; syringe frequently to prevent the introduction or increase of insects. Make up Mushroom beds in cool sheds; they succeed much better in such positions than in warm houses. If beds in which the crop is declining are watered thoroughly with water at 90° a new and vigorous crop will soon follow.

FRUIT-FORCING.

Figs.—The earliest crop of Figs on trees in pots will have completed their first swelling, and it will be necessary to attend carefully in supplying water, affording liquid manure daily a few degrees warmer than the temperature of the house, as if the pots are properly drained the Fig at this stage will take great quantities without injury, and if allowed insufficient water the probability is that most, if not all, the most forward fruits will fall just when they should be taking their last swelling. If the trees are in good condition the roots will have found their way through the top-dressing, and if the trees carrying a heavy crop large pieces of turf may be laid grass side downwards on the surface of the soil, into which the roots will soon pass, and the fruit will be much improved in size and quality. The day and night temperature should not be increased until the fruit commences growing, when a few degrees' advance may be allowed. Syringe the foliage well twice on fine days, damping the floors and walls, and close sufficiently early for the temperature to rise up to 80° from sun heat. Ventilation will require careful attention, especially after a dull period; a sudden change to bright weather will necessitate early ventilation in order to prevent the leaves being scorched. Trees that are planted out will require to have the growths regulated, tied, and stopped as growth proceeds, stopping the side shoots at the fifth or sixth leaf, laying in full length terminal shoots until they have filled the allotted space. Syringe well twice a day, damping the paths, and at closing time mulch and water the borders, encouraging a sturdy growth as the best means of securing fruitfulness and keeping down red spider.

Vines.—Late Vines must be started forthwith, and those that have been started will need gentle fire heat to keep them gently growing. In the case of vigorous young canes not inclined to break regularly they should be brought down to a horizontal position to prevent a rush of sap to the terminal bud until all the eyes have broken, when they may be tied up to the wires. Syringe twice a day, ventilate a little at 70°, and encourage free growth by closing with a humid atmosphere at a temperature of 75°. Disbudding, tying, and stopping in succession houses must be followed up promptly, and do not neglect thinning the bunches and berries. Maintain a circulation of dry warm air where Grapes are setting, but avoid currents of cold air. If the bunches do not develop well, having a tendency to run into tendrils—a sure symptom of imperfectly ripened wood—increase the temperature and reduce the moisture. Shake the Vines to liberate the pollen, which will be sufficient for most sorts, but Muscats, Black Alicante, Lady Downe's, and other indifferent setters should have a camel's-hair brush passed over them, using pollen from Black Hamburgs, performing the operation about midday on fine days. The fermenting material should be removed from the inside borders of vineries in which Grapes will soon be commencing colouring, giving the borders a thorough soaking with tepid liquid manure, when a mulching with short

manure will keep the roots active near the surface, and prevent evaporation. Vines in pots swelling off crops of fruits will need feeding liberally with tepid liquid manure, removing the top-dressing as necessary. Pot young Vines from eyes or cut-backs, keeping them close and moist for a few days, but avoid coddling, as when they have taken to the new soil they must have full exposure to light and air. Compost for new Vine borders should now be prepared, using the soil in a rough open state, making narrow borders, and increase the space as the roots extend. The roots after planting should be kept near the surface by mulchings of short dung, frequently sprinkled with water at a temperature of 90°, encouraging growth by keeping the house close for a few days, and shading if the weather be bright.

Tomatoes.—These of late years have been extensively cultivated under glass, by which means they have been brought to great perfection, and so much esteemed are the fruits as an esculent that in many places it has become a necessity to provide them fresh throughout the year. This may be effected by sowings made early in February, April, and September, and the management in each instance is similar—viz., when the seedling plants are moderately strong they are placed in 3-inch pots, being transferred from those to 6-inch pots, and from these into the fruiting pots—*i. e.*, 12-inch, using in the latter case a compost of two-thirds friable loam and one-third decayed manure, with a little grit to keep the soil open. In potting provision should be made for top-dressing, leaving a space in the pots of about 3 inches. Surface roots abound in these plants, which should be encouraged by applying a dressing at intervals of decayed manure, with a few lumps of loam added. The plants will do in a house having a temperature of 55° to 60° at night, and where they can have sunshine to the fullest extent. The plants should be allowed to run with one main stem, allowed to run according to circumstances, or to an extent of about 6 feet, from which all side shoots should be removed, and the fruit when too thickly placed may be thinned. An important matter in the after treatment is to keep the plants liberally supplied with weak liquid manure. Syringing should not be practised after the fruit is half grown. There is now some admirable varieties. We find Orangefield Dwarf, Trentham Early Fillbasket, Hathaway's Excelsior, and Vick's Criterion admirable in every respect.

FLOWER GARDEN AND PLEASURE GROUND.

The Hardy Fernery.—As Ferns are fast starting into growth any alterations and propagation by division should no longer be deferred. When forming a fernery regard should be paid to the requirements of each species. For instance, the Athyriums, which comprise many handsome varieties, thrive best in a damp shady position, and in a mixture of loam and peat or leaf soil. Aspleniums should have a lighter and less damp position, though not much exposed to strong sunshine. Blechnums in similar soil will succeed in an exposed position, and so also will the varieties of Lastrea Filix-mas, but Lastrea dilatata varieties require shade. Cystopteris fragilis varieties delight in a shady position and a dry stony root run. Osmunda regalis should be planted in a cool moist position and in strong loam and peat. Polypodium alpestre varieties, P. dryopteris, and P. calcareum should have a moderately cool position, and loam and leaf soil or peat. The varieties of the common Polypody (P. vulgare) will grow freely in an exposed position, and will spread rapidly over a heap of stony soil, roots, or mossy stones. Polystichum aculeatum proliferum and P. angulare varieties bear a moderate amount of exposure, but not excessive moisture; a rich stony soil suits them. Scolopendrium vulgare varieties will thrive either in the open or partially shaded, and should have a good soil and plenty of moisture when growing. Regard should also be paid to the heights of each species and variety; but as they are many in number and vary considerably, recourse for further information must be had to a good catalogue or work on the subject.

Various.—Part of the stock of Gladioli ought at once to be planted, and the remainder, in order to secure a succession, at the end of March or early in April. A few corms may be potted singly, started in a moderately warm structure, and planted out early in May, and these throwing up spikes earlier will still further lengthen the display. Rich deeply dug soil suits them, and the corms or bulbs should have a little sand about them, and be covered to a depth of 2 inches. Ranunculus and Anemone tubers ought not to be kept out of the ground any longer. Plant in a rich loamy soil, the former about 6 inches apart, and the latter 4 inches apart each way. A little sand should be about each tuber. Pentstemons struck and wintered in handlights or frames may now be finally planted, especially if crowded; so also may herbaceous Phloxes. Cuttings of the latter with or without heels will strike in a gentle heat and flower this season.

THE BEE-KEEPER.

ON BUYING HIVES.

THOUGH the seasons of late years have been very unfavourable for honey-gathering, the interest taken in bee-keeping has greatly increased in England, and every year the ranks of apiarians are enlarged by recruits chiefly from the better classes of society. Many working men, too, have made an attempt in bee-keeping; but owing to the seasons and circumstances of trade being adverse at the time some were discouraged in their endeavour. It is known that many of the working classes long to have bees in their gardens, and doubtless if we have a honey season or two their desire for bees will be intensified, and bee-keepers will be multiplied. Then the pleasures and profits of bee-keeping will be widely realised, and bees will be considered a source of healthful enjoyment to all apiarians and of support to working people. I know what bees have done and can do in ordinary seasons and summers when fairly well managed. As it is desirable for beginners to commence bee-keeping with healthy strong hives, they should know something of bees or how to choose good hives before they buy them, or employ someone who does to purchase for them; or otherwise to go to an honest competent dealer and trust him. The advice so often given—viz., not to buy stocks but swarms only, I do not follow. The reason given for this advice is that bee-keepers sell their worst stocks and keep their best. When I buy bees I buy stocks, not swarms. When men apply to me for stocks I ask them to select the best of all I have. When swarms are asked for I advise the applicants to purchase stocks in preference, and thus have the chance of getting both swarms and honey the first season. Ladies and gentlemen at a distance who cannot visit my apiary and select hives for themselves generally ask me to do it for them. This, of course, is done, though I prefer or like buyers to choose for themselves. Thus some of my best stocks are sold every year, and sure enough I could have no satisfaction in selling inferior stocks. I am not now advertising bees or stocks of bees, for at present I have none to sell. My object in writing thus is to help beginners.

About a fortnight ago I went ten miles to see a gentleman's garden in this county—the last four miles I had to walk. On passing a cottager's garden with four hives in it I called to ask what price they would be sold at: 21s. each for either two or three of them. I agreed to give that price for two of them, and marked two which the cottager thought I would reject. Further on I came to a garden containing six hives—four straw and two bar-framers. I asked the owner what he wanted for the four straw hives. He said, "You shall have them at any price you name." "No, you must price your own goods." He did so, and I bought them at once, and brought them home yesterday. Though the hives are not first-class, being far inferior to many of my own which I have wintered, they are cheap enough, for we shall make twelve stocks out of the six during the summer, and have them in larger and better hives, and in better condition every way.

With the hope of helping inexperienced people in selecting stocks, a few points of excellence may be here mentioned.

1, *Size and Appearance of Hive*.—Handsome hives everybody likes, for they ornament gardens and please the eye. Large hives are more valuable than small ones, for they hold more bees and honey, and yield larger swarms and harvests of honey.

2, *The Combs*.—Hives filled with young sweet combs are better, all other things being equal, than those full of old combs, and better too than those not filled with combs. The combs built in spring are often formed of drone cells, and hence hives not filled with combs before autumn have, generally speaking, a superabundance of idle drones to feed during the following summer. But hives not nearly full of young combs are often to be preferred to hives full of old combs. The two hives I selected and bought for 21s. each are not nearly filled with combs, and the two others which I did not buy are full of older combs.

3, *Bees*.—Numerical strength in stock hives is a point of great importance—greater than any other point in the opinion of experienced apiarians who keep bees for profit. Those who make their hives strong with bees in autumn can smile at the dangers and difficulties of winter, and examine their stocks at all times with pleasure and confidence. Two gentlemen from the north of Lancashire called and asked to see my bees a few days ago. I had not examined them or unfastened them from their boards, but I lifted three or four of them in their presence, and found two of them in pretty good condition with bees between every comb; and one, a sugar-fed stock, with combs to the board in the centre

of the hive and all the combs covered with bees. This extra strong hive was created in October, and I may venture to say the bees now in full health have lived and enjoyed life all the winter without pollen. During the last fortnight or three weeks while breeding has been going on my bees have had a small barrel of shavings sprinkled with flour placed near them. Hives in April and May with their combs covered with bees, as we found this stock, are within a month of swarming; but in the colder atmosphere of February and March brood is not so widely spread, being more difficult to keep warm than it is in April and May: still we believe the hive in question will be quite ready for swarming by the end of April. Early swarms are, generally speaking, the most valuable of all hives, and often outrun all hives that do not reach the swarming point till the middle of June; and the way to get early swarms is to make stocks strong in bees in autumn.

Those who buy hives at a distance from home should ascertain and have a warrant that their combs are well fastened and will not break on the journey, and that ventilation will be properly attended to. From August till April stocks may be purchased and removed with safety. In May and June, when hives are at the swarming point, it is rather risky to remove them. Better buy swarms then. One point which should be considered in buying hives is the ages of the queens, youthful ones being the most valuable. The readers of the Journal interested in bees and bee-culture know that I attach great importance to autumn treatment, and believe that when bee-keepers learn by experience the value of strong hives they will alter their mode of management, so as to be able to make every stock hive marked for future work numerically strong in autumn. The bees of honey hives given to stock hives in September increase their working powers and value very much. A bar-frame hive or a Pettigrew hive is at least worth 10s. more with additional bees than without them. Hives weak in bees in spring have dangers and difficulties to meet. The bees can cover but few eggs, and therefore the patches of brood hatched are very small indeed. The fruit-blossom season passes before they are ready for work; indeed, many hives are lost from sheer want of heat or vitality in early spring.

The value of hives and selling price vary with their strength. The price of second-rate stocks ranges between 20s. and 30s. each, and first-rate ones both in size and quality range between 30s. and 40s. each. Hives in February and March with only two seams of bees are in danger of dying, and therefore not worth buying. Those with three seams of some size will live and may do well. Those with four seams of bees and two patches of brood are past all danger; and those which have five and six seams of bees in February and beginning of March are in splendid condition, and likely to give great satisfaction in seasons of honey-gathering.—A. PETTIGREW, *Bowdon*.

TRADE CATALOGUES RECEIVED.

- Native Guano Company, Aylesbury, Bucks.—*List of Testimonials*.
James Hunter, Chester.—*Catalogue of Agricultural Seeds for 1883*.
Charles Turner, Slough.—*Catalogue of Florists' Flowers for 1883*.
Edward Gillett, Southwick, Mass., U.S. America.—*Catalogue of North American Perennial Plants*.
G. Neighbour & Sons, 127, High Holborn.—*Catalogue of Improved Bee Hives (Illustrated)*.
James Dickson & Sons, 108, Eastgate Street, Chester.—*Catalogue of Farm Seeds*.
Samuel Yates, 16 and 18, Old Millgate, Manchester.—*Catalogue of Flower and Vegetable Seeds*.
George Templeton, Prestwick.—*Catalogue of Florists' Flowers*.
Dickson & Robinson, 12, Old Millgate, Manchester.—*Catalogue of Farm Seeds*.
William Paul & Son, Paisley.—*Catalogue of Florists' Flowers*.



** All correspondence should be directed either to "The Editor" or to "The Publisher." Letters addressed to Dr. Hogg or members of the staff often remain unopened unavoidably. We request that no one will write privately to any of our correspondents, as doing so subjects them to unjustifiable trouble and expense.

Correspondents should not mix up on the same sheet questions relating to Gardening and those on Poultry and Bee subjects, and should never send more than two or three questions at once. All articles intended for insertion should be written on one side of the paper only. We cannot reply to questions through the post, and we do not undertake to return rejected communications.

Books (Subscriber).—We stated last week that the price of Mr. Barron's book, "Vines and Vine Culture," is 10s., post free 10s. 6d. The size is demy 8vo, or perhaps it will be more intelligible to you to say that it is about 8½ inches long, 6 inches wide, and an inch thick. It contains 240 pages, divided into twenty-four chapters, and is illustrated by thirty plates on tinted paper, and forty-eight engravings. It is a very handsome volume.

Blood Manure (C. B.).—We are obliged by your letter. Experiments are being made and inquiries instituted on the matter.

Poetry (C. T.).—Your "rugged rhyme" had we think better not be printed. We are sorry to say that the gentleman to whom you refer, owing to failing health, has been compelled to rest awhile from all public duties and active mental or physical exercise.

Growing Lily of the Valley (J. B. W.).—In our issue of February 8th of the present year we published an article on the subject on which you desire information. That article we presume you did not read. You had better peruse it carefully, and then if you desire any further information write to us again. There is no reason whatever that crowns should not be grown as well in this country as in Germany, indeed they are so grown by some cultivators.

Climbers for a Cool Conservatory (P. G.).—You do not state the size of your house, or whether you require plants of strong habit or otherwise. The following, however, will probably suit you—*Lapageria rosea* and *alba*, *Clematis indivisa*, *Passiflora ceruleo-racemosa*, *Rhodochiton volubile*, *Lonicera sempervirens*, and *Cestrum aurantiacum*.

Dwarf Plants for a Grave (J. S., Carnie).—Snowdrops, *Seilla amœna*, Crocuses, Daisies, Alpine Auriculas, Primroses, Violets, *Arabis alba*, *Aubrietias*, *Violas*, *Pansies*, *Saxifragas Wallacci* and *muscoideæ*, *Lithospermum prostratum*, and autumn Crocuses are all of dwarf habit, and some of them would be in flower during the greater part of the year.

Pruning Roses (A. M. B.).—You appear to have pruned your Roses correctly, and if they are established, not newly planted, and fairly strong, you may safely leave them as they are, otherwise we should prune them to two or three buds, according to their strength, on whatever stocks they may be grown.

Gladiolus Brechleyensis (Idem).—It is one of the most hardy, useful and effective for massing of all. For flowering with *Anemone japonica alba* the corns should not be planted till the middle of April, surrounding them with sand, and covering about 4 inches deep. They should not be placed in immediate contact with manure. *Lobelia cardinalis* is a splendid plant for producing spikes of brilliant flowers in the autumn.

Tobacco Water (Constant Reader).—Tobacco liquor is sold by chemists, and to a gallon of it 6 gallons of water should be added before using. If, however, you have any difficulty in obtaining the liquor, you may make your own tobacco water by pouring half a gallon of boiling water on an ounce of strong shag tobacco, allowing it to remain until cold; then strain it, and use as required.

Insuring Glass Structures (T. S., Prescott).—Greenhouses, we believe, are insured by nearly all established offices in which property is insured. We do not know of any office in which the business is confined to the insurance of glass structures.

Odontoglossum Pescatorei and O. Alexandræ (J. W.).—Some of the varieties of these are very much alike, but you can readily distinguish them by the former having more rounded entire sepals and petals, while the petals of *O. Alexandræ* are usually slightly and sometimes very deeply cut. The flower of *O. Pescatorei*, too, is seldom so much blotched or spotted as *O. Alexandræ*, except in the case of *O. Pescatorei Veitchii*, which is one of the most distinct varieties in cultivation.

Double Richardia (A. W. B.).—We presume this is the plant you mean and if you grow it well you may expect it to produce double spathe next year. The variegated-leaved plant is *Abutilon vexillarium*. The green leaf you have sent is of *Pittosporum undulatum*, a greenhouse plant with greenish white flowers. It is a native of New South Wales, and was introduced in 1879.

Gloire de Dijon Rose not Expanding (A. B., Paisley).—Judging by the thin and pale footstalk we think your plant is the reverse of vigorous. The root-action is either defective or you do not afford the plant adequate support. It was evidently overcropped with flowers last year, and consequently the growth was not matured. You had better remove the weaker buds and supply the plant with soot water or other liquid manure. Possibly also it might be advisable to remove some of the surface soil and add fresh compost, good loam mixed with bonemeal or manure for inciting fresh root-action. A greenhouse will be quite warm enough for the plant. A high temperature would aggravate the evil.

Azolla caroliniensis (X. F. Z.).—The plant concerning which you require information is related to the *Jungermannias* and *Salvinias*. It is a diminutive aquatic, with small, dark green, closely imbricating leaves. It is a native of many parts of the world, both temperate and subtropical, and under cultivation either in a cool or warm house. The plants require little attention, except removing confervæ or any stagnant vegetation. In the autumn a few plants are usually placed upon damp soil to yield a supply for the next season, and if the plants are grown in a shallow pan it will only be necessary to drain the water from them. The last edition of the "Cottage Gardener's Dictionary" will no doubt suit you; it gives the names of plants introduced before 1880. This work can be had from this office, price 7s. 6d., or post free 8s. 3d.

Bunches of Chrysanthemums (Exhibitor).—We have referred to the article in the paper to which you direct our attention, and find that the "foggy quotation" has been taken from our columns without acknowledgment. It is not a "foggy" case at all, but every word has been transcribed from page 573, vol. iii., of this Journal, the issue of December 22nd, 1881. We do not, however, join in your accusation of "F. W. B.," than whom we know of no writer more honest, and he certainly has no occasion to display any weakness by masking the authorities from whom he quotes. We are satisfied that the non-acknowledgment of the abstracted paragraph was either a pure accident on his part, or it is due to a cause which he had not an opportunity to control in its preparation for the press.

Vine Management (J. T. S.).—Your explanation relative to the shortness of the rods is very convincing. You might if you choose take them down the other side, and let them take root in the soil the same as Mr. Wildsmith has done at Heckfield (see p 431, November 9th, 1882). Until the Vines break a temperature of 50° to 55° by fire heat will suffice; after they have grown a few inches increase the heat by 5°. When flowering and onwards the temperature may be 60° when you enter the house early in the morning, by fire heat alone in the daytime 65°, by sun heat 80° to 85°, closing the house in the afternoon early, so as to maintain the maximum temperature as long as possible, damping the house at the time of closing. In the morning open the top ventilators slightly at 65°, again at 70°, and so on as the sun increases the heat, and reduce similarly the ventilation in the afternoon. At the present time you may syringe the Vines twice a day until they are growing freely, after which time you can afford sufficient moisture by damping the house occasionally, according to the weather. If you give the Aloe tepid liquid manure it will probably push fresh growth from the stem.

Ornamental Grasses (J. E. O.).—None of the Grasses named require heat. You may either sow the seeds thinly in 3 or 4-inch pots and place in a cold frame, or sow in the open ground, covering them very lightly with fine soil. If you sow in pots the end of the present month will be soon enough, as the young plants require all the air and light possible, and hence the lights should be removed in fine weather. The seedlings must also be thinned out as soon as



Fig. 60.—*Briza maxima*.

possible, and when they are an inch high, sturdy and hardy, may be turned out of the pots and planted without disturbing the soil. For sowing in the open ground choose fine weather in April. *Briza maxima* is very ornamental and has long been grown in gardens. The earliest writer who mentions it as grown in this country is Gerarde. He says it was then called "Pearl Grass and Garden Quakers, growing naturally in some parts of Spain, and it is sown yearly in many of our English gardens." The term Quaking Grass has reference to the spikelets, which are in constant motion, being agitated by the slightest current of air, owing to their size, and the extreme delicacy and length of their stalks. Parkinson, who wrote a few years later than Gerarde, says this Grass was given to him by Clusius, the botanist, under the name of the "elegant Grass with Hop-like heads" (*Gramen elegans lupuli glumis*), a very descriptive title, and,

adds Parkinson, "It is now-a-days among our gentlewomen much esteemed to wear on their heads or arms, as they would do any fine flower or pretty toy to behold, as also to put into wreaths and garlands that the country people make for their sports and pastimes." Ray, writing some time later, says that when he sowed it in the spring it produced its flower-heads in August, but if he sowed it in the autumn they were produced in spring. He found it growing wild near Messina in Sicily, and it is also a native of Italy and other parts of southern Europe. It flourishes in any moderately fertile loamy garden soil, and may be sown at either of the seasons mentioned by Ray. The seedlings from the autumn sowing are sometimes destroyed by severe winters.

Pelargonium Leaves Spotted (Rev. E. F. C.).—Without knowing anything about the age of the plant, nor the conditions under which it is grown, we can only repeat a reply we gave to a correspondent a few weeks ago, that the cause of the disease is not known. It is indicative of some inherent weakness in the plant, induced, probably, by defective root-action at some time. Possibly the roots of your specimen are not in a very active state now. The best method of treatment is to cut the plant pretty closely down, and it is just possible the subsequent growths may be healthy. If they are not prepare the plant for the open air, and in due time plant it out in good soil and a sunny position. If this does not cure it nothing will, and it will be advisable to destroy it. We never propagate from plants similarly affected.

Calyx of Rose becoming Foliaceous (A. H. J.).—The phenomenon of which you send us an example is by no means uncommon in Roses and many other plants, and indicates what botanists term reversion. The calyx, corolla, stamens, and pistil are all regarded as leaves altered to perform special functions, and under cultivation we frequently see instances exemplifying this. Thus stamens become petal-like, sepals also become coloured and assume the appearance of petals, and they all occasionally revert to the original foliaceous state. In some cases transitions may be traced from leaves to bracts, sepals, petals, and stamens, each series becoming gradually merged in the other. In the case of cultivated plants, such as the Rose you sent, this alteration of form is generally due to luxuriance of growth, but some varieties are more subject to it than others.

Orchid Sales (Amateur).—The object of the auctioneer in the matter you mention is doubtless to economise time, as the greater the number of lots the longer is the duration of the sale, particularly when the competition is at all keen. If the "lumping" system were not adopted it would often be impossible to conclude the sale within the day. Of course it is in a measure disadvantageous to amateurs who are desirous of purchasing small lots, but these also are often offered, and you could then readily obtain what you require. It is, however, preferable for an amateur who does not wish to expend much money upon Orchids, with the risk of uncertain results, to purchase established plants from nurserymen, as they can be then had true to name, and will cause less trouble in subsequent culture. It is quite impossible to guarantee the names of the imported Orchids sold until they have been flowered, and this the nurserymen do at their own risk.

Various (F. J.).—The manure is practically inodorous, and quite so when covered with soil as you propose. Whether it would be wise to use it in your case depends entirely on the state of the Vines and border. If you read Mr. Taylor's book carefully you will, we think, find he did not apply the manure to young Vines, but only to Vines that had been established for some years, and had consequently partially exhausted the border. He also states the quantity he uses and the time of its application. The scions of Pears you have obtained will not grow if inserted as cuttings. Clay's fertiliser is in a great degree soluble, and is valuable as a top-dressing for plants. It is good also for mixing in the compost for certain plants, but this would not be the safest method for you to adopt. You would, perhaps, however, like to try a few experiments, and you may commence by adding a twentieth part of the manure to the compost, mixing it carefully and uniformly through the entire mass.

Polmaise Heating (H. S.).—There is a plan showing this method of heating in an early issue of the *Cottage Gardener*, page 258, January 13th, 1857, but the number containing it has been long out of print. If you possess the volume (xvi.) you can refer to it, and you will, we think, find it is no more adapted to heating your house than is the ordinary and better system of a hot-water apparatus. Where cost is no object we have never seen a structure that could not be heated by hot water; and if we had a well-executed plan of your house, drawn to scale, showing the paths and borders—in fact, showing everything clearly, we could possibly suggest a mode of heating; but a rough imperfectly drawn plan, of which we receive so many, is of no use whatever. There is nothing unusual in your Vine eyes; roots will follow in due course if the curves are kept in a proper state of moisture and a suitable temperature is maintained.

Propagating Begonias (H. S.).—Cuttings taken off close to the tubers, the same as those of Dahlias, will strike in a heated propagating case. We should, however, prefer to let the growths advance somewhat, then sever them a few points above the tubers; the stems would then break again and the parent plants make good specimens, which would not be the case by the above-mentioned plan of taking the cuttings with a portion of the tubers, or very close to it. We did not mean to imply you had been neglectful, as it was quite natural you should not think of cockroaches, which, however, are much addicted to eating ornamental-foilage Begonias. Caterpillars are often very destructive amongst Pelargoniums. They may perhaps eat Begonias also, but we have not known them to do so. We think you have made the plants safe, and your endeavours certainly merit success. We do not know where the compressed moss for stable litter is obtained, perhaps some of our readers can supply the information.

Narcissus in Pots (Ayrshire Amateur).—As soon as the flowers fade remove the stems and place the plants in a very light position, either in cool house or a frame, and water them with the same care as usual until the foliage changes. During mild days and sunny weather remove the frame lights. Your object should be to produce good foliage, and keep it fresh as long as possible under the full influence of light and air. If the plants are well managed on the lines indicated they will store up matter in the bulbs for the formation of future flowers. They will not equal imported bulbs, but if planted in good well-drained soil will become established and increase in numbers, and probably in vigour, year by year. All the *Tazettas* or *Polyanthus* varieties do well in pots, also in the open air, as do many others. Not knowing the varieties in your "very large collection" we should, in all probability simply repeat them if we gave a list of names. As you are specially interested in these plants you cannot do better than refer to vol. xxxvi. of this Journal, where you will find much information, with figures of typical varieties, on pages 361 and 381; also in vol. iv., third series, pages 381, 387, and 407. If you do not happen to possess those volumes the numbers containing the articles can be had from the publisher in return for 1s. 2d. in stamps, requesting him to send you Nos. 946 and 947, new series, and 98 and 99, third series.

Vines in Pots (F. C.).—Growing Vines permanently in pots is rarely indeed profitable, and especially in 9-inch pots. We have seen very good crops on Vines in 15-inch pots, but these you do not appear to have room for, and, besides, with the top-dressing you propose 9-inch pots will suffice for your small canes. Undoubtedly a layer of turfy loam and manure for the pots to stand on would, if kept constantly moist, be of service, and the roots that would form there could, if needed, be cut off when the Vines were pruned. Remove the weaker of the two buds in every case where twins appear, and remove also the bunches from the cutbacks. It would be well, too, to remove as much of the soil as possible from the pots of these without materially disturbing the roots, and add fresh turfy loam with a tenth part of bonemeal, or, failing this, a fourth of manure, the compost to be pressed firmly in the pots. These growths, only one being left on each Vine, ought to form very fine canes, far superior to those you are now fruiting. You may as well allow a few bunches to remain on these, as, whether you do or not, we do not apprehend they will be of any substantial value another year. They are really too weak to be relied on, though we can quite understand your anxiety to obtain a few bunches. Give them the best treatment you can, both by top-dressing and a bottom layer of rich compost, and they may possibly turn out better than we anticipate. We should insert a few more eyes now. Grow them after being rooted in 6 or 7-inch pots, upon the wood well, cut them back in the autumn, shift them in the spring, and in the following summer they would be fine canes ready for taking the place of the present fruiters if these should fail to make vigorous growth. We are obliged by your notes of approval, it is our endeavour to be useful.

Hardy Annuals and Herbaceous Plants for Cut Flowers (J. P.).—Perhaps the finest annuals for cutting are *Chrysanthemum tricolor* vars.—viz., *Atrococcineum*, *carinatum*, *Burridgeanum*, *Lord Beaconsfield*, *W. E. Gladstone*, *Inteum*, *The Sultan*, and *venustum*; *Eschscholtzias* in variety, *Mignonette*, *Centaurea Cyanus minor*, *C. Cyanus carulea*, *Sweet Peas*, *Sweet Sultan*, purple, white, and yellow. To these you may add some of the many varieties of *Candytuft*, *Collinsia*, and *Nasturtium*. Of half-hardy annuals, which you may raise in gentle heat, sowing in pans or boxes in the coolinery, *Phlox Drummondii* vars., large-flowering *Ten-week Stocks*, *Double Dwarf Scabious* vars., *Asters*, and, if you like them, the *French and African Marigolds*. Of herbaceous plants *Achillea Ptarmica plena*, *Alstrœmeria aurantiaca*, *A. chilensis*, *Anemone japonica*, *A. japonica alba*, *Anthericum Liliastrum major*, *Aster Amellus majus*, *A. multiflorus*, *A. dumosus*, *Campanula Hendersoni*, *Chrysanthemum lacustre*, *Francoa ramosa*, *Fuchsia corallina*, *F. globosa*, *F. Thompsoni*, *Helianthus multiflorus plenus*, *H. angustifolius*, *Hyacinthus candicans*, *Plumbago Larpentæ*, *Polygonum vacciniifolium*, *Rudbeckia Newmanni*, *Schizostylis coccinea*, *Sedum spectabile*, *Senecio pulcher*, *Spirœa filipendula plena*. *Phlox* of the *decussata* section are fine for late summer flowering, and so are single *Dahlias*, which you may forward in your cool house, and plant out at the end of May. *Carnations* frequently bloom until a late period—in the north of England often until frost, especially those that are raised from seed.

Grapes Setting—Air Roots (E. Y.).—Your Grapes, judging by the bunch sent, have set admirably, and by the time you read these lines will be ready for thinning. The presence of roots on Vine rods sometimes, but not always, indicates that the roots in the border are not in such good condition nor working so freely as is desirable; the production of roots from the stems is also accelerated by a too moist atmosphere. When we give a reply to a correspondent it applies essentially to his particular case, but not infrequently has a general application. You have not read the reply to which you refer carefully, or at least have not quoted from it correctly. We never mentioned any particular hour, such as "three o'clock," for closing and damping. We have never managed Vines by clockwork. We said "very little moisture should be afforded with a declining temperature, and no syringing or damping should be done after the sun has left the house." You had better reduce the atmospheric moisture, and in due time the stem roots will shrivel. Since writing the above we have received the following note from "Vitis," which may be appropriately inserted here—"Various opinions are expressed regarding air roots on Vines. Some maintain they are a sign of ill health and unsuitable condition, others that they are a sign of robust and overflowing strength. I do not intend to try and settle the matter, but simply record my experience. A house which from surrounding and internal circumstances is much shaded and damp, has furnished Vines which display every year air roots in great numbers, and about 9 inches long. The Vines bear well and seem in good health. Other houses in better situations are less troubled, and, indeed, some are almost without air roots on the Vines. This would lead one to suppose that a damp situation, and comparatively shaded house are conducive to the abundant production of air roots. Certain it is that the Vines are not in bad health, indeed they are remarked upon by all who see them for the way in which they bear, and the style in which they ripen a heavy crop year after year. The ripening is secured by a very liberal use of fire heat combined with judicious ventilation, the fire heat being used in this case more freely than is required in houses more fully exposed to the sun." This record of experience of a practical and observant cultivator will be useful to yourself and others.

Names of Plants (J. Dickson).—1, *Omphalodes verna*; 2, *Erica carnea*; 3, *Eranthis hyemalis*; 4, *Sisyrinchium grandiflorum*. (*B. Davis*).—1, *Primula denticulata*; 2, *Begonia nitida*; 3, *Pteris argyrea*; 5, *Adiantum decorum*.

COVENT GARDEN MARKET.—MARCH 14TH.

MARKET quiet, with little to remark. Grapes shorter, with a good demand for first-class samples.

VEGETABLES.

	s. d.	s. d.		s. d.	s. d.		
Artichokes.....	dozen	2 0	0 4	Lettuces.....	score	1 0	1 6
Asparagus, English	bundle	12 0	0 0	Mushrooms.....	punnet	1 0	1 6
Asparagus, French	bundle	25 0	30 0	Mustard & Cress..	punnet	0 2	0 3
Beans, Kidney....	100	2 0	0 0	Onions.....	bushel	2 3	2 6
Beet, Red.....	dozen	1 0	2 0	Parsley.....	doz. bunches	3 0	4 0
Broccoli.....	bundle	0 9	1 6	Parsnips.....	dozen	1 0	2 0
Brussels Sprouts..	sieve	1 6	2 0	Peas.....	quart	0 0	0 0
Cabbage.....	dozen	0 6	1 0	Potatoes.....	cwt.	6 0	7 0
Capstems.....	100	1 6	2 0	Kidney.....	cwt.	6 0	8 0
Carrots.....	bunch	0 4	0 0	Radishes....	doz. bunches	1 0	0 0
Cauliflowers.....	dozen	2 0	3 0	Rhubarb.....	bundle	0 4	0 0
Celery.....	bundle	1 6	2 0	Salsafy.....	bundle	1 0	0 0
Coleworts.....	doz. bunches	3 0	4 0	Scorzoneræ.....	bundle	1 6	0 0
Cucumbers.....	each	0 9	1 8	Seakale.....	basket	1 0	2 0
Endive.....	dozen	1 0	2 0	Shallots.....	lb.	0 3	0 0
Fennel.....	bunch	0 3	0 0	Spinach.....	bushel	3 0	0 0
Herbs.....	bunch	0 3	0 0	Tomatoes.....	lb.	1 6	2 0
Leeks.....	bunch	0 3	0 4	Turnips.....	bunch	0 2	0 3

FRUIT.

	s. d.	s. d.		s. d.	s. d.
Apples.....	½ sieve	2 0 to 7 0	Grapes	lb.	2 0 to 8 0
".....	per barrel	20 0 40 0	Lemons	case	10 0 20 0
Apricots.....	doz.	0 0 0 0	Melons	each	0 0 0 0
Cherries.....	½ sieve	0 0 0 0	Nectarines.....	dozen	0 0 0 0
Chestnuts.....	bushel	10 0 12 0	Oranges	100	6 0 10 0
Currants, Black..	½ sieve	0 0 0 0	Peaches	dozen	0 0 0 0
" Red.....	½ sieve	0 0 0 0	Pears, kitchen ..	dozen	1 0 2 0
Figs.....	dozen	0 0 0 0	dessert	dozen	1 0 2 0
Filberts.....	lb.	0 0 0 0	Pine Apples, English	lb.	1 6 2 0
Cobs.....	100 lb.	0 0 0 0	Raspberries	lb.	0 0 0 0
Gooseberries	½ sieve	0 0 0 0	Strawberries	oz.	0 9 1 3



POULTRY AND PIGEON CHRONICLE.*

THE POLLED BREEDS OF CATTLE.

(Continued from page 207.)

WHEN the celebrated Mr. McCombie appeared upon the scene he took up the good work systematically commenced by Hugh Watson. William McCombie carried it on with a skill and success that have few equals, and that will hand down his name to posterity as the chief improver of the polled breed. It might with truth be said that what the Booths have been to "Red, White, and Roan," William McCombie was to the "Glossy blacks." Than that, higher credit could be given to no breeder of live stock; and everyone who has any knowledge of the subject will admit that it is due to the memory of the late Laird of Tillyfour. In the space we can afford in this Journal, however, a detailed account of Mr. McCombie's work as a breeder of polled cattle cannot be attempted. Still, as Tillyfour was regarded the headquarters of improved black polled cattle, and as Mr. McCombie did more than any other man to gain for the breed the world-wide reputation it now enjoys, a short statement of the leading features in the history of his herd will probably prove acceptable to our readers.

Mr. McCombie was born in 1805 and died in the spring of 1880. He dated the foundation of his polled herd from the year 1832, the first year in which he gained a first prize for a polled animal. This herd, however, was dispersed in 1880. In the interval between 1832 and 1880 lies the history of Mr. McCombie's mode of breeding and his style and type aimed at by which he improved the black polled cattle, and which insured him an unrivalled career and immense success in the various cattle exhibitions, not only in England but also on the continent, especially in France, where the crowning victory of his life was achieved at the great International Exhibition held at Paris in 1878. On that occasion, in addition to several leading "class" honours, he carried off with a group of beautiful young polled cattle, all bred by himself at Tillyfour, not only the £100 prize for the best group of cattle bred by the exhibitor in the division foreign to France, but also the £100 prize "for the best group of beef-producing animals bred by the exhibitor." To enable him to achieve these unrivalled successes let us refer to the means whereby he obtained them, and make some allusion to his ideal of form and type which he adopted during his career in the animals which he reared. Mr. McCombie claimed that his stock possessed valuable natural properties not found to an equal extent in any other race of cattle. While he aimed at developing long, level, thick, deep quarters, he also retained the rounded appearance which was originally one of the dominant characteristics of the breed.

As the polled Angus cattle are more prized for the production of beef, and at the earliest age, than for their milking capacity, we will give a description of the best polled Aberdeen and Angus cattle, as stated by Mr. G. Walker in a paper which he read before

Kincardineshire Farmers' Club in 1872. The colour is, of course, "black, and all black if possible." The points required in a bull are as follows:—"Head neatly put on, clean throat and fine muzzle, not over long 'twixt the eye and the nose, eye bright and prominent, ear moderately sized, good breadth betwixt the eyes, and poll high; neck a good length and clean, a little but not over-full on the top; chest full and deep; legs short, but not so as to give the animal a dumpy appearance; bone clean and free from coarseness; shoulders not too full, and top free from sharpness, but not over-broad; back level and straight; ribs well sprung; deep barrel; well ribbed down towards hook; full behind shoulder; hooks level, but not too broad, and well and evenly fleshed to tail; twist full and long, and well fleshed down, but not protruding behind; tail of moderate thickness, and hanging straight; hair soft and plentiful; skin of moderate thickness and mellow to the touch; body fully developed, and the animal when in motion to have a blood-like look and style about him. A cow should differ from a bull in the head in having, instead of a broad masculine-looking head, a neat feminine-looking one. The ear should be also of good size, with plenty of hair in it; the neck well put on, clean and straight, and without any prominence on the top or abrupt hollow where it joins the shoulder; and the top of shoulder sharper than the bull's, and the shoulders themselves thinner." In both, however, "scurs"—loose horny excrescences on the head—are objectionable. We have been rather particular in describing the individualities of form and shape in this breed, because they differ materially in some respects from most other breeds, but especially those valued for their milking capacities.

We will now return to the doings of Mr. McCombie, for his famous polled ox in 1867, bred at Tillyfour and exhibited at the Birmingham and Smithfield Shows when four years old, and at both shows made almost a clean sweep of the special honours. At Birmingham he won the £15 and silver medal as the best in his class, the Earl of Powis's silver cup value £25, four other prizes, and the gold medal for the best steer or ox in the show. At Smithfield he won the first prize and silver medal as the best in his class, and the £40 silver cup for the best steer or ox in the show, and the £20 gold medal to the breeder. The ox was, by the Queen's desire, forwarded to Windsor for Her Majesty's inspection, and of which Her Majesty expressed great admiration, and was graciously pleased to accept from Mr. McCombie her Christmas baron of beef from the carcass of this fine animal. A year or two afterwards Her Majesty visited Tillyfour, mainly for the purpose of inspecting Mr. McCombie's celebrated herd of polled cattle, and was interested greatly in the beautiful herd shown at Tillyfour. We may here observe that their superiority over most other breeds from a butcher's point of view lies chiefly in the excellent quality of their beef and in the high per-centage of dead meat to live weight, and it is well known that they make the highest price per stone in all the principal markets of the kingdom.

(To be continued.)

WORK ON THE HOME FARM.

Horse Labour.—Some work, such as rolling the Clovers and carting manures to heap, was continued until the end of February, and March commenced with favourable weather, though it has since changed. If the weather should become fine during the next four or five weeks much sowing and planting will be done. Sowing Beans and Peas should be done first before the land becomes too hard and dry; Oats come next in rotation, with Barley in due course. If the land had been ploughed early scarify it and sow the seeds; otherwise, work down and seed the land daily as fast as it is ploughed. This only will make safe work, and land will work fine as it should do if dry weather continues, for what is right for dry weather as regards tillage must be right if the weather becomes showery. On the other hand if we sow and wait for rain, without the seed vegetates immediately, the rain may not come in time, and the land be comparatively barren. We have known seasons when there was not rain enough to vegetate the Barley and Oats until near to and after harvest, and after such a long cycle of wet seasons as we have experienced it may very probably happen again; at any rate we always recommend that ploughing or scarifying with immediate seeding is the only safe plan, because it is always right if the season proves either dry or wet afterwards. Rolling in those meadows and pastures laid up for hay should be done in favourable weather, when the land is firm enough to bear the treading of the horses.

Live Stock.—This is now a very important matter, for whether the practice is to rear all the lambs (where a breeding flock is kept) for sale, or whether the lambs are usually reared for selling in the early market fat. In the former case the ewes and lambs also may be doing very well, and a good average of lambs in number saved, and there is at present plenty of food; yet if the weather proves dry through April and May a pinch may come, and at these high prices they may be held too long, referring to the lambs. In the case of these on the vale farms and grazing lands the lambs may be held on

unless they will fetch a high price. We have lately known lambs sold very young at 40s. and 42s. This is folly at present, because they are worth money now according to their weight, and there never was a time that lambs would pay for making heavy weights like the present. We have been so much accustomed to productive summers as regards sheep food, that numbers of young farmers have never encountered the difficulties of maintaining sheep through a season of drought. As, however, eyes of seasons are said to repeat themselves, it will be well now to be prepared for a dry eye in various ways with regard to cattle management, for correct and foreseeing treatment and provision for cattle in advance for a dry season will always be right for a wet one.

PECULIAR REQUIREMENTS OF DIFFERENT POTATOES.

HAVING for many years taken special interest in the cultivation of the Potato both in the field and in the garden; having made not a few experiments in their culture, and been instrumental in inducing others with more space to do the same; and having collected much evidence from farmers personally known to me,

as well as having studied outside reports, I was more than usually interested in your Potato election, as well as in the extract from Messrs. Suttons' pamphlet. I had commenced a paper on the subject of the different cultural treatment required by different varieties of Potatoes, but seeing Messrs. Suttons' pamphlet advertised in your columns, thought it better to send for it in case the result of my observation had been forestalled, in which case plagiarism might have been imputed. But as what observations I have to offer are perfectly original, so far as is known to me, and are of more than usual importance, especially at this time, just when farmers and gardeners are thinking of planting, I hope to help to produce even better results than any mentioned by Messrs. Sutton.

Stated shortly it is this: Strong-growing Potatoes, like Scotch Champion, produce better crops, of better quality, when manured with mineral manures only. We have repeatedly proved this in the garden. Scotch Champion, planted on good soil and heavily manured, invariably produces an immense crop of haulm and a miserable crop of tubers, most of which are unfit for use. With no manure the produce has been fair, producing on an average during the last four years about 7½ tons per acre. With kainit

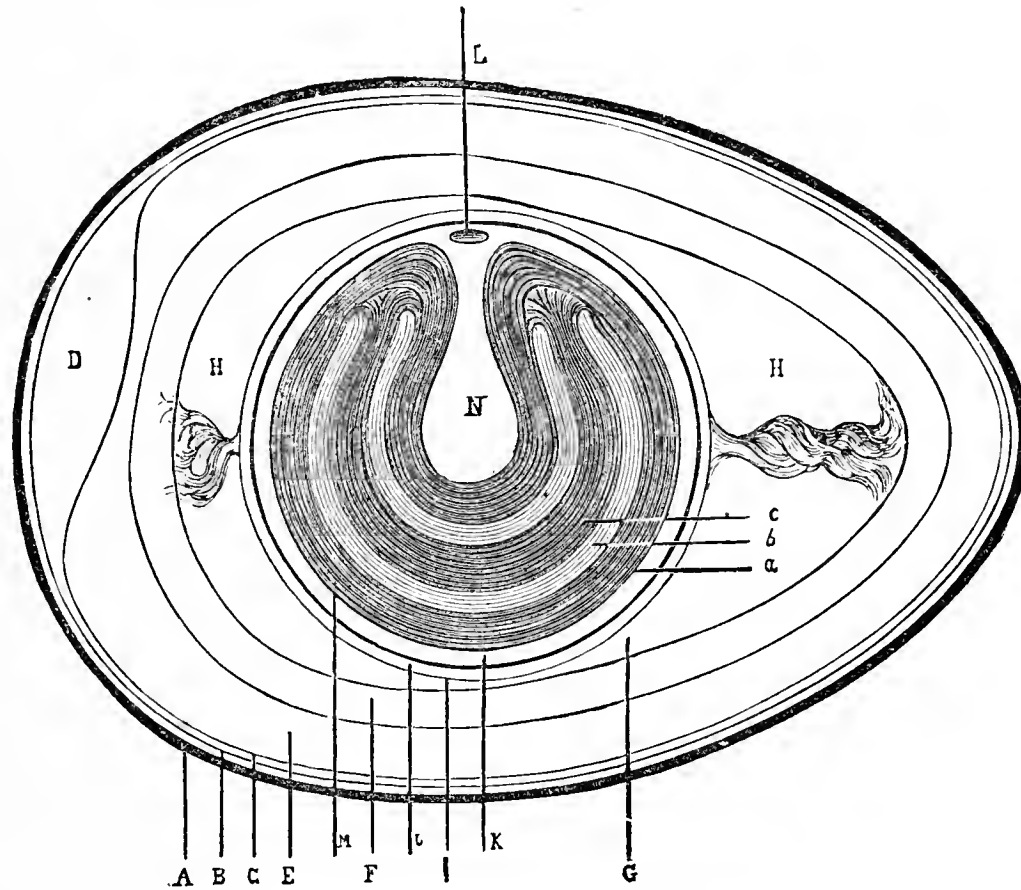

Fig. 61.—THE EGG. (See next page.)

applied at the rate of 2 cwts. per acre the produce has been fully 10 tons, and with 2 cwts. of superphosphate added the produce has been close on 13 tons gross. We may premise that the soil is very favourable for Potatoes. In the case of Magnum Bonum the results have been better in all cases except the last, but it must be remembered that 1 ton of Magnums are certainly equal to 1½ ton of Champions. When to the mixture above was added 1 cwt. of nitrate of soda the produce of the Champions went down to 9¾ tons, and the Magnums to 11½; but the experiment was only tried once. With a half-hundredweight of the nitrate the Champions produced at the rate of almost 11 tons, and the Magnums 13½ tons. These represent gross weights, but as only one-fortieth of the Magnums had to be rejected, and fully one-tenth in the Champions, it requires no more to prove which is by far the more profitable Potato. The produce and the market price will soon decide which is fitted to survive. On the home farm the results were pretty much the same as above, except in the case of those heavily manured with ordinary manure. In this case the produce of both were considerably superior to what was obtained in the garden; we feel certain because the soil was poorer in nitrogen.

Farmer No. 1, to which we will now refer, after trying both, with plenty of manure had very fine crops—of tops, but the bottoms were unsatisfactory. Champion gave 5½ tons of good Potatoes and 1¾ ton of utter rubbish; Magnums fully 8 tons of good and 5 cwt. of bad; Victorias gave 10 tons under the same

conditions, but this was in the favourable year—in this district—of 1880. Next year only an acre of Magnum and half an acre of Champion were planted. Half of each had a half manuring, half had nothing. Those with a half manuring gave Champions nearly 7 tons of good Potatoes, where no manure was used 7¼ tons—an actual excess over the half manured. Magnums, half manured, gave 8¾ tons; unmanured 6¼ tons. Victorias, on which he had relied, produced only about 2½ tons of sound tubers, but the disease attacked these very badly.

Last year mostly Magnum Bonums were planted, and, with the exception of experimental plots, half manured. Part was unmanured; part had 2 cwt. of kainit; part three; part four; part three of kainit and one of superphosphate; and part had two of each. This experimenting was done on the basis of the Munster trials, which were reviewed in your columns a year ago. Unfortunately I must leave figures now, but in a short letter I am informed that those which had the mixture of superphosphate and kainit in equal parts are "magnificent—never saw such crops! The rest of the series are good—indeed, very good; but the last beat the others. The next best after the half-and-half are those which had 3 cwt. of the potash salts and one of superphosphate."

"But many have grown good crops with heavy dressings of farmyard manure?" Yes; and farmer No. 2 does it, and yet he is a very bad farmer, whereas No. 1 is a most excellent one. How can such facts be reconciled? This puzzled me, and yet the problem was easily solved. No. 1 collects and prepares all his

manure under cover, and moistens it thoroughly with urine. It is never allowed to heat violently; hence it is rich, very rich, in nitrogen. No. 2 is careless. His manure is collected in the open, where it is spread thinly. When driven out to the fields it is put into large heaps and allowed to heat violently. What soluble nitrogenous matter escapes the washing of the rain is driven off by the heat, hence the manure is poor in nitrogen—"it is the dead body from which the soul has fled."

Space will hardly permit us going further into details; but we may say that one successful grower in a neighbouring county ploughs in his manure in autumn, and succeeds much better than when he used an equal amount in spring. The reason is evident; the rains carry away much of the nitrogen in winter. Another finds that on his land—it is good Wheat land—a mixture of 3 cwt. of kainit, 1 of superphosphate, and half a hundredweight of sulphate of ammonia produce between 12 and 13 tons per acre of Magnums. The same mixture produces 10 of Champions, but when the ammonia is left out nearly 12 tons result.

Another gives 6 tons of ordinary manure and 2 cwt. of kainit, and the result is something between 10 and 12 tons of Magnums; he does not grow Champions. But we must stop. The evidence is overwhelming. Let anyone study the Munster report, and he will see that the application of nitrogen was in all cases worse than useless in the case of strong-growing Potatoes. Even in Messrs. Suttons' pamphlet evidence of this is found. For instance, Mr. Smith reports a crop of 9 tons at a cost of £1 4s. for manure—"6 cwt. at 4s." It must have been kainit, as no other is sold at that price. Had Mr. Smith used only 2½ cwt. of kainit, 1 of phosphate, and half only of nitrate of soda, the price would have been about the same; but the crop would have been, almost without question, heavier by a ton or two. Messrs. Sutton think this gentleman's estimate of cost too low. We think not. "J. M. J.'s" expenditure of £12 10s. for farmyard manure was followed by the invariable results.

Nitrogen causes far too much growth on Potatoes already too strong. Magnum Bonum, being less robust than Champion, is the better with a small amount. Champion had better have none. Whether a little manure and the mineral mixture, or the latter with nitrates or ammonia, be most economical for Magnums, each must determine.

But for early kinds, producing moderate haulm, a liberal application of stableyard manure gives the best results. The mineral mixture along with 2 cwt. of sulphate of ammonia we have found a good substitute. Too much growth runs away with all available supplies; too little fails to provide for the converting of the carbonic acid of the air into Potatoes. Hence the necessity for quite different treatment according to the habit of the variety. The best crop we ever saw of Magnums was raised by a liberal application of wood ashes. Gardeners can take the hint.

We cannot agree with Messrs. Sutton about our never being able to have the market in our own hands in May and June. As Magnum is the best late it is also the best early. Kept cool, airy, and often turned, it is as good in June as in January. We have had it good so late as August; but in June it is vastly superior as food to the unwholesome watery rubbish from France. As a luxury the inferior Potatoes may continue to be eaten, but since there is a better the demand for French Potatoes will surely decrease when farmers have learnt to make money by keeping this Magnum. Northern farmers should take the hint.

In closing special attention is drawn to the remarks by Messrs. Sutton on selection of seed. One grower, indeed, speaks of having so many good Potatoes and so many "good enough for seed." Only the best are good enough for seed; inferior tubers produce speedy deterioration. Proper selection and good cultivation will prevent this, but can do no more. "Improved" Potatoes are often improved the wrong way. This is evident in the Munster report, where Messrs. Suttons' seed produced more than did "Improved" Magnum Bonum.

But the cultivation is most important. Will all the farmers who read this experiment on a small scale on the lines we have advocated, and next year send reports to the Journal? It is a matter of national importance; of patriotism as much as profits. In another paper we will show how to restore the land to fertility.—A. H.

PERMANENT PASTURES.—The edition of Messrs. J. Carter & Co.'s treatise on "Laying Down Land to Grass for Permanent Pasture" is now issued, and contains much interesting and instructive matter bearing upon that subject. It is in several sections—preparing, draining, and sowing being fully treated, together with renovating and general management. One very important chapter is that devoted to a consideration of the geological formations of soils, in which the characters of the various districts are considered under the heads of the different soils, such as clays, sand, chalk, and limestone.

In this portion of the work is contained a large amount of condensed information. An elaborate descriptive list of the Grasses used in forming permanent pastures, with figures of the most important, is also included, and adds to the utility of the work.

POULTRY AND PIGEONS

THE EGG.

THE woodcut on page 227 is taken from *Le Poussin*, M. Lemoine's new weekly paper. It represents more clearly than we remember to have seen elsewhere the composition of the egg. M. Lemoine has kindly permitted us to reproduce the woodcut for the benefit of our readers.

The dark line at the outside represents the shell marked A. Next to this come two membranes or skins marked B and C. The outer one, B, adheres or lies close to the shell throughout. The inner one, C, also follows the line of the shell except at the larger end of the egg, where the two membranes are apart, and form the air vessel, D.

Next to the lining membrane, C, is the white. This is in three layers, E, F, and G. In the inner layer of white, G, the yolk is suspended by the chalazas H H. These are spiral springs of more dense albumen, and extend from the middle layer of white to the membrane of the chalazas, I, which surrounds and almost touches the vitelline membrane, J. This membrane encloses the yolk, which again is composed of an outer layer of white yolk, K, which does not harden even in cooking, and inner concentric layers of yellow and white yolk, a, b, c. The yolk when the egg is perfect is suspended by the chalazas, and floats rather towards the upper part of the egg, as it is less dense than the white. It is curved on all sides round the utricule (latebra), N, at the entrance to which the germ, L, floats close to the vitelline membrane, and not far from the shell. The constituents of the egg are as follows:—The shell is composed of carbonate of lime, phosphate of lime, and gluten. The white consists chiefly of albumen, which chemical analysis has shown to contain carbon, oxygen, hydrogen, azote, phosphorus, and sulphur in varying amounts. The yolk is made up of albuminous matter, organic salts, vitelline colouring matter, phosphoric acid, and a fatty phosphoric substance.

The shell is porous, thus admitting a renewed supply of air to the embryo chick, which by process of incubation is produced from the germ and white. Shortly before its exit from the shell the embryo absorbs the yolk which forms a large proportion of its support during the first week of its existence outside the shell.

OUR LETTER BOX.

Sunflower Culture (C. A. H.).—Notes on the culture of Sunflowers in fields will be published in a future issue in time to be of service to you and other cultivators.

METEOROLOGICAL OBSERVATIONS.

CAMDEN SQUARE, LONDON.

Lat. 51° 32' 40" N.; Long. 0° 8' 0" W.; Altitude, 111 feet.

DATE.	9 A.M.					IN THE DAY.				Rain.
	Baromet- er at 324 and Sea Level	Hygrome- ter.		Direction of Wind.	Temp. of Soil at 1 foot.	Shade Tem- perature.		Radiation Temperature.		
		Dry.	Wet.			Max.	Min.	In sun.	On grass.	
1883.										
March.										
Sun. 4	30.722	37.4	35.8	N.E.	41.0	50.3	30.2	80.8	27.1	In.
Mon. 5	30.636	34.1	34.1	N.E.	40.3	54.3	31.3	83.8	25.7	—
Tues. 6	30.205	39.8	35.6	N.	40.7	48.2	33.7	87.5	32.5	—
Wed. 7	30.028	33.0	32.7	N.	39.6	39.5	29.1	86.0	26.4	0.143
Thurs. 8	29.770	30.6	30.4	N.E.	38.5	37.3	25.2	86.8	27.8	0.056
Friday 9	29.993	30.3	30.1	N.E.	37.8	37.8	23.7	83.7	25.1	—
Satur. 10	29.899	28.8	28.0	N.E.	37.4	37.0	23.4	83.9	21.2	—
	30.179	33.4	32.4		39.3	43.5	28.1	84.6	26.5	0.199

REMARKS.

4th.—Bright cold day.
5th.—Misty early, bright cold day. [wind.
6th.—Sleet at 8 A.M., snow occasionally during the day, with high very cold
7th.—Very cold gusty wind, showers of soft hail and snow.
8th.—Thick snow in early morning, and driving snow showers, with intervals of bright sunshine during the day.
9th.—Very bright and cold.
10th.—Fine and cold.

A week of truly wintry weather, the mean temperature lower than in any week for more than a twelvemonth, except the second week in December, 1882, and the mean minimum without parallel during that time. The lowest point reached in the shade, 23.4° on 10th, has been exceeded in March since 1858 only in the following years—1862, 21.3°; 1865, 23.2°; 1866, 22.5°; and 1874, 21.9°.—G. J. SYMONS.



22nd	TH	
23rd	F	GOOD FRIDAY.
24th	S	
25th	SUN	EASTER SUNDAY.
26th	M	Bank Holiday.
27th	TU	Royal Horticultural Society's Fruit and Floral Committees.
28th	W	Royal Botanic Society's Spring Show.

THINNING GRAPES.

NEARLY forty years have elapsed since I was initiated into the art of thinning Grapes. My tutor was a sturdy, hard-headed, but good-hearted representative of the "old school" of gardeners, who thought as much about wall trees and Onions as he did about Vines, while for "pottering about" among flowers he had a profound contempt. When the bedding mania came in Lobelias had to be raised in thousands, and occasionally my chief was almost obliged to assist in pricking out the seedlings, but never without, as he said, feeling ashamed of himself, as he was convinced that there was a great waste of force in an able-bodied man weighing 18 stones lifting plants that he could not clearly distinguish without his spectacles. This he regarded as work for the lads, and he held much the same views on the matter of thinning Grapes: hence the "lads," of whom I was one, had an opportunity of engaging in that occupation in early years.

At the age of eleven I was often perched on the top of a pair of steps at four o'clock in the morning practising; and the following year I was considered fairly competent—in my own opinion very much so, and was entrusted with the thinning of nearly all the bunches in a range of vineries 120 feet long. How many bunches of Grapes I spoiled I shall never know, but I may venture to assert that there are few individuals who did more damage in this respect before the age of fifteen years than I committed. Rubbing the Grapes with the head, fingering the bunches to get the work over quickly, piercing the berries with the points of the scissors, cutting out those that ought to have remained, and leaving others that ought to have been removed, were common errors and delinquencies, but not the worst by any means.

Possibly there may be a solitary reader of these notes unable to imagine any malpractice in the work under notice more serious than those enumerated; yet there is one, and it appears all the more necessary to point it out, since, although many gardeners must know of it, I do not remember ever to have seen it prominently alluded to in print. I have seen this greater error committed times out of number, and not always by lads alone or young men, but by amateurs, and even gardeners of mature years, in happy ignorance that they were acting otherwise than in the most safe and proper manner. In a word, they were complacently satisfied they were doing perfectly right when in reality they were doing what was utterly wrong, and were surprised

when the berries did not swell regularly, also that some of them, even who e shoulders, shanked.

"Shanking!" does someone soliloquise. "Surely nothing in connection with thinning the bunches in spring can affect the berries injuriously in the summer and autumn." But there is something that can and does limit their size and impair their quality, and in the case of Vines predisposed to shanking unquestionably aggravates that evil. What is this something? It is the very simple and very much too common and thoughtless habit of twisting the stalks and shoulders of bunches for reaching the opposite side instead of shifting the step-ladder or position of the operator. A slight turning of a bunch or portion of a bunch for convenience of thinning may do little or no harm, but twisting violently, as hundreds of bunches are twisted, so as to rupture the sap vessels, is an evil that can never be repaired.

The shanking of the Grapes in the vineries, where in my early days I thinned the bunches with lad-like recklessness, was grievous. The twisting of the stalks was not by any means the sole cause of the deplorable condition of the fruit; but rupturing the sap vessels, and consequently obstructing the free supply of food, without doubt intensified the evil. This was not, of course, thought about at the time, and in fact not until some years afterwards, when experiments were made with the object of ascertaining the effects of such a rough process of handling the fruit and twisting the bunches at a time when the tissues of the stem were in a peculiarly tender state.

On Vines where there were invariably more or less of shanked Grapes the bunches maltreated in the manner described were always the most seriously affected, and on shoulders that had been purposely violently twisted not one berry ripened, but all shanked. The experiment, when tried on Vines that produced no shanked fruit, always resulted in irregular-sized berries, some swelling much less freely than others, quite spoiling the appearance of the bunches in comparison with others that had not been injured in the thinning. Twisting the laterals of Vines or fracturing them in tying is bad enough, but the injury resulting from fracturing the stalks of the bunches is more marked. Let anyone observe closely a bunch of Grapes on a lateral that has been rather seriously "cracked" in tying down, and if all the berries swell with the same freedom and regularity as those on laterals where there has been no obstruction to the flow of sap it will be little short of a miracle, and will denote that the Vines are remarkably and unusually vigorous; and still more marvellous will it be if the berries on ruptured bunches swell evenly and become full-sized and regular.

Thousands of bunches of Grapes will be thinned every day now for some time. Let great care be exercised in this important work. Rubbing the fruit with the head or the hand cannot be done without the effects being seen by the educated eye of the master; puncturing the berries with the scissors will in a few days be perceptible; but twisting the stems or shoulders of the bunches leaves no immediate marks to arrest attention, yet the man, be he old or young, who permits himself to make such an egregious mistake after he knows the evil of it, is none the less culpable and ought never to be permitted in a vinery.

Instead of twisting a bunch to bring its opposite side round to the operator let the man go round the bunch.

Rather than incur the trouble of stepping down and moving a ladder I have in years past spoiled numbers of bunches of Grapes, not knowing at the time that any real injury would result from my hurried work with the seissors and laziness of the limbs. I know it now, and it is because I desire others to know it also that, after a long silence, I pen these lines during the Grape-thinning season, the subject having been brought to my mind by a rebuke that I have been compelled to administer to a man who will have the mortification of seeing a small label with his name attached to the laterals bearing some bunches that he has injured, and which cannot possibly finish satisfactorily.

Where a number of young men are employed in thinning Grapes it is advisable as far as possible to let each have a Vine to himself, his name being written on a label and attached to the rod where it cannot be seen except by those who know where to find it. Those who do the work in the neatest manner may be trusted to take care that the labels are not shifted; but the quality of the work cannot be fully tested until the fruit is ripe.—A NORTHERN GARDENER.

CARNATIONS AND PICOTEES IN BEDS.

IN my "salet days," when George IV. was king, it was a very common practice to grow these beautiful flowers in beds, and some of the best collections I have ever seen were so grown, one especially. I recollect one which was cultivated in almost the very heart of Dublin, in the grounds of the Meath Hospital, whose Secretary, Mr. Shaw, was a very ardent and very successful florist. Here those of us who used to look out for what was new and good used to go to gaze upon beauties which were beyond our reach, but which still we might look upon. How well do I remember the anxiety with which we looked for the opening pods of a variety which is nowhere to be found now, but which the owner of the collection I allude to had paid two guineas to possess—Twickett's Don John, and how fully we persuaded ourselves it was well worth the money! Since then I have at various times and in different places endeavoured to grow Carnations in beds, not because I think it the best plan, but it is less expensive and less troublesome. The size of the pots considered necessary for growing them well has been considerably diminished of late years; but, withal, the expense of pots, the expense of compost, the time taken in potting, all tend to make that method of growing them impossible to many. These same reasons influenced myself for some years; but there is one very serious drawback to their culture in beds, and that is the layering. It is not quite so easy when fifty is passed to bend the back for this operation; but when they are grown in pots it is easy to lift the pots on a bench and then layer them. On the other hand, we get larger growths, as a rule, when the plants are in pots, although this may be considered by some a doubtful advantage. While, then, I think the balance of advantage is clearly on the side of pot culture, especially where there is the advantage of a glass roof under which to bloom them, there is much that may comfort anyone who cannot venture on this in being able to have a bed or two of these sweet and beautiful flowers.

It is not advisable, where it can be avoided, to plant in the autumn. I have done so more than once, but a wet season like this, or a very cold one (such as we had two years ago), is very injurious to them; and therefore, where a cold frame is procurable, it is better to winter them in pots, as if they were to be grown in pots afterwards—*i.e.*, either singly or in pairs. During the winter they will require only to be watered occasionally, green fly being watched for and destroyed when it makes its appearance, dead leaves removed, and the surface of the soil stirred when it becomes (as it will sometimes) green from the growth of mosses.

When the winter is fairly over, say in March, it is then desirable to transfer the plants to the beds, which we will of course suppose to have been prepared in the autumn for their

reception; and if they have been turned up roughly so as to expose them to the action of frost so much the better, as in all such operations a dry day should be chosen, and when the ground is in good order. This is a point which in all gardening operations is essential to success, but which is too often overlooked, and indeed sometimes almost impracticable. I have been waiting to plant various things, but it has been impossible to do so. I have grown mine in beds $4\frac{1}{2}$ feet wide: this allows room for four rows of plants, placing them about 10 inches apart and about a foot in the rows. In planting they should be pressed gently into the soil so as to keep them firm, and then a small piece of stick should be put to each plant, to which it should be loosely tied, as nothing is more injurious than for the wind to twist them about, making a hole into which the water pours and so injuring the plant. There is one great enemy of the Carnation and Picotee which should be carefully looked after—the wireworm. One of these is quite equal to destroying the most robust plant, eating into it and ensconcing itself in the pith, and oftentimes when its work is completed then passing on to another. Where plants are grown in pots the compost can be carefully hand-picked and these destroyers killed, but it is not so easy when they are grown in beds. However, they are not so abundant in garden soil as in fresh pasture loam, and therefore when any of this is added to the beds in autumn it should be first carefully examined. As labels are so likely to be shifted and through carelessness or ignorance made useless, I find it to be a good plan, besides placing the label to the plants, to enter them in a book according to the rows. Thus, first row Zerlina four, Mary two, &c.; then if the labels are disarranged they can be easily replaced. When the plants spindle for bloom stakes should be placed to each and the flowering stem loosely tied to it, and all other shoots which exhibit the same tendency should be removed. The after treatment is precisely similar to that when they are grown in pots as to disbudding, tying the buds to prevent bursting, &c.; and all this will depend very materially on the purpose for which they are wanted. If for exhibition, then severe disbudding must be the rule, two or three of the best being left on each plant. When they are grown merely for decoration then this need not be so much done. I have found it best to erect an awning over the beds, as this keeps them from the direct rays of the sun and they continue longer in flower. Moreover, it is an advantage to be able to draw it over when the process of layering is going on.

There is one question which has always been a puzzle to Carnation growers—what occasions them to run? The older florists, and indeed many modern ones, attribute this to the use of manure, and have recommended growers to plant them in poorer soil than Potatoes are grown in. In my early days one of the most successful growers was Mr. John Puxley, a gentleman of large fortune in South Wales, but who was also the principal owner of a very rich copper mine at Castleton Berehaven in the county of Cork. His name is still commemorated in our catalogues as being affixed to Jenny Lind, Orestes, Lord Clifton, Illuminator, and others. The plants used to be grown in the pure air of that lovely neighbourhood and in the excellent loam which the limestone range there produced, and there I used to be told that run flowers seldom occurred. It is hardly possible to alter the character of the soil when grown in beds, but is easily managed when grown in pots.

Anyone who has a catalogue of the varieties grown twenty years ago, and will compare it with those of the present day, will be struck by two facts. One is that many of the older varieties still hold their own; the other is, that the last few years have seen a considerable displacement of the older varieties by new ones, especially those which have been raised by Mr. Dodwell, who, returning to their culture after several years' retirement, has considerably added to the Show varieties. Messrs. Fellowes, Hextall, and others have also contributed sorts which are more vigorous and easily grown than the older varieties. In an article by Mr. Dodwell in 1857 he only enumerates one variety as likely to displace that fine old flower Admiral Curzon in the S.B. class—Mr. Ainsworth, but which is not now in the list, while the Admiral still remains; but in this very class Mr. Turner, who is by no means inclined to swell his catalogue with padding, has no fewer than twenty-

one of Mr. Dodwell's varieties. So in crimson bizarres, while several are enumerated which have passed out of date, Lord Milton and Black Diamond maintain their reputation; but such varieties as Warrior, Hope, Tenby Rival, and Duke of Bedford have been displaced, a dozen of Mr. Dodwell and others of Wood's Abercrombie, &c., come to the front. Pink and purple bizarres, always a limited class, have had but few additions. Sarah Payne and Falconbridge are still attractive flowers; but James Taylor, Purity, and a few others claim attention as improved sorts. In scarlet flakes I find but one of those mentioned in 1857 in Mr. Turner's catalogue now—Comet, while here again Mr. Dodwell has made his mark, seven of his flowers being retained in a list of fifteen varieties. In purple flakes there has been not so much change, and Ascendant, Beauty of Woodhouse, Dr. Foster, Squire Meynell, and Mayor of Nottingham are still amongst the best flowers. In that very lovely class rose flakes a few of the older favourites remain, such as Lovely Ann and Lady Gardiner; but King John, Flora's Garland, Lorenzo, Friar Lawrence, and others are now nowhere; and James Merryweather, John Keet, Sybil, and others, including some of Mr. Dodwell's, Dr. Vernon, Mrs. Tomes, and Mrs. Horne have supplanted them. I have thus dwelt on the Carnation because for so long a time it seemed as if growers would have to be content with an occasional addition now and then and keep mainly to the old sorts, but Mr. Dodwell has revolutionised them, and as he is yearly adding to his novelties we may expect ere long the older sorts to be ousted by newer and more vigorous-growing varieties.

I do not desire now to enter into the vexed question of dressing, although my opinions have no way altered. I would merely warn those who see the beautiful and regular flowers shown at exhibitions that they will never be able to have theirs like them unless they are adepts at what is euphemistically called "dressing." This they must take lessons in, and learn by practice; but they may have great enjoyment in very lovely flowers without it, although they may not be up to exhibition mark.—DELTA.

MOVING LARGE SHRUBS.

It very frequently occurs that shrubs are left in positions where they have not room for development till they are too large to be moved by so light a machine as was figured on page 174. Shrubs planted too near to walks are very troublesome on account of the hard cutting they have to be subjected to, to keep them within bounds. Not only is this so, but they are generally an eyesore, sometimes in the shape of round mop-like heads as hard as worn-out brooms, at others they assume the form of hedges, some even going so far as to cut them with hedge shears. Instead of going on year after year cutting them, it would be much better to move them back, so that they could have a reasonable amount of room. To those who may have such to deal with, and are in any doubt as to how it is to be done, the following note on the subject will perhaps be acceptable.

Suppose, then, that *a a*, fig. 62, represents the position of two Laurels with a spread of branches some 5 feet from the stem, as indicated by the dotted lines *b b*. For their size they are too near the edge of the walk *c c*, and too close together. In the first place the lower branches must be tied up so that they will not impede the work of removing the soil. This is best done by getting a good length of strong soft rope. Fix one end to the main stem about 5 feet from the ground; take a few branches in the double of the rope and bring the loose end round the stem again and pull the branches up tight; enclose a few more in the next double, and so work round the tree till all is made secure by fastening the end of the rope to where you started.

We will suppose that the Laurels have to be moved back a distance of 5 feet, and a like distance further apart. The new position will be at *d d*. At those points insert stout pegs, and from them at each side, and from the stems of the shrubs, measure off $3\frac{1}{2}$ feet *e e e*, stretch a line to correspond, and mark it out with the spade. Measure from *d* to *f* 4 feet. In the same way mark out a square ball round the shrub, say 4 feet by 5 feet. Proceed to dig out the whole of the soil to a depth of 2 feet, except this square round the roots of the tree, placing the soil at each side of the trench. This done, commence to undermine the ball on each side to a distance of about 9 inches, having a clear space of about the same depth below the ball. At each end undermine it in the same way to the distance of a foot. Now get two long planks, and place them, one on each side, under

the ball as shown at *g g g g*. Upon the top of each of these place a bat of good sound oak or larch, about 4 or 5 inches square and 6 feet long, so that they will project 6 inches beyond the ball at each end. On the top of these bats place a piece of $1\frac{1}{2}$ -inch board, 9 inches wide and 4 feet long, across each end, pushing them under the ball as far as possible.

Next, place something under each corner, a small block of wood, or a brick if there is room for it, between the planks and the bats. This will give room to get a bar under the ends of the latter, by which means it will be easy to raise it so as to get a brick under. Having placed one under each corner, get a lever about 10 feet long made of a straight young larch, with a large block of wood for a fulcrum, and with this raise one corner at a time and place another brick on the top of the one already there, or, what is better, apply two levers at the same time, placing a brick under each corner.

Having raised it in this fashion till there are four bricks under each corner, clear all loose soil from under level with the planks, and cut off any roots that may project below the level of the bats under the ball. Four rollers of about 6 inches diameter and 4 feet long are now required. Place two of these in position on the planks, and by using the levers remove the bricks one by one till

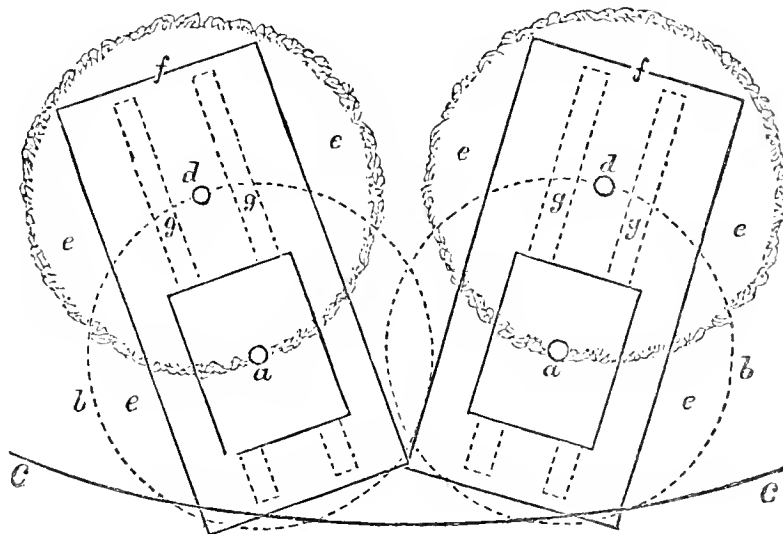

Fig. 62.

the bats rest on the rollers. It is then moved along the planks to its new position, raised on bricks again to allow of the rollers being removed, and then let down on the planks. Ram the soil well under the ball where it may be hollow before filling up the space round it. Without very much difficulty two men may move such trees in the way above described, but if they have a lad to assist, the work is done much sooner. They can then each use a lever while the lad places the bricks. If good hard-burned bricks cannot be had, blocks of wood of the same size will be best, as soft bricks will not stand the weight of a heavy ball.—R. INGLIS.

POTATOES FOR TABLE AND MARKET.

(Continued from page 215.)

In the following notes the figures 1, 2, and 3 indicate first early, second early, and late varieties; the months the time of planting; and the asterisks those varieties that are considered the best for market purposes by the respective cultivators.

NORTHAMPTONSHIRE.—1. For these and second earlies end of March or beginning of April, according to state of weather and soil. *Myatt's Prolific and *Beauty of Hebron. Soil.—I find light soil suits these the best. 2. *Suttons' Fiftyfold and *Reading Russet. Soil.—Light and medium suits these. 3. First week in April. Scotch Champion, *Reading Hero, *Magnum Bonum, and Schoolmaster. Soil.—For Scotch Champion, light; Reading Hero, light and medium; Magnum Bonum, medium and heavy; Schoolmaster, medium and heavy. Manures and Application.—For garden culture I use no manure, but manure for the previous crop. For field culture I use farmyard manure ploughed-in in autumn. General Culture.—I find the essential part of Potato cultivation to secure a good crop of clean and handsome tubers is to have the ground thoroughly pulverised by turning it up roughly in autumn, and forking it several times, the oftener the better, in spring before planting, and at least twice after the plants are up. This will, in my opinion, give better results (certainly for table qualities) than a coat of manure, provided the ground is not too poor. Should manure be necessary I would advise it being put on not later than November and dug in; by so doing I find the Potatoes are of better quality than they are if it is applied at the time of planting. The same remark is true as regards

field culture, except, of course, that the plough must be substituted for the spade. I am sorry to find that many cultivators, especially cottagers, do not attach sufficient importance to the working of the soil. They think manure is the chief element of success; but for garden cultivation, where the ground is rich and has been manured for the previous crop, it is quite unnecessary, indeed it often does more harm than good, as the richer the ground the more disease there will be. Myatt's Prolific is so well known that it needs no description. I consider it the best all-round early variety. Beauty of Hebron for light soils is good for all purposes, but on no account should it be planted on very rich or heavy soils, as from such its table qualities are anything but good. For second early varieties I can strongly recommend the two I have named. Fiftyfold is an enormous cropper, resists disease, and possesses excellent table qualities. The same may be said of Reading Russet, but that it is much handsomer in appearance. These two varieties were untouched by disease with me last year, although it was the worst year (except 1879) for disease in this neighbourhood that has been experienced for a long time. I have placed Scotch Champion first on the list of late varieties, and for the reason that as grown on the soil about here (which is light and sandy, resting on a rock of sandstone), it has no equal as a late variety for table qualities; and were I asked to name one late variety for light, shallow, and poor soils I should have no hesitation in recommending Scotch Champion. Unfortunately it has deep eyes, in consequence of which it does not take well in the market. Reading Hero is an excellent cropper, disease-resister, and table variety; its greatest drawback is its very luxuriant haulm. Magnum Bonum is not good here, but I have seen excellent crops obtained from medium and heavy soils, and it sells well in the market. The same remarks apply to Schoolmaster. Regents and Victorias will not do at all here, they seem to be quite worn out. I think that in the course of a year or two we shall have some new varieties of sterling merit, as Potato raisers are now on the right track. Cosmopolitan sent out last year is a promising early variety, but as I grew a limited quantity of it I am unable at present to say more about it.—J. HUGHES, *Eydon Hall Gardens, Byfield.*

1. First week in April for all the sections. *Empress Eugénie, Wilson's Early Frame, and Myatt's Ashleaf. Wilson's Early Frame Potato is the earliest I know, and has all the good cropping qualities of Myatt's Ashleaf. Soil.—Rich old garden soil well manured. 2. Rector of Woodstock, Porter's Excelsior, *Beauty of Hebron, and Milky White. I consider Beauty of Hebron the best. Soil.—Medium, resting on gravel, manured every two years at the rate of 10 tons to the acre. 3. *Scotch Champion, Magnum Bonum, Uxbridge Kidney, and *Wormleighton's Seedling. I consider Wormleighton's Seedling to be the coming Potato, but the Champion is at present the most useful. Soil.—Medium, resting on gravel; no manure used since land was broken up for the purpose two years since (having previously had a crop of Turnips fed off with sheep), and we find last year's crop to be the soundest and best by far, and not containing any with hollow centres. Manures and Application.—Champions are grown on sandy land three years in succession without any manure. The manure we use for Potatoes generally is farmyard manure, 10 tons to the acre.—R. GILBERT, *Burghley Gardens, Stamford.*

NORTHUMBERLAND.—1. About the middle of February. Old Ashleaf, Alpha, and Sandringham. Soil.—I have had strong loam, sandy loam, and gravel soil. 2. About the middle of March. Fortyfold, Rector of Woodstock, and Porter's Excelsior. 3. About the middle of March. Rintoul's White Don, Lapstone Kidney, and Magnum Bonum. Manures and Application.—After more than twenty years of Potato planting I have found that the less manure Potatoes receive in gardens the better, and I never give them any. I employ with the sets plenty of leaf soil, which I find they like well. If the ground has been previously dug I set the line, and with a draw hoe take out an opening about 4 inches deep, and after planting the Potatoes I cover them with about 3 inches of leaf soil or half-decayed leaves, then with the hoe draw on the soil over the leaf soil or half-decayed leaves, and this forming a low drill. Should weeds appear before the Potatoes they can be destroyed with the Dutch hoe. Potatoes should never be planted if the soil is wet, as it becomes too hard and they do not like it. Before earthing-up the soil should be well forked over.—WM. MCCOMBIE, *The Gardens, Mitford Hall, Morpeth.*

NOTTINGHAMSHIRE.—1. March. Veitch's Improved Ashleaf and Rivers' Royal Ashleaf. Soil.—Light, sandy, or medium. 2. First week in April. Myatt's Prolific Ashleaf and Porter's Excelsior, the latter a wonderful cropper. Soil.—Light and medium soils suit them best. 3. First week in April. A variety called Haigh's Improved Kidney does well here, also Schoolmaster, and Magnum Bonum. Soil.—Medium and strong. Manures and Application.—Farmyard manure is dug in the ground, and a little malt coombes applied round the stems when earthed up I find very good for early varieties. For second and late varieties farmyard manure is dug in, and the drills dressed at planting time with rape dust or soot and lime to great advantage. Salt at the rate of 5 cwt. per acre is very good previous to digging. General Culture.—We plant early varieties in rows 3 feet apart. Four feet apart for second earlies after earthing up leaves a good space to plant Eclipse and Veitch's Autumn Giant Cauliflowers or Brussels Sprouts. Plant late varieties 5 feet apart by 2 feet, which leaves good space for Broccoli between. We earth

the rows like rows of Celery.—THOS. H. SUTTON, *The Gardens, Workson Manor.*

OXFORDSHIRE.—1. March, also for the second earlies. Veitch's Improved Ashleaf, Early Hammersmith, Myatt's Prolific Ashleaf, and Rector of Woodstock. Soil.—Medium. 2. Edgcott Seedling, Woodstock Kidney, and Crampian. 3. End of March or early in April. Magnum Bonum, Reading Hero, Bresee's Prolific, and Vicar of Laleham. There are several new varieties I think highly of, but have grown them one season—viz., Suttons' First and Best, Suttons' Early Border, Reading Russet, and Fortyfold. Manures and Application.—No manure used, the ground being previously well manured for other vegetables. General Culture.—The ground is dug two spits deep, and again dug with five-tined steel forks and thoroughly broken.—WILLIAM FINLAY, *The Gardens, Wroxton Abbey, Banbury.*

RUTLANDSHIRE.—1. First week to end of February. The old Ashleaf, Uxbridge Kidney, and Myatt's Prolific Ashleaf. Soil.—Medium, planted on south border. 2. Middle to end of March. Snowflake, International Kidney, Rector of Woodstock, and Beauty of Hebron. Soil.—Heavy, also for the late varieties. 3. Middle to end of April. Schoolmaster, Magnum Bonum, Fortyfold, and Paterson's Victoria. Manures and Application.—Old hotbed material and burnt refuse from garden are dug in during the winter season. No artificial manure used. Soil naturally good. Uxbridge Kidney procured from Mr. Gilbert of Burghley is decidedly the best cropper of the early varieties. General Culture.—Ground winter-dug, trenches taken out at planting time with the spade. The first trench taken out at end of quarter, the next trench taken out to cover Potatoes planted in first trench, and so on through the quarter. Distance from 2 to 3 feet between rows according to varieties, the sets from 10 inches to 1 foot apart.—JOHN LINDSAY, *Exton Park, Oakham.*

SHROPSHIRE.—1. April for all the sections. Mona's Pride, *Myatt's Prolific, Beauty of Hebron, and Early Bird. Soil.—Light. 2. Woodstock Kidney, Gloucestershire, *Schoolmaster, and International. Soil.—Medium. 3. *Magnum Bonum, Scotch Champion, Vicar of Laleham, and White Elephant. Soil.—Heavy. Manures and Application.—Farmyard manure is applied at the time of planting.—JAMES RICKS, *Oakley Park, Market Drayton.*

SOMERSETSHIRE.—1. On a warm border early in February. In the open towards the end of March. Veitch's Improved Ashleaf, Rivers' Ashleaf, Suttons' First and Best (round), and *Beauty of Hebron. Soil.—Medium. 2. End of March. *Bliss's Triumph, *Suttons' Early Regent, Lapstone Kidney, and Woodstock Kidney. Soil.—Medium, clay subsoil. 3. Early in March as possible. *Schoolmaster, *Reading Hero, *Magnum Bonum, and *Scotch Champion. Soil.—Rather heavy, stiff clay subsoil. Manures and Application.—The early borders, being heavily manured for preceding crop, receive a dressing of lime only, applied in a quick state a few days prior to planting. The ground for the bulk of earlies and second earlies is usually heavily dressed with a mixture obtained from a large heap of decomposed garden rubbish applied when planting. The land for late varieties receives a liberal dressing of horse manure, and either soot or superphosphate of lime is dusted in the drills. General Culture.—We attach much importance to the preservation of the central sprout, especially those on the kidney varieties. We plant in shallow drills and earth up heavily, more particularly the late varieties. Earlies on warm borders are planted in rows 2 feet apart, and the sets 9 inches asunder, while those in the open receive another 6 inches. The same distance (30 inches) is found sufficient for the second earlies and Schoolmaster. The more vigorous late varieties are planted in rows 3 feet apart, and the sets 12 inches asunder. This proved ample room last season.—W. IGGULDEN, *Marston Gardens, Frome.*

1. End of February or early in March. Carter's Champion, Veitch's Improved Ashleaf, and *Myatt's Prolific. Soil.—Garden Crops.—Soil varies; naturally a loam of medium texture. The upper portion has through long cultivation and enrichment become a light soil, while the low-lying ground, originally heavy, has been so ameliorated by the continued application of limestone siftings, road sand, ashes, &c., as to be classed as medium. 2. End of March. *Fluke and *Dalma-hoy. Soil.—Field Crops.—Medium loam. 3. End of March or early in April. Victoria, *Walker's Regent, *Scotch Champion, and *Magnum Bonum. Soil.—Field Crops.—Medium loam. Manures and Application.—In the garden culture of the earlies we prefer to plant without manure on ground liberally dressed with farmyard manure for the previous crop, or use well-decayed leaf soil and old Mushroom beds mixed, strewing it in the trenches under the sets. In the field we apply in the same way a mixture of burnt ashes from the common rubbish heap, sifted coal ashes, and malt dust well incorporated. The malt dust is an excellent, and in this vicinity a very popular Potato manure. General Culture.—The greater part of our early and all late supplies are grown in the open field, alternating as far as possible with root and grain crops, for which the land is heavily dressed with farmyard manure. Planting is done with the spade, digging the ground and placing the sets in front of the line as the work proceeds. The rows for earlies are 2 feet apart, 1 foot from plant to plant, and about 4 inches deep, and disposed in beds running east and west

about 6 yards wide. The ranker-growing late varieties have more space given them. What I consider the most essential helps to success in Potato culture are the following:—First, yearly change of ground; second, frequent change of seed, say every two years at least; third, planting whole tubers of medium size; fourth, when growing keep the soil open by repeated surface-stirrings; and last, but by no means least, the proper preservation and condition of the sets at planting time. How can good crops be expected when exhausted sets, from which the first and best growths have been picked, are planted? In the case of the earliest for garden culture we place them all on end in shallow boxes in the light, but for large quantities this is impracticable. For field-planted earlies we have long shallow trays of three-quarter-inch wood about 15 feet long and 18 inches wide, with strips nailed on the sides. In these the sets are spread and the trays placed one above another on blocks of wood. These with their contents are shouldered by four men, placed on a waggon, and taken straight to the field without removal. We have tried autumn planting of pedigree Potatoes with great success, but the difficulty lies in getting the land in workable condition then.—ARTHUR MOORE, *Cranmore Hall, Shepton Mallet*.

STAFFORDSHIRE.—1. Second week in March. Ashleaf, *Beauty of Hebron, *Covent Garden Perfection, and Mona's Pride. Soil.—Rather light and rich, fully 2 feet deep. Subsoil, marl; substratum, clay, resting on a cold bottom. Early Potatoes, always abundant and good, if planted earlier are sure to be cut by frost. 2. April 1st. *Magnum Bonum, Snowflake, *Dalmahoy, and Paterson's Victoria. Soil.—Rather light. 3. April 10th. *Schoolmaster, Scotch Champion, *Skerry Blue, and Rector of Woodstock. Soil.—Medium. Manures and Application.—Good horse manure decayed applied in the autumn or winter and dug in. We manure rather heavily, as we grow Broccoli and other vegetables between the rows, otherwise I should use no manure for Potatoes. General Culture.—In order to insure the earliest crops the kidney varieties should be sprouted—that is, they should have an advancement in growth before planting. The Potato requires a deep thoroughly drained light soil, if the ground is new so much the better. The best crop I ever had was grown on the side of a hill; soil, light maiden loam.—EDWARD THOMAS GILMAN, *Ingestre Gardens, Stafford*.

1. December in frames, February outside. Veitch's Improved Ashleaf, *Early May, and *Early Racehorse. Soil.—For frames the soil is a mixture from the potting shed and spent Melon and Cucumber beds, with a little burnt earth and wood ashes added, which I find suits them well, the tubers turning out as clean and clear as I could wish. 2. March, first week. American Early Rose. Soil.—Our soil is of medium texture, and the above is suited so well that I grow no other. It is always heavy in crop and boils well. 3. March, first week. Schoolmaster and *Magnum Bonum. Soil.—Medium. Schoolmaster is not good on our soil, but Magnum Bonum is all I could desire both for keeping and cooking. It is also a heavy cropper. Manures and Application.—Chiefly stable manure, with a little from the farm, which is trenched-in during autumn, but not deeply. Artificial manures are not used for the kitchen garden.—W. A. PHILLIPS, *Patshull Gardens, Wolverhampton*.

SUFFOLK.—1. The first week in April. Rivers' Royal Ashleaf, *Myatt's Prolific Ashleaf, Porter's Excelsior, and *Beauty of Hebron. Soil.—Medium. 2. Second week in April. *Covent Garden Perfection, *Beauty of Kent, Woodstock Kidney, and Queen of the South. 3. First week in March. *Magnum Bonum, Schoolmaster, *Scotch Champion, and Adirondack. Manures and Application.—Good farmyard manure well dug in, or ploughed very deep in autumn. General Culture.—Dig the land well in the spring just before planting-time, so that the manure may be well mixed with the soil. After planting, and just before the shaws push through the soil, well fork between the rows. When the shaws are about 6 inches high earth them up with a hoe, and fork between them again after earthing. Plant early kinds 2 feet apart, second earlies 2½ feet, late varieties 3 feet apart.—WILLIAM ELLINGTON, *West Row Gardens, Soham*.

1. From the end of February to the middle of March. Old Ashleaf, Veitch's Improved Ashleaf, Rivers' Royal Ashleaf, and Myatt's Prolific Ashleaf. Soil.—Light sandy soil and not very rich for the first and second earlies. 2. From the middle to the end of March. Schoolmaster, Lapstone, Snowflake, and Dalmahoy. 3. The end of March and beginning of April. Magnum Bonum, Regents, Paterson's Victoria, and Reading Hero. Soil.—Light shallow sand on chalk. Manures and Application.—The manure we use is from spent hotbeds. For early Potatoes it is dug in and the Potatoes planted at the same time. The ground for the second earlies is dunged and dug about the same time, and the Potatoes planted with a dibble at the time stated. The late varieties receive no manure.—General Culture.—The early Potatoes are grown on borders round the walls, and the second earlies in the open quarters. They are planted 2 feet between the lines. We generally have a good crop of very good quality. The late Potatoes are planted between the lines in young plantations, of which we plant from 20 to 40 acres every year. The ground is trenched two spits deep, and with the exception of an inch or two on the top the soil may be called a bright sand. The sets are planted in the lines from 15 to 18 inches apart, and in a moist season like the last they turn out well both in size and in quantity. The flavour cannot be surpassed. In dry seasons, even a

fortnight of very hot weather in the middle of summer, they are apt to receive a check, and when the ground is moistened will begin forming new tubers on those that were checked. They are not then so good in quality. The rainfall here for last year was 27.10 inches.—ALEX. MCARTHUR, *Elveden Hall, Thetford*.

1. Early in March. Veitch's Improved Ashleaf. Soil.—Mixed in places, strong clay subsoil. 2. Middle to end of March. Huntingdon Kidney. Manures and Application.—Stable manure. The ground is deeply worked, and the manure frequently buried as it comes from the stables. General Culture.—Planting is either done by opening a trench with a spade or by dibbling, the holes being made not less than a foot apart. The rows for Huntingdon Kidney are usually a yard apart, on some plots 5 feet, then a crop of Broccoli or winter greens is planted between the rows. I have tried a goodly number of sorts, both round and kidney-shaped varieties, but on our soil have found none to surpass, and extremely few to equal in all good qualities, the two named. With ordinary management the Huntingdon is a first-rate keeper. We have it in use as late in the season as old Potatoes are required, and it is uniformly good in quality throughout.—J. WALLIS, *Orwell Park, Ipswich*.

1. Early in February. *Veitch's Improved Ashleaf, Llangollen (a local name for a very good kidney), Suttons' Racehorse (much prized in this district), and King Noble. Soil.—Medium. 2. February if soil is in suitable condition; if not, early in March. *Schoolmaster, Woodstock Kidney, and Hanworth Superior. 3. April. *Magnum Bonum and Scotch Champion. Soil.—Inclined to heavy. Manures and Application.—The manure we invariably use for Potatoes is a mixture of manure from the stables and decayed leaves dug deeply into the soil in the autumn. About February, usually when we plant our earliest, we give the soil a dressing of wood ashes and other charred refuse, well incorporated with the soil, a little soot being mixed with it. General Culture.—We attach great importance to the preparation of the soil, and believe in having the ground deeply stirred in autumn and again well broken up at planting time. Our practice here is to plant our earliest varieties 30 inches apart between the rows, and afterwards plant autumn Cauliflowers between them. We invariably have heavy crops of Potatoes, and the last few seasons the Veitch's Autumn Giant Cauliflowers have been very large. We are curtailing the number of varieties. We have always grown a good breadth of Early Rose, but the quality is not good enough, so Schoolmaster is to be tried instead. Snowflake was also planted to a moderate extent, but the produce these last two seasons has not been satisfactory. Our late varieties are grown in a field, which is manured and ploughed as early as convenient in the autumn, and again well ploughed, harrowed, and broken up at planting time, planting in stretches in preference to on the flat. For all our crops we use moderately sized whole tubers, which we keep on shelves exposed to the light.—JAMES BOLE, *Somerleyton Hall, Lowestoft*.

SURREY.—1. Last week in February. Fox's Seedling, King of Earlies, Early Ashleaf, and *Myatt's Prolific Ashleaf. Soil.—Very shallow and dry, with a chalk subsoil. 2. Third or fourth week in March. King of Potatoes, *Schoolmaster, *Beauty of Hebron, and Bresee's Prolific. 3. First or second week in March. Queen of the Valley, Red-skin Flourball, *Magnum Bonum, and Scotch Champion. Manures and Application.—Mixed pig, cow, and horse manure is ploughed in during winter and the land well scarified in the spring. General Culture.—The Potatoes are dibbled in after the plough; then the horse hoes are used freely during the growing season before being earthed up with the moulding plough. I generally plant about forty-eight varieties.—C. OSMAN, *Bailiff, S.M.D. Schools, Sutton*.

1. As early in March as possible. Early Coldstream, Veitch's Improved Ashleaf, and Early Bird. Soil.—Light, chalk subsoil within 12 inches in most parts of the garden. 2. Middle of March. Schoolmaster, Covent Garden Perfection, Prince Arthur, and Woodstock Kidney. 3. Middle to end of March. Suttons' Reading Hero (most excellent), Vicar of Laleham, Grampian, and Scotch Champion (for field and market). Scotch Champions come of fine quality on the lightest ground, and seldom take disease; on heavier soil they grow coarser and are more liable to disease. Manures and Application.—Potatoes are planted on parts of the garden to which manure was applied for other crops the previous year. For field cultivation farmyard manure is placed on the stubble in autumn and ploughed in, ploughed again in March, and planted after the plough. No artificial manure is used. General Culture.—In the spring of 1882 I planted thirty-two varieties, including many new kinds, some of which proved tender and require rich ground; others I intend to try again in other situations. I, however, proved that the American varieties are not suitable to this soil, all being of poor flavour and subject to disease, though many of them are heavy croppers.—OLIVER GOLDSMITH, *The Gardens, Polesden, Dorking*.

1. Generally last week in February. *Rivers' Royal Ashleaf, *Myatt's Prolific Ashleaf, Veitch's Improved Ashleaf, and Early Hammersmith. Soil.—Light, and a tendency to being sandy. 2. First week in March. *Early Rose, *Beauty of Hebron, *Rector of Woodstock, and Suttons' Early Regent. Soil.—Medium loam. 3. First and second week in March. *Magnum Bonum, *Schoolmaster, *Scotch Champion, and Suttons' Red-skin Flourball. Manures and Application.—The land is ridged, and good decomposed farmyard manure is spread between the ridges a month before planting. General

Culture.—The stubble is ploughed up as early as possible in the autumn, cut across with the plough in January, well dragged or scarified and harrowed, finally throwing it in ridges, and manure is laid between if possible a month previous to planting. It is kept perfectly clean by hoeing, and the plants are well banked up.—THOS. SILENCE, *The Gardens, Nonsuch Park, Cheam.*

1. February 20th. Old Ashleaf, Veitch's Improved Ashleaf, Walnut-leaved Kidney, Fortyfold Early, and Beauty of Hebron. Soil.—Light sandy loam. 2. Early in March. Schoolmaster, Snowflake, Walker's Early Regent, and Covent Garden Perfection. 3. March 20th. The old York Regent, Scotch Champion, Magnum Bonum, and Paterson's Victoria. Manures and Application.—Well-decayed good stable manure. Early varieties are planted 2 feet apart in the rows, second varieties 3 feet, late varieties 4 feet. General Culture.—All well earthed as soon as clear from weeds at 4 to 6 inches out of the ground. WILLIAM KEMP, *Albury Park Gardens, Guildford.*

1. First week in March for all of them. Veitch's Improved Ashleaf, Rivers' Royal Ashleaf, and *Early Rose. Soil.—Sandy and rather light, but very much inclined to cake hard during the summer months. 2. We do not grow second early varieties, as the early and late varieties here answer all the purposes required. 3. *Scotch Champion, *Suttons' Magnum Bonum, and Paterson's Victoria. Manures and Application.—Well-decayed stable manure is employed, mixed with equal portions of soil from the garden refuse heap. General Culture.—We spread the compost over the ground, and then well dig it and dibble in the Potatoes in rows 3 feet apart.—E. J. BAYMAN, *Holmbury, Dorking.*

1. From end of January till middle of March. *Veitch's Improved Ashleaf, *Fox's Seedling, Giant King, and Royal Ashleaf. Soil.—Light sandy loam. 2. March and early in April. *Rintoul's Early Don, Dalmaahoy, *Grampian, and *Magnum Bonum, the last in some seasons is good to use when being dug. 3. April and early in May. *Magnum Bonum, *Victoria, *Dunbar Regent, and Champion. Manures and Application.—Short stable manure mixed with old hotbed materials. Sometimes the sets dibbled in after the ground is dressed and dug. I find the best results after dressing the sets as they are planted, laying on the manure and digging the ground as we plant. General Culture.—I should prefer to have all the planting done by the middle of April, but we are obliged to wait till the green vegetables are removed. I have always had Late Rose of very good quality here, and a first-rate cropper, but this season it is quite uneatable, and most of the other Americans are the same. I have grown the old Fortyfold for several years, but during the last few seasons the crop has decreased, otherwise it is one of the best midseason Potatoes. Magnum Bonum is here of extra fine quality, and certainly one of the best Potatoes for market or table, and we have scarcely had a diseased tuber.—JOHN BURNETT, *The Deepdene Gardens, Dorking.*

YOUNG GARDENERS.

I HAVE read with great interest the articles on gardening and gardeners. As a young gardener, having spent over seven years in bothies at various places, I never met young men generally as described by "G. H." on page 134. Head gardeners, as is stated on page 172, would not tolerate unsteady men; and, further, I venture to say that as a rule young gardeners compare favourably with any other class of men. In reference to "G. H.'s" suggestion on libraries, I do not think that it is in any way the want of books that keeps young men from reading. Books and papers upon gardening are so numerous and cheap that with the outlay of a few coppers weekly information can be had on every useful topic; yet libraries in gardens would be a great boon to many.

There are more failures by the want of perseverance than of ability, and no one knows what he can do until he tries. I would urge every young gardener to study the writings of their superiors, and consider who is to supply the succeeding generation with the privileges we now enjoy. Young men should endeavour by every possible means to make themselves competent to take the places of those who by their diligence and perseverance gained their distinction. Those amongst us who think more of seeking night than gaining knowledge had better leave the ranks, as they will do no good for themselves nor to the calling with which they are connected.—J. S.

PRESERVING MELONS.

LATELY, to pass the time, I had occasion to read Burnaby's "Ride to Khiva," and could not help wondering how the Khivans manage to keep Melons fresh and well flavoured all through their almost arctic winter. At the end of January he found them plentiful in the bazaars, and pronounced them to be better flavoured than any he ever tasted in England. Whether this was owing to his having tasted nothing in the fruit way for some time, or was really owing to their excellence, may be a question, for those brought home were by no means first-class. But is it not possible that the kind might be possessed of valuable keeping qualities

that might enable us to have Melons all the year round without the aid of excessive firing or the electric light? Captain Burnaby asserts that they are preserved by the dryness of the air. This may be doubted. At all events there need be no great difficulty in producing air dry enough and also cool enough. The man who shall invent a method or raise a variety that shall enable us to keep Melons like some of our Grapes from September till spring will confer a boon on us, whereas growing them in winter by hot water and the electric light will be no boon. The one system is excessively costly, the other should be inexpensive. Is there any reason why this should not be realised? So far as flavour and fruitfulness is concerned improvements are hardly possible. But let raisers now devote their energies to produce a Melon that may be kept to serve with Lady Downe's Grape in March, and the horticultural world will be indebted to him indeed. Even supposing only the first step he taken along the road we have indicated, the goal may one day be reached.—INVALID.



MR. SHIRLEY HIBBERD will give a LECTURE ON AMARYLLISES at the meeting of the Royal Horticultural Society on Tuesday next at 3 P.M.

— A DORCHESTER correspondent, "Crux," asks if any of our readers will kindly say if they find cocoa-nut fibre refuse a harbour for woodlice. They are a perfect pest in his garden, and he would not like to introduce the stuff if they are at all partial to it.

— THE dates of the NEWCASTLE-ON-TYNE FLOWER SHOWS for the present year are fixed as follows:—Spring Show, May 2nd and 3rd; Summer Show, July 25th, 26th, and 27th.

— A CORRESPONDENT thus alludes to CARDIFF CASTLE CUCUMBER: "For handsomeness, fertility, and hardiness allow me to recommend this variety. I grew it last year for the first time, and to those who have not yet made its acquaintance I would say, Do so."

— IT has been decided to open a subscription for a memorial to the late MR. JOHN SADLER, and that this should chiefly take the form of a fund applicable to the maintenance of Mr. Sadler's widow and family of seven children, who, in consequence of his sadly premature decease (at the age of 45) are left altogether inadequately provided for. Dr. William Craig, F.R.S.E., Lecturer on Materia Medica, Edinburgh School of Medicine (address, 7, Lothian Road, Edinburgh), is appointed Treasurer, and empowered to receive subscriptions.

— IN MESSRS. GARRAWAY'S Durdham Down Nurseries, Bristol, we recently noticed a very useful strain of CINERARIAS. They were remarkably dwarf, and produced heads of large well-formed flowers of a variety of colours. Such a strain of Cinerarias are well adapted for conservatory decoration, and for market purposes must prove valuable. Double Cinerarias are also well represented, and seedlings, which though inferior to Mr. Thomas Lloyd and other named varieties in the house with them, are still very serviceable. In another house a good batch of Begonia Roezlii was noteworthy. This will in time become equally as popular as the old and perpetual-flowering Begonia nitida, which it resembles, with the important exception of producing large trusses of bright scarlet flowers, instead of the pale rose-coloured blooms which we are most accustomed to.

— A CORRESPONDENT writes — "With reference to DR. PATERSON'S NOTE ON MATERIAL FOR POTTING ORCHIDS IN, has that gentleman never tried the roots of strong-growing Ferns

such as *Lastrea Filix-mas* and *L. dilatata*? I have employed the above for several years back. A most successful Orchid grower in the Doctor's own neighbourhood also employs Fern roots, with great satisfaction. I had the pleasure of visiting the collection under his care only a few days ago, and found some remarkably well-grown plants, the cool Orchids especially."

— MR. JOHN CARTER, Keighley, writes—"It may interest some of your readers to hear that after trying of many plants I do not find any so effective for edging either garden or shrubbery as *COTONEASTER MICROPHYLLA*. Small and young plants planted in April, about a foot apart and pegged down, form a graceful bordering in a few weeks. During the summer the longer growths should be shortened with secateurs, and in future years kept in any form to suit the taste. The flowers and red berries give a pleasing appearance during many months. *Cotoneaster* has not the stiff formal appearance of *Box*, nor the sombreness of *Ivy*."

— THE twelfth annual Exhibition of the TEDDINGTON ROYAL HORTICULTURAL SOCIETY is announced for Wednesday, July 4th, and will be held in the grounds adjoining Bushey Park Cottage. Ninety-three classes are provided, eighty-three being in three sections, for nurserymen, amateurs, and cottagers respectively, the remaining ten being special classes, in which the prizes are contributed by local supporters of the Society. Plants, flowers, fruits, and vegetables are all liberally provided for. The condition of the Society appears to be very satisfactory, for the financial account gives a balance of £22 14s. to its credit, an improvement of about £4 on last year.

— "F. W. B." writes to us as follows relative to the NON-ACKNOWLEDGMENT OF EXTRACTS FROM OUR COLUMNS, and published elsewhere:—"As you were so generous as to believe of me, in the *Journal* of last week, page 224, the non-acknowledgment of the paragraphs referred to was indeed quite unintentional—in fact, as you suggest, a pure accident on my part. Having satisfied myself that the omission was entirely my own, whatever of responsibility there is must rest on my own shoulders. As the articles in question are likely to reappear in book form I am especially pleased that an opportunity is still left to me to make some little reparation in the matter." This is just such a frank acknowledgment as we expected. We have had further letters on the subject of "manufactured" articles, and it is clear from them that the practice does not meet with general approval.

— AN American contemporary states that Strawberries and green Peas, fresh picked, from Florida are now on sale in some of the markets. Hothouse Tomatoes of insignificant size are retailing at 1 dollar (4s. 2d.) per pound, and Cucumbers 3 dollars (12s. 6d.) per dozen. Twenty-three quarts of Strawberries from Florida were recently sold in New York at from 1 dollar to 5 dollars a quart.

— WE are glad to observe by the schedule before us that the NORTHAMPTONSHIRE HORTICULTURAL SOCIETY, which held its first show last year, is in a satisfactory state, the income of the year—£753 9s. 3d.—having exceeded the expenditure by nearly £200. The Exhibition will be held this year on August 6th and 7th in Delapré Park, the schedule containing 125 classes. Prizes of £10, £6, and £3 are offered for twelve stove or greenhouse plants, and £5 is offered as the first prize for a miscellaneous collection. These prizes and some others for Ferns and fine-foliaged plants are open to non-members on payment of an entrance fee of 10s. 6d. In connection with the Society a seedling Potato exhibition will be held on August 6th and 7th, an exhibition of bees and apiarian appliances to be held at the same time.

— IN the issue of *L'Illustration Horticole* for February excellent coloured figures are given of *DENDROBIUM BIGIBBUM* and *CYPRIPEDIUM LAWRENCEANUM*, two very distinct and beautiful Orchids. The former is one of the most beautiful of the Australian Orchids, its large racemes of crimson flowers being very attractive. *Cypripedium Lawrenceanum* is entitled to rank amongst the finest of the marble-leaved species, the dorsal sepal being of great size, rounded, white streaked regularly from apex to base with warm purplish-crimson; the lip is also of a fine purple hue.

— IN the same issue of the above periodical is given a coloured representation of *ARALIA GEMMA*, a New Caledonian species introduced by M. Linden in 1875. It has long, graceful, pinnate leaves, the pinnæ being small but deeply and irregularly cut, imparting a very distinct appearance to the plant. It is said to succeed well in a greenhouse, or perhaps preferably in a temperature intermediate between a stove and that of the house mentioned. It is very easily grown, thriving in a compost of peat, leaf soil, light loam, and sand.

— WE have received the schedule of the ROYAL CALEDONIAN HORTICULTURAL SOCIETY'S SHOWS during the present year. The spring Exhibition will be held on the 4th and 5th of April, the summer Exhibition on July 11th, and the autumn Show on September 12th and 13th. The classes are very numerous, and have been judiciously framed with the object of enabling the greatest number of exhibitors to compete, while the prizes are good without being sensational. The amount offered in 139 classes at the spring Show is £258, in 103 classes at the summer Show £207, and in 148 classes at the autumn Show £240. At the first-named Show £5 is provided for the best table of plants, and a similar sum for six Azaleas. At the autumn Exhibition £5 is the chief prize for a collection of fruit, and £6 for twelve bunches of Grapes. The Corporation of Edinburgh also contributes £12 in three prizes for Grapes. The Shows are open to all competitors, whether members of the Society or not, and the commendable practice is adopted of paying the prize money on the days of the Shows. The finances of the Society are in a healthy state, there being a balance of upwards of £330 over the disbursements of the year.

— A HANDSOME folding writing cabinet with the following address has been presented to Mr. H. A. MANN at the New Somerby Literary Institute (the Rev. W. Nash in the chair) accompanied with a purse containing £10, on the occasion of his removal from St. Vincent's, Grantham, to take charge of the gardens at Denton Hall, Grantham. "Dear Sir,—We have great pleasure in waiting upon you to ask you to accept the above-mentioned testimonial as a small token of our appreciation of the high professional qualifications you have attained as a member of our ancient craft, which have been so fully proved to the horticultural community in the many successful achievements which have attended your career as an exhibitor, and by certificates, &c., which have been awarded you by the Royal Horticultural Society. Also in recognition of the valuable services rendered by you as head gardener to Mrs. Hornsby at St. Vincent's, an establishment with which your name will long be remembered, especially by those whose privilege it has been to live under you as foremen and pupils of your training. We beg to offer you our united congratulations on your appointment to the charge you are about to undertake; and we sincerely hope that that confidence which has been placed in you by both employer and those employed under you (in the situation to which you are about to say farewell) may be vouchsafed to you in the position on which you are shortly to enter, bearing with you the best wishes of the friends who have so liberally supported this our united offering.—(Signed) STEPHEN DAVIES, on behalf of the Subscribers."

— It has been decided by the Chambre Syndicale of Belgian Horticulturists to organise at Ghent an INTERNATIONAL MEETING OF HORTICULTURISTS on the occasion of the quinquennial Exhibition which opens on April 15th. This meeting has for object to offer to the horticulturists of all nations an occasion to discuss mutually a few of the intricate questions connected with the development of their industry and the extension of their commercial relations. Two main points are already inscribed as business of the day—one bearing upon the state the horticultural trade is placed in by the Berne Phylloxera Convention; the other of the necessity that common action of all horticulturists of the different countries should be taken, with a view to obtain the protection and advantages the horticultural industry has a lawful right to. Entertainments and excursions will be organised to the different horticultural centres of Belgium at the occasion of this meeting. A reduction of 50 per cent. is allowed on the Belgian state railway lines, and steps are being taken to have the same favour allowed from foreign ones. A Congress member ticket will be addressed to each adherent to enable him to partake of all advantages connected with his adhesion. No special imposition is claimed of the Congress adherents, but only persons connected with horticulture, by their interests or their known sympathies for horticulture are invited. All who desire to join in this Congress can obtain the requisite forms from M. Edm. de Potter, Secretary, Chambre Syndicale des Horticulteurs, Ghent, Belgium.

BRISTOL SPRING SHOW.

MARCH 14TH AND 15TH.

THE thirteenth annual spring Exhibition of the Bristol Chrysanthemum and Spring Show Society, held as usual in the Victoria Rooms, Clifton, was in every respect most successful. It is true the extremely cold weather prevailing had the effect of keeping away many large and valuable plants, and from the same cause the attractive groups usually exhibited by the Messrs. Maule & Son were absent; yet the large plants exhibited well filled all the centres of the tables, and formed admirable backgrounds to the long and wide bands of Hyacinths and other bulbous plants.

Hyacinths were shown in extraordinary numbers, of good average quality, and were the great attraction of the meeting. Many most creditable examples were staged; and this is all the more noteworthy, seeing that Hyacinths are much complained of this year, owing, it is presumed, to imperfect ripening of the bulbs. There was, however, nothing apparent of this in the premier prize collection of eighteen Hyacinths and twelve Tulips staged by Mr. G. Marsh, gardener to M. Dunlop, Esq., as these would have been difficult to surpass at any time, so exceptionally fine were they. In addition to the special prize of three guineas offered by the Treasurer, W. Derham, Esq., the Knightian silver medal of the Royal Horticultural Society was also awarded to Mr. Marsh, this being offered for the best twelve Hyacinths in any class. These consisted of Leonidas, Prince of Wales, Czar Peter, Pieneman, Madame Van der Hoop, King of the Blues, L'Innocence, Princess Mary of Cambridge, Lord Derby, L'Or d'Australie, Mont Blanc, and Gigantea; while the best pots of Tulips, equally as well grown, were of White Pottebakker, Keyser's Kroon, Proserpine, Yellow Pottebakker, and Yellow Tournesol. Mr. G. Howe, gardener to L. Fry, Esq., was an excellent second, the spikes of Hyacinths Charles Dickens, Lord Derby, King of the Blues, Blondin, Fabiola, and Mont Blanc being most noteworthy, and his Tulips were generally fairly good. The third prize went to Mr. W. Fox, gardener to Mrs. Hurle, for an even and good collection. Two others also staged meritorious collections. Mr. Marsh also staged the first-prize group in the well-filled class for twelve Hyacinths, distinct, these including good examples of Jenny Dcans, Grandeur à Merveille, Lina, and Macaulay. Mr. G. Webley followed closely with spikes remarkably sturdy, the bells being well developed. His best were Lord Derby, Pieneman, Baron von Tuyl, Leonidas, and Ida. Mr. E. S. Cole, gardener to W. Pethick, Esq., was awarded the third prize for a very slightly inferior group, and an extra prize was deservedly awarded to Mr. G. Howe.

Mr. G. Webley took the first of the special prizes offered by the Messrs. Garaway & Co. for twelve single Hyacinths in four colours, the exhibitor's examples of King of the Blues, Sir H. Havelock, Von Schiller, Czar Peter, Grandeur à Merveille, and La Grandeur being remarkable for the stoutness of spike and correspondingly good foliage. Mr. C. Taggett followed with very similar varieties well grown, while Mr. Marsh was awarded the third prize for good examples. The first of the prizes offered by J. D. Weston, Esq., for twelve Hyacinths in pairs of six distinct varieties was awarded to Mr. C. Taggett for slightly drawn but otherwise excellent pairs of King of the Blues, Madame Van der Hoop, La Grandeur, Lord Ma-

caulay, Baron von Tuyl, and Florence Nightingale. The second prize was awarded to Mr. G. Howe, and the third to Mr. F. Perry, gardener to H. C. Miles, Esq., both well deserving the awards. The best six Hyacinths, distinct, were staged by Mr. E. S. Cole, he having Queen of the Hyacinths, Czar Peter, Mont Blanc, and C. Dickens in good condition. Mr. G. Milliner, gardener to Miss Richardson, and Mr. W. Lintern, gardener to W. Butler, Esq., took the remaining prizes in the order named, these and several others staging creditably. The prizes offered by Mr. E. J. Burgess for twelve Hyacinths in not less than six varieties brought together an excellent class. Mr. W. Dobson was first with massive spikes, but pips small, the best being Ida, King of the Blues, Alba superbissima, and Mont Blanc. Mr. Marsh was a good second; and Mr. W. Rye, gardener to J. Derham, Esq., took the third prize for a neat brightly coloured group.

With four pots of single Tulips in a large class Mr. G. Milliner, gardener to Miss Richardson, took first honours, his examples of White Pottebakker, Vermillon Brillant, Keyser's Kroon, and Proserpine being even and good in form and colour. Mr. Webley was placed second, his collection including good pots of Chrysolora and White Pottebakker. Mr. J. Goddard, gardener to R. H. Symes, Esq., was placed third for a very dwarf even lot. In the corresponding class for double Tulips Mr. C. Taggett took the lead with well-grown examples of Rex Rubrorum, Imperator Rubrorum, and Red and Yellow Tournesol. Mr. Marsh and Mr. W. Fox took the remaining prizes in the order named, and these two exhibitors were respectively first and second with six pots of Polyanthus Narcissus.

A silver cup of the value of four guineas was offered for the best group of plants in bloom, exclusive of Orchids, and this was easily won by Mr. W. Rye, who staged a highly creditable collection, comprising Azaleas of all sizes, a large Rhynchospermum jasminoides, Imantophyllum miniatum, Bonvardias, Pimelea spectabilis, Deutzias, Spiræas, and bulbous-rooted plants. Mr. F. Perry followed with a more flatly arranged yet showy group, in which Rhododendrons, Belgian and Indian Azaleas figured largely; he was also the only exhibitor of a bank of plants in which Orchids were admitted, and was awarded the first prize and Knightian bronze medal of the Royal Horticultural Society. Of these the most conspicuous were Cypripedium villosum, C. Boxalli, C. barbatum, Odontoglossum Alexandræ, Cattleya delicata, C. Trianae, Dendrobium nobile, Lycaste Skinneri, Lælia harpophylla, and Masdevallia Lindeni, the latter being remarkably good. The best specimen Orchid, a Dendrobium nobile, measuring from 3 to 4 feet in diameter, and crowded with blooms, was staged by Mr. E. Miller, gardener to F. Tagart, Esq.; the next best, a large pan of Coelogyne cristata, equally flowered, being staged by Mr. F. Perry. The third prize was awarded to Mr. J. H. Stevens, gardener to S. Budgett, Esq. Prizes were offered by A. Baker, Esq., for six Ferns, Mr. Bannister, gardener to H. H. V. Ames, Esq., securing the first for fine healthy specimens of Adiantum farleyense, A. formosum, Gymnogrammas, and Blechnum corcovadense, while Mr. H. K. Ward followed very closely with somewhat similar varieties. The latter exhibitor reversed the position in the class for four fine-foliaged plants, as he secured the premier award for medium-sized but healthy and highly coloured specimens of Croton Weismanni, Anthurium crystallinum, Ananassa sativa variegata, and Maranta zebrina; Mr. Bannister was a good second. The best six ornamental-foliaged plants, which included large specimens of Croton interruptum, Latania borbonica, and Pandanus Veitchii were shown by Mr. Rye, Mr. S. Budgett taking the second prize for a creditable group. Special prizes were offered by P. H. Vaughan, Esq., for a single specimen stove or greenhouse plant in flower, and the first of these was secured by Mr. G. Howe with a grandly bloomed Imantophyllum miniatum, the second prize going to Mr. Perry for a very good Genetyllis tulipifera. Forced hardy hardwooded plants were fairly well shown, the best being by Mr. O'Brien, gardener to Mrs. King; the second prize going to Mr. W. Fox; and Mr. O'Brien was also successful with Rhododendrons. Large Azaleas were well shown by Messrs. C. Taggett and E. S. Cole, who took the principal prizes. Numbers of beautifully flowered Azaleas, suitable for table decoration, were shown, the best pair by Mr. Bright. Table plants and small Ferns are always well shown at Bristol, and include neat well-coloured Dracænas, Pandanus Veitchii, Aralias, Crotons, and Adiantum cuneatum, A. gracillimum, A. farleyense, Lomaria gibba, and other Ferns. In these classes the most successful exhibitors were Mr. Loosemore, gardener to W. Cooper, Esq., Mr. E. Miller, Mr. Bannister, Mr. S. Budgett, and Mr. Prideaux.

Cinerarias were shown unusually well, and better plants than Mr. F. Edwards's, gardener to J. Lysaght, Esq., the premier exhibitor, would be difficult to find. The heads of large well-formed blooms averaged 15 inches in diameter, and those staged by Mr. N. Hockey, gardener to H. Mordan, Esq., and Mr. M. Cole, gardener to R. B. Cater, Esq., were only slightly inferior. Chinese Primulas, again, both double and single-flowering, were very fine, the first and second prizes for the former being taken respectively by Mr. G. Howe and Mr. Rye; and with the singles Messrs. W. Lintern and H. K. Ward were deservedly successful. Lilies of the Valley were remarkably well shown by Messrs. Howe and G. Shelton, gardener to W. K. Wait, Esq.; Marie Louise Violets by Messrs. Pethick and H. K. Ward; Cyclamens by Messrs. Howe and W. Rye; and Tricolor Geraniums by Mr. C. Taggett.

Hand and button-hole bouquets and vases of cut flowers are invariably well represented at these shows, and were very attractive

and good on this occasion. As a rule the bouquets were too closely packed, but as regards shape and the quality of flowers employed they were perfect. Messrs. Loosemore, E. Miller, gardener to F. Targart, Esq., and J. Goddard took the prizes in the order named for bouquets from which Orchids were excluded; and in another class for which prizes were provided by Mrs. Yates Stevens, Messrs. W. Pethick, E. Miller, and J. Loosemore secured the awards. The vases of flowers for table decoration were extremely light and elegant, very choice flowers predominating. The prizes were taken by Messrs. T. Pease, W. Pethick, and W. Butler in the order named. Cut Roses were fairly well shown, and included an excellent stand of Teas from Mr. Gowing, gardener to C. Fisher, Esq., the same exhibitor also staging other blooms not for competition. The best were of Catherine Mermet, Souvenir d'un Ami, Niphotos, Madame Willermoz, Anna Ollivier, Cheshunt Hybrid, and Rubens. The second prize was awarded to Mr. M. Cole for a creditable stand, which included good blooms of Catherine Mermet, Comtesse Rose de Paris, Madame Bravy, Empereur de Maroc, and Maréchal Niel. Muscat of Alexandria and Lady Downe's Grapes and Telegraph Cucumbers were very well shown by Mr. J. Gibson, gardener to Mrs. Miller, who took the first prize in both instances; and Mr. Loosemore had Lady Downe's Grapes in good condition, and was awarded the second prize. Apples were shown by Messrs. Milliner, E. T. Hill, and Webley, and Pears by Mr. T. Pease.

Messrs. Garaway & Co., Durdham Down Nurseries, in addition to lending a number of large ornamental-foliaged plants, staged upwards of two hundred Hyacinths, and which made a very effective display. All were well grown, but the best spikes were of Lothair, Grand Lilas, Tricolor, Grand Blue, Lord Byron, Charles Dickens, Pieneman, Fabiola, L'Innocence, Cavaignac, King of the Yellows, Prince of Wales, Maric, L'Or d'Australie, and Beauty of Waltham. On the whole a most attractive exhibition was arranged, which greatly redounded to the credit of the experienced and energetic Honorary Secretary, Mr. Webley, and the Committee, which, it will be remembered, is composed exclusively of practical gardeners. Many special prizes other than those enumerated were provided, but in other respects the inhabitants of Bristol and the aristocratic neighbourhood of Clifton are scarcely so appreciative as these annual extensive exhibitions fully merit.

THE CHRYSANTHEMUM ELECTION.

IN looking over the result of the Chrysanthemum election I find eleven electors bracket Refulgence and Inner Temple as the same variety. This is curious, seeing that Inner Temple grows as coarse as Prince Alfred, while Refulgence has more the habit of Prince of Wales. Inner Temple is much wider in the petal, while the colour resembles Arigena. I fail to see any difference between Mr. Bunn and Golden Beverley, and should not like to exhibit them in one stand. With regard to Mrs. Heales and Princess of Wales they are distinct enough for any purpose, being at the least quite as distinct as Queen of England and Empress of India. That Mr. G. Glenny should obtain a place in the first twenty-four seems strange when such varieties as Baron Beust, Angelina, Mr. Brunlees, and Mrs. Shipman failed to do so. Having been a regular reader of the Journal for fifteen years I trust you will excuse me troubling you with these notes.—J. HOLMES, *Nightingale Lane, Balham.*

IN briefly expressing my thanks to the Editor and all concerned in the recent election of Chrysanthemums, I must say how greatly I have been interested in the same. As a large grower, I must confess I felt very much surprised at the way many varieties have been bracketed together as too much alike, when in many cases they have been quite distinct. I cannot pass the discussions which have followed without noticing Mr. Moorman's remarks on page 178, where he says Princess of Wales and Mrs. Heales are so closely allied that they ought not to be admitted on a stand of twelve varieties. Now in this I must disagree with him, as when properly represented they are quite distinct. I have Mount Edgcombe, which is quite dissimilar from Mrs. Rundle, and with me Mr. Howe is larger and of a different shade of colour from John Salter, though they are much alike in other respects. I quite agree with Mr. Orchard (page 190), and find White Globe, Isabella Bott, and Empress of India quite distinct, as also are Golden Beverley from Mr. Bunn. The last-named is an acquisition to any collection, and only wants to be better known to be appreciated.

I concur in the remarks of Mr. Etherington (page 195) respecting the desirability of an election of Japanese varieties, which would prove to be of great service to many of your readers; and I hope, if an election should take place of these special favourites, that we shall have them elected, a certain number best for exhibition, and a certain number best and most suitable for decorative purposes.—W. A. WALTER, *Gayton House.*

THE Chrysanthemum election promises to lead to a thorough

revision of all the most important varieties. This will be a boon to many, and thanks are due to your Journal and to all who are aiding in reducing confusion to harmony. It appears to me that several contributors did not clearly understand what was meant by too-much-alike varieties, as it is evident that several have bracketed varieties on the ground of similarity in colour only; but there are other points to be taken into consideration. Lady Hardinge and Lady Slade are alike in colour, but the build of the flowers is very different. Pink Perfection, Venus, and Lady Hardinge certainly resemble each other in colour only; General Bainbrigge and Beauty of Stoke are very much alike in colour and build, or I have not had the correct variety of Beauty of Stoke. Mr. Moorman thinks they are quite distinct; I consider them third-rate varieties. Vesta has been described as a reflexed flower. I have known it eighteen years, and have always found it an incurved flower, and a very free and useful variety, of which I have seen remarkably fine blooms.

Varieties have been mentioned as too much alike that bear no resemblance whatever to each other either in character of flower, colour, or foliage—for instance, Angelina and Mabel Ward, John Salter and Angelina. One contributor speaks of Mrs. Rundle and Mrs. Shipman being alike, while the former is pure white and the latter fawn colour. Again, Isabella Bott is white, while Lady Hardinge is pink.

I am surprised that Golden Queen did not stand higher in the election, but with the votes accorded to Emily Dale it would have been in the twenty-four. I thought it would have been in the first twelve. I also think Golden Empress of India should have the place of Prince Alfred. Crimson Velvet is a reflexed variety; Mons. Bonamy, which I presume is meant for Louis Bonamy, is Anemone-flowered. I hope the Editor will open an election of Japanese varieties, which I am sure would meet with a cordial reception.—GROWER AND EXHIBITOR.

LIFTING VINES IN MARCH.

I READ with much interest Mr. Bardney's article on the above subject, and feel sure that what he says about the desire to root out Vines and replant being so general, especially with young gardeners, is very true. It is astonishing what can be done in the way of lifting and laying Vine roots in new soil. I have seen every root belonging to a Vine lifted, entirely freed from old soil, laid in fresh turf, &c., the result being a new lease of life to the Vine, finer wood, and larger bunches. I have lifted the roots of late Vines in autumn when the leaves were just about to fall, and with all the fruit on the Vines. No apparent injury was done to the Grapes, which hung fresh and plump till January. The Vines broke well, grew strongly, and have ever since continued to improve in strength and fruitfulness. When convenient, however, I would lift Vine roots in spring, say March, in preference to autumn. At present we are renewing the soil of a Vine border where the Vines have been for a number of years undisturbed. The roots are found inclining downwards, but they are all being brought near the surface, and laid in new soil. Mr. Bardney is very right to advocate an extensive growth of foliage in connection with newly lifted Vines. I may perhaps be allowed to add that the article in question (page 189), is one that should have the attentive perusal of all who are wishing trustworthy information on the subject of lifting Vine roots.—N. W.

CURRENT TOPICS.

SUBSTITUTES FOR MAIDENHAIR.—At page 197 Mr. Taylor recommends sprays of the Red Cedar as a substitute for Maidenhair. Its fault is there pointed out. A better is the thin, drawn, slender twigs of Box, either from the centre of bushes or from those grown in the shade. These are bright green, are elegant, and, above all, will retain their freshness for a week or more in the driest atmosphere. We have some here a fortnight old, perfectly fresh, which have withstood atmospheric conditions that withered matured fronds of *Adiantum cuneatum* in a few hours. Greenery in winter is scarce; even those who have the best appliances are glad to look out for a substitute for Maidenhair then, but those whose appliances are not of the best are glad of such substitutes as we have named. Ivy, Mahonia, and other leaves are charming, and might be oftener used.

THE GROWTH OF TREES.—Referring to the quoted remarks at page 197, we may be allowed to remark that the growth of trees, at least so far as length of annual growth is concerned, depends much more on the character of the preceding summer, and especially autumn, than on the meteorological conditions of the summer in which they are made. When the summer previous is warm and the autumn also warm, trees of all kinds go

on storing matter, and the consequence is a strong growth the year following. This applies much more to young than to old trees, however. But following a wet late summer and autumn the growth is much less, simply because the store of organised material is small. In the case of matured trees something very different happens. A fine summer and autumn is then followed, not by an extra growth, but by an abundant crop of fruit, whether of Pears, Apples, Cones, or Chestnuts matters not. This crop absorbs what the leaves elaborate, and the annual deposit of wood is small. But a spring frost may interfere, and then a thick layer of wood results. So after a dull wet year the crop of fruit may be small or nothing, and then the timber formed may be actually greater than after a good summer. The subject is complicated, so much so that the reading of the meteorological characters of bygone seasons by measuring the thickness of annual timber rings is sure to lead to error; not that any particular ring may not indicate the nature of the season in which it was made, but it may indicate something else.

AERATION OF SOILS.—Is Mr. Taylor at page 194 altogether consistent? At one place he speaks of the advantage to the soil of aeration, and shows how best to secure it—namely, by the supply of abundance of water to soil “thoroughly drained.” But he seems to think that this aeration is not necessary in flower pots; for them he would, under certain conditions, deprive of drainage altogether! Is he not also wrong in saying that the soil in pots is too much aerated? Is he not putting the saddle on the wrong horse? Rather is it not too rapid evaporation that does the mischief? And is it not that we seek to check when we plunge in shade our pots? With nearly everything Mr. Taylor says we agree, but on the above points are sceptical.

THE POTATO FUNGUS.—In Mr. Bravender's report at page 191 there is a statement that seems to require explanation. Plentiful manuring, according to him, secures a greater “margin of profit,” because it secures a larger crop; but such Potatoes, though sound, have “the mycelium of the fungus largely developed in them,” and are therefore unfit for seed. Only sound (or good) Potatoes are referred to, for there is “no objection to this”—*i.e.*, a heavy crop—“if the produce is to be consumed,” and, of course, men do not consume diseased Potatoes. As really good seed cannot be produced except in the way Mr. Bravender condemns, it is possible his remarks may mislead. Deterioration, swift and sure, will certainly follow the adoption of his method of raising seed. In fact, such practices alone make change of seed so necessary. Highly nitrogenous manure certainly tends to produce disease by causing a too luxuriant top growth: the same thing causes a reduction of the crop. The application of proper mineral manures tends to the vigorous increase of crop without unduly forcing the tops; and to disease-resisting varieties kept in the best vigour by the proper application of manures we look for full crops of sound Potatoes in future.

TIME TO PLANT POTATOES.—Unlike the rest of your correspondents I have found that it is good to plant late Potatoes before the midseason ones. The reason for this is that such as Victorias and Magnum Bonums come up a certain time after they are planted, and always slowly. Planted at the end of March or beginning of April they come up at the end of May; planted at the end of April they do not come up till June, and so some weeks of growing weather is lost. Midseason varieties planted at the end of March are up by the end of April or beginning of May, and are almost certain to be cut down by frost; planted towards the end of April they come up a month afterwards after the frosts are generally gone. Climate must determine the best time to plant, but I fear valuable time is sometimes lost by delaying the planting of late Potatoes, which come up slowly, until early kinds are planted, which come up rapidly.—**SINGLE-HANDED.**

BULBS UNDER TREES.

UNDERNEATH a belt of large trees here the soil is crowded with bulbs. The trees, principally Beech and Elm, which are growing on the east side of our lawn, were probably planted as a screen from the cutting east winds. Through these trees a gravel walk winds its way, on each side of which the display of violet Crocuses now and for a month hence, especially when the sun shines, is a sight not readily forgotten. These bulbs predominate; but besides these there are interspersed yellow and white Crocuses, also Snowdrops and Narcissuses in variety. They require no attention, and receive none in any shape or form. As to when they were first planted I have no means of ascertaining, but in all probability nearly half a century ago, and judging by their appearance they have not been disturbed during that time. That such bulbs will do well under trees ample proof is afforded here,

and they ought to be planted in such positions in thousands.—**J. RICHARDSON, Calverton Hall.**

PRUNING ROSES.

THE result of the mild winter and severe spring is now conspicuous amongst Roses of all kinds, and everybody is asking about pruning. The temperature ranged from 40° to 50° on every day in January and February, while the nights were correspondingly warm. The rainfall was also excessive, the total amount during the period named being nearly 6 inches in Surrey. Roses made growths from 2 to 3 inches long under those circumstances, many of them forming flower buds, which might be easily perceived by pressure with the finger and thumb, such sorts as Madame Victor Verdier, Pierre Notting, and other dark varieties being the most prominent in this respect. Pruning away these growths is looked upon by some persons as detrimental to the future prosperity of the plant, while others are over-anxious, and prune very early. Where this has been done, we fear it has caused the bottom buds to start and hence sustain injury by the severe frosts. Late pruning is thus the safest plan to adopt in our fitful climate.

As soon as mild weather returns we advise that all collections, especially in the south, be pruned without delay. Notwithstanding that young growths have issued not only from the extreme point but to some considerable distance down the stems, there will on examination be found almost at the base of last year's growth some three or four dormant buds. All Hybrid Perpetuals should be now cut back to a prominent out-looking bud, the weak growths being entirely removed with the object of producing an open and well-balanced head of strong wood, while this in turn produces strong growths and fine flowers. The prominent buds of some varieties are easily distinguished, but with Baronne de Rothschild and that class of rigid growers they are not so readily perceived, and in these cases the strongest bud must be found and cut back to, whether it appears high or low on the shoot. The more we use the sécateurs the better we like them for pruning Roses. The cut made by them is perhaps not so cleanly done as with the more ancient pruning knife, but the work is completed more expeditiously, and we have not found any harm accrue from the use of the former. The pruning of Hybrid Perpetuals, whether as standards or dwarfs, differs so little, that what is advised for one applies to the other; only in the case of dwarfs, if a bank or bed is required to be covered, some of the strongest branches if cut back below the growth may be pegged down. We have seen some very good and early blooms produced from these.

After pruning we dug the ground. This gives a neatness which is acceptable after the unattractive appearance of a rosery during the winter months.

Teas and Noisettes are not as a rule cut back so hard as Hybrid Perpetuals, and in the case of Gloire de Dijon and such-like strong growers the weak and dead wood only requires removing and the points of the shoots shortened, but they will have to be pruned closer than usual this spring. Nearly all the Hybrid Chinas, Bourbons, Ayrshires, Banksians, evergreens, as well as the better known Hybrid Perpetuals, Teas, and Noisettes, are suitable for walls and trellises. The majority of these ordinarily require but little pruning, merely the old, decayed, and weak wood being taken out and the extreme point of the shoots removed. Any young shoots made during the previous year from the base of the plant must be encouraged, and the older shoots cut away to make room for them. By attention periodically to this the base of the wall is prevented from becoming bare.—**J. W. MOORMAN.**

CLIMBERS, OR ROOF-COVERING PLANTS.

CLEMATIS INDIVISA.

It is a question if so little has been written on any other plant of equal merit as of this beautiful greenhouse climber or roof plant. Of late years the attention that has been given, and worthily, to the ever-increasing and increasing beautiful garden varieties of Clematises would appear to have resulted in the claims of this most attractive species being almost entirely overlooked. It is questionable if there is any plant more effective and that will command more general admiration at this season of the year than Clematis indivisa as seen with its festoons of white flowers hanging from the roof of a greenhouse or conservatory. The plant grows freely and rapidly in a border of peat and loam, and also succeeds well and flowers profusely in pots. Its adaptability for pot culture we never saw so forcibly exemplified as in Messrs. W. Paul & Sons' nurseries at Waltham Cross. Numbers of plants in 5-inch pots were laden with white star-like flowers so

completely that the foliage was scarcely visible. These plants varied in height from 1 to 2 feet, and would have been an important acquisition to any conservatory. The annexed figure is of a spray from one of these small plants, and the effect of a thousand of such panicles hanging from the roof of a house may be imagined. Clematis indivisa is a native of New Zealand, and has been in this country for many years. It is not a little surprising that it is not found in a great number of gardens, as it should be included in every select list of greenhouse climbers.

Being an evergreen it has a neat and not unattractive appearance after the flowers have faded, and it will grow in any cool house from which frost is excluded.

SO-CALLED LARGE BUNCHES OF GRAPES.

I THANK "Druid" and the Editor for forwarding to me a sample of what the former calls a "so-called large bunch of Grapes." I regret if my remarks appeared dogmatical, but I can

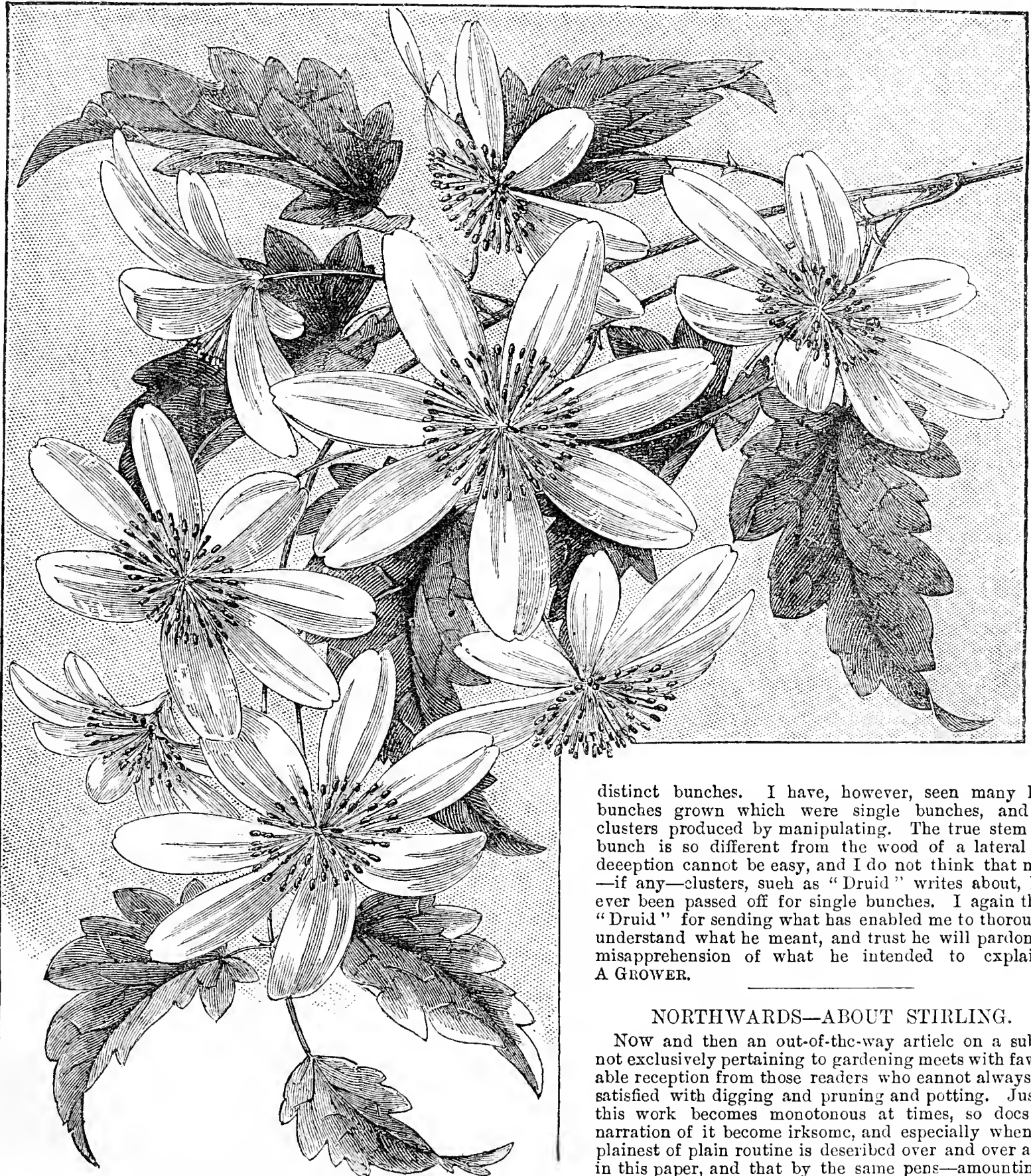

Fig. 63.—CLEMATIS INDIVISA.

hardly see how "Druid" can disclaim casting a slur on past exhibits. His first letter on this subject appeared to convey the idea that many of past large bunches were not "bonâ fide." From the sample sent I now quite understand what "Druid" means. The cluster sent is undoubtedly not a single bunch, but two

distinct bunches. I have, however, seen many large bunches grown which were single bunches, and not clusters produced by manipulating. The true stem of a bunch is so different from the wood of a lateral that deception cannot be easy, and I do not think that many—if any—clusters, such as "Druid" writes about, have ever been passed off for single bunches. I again thank "Druid" for sending what has enabled me to thoroughly understand what he meant, and trust he will pardon my misapprehension of what he intended to explain.—
A GROWER.

NORTHWARDS—ABOUT STIRLING.

Now and then an out-of-the-way article on a subject not exclusively pertaining to gardening meets with favourable reception from those readers who cannot always rest satisfied with digging and pruning and potting. Just as this work becomes monotonous at times, so does the narration of it become irksome, and especially when the plainest of plain routine is described over and over again in this paper, and that by the same pens—amounting to a mere ringing of the changes, with really no change at all beyond that from ding, ding, dong to dong, dong, ding. As change is certified by a high authority as only another word for rest, I will ask my audience to rest awhile from laborious work and accompany me in an afternoon's ramble in a district full of interest to all true Britons; and to take a stand on an historic site where kings and warriors of the past have stood, not always looking on a scene so peaceful

as we will look on now in all its pastoral beauty and rugged grandeur.

We are on the ramparts of Stirling Castle, a fortress so old that its early history is lost in obscurity, and remarkable alike by its position and associations, for here kings have been born, imprisoned, and died, and the fortress has been won and lost after long and desperate struggles more times than I can remember. But the period of turmoil is over; and the English, dreaded once, and repulsed many times, are welcomed now, for Stirling is a great centre for tourists, and he must be hard to please who leaves the town dissatisfied with either the inhabitants or their beautiful district.

Those readers of these notes, and they must be many, who have visited this romantic locality, will know that the castle rock rises abruptly to a height of some 300 or 400 feet from a level plain, and they will agree that those who have not seen it can form but a slight conception of its appearance and magnificent surroundings. It is pleasant to read of the delight that a visit to some fine old country seat affords; its park and lake, woodlands, lawns, and gardens, are described in a manner to which they are justly entitled; but from our standpoint a scene far grander than that from the most imposing of domestic terraces is spread out before us, and in which some half-dozen homes of the great are seen as the smallest features in the landscape. McNeil did not exaggerate when he penned the following lines on "The Links of Forth:"—

"O! grander far than Windsor's brow!
And richer, too, the vale below!
Whar Forth's unrivall'd windings flow
Through varied grain,
Brightening, I ween, in glittering glow
Sterlina's plain.
There raptur'd trace (enthroned on high)
The landscape stretching on the ee
Frae Grampian heights down to the sea—
A dazzling view!
Corn, meadow, mansion, water, tree
In varying hue."

That is a literally accurate description of the view before us. From one side we see the field of Bannockburn, where some four and a half centuries ago thirty thousand English troops were slain, and the statue of the conqueror Bruce, near which we stand, looks over the scene of his great victory. Entering by the drawbridge and passing through a pretty garden we look down from an almost dazzling height to the king's park and garden below, now used as a recreation ground, and on the wooded heights in the distance is Polmaise Castle, the seat of Col. Murray. Looking towards the Garvan hills the eye rests on another ponderous rock, Abbey Craig, surmounted with the Wallace monument—an imposing tower, completed in 1869 in honour of the Scottish patriot, Sir William Wallace. This is a favourite place of public resort, and, to strangers especially, is not less interesting, as they have a view of no less than six battlefields, in two of which both Wallace and Bruce displayed their prowess. Surely this is a sufficiently out-of-the-way circumstance to entitle me to claim for these notes, as suggested, an "out-of-the-way" character.

The tower of Cambuskenneth Abbey arrests notice; it is very ancient, records pertaining to it nearly 1700 years ago still existing. Also within easy range of the vision are Airthrey Castle, the seat of Lord Abercrombie of Aboukir; Keir, described on page 550 last volume; Drummond House, the seat of Charles Home Drummond Moray, Esq., of Blair Drummond; Touch House, the seat of Sir Henry Seton Stewart, Bart. Still nearer the rugged eminence of Craigforth, while at our feet is the picturesque cemetery grounds which were purchased and laid out by that great benefactor and good man the late Mr. William Drummond, who further invested a sum of money for keeping them in order. It will be granted now our standpoint is commanding, and dwarfs by comparison the panoramas which are spread before mansions we are apt, and not unfairly, to call "great." Only one of the seats above mentioned I had an opportunity of visiting, and am happy, therefore, in having an excuse to go to Stirling again; but there was one little spot down in the carse below, and apparently not more than a mile distant, that I left behind even more reluctantly than all—the snug home of the famed octogenarian *Auricula* grower, Mr. Meiklejohn; but the exigencies of Fleet Street permitted no delay, and for the same reason I was denied the anticipated pleasure of a gardener's grasp with the "Northern Amateur," who writes so entertainingly on gardens and flowers in the north, and grows them so well but a few miles distant. Quite naturally, and almost unconsciously, I have glided into gardening. It is the usual result. Start from whence I may I somehow "land" in a garden. And now for a violent plunge from battle fields to Orchids.

DR. PATERSON'S GARDEN.

This is quite of an out-of-the-way character, but is not in an

out-of-the-way place, for Bridge of Allan is very accessible, being the first station from Stirling on the highland route, and within two miles from the town. Of this village the local chronicler, Mr. Shearer (whose "Guide" all visitors should obtain), applies Goldsmith's familiar lines as a "word painting"—

"Sweet Auburn, loveliest village of the plain;"

and it is certainly charmingly situated, admirably sheltered, and salubrious. Dr. Paterson is an old and honoured resident of this popular watering place, and is famed for much more than Orchids; but it is with these we have more immediately to deal.

After seeing the splendid specimens from the Fernfield collection that were sold in Edinburgh in September, and which realised some £800, and then visiting the houses in which they were grown a week afterwards and finding them yet well furnished, a stranger could not fail to be struck with astonishment. He would be excused even if he declared it impossible that such plants could have been grown in the small structures in the doctor's villa garden; but they were grown there, and hundreds still remain of great value and in superb health. If there are any individuals remaining who are deeply impressed with the idea that Orchid culture is difficult and costly, that expensive structures of some special design are requisite, and that fuel must be consumed at an extravagant rate to maintain a high temperature, let them visit Fernfield, and all such notions will be dissipated in an hour. For gaining a lesson on Orchid culture made easy it would be a task to find a more competent tutor than Dr. Paterson. Long experience has shown that great results can be achieved with small conveniences and simple methods. Common sense and moderate temperatures appear to be the governing principles here. If the house is in any sense uncomfortable to the owner—too "stuffy" and oppressive—it is deemed unsuitable for the plants. Fresh air without draughts, a sweet genial atmosphere, and a temperature in which a person may remain for an hour with his coat on, is fairly characteristic of the doctor's Orchid house, where *Cattleyas*, *Vandas*, *Phalænopsis*, and other forms flourish that are so often found languishing in excessive heat. Similar results may be seen in Mr. Smee's rapidly growing collection of upwards of four hundred species at Wallington, where interesting experiments are being made, testing the effects of climatic influences on various plants. "Admit air freely" is Dr. Paterson's axiom, but (an important "but" this is) "always on the leeward side of the house." Even with a door open on certain days there is no draught then, but a moist yet buoyant atmosphere can at the same time be maintained. Dry floors and houses with driving currents of air—always opening the ventilators on the same side of a house from whichever quarter the wind may be blowing—will ruin almost any Orchids, even "cool house" kinds; while no amount of heat applied to tropical kinds can atone for that initial mistake. Such mistakes are never made by the doctor, and the still lingering dictum that high temperatures are indispensable for Orchids is emphatically dispelled by the admirable condition of his plants.

And now as to the costliness of culture, the evidence of the sale referred to may be adduced. A grand example of *Cattleya labiata Warneri* with seventy-nine bulbs and sixty leaves realised forty-five guineas; *C. labiata* and *C. Trianae Symei* thirty-nine guineas each, and *C. Mendeli* twenty-seven guineas; *Dendrobium thyrsoflorum Walkerianum* thirty-seven guineas; *Lælia anceps Barkeri* twenty-six guineas; *Aerides Fieldingi* twenty-five guineas; *Vanda tricolor Patersoni* twenty-one guineas; *Angræcum sesquipedale* eighteen guineas, and so on, until the above-named total of £800 was reached; and this out of three small houses in which scores of pounds worth were left behind, one house being, perhaps, 15 feet square, the other two collectively about 30 feet long by 12 feet wide, plain span-roofs, such as are usually devoted to *Pelargoniums* and *Fuchsias*, *Coléuses*, *Begonias*, and *Balsams*. So far from Orchid culture being costly, the "weight of evidence" tends to show that it is, when well conducted, decidedly profitable, for on the debtor side we have only to enter the doctor's leisure hours in potting and watering, assisted by a woman labourer for sponging the plants and keeping the houses clean, and the fuel. This is a comparatively small item where the temperature by fire heat ranges from 50° to 60°, and the position is sheltered, as it is in this case, by the Orchids on the east and well-wooded rising ground on the north. It is a simple fact that no more cost is incurred here in growing plants of such great value than is usually involved in the culture of ordinary stove and greenhouse plants.

These small Orchid houses must have been densely crowded before the sale, seeing that they are full now; the plants, however, being smaller are arranged on stages, while previously the large specimens were stood on the ash-covered floor. Instead of

giving a list of some of the plants in the collection after the sale, an enumeration of those flowering in February will better show what can be done and is accomplished in three small houses by an accomplished amateur. The list now published has been obligingly sent by "A Northern Amateur" who has recently visited Dr. Paterson, and was most agreeably entertained at Fernfield, as all visitors are of kindred tastes with the genial owner.

ORCHIDS IN BLOOM AT FERNFIELD, BRIDGE OF ALLAN, IN FEBRUARY, 1883.

Aerides Fieldingi	Godiera discolor
" Leeanum	Leptotes bicolor
" rosenum	Laelia acuminata
" vandarum	" albida var. pulchella
Angraecum citratum	" aneeps Barkeriana
" Ellisii	" harpophylla
" sesquipedale	" superbiens
Calanthe Veitchii	Lycaste Skinneri (several var. in flower, one grand)
Cattleya bnlbosa	" macrophylla
" Gaskelliana (showing fine spathe)	Masdevallia ignea
" Trianae (grand var. and fine plant)	" ochtodes
Chysis braetescens	" Shuttlesworthii
Coelia macrostachya	" Tovarensis
Coclogyne cristata	Neottia maculata
" ocellata	Odontoglossum Alexandrae (one var. yellow, fine and rare)
" flaccida	" bitionense
Cymbidium Lowianum (splendid var.)	" Bluntii
" sinense	" constrictum
" eburneum	" cordatum
Cypripedium Dayanum	" gloriosum
" Harrisianum	" Pescatorei
" insigne	" pulchellum
" longifolium	" rosenum
" Manlei	Oneidium aurosum
" pardinum	" incurvum
" Roezlii	" serratum
" Schlimii	" tigrinum
" Sedeni	" Weltoni
" venustum	Phalaenopsis Schilleriana (large branching spike)
" villosum	" Luddemanniana
Dendrobium bigibbum	Filumna fragrans
" Farmeri	" ossolata maxima
" Findleyanum	Saccolabium giganteum
" infundibulum	Sophranitis grandiflora
" Jamesianum	Uropedium Lindenii (showing three fine spikes)
" nobile caeruleseens	Vanda Cathartii
" Pierardi	" furva
" Wardianum	" lamellata Boxalli
" cambridgeanum	Zygopetalum Maekayii
" Freemanii	" Hookeri
Epidendrum eiliare	
" erectum	
" latifolium	
" rhizophorum	

While the above list indicates the character of the Fernfield collection, it is only in a degree, many rare and valuable plants in the best of condition not being in flower. These it is impossible to enumerate, and it can only be added that if anyone wants to see Orchid-growing made easy, and the most made of small means, let him pay a visit to Dr. Paterson at the Bridge of Allan, and he will be a very wise man indeed if he does not gain a hint that will be useful from the veteran orchidist who has proved his competency by such results that have seldom, if ever, been surpassed in such circumscribed limits as three miniature structures in a villa garden of the total extent of perhaps half an acre.

In the "grounds" of such a place not much can be expected that is noteworthy, yet there was a little in September. For instance, Masdevallia melanopses had been growing in the rockery for four months; Podophyllum peltatum was growing as if wild in a Rhododendron bed; Retinosporas were, and are, as fine as could be expected, if not finer, for R. plumosa is about 10 feet high, R. squarrosa 12 feet, R. pisifera still higher, all being proportionally broad and well furnished, while Abies grandis is grand indeed. Yet just one other plant must be mentioned, an altogether out-of-the-way plant—in fact such a specimen as was, perhaps, never before seen—a Wall-flower. And what about it? Well it was 9 feet high! one straight spike ripening seed. Besides the most modern of Orchids in the greenhouse, ancient historic relics may be seen in the study, for the Doctor is an archaeologist as well as an orchidist; yet amongst all his treasures nothing is more prized than his mementos of Queen Victoria, received on the occasion of presenting Her Majesty with a beautiful bouquet of Orchids at Perth.—J. WRIGHT.

NEW FUCHSIA, MRS. RUNDLE.—I saw this advertised, or referred to by some passing visitor to Swanley last year in the Journal, and soon after was fortunate in obtaining a cutting. It has proved a vigorous grower, and, so far as I can form an opinion, is a distinct improvement on Arabella Improved. That, to my mind, in most respects it resembles, more than it does Lord Beaconsfield. Mr. Cannell deserves great credit as the raiser of this fine variety, for

which, I see by your last issue, a first-class certificate was awarded at the last meeting of the Floral Committee of the Royal Horticultural Society. I shall try a small plant plunged in the border later on for flowering in winter.—W. J. M., Clonmel.

AURICULAS.

YOUR correspondents "D., Deal," and Mr. J. Luck seem to have a strange notion about strains of this favourite spring florist's flower.

"D., Deal's," friend is said to have a fine strain of Colonel Taylor. The plants which he has must be either Colonel Taylor or they are not. If they are Colonel Taylor then they must be the same as the Colonel Taylor of any other grower; but if the plants he has give better flowers than Colonel Taylor they cannot be the Colonel, and he should give them another name, and say who raised them. The same remark applies to every other variety.

"D., Deal," asks where the green-edged variety of Oliver's Lovely Ann originated, as it was sent out as a grey edge. I understand it was sent out as a green edge, but, like a number of greens, is somewhat inconstant. If the truss is from the heart of the plant it is almost certain to be grey; but if the truss comes from the side it is almost as certain to be green. "What is the cause of this?" I think I hear him ask. Well, my theory is this. A number of varieties have the outer leaves quite green—entirely destitute of farina—but have the centre a little mealcd. Lovely Ann is one of these. The truss coming from the side has no meal on it, whereas that from the centre partakes of the meally nature of the centre, converting the green into a grey. This is of course open to question, as some of our finest selfs have very white foliage.

Both your correspondents seem to have misfortunes with their plants as other growers have. I think it is likely that the plants they complain of are the offspring of starved plants, and I believe the mode they have adopted to restore them is the best—namely, a change of soil whether it be in pot or frame. See that the carrot is sound, keep them from blooming, and they will soon regain vigour.—W. S. B.

HEPATICA TRILOBA.

ONE of the most attractive hardy plants that commences to flower in February is the subject of this note. This season they have been particularly showy on account of the mildness of the winter. They last several weeks in perfection, and for spring bedding they are admirably adapted, also for planting at intervals in the mixed border—in fact planted anywhere, they could not fail to be appreciated when in flower. Where spring bedding is carried out the Hepaticas make a splendid edging. The colours of the flowers are much in their favour. Red, or more strictly speaking pink, white, and blue, are colours that are very suitable and easily matched. I find they are by no means fastidious as to soil, doing equally well on stiff clay as on a lighter soil, but with us they grow stronger if slightly shaded with trees. They are readily propagated either by seed or division. If it is intended to propagate by seeds the seed should be gathered before it is thoroughly ripe, and dried in paper to prevent its shedding. As soon as sufficiently ripe, which in good seasons will be about May, it should be at once sown in pans and placed in a cold frame. If the seed is good it will germinate through the autumn. The seedlings should be potted as soon as sufficiently large, and allowed to remain in the pots till they have flowered, by which means the colours can be tested, so as to prevent confusion in planting. I find this a very variable plant from seed. Division of the root no doubt is the quickest and most certain method. Hepatica triloba when not in flower is attractive on account of its shining trilobed foliage. There are several distinct varieties of this species: single rose, blue, and white, also double rose and double blue. They are, however, all worth growing either separately or in mixture.—G.W.

SEASONABLE NOTES ON FLORISTS' FLOWERS.

AURICULAS.—The cold wave, or whatever we may please to call it, which visited us on the 5th of March and continues up to the present date (16th), has considerably altered the prospects and hopes of Auricula growers as far as early flowering is concerned, and will, I fear, in other respects be damaging; and it is here that those who possess heated structures, if they use them judiciously, have an advantage over those who do not possess them. When the earth is frost-bound, and when—as there has been with me—nearly 8 inches of snow, and the frames are covered with it, it is not only impossible to apply water, but plants

stand still; and, what is probably worse, the young bloom is affected by the frost, and the pips then become ill-shaped; for although the Auricula is an alpine plant, and although—notwithstanding the manner in which it has been changed by cultivation—it will stand severe frost without the plant being killed, the bloom suffers materially from the effects of frost. We are now within an appreciable distance (five weeks) of the exhibition day, and it strikes me that it will be very difficult for those who have not the advantage of heat to have their plants in bloom for that time; while many who, like myself, consider fire heat injurious to the Auricula, would hesitate to use it even if they had it at command. On one point on which I have strenuously contended against the feature recommended by the National Auricula Society (southern section)—viz., using stakes for the flowering stems, I find that the resuscitated Bradford Auricula Society makes the use of them a disqualification—another proof to me that the north is the true home of the florist.

CARNATIONS AND PICOTEES.—Here again, although not to so great an extent, the cold weather of the last fortnight has interfered with the well-being of the plants. I have not seen mine during that time, as there has been 4 inches of snow on the frame; but as they were tolerably dry I hope and believe that not much harm has resulted from their forced imprisonment, as they were pretty dry before the hard weather set in.

GLADIOLI.—No planting has as yet taken place, but I shall commence as soon as the ground and the weather are suitable. I may here refer to "W. J. M.'s" notes in last week's Journal as to the statement made by him and denied by me that Mr. Banks left his Gladioli in the ground. He says that his informant, noticing my note, again told him that Mr. Banks had stated that one season the frost overtook him before he had finished taking up his bulbs, and that he would fain make that corroborative of his former statement. It seems to me just the reverse, as it shows that he always took up his bulbs, and that it was only by an accident that some that season were not harvested as usual. I do not think that the depth of planting has much influence, and the idea that 6 inches is too much and prevented the bulbs from coming up, and hence their loss, is falsified by my experience. Last year my best bed was planted from potted roots, all of which had made 6 to 8 inches of growth before they were planted, and yet many of these failed. As to the seeding, many of mine were cut off for the sake of the blooms for indoor decoration, and yet these died quite as much as others that were left. I have no trees anywhere near my beds, and yet the corms fail. I have found with "W. J. M." the whites most difficult to keep. Madame Desportes, Ondine, Shakspeare, and others seem most susceptible of disease. The first of these I have given up as hopeless, and I fancy the same difficulty is experienced with it across the Channel, for it keeps up its price while others sent out the same year are to be had for a few pence; and I am inclined to think that "W. J. M.'s" future experience will tend to confirm my views on the whole subject. If care and trouble would help me I should begrudge neither for a flower of which I am immensely fond.

RANUNCULUS.—My bed of these was planted when the ground was in good condition, but what the result of this severe weather on them will be I cannot tell. I fear it will not be favourable. I have been much struck with the effect of the very wet weather on the Turban Ranunculus; those which I planted in October are only just making their appearance. This I can only attribute to the excessive coldness of the ground and the absence of sunlight.

PINKS AND PANSIES have had a hard time of it. Slugs have been busy at them, the wet has been very trying, and now that this severe frost has come on them they look miserable indeed. They will, as soon as the ground becomes a little drier, have to be examined and fixed securely in the ground. Those who have Pansies in pots will now be looking for the earliest blooms, and in every way, with us in the southern parts of the kingdom, this is the most satisfactory way of growing them. I have often envied the beautiful plants out of doors in Scotland and the north; but we cannot have everything, and I rather think in our "Garden of England" we have the best of it.—D., Deal.

CULTURE OF CALANTHES.

CALANTHES rank amongst the most useful winter-flowering Orchids we have, and the easiest to cultivate. Anyone having a few bulbs may easily raise a good stock, especially of *C. Veitchii*, which is about the best and most effective. The only disadvantage connected with Calanthes is that the foliage fades when the plants flower, but that is remedied by placing the pots amongst Ferns, from amongst which the spikes arch gracefully. The best time to repot Calanthes is just when they commence growing. Those who have only a few bulbs will find it best to

pot them singly in small 48's in the following compost—two parts of fibry loam, one part of peat, and one part of well-decayed cow manure, with a liberal sprinkling of silver sand and charcoal. The pots should be three parts filled with drainage. Place them in a temperature of 65°, but do not give any water until the bulbs commence growing, and they should only have just sufficient to make the compost moist until they are well rooted, after which they should be well supplied. After the pots have become filled with roots the plants will be greatly benefited by liberal applications of liquid manure, and the atmosphere must be well charged with moisture. When the flowers show colour the atmosphere must be kept drier; when in bloom a temperature of about 60° suits them admirably, and they will last a long time in full beauty. After the flower spikes have decayed no water should be given until their growing season again commences.—A. YOUNG.



[By the most skilful Cultivators in the several Departments.]

HARDY FRUIT GARDEN.

Protection.—Recent frosts have been so severe that buds of early-blossoming Pears have suffered in a few instances where the trees could not be covered. Warm sunny days followed by cold frosty nights may lead to further injury. Watch the progress of the buds closely and give shelter promptly as it becomes necessary, a single night's exposure may now destroy the blossom. Whatever is done for protection should be as thorough as possible; therefore carefully consider ways and means, and only do what can be well done. Far better is it to save the crop of half a dozen trees, if to protect them thoroughly exhausts the time and means at disposal, than to spend strength in vain efforts to protect half a hundred. See that every appliance for shelter is made secure; tender buds and flowers have not unfrequently been battered to pieces in a high wind by mats or tiffany blown loose. Coping boards afford shelter from frost to wall trees, but they do very little good alone when severe frost is accompanied by high winds, as it has been so frequently of late. Stout tiffany stretched on poles thrust into the ground and fastened to coping boards serves admirably as a screen, and will preserve the blossom from injury in very cold weather.

General Hints.—The nearness of Lady-day reminds us that it is the season for a change of residence for many owners of small gardens. To all such the cold weather will be welcome, as it has much retarded the growth of fruit trees. Not a day should be lost in filling any vacancies, and by the exercise of due care there is no reason why the trees should not only live but make a fair growth this year. The points of especial importance for such late planting are enriching the soil with sufficient well-decayed manure to induce a quick, strong, free root-action, mulching the entire surface of the station with rough half-decayed manure, securing the tree firmly by means of wire or stakes, and by frequent subsequent waterings not only in dry weather, but every week when there is no rain, of an hour or two's duration.

All neglected pruning should also be done speedily. Be not rash or hasty in the treatment of trees of doubtful aspect. Barrenness or decay are, however, not difficult to discover, and the condition of each tree can alone suggest the right remedy—it may be a simple re-invigoration by means of fresh soil and manure to the roots, or the barren time-worn appearance of branch and spur may point to a necessity for shortening each branch to within a foot of the stem, and grafting each of them, so that every scion may form a branch. We have found this plan answer admirably, affording a supply of fruit much sooner than if the old tree had been replaced by a young one.

The process of grafting has so recently been explained that we need not enter upon it. Now is the time to do it, and remember the three conditions necessary to success are a connection of the inner bark of stock and scion, binding them together securely, and the exclusion of air from the wounds or cut parts by wax or clay.

FRUIT-FORCING.

Peaches and Nectarines.—The fruit in the early house being about stoning will need to have the temperature kept as equable as possible until the trees have passed through this critical period.

A night temperature of 60°, with 5° more in the day from fire heat, ought not to be exceeded, with a rise of 10° to 15° on sunny days. In dull sunless weather a few degrees lower will be safer than an increase of temperature by fire heat alone. Syringe the trees twice a day with tepid soft water, as spring water is likely to leave a sediment on the fruit and seriously disfigure it. Admit a little air early, gradually increasing it as the sun heat increases, until the maximum for the day is reached; yet be cautious in admitting air by the front sashes in cold windy weather, as cutting draughts may have disastrous results. Tie-in young growths as they advance, and avoid overcrowding, which is one of the greatest evils in Peach-forcing. Stop the laterals at the first joint, and shoots retained to attract the sap to the fruit at the second or third leaf, and to one leaf afterwards as it is produced. Train the leading shoots their full length, and do not stop them until the limit of the trellis is reached, as the wood can hardly be too strong provided there is plenty of room for exposing the foliage fully to light and air.

Proceed with disbudding in succession houses, leaving no more shoots than will cover the trellis evenly at 12 to 18 inches apart; and shoots from the base of the present bearing wood, and to take its place next season, must not be overcrowded. Tie down the shoots and thin the fruit by degrees, leaving those most favourably situated for swelling to maturity. Green aphid, if it makes its appearance, must be destroyed by fumigation on calm evenings, having the foliage dry. Trees in succession houses must be well supplied with water whenever the borders show symptoms of dryness. Syringe twice a day, and keep the temperature at 55° to 60° by artificial means, with 10° to 15° rise from sun heat. Trees in flower should have a temperature of 50° to 55° by fire heat, and 60° to 70° from sun heat, ventilating freely; and where bees do not visit the flowers shake the trees, or, better, brush the flowers over with a camel's-hair brush on fine days. Syringing will not be needed, but the floors and borders should be damped twice daily, as a genial condition of the atmosphere is essential to the health of the trees.

Late houses are now in fine bloom and promise well. These should be kept well ventilated and the atmosphere dry, as the blossom will endure a low night temperature provided the house is dry, but frost should be excluded; and to secure a good set the temperature should be raised to 50° in the daytime, air being admitted on all favourable occasions.

Melons.—These, despite the weather, have made good progress, and the earliest are swelling freely. They have been earthed, and the full complement should now be given if not already done. Stopping the growth at every joint as it is made must be the order of the day, and where the shoots are likely to interfere with the principal foliage they must now be well thinned. Remove all flowers, and place tables or other means of support to the fruits before they become very heavy. Examine the soil at the roots, and see that the plants do not suffer by want of water; and as they will now be in condition to take a little weak liquid manure, it should be given in a tepid state, avoiding watering close to the stem to avoid canker, which if it appear should have quicklime rubbed well into the affected parts. Keep the bottom heat steady at 80° to 85°, maintaining a night temperature of 65° to 70°, 70° to 75° by day, and a maximum of 90° from sun heat, admitting a little air early, but avoid currents of cold air. Syringe twice a day in bright weather, but only damp the paths and walls on dull days. Keep the evaporation troughs filled with liquid manure. Attend to stopping, tying, and thinning in succession houses, and impregnate the blossoms on fine days.

Cucumbers.—Attend to tying, stopping, and thinning the shoots, and remove superfluous fruit, as nothing so enfeebles the plants as overbearing. Plants in full bearing require copious applications of liquid manure, especially those having the roots in a somewhat confined space. Syringe the plants freely on fine days, wetting every part, as cleanliness is essential to their healthfulness. Admit air early but cautiously, avoiding cutting winds, and close early with plenty of atmospheric moisture. Keep the bottom heat at from 80° to 85°, night temperature 65° to 70°, allowing an advance from sun heat to 85° or 90°. Add more soil to the ridges or hillocks as the roots protrude. Keep the evaporation troughs charged with liquid manure. Remove from the plants any unsightly or damaged leaves as quickly as they appear, and keep a sharp look-out for insects, and if they appear promptly apply approved remedies.

PLANT HOUSES.

Orchids.—In this department top-dressing and repotting where necessary should be pressed forward with all possible speed. The pots prepared for the reception of the plants should be well and liberally drained by half or three parts filling them with broken

crocks, according to the different requirements of the plants. The material used for drainage should be washed clean. Pay particular attention to the drainage, for if this is deficient and water be allowed to stagnate and make the soil sour the roots will not long remain healthy. *Aerides*, *Vandas*, and *Saccolabiums* may be commenced with, and should always be operated upon just before they start into growth, also *Cattleyas* and *Laelias*. If any of the above have become tall they can, if the top roots are healthy and abundant, have the lower portion removed and be lowered in their pots. When the plants are turned out of their pots remove all decomposed material from amongst their roots. The above thrive best when the pots in which they are grown are nearly filled with crocks, and charcoal carefully laid amongst their lower roots, the others elevated above the rim of the pots with living sphagnum. *Dendrobium nobile*, *D. Wardianum*, *D. crassinode*, and others that have commenced growth can also be repotted or placed in larger baskets if they require them. Use for these two parts of fibrous peat to one of moss, with a moderate proportion of charcoal and a little sand; the last is not required for those growing in baskets. *Phalænopses* do best in baskets or in pans suspended from the roof, and if they require larger sizes nearly fill the baskets used with charcoal. Place over this a little moss, and then fill in amongst the roots with the same material and broken charcoal or small crocks. The moss will grow freely if these plants receive that abundant supply of water they really require while in active growth. Suspend them in the most moist and shaded position in the house in which they are grown. Afford these plants a temperature of 65° by night, with a rise of 5° or 10° by day.

Many *Cattleyas* and *Oncidiums*, with *Dendrobium thyrsoflorum*, *D. densiflorum*, *D. suavissimum*, and others of this type, may still be at rest; but this entirely depends upon the time they completed their growth or the date they are wanted to flower. When wanted in flower late, and retarding is necessary, give a long season of complete rest. It is much better to retard the plants now than when they have started into activity, and the season's growth be injured in consequence. Those that have started into growth should have a night temperature of 60°, with a corresponding rise of 5° or 10° by day. *Cattleyas* and others still at rest may have a lower temperature of 5° or 10° by night, while *Dendrobiums* can be kept quite cool if dry at the roots and cold draughts are avoided. Water *Cattleyas* carefully, for they require less moisture at the roots while in active growth than do many *Orchids*. If over-watered and the atmosphere is overcharged with moisture they are not unfrequently subject to spot.

Nearly all the occupants of the cool house, if they have been subject to a night temperature of 50°, may now be potted and top-dressed without delay. Give *Odontoglossums* and *Masdevallias* equal parts of fibrous peat and moss to grow in, with a little charcoal broken small. *Celogynes* succeed well in a similar compost, while *Lycastes*, *Epidendrums*, and *Maxillarias* may have two-thirds of good peat to one of moss, with coarse sand and charcoal added. Do not give the plants water for two or three days prior to repotting, and water carefully afterwards until the roots have commenced working. The blinds should now be prepared and drawn down for a few hours during the brightest part of the day over *Odontoglossums* and other shade-loving plants that have been repotted.

Greenhouse.—To have a fine display of *Chrysanthemums* next autumn and winter propagation should now be attended to. The present time is early enough to insert cuttings for all decorative purposes and for supplying cut flowers, and can, if inserted at once, be grown rapidly from the time they are rooted without any check. No advantage is gained by rooting the plants earlier for these purposes. Insert the cuttings singly in small pots and place them in handlights in a temperature of 50° to 55°, shade from strong sun, and keep them close and moist until they are rooted. Where large bushes of *Pompons* or any dwarf-growing varieties are wanted insert two or three cuttings in one pot and grow them together. As soon as the young plants are rooted pinch out the points and harden them gradually, so that by the time they are ready for 4-inch pots they can be placed in cold frames.

Sow seed of Chinese *Primulas* for early autumn flowering in pans or pots liberally drained and filled with a light compost consisting of half leaf soil. Scatter fine leaf soil freely over the surface of the pans, and then sow the seed without covering it; water with a fine-rose can, and cover with a square of glass, placing them in heat, shading the pots from the sun. On no account must the surface of the soil become dry, and if it can be kept moist without being watered the seed will germinate the more freely. The pots, therefore, should always stand on a moist base, and not on open trelliswork or the dry shelf of a greenhouse.

THE BEE-KEEPER.

BEES AMONGST SNOW.

IN the changing and uncertain climate of Great Britain showers and falls of snow are not uncommon in the month of March, and sometimes we have had such in April. Experienced bee-keepers know that while snow is on the ground or around an apiary bees should never be allowed to leave their hives. During frosty weather they will not venture out, but when the thermometer rises and snow begins to melt the bees venture to fly, and in doing so many perish. They seem to be dazzled and bewildered by the light, and rapidly fall into the snow, and become motionless in a moment. The heat of their bodies melts soft snow, causing them to sink about an inch in it. When snow is crusted on the surface bees on touching it lose the power of their feet and legs by a kind of paralysis, and many of them are unable to take wing, roll on to their backs, and speedily perish. Many hives are weakened—some are destroyed by loss of bees in snow. This is well known.

The severity of the present frost and its continuance in the middle of March is a new experience to British bee-keepers. The past winter was mild and favourable for bees. At the end of January hives were strong, and the bees of many of the hives in this section of the country began to breed, then when Snowdrops and Crocuses came into flower the bees in great numbers were seen on them. Some of the strongest hives had two and three seams of brood sealed, and doubtless much brood unsealed. At the beginning of March we had several days of cold and cutting winds, so cold that bees would not leave their nests for food; afterwards severe frost set in, bringing down the mercury of the thermometer at nights below 20°; one morning, the 10th of March, to 13°, or 19° of frost. The frost still continues, and snow is now falling in Cheshire on this the 16th of March. If the frost had come a month sooner little harm would have been done to hives.

In my time we have never before experienced such severe and continuous frost in the brood-rearing season, and therefore I cannot speak from experience as to the extent of the injury probably done to the brood during the last fortnight. We know that bees dislike cold winds even in April and May, and in order to protect their brood then from chilling winds they contract their doors with compact masses of their own bodies. In the months of April, May, and June bees spread the eggs of their queens as widely as they can be covered and hatched, and when cold winds come they endeavour to keep them out by blocking or corking their doorways. Hives are numerically weak in March generally speaking, and in severe weather, such as we have now, the bees have two difficulties to contend against—viz., first, their inability to feed and nurse their brood; and secondly, their inability to keep it warm enough. In cold weather bees are very helpless creatures. In winter and early spring bee-masters will do well to give them all the protection possible. Before the present frost set in hives were in capital condition, and fruit trees covered with blossom buds, giving bee-keepers good hopes of early swarms and great results, and therefore this severe and unexpected weather is the more disappointing. By-and-by we shall learn what real harm, if any, has been done by it beyond stopping progress for a season.—A. PETTIGREW.

BEE-FEEDERS.

THE interesting article on bee-feeders by "Y. B. A. Z." appears to be particularly valuable at the present time, inasmuch as his verdict, after reviewing a three-shilling, a two-shilling, and a six-penny feeder, is in favour of the latter. In these days of expensive hives with expensive appliances the saving of 1s. 6d. or 2s. 6d. for each hive, where many are kept, is a matter of consideration, but if the owner of the said hives be a cottager the economy is a real boon. The points mentioned as requisite for a stimulative feeder—namely, the power to give much or little, prevention of robbing, ease of application, are in the first and second instances fully sustained by the vulcanite stage and feeding shovel, and I might add flower pots; but the ease of application may be made still easier by a slight alteration which I would submit for "Y. B. A. Z.'s" approval. The device is exceedingly simple, and, moreover, cheap, 4d. being an outside figure for each complete feeder.

Before explaining it, perhaps it would be well to state the necessities that suggested the contrivance. The defective principle on which "socket" feeders are constructed is most clearly set forth, but my experience with those, though not actually Mr. Blow's,

was attended with more direful results than those mentioned by "Y. B. A. Z." Besides finding that bees took their "half pint regular" in spite of a "temperance movement," I have more than once flooded a colony by lifting off a half-emptied bottle when preparing for examination, and instead of lifting off the cover with the bottle, left that useful appendage in the socket fast and firm. Doubtless this was careless. "Very!" I hear it muttered, but the fact remains that many of these feeders are made too beautifully exact. After using for some time the wood swells, and thus gets a firm grip of the inverted cover, which is difficult to extract, even with the help of a screwdriver or some such tool. It occurred to me, therefore, to dispense with the assistance of the socket, and to make the stage as follows.

Take two pieces of three-eighth red deal 5 inches square. Place them together cross way of the grain to prevent warping, and fasten them together with wire nails. Bore two 1-inch auger holes, or larger. Tack over these a piece of wire cloth 4 inches square. This completes the stage. Any wide-mouthed bottle will do provided the rim is even. (Rub on a rough paving stone if not square.) These have tin caps, which I order without any holes in, so that I can please myself as to number and place by punching them as required. My tinman charges 1s. a dozen for these caps—he would doubtless be glad to make them in unlimited quantities—so that if the bottle be reckoned at 2d. and the wire cloth and wood 1d., the feeder complete costs 4d. Of course it is an advantage to have a supply of these caps with the holes pierced in a variety of numbers, that fast or slow feeding may be regulated by changing one for another.

The ease of application is obvious. All that needs to be done is to fill the bottle, put on the cap, and place on the stage in the same manner as the two-shilling feeder. The feeding shovel is dispensed with, there is delusive half plate of unperforated zinc between the cap and the bottle, and no sticking fast of the cap in the socket.—H. V. EDWARDS.

TRADE CATALOGUES RECEIVED.

- Ormiston & Renwick, Melrose.—*List of Farm Seeds and Potatoes.*
 John Forbes, Hawick, N.B.—*Descriptive Catalogue of Florists' Flowers, Ferns, &c.*
 Vilmorin, Andrieux & Co., 4, Quai de la Megisserie, Paris.—*Catalogue of Seeds of Trees and Shrubs.*
 James Lye, Clyffe Hall, Market Lavington, Wilts.—*List of New Fuchsias.*
 Louis de Smet, Ledeborg-lez-Gand, Belgium.—*Supplementary Catalogue of Plants.*
 A. M. Scipion Cochet, Grisy-Suisnes (Seine et Marne), France.—*Catalogue of Roses, Trees, and Plants.*
 B. W. Warhurst, 33, Highgate Road, Kentish Town, N.W.—*List of Boilers.*

TO CORRESPONDENTS.

*** All correspondence should be directed either to "The Editor" or to "The Publisher." Letters addressed to Dr. Hogg or members of the staff often remain unopened unavoidably. We request that no one will write privately to any of our correspondents, as doing so subjects them to unjustifiable trouble and expense.

Correspondents should not mix up on the same sheet questions relating to Gardening and those on Poultry and Bee subjects, and should never send more than two or three questions at once. All articles intended for insertion should be written on one side of the paper only. We cannot reply to questions through the post, and we do not undertake to return rejected communications.

"Single-handed" (E. M. E., Gateshead).—Your extremely kind letter and substantial expression of sympathy towards our correspondent have been forwarded to him, and cannot fail to do him good.

Vines (H. S.).—Owing to great pressure on our columns answers to your questions, which are not urgent, must be deferred until next week, when we hope to be able to make the matter clear to you.

Various (F. C.).—Continue stopping your Vines as usual. There is nothing on the Apricot wood except scale, and the petroleum and softsoap mixture will destroy it. The globules on the leaves are indicative of health. The white flower is *Leucojum vernum*, the scarlet one *Alonsoa Warscewiczii*. The weed is quite shrivelled. Our reply must be brief, as we go to press earlier this week. We may possibly refer to your letter again.

Fir Tree Oil (J. Garrett).—Try a dessert-spoonful of the oil in a wine-bottle full of rain water. This will probably answer your purpose for using with the spray-diffuser. If it neither kills the insects nor injures the plants you can

easily add more oil; but you will act safely by trying a weak solution first. Shake the bottle well before using the insecticide.

Camellias (*Ignoramus*).—The presence of the glutinous liquid on the leaves indicates that there are insects either on the plants, or some other plants near to them, or on the roof above. You had better ascertain by a close examination if this is not the case, and if it is not you might write to us again enclosing a few of the Camellia leaves. More will be written on Camellias in an early issue.

Vine not Breaking (*Inquirer*).—The Buckland Sweetwater does not always break so freely as the Black Hamburg. All you can do is to syringe the Vines a few times a day in fine weather with tepid water, and, if all the buds do not start, probably sufficient will do so to furnish the Vine. It is not uncommon to find far too many laterals on Vines, the result being crowded and undeveloped foliage, and consequently inferior Grapes.

Flower Boxes (*M. F., Farnham*).—We do not know the address of a "wholesale firm that makes tin and wooden boxes for sending cut flowers in," as we have never seen them advertised. Mr. Lovel of Weaverthorpe, York, has advertised neat, light, and strong cardboard boxes for flowers, and you might send to him for his price list with the view of obtaining samples of different sizes. We have many times received flowers in those boxes as fresh as when cut from the plants, when the boxes had been lined with a few soft green leaves of any kind.

Horticultural Appliances Exhibition (*J. E. D.*).—The date of this Exhibition was entered in "Coming Events" last week because the show had been advertised to open on the day indicated. We have received no notification of the postponement of the Exhibition, but have heard, unofficially, that the opening has been deferred to some date at present unknown to us.

Cannas (*E. Fisher*).—These vary greatly in height, and also differ in the colour of the foliage and flowers. If you desire both plants of the same variety, and this to have scarlet flowers, you may grow *C. Van Houttei*, which has handsome purplish bronze foliage. It attains a good size and flowers freely. If you prefer a green-leaved variety with yellow flowers, *C. Auei grandiflora* is one of the best.

Blood Manure (*C. Bateson*).—We have communicated with Sir Daniel Cooper on this subject, and he informs us that the gentleman who gave him the recipe is dead. We have ascertained the chemicals named do not have the effect desired. In all probability a much larger quantity of them must be used. This we have not yet had time to ascertain. If you make further experiments we shall be obliged if you would let us know the results.

Frost and Fruit Blossom (*Thornton Stewart*).—We fear the blossoms you have sent are seriously injured, but they are not sufficiently advanced for being examined satisfactorily. The stamens are fresh, but the pistils of several of them at least are killed. Most of the flowers, we think, will expand, but few will be followed by fruit. This is only what might be expected, since you state that the mercury of the thermometer fell to zero. This is extraordinary for the month of March. You did not state the date of this remarkable frost, but only the day—Saturday. We presume it would be the 10th inst.

Potting Camellias (*C. P. L.*).—Are you sure your plants need repotting? If you state their size and condition, also the size of the pots, we can, perhaps, better answer your question. Turning the plants out of the pots, rectifying the drainage, removing an inch or two of the surface soil and adding fresh compost, is often a safer practice than repotting. Perhaps the notes on Camellias in our last issue, which you had not seen when you wrote to us, may be of service to you, and others will follow as soon as possible, that may be still more applicable to your particular case. You may safely wait the issue of these notes, and in the meantime send the particulars suggested, and we shall be glad if we can aid you.

Tuberose not Growing (*Idem*).—You say you "potted the bulbs in January, placed the pots in an intermediate house, gave no water, but allowed the soil to be dust dry," and then ask what you have "done wrong, as the bulbs do not start into growth." You have done wrong by keeping the soil so dry. Nothing can grow in "dust dry" soil. If immediately after potting, and before the soil became dry, you had buried the pots in cocoa-nut fibre refuse, or even ashes, leaf soil, or damp sawdust, as if burying Hyacinths, the pots would be half full of active roots by this time, and growth would have commenced. All you can do now is to keep the soil moist, especially at the bottom of the pots, but not decidedly wet, and await the result. If you can plunge them in gentle bottom heat in any damp material roots will be emitted the sooner, and the soil will be kept regularly and moderately moist without being frequently watered.

Red Spider on Fuchsias (*W. H.*).—Are you sure your plants are infested with this insect? It is not usually so prevalent at this period of the year. As you are afraid of pure water injuring the flowers, anything else you can apply with the syringe will injure them still more. If your plants are not attacked by any other insects you may wash off the pest by syringing—one man carefully inverting a plant and holding it while the other uses the syringe freely. This, if done carefully, would not seriously injure the flowers. An alternative remedy is to mix a quarter of an ounce of petroleum in a quart of water in which half an ounce of soft soap has been dissolved, or to dissolve an ounce of nicotine soap in the same quantity of water; invert the plant and apply the insecticide to the under sides of the leaves with a vaporiser, not a syringe. This would not injure the flowers. No steaming or fumigating will destroy the insects. If the plants are much infested they have evidently been neglected or mismanaged in some way.

Grafting (*E. Welton*).—We are not aware of any simpler methods or plainer instructions than those recently published, and relative to which we have received the following testimony from a clergyman in Ireland:—"I have read with much interest your articles on grafting, which are the best by a very long distance of any that I have met, and I have a great many books on the subject, and am myself not altogether a tyro in the art. One great advantage to the beginner is your only giving the best methods, and not ten or twelve, and leaving the learner to find out for himself which is the easiest, and therefore which the most certain to succeed. I, for one, beg to thank you most heartily for all—letterpress, and the most excellent illustrations." Read those articles attentively and we think you will be able to graft fruit trees.

Melons and Tomatoes (*Reader*).—It is no trouble to us to answer letters when inquirers state their wishes intelligibly. You say you now "repeat" your questions. On referring to your letter of last week we find you required information on growing Melons in winter, and did not even mention Tomatoes, though no doubt you intended to do so. Instead of repeating your letter you have improved on it, and we can now understand what you desire to know. If

the flags over the pipes are not fixed we should raise them 3 inches, but this is not very material, and no rubble will be needed beneath them. Spread an inch or two of gravel or cinders on them, then place in the fermenting material, spreading over this a thin layer of turves, then the soil, in ridges at first, to be added to as the roots of the plants protrude through them. The soil used for surfacing must be warmed and pressed down firmly after the plants are in free growth. By having very strong plants of Tomatoes in 6 or 7-inch pots ready for planting immediately the Melons are over, you may have an excellent crop of fruit in the autumn and winter. They would probably grow in the old Melon bed, but we should dig a portion of it out and add half a bushel of fresh compost for each Tomato plant. They could be grown in large pots, but you would probably have heavier crops by planting out. The Conqueror and Earley's Defiance are good varieties; earlier and dwarfed are Vick's Criterion and Orangefield, while many persons like the colour and flavour of Green Gage. The question of varieties is really a question of taste. If you have not had much experience in growing Tomatoes you will do well to obtain Mr. Iggulden's Manual, price 1s., post free 1s. 1d., from this office. It gives all the details of cultivation in pots, frames, and the open air.

Chorozema cordata (*A. X., Whitby*).—The plant of which you have sent a spray is a *Chorozema*, and we think *C. cordata*, but as you took no pains to let us have it in a fairly fresh state, but simply enclosed it in a letter to be crushed and dried, the fault is your own if we have not given the correct specific name. Your plant is evidently in bad condition. Unless it is 4 or 5 feet high and as much in diameter the pot is much too large for it, and probably the roots are the reverse of active. We should prune it rather severely, but not cutting below the leaves, place it in a warm greenhouse orinery, syringe it a few times a day, and only apply water to the soil to keep it moderately moist. On signs of fresh growth appearing we should turn it out of the pot, remove a good portion of the old soil, and place the plant in a much smaller, clean, well-drained pot,



Fig. 64.

employing as compost light turfy loam and firm fibrous peat in equal parts, with a tenth part each of silver sand and crushed charcoal, potting very firmly. Water must be applied with great care after potting. If you err in this matter you will fail; if you exercise sound judgment you will succeed in renovating the plant. Syringing the plant and pot occasionally will prevent the necessity for watering the soil for a few days, but when you do give water apply it in sufficient quantity to moisten every particle of soil. As fresh roots take possession of the soil and growth becomes free more water will be needed, and the plant cannot then have too much light and air, a close house and shaded position at that time being evils to be avoided. Although this is by no means one of the best *Chorozemas*, yet a well-grown plant is both elegant and bright. The illustration will show the character of a well-grown specimen, and you will do well to endeavour to grow your plant as nearly like it as possible.

Carnations for Winter (*Idem*).—They must be propagated in the spring from strong healthy cuttings, and not by layers in the summer. A successful cultivator has briefly described his practice as follows:—"Side shoots may be slipped off with a heel, inserted in pots of sandy soil, covered with a bellglass, and plunged in a gentle heat. Roots are soon formed; then pot the plants singly in 60-sized pots, keeping them in moderate heat and close to the glass, shifting them into 4-inch pots before they become root-bound. Pinch out the point of the shoot as soon as they are well established in the 4-inch pots, which will cause them to break freely, then place them in a cold frame and gradually expose them to more air till the lights can be withdrawn. Transfer them to their large pots early in June, employing soil similar to that employed for Zonal Pelargoniums, having it rather dry and potting firmly, draining well. Staud them out in an open but rather sheltered position, or the winds are likely to snap off the shoots unless staked securely. For the weaker growers, such as *La Belle*, place some stakes round the outside of the pots, training the growths round them; for the bushy growers some small spray of Birch or Hornbeam round the pots is preferable to stakes. Supply water carefully, and fully expose them to the sun all the summer to ripen the wood, or they will not flower freely. House them at the same time as Pelargoniums, giving them a light position and free ventilation, and they will amply repay at Christmas and onwards for the trouble taken. They are benefited by a little weak liquid manure when the soil has become partially exhausted." As you do not appear to possess much knowledge on plant culture, you will find the investment of 10d. in our Greenhouse Manual not misapplied capital.

Winter and Spring Onions—A Coming Contest (*John Topham*).—As your question is an unusual one, we print it and append our reply:—"Our township have matched themselves against another for £10 this year to show forty-eight Onions on each side. The conditions are—"Forty-eight spring-sown and spring-grown Onions of the flat variety." Now our competitors have been told that spring does not commence till the 25th March, and some of them have sown on the 7th of this month, and they are afraid of the other side taking advantage of this and call their Onions winter-sown. I shall be glad if you will say whether Onion seed sown in March is winter-sown or spring-sown." Our answer is that it must be decidedly regarded as spring-sown, and to object to the produce on the ground stated would be an unworthy quibble. Winter Onions are so designated, not because the seed is sown in winter, but because it has germinated in the autumn, and the plants have passed the winter in the open air. Plants raised from seed sown in the open ground any time in March could not possibly appear until spring, hence could not be "winter" Onions. We cannot imagine any such objection as that named being seriously advanced, and if it should be it cannot be sustained. The term, "winter-sown," is a misnomer. There are two seasons for sowing Onion seed—autumn and spring, and that sown in March, at whatever date, is spring-sown. As the Onions in the coming contest will not have completed their growth by the 21st of June, at which date the summer quarter commences, but must grow for some time after that, it might with as much reason be urged that the plants were not "spring-grown" as that the seed was not "spring-sown." This shows the absurdity of such an objection as that anticipated. We shall be glad if you will send us the particulars of your Onion contest, stating the weights and varieties of the best collections.

Leaves for Forcing (*E. S. R.*).—It depends entirely what you want to force and the time you wish to commence, as to whether linings will be needed or not. We have grown Cucumbers and Melons in pits, forced such vegetables as Asparagus and Potatoes, and such flowers as Roses, Lilies, and various other kinds in pits with the aid of a thick bed of leaves alone; but we did not plant the two first-named crops before the middle of May. Very early forcing cannot be satisfactorily accomplished with the aid of leaves alone, as, although they afford a gentle bottom heat, they do not give the requisite top heat when used as linings to pits and frames. For this purpose fermenting manure should be mixed with them, and even then but little heat could pass through brick walls, which, we presume, form the sides of your pits. Your letter is not sufficiently explicit to enable us to give a more definite reply. There is no cheap book which gives the information you appear to require so fully as you will find recorded in our "Work for the Week" columns during the past twelve months. The best work on fruit-forcing is Mr. D. Thomson's "Fruit Culture under Glass." It is published by Messrs. Blackwood, price 7s. 6d.

Names of Plants (*C. J. S.*).—*Andromeda floribunda*. (*J. N., Neath*).—Although we do not undertake to name plants without seeing their flowers, we will endeavour to name yours if you will send us some particulars about it, such as its size and the conditions under which it is grown. We presume it has not flowered. Without some data of the nature indicated we cannot determine the name of your plant. (*M. C. B.*).—No doubt a form of *Tecoma australis*, which is a very variable plant as regards foliage. It ought to flourish in a greenhouse. Perhaps there is not sufficient light for it to flower. Is the house warm? It is grown out of doors at Kew. (*Captain H.*).—There are two or three Hollies so closely resembling yours, and the texture of the leaves is so much influenced by soil, that we are unable to state with certainty the name of the variety. By far the best plan for you to adopt will be to send a spray to a large nurseryman from whom you intend obtaining shrubs. This is the surest way to prevent disappointment.

Clay's Fertiliser (*F. J.*).—We are obliged to Messrs. Clay & Levesley, the manufacturers of this manure, for correcting a mistake—a clerical error—which we made last week in advising you to use one part of the fertiliser to twenty of compost. The safe quantity is one in eighty, or a 48-sized potful to a fair-sized barrowload of soil. When plants are in vigorous growth and have filled the pots with roots, a top-dressing of a small teaspoonful to a 48-pot may be given with advantage. It is important that the public in estimating the value of this manure should notice the small quantity required.

Feeding Bees (*A. B.*).—The weather has lately been too cold and snowy for feeding bees. In such weather they sit closely in clusters in the centre of their hives, and will not expose themselves to cold more than is necessary, but as bees cannot live without food they should be fed if they have no food in their hives. As there is a hole in the top of your hive the bees in it could easily be fed through the hole. Put a teacupful of good warm syrup—sugar and water—into a small pitcher, take the lid off the hole, and pour the syrup amongst the combs as well and widely as you can. By holding the hive in a slanting position the syrup will run into the cells and not drop straight down to the board. All this can be done before the bees have time to rise, and when it is done close the door and the top hole of the hive so that all the bees are kept inside. In very cold weather some weak hives so treated are taken near the kitchen fire or into a warm place, where the bees soon become lively and take all the food given to them. Your bees may soon be taught to come to the top hole for a little food daily. Cover your hive well and keep the bees comfortable. The cap you mention is meant for supering, and should be put on in May or as soon as the hive is filled with bees. From such caps good honey and honeycomb are obtained.

COVENT GARDEN MARKET.—MARCH 21ST.

MARKET still slack, with no signs of improvement until the holidays are over.

VEGETABLES.		s. d.	s. d.	score		s. d.	s. d.
Artichokes.....	dozen	2	0 to 4	0		1	0 to 1
Asparagus, English	bundle	12	0	0	0	1	0
Asparagus, French	bundle	25	0	30	0	2	0
Beans, Kidney....	100	2	0	0	0	3	2
Beet, Red.....	dozen	1	0	2	0	3	0
Broccoli.....	bundle	0	9	1	6	4	0
Brussels Sprouts..	1/2 sieve	1	6	2	0	0	0
Cabbage.....	dozen	0	6	1	0	0	0
Capsicums.....	100	1	6	2	0	7	0
Carrots.....	bunch	0	4	0	0	8	0
Cauliflowers.....	dozen	2	0	3	0	0	0
Celery.....	bundle	1	6	2	0	0	0
Coleworts.....	doz. bunches	2	0	4	0	0	0
Cucumbers.....	each	0	4	0	8	0	0
Endive.....	dozen	1	0	2	0	0	0
Fennel.....	bunch	0	3	0	0	0	0
Herbs.....	bunch	0	2	0	0	0	0
Leeks.....	bunch	0	3	0	4	6	2
Lettuces.....	score	1	0	1	6	0	0
Mushrooms.....	punnet	1	0	1	6	0	0
Mustard & Cress..	punnet	0	2	0	3	0	0
Onions.....	bushel	2	3	2	6	0	0
Parsley.....	doz. bunches	3	0	4	0	0	0
Parsnips.....	dozen	1	0	2	0	0	0
Peas.....	quart	0	0	0	0	0	0
Potatoes.....	ewt.	6	0	7	0	0	0
Kidney.....	ewt.	6	0	8	0	0	0
Radishes.....	doz. bunches	1	0	0	0	0	0
Rhubarb.....	bundle	0	4	0	0	0	0
Salsafy.....	bundle	1	0	0	0	0	0
Scorzoneria.....	bundle	1	0	0	0	0	0
Seakale.....	basket	1	0	2	0	0	0
Shallots.....	lb.	0	3	0	0	0	0
Spinach.....	bushel	3	0	0	0	0	0
Tomatoes.....	lb.	1	6	2	0	0	0
Turnips.....	bunch	0	2	0	3	0	0

FRUIT.

	s. d.	s. d.		s. d.	s. d.
Apples.....	1/2 sieve	2	0 to 7	0	
".....	per barrel	20	0	40	0
Apricots.....	doz.	0	0	0	0
Cherries.....	1/2 sieve	0	0	0	0
Chestnuts.....	bushel	10	0	12	0
Currants, Black..	1/2 sieve	0	0	0	0
" Red.....	1/2 sieve	0	0	0	0
Figs.....	dozen	0	0	0	0
Filberts.....	lb.	0	0	0	0
Cobs.....	100 lb.	0	0	0	0
Gooseberries....	1/2 sieve	0	0	0	0
Grapes.....	lb.	2	0 to 8	0	0
Lemons.....	case	10	0	20	0
Melons.....	each	0	0	0	0
Neectarines.....	dozen	0	0	0	0
Oranges.....	100	6	0	10	0
Peaches.....	dozen	0	0	0	0
Pears, kitchen..	dozen	1	0	2	0
" dessert.....	dozen	1	0	2	0
Pine Apples, English	lb.	1	6	2	0
Raspberries.....	lb.	0	0	0	0
Strawberries....	oz.	0	6	0	9



POULTRY AND PIGEON CHRONICLE.

THE POLLED BREEDS OF CATTLE.

(Continued from page 226.)

Of the "Polled Herd Book," first published in 1862, six volumes have been issued, in which there have now been registered 1930 bulls and 5054 cows and heifers. The "Herd Book" is now owned by the Polled Cattle Society, the Editor being Mr. Alexander Ramsay, from whose essay in the "Live Stock Journal Almanack" for 1879 we have gleaned much important information. The rise in the value of this breed within the past fifteen years has been most remarkable, and has continued up to the present time; for although Mr. McCombie's stock were sold in 1880 at what was then considered high prices, yet the herd of select animals from Mr. H. D. Adamson, sold in May, 1881, was dispersed at Aberdeen at still higher prices. The averages were, fifteen cows £74 18s. each, ten yearling heifers £47 15s. each, and younger animals in proportion; and to show the value of pedigree, eleven "Prides of Aberdeen" brought an average of £96 8s., and three "Sibyls" £116 4s. each. Again, we find that never in the history of any breed of cattle has the advance been so rapid as for the native breed of polled Aberdeen and Angus "doddies." They have doubled their price within the past few months, speaking of the end of the year 1882. The sales at Montbleton of forty lots averaged nearly £98; at Advie forty-two animals averaged £88 3s.; and at Cortachy fifty-seven animals averaging £108 11s., took everybody by surprise. These high figures are due to the demand from America, as shown by the purchases made by Mr. Wilken of Forbes, who bought at several sales lately fifteen polled cattle for the Hon. J. H. Pope of Canada at a cost of about £1500, and eight for the Hon. M. H. Cochrane, Hillhurst, at a cost of £1864. With regard to success at the Smithfield Show of fat cattle, for several years Sir W. C. Gordon Cumming has been the most prominent champion prize and medal winner. Since the rage for baby beef has set in, a great many polled cattle have been fed off at twenty-four to thirty months old, making £24 to £35 each. In the London Christmas market it is stated, choice three-year-old black polled bullocks bring from £40 to £48, and even in some cases over £80. We must conclude by stating the opinion based upon our observation and experience, that a herd for the production of young beef of Angus cows crossed with a full pedigree Shorthorn bull, will pay better and make greater weight for age, with best quality, than any other known cross.

The red-polled cattle of Norfolk and Suffolk have within the past few years made rapid progress in public estimation. So much interest has been displayed by some of the most eminent agriculturists of the eastern counties in their history and qualifications for public favour, that they can no longer be allowed to remain a merely local breed, useful only in their native districts,

but will doubtless be recognised in the future as first-class cattle under the cognomen of Red-polls.

In consequence of the recent progress which has been made in the improvement of this breed, many persons have hardly been prepared for the information we can supply relating to the antiquity and history of the breed. We are indebted to the Editor of the "Red Polled Herd Book," Mr. H. T. Euren, for much valuable information relating to their origin and progress. He says, "The history of the red polled cattle can be carried back well into the last century. Suffolk had from time immemorial its breed of polled cattle producing butter which, 150 years ago, was asserted to be 'justly esteemed the pleasantest and best in England.'" Arthur Young, in his "Survey" (A.D. 1794), defines the area—"A tract of country twenty miles by twelve . . . the seat of the dairies of Suffolk"—which, he said, must be peculiarly considered the head-quarters of the Suffolk polled stock, though he found them spread over the whole county. In this "Survey" we get the first accurate description of the breed. Though Arthur Young makes no note of Norfolk polled cattle, yet advertisements of sales held in and from the year 1778 prove that dairies of such animals were numerous in the county, and that they extended from the northern boundary of the Suffolk "head-quarters" well into the centre of Norfolk. An old Elmham tenant, who survived till 1872, recollected red polled cattle on the estate so long ago as the year 1780. At Shipdham they were greatly valued from a date equally early. The predominant breed in Norfolk at that time (see Marshall's "Rural Economy of Norfolk"—notes written from 1780 to 1782) was, however, "a Herefordshire breed in miniature," and "the favourite colour a blood-red, with a white or mottled face." He says there are several instances of the Norfolk breed being crossed with Suffolk bulls, and that the result was "increase of size and an improvement of form." This would show that in a remote way this cross may have had its effect on the Suffolk breed. But there is another statement which shows that about the year 1808, at a time when the rage for Devons was at its height on the Holkham estate, a new kind of breed made its appearance, partaking of the best qualities of the Suffolk and Devon or Norfolk red, the mixture of the two varieties by some of the animals having been introduced into Suffolk for crossing with the red cows there, and its effect to some extent has continued until the present time. Another cross was tried some fifty years ago by Mr. Moseley of Glemham, Suffolk. He used a Scotch bull for one generation, and then reverted to the original Suffolk breed, with but doubtful benefit. This we can understand, for it is admitted all round that the Suffolk reds, although they approach so nearly in shape and make to the black polled Scotch, yet they far exceed them in the milking capacity. Colour, too, should always be recognised as important. Any breed, although it is frequently ignored by amateurs, yet we find at one period in a few districts that red and white brindled and a yellowish cream colour had been accepted as representing good milkers. Again, in Norfolk we find that some cases sheeted polls were preferred. The fashion, however, during the last forty years has continued steadily in one direction in favour of the red, which is now exclusively regarded as the mark of excellence, especially the deep rich blood-red.

The amalgamation of the two varieties, Norfolk polled and Suffolk polled, may with certainty be traced from the year 1846. About this period the two counties met in honourable competition in the show yard at local exhibitions, but just twenty years ago the Royal Agricultural Society opened classes for Norfolk and Suffolk red polled cattle. The breed now having its "Herd Book" may henceforth be properly known as the red polled breed. A description of them was required and agreed upon by the breeders in the autumn of 1873, after Mr. H. T. Euren's proposal to establish a "Herd Book" of the breed; the particulars are, how-

ever, too lengthy for the space we have at command. The conditions of registry were not made too strict. Personal inspection, however, of the herds by the editor of the "Herd Book," and his inquiry into the breeding and antecedents of the cattle were in most instances resorted to. The first record up to 1877 consisted of 119 bulls and 554 cows and heifers, whose owners accepted the conditions of registry. It was by an excellent arrangement that each group was distinguished by a letter of the alphabet. Thus (to name the more prominent groups), A marks all cattle descended from red polls of the Elmham selection; B, those of the Biddell selection, and so on.

The red polls are said to have made great progress in America lately, and are much approved, for they have the advantage of being hornless, and therefore more harmless, no little gain where horses also are fed in the same pastures, or where the cattle sent to market make a long railway journey.

This breed of cattle, although really good milkers, still make heavy weights as beef, yet yield a superior quality of flesh, and in consequence are much sought for by the butchers, who are willing to pay for them the top price per stone. It is recorded that the live weight of a three-year-old steer of the Biddell strain shown in 1876 was 25 cwt. 2 qrs., its girth nearly 9 feet. Mr. A. Taylor's red polled steer, first-prize at Smithfield Club Show in 1881 (aged three years seven months; sire, Norfolk; dam, Suffolk) had a recorded live weight of 17 cwt. 1 qr. 1 lb. Its dead weight was 91 stone 6 lbs. (14 lbs. to the stone), being the high per-centage of 66.74 of the live weight, whereas 62 per cent. is a high average for the best Christmas cattle.

Milk and cream as tests of this breed are very favourable for the size of the cows and the nature of the pasturage. Mr. Gooderham, Monenden, one of whose cows, Wild Rose of Kilburn (vi.), which was first prizewinner as a yearling at the Royal meeting of 1879, brought her first calf when not quite two years old; and eight weeks after dropping her third calf she gave thirty pints of milk per day on winter feed, and her average of butter was 9 lbs. per week all the year round, and she never goes dry. This latter quality of never losing their milk is of immense importance, for not only does it add greatly to the annual product of milk, but it is almost an insurance against puerperal fever at calving time, the great fatality of which in high-conditioned herds is proverbial with almost every breed of full pedigree stock. Mr. Gooderham, to whom we have just alluded, has recently read a paper of great value at the Framlingham Farmers' Club in Suffolk on "Breeding, Rearing, and Fattening of Cattle," and with special reference to the management of his own herd of red polls. He says—"I would express my belief that no heifer ought to be grazed until she has had one calf; for this reason—you would then have the opportunity of ascertaining which are likely to make the best milkers, and, besides, heifers of that kind pay best to fat. For example, a barren heifer fat at two and a half years old will do well to weigh 50 stone (14 lbs.), and make £25; but supposing she has a calf at two years old, and you do not think she will make a good milker, graze her and her calf, and at three years old she and her calf will weigh—viz., the heifer will weigh from 44 to 46 stone, and will make from £20 to £23; her calf will weigh 36 to 40 stone, and make from £18 to £20. Thus a heifer and her calf will pay 10s. per week for the last year's keep, being quite as much as a milch cow."

WORK ON THE HOME FARM.

Horse Labour.—We have lately been busily engaged in preparing and sowing the land with spring Wheat, Beans, Peas, Oats, and Barley. We have sown a new sort of spring Wheat, raised from a single plant, and called the Red Talavera. We noticed a field of this last harvest, and in walking through it found an enormous crop of straw, although it was growing upon a strong soil. Barley will not be grown so much as heretofore upon loamy soils where roots have been fed off by sheep, as the land has been so seriously poached by the treading of the animals that it has been found impossible to obtain a Barley tilth without much spring labour, which means a late and deferred seed time. It is in consequence thought best to sow the land with early white Oats, to be seeded with Clover and Alsike mixed, and as the Oats come to harvest very early a good cutting of Clover for horses and cattle will be available until the first frosts in November occur. This mode of using the autumn growth of the young seeds has often proved more beneficial for the next year's growth in our own case than when it has been eaten down by sheep, which eat out the crowns of the plants, and in the winter months they die, the land in consequence being erroneously termed Clover-sick.

Potatoes should next be planted, especially if of the early varieties; but we do not recommend very early sorts for farm planting, except in case of being near a town or railway within reach of the market of the metropolis, in which case any quantity can be disposed of. For farm cropping generally we recommend the second earlies, which may

be planted the first favourable weather after the 20th of March; nor do we advise planting Potatoes with yard or town manure, for unless it was laid out in the autumn or winter the delay will prove too much at planting time, and we therefore prefer hand manures—Peruvian guano 4 cwt., and 2 cwt. of nitrate of soda per acre strewed in the furrow with the Potato sets. This is all hand labour and saves time, a matter of great import where there is much planting to be done. This application will prove superior to yard, stable, or town manure, and be far less liable to incite disease, particularly if the sets are planted not less than 8 or 9 inches, for where the disease occurs we have always found the soundest tubers at the greatest depth. All those sorts which produce luxuriant haulm should be planted in rows 3 feet apart; there is so much more room for tilling both with the horse hoe and ridging plough, besides which there will be a less number of small tubers than when planted more closely, and an even sample is always most profitable. Some years ago we were asked to go and see the result of an experiment, in which whole tubers had been planted in hills at 30 inches, 36 inches, and 42 inches apart, and the result proved that the greatest number and the largest tubers were obtained from the sets planted at the greatest distance apart. In farm work it is always important to reduce the number of sets, and also give greater facility for interculture.

Hand Labour.—Much labour will be required on many farms in clearing the land of couch grass now in tillage. To facilitate the work of clearance we never think of burning it on the land in small heaps, but burn it in large heaps when ashes are required for drilling on the root-crop seedings. As a rule the couch is carted away to decay in heaps, and with some earth attached becomes very useful in various ways. The burning is often delayed by rain, whilst the carting is done so quickly that the land is ready for seeding without delay.

Live Stock are still selling at very high rates, whether of stores or fat stock; our motto is therefore still in force with benefit, "Breed all you can and fatten all you breed." The home farmer in such a case will then reap all the benefit to be derived from grazing and fattening, whereas the benefit is frequently very unequally divided between the breeders and the graziers. For instance, why sell at present prices any lambs of light weight, when by holding them on up to 9 or 10 stone weights they will pay better than by selling at any other weights, either lighter or heavier? Dairy cows now should not be turned out to graze or lay out at night until the first week in May; and as there are plenty of roots, such as Mangold and Swedes, in hand on most farms, the cows will yield a more regular supply of milk if they are regularly managed, so as to insure their comfort and judicious feeding under cover for some time yet. Fattening cattle, especially animals of two years old and under, pay this year well for feeding, and it must be considered that the plan is beneficial on the principle of fattening all you breed.

THE SUNFLOWER IN FIELDS.

INFORMATION has been sought on the culture of this now popular flower as a field crop for commercial purposes. I have grown the plants in large numbers for chickens, and in fine autumns the seed ripened well, but in a dripping autumn a large breadth is difficult to deal with satisfactorily, as the seed does not ripen well, and it is not easy to harvest in good condition. Those who have barns or large open sheds in case of wet weather might dry the heads, when they could not be dried in the open air. Since reading Mr. Hanbury's note I have sought for information on growing the Sunflower in fields, and find the following in the "Rural Cyclopædia."

"The produce per acre will widely vary according to soil, situation, and culture, but has been found to average about 50 bushels of seed—equal to 50 gallons of oil and about 1500 lbs. of oilcake; and the stems of the crop, if burnt for alkali, will yield about 10 per cent. of potash, while the leaves may be dried and pulverised and mixed with bran for fodder. The crop, however, has a very scourging effect on land, and particularly robs it of potash, and is peculiarly unsuitable for going before Potatoes in a rotation. The soil most suitable is light, friable, and richly alkaline, and does admirably well to be manured with fresh seaweed; and if loamy or clayey may be advantageously prepared by commixations of shell sand, limestone gravel, or any other opening calcareous substance; and, in any case, must be well tilled and finely pulverised. The situation most suitable is a moderately sheltered one, with sufficient exposure to enjoy free and constant circulation of the air. The sowing may be done at any time in March when the weather and soil are favourable. The manner of sowing and of transplanting may be very varied, but the following has been particularly recommended:—'Let drills be drawn with a hoe or otherwise, about an inch deep, and about 18 inches asunder; sow the seed therein thinly, and cover it over an inch thick; or it may be sown by dibbling in, which is the better plan. When the fourth leaf of the young plants has sprouted, and the fifth is ready to sprout, let them all but one be removed from each place and planted elsewhere, in rows 12 or 18 inches apart, and at a distance of 10 inches in the row. Water the plants as they are put down if the weather be

dry, and dry weather is essential to the success of the crop. Especial care should be directed to remove all weeds for about a month or six weeks, and occasionally to mould up the earth around each plant.' When the heads are quite or nearly ripe, the plants should be cut down at about an inch from the ground, and removed to a shed or some other place of complete shelter from rain, and there left till they become dry; and either then or afterwards they may be freed from the seed; but they must not, in any case, be left on the ground, as they have a great capacity for moisture, and would be very likely to attract it and to become filled with insects."

In my experience 18 inches is much too close for the rows. They are far better 2 feet apart, and in rich soil 2½ feet. Kainit is one of the cheapest and best manures for this crop, and a dressing of 5 cwt. per acre, with two of superphosphate of lime, would not be too much, 1½ cwt. of nitrate of soda to be applied as a top-dressing after the plants are fairly growing, if they do not make satisfactory progress. About 2 bushels of seed will suffice for sowing an acre at the wider distances recommended. If anyone else can give better information than this it will be acceptable.—A GARDENER.

BATH AND WEST OF ENGLAND SOCIETY AND SOUTHERN COUNTIES ASSOCIATION.—This old-established Society will this year hold its annual Show at Bridgwater on May 28th, 29th, 30th, 31st, and June 1st, and prizes to a large amount are offered for Horses, Cattle, Sheep, Pigs, Cheese, Butter, Poultry, &c., and for Horse-shoeing. The display of implements has always been a very fine one and among other special and attractive features in connection with the Society are exhibitions representative of horticulture, fine art, decorative art, and manufactures. Entry forms, &c., can be obtained of the Secretary (Mr. Thos. F. Plowman, Bath), and further particulars will be found in our advertisement columns.

THE WEATHER IN SOUTH PERTSHIRE.—Severe frosts have prevailed during the past week, the thermometer registering 10° and 11° during two or three nights. These have greatly facilitated the working of the heavy "carse" soil; and the Bean crop—a very important one in the district—has been got in very satisfactorily. On Saturday blinding showers of snow from the N.E. prevailed during the earlier part of the day, and during the evening and early morning fully 2 inches of snow fell. Last night we had nearly 7° of frost, and, the snow still lying, the country all round has a thoroughly winter's appearance.—N. A.

OUR LETTER BOX.

Duck Eggs (*H. Buxton*).—It is impossible to say with any certainty for how long the eggs will prove fertile. It is worth trying the next ten laid by each Duck, but it is hardly likely that all these will prove fertile.

Sootch Champion Potato (*Bailiff*).—No doubt this variety exhausts the soil much more than the earlier sorts do, and manure must be used for the succeeding crop accordingly. This is better than making the land rich for the Potatoes. We shall shortly publish notes on this subject.

METEOROLOGICAL OBSERVATIONS.

CAMDEN SQUARE, LONDON.

Lat. 51° 32' 40" N.; Long. 0° 8' 0" W.; Altitude, 111 feet.

DATE.	9 A.M.					IN THE DAY.				Rain.
	Baromet. at 324 and Sea Level	Hygromet- er.		Direction of Wind.	Temp. of Soil at 1 foot.	Shade Tem- perature.		Radiation Temperature.		
		Dry.	Wet.			Max.	Min.	In sun.	On grass.	
1883.										
March.										
Sun. 11	Inches. 29.715	deg. 37.4	deg. 34.9	N.W.	deg. 36.5	deg. 41.4	deg. 26.2	deg. 74.8	deg. 22.0	—
Mon. 12	29.827	31.4	31.4	N.E.	36.4	40.6	27.6	83.0	24.2	—
Tues. 13	30.045	34.5	32.6	N.W.	36.2	45.8	27.0	86.7	22.7	0.024
Wed. 14	29.759	35.0	33.8	N.W.	36.4	47.4	32.7	89.3	29.4	—
Thurs. 15	29.635	34.3	31.6	E.	37.3	40.0	31.0	74.8	28.3	—
Friday 16	29.609	30.2	29.6	N.W.	37.1	41.7	23.8	82.4	21.7	0.010
Satur. 17	29.550	38.6	36.1	W.	33.4	47.0	30.1	85.8	25.4	0.125
	29.734	34.5	32.9		36.6	43.4	28.3	82.5	24.8	0.159

REMARKS.

11th.—Dull and cold; snow in evening.

12th.—Very cold, with bright sunshine.

13th.—Fine, bright, and calm; slightly warmer.

14th.—Cold and bright; sun at intervals.

15th.—Very cold, snow falling thickly at times; bright moonlight night.

16th.—Very bright sunny morning; cold wind; cloudy afternoon; moonlight night.

17th.—Fine at first, afterwards showers of hail and rain.

Temperature almost the same as in the previous week, and remarkably low for the season.—G. J. SYMONS.



29th	TH	
30th	F	
31st	S	
1st	SUN	LOW SUNDAY.
2nd	M	
3rd	TU	
4th	W	Society of Arts at 8 P.M.

DENDROBIUM WARDIANUM.

ONLY a few years ago this magnificent Dendrobe caused quite a sensation, and for a time, in consequence of its high price, did not find its way into gardens generally. Plants can now be obtained for as many pence as they cost shillings four years ago. Within the last two years tens of thousands have been imported from Burmah, and within twelve months some nine or ten thousand have been landed in Liverpool. Less than two months ago over five thousand were received at Garston with pseudo-bulbs fully 3 feet long. To show the great popularity of this Orchid it may be mentioned that the whole of these plants were disposed of in a remarkably short time without having recourse to a sale by auction.

There are several varieties of this handsome Dendrobe, some being much finer than others, yet in many the variation is slight, and all are well worth growing. The superiority of some is marked by the large size of their flowers and the deep orange yellow on the lower part of the lip, while in others the lip has a greenish yellow appearance. The tip of magenta on the sepals and petals of some flowers is heavier and more vivid than upon others, while the lip varies in shape, being in some cases well open and almost round, while in others rather long and inclined to be pointed. Some flowers open here at the present time are over 4½ inches across.

Without doubt this is one of the most lovely and useful of spring-flowering Orchids. It is the more serviceable because it can be grown in the best condition suspended from the roofs of houses either in baskets or on blocks; in fact it is quite at home in this position, and yields abundance of the choicest flowers without taking up the stage room which is so valuable where the space at disposal is limited. A number of plants thus grown and well bloomed have a charming appearance; or when the plants are arranged to rise out of a groundwork of *Adiantum cuneatum* associated with dwarf well-coloured *Dracænas* they are displayed to great advantage, and it would be difficult to imagine any arrangement more beautiful and effective. For a long time we regarded the old *D. nobile* as one of the most beautiful of the whole family. It is certainly one of the most useful; but we have a number of this species arranged with *D. Wardianum* on one side of a small span-roofed house intermixed with other Orchids and *Dracænas*, and the palm must decidedly be given to the latter.

The species under notice is by no means so difficult

to manage as many others, and none need fail in its cultivation even if he commences with imported plants, provided they are in good condition when they arrive. The best time to obtain imported plants is in early spring, as they can then be started into growth almost immediately. If they arrive during winter and growth has already commenced they require very careful treatment in the supply of moisture, or they may damp off altogether. If at rest they should not be excited into growth by the application of strong heat or more moisture than is required to maintain their pseudo-bulbs fresh and plump; in fact they should be treated until the days lengthen very similar to established plants. Whenever they arrive remove any portion that may have been bruised in transit, or decay may ensue when moisture is applied.

After they arrive place them in a temperature of 50°, but care must be taken that water does not lodge about them from syringing or otherwise. A vinery that has been started is a capital place for them, especially if they are suspended from the wires, and the moisture of the house will prove sufficient to keep them fresh. After the first fortnight, when syringing the Vines or other occupants in the house the Dendrobes may be gently sprinkled at the same time on fine days; once daily will be ample until they are placed in baskets or upon blocks. They do well on blocks of white or red pine, to which their roots cling tenaciously, but require more care and attention than when placed in baskets. When secured upon blocks with the intention of eventually placing them in baskets the wood used should only be small and well charred. The method of placing them upon blocks is simple. A few small nails should be driven into the sides, and the plants secured by means of copper wire after placing a little sphagnum moss over their roots. In an atmosphere moderately charged with moisture and in the temperature named the most prominent buds will soon show signs of moving, then the plants should at once be placed on permanent blocks or in baskets. The size of the baskets to be used entirely depends upon the size of the plants.

In placing them in baskets a layer of crocks should be placed at the base and covered with sphagnum moss, then filled almost level with two parts of fibry peat from which the small particles have been shaken to one part of living sphagnum and small lumps of charcoal. Upon this the plants should be placed and their growths carefully secured in an upright position. The roots must also be made firm, but the base of the pseudo-bulbs must not be buried, or the breaks are liable to damp, especially if moisture is given in excess. A thorough soaking will not be needed until the plants are fairly started into growth if care is taken in dewing them with the syringe once or twice daily according to the weather. When fairly started they should have more moisture, and the night temperature kept at about 60°, with a rise of 10° or more from sun heat by day. The breaks when 3 or 4 inches in length will commence forming roots. If the plants show flower, which they often will when received during winter and spring—the flowers, if allowed to open, must not remain upon the plants for any length of time, or the new growths will suffer. After the roots have commenced working amongst the material in the baskets all danger of failure with the plants is past. From this time until their growths are thoroughly completed the plants should never suffer by want of water at the roots or

moisture in the atmosphere; on the other hand they must not be saturated, or their roots will fail to work freely. When in active growth they delight in a moderately close, moist, and warm atmosphere. During the summer the night temperature may safely range at from 70° to 75°, and be allowed to increase by sun heat to 85° or 90°.

Shade must be given during the growing season, but not so as to exclude light—merely breaking the strong rays of the sun. Abundance of light, with a little air admitted daily, is of the utmost importance to solidify the growths as they are made. This is most essential during the latter stages of growth; and when completed, which is readily determined by the small leaf that is produced on the termination of the pseudo-bulb, more light than ever must be admitted until the plants will bear full sunshine. Full exposure must be brought about carefully and gradually. Give sufficient water to keep them fresh, with more air, until every leaf naturally ripens and falls off. Any deficiency in the supply of water at this time is apt to bring the plants prematurely to rest, which results in the diminished size of the pseudo-bulbs and limits the number and size of the flowers.

After the growths have been well ripened the plants should be gradually brought to a cooler temperature until they can be rested in a temperature of 45° or 50° with a dry atmosphere. They should be allowed to become thoroughly dry, only giving sufficient water to keep the stems from shrivelling. A long season of rest is advantageous to insure the plants flowering well and making stout vigorous growths the following season. It is not difficult to maintain a succession of bloom by introducing a few plants into more heat and moisture while the remainder are resting. Care must be taken that the plants are not transferred directly from a cool and dry house to strong heat and moisture. They must be gradually inured to the change by affording them a few degrees' more heat at intervals of two or three weeks until they are placed in a night temperature of 60°. The practice of moving these plants from the house in which they are at rest into one at least 15° warmer is unnatural; and the flowers, which were probably showing from nearly every joint, will often turn yellow, and many of them fail to expand.

When the plants have flowered they should have exactly the same treatment as recommended for the first season for the plants that had started into growth. Before the roots commence working, the old sphagnum and as much of the surface peat as can be removed should be carefully picked out from amongst the roots and fresh material added, by which means the plants may be kept in the best health and condition. If the material be allowed to become thoroughly decomposed the plants will not long flourish; in fact, instead of their growths increasing in size and numbers they will gradually decrease. It is important that the material about their roots be kept fresh even if the plants are grown in baskets, for I am convinced that more failures are due in the cultivation of Orchids through inattention to this matter than any other cause.

When the plants require larger baskets the wires should be removed, and the baskets containing the plants be placed in others of a larger size, merely removing as much of the decayed compost at the time as possible. This is decidedly preferable to trying to take them out of the baskets in which they have been

grown and injuring the roots in the operation. These plants while making their growth are subject to red spider, which is readily kept down by a liberal use of the syringe.

I may add that *D. crassinode*, *D. Devonianum*, *D. crystallinum*, and many others require exactly the same treatment. The two last require more moss and pieces of charcoal in the compost to grow them to perfection than is required by either *D. crassinode* or *D. Wardianum*.—W. BARDNEY.

DISBUDDING, THINNING, AND TRAINING PEACHES

I HAVE an opinion that Peach trees which are grown indoors on a flat trellis running parallel to the roof of the house are often defoliated too much or too early, and this is especially the case with the shoot which pushes from the companion eye to that which produces fruit.

We will suppose that the tree has received its proper winter pruning, is furnished with fruiting branches from a foot to 3 feet long, well studded with twin and triple buds, that the wood is firm and ripe to the point, and has needed no shortening. Along its entire length, soon after it meets with a suitable temperature, it will be clothed with perfect flowers, and almost immediately a shoot will start from the base of each flower, while the triplet buds will generally furnish two shoots.

As soon as the blooms are expanded many of them will be seen to be placed where the fruit would not have the best possible chance of coming to perfection, and, as there is at least twenty for every one we want, there is ample opportunity for selection of the fittest. Those on the upper side of the branch are to be preferred, as they will have a better chance of receiving direct sunlight; while those on the lower side, and such as are apt to come in contact with the trellis, or from any cause be unfavourably situated, are to be rubbed off at once, leaving, we will say, four to six blooms to the linear foot, all of which are favourably placed. This is done before the flowers are set, or very soon after. If it is deferred till the petals will fall off on being touched, then some of the superfluous shoots may be removed with the flowers and with the same grip. As soon as the young fruits can be seen to be swelling a further thinning takes place, leaving this time about double the quantity of fruits we intend to leave at the final thinning, which takes place a week later.

The successional shoot for fruiting the following year has now to be looked after. This springs from the base of the present fruit-bearing branch, and the lower down we can obtain it the better will the tree be furnished. We prefer to have no fruit in the way of this, and if there is plenty on the upper portion of the branch we remove all at the lower end to the length of 4 to 6 inches. The wood buds, too, with the exception of the one in question, are removed to this length, not all at one time, but sufficiently fast to keep a clear headway for our successional shoot. When disbudding and thinning take place thus early, provided it is not done too much at a time so as to cause a check, the successional shoots will quickly become strong, and if not looked after in the matter of training they will be difficult to tie in straightly at a later date.

The fruit-bearing branch being clear, as I have said, for 4 or 6 inches, I make a practice of tying the successional shoot down to it before it has had time to become stiff. It cannot at this early period be tied to the trellis, but afterwards it can easily be trained to it. It is just where it springs from the old wood that there is apt to be a curvature, which half a dozen ties the following season will not wholly correct; but taken in time now and tied as I have indicated, it will when it becomes hard remain in the position desired without the employment of much force.

But the point to which I wish to draw special attention is that the shoots left for the purpose of encouraging the sap towards the fruit are generally stopped too closely. The first five or six leaves on the new shoot are small and presumably

imperfect. There are sometimes as many as eight or ten of these undersized leaves, forming almost a whorl at the base of the shoot, and taking up not more than three-quarters of an inch of its length, and most of them fall before the stoning period is passed. These small leaves almost entirely cover the fruits in their earliest stage, but when the fruits become larger and harder they need the light, and the small leaves fall off. I take a lesson from this, and instead of stopping the shoots to three or four leaves, as is often recommended, three or four leaves in addition to the small ones are pulled off, and then when the shoot is 5 or 6 inches in length, and has several good leaves so far away from the fruit that they cannot possibly shade it, the point is picked out. The result is that before stoning time the fruit has become a good deal hardened, and, some of the Nectarines especially, show it by their colour. The terminal shoot, which generally has a fruit at its base, is treated in the same way.—WM. TAYLOR.

EARLY-FLOWERING GLADIOLI.

THOUGH not so stately as the varieties of *G. gandavensis* these bloom considerably earlier, and on that account are very valuable either in the garden for decoration, or where cut flowers are in demand, as they afford a plentiful supply when other flowers are not very abundant. Once planted they give no further trouble, but continue increasing, forming effective clumps, which, when in masses that have not been disturbed for a dozen years or more, are grand. Not the least of their merits is that of not being so particular as regards soil and situation as the choicer and more imposing relatives, but no idea can be formed of their effectiveness from newly planted bulbs. It is important, however, to select a site for planting where water does not stagnate in the subsoil—indeed it should be well drained, and light rather than heavy. Anything likely to form a close heavy mass, as manure mixed with the soil in quantity, should be avoided, although a very light poor soil will bear considerably more enrichment than heavy soil; and the latter should be made porous by a free incorporation of sand or ashes. After the bulbs are planted and established a top-dressing of well-decayed manure, leaf soil, or decayed vegetable matter will be advantageous, the surface being pointed previous to its application, which should be effected as soon as the stems have died. If the summer be hot and dry a good soaking of water or weak liquid manure will greatly benefit the plants and durability of the flowers.

The best time to plant is October, as they start into growth early, and established clumps commence growth early in autumn; but I have planted purchased bulbs as late as March, which, though not so good as those earlier planted the first year, have nevertheless formed equally effective masses. The corms of the *G. ramosus* section should be planted 6 inches apart, half a dozen or more in a clump, and these in a few seasons will form magnificent masses. They should be planted from 4 to 6 inches deep, and in heavy soil it will be advisable to place a little sand under and over the corms. The smaller varieties of the summer-blooming Gladioli should be planted 4 inches apart and that depth. It may be noted that they do remarkably well where the soil is of a peaty nature, and they may be employed in association with Rhododendrons.

The species *G. ramosus* has deep rosy-red flowers flaked with white. The following varieties are cheap and good: Queen Victoria, scarlet, with large white flake and of dwarf habit; Ne Plus Ultra, deep red, flaked white and crimson, one of the hardiest and best. Floribundus, white, rose, and violet flakes, has entirely died out with me, and so have others of the hybrids of *ramosus*, the exceptions are *formosissimus* and *emicans*. Of the early-flowering section *Gladiolus communis albus* and *roseus*, though small, are very pretty. *G. byzantinus*, rosy purple, is very showy. *G. insignis*, with its dense spikes and bright scarlet flowers, flaked crimson-purple, is very striking. *G. blandus*, dwarf, flesh-coloured with dark spots, is one of the earliest to flower, and is more or less fragrant. *G. cardinalis*, bright scarlet, is one of the most useful and effective. *G. Colvilli*, purple, striped lilac, and its var. *albus* (The Bride), afford flowers for cutting, than which there are few finer in existence. *G. sagittalis*, purple, and dwarf

habit, of which there are several varieties; *G. trimaculatus*, rose, spotted white, and *G. segetum*, purple, from the Austrian Tyrol, are all worth place in every garden.

Early-flowering Gladioli are charming in pots for decorative purposes, and for forcing to precede those grown in the open ground or forwarded by cool treatment. The bulbs are potted as soon as they are received in autumn, and are placed in 5 or 6-inch pots, four or five corms in each, employing a compost of light turfy loam with a little sand, covering the corms about an inch deep. It is advisable to have the compost in a moderately moist condition, so as to avoid the necessity for giving water till the growth has commenced. They do very well under the stage of a greenhouse until they have made a growth of a few inches, then they should be placed in a position near the glass, and duly supplied with water and weak liquid manure once a week, being careful not to overwater them. If placed early in the year in a light airy house with an intermediate temperature they will advance rapidly and flower in April or early in May, or in the latter month if brought on in an ordinary greenhouse temperature. Others can be placed in a cold frame or pit, or outdoors, plunged in ashes, from which they can be transferred at intervals to the greenhouse for a few weeks, thence to a house with a temperature of 50° to 55°, and, assigned a light position, they will come in useful for general decorative purposes. Brought on in an ordinary greenhouse they will flower in late May or early June, and precede those in the open ground. To form effective masses for conservatory decoration any size of pot may be employed, placing the corms a couple of inches apart, and an inch from the sides of the pot, giving them similar treatment to those in smaller pots. After flowering they may be placed outdoors, that is after the middle of June, and being properly supplied with water they will be available for flowering again in successive years, and from having the growth accelerated and ripened at an early period they will acquire an early habit, and be all the more valuable on that account; or, planted out after flowering, they be attractive each season.

I may especially mention *G. Colvilli*, purple lilac, and its var. *albus* (The Bride), pure white, which are valuable, force readily, and ought to be grown by everyone.—G. ABBEY.

POTATO DISEASE.

A SHORT report is given in the Journal of the 15th inst. of objections offered by Mr. George Murray, at the Royal Horticultural Society, to certain views of mine on the so-called sclerotia of *Peronospora infestans*. He says that "a microscopical examination of certain specimens did not clearly reveal any organic connection between the sclerotia and the *Peronospora* mycelium." But it has to be kept in view that generally the edges of the sclerotia plasmodiate before myceliation begins; so that, in point of fact, the granular plasm from which the *Peronospora* mycelium arises has lost all organic connection with the undissolved part of the sclerotia. On rare occasions, however, excessively delicate threads in considerable numbers can be distinctly seen to arise from a sclerotium.

These sclerotia have been seen already by Mr. W. G. Smith, and perhaps by others; and whether they are truly called sclerotia (as Mr. Murray denies) is a mere matter of classification. Mr. Murray says sclerotia are "a compact mycelium." But sclerotia are not going to be tied up in this narrow way. It is true that some sclerotia consist for the most part of compact mycelium; but, in addition to the short anastomosing lines, there is the hornified plasm which holds these lines together. If they are "caught young" something more may be made of them. It is then seen that the mycelic lines arise from exuded plasm around the mass already formed. But in the case of the best known of all the sclerotia—Ergot, the mass consists for the most part of agglutinated spores. If a white young Ergot is squeezed out on the slide it is seen to consist of whole oceans of spores (variously named) arising from a spongy mycelic axis.—A. STEPHEN WILSON.

FUCHSIA MRS. RUNDSELL.—I wish to point out an error of your correspondent, "W. J. M., Clonmel," on page 241, where he says that Mr. Cannell is the raiser of this Fuchsia. I beg to state that I was the raiser of this variety, and Mr. Cannell obtained it from me. I quite agree with "W. J. M." as to its being a vigorous grower, and is most certainly a free winter bloomer. It is the result of a cross

between the light Fuchsia Lady Heytesbury and F. Earl of Beaconsfield, Earl of Beaconsfield being the seed-bearer. The name is spelt Rundell, not Rundle. I have other new varieties, one of which will be found to possess qualities far superior to Mrs. Rundell, both in its vigorous growth and winter-blooming qualities.—ALFRED RUNDSELL.

LIVERPOOL HORTICULTURAL SOCIETY.

MARCH 20TH AND 21ST.

THE first spring Show of the above Society was held in St. George's Hall under very unfavourable circumstances. The inclemency of the weather—snow, rain, and sleet—prevented many exhibitors staging their plants; nevertheless the competition was keen in several classes, and very few vacant spaces were to be seen. The most marked deficiency was noticeable amongst the large stove and greenhouse plants. On the whole the Exhibition was an excellent one, and far exceeded the expectations of the Committee.

Stove and Greenhouse Plants.—In the class for six plants, three in flower, Mr. W. Mease, gardener to C. W. Newmann, Esq., Wyncote, Allerton, had no difficulty in securing the premier position; Mr. G. Leadbetter, gardener to T. S. Timmis, Esq., having the second place. The former staged Crotons Wiesmanni and Queen Victoria, fine, large, well-coloured plants, fully 7 feet through; Clerodendron Balfourianum; Thrinax elegans, large; Azalea Flower of the Day, profusely bloomed; Dendrobium nobile, about 3 feet through and very good. The second collection contained a very fine well-flowered plant of the last-mentioned, also a good Azalea amoena, Alocasia metallica, and a large plant about 7 feet through of Gleichenia dichotoma in the best possible health. For one stove plant in flower Mr. W. Evans, gardener to Mrs. Lockett, Aigburth, was deservedly placed first with Phaius grandiflorus, a large specimen with spikes of flowers fully 5 feet high. Mr. Jellico, gardener to F. H. Gossage, Esq., Woolton, was second with the same variety, which was considerably past its best. Mr. M. Wood, gardener to Col. Wilson, Aigburth, was an easy first in the corresponding class for one greenhouse plant in flower with the finest plant of Imantophyllum miniatum splendens that we have seen exhibited, being between 7 and 8 feet through and thickly crowded with splendid trusses. Mr. J. Hurst, gardener to W. B. Bowering, Esq., followed with a fair Erica Wilmoreana. Mr. Mease took the lead for one foliage plant with a splendid example of Croton Williamsi; Mr. A. R. Cox, gardener to W. H. Watts, Esq., Elm Hall, Wavertree, second. Mr. S. Whitfield, gardener to J. T. Cross, Esq., Beechwood, Aigburth, was placed first in the class for three Palms or Cycads, followed closely by Mr. J. Phythian, gardener to D. Walker, Esq., Forest Lawn, West Derby, the former staging in the best of condition fair-sized plants of Latania borbonica, Phoenix reclinata, and Thrinax elegans.

For one Palm the same exhibitor was again first with a noble specimen of Kentia australis, Mr. J. Hurst being placed second with a healthy young plant of Phoenix reclinata. Seven or eight competitors staged in this class. There were only two exhibitors in the class for six table plants, and the first and second prizes were awarded to Messrs. G. Leadbetter and W. Mease, both staging small, light, and neat plants, especially the first named exhibitor. Mr. Edward Green, gardener to J. Woolright, Esq., The Hollies, Mossley Hill, and Mr. G. Leadbetter were the prizetakers for Cinerarias, which need no further comment. Primulas were not numerous, only two lots being staged for the prizes given, the plants in both collections being fully 18 inches through and a mass of bloom, the whites being much superior to the reds, Messrs. J. Phythian and E. Green being the prizetakers in the order named. There were four competitors for Cyclamens, and the plants on the whole were not in the best condition, some being worthy of special mention, with the exception of the first-prize plants shown by Mr. J. Jellico, which had flowers of large size. Mignonette we have seldom seen staged in better condition, the plants throughout being in good health, with large dark green foliage and very large flower spikes. Messrs. J. Jellico, W. Mease, and T. Robinson, gardener to D. Holmes, Esq., Lyndhurst, Mossley Hill, were the successful competitors, those shown by the two first exhibitors being especially fine, Mr. Jellico staging pyramids and Mr. Mease bushes, the variety being Miles' Hybrid Spiral.

Azaleas.—These added materially to the beauty of the Exhibition. Mr. W. Evans was the only exhibitor in the open class for six plants. The specimens staged were about 5 feet high, of pyramidal habit, and well bloomed. His best plants were Eulalie Van Geert, Fielder's White, and Reine des Roses. In the amateurs' class for three plants Mr. J. Hurst took the lead with well-bloomed half-specimens, Stella and Charmer being the two best. Mr. G. Moreton was placed second. For one plant Mr. W. Mease was well first with a large plant in good condition of Souvenir du Prince Albert, Mr. A. R. Cox being second with Iveryana.

Ferns.—The competition was keen in the few classes devoted to these plants. Mr. A. R. Cox was first for four plants with very healthy even specimens of Adiantum cuneatum, A. farleyense, Lomaria gibba, and Gleichenia Mendelli; Mr. J. Phythian being second with larger plants of Blechnum corcovadense, Alsophila australis, and A. excelsa. Mr. J. Stephenson was awarded the remaining prize. For one Fern Mr. W. Evans was deservedly placed first with a very fine plant of Goniophlebium subauriculatum, Mr. J. Jellico

second with Davallia Mooreana 6 feet through, and Mr. G. Moreton third with the same species.

In the open class for a group of miscellaneous plants arranged for effect, space not to exceed 50 feet, there was only one exhibitor—Mr. Cox, who was awarded the first prize. The group was light and very well arranged, Palms, Crotons, Aralias, Caladiums, Hyacinths, Tulips, and other similar plants rising well above the groundwork of Ferns and dwarf flowering plants.

Orchids.—There were only two classes for these, but the specimens staged were in very good condition. For four plants Mr. W. Moss, gardener to W. Holland, Esq., Mossley Hill, took the lead with Zygopetalum crinitum, good; Odontoglossum Halli leucoglossum, good variety, with a large spike of fine flowers; Lycaste Skinneri, a large plant remarkably well bloomed, and a fair plant of Ada aurantiaca. Mr. J. Edwards, gardener to T. S. Walker, Esq., Rodney Street, Liverpool, was second, having a grand spotted variety of Odontoglossum Alexandræ, Oncidium Marshallianum, and O. maculata superba. For one plant Mr. J. Stephenson was first with a well-flowered specimen of Cœlogyne cristata, Mr. G. Leadbetter with Dendrobium Wardianum, and Mr. W. Mease with a large plant of D. fimbriatum oculatum secured the remaining prizes.

Forced Hardy Plants.—There were four or five competitors in the class for four plants, Mr. G. Moreton being awarded the premier position with a large plant of Azalea mollis; Azalea Daviesi, good; Deutzia gracilis, profusely flowered and about 6 feet through; and a fair Tea Rose, Souvenir d'un Ami. Messrs. W. Mease and W. Bustard were the remaining prizetakers, the former staging creditable plants of Rhododendrons Everestianum, Madame Wagner, and R. fragrans, a very useful small-flowered variety. Rhododendrons were not numerous, but the few staged added materially to the beauty of the Exhibition. Mr. W. Bustard was the only exhibitor in the class for four, and staged creditable plants. Messrs. W. Evans and W. Bustard were the prizetakers in the class for one specimen; both staged large well-flowered plants of George Cunningham. For one greenhouse variety Mr. Cox was first with a handsome profusely flowered plant of R. Gibsoni, Mr. W. Evans second, and Mr. J. Stephenson third, both showing the same kind. The first-named was first in the class for Roses, and Mr. J. Phythian staged the best pans of Lily of the Valley.

Hardy Herbaceous and Bulbous Plants in Flower.—Four exhibitors staged in the class for ten plants, the exhibits on the whole being good and attracted considerable attention. Messrs. J. Dickson and Sons, Newton Nurseries, Chester, were well to the fore with fine pots of Spiræa japonica, Dielytra spectabilis and its white variety alba, Aubrietia Hendersonii, Primula marginata, Chionodoxa Luciliæ, bright; Tulipa retroflexa, Narcissus bicolor Empress, N. moschatus, and a good pot of N. Bulbocodium. Mr. J. Hurst second; his best pots were Polemonium cæruleum, Narcissus Empress, and Scilla campanulata; Mr. W. Morris, gardener to R. R. Heap, Esq., West Derby, having good examples of Primula cortusoides.

Hyacinths.—These constituted the chief feature of the Exhibition, and were better than we expected to see them, for the bulbs generally were not good last autumn. For eighteen plants Mr. W. Mease was well first with a very neat collection, his best being—Blues: Sir C. Napier, Marie, good; Baron Van Tuyl, King of the Blues, and Grand Maitre. Yellows: Obelisque, very fine; and Duc de Malakoff, the best spikes we have seen for a long time. Reds: Koh-i-Noor, the best spike of this variety in the Show; Howard, bright; and Lord Macaulay, good. Whites: Alba maxima, La Grandesse remarkably good, and Mont Blanc. Pinks: Florence Nightingale and Grandeur à Merveille. Mr. G. Moreton was a good second, his plants being a little taller. His best reds were Von Schiller and Howard. Dark Blues: King of the Blues and Baron Van Tuyl. Light Blues: Lord Byron, good; Lord Derby, fine; and Grand Lilas. Whites: Madame Van der Hoop, large and good. Mr. J. Kelly, gardener to R. Singlehurst, Esq., was awarded the remaining prize. The plants in this collection possessed the best spikes of the three collections, but had not been well handled. His spike of King of the Blues was remarkably large, while King of the Reds was conspicuous by its brightness. The same exhibitor was again first for twelve Hyacinths, staging dwarf plants similar to those in the first collection; Mr. J. Kelly second, having a fine spike of Gladstone; Mr. W. Evans took the remaining prize, and had good Lord Macaulay, red, and Baroness Van Tuyl, white. Mr. J. Phythian secured the first prize for six plants, having good examples of Nimrod, Mont Blanc, and Von Schiller. Messrs. A. R. Cox and E. Green were the remaining prizetakers, the last showing Ida (yellow) in good form.

Tulips.—These were well represented, and the competition in some of the classes was keen. Mr. G. Moreton was first with twelve pots in not less than six single varieties, and staged a very creditable assortment. His best were Groost van Vondel, Vermillon Brilliant, Keyzers Kroon, Fabiola, Proserpine, and White Pottebakker. Mr. Minshul, gardener to H. Nash, Esq., Aigburth, followed, having Golden Standard, Cottage Maid, and White Swan very good; Mr. W. Mease had the third prize. For six pots Mr. J. Phythian was successful with Van der Neer, Chrysolora, and Keyzers Kroon; Messrs. E. Green and J. Hurst second and third in the order named. For ten pots of double varieties Mr. Mease was awarded the premier prize, followed by Mr. W. Evans. The best in the first collection were Golden Tournesol, Murillo, Blanche Hâtive, and Tournesol. In the

corresponding class for six pots the prizetakers were Messrs. G. Moreton and W. Bustard.

Miscellaneous Exhibits.—The various exhibits contributed by local nurserymen added materially to the beauty and attractiveness of the Exhibition. Messrs. T. Davies & Co., Wavertree, staged a magnificent collection of plants in flower, including Azaleas, Rhododendrons, Amaryllises, Spiræas, Dielytra spectabilis, and many other seasonable plants, the most striking feature of this collection being about one hundred Hyacinths in grand condition, and about the same quantity of Tulips and pots of Lily of the Valley, the latter being magnificent with spikes and bells of enormous size. Messrs. R. P. K& Sons contributed a very choice collection of spring-flowering plants intermixed with Palms, Ferns, and others. In this collection Impatiens Sultani was conspicuous, and the Judges awarded it a first-class certificate. *Choisya ternata*, remarkably well grown, was also very effective in this group. The Horticultural Company (John Cowan) also contributed a similar assortment of plants freely intermixed with Tea Roses in bloom and Orchids. Mr. Bridge, gardener to Mrs. Jowett, Huyton, sent a box of Tea Rose blooms, *Alba rosea*, remarkable for size and substance, for which an extra prize was awarded. The Horticultural Company had a first-class certificate for a new crested form of *Pteris serrulata cristata* named *Cowani*, which is very distinct.

The manner in which the various arrangements of this Exhibition were carried out reflected great credit upon Mr. Richardson the Chairman, Mr. J. Gore, Secretary, and the whole of the Committee.

ROOT-EXTENSION VERSUS ROOT-RESTRICTION.

ON no subject are authors of garden literature more at variance than on the matter of soils most suited to the requirements of the different classes of plants; and in many cases, though the practice differs very widely, it is astonishing how near alike the results are. The cause of this is not so difficult to explain as at first sight it may appear, for each grower treats his plants according to the compost in which he has planted them. But although equal results may be obtained from soils distinct in their chemical nature, the same effect seldom follows the opposite practice of restraining or extending the root space.

From an early period it has been observed that if the roots of a plant be restricted, its floriferous habit, and as a natural consequence its fruitfulness, will be increased. That there is some grounds for the idea very few will doubt; but it is hard for a gardener who has mastered his business to believe that it is altogether correct. If we take a glance at the gardens of the past and compare them with those of the present, we cannot help thinking that the idea is little believed in. Do we not still see restriction recommended, though so little practised in first-class establishments? Are we to think, then, that theory and practice are opposed on such an important matter? There may be cases in which the restricted method is necessarily applied where convenience is small, but for my part I would rather grow a few plants well than crowd the place with stunted specimens.

Those of us who have had charge of Vines in pots know well the greater amount of attention and labour were incurred in early forcing as compared with Vines in inside borders, and not a few have been disappointed at the sometimes very scanty crop of the former. Can we wonder, then, that the more rational system is gradually gaining favour? Take orchard-house trees again. A few years ago much was said in favour of growing fruit trees in pots. Orchard houses were built and filled with such trees; but comparatively few remain, for the roots are revelling with freedom in the soil which before they could only reach after long struggles through the perforated bottoms of the pots, and better results fully justify the change.

But it is not so much in the culture of fruits as of plants that restriction is most practised. Take the *Allamanda* for instance; though often grandly flowered in a pot it cannot be compared to the glorious spectacle produced by a plant in a border, the growths trained up the roof of a stove. The same remark applies to *Clerodendrons*, *Bougainvilleas*, and many others. Nor do I leave out the *Stephanotis*. Though well aware that it is contrary to the practice of many good growers, I hold that it is never seen in its best except where it has the root run of a prepared border. If the plants are grown for exhibition or to be removed for conservatory decoration, then they must of necessity be grown in pots or tubs; but if required for cutting or to see them in all their glory they require to be planted out.

If we are to take a lesson from Nature the reason is soon obvious why freedom of root-action produces better results than where the roots are restrained. Not that we can follow Nature in all respects, but it is time for us to forego past notions if modern practice has proved them to be incorrect.—J. MACDONALD.

LIFTING VINES IN MARCH.—In reply to your correspondent Mr. Nunns in relation to the age of the Vines referred to on

page 189, I wish to say that I cannot give him the exact age of the Vines when lifted, but should think they had been planted about twenty years. This is the nearest I can gather from some of the men here, although the Vines did not look that age in appearance, for their stems had evidently discontinued swelling. They have, in fact, nearly doubled in size near the base since they were lifted, but the higher portions of the canes have not swelled to the same extent. I have known the Vines in question a little over seven years, but had no control over their management until five years ago. The first year I knew them a trench was cut some 4 feet from the front of the border, and the contents of a number of closets were deposited in the trench, which killed a considerable quantity of the roots that were not cut off with the spade in making the trench. To this I attribute the cause of the roots springing from the collar as mentioned in my notes. This instance of manuring Vines with a vengeance, and the result is perhaps worth recording.—W. BARDNEY.

POTATOES FOR TABLE AND MARKET.

(Continued from page 234.)

In the following notes the figures 1, 2, and 3 indicate first early, second early, and late varieties; the months the time of planting; and the asterisks those varieties that are considered the best for market purposes by the respective cultivators.

SUSSEX.—1. February and March. Old Ashleaf, *Myatt's Ashleaf and Veitch's Ashleaf. Soil.—Medium. 2. March. Woodstock Kidney, *Early Rose, and Beauty of Hebron. Soil in this and the following section heavy. 3. Early in April. Paterson's Victoria, *Magnum Bonum, Schoolmaster, and Queen of the Valley. Manures and Application.—Stable manure dug-in in the autumn. If any artificial manure is used it is applied soon after the Potatoes appear above ground, superphosphate of lime being then hoed or forked in. General Remarks.—This is very bad soil for Potatoes, but by generous cultivation and planting wide I obtain good table produce and crops from the sorts mentioned.—G. WILLIAMS, *The Gardens, Peasmarsh Place.*

1. First week in March. *Myatt's Ashleaf and *Veitch's Improved Ashleaf. Soil.—Medium, being made so by leaf soil, ashes, and cocoa-nut fibre refuse mixed together. The natural soil here is a heavy loam, not good for Potatoes. 3. Second week in March. *Magnum Bonum and *Schoolmaster. Soil.—Same as for early sorts. Manures and Application.—Manure from decayed hotbeds is applied in the autumn, and the ground dug 2 feet deep. General Remarks.—Early varieties are planted 2 feet 3 inches between the rows, the ground being previously forked and allowed to dry a little before planting. The sets are planted about 3 or 4 inches deep; when the Potatoes come up the ground is forked between the rows. Late varieties are planted 3 feet between the rows, and about 15 inches from plant to plant. I usually lift early, or as soon as the tops are ripe. Magnum Bonum and Schoolmaster do best on this soil, though Snowflake does well some seasons.—H. PRINSEP, *Buxted Park, Uckfield.*

1. February. Veitch's Ashleaf, *Royal Ashleaf, and Myatt's Ashleaf. Soil.—Light. 2. March. Bresee's Peerless, Schoolmaster, and *Beauty of Hebron. Soil.—Medium. 3. April. *Magnum Bonum, *Scotch Champion, and White Elephant. Soil.—Heavy. Manures and Application.—Spent hotbed manure dug-in in the autumn for early varieties, and a dressing of the same in the spring for second earlies; but for late kinds newly reclaimed land with farmyard manure is best placed under the Potatoes at planting-time. General Remarks.—Potatoes as a rule are too closely planted; the rows should be a yard apart. A crop of Brussels Sprouts or Broccoli can be planted between the rows of early kinds, and it is most important that the late kinds be planted in drills and earthed-up in summer with the plough, as is done in Scotland.—JOSEPH RUST, *Eridge Castle.*

1. Last week in February. Walnut-leaved Kidney, Early Coldstream, *Myatt's Prolific, and Porter's Excelsior. Soil.—For first and second earlies light and rich. 2. Middle of March. Improved Lapstone, Daintree's Seedling, Beauty of Kent, and *Adirondack. 3. End of March. *Paterson's Victoria, *Scotch Champion, *Pride of Ontario, and *Magnum Bonum. Soil.—Poor and sandy. Manures and Application.—Farmyard manure when possible, otherwise the leaves and short grass collected in the pleasure ground, well rotted, with all the ashes and charred refuse that we can collect spread on the ground in spring, and well worked into the soil with the cultivator during dry weather. General Remarks.—Trenching and ridging the soil during the autumn and early winter, levelling the ridges in spring when dry, and carting or wheeling the manure on to the surface, to be afterwards worked into the soil in the manner indicated. We plant 16 to 18 inches apart in rows 30 to 42 inches apart, according to variety. So soon as the tops are above ground the cultivator is kept at work loosening and sweetening the soil until the plants are ready for moulding up. The crop is dug as soon as ripe, and stored in a cold dark cellar in preference to earth pits. For seed we like the tubers about the size of a hen's egg, and find no better place for storing than the shelves of the Apple-room. The varieties enumerated with the mode of cultivation gives us excellent crops of good quality, with little or no disease.—J. GILMOUR, *Seacox Heath, Hawkhurst.*

1. March. *Myatt's Prolific Ashleaf, *Rivers' Royal Ashleaf, Coldstream, and Grampian. Soil.—Medium. Originally a thin poor silicious soil upon the Hastings sand formation, almost barren, but now rendered thoroughly fertile and porous by heavy dressings of farmyard manure, lime, and coal ashes. 2. April. Snowflake, *Dalmahoy, Yorkshire Hero, and *Early Rose. 3. April. *Magnum Bonum, *Dunbar Regent, and Paterson's Victoria. Manures and Application.—In addition to the manure used as mentioned in connection with character of soil, a liberal dressing of "Three Star" Crown Manure is scattered along in the rows at the time of planting the Potatoes. Last summer several sorts of manure were tried in this way in soil quite innocent of manure, and the result was so decidedly in favour of the Crown Manure Company's manure that I prefer it to any other. General Remarks.—Nothing is gained by pressing on the planting in unfavourable weather. The seed tubers are spread thinly in the store shed upon trays near the windows, and often have stout green sprouts upon it nearly an inch long at the time of planting, which is done when the soil is sufficiently dry for the purpose. When the growth is well above the surface the soil is well stirred between the rows, and the earthing done at the same time with a light steel fork. The main haulm growth is watched closely, and as soon as it ceases, while yet quite green, and before there is any possibility of lateral growth, the tubers are lifted and stored. Early, medium, and late sorts are so treated, each in turn, and the entire crop is invariably saved free from disease, unless wet weather sets in at the critical moment of the first cessation of growth, in which case there will be a certain per-centage of loss from disease. After the tubers are in the store shed they are examined, and turned frequently till they are quite dry and ripe for winter storage.—EDWARD LUCKHURST, *Oldlands, Uckfield.*

WARWICKSHIRE.—1. February. Veitch's Improved Early Ashleaf and Rivers' Royal Ashleaf. Soil.—Light and rich. 2. March. Bedford Prolific and Beauty of Kent. 3. Magnum Bonum and Scotch Champion. Soil.—Light loam. Manures and Application.—Farmyard manure alone is used.—WILLIAM BROWN, *Merevale Gardens, Atherstone.*

1. February and March. Mona's Pride, *Veitch's Ashleaf, and Myatt's Prolific. 2. These and the late varieties are planted in March and April. *Keeper's Kidney and Beauty of Hebron. 3. *Magnum Bonum, *Paterson's Victoria, and Suttons' Flourball. Soil.—Light throughout. Manures and Application.—Stable manure and lime, about half a dressing dug-in together. General Remarks.—In my experience I find early planting and early lifting the best practice to adopt.—THOMAS BEDDARD, *The Gardens, Stoneleigh Abbey, Kenilworth.*

1. Second week in March. Early May, Mona's Pride, *Veitch's Ashleaf, and Rivers' Royal Ashleaf. Soil.—Medium, but very tenacious. 2. Third week in March. *Rector of Woodstock, *Porter's Exceelsior, Victoria Regent, and *Schoolmaster. No late sorts are grown. Manures and Application.—Hotbed manure is dug in during winter, and the ground ridged up.—JAMES RODGER, *The Gardens, Charlecote Park.*

1. First week in March. Kidney Racehorse, *Mona's Pride, *Myatt's Prolific, and Prince of Wales. 2. March 20th. Kidney, Snowflake, Early Rose; round, Grampian and Schoolmaster. 3. First week in April. Reading Hero (round), *Magnum Bonum (kidney), Red-skinned Flourball (round), and *Scotch Champion. Soil.—Medium. Manures and Application.—Farmyard manure dug in during October or November. General Remarks.—I have during the last thirty-three years planted with the dibber. I find it much quicker than drilling or planting with the spade, and have never had one case of failure in all that time.—DAVID LESLIE, *Appleby Castle.*

WILTSHIRE.—1. End of March. Veitch's Early Ashleaf, Rivers' Royal Ashleaf, and *Myatt's Prolific. 2. April. Dalmahoy, Flourball, Schoolmaster, and *Grampian. 3. Paterson's Victoria, Magnum Bonum, Scotch Champion, and Wormleighton's Seedling. Manures and Application.—I prefer manure not too much decomposed, as it keeps the soil more open. General Remarks.—I plant with the spade in shallow trenches. If the seed is selected with care all the plants come above ground together. I prefer medium-sized Potatoes for planting to either large or cut Potatoes, and find it best when taking up the crop to then select the seed for the coming year, being very careful as to size and shape, thus always securing good samples. I plant early varieties 20 inches by 9 inches, second ditto 2 feet by 10 inches, and late varieties 4 feet by 1 foot.—CHAS. DAVIES (*late of Chalcot Gardens*), 106, *Malden Road, London, N.W.*

1. February and March. *Beauty of Hebron, Myatt's Ashleaf, *Veitch's Ashleaf, and Rivers' Ashleaf. 2. *Covent Garden Perfection, Suttons' Fiftyfold, Rector of Woodstock, and Fortyfold. These and the next are planted in March; the soil medium and chalky. 3. *Magnum Bonum, *Paterson's Victoria, Peachblow, and Schoolmaster. Manures and Application.—Stable manure applied to the land in autumn and winter. General Remarks.—We plant on land which has been heavily manured and dug in the previous autumn and winter months. There are three points to which we attach the greatest importance—viz., manuring, distance at which the seed should be planted, and dishauling when the disease first makes its appearance. With regard to manuring, my experience leads

me to form an opinion totally different from the theory which has frequently been put forth in our gardening papers by some writers during the past few years. The theory alluded to is that if you manure heavily you do so at the expense of the quality of the tuber itself, and that the succulent growth resulting from such manuring is more susceptible to disease than it would be if a less quantity—or no manure at all—were applied. I have been unable to detect any difference in the same variety when grown under (other than manure) precisely the same conditions; and as regards being more subject to disease, I maintain that the contrary is the case—i.e., when they have sufficient room to grow in, the more vigour and strength you give to a plant the better able it is to resist any form of disease. Of course the disease will make its appearance—atmospheric conditions being favourable—in the haulm of even the strongest-constituted varieties at a certain stage of their growth. When this is the case the best plan to adopt, in my opinion, is, if the tubers be large enough for use, to cut off the tops without further delay, or, what is better, if the tubers have arrived at that stage which may be designated as being within the measurable distance of ripeness, lift the crop and store away. In planting we give dwarf-growing kinds, such as Myatt's Ashleaf and Beauty of Hebron, a space of 18 inches by 15 inches, and to strong-growing varieties of the Magnum Bonum class 36 inches each way. With liberal treatment as regards manure we do not find these distances at all too great.—J. HORSEFIELD, *Heytesbury, Wilts.*

1. Middle of March. Hammersmith Kidney, Suttons' Early Border (round) *Myatt's Prolific Kidney, and Woodstock Kidney. 2. About the 20th of March. *International Kidney, Schoolmaster, Porter's Exceelsior, and *American Early Rose. 3. From the 20th to the end of March. *Scotch Champion, *Magnum Bonum, Regents, and Suttons' Reading Hero. Soil for all sorts light, with a gravelly subsoil. Manures and Application.—Well-decomposed stable-yard dung spread over the surface of the ground and dug deeply into it the preceding autumn, thereby reducing the dung to the nature of mould by the time the planting season has arrived; and the ammonia, being retained by the soil, is taken up by the plants. General Remarks.—The ground which was manured and prepared for the reception of Cabbage plants in September, 1881, will be planted with Potatoes during the present month, the only preparation necessary being the clearing-away of the Cabbage stumps and the digging of the ground. Potatoes thus treated will yield a minimum of haulm and a maximum of tubers. The latter, moreover, are, on account of the growth of the stalks being less luxuriant, more free from disease.—H. W. WARD, *Longford Castle, Salisbury.*

1. Planted in succession from the end of February to the middle of April. Soil made light. Old Ashleaf. 2. First week in April. Myatt's Ashleaf. 3. Middle of March. Scotch Champion. Soil heavy and shallow. Manures and Application.—The Old Ashleaf for the earliest crops is planted on south borders made light by the annual addition at planting time of leaf mould, spent Mushroom beds, or other light but not rich dung. For later crops we cannot afford to make the ground so light, but this variety does best on light soil. Myatt's Ashleaf does very well in our soil, and Champion is so good that I am requested to make its season as long as possible. All are manured at planting time, the Champions rather heavily. General Remarks.—Seed of the Ashleaf varieties is selected in autumn and put up on end in a shed; that of the Champion is selected and spread out singly not later than January. All are planted with the spade at the second digging. They are forked between as soon as the rows show, and earthed up very early, frequently covering them overhead entirely. Ashleaf varieties are planted 24 by 12, and the Champion 30 by 15 inches apart. We are always trying other varieties, but up to the present have not found another to suit us so well as those named.—WM. TAYLOR, *Longleat Gardens, Warminster.*

1. February. Ashleaf Veitch's Improved, *Myatt's Ashleaf, *Covent Garden Perfection, and Early Fortyfold. 2. March. Woodstock Kidney, *Schoolmaster, Vicar of Laleham, and Climax. 3. March. Paterson's Victoria, *Suttons' Magnum Bonum, *Dunbar Regent, and *Scotch Champion. Soil heavy for all kinds. Manures and Application.—The ground is well manured in the autumn, and dug as roughly as possible. A liberal supply of wood ashes is given at the time of planting.—ALEXANDER MILLER, *Rood Ashton Park Gardens, Trowbridge.*

WORCESTERSHIRE.—1. Beginning of March. Veitch's Improved Ashleaf and *Rivers' Royal Ashleaf. Soil.—Heavy, but made as light as possible. 2. Middle of March. Covent Garden Perfection, *Schoolmaster, and *Grampian. 3. End of March. *Scotch Champion, *Reading Hero, and Vicar of Laleham. Manures and Application.—We do not, if we can avoid it, plant on freshly manured ground, but select such that has been heavily manured for the preceding crops, such as Peas, Turnips, &c. After the drills are drawn for the Potatoes we sow in them a good dressing of burnt refuse and wood ashes, on which we plant the sets.—ARTHUR BARKER, *The Gardens, Hindlip.*

1. Middle of March. Veitch's Improved Ashleaf and *Rivers' Royal Ashleaf. 2. Middle of April. *Schoolmaster, Fortyfold, Dickson's Premier, *St. Patrick, *Porter's Exceelsior. 3. First week in May. *Suttons' Magnum Bonum, *Prince Arthur, *Reading Hero, and Paterson's Victoria. Soil.—For all kinds heavy and marly.

Manures and Application.—When practicable I like Potatoes to succeed Strawberries, the land having a good dressing of decayed manure in autumn, then ridged for winter exposure. When Potatoes are about 4 inches above ground I generally give them a dressing along the rows of soot, a little salt, and guano. General Remarks.—For a first early and satisfactory crop I find no variety better than Veitch's Improved Ashleaf. For an early and heavy crop my experience decides in favour of Rivers' Royal Ashleaf. For second early sorts combining quality and productiveness I give preference to Schoolmaster and St. Patrick. Late sorts for productiveness and general good quality combined Suttons' Magnum Bonum must have the premier place. I have discarded Scotch Champion, it is too wasteful in character, having to be peeled, as the common saying is, "inside and out." To those who desire quality alone Paterson's Victoria should be grown, but not to any extent, as it is subject to diseases when prevalent.—OWEN THOMAS, *Impney Gardens, Droitwich.*

YORKSHIRE.—1. *Mona's Pride, *Myatt's or Veitch's Ashleaf (I cannot detect any difference between them). 2. Lapstone. 3. *Scotch Regent, *Magnum Bonum, and *Champion. All the sorts are planted in April in heavy magnesian limestone soil. Manures and Application.—Farmyard manure. In field culture it is put in the drills with the Potatoes at the time of planting, but in the garden it is dug in during the winter. General Remarks.—I have only named the varieties such as are grown in this locality. Myatt's I consider one of the best all-round early Potatoes, it being a heavy cropper and of first-rate quality. Mona's Pride is larger, but not so good in quality. The true Scotch Regent is the best late Potato as regards quality, but unfortunately in wet seasons it is very much given to disease. The Champion and Magnum Bonum are now extensively grown for market, both yielding heavy crops of sound tubers. Magnum Bonum is now making the best price in the market. Second earlies are not much grown here. Lapstone is of first-class quality, but will not stand the disease in wet seasons.—G. SUMMERS, *The Gardens, Sandbeck Park, Rotherham.*

1. Early in April. *Early Ashleaf (original variety), and *Veitch's Improved Ashleaf. Soil.—Clay soil, made moderately light by adding year after year sand, lime, &c., to the borders. 2. Second week in April if the weather is suitable. *Edgcott Seedling, *Covent Garden Perfection, *Schoolmaster, and Woodstock Kidney. 3. Third week in April. Prince Arthur and Yorkshire Hero. Soil.—Strong clay resting on hard marly blue clay. Manures and Application.—We use stable manure under the sets at planting time, and on the top of each set put about half a shovelful of sea sand, lime, and decomposed garden refuse mixed and turned over two or three times during winter. We have used the above compound for the last three years with most excellent results. General Remarks.—This place is situated 400 feet above the sea six miles inland, and anything but suitable for producing first-class table Potatoes. However, by liberally applying sea sand, lime, &c., we get very satisfactory returns. During the last nine years we have tried upwards of sixty varieties, and from some cause or other have rejected them all except the eight sorts named.—J. MCINDOE, *Hutton Hall Gardens, York (Cleveland).*

1. Old Ashleaf, *Veitch's Ashleaf, Racehorse, and Mona's Pride. 2. *Myatt's Ashleaf, Haigh's Seedling or Lapstone, Excelsior, and *Dalmahoy. 3. Regents (York), *Magnum Bonum, *Scotch Regents, and *Champion. The early sorts are planted in warm borders about the middle of March, main crops towards the end of the month or early in April. Manures and Application.—Good farmyard manure either dug or ploughed-in some time previous to planting. If not sufficient of this we find that rape dust and guano in equal quantities mixed to be a capital manure. One of our largest Potato growers hereabouts tells me that he finds that the crop of Potatoes is considerably heavier where the manure used is from cattle that have had a good supply of linseed cake. General Cultural Remarks.—For our early crops we are careful to have the seed tubers well sprouted before planting, but not drawn—say nice dark green stubby sprouts about three quarters of an inch long. The farmers know the value of this, too, for early crops, and the most successful early Potato growers have a large supply of rectangular-shaped boxes or trays—say, 3 feet long, 2 feet broad, about 3 inches deep—in which to place their seed tubers some time in February to grow in light, yet frost-proof barns. There are hundreds of acres grown between here and Selby, within a distance of two miles each side of the river Wharf, in light loamy land not liable to be flooded, and good crops are, as a rule, procured. I do not think it is at all worth while planting Potatoes in quantity on heavy soils. Good samples of splendid quality are produced on lightish limestone soils.—HENRY JAMES CLAYTON, *Grimston Park Gardens Tadcaster.*

1. *Early Ashleaf and *Myatt's Prolific. 2. Ashtop Fluke, Lapstone, *Schoolmaster and Victoria. 3. *Magnum Bonum, *Scotch Champion, and Red-skinned Flourball. The soil is medium loam with sandy subsoil. The earlies are planted on a warm border about the middle of March, second earlies in April, and late varieties the first week in May. Manures and Application.—Farmyard manure dug-in in the autumn. Night soil and ashes applied at the time of planting. No farmyard manure to touch the sets. General Remarks.—Plant deeply, not to be ridged too early. Haulms to be thinned to three or four to a plant. I have grown thirty or forty varieties, but those named are the most useful.—REV. C. P. PEACH, *Appleton-le Street, Malton, York.*

1. Veitch's Early Ashleaf and *Myatt's Prolific. 2. *Covent Garden Perfection, Yorkshire Hero, and *Vicar of Laleham. 3. *Schoolmaster, *Prince Regent, and *Scotch Champion. Soil.—Light loam. Time of Planting.—End of March to middle of April. Manures and Application.—Stable manure, thoroughly decomposed, applied in autumn and dug in at the time of application. This for the early and second early varieties. For the late varieties farmyard manure at the rate of about 12 tons per acre placed in the rows before putting in the sets. No artificial or other hand manure employed. General Remarks.—The early varieties are planted in rows 24 inches apart and 12 inches asunder in the rows; second earlies in rows 30 inches apart, and sets 15 inches asunder. Late varieties in fields same distance as the second earlies; but in richer ground, as that of

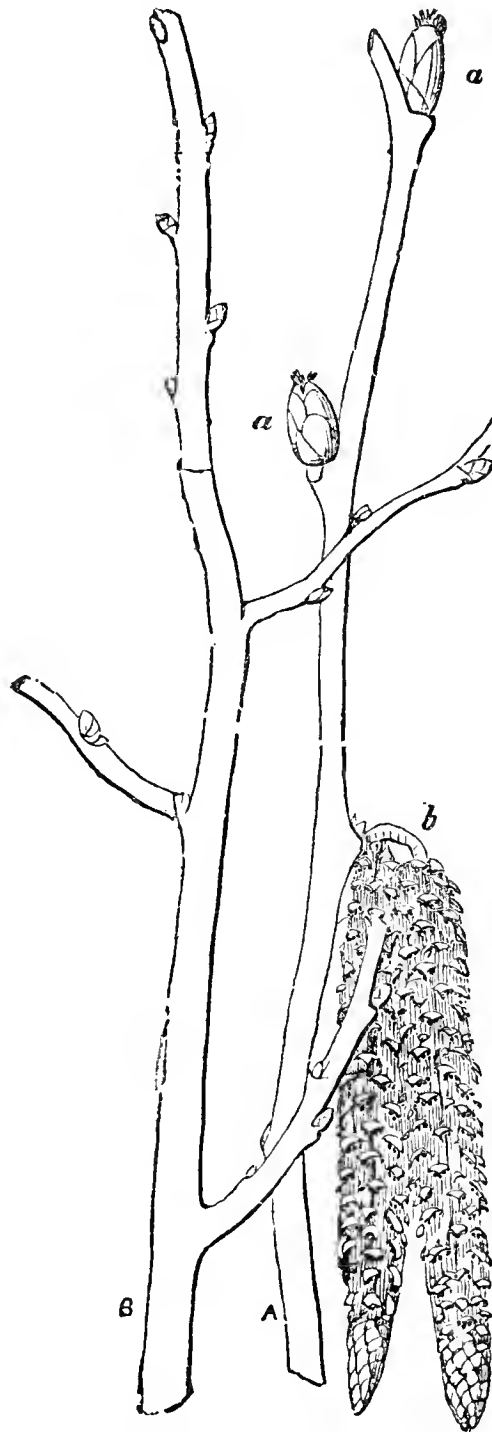

Fig. 65.—Filbert Blossoms.

gardens, 6 inches more distance between the rows and 3 inches more between the sets. The early and second early varieties are planted 4 inches deep on the level, hoed when appearing above ground, and well earthed up when sufficiently advanced. Late varieties have drills made with the plough, manure put in and spread, and sets covered with the plough 6 inches deep, scuffed when weeds appear, repeating as needed, and hoeing once or twice before earthing up, which is usually done when the tops are about 6 inches high.—GEORGE ABBEY (late of) *Grinkle Park, Loftus-in-Cleveland.*

FILBERT PRUNING.

I HAVE been interested in reading the remarks on page 202, and although I have Filbert trees I cannot find "pink" blossoms on any of them. The truth is, I do not exactly know what to look for, and consequently could not prune with such confidence as I should wish. Is it possible to make the matter more plain to an inexpe-

rienced amateur, to whom Filbert-growing is quite a new pursuit?—F. L. E., *Notts.*

[The outline engraving will be of assistance. The fruit of the Filbert is produced upon the upper part of the young shoots, and upon small branches which spring from the part at which the shoots of the preceding year were shortened. The male blossoms (catkins) are produced separately from the female ones. Fig. 65 (p. 255) A represents a shoot in which *a a* are female flowers, and *b* the males. In pruning, care must be exercised to leave a sufficient supply of these male blossoms for the purpose of fertilisation; and therefore the trees should not be pruned till early in the spring, when their development is obvious. A crop of the fruit is often lost for want of attention to this; and it has been found by experiment that where a tree has itself been deficient in the supply of catkins, cutting them from other trees and suspending them over the pink female blossoms has resulted in producing a good crop. The pruner must therefore insure an annual supply of these small productive twigs.]

PRUNING ROSES—LADY MARY FITZWILLIAM.

I HAVE been reading Mr. Moorman's interesting article on pruning Roses (March 22nd). He advises late pruning. I must confess myself rather a disciple of Mr. G. Baker of Reigate, that strenuous advocate of early pruning. The present is an excellent season for testing the two plans. The end of February was most tempting for the purpose; since then March has been coming in too much like a lion all along. All my pruning, except Teas, was finished before March began. I saw the garden of a skilful Rose-grower yesterday near here, in West Surrey, where not a plant had been touched. I shall watch with interest which of us is nearest "in" on the Rose year's central day—July 3rd, the National Rose Society's London show day. My impression is that it makes but little difference as to the flowering, and that in late pruning there is always some danger from bleeding. Even in February I found great difficulty with some excitable Manettis in cutting down to a dormant bud.

To turn to another subject. I may remark that Mr. Bennett's Roses seem the novelties of the present season, and Lady Mary Fitzwilliam one of the most desirable. The friends of Hybrid Teas will be glad to hear that they will have a chance of being shown in a class for a basket of Teas introduced by Mr. George Paul into the forthcoming National Rose schedule, and which he starts, I think, with a silver cup prize.—A. C.



At a General Meeting of the ROYAL HORTICULTURAL SOCIETY held last Tuesday, Thomas Moore, Esq., F.L.S., in the chair, the following candidates were unanimously elected Fellows—viz., John Barker, Francis Darwin, M.D., F.R.S., William Wickham, F.L.S. The Right Hon. Lord Aberdare, President, has nominated the following gentlemen Vice-Presidents of the Society for the ensuing year—viz., Sir Trevor Lawrence, Bart., M.P., J. H. Mangles, F.L.S., R. Hogg, LL.D., F.L.S., Wm. Haughton.

— WE are informed that the HORTICULTURAL EXHIBITION AT THE AGRICULTURAL HALL will now form part of the "Furniture Trades" Exhibition, from 23rd April to 16th May, and will represent most of the garden furniture, such as glass houses, boilers, seats, vases, mowers, rollers, &c., filling the whole of new entrance arcade, the space in the hall and galleries being entirely filled with other furniture.

— MR. H. CANNELL of Swanley states that at an Exhibition of the Société Nationale et Centrale d'Horticulture de France, held at Paris on the 22nd of March, he was awarded a first prize for plants of the NEW FUCHSIA MRS. RUNDALL, which has also been certificated by the Royal Horticultural Society at South Kensington.

— MR. J. CLARKE of Brynkinalt writes as follows on FROST AND FRUIT BLOSSOM in North Wales:—"Although we have

experienced 12°, 14°, and 18° of frost incessantly for the past fortnight, only the first-expanded blooms are killed here, and I am pleased to say they are very few. Peaches, Nectarines, Apricots, Apples, and Pears on walls and otherwise promise abundantly, and we hope with a genial spring our fruit rooms may be filled."

— MESSRS. JOHN STEWART & SONS inform us that they have dissolved partnership with their branch nursery at Fern-down, Dorsetshire, managed by their late partner, Mr. David Stewart. The nursery and seed business at Dundee and at Broughty Ferry, which has been established for over a century, will be continued by the firm.

— THE sixth annual Exhibition of the PUTNEY AND DISTRICT CHRYSANTHEMUM SOCIETY will be held at the Assembly Rooms, High Street, Putney, on Tuesday, November 13th, of the present year, when the usual liberal prizes will be offered in thirty-three classes, besides a number of special prizes for miscellaneous plants and cut flowers.

— "J. W., *Liverpool*," writes on HOT WATER AS AN INSECTICIDE:—"Last spring I read in the Journal that the best way to get rid of insects destructive to Orchids was to plunge the pots in hot water at a temperature of 120°. I was rather in doubt whether it was safe to do this, consequently tried two or three pots that I knew were pretty well full of woodlice, or, perhaps I should say, appeared so from the condition of the roots. The contents of these pots all changed, the insects were killed, and the Orchids improved. Seeing that no injury was caused to the plants, I last August plunged every Orchid I had in water heated to 120°. I have found that it has not injured one plant. *Dendrobium densiflorum* that I subjected to this treatment has now no less than forty-two spikes of bloom, and these in a few days will be fully expanded."

— WE have received many letters relative to the extreme COLDNESS OF THE WEATHER and its effects on vegetation. From Sussex a correspondent writes:—"We have it wretchedly cold here, the east wind blowing as if it were blowing its last. I wish it would! Neither man nor beast can stand out in it, and spring flowers are so nipped that they can scarcely be recognised." A letter from Scotland describes the weather as "dreadfully bad, the ground covered with snow. Vegetation, which was much too forward a month ago, has had a serious check, and Broccoli where exposed to the wind has melted down into a mass of offensiveness." "H. B., *Louth*," writes:—"The weather in Lincolnshire has been very wintry for over a fortnight, with heavy falls of snow, wind, and severe frosts. Much damage has been done by the latter in the garden, where a large extent of plants, such as Wallflowers especially, &c., has been irretrievably ruined. Pear trees, which a fortnight ago were profusely covered with fruit buds in nearly an expanded condition, appear to be in a pitiable plight, the buds being browned as if scorched by fire. Apple trees are fortunately in a more backward state. Talking of Apples, we wonder the Stamford Pippin is not more spoken of, as at this time of year it cannot be surpassed for flavour."

— A CORRESPONDENT, "J. L.," writes to us as follows on the CARDIFF CASTLE CUCUMBER:—"When the seed of this valuable all-the-year-round Cucumber was first distributed by one of the leading Edinburgh firms some doubts were expressed as to its being a new variety. I can endorse all that has been said of its value. Last autumn, when passing through a busy market in the midlands, I heard a grower recommending it to his friends. Holding up some of the finest samples I ever saw, he shouted, 'Cardiff Castle Cucumber: grow no other: pays grower and seller better than any other variety in cultivation.' On looking through your advertising columns we find Carter's Cardiff Castle Cucumber and Pettigrew's Cardiff Castle Cucumber. I have

ordered the latter variety; others I know have ordered the former. But as there is a great difference in the price should like to know if they are distinct or identical." [Messrs. Carter state on p. 17 of their "Vadc Mecum" that they "this year purchased the entire stock of this Cucumber from Mr. Pettigrew, the raiser." The one they offer is thus acknowledged to be Pettigrew's Cardiff Castle. It does not follow that others have not grown the same variety and saved seed from it last year.]

— A MEETING of the ROYAL BOTANIC SOCIETY was held on Saturday last at the Gardens, Regent's Park, Mr. W. F. Lord in the chair. Upon the table were specimens of seaweeds preserved in glass jars from the Society's museum. The Secretary, in the course of some remarks upon them, said that, having last summer collected some seaweeds for the museum, it struck him whether it might not be possible to procure them in a living state and grow them in the garden. Upon making inquiries he found that hitherto little or nothing had been done in that direction, it having been generally regarded as impossible. After sundry experiments he had succeeded, specimens of various kinds collected last autumn being at present in what might be called a fairly flourishing condition, growing and fruiting freely in the greenhouse set apart for them in the Garden.

— A CORRESPONDENT, E. F. Behrens, writes:—"All may not know that the TURNIP-ROOTED CELERY, called by the Germans "Knollen Celerie," besides being used for flavouring soups, &c., makes an exquisite salad, which is of the greatest value to the housekeeper during the winter and early spring. The method of cultivation is to sow in March in well-manured ground; in May transplant into rows 4 feet apart, with 2 feet between the plants, pinching the tips off the roots and leaves. Well water and hoe during summer, and when the root is the size of an Apple remove the earth and side shoots and cover up again. In October lift, clearing off the roots and outer leaves, retaining only the centre leaves. Bury the ball trimmed of roots in sand in a cellar or deep trenches to keep from all frost until required for use. For use well wash the balls, put unpeeled in a large pan of cold water and boil for two hours. Allow them to get cold with the peel on, to preserve their whiteness. Peeled, finely sliced, mixed with pepper, salt, three spoonfuls of olive oil to one and a half of vinegar, makes a dainty dish to set before a king 'or an epicure.'"

— "ONE of the best warm greenhouse plants we have for flowering at this time of year is," writes a correspondent, "IMANTOPHYLLUM MINIATUM. Well-established plants invariably throw up several strong flower scapes, and these keep fresh and attractive for many weeks. Anybody can grow it, and it very seldom requires repotting. Ours have not been disturbed for three years, and they are in perfect health and extremely floriferous. They are never dried off in any way—in fact remain constantly on the end of a stage in an intermediate house; and at no time are they unsightly, as the foliage if stiff and erect is yet of a rich attractive green, this being maintained with the help of an occasional supply of liquid manure. There appear to be several forms of the variety, some having thin and pale reddish-yellow-coloured blooms, others, as with us, much richer in colour, and occasionally a still better form is to be met with. The best we have yet seen, if we except Mr. B. Williams' variety, were flowering freely in the houses connected with Messrs. Garraway's Durdham Down Nurseries, Bristol. The scape of flowers in this case are large and compact, and the individual flowers shorter, more round, and of a rich orange-red colour. The stock is being rapidly increased by division, and ought gradually to replace the inferior forms now being generally grown."

— A BEDFORDSHIRE correspondent writes relative to the SEVERITY OF THE WEATHER IN MARCH:—"On the morning of the 24th inst. we registered 14° of frost, and at Southall Park 21°

were registered at 4 feet from the ground. For several nights we have registered from 7° to 9°. The penetrating east winds had done much to mellow stiff and soddened soils, which made gardeners unusually busy sowing small seeds, &c.; but as I now write (Easter Monday) the outlook is a cold one, and presents a midwinter scene. The ground is covered with upwards of 3 inches of snow; this fell in the short space of rather more than an hour. The trees and shrubs are enveloped in snow to the same thickness as the ground. Luckily the wind has fallen, or much damage would have been done to evergreen shrubs and trees owing to the great weight of snow. Apricots on walls covered with hexagon netting have been much blackened by the frosts, and fears are entertained that the crop will be lost. Peaches and Nectarines are now in full bloom, and being a little later hopes are entertained that they will fare better than the Apricots. Currants and Gooseberries are in a backward state, which we hope are still safe. On the 27th the thermometer registered 18° below freezing."

— THE usual monthly meeting of the METEOROLOGICAL SOCIETY was held on Wednesday evening, 21st inst., at the Institution of Civil Engineers, Mr. J. K. Laughton, F.R.G.S., President, in the chair. The following gentlemen were elected Fellows of the Society—viz., Mr. G. T. Hawley, Dr. C. W. Siemens, F.R.S., Mr. C. Walford, F.S.S., and Col. H. G. Young. Dr. W. Köppen was elected an honorary member. The paper read was "Notes on a March to the Hills of Beloochistan in North-West India, in the Months of May to August, 1859, with Remarks on the Simoom and on Dust Storms," by Dr. H. Cook, F.R.G.S., F.M.S. These months may be considered as the summer of the hill country of Beloochistan, though the natives expect the weather to change soon after the fall of rain, which takes place about the end of July and beginning of August. Compared with that of the plains the climate is delightful. The actual heat is greater than in England, especially the intensity of the sun's rays, but the weather is less variable. Fruits and crops, as a rule, ripen earlier and are not exposed to the vicissitudes of the English climate. The atmosphere is clear and pure, the air dry and bracing. The simoom occurs usually during the hot months of June and July. It is sudden in its attack, and is sometimes preceded by a cold current of air. It takes place at night as well as by day, and it burns up or destroys the vitality of animal and vegetable existence. It is attended by a well-marked sulphurous odour, and is described as being like the blast of a furnace. Dr. Cook believes it to be a very concentrated form of ozone, generated in the atmosphere by some intensely marked electrical condition.

— AFTER the reading of Dr. Cook's paper the Fellows inspected the EXHIBITION OF METEOROLOGICAL INSTRUMENTS for travellers, and of such new instruments as had been constructed since the last exhibition. In addition to the ordinary instruments designed for travellers—viz., barometers, thermometers, hygrometrical apparatus, compasses, artificial horizons, &c., some very interesting historical instruments used by celebrated travellers and explorers were exhibited, including those used by Dr. Livingstone in his last journey, by Commander Cameron during his journey across Africa, by Sir J. C. Ross in his antarctic expedition, by Sir E. Sabine in his arctic voyage, &c.

HOME-GROWN LILY OF THE VALLEY.

THOSE who have not experimented with home-prepared Lily of the Valley for early forcing would do well to give the system a trial. I do not so much advocate the system on account of cheapness as for the much better results obtainable from home-grown plants. Not that the commercial side of the question is unworthy attention, for, were only a very limited quantity flowered at one time, if the season be prolonged from Christmas till the end of April the expenditure helps to swell the yearly amount somewhat; and

where the supply required is large the outlay annually is serious. A dozen plants do not make much appearance, especially where they are required for cutting from as well as looking at, and the retail price ranges from 15s. to 30s. per dozen, and we know from experience that those costing the largest sum are the cheapest in the end, consequently the commercial aspect demands consideration to some extent. We obtain quite as good spikes from home-grown plants, with these important advantages—they are easier to force, and early in the season we obtain good foliage as well as good spikes; besides, we obtain much finer masses of bloom. Two dozen spikes from an imported clump is the largest number obtained. Last January I counted the number in an 8-inch pot (home-grown roots), and found over six dozen good spikes.

Presuming that a batch of healthy plants are either in flower or just over, instead of turning these into the rubbish heap introduce them into a structure where they can have a temperature of 55° to 60°. In May turn them out of doors, taking precautions to shelter them from cold winds and frost. At the end of that month or the beginning of June select a sheltered position, open, though not exposed to hot sunshine, and plunge the pots to their rims amongst coal ashes, introducing a small pot under each to stand them on, so that freedom from stagnant water is assured, at the same time the visits of worms are hindered.

Though dryness at the root is extremely prejudicial they do not require to be kept more than moderately moist throughout the summer and autumn months. We have had the crowns perfectly ripened in July. In any case the crowns should be plump by the beginning of September at the latest. This condition of ripeness will be better understood when it is explained that on opening a ripened crown the spike and leaf will be found so far perfected as merely to require the necessary amount of moisture and heat for full development. I have tried drying the plants after the foliage has commenced decaying. I cannot say that any difference was noticeable in any way when the plants were forced from those which had been kept moist. The smallest-sized pots we employ are those 7 inches in diameter. These are suitable for imported clumps the first season; some of the largest may require 8-inch pots. The soil we use is a strong loam enriched with dried cow dung finely pulverised. Ample drainage is necessary, as the plants do well in the same pot for a couple of seasons. With the aid of liquid manure and surface dressings they would do well for a longer period, but the plants invariably outgrow the pots they are in, so that it is impossible to water them, consequently repotting becomes an absolute necessity.—R. T.

CHRYSANTHEMUM CULTURE.

I wish to thank "A Grower and Exhibitor" for his able article on the culture of the Chrysanthemum. I had hoped there would have been more discussion on some of my questions, which was really one of my objects of inquiry. I thought it might bring some hints respecting the different liquid manures and their merits, the ripening of the wood, and the culture of Japanese varieties. With me the Japanese require more heat than the Incurved at the time of opening their flowers, and liquid manure while the flowers are opening, which, if given to the Incurved, would cause the flowers to reflex. I also find they are more easily overpotted, or are not potted quite soon enough. Which is it?

As regards the "ripening of the wood," the cultural directions as given by many are, that plants should be grown from the cutting to the flowering period without a check, and as soon as they have filled their flowering pots with roots watered regularly with liquid manure. There are several of the varieties when kept growing in this way that will not show their buds until October, which is too late for exhibitions, and some of those which do show their bloom buds come deformed, and are useless. I find such sorts do better when placed in their flowering pots the first week in June, and I do not give them any liquid manure until they show their buds, then top-dress the soil and supply liquid manure liberally. This is what I mean by ripening the wood, and upon which I sought the opinion of others.

I consider the election a success, a boon to all, especially to beginners. The "too-much-alike" varieties, I think, require very hard pruning.—J. L.

PLANTS AND WEATHER CHANGES.—We all have heard of or seen movements of birds and animals at the approach of changes of weather. I have a notion that some of the larger plants have movements in the position of their foliage that show that they also feel when different atmospheric changes are about to take place. For instance, a *Colocasia esculenta*, the leaves of which last year in a half-bushel pot, measured 4 feet 6 inches by 3 feet 6 inches, is now, after having been placed in half of an eighteen-gallon barrel, throwing fresh leaves. At any alteration in barometrical pressure I noticed

differences in position of the last-developing leaves—i.e., expanding leaves. Will others notice and observe whether these are all fancies of mine or realities? 1, Whether direction of wind can be foretold; 2, Whether downfall of rain can be portended by plants.—INQUIRER.

CLIMBERS OR ROOF-COVERING PLANTS.

RHODOCHITON VOLUBILE.

THE attractive Mexican plant, of which a spray is represented in the woodcut, fig. 66, is one of the most distinct and striking of all climbers suitable for greenhouses and conservatories, as its flowers are rich and peculiar in colour, while they are produced in great profusion. One of the chief characters of the flowers is the coloured calyx, which is large, flat, spreading, five-lobed, and bright pink, the corolla being long tubular, also with five lobes, but smaller and more oblong than those of the calyx; and the colour is a very striking contrast, being a rich deep purple, which is sometimes so intense that it is almost black. These flowers are produced singly on long slender twisting peduncles, and the flowers hang in dense clusters from the branches. When trained to the roof these are seen to the best advantage, and this is the only way in which this plant should be grown. A moderately rich compost of turfy loam, well-decayed manure, leaf soil, and sand suit it well, and it should be preferably planted out in a small border. It requires little care, except thinning the shoots and removing those that are straggling or weak. It was introduced from Mexico early in the present century, and is said to have been first grown in Mrs. Marryatt's garden at Wimbledon, now the property of Sir Henry Peek, Bart.

WHY WE VENTILATE.

PRIOR to writing on the subject of ventilation, I have waited in the hope that "J. J.'s" remarks on page 22 would have elicited replies from one or more scientific readers of the Journal. Scientific I cannot by any means claim to be, at the same time I seldom if ever give haphazard advice, and as a rule can explain myself more fully if the necessity for so doing arises. "J. J." evidently considers I err in insisting on the importance of giving air on all favourable occasions, though he admits I am in goodly company. Against the practice, however, he quotes Mr. Taylor, also the practice of growing Cucumbers in houses without ventilators, and unfolds a "harrowing tale" anent his own unfortunate experience with a batch of *Phalænopsis*.

With regard to the quotation from Mr. Taylor's writings on Grape-growing, the context should convince an impartial reader that Mr. Taylor had in his "mind's eye" the immense vinery under his charge, where during the growing season of the Vinos in all probability it is "unnecessary to open the ventilators merely for an interchange of air," but it does not follow he would apply this dictum to all houses of all forms and at all seasons of the year. If I am mistaken in this I hope he will "follow on the other side"—that is to say, in opposition to myself. The "express" method of growing Cucumbers is practised, unless I am much mistaken, during the spring and summer months, and it is almost needless to state under totally different circumstances with regard to heat and light than is the case when winter Cucumbers are being grown. It may be advisable to push on Cucumbers as rapidly as possible, but the less growth many other more valuable plants make during the winter months the better. The more robust they are maintained without actual damage by cold winds the more certain are they to grow healthily and vigorously at the right time.

"J. J." evidently considers he scores a point in favour of little or no ventilation when he mentioned his misfortune with the *Phalænopsis*. He, by his own showing, bought his experience at a high price, and I only trust he will not go to the other extreme, or he may meet with other disasters. Doubtless the stereotyped directions with regard to giving Orchids "plenty of atmospheric moisture with abundance of air" greatly misled in this case. If, however, the different writers who gave them, and others, had written at greater length upon this and other subjects, and were, in fact, to go into details every week, advising as to when air should or should not be given, and in what quantities, the periodicals must either have been enlarged or less variety be included. The probability is, not one of the competent men who advise upon Orchid culture ever contemplated the contingency of a batch of *Phalænopsis* or any other Orchid newly imported, or otherwise, being exposed to a freezing wind. In the matter of air-giving, as in all other cases, judgment is required to be exercised by the novice as well as the expert, and this probably "J. J." will now admit.

"Ventilate on all favourable occasions" is my favourite rule both in practice and when advising; but when a cold and perhaps easterly wind prevails this would be considered the reverse of favourable,

and no air would be given unless necessitated by strong sunshine. To prevent burning, I should shade where blinds are available, or give as little air as possible. Neither am I an advocate of fixed temperatures, especially high ones, during the night time, believing this to be only an invention to worry the life of the under gardeners. We certainly prefer to see the temperatures of the different houses near a certain height, but if they happen to be either a trifle higher or lower occasionally no notice is taken, because no ill effects result. I hold we should ventilate when the external conditions are

favourable, and, unless "J. J." admits fresh air to his house judiciously, I am afraid his Orchids will not equal his expectations.

We are informed by "C. P. P." (page 66) that "hot water pipes secure a constant circulation of air," but much as I respect the esteemed writer, I cannot believe he resorts to no other method of ventilation. No doubt when the pipes are first heated the radiation is rapid and far-reaching, but I feel certain the area thus affected gradually lessens according as everything becomes much warmer. Besides, if there is no egress for the rarified air this must collect at

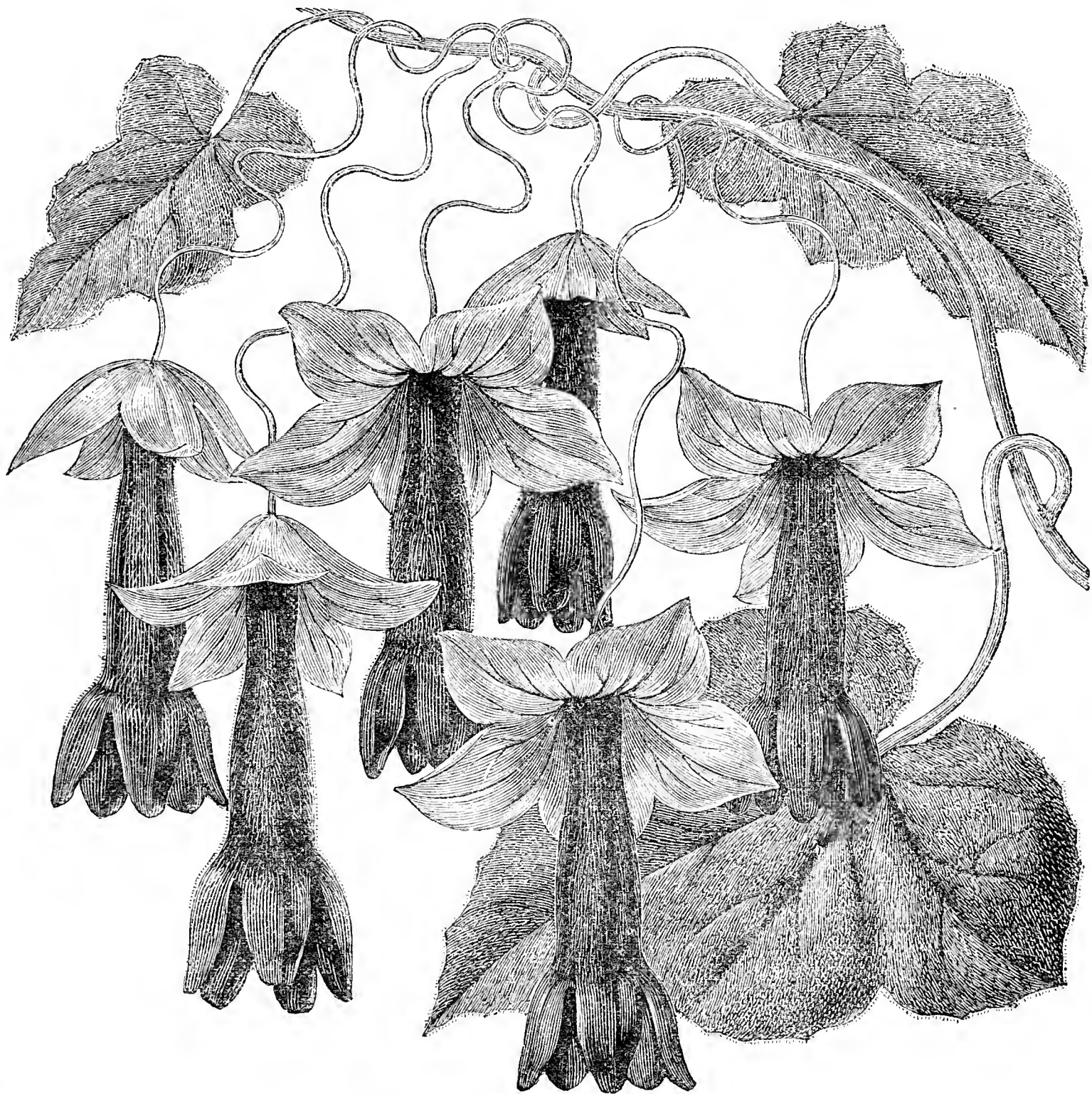

Fig. 66.—RHODOCHITON VOLUBILE. (See page 258.)

the highest point and stagnation gradually result. The slightest opening of the top lights of a house quickly effects a change in the atmosphere. This I submit is beneficial, and it is an easy matter on a still day to accomplish without lowering the temperature one degree.—W. IGGULDEN.

FREESIA REFRACTA ALBA.—I have tried this and *F. r. Leitchlini*, both indoors and planted out, but have not succeeded with them to my satisfaction—at least, not so well as some of my correspondents. A lady in Sligo ("M. R. P."), who has been more fortunate in her pot culture for greenhouse decoration, writes to-day—"On one of my plants there are now three flowers open, and about six more to ex-

pand. The form is most elegant and showy, and the perfume a delicate Auricula scent." Would some growers tell us of their system of growth?—W. J. M., *Clonmel*.

PELARGONIUMS IN WINTER.

It is hardly necessary at the present day to apologise for referring to Pelargoniums as winter-flowering plants. Since the late Dr. Denny called attention to the beauty of some of his seedlings ten or a dozen years ago their cultivation for flowering in winter has increased in a wonderful manner. The point of the greatest importance for winter-flowering is the selection

of the right varieties for that purpose. These need not be very numerous, indeed the more rigorous the selection the larger may be expected the return in bloom. I find it much better to grow from one to three dozen plants, each of a few good sorts, than to increase the number of kinds. The following have been well proved as extra free-flowering and fine in other respects:—White Vesuvius; Aida, blush, extra fine; Remus, white with red eye, fine; Lizard, salmon shaded, fine; Helen, fine salmon and white; Louisa, light rose, very floriferous; Lady Sheffield, Mrs. Leavers, Lady Bailley, and Olive Carr, all extra fine pink shades; Earl Manvers, Col. Sceley, and Charles Schwind, shades of crimson; De Lesseps, Lady Stanhope, E. Davies, Lizzie Brooks, shades of scarlet; and Hettie, a plum shade.

The next most important matter to having the right varieties is to have a proper structure in which to grow the plants. The best of the kind I have seen was a roughly built lean-to pit, having the sashes moveable and with a flow and return 4-inch pipe for heating. The plants were placed on coal ashes and were within a few inches of the glass. Whatever the kind of structure, light is one of the chief requirements. A temperature to keep the plants growing healthily is also necessary, as, unless a continued growth of foliage and stem is secured, the supply of trusses must soon come to an end. It may be noted here that there is little if any difficulty in obtaining flowers up to Christmas. It is between that time and the beginning of March that any weakness in the treatment is betrayed by an absence of flowers. I have found a temperature of 55° to 60° secure a continued state of floriferousness right through the winter.

Having disposed of these points I will now note the modes of propagation and the summer treatment of the plants. They may now be propagated at any convenient time. We like to have the cuttings rooted, so that when they are transferred into 4-inch pots they may be at once placed in a cold frame. What I consider the best mode of propagation is to place each cutting singly in the smallest sized thimble pot. The compost employed for the cuttings consists of half sand, half soil. No drainage is required. The pots are placed several dozens together on the potting bench, and the compost placed in them with a spade; the cuttings are then inserted and the soil made firm. They are placed in a stove quite close to the glass, a minimum temperature of 65° being allowed them. Water is given as they require it, and in from ten days to a fortnight root-action has commenced. They may also be rooted quite readily in boxes, using about an inch in depth of the same compost. The quickest mode of all is to dibble the cuttings into the sand in a propagating house. After the plants are all rooted they should be removed to a cooler house, just keeping them growing.

In April they are transferred into 4-inch pots, the compost preferred being a friable loam, not turfy, a fourth part of cow manure being added. A few coal cinders are employed for drainage. The compost is rammed down quite hard, a slow sturdy growth being needed. We have a frame about 3 feet in depth for growing the plants in during the summer months, and in this they are at once arranged. They require little water until the weather becomes warmer. In June the points are taken out of the young growths, and that is all the pinching they receive or require. In July the plants are shifted into 6-inch pots in which they flower, the same compost being used, and the manner of potting being the same as with the first shift. The plants are returned to the frame again, some being placed behind hothouses when we have too many for our frame to hold. It has been recommended to place them out in the sun throughout the summer months, the object being to render the growth firm and stout. I have tried various plans, and would much prefer to have a structure set apart for the plants the whole year round. Next to that my plants do much better under the shelter of the deep-sided frame set apart for them. They never fail to flower, and the foliage keeps a healthy green hue which exposed plants never have.

It is not well to be late in housing the plants, as a few cold nights will cause the greater portion of the foliage to fall after going into warmer quarters. The last week in September may, therefore, be taken as the latest time they should be standing out. Besides the points already treated of at the beginning of these notes there are only three matters requiring referring to in their winter treatment. The first is to allow the plants plenty of room. It will be found better to throw any inferior plants away during the winter than to allow the whole collection to be overcrowded.

The next point refers to watering. This, of course, is a question greatly resting on local circumstances. For instance, plants standing in a low pit on coal ashes will not require half as much water as plants standing on an open wooden trellis in a larger structure. This, however, may be noted, that the necessary tem-

perature required to keep the same plants in a healthy and floriferous condition throughout the winter and early spring months, also requires that a sufficient supply of water be regularly forthcoming. I do not believe in dryness for a growing plant. The plant is certain to break down at some point; even if it flowers it will affect the size of the trusses and pips. The last point is the question of manure. Our plants are regularly supplied with a stimulant about once a fortnight. Sulphate of ammonia or nitrate of soda are not suitable, a little of the former which we gave our stock last year threw the plants out of bloom for a week or two. Standen's manure is the safest and best.—R. P. BROTHERSTON.

ROYAL HORTICULTURAL SOCIETY.

MARCH 27TH.

THE first promenade Show of the season was held in the conservatory, the Council-room being now occupied by the Fisheries Exhibition Committee. As usual at these early shows bulbs formed the great feature of the display, Hyacinths being particularly well represented, the large collections from Messrs. Veitch, Williams, and Cutbush occupying a large portion of the space. Several other handsome groups also contributed to the beauty of the Show, not the least pleasing being Messrs. Pauls' Roses and Mr. James' Cinerarias.

FRUIT COMMITTEE.—Philip Crowley, Esq., in the chair. The following members were also present:—Messrs. G. H. Goldsmith, Sidney Ford, G. Paul, C. Silverlock, J. Burnett, J. Woodbridge, J. Smith, W. Denning, and Thomas Laxton. Mr. J. Hudson, gardener to H. J. Atkinson, Esq., Gunnersbury House, Acton, sent six bunches of Lady Downe's Grapes extremely well kept, fairly coloured, and the bunches very even. A cultural commendation was awarded for these Grapes. Mr. J. Summers, The Gardens, Sandbeck Park, Rotherham, was awarded a cultural commendation for a box of La Grosse Sucrée Strawberries large and well ripened. Mr. S. Ford, gardener to W. E. Hubbard, Esq., Leonardslee, Horsham, exhibited a collection of about forty dishes of Apples and Pears, the former comprising some well-kept fruits of Norfolk Beefing, Round Winter Nonesuch, Mère de Ménage, Coronation Pippin, Blenheim Pippin, Scarlet Pearmain, and Redstreak. The Pears were Uvedale's St. Germain's, and Bcurré Berckmans. A cultural commendation and vote of thanks were awarded for this collection.

FLORAL COMMITTEE.—Shirley Hibberd, Esq., in the chair. The following members were also present:—Rev. G. Henslow, and Messrs. T. Moore, J. Laing, H. Bennett, James Cutbush, H. Cannell, H. Ridley, W. Bealby, J. Duffield, H. Ballantine, J. Dominy, James Hudson, H. Turner, J. James, and M. T. Masters. Messrs. H. Cannell & Son, Swanley, sent plants of a Zonal Pelargonium named Edith George, a variety with a very large truss of bright pink flowers, and a basket of the double Cineraria Sir Drummond Wolff, Miss Simpson, and Hernia. A vote of thanks was accorded to Mr. Woodbridge, The Gardens, Syon House, Brentford, for some fine trusses of the fragrant *Pancreatum-like Hymenocallis macrostephana*.

Messrs. J. Veitch & Sons, Chelsea, staged a magnificent collection of Hyacinths, comprising nearly 250 plants, and representing all the best of the varieties in commerce, together with a number of novelties. The plants were in excellent condition, the spikes very massive, the bells large, and the colours clean, bright, and rich. They were also tastefully arranged, the colours being carefully contrasted or harmonised. Of the new varieties the following were the most noteworthy in addition to the certificated varieties which are described at the end of the report. *Empress of India*, single, very dense spike, warm crimson, small bells; *Safrano*, single, pale yellow, compact spike, large and distinct; *Mauve Queen*, single, purplish mauve, the margins of the petals lighter, spike compact, of moderate size; *Balsamæflora*, double, flowers very large and full, white tinged with pink; *L'Obscurité*, single, very dark blue, almost black, neat spike; *Passe Incomparable*, single, very rich rosy red, extremely bright; *Actrice*, double, blooms very large, pale pink, loose spike. Amongst the older varieties the following were the best, taking the single forms first. *Blue and Black*: Lord Byron, Charles Dickens, King of the Blues, Grand Lilas, Queen of Blues, Porcelain de Sevres, Tricolor, Sultan, Grand Bleu, Pienneman, Blondin, Masterpiece, and General Havelock. *Red and Pink*: Von Schiller, King of Reds, Macaulay, Prince Albert Victor, Princess Alexandra, Princess Clotilde, Annie Lisle, Queen of Hyacinths, and Countess of Rosebery. *White*: Mont Blanc, L'Innocence, Grandeur à Merveille, La Franchise, Snowball, Baroness Van Tuyl, and La Grandesse. *Yellow*: Queen of Yellows, Bird of Paradise, Ida, Marchioness of Lorne, King of Yellows, and Jonquillon. The best doubles were Princess Louise, rosy red; Van Speyk, pale blue, very large bells; Susannah Maria, pale rose; Lord Wellington, creamy white; Von Siebold, pale blue; and Koh-i-noor, pale red. A collection of new Amaryllises and greenhouse Rhododendrons was also shown by Messrs. Veitch; all these were very fine, and certificates were awarded for several, which are described below. A silver-gilt Banksian medal was awarded for these groups.

Mr. B. S. Williams, Upper Holloway, contributed extensive and beautiful collections of Hyacinths, Tulips, Lilies of the Valley, and Cyclamens, all of great merit. The Hyacinths in particular were remarkably fine, the spikes massive and the colours rich. About

150 plants of these were shown, even and vigorous. About fifty Tulips were contributed also of good quality, the Cyclamens being notable for the great size of their flowers. A silver Banksian medal was adjudged to Mr. Williams for this collection.

Messrs. J. Carter & Co., Holborn, exhibited a large collection of Cinerarias of their "Brilliant Prize" strain, the plants being dwarf and bearing richly coloured flowers of many distinct shades. Four baskets of Primulas, comprising specimens of all the chief Holborn varieties, were also contributed, the group being backed up with a row of Deutzias and Dielytras. A bronze Banksian medal was awarded.

Messrs. Paul & Son, Cheshunt, exhibited a large and handsome group of Roses in pots, of sizes varying from 6 to 12 inches or more in diameter. The plants were all very healthy, the blooms abundant, bright, and of good substance. Such well-known varieties as Madame Thérèse Levet, Madame Victor Verdier, Duke of Teck, Annie Laxton, Marie Rady, Souvenir d'Elise, and La France were represented by fine plants, smaller specimens being staged of the neat Polyantha Roses Mignonette and Margueritta, the former pale pink and the latter white, the flowers being small but borne in dense clusters. A silver-gilt Banksian medal was adjudged to Messrs. Paul & Son.

Messrs. Collins Bros. & Gabriel, Waterloo Road, London, had a very bright collection of the scarlet *Anemone fulgens* flowers in neat glasses. Purple, white, and crimson varieties of the new Victoria Giant type were also represented by a number of flowers very prettily arranged. Mr. J. James, Woodside, Farnham Royal, Slough, contributed a group of Cinerarias extremely varied in colours, the flowers of great size and admirable form, and for which a bronze Banksian medal was awarded.

Messrs. Cutbush & Son, Highgate, exhibited a beautiful group of Hyacinths and Tulips, about 120 of the former and fifty of the latter. The Hyacinths were distinguished by their fine spikes and large bells, all the leading varieties being represented. The Tulips also were of very good quality, the flowers large, and the colours rich. A bronze medal was awarded. From the Society's garden at Chiswick several groups of Azaleas, Lachenalias, Primulas, and Begonia manicata.

Several prizes were offered by an amateur for Amaryllises, but the competition was not very keen, Mr. Little gaining nearly all the prizes, being first and second for the best seedling with The Ameer and Queen Mab; first and second for the best light variety with Iolanthe and Comet. He also gained the same position for the best dark variety with Princess Dagmar and Dr. Masters. These four with Mdle. Titiens and Coronet also were placed first as the best Amaryllises. Messrs. Paul & Son were third with a seedling Amaryllis named Mrs. Hird.

Messrs. Sutton & Sons, Reading, offered prizes for nine seedling Cinerarias, single varieties, but only one collection was staged, for which the third prize was awarded to Mr. H. Little, Hillingden Place, Uxbridge.

First-class certificates were awarded for the following plants:—

Amaryllis Lady of the Lake (Veitch).—Flower of excellent form; petals broad, rounded, white, with a few rose spots.

Amaryllis Wordsworth (Veitch).—Flower neat, rounded; petals very bright scarlet, veined with darker shade.

Amaryllis Byron (Veitch).—Flowers of moderate size, five in a head, but remarkably rich in colour—a deep warm crimson, quite distinct, and scarcely equalled in richness by any other variety.

Amaryllis Tennyson (Veitch).—A very handsome variety, with flowers of enormous size, 7 or 8 inches in diameter; the petals proportionately broad, and bright scarlet in colour. The plant shown was bearing a massive spike, over 3 feet high, with four grand flowers.

Hyacinth Pink Perfection (Veitch).—A single variety with spikes of great size and excellent form, the bells very large, the petals spreading, white suffused with a delicate pale pink. An exceedingly handsome variety.

Hyacinth Souvenir de J. H. Veen (Veitch).—A single variety, rich dark blue; bells of moderate size, in a very dense compact well-formed spike.

Rhododendron Triumphans (Veitch).—A striking variety, bright scarlet, rounded petals, wax-like in texture and appearance.

Cineraria Princess of Wales (James).—Flowers nearly 3 inches in diameter; petals very broad, rich purple-crimson.

Cineraria Mr. Herrin (James).—Intensely deep, rich maroon; flower of moderate size but beautiful in form.

Cineraria Duke of Edinburgh (James).—Flower 2½ inches across, rich purple-blue; petals broad with a white ring in the centre.

Anthurium ferriense.—A hybrid between *Anthurium ornatum* and *A. Andreanum*, raised by Mr. Bergman, gardener to Baron A. de Rothschild, Ferriers en Brie, France. Foliage very much in the way of *A. ornatum*, the spathe being 5 inches long and about 4 broad, ovate in form, and not puckered like *A. Andreanum*, of a rich cherry-red colour; the spadix white.

Angræum articulatum (Williams).—Flowers about an inch in diameter, white and wax-like, with spurs 3 or 4 inches long, and borne in a short raceme.

Rose Mignonette (Paul & Son).—A pretty little Rose of the Polyantha type, with pale pink flowers, produced in clusters similar to Margueritta, but rather larger. It is dwarf, free, and graceful.

Rose William Francis Bennett (H. Bennett).—A Pedigree Tea variety of a purplish crimson colour, very bright in the bud, which is neatly

formed, and well adapted for buttonholes or bouquets. They are extremely fragrant.

SCIENTIFIC COMMITTEE.—Sir J. D. Hooker, K.C.S.I., in the chair.

Sclerotia of Peronospora infestans.—Mr. W. G. Smith called attention to the fact that the so-called "sclerotia" described in a paper by Mr. A. Wilson, read at the last meeting, were observed and figured by Von Martius so long ago as 1842 (Die Kartoffel epidemic), and by Berkeley in his paper on the Potato murrain in the first volume of the Horticultural Society's Journal. They were subsequently figured by Broome in 1875, and Professor Buckman. Mr. G. Murray said that from his examination they often seemed to consist of the discoloured and disorganised contents of the cells which they completely filled, though in Martius' drawing two or three were in one cell. Dr. Masters, however, noticed that they were often *outside* the cells, and of an angular character, as if they had not assumed the form of the interior of the cell. The question was raised whether they might not have been expressed by the covering glass. Martius figured them with coniferous threads proceeding abundantly from them. Further investigation of their true nature was thought desirable.

Abutilon and Hibiscus "bigener".—Dr. Masters described a very dark-flowered Abutilon, which was said to be due to an original cross between *Hibiscus rosa-sinensis* and *Abutilon striatum*. The original plant was a dark-flowered seedling which was fertilised by Mr. George for two or three generations with the pollen of the *Hibiscus*, and though the character of the flower is that of Abutilon it has the truncated column and foliage of *Hibiscus*, thus showing distinctly intermediate characters. In one plant the leaves were marked with a dark crimson spot. Hence it appears to be a true bigener, or cross between two distinct genera.

Ivy-leaved Pelargonium Cross.—Mr. George sent some foliage of a cross between the Ivy-leaved and a rough-leaved Pelargonium. Several showed a reversion to the peltate type, some assuming a funnel-shaped or other irregular form, thus betraying its origin from *P. peltatum*.

Orange Trees attacked by Mytilaspis Citricola.—Mr. MacLachlan exhibited leaves and branches of Oranges much injured by this insect from the Bahamas. He read a communication by Messrs. Dunlop and Roker, communicated by the Governor to the British Government, requesting information. The insect was therein named *Aspidites Gloverii*. He made some remarks on the method of attack by the insect, and suggestions as to remedies to suppress it.

Solanum species.—Sir J. D. Hooker read a communication from Mr. Lemmon of Oakland, California, upon the discovery of three species or varieties of *Solanum*, bearing tubers, from the borderland of Arizona and Mexico. "We found them first," writes the author, "on the cool northern slopes of the high peaks [of the Huachuca range]; then afterwards, where least expected, invading the few rudely cultivated gardens of the lower foot-hills. One kind is called *S. Jamesii*. This has white flowers and tubers. Another was *S. Fendleri*, Gr. It has smaller purple flowers and flesh-coloured tubers. This, Dr. Gray lately concludes to be but a variety of the old Peruvian Potato, and he calls it *S. tuberosum* var. *boreale*. The third form or species, found at 10,000 feet altitude, has mostly single orbicular leaves, one or two berries only to the umbel, and small pink tubers on long stalks, growing in loose leaf mould of cool northern forested slopes. I have great faith in the successful raising of one of these species (or varieties) to a useful size, for the following reasons: 1, While the *S. tuberosum* var. *boreale* bears long stolons and but a few tubers, the other kind, *S. Jamesii*, makes many short stolons terminated by four to eight large round white tubers. 2, While the first kind has been partially tried and then given up, the latter species is known to have become enlarged to the size of hen's eggs during the accidental cultivation of three years in the embanking of a rude fishpond."

THE CHRYSANTHEMUM ELECTION.

TOO-MUCH-ALIKE VARIETIES.

I NOTE at page 177 of the *Journal of Horticulture* the excellent remarks of Mr. Moorman on the "too-much-alike varieties," and like him am rather amused at the opinions expressed by some of the electors regarding the varieties that are supposed to be identical. As you say, no doubt this arises through their not having the varieties true to name. The election must prove an advantage to all, particularly to those now forming collections, of which there are many.

I was rather surprised to find that some varieties, Cherub for instance, did not obtain more first-class votes. The reason I think is not far to seek; many growers fail to obtain good blooms of that variety, and thus it loses a place in the first class. It is a telling flower in a stand when in its proper form.

Princess of Wales and Mrs. Heales I hold are quite distinct when properly grown. The petals of the Princess have a deep pink shade, whereas those of Mrs. Heales are a light creamy white. I know that under some conditions they are very nearly alike, particularly when the blooms of the Princess are fading; they then lose that rich shade of colour which renders them so attrac-

tive. I contend that of all the varieties of Incurved Chrysanthemums Princess of Wales is the best; it is one that is most to be depended upon to produce fine blooms, and has an excellent habit of growth.

Inner Temple I have not yet made out as a distinct variety. In my opinion it is Refulgence under a new name, which name never ought to have been given. Some catalogues describe it as synonymous with Arigena; if so that is a very poor recommendation, as I have not yet seen anything approaching a good bloom of that variety, nor do I think anyone else has. With me it has always produced flowers, the petals of which remind of the bristles on the back of a hedgehog.

Mrs. Parnell is the same as Mrs. G. Rundle in all respects except size the former grows large, and I consider it the better of the two. Golden Queen I never thought good enough to grow; it is much too coarse in the petal. It differs from Emily Dale in the petals being not so broad, and not so well incurved. Baron Beust and Orange Perfection are distinct enough for twelve if necessary. The former is a first-class variety, not nearly sufficiently grown, as it is of such easy growth. Orange Perfection has a brighter hue of colour, and does not show the golden tips as in the case of Baron Beust.

Nonpareil, though an old variety, introduced, I believe, in 1846, is desirable, colour deep lilac; the flower is of good form with perfectly incurved petals. Much has lately been said in favour of Beverley or White Beverley, as it may be. I fail to see its good qualities as set forth by some. It is not large, the petals are too erect, the habit of the plant is not good, being too weak to carry a fair-sized bloom without so much support. There are plenty of white kinds far superior. These remarks apply to Golden Beverley also.

I am not at all surprised that Jardin des Plantes attained so high a position in the election. I own the form is not good in all hands, but the colour is very rich, and good plants are pretty sure of producing fair blooms under ordinary treatment. It was sure to be pounced upon for a first place. I named Mr. Bunn in preference to it for the first twelve.

Should the election of the Incurved varieties be followed by one of Japanese the results will be rather surprising, I fancy, as to some varieties. Much more progress has been made with the introduction of new varieties in that section than the Incurved. Many new kinds are much superior to the older ones, and are not so well generally known, therefore electors will have more difficulty in naming all the first twelve.—E. MOLYNEUX, *Swanmore Park*.

MR. HIBBERD'S LECTURE ON THE AMARYLLIS.

AT the meeting of the Royal Horticultural Society on Tuesday, March 27th, Mr. Shirley Hibberd gave a lecture on the Amaryllis. The occasion was made the more interesting by the exhibition of collections of these beautiful flowers, in some cases not for competition, in others for the prizes offered by an amateur desirous of encouraging the production of hybrid Amaryllis of high floral quality.

Mr. Hibberd said the name of the flower suggested that its history should begin somewhere in the 106th Olympiad; or, say some three hundred years before the Christian era, in order to bring the country girl, Amaryllis herself, to furnish the subject of the opening chapter. But there is nothing to be gained for our present purpose from the pleasant verses of Theocritus or the later lines of Virgil, for neither of these poets gives aught beyond the name, and, as a matter of fact, Amaryllis does not anywhere in classic poetry rise to the dignity of a heroine. But it is one of the glories of the Linnæan nomenclature that by means of symbols selected from imperishable Nature we are brought into contact with the sweet stories of old, the flower of to-day taking us to the very fountain-head of pastoral poetry—the idylls of the poet of Syracuse.

The Amaryllis in some form was known long before the time of Linnæus, for John Gerarde had the one now known as *Sternbergia lutea*, which he figures at page 113 as *Narcissus autumnalis major*. John Parkinson had this same plant, and figured it at page 75 of the "Paradisus," and he had another which he figured at page 71 as *Narcissus indicus*, the Indian Daffodil, with a red flower. This became known as the *Jacobæa Lily*, and was figured in the "Botanical Magazine" (t. 47) as *Amaryllis formosissima*. This *Jacobæa Lily* is now catalogued as *Sprekelia formosissima*, having been so named by the German botanist Heister in honour of Dr. Sprekel, and not, as is generally supposed, by Dean Herbert, who, however, adopted it and thereby sanctioned it. The plant has been of late years met with in Guatemala, but its native habitat was long unknown. It appears to have been introduced to Spain before the year 1593, in which year, according to Linnæus, it began to be known generally in Europe.

Linnæus classed as Amaryllis a number of plants that have since been separated under other generic designations. But he made considerable progress nevertheless towards a clear definition, preparing the way thereby for the labours of Dean Herbert half a century subsequently. This good churchman devoted to these plants an immensity of labour in determining distinctive characters, raising

hybrids, and reducing to order all the Amaryllids known in his time. The first publication of his views occurred in the "Botanical Magazine" in the year 1820, under the description of *Amaryllis reticulata* (t. 2, 113). These views were illustrated in a remarkable manner in a paper on "The Production of Hybrid Vegetables," published in "The Transactions of the Horticultural Society" in the year 1822. In a treatise on the order published subsequently he developed a complete system of classification, one result of which was to give to Amaryllis *Belladonna*, otherwise known as the *Belladonna Lily* of the Cape of Good Hope, the sole honour of representing the classic beauty Amaryllis. The South American plants that are nearest allied to the *Belladonna* were classed under *Hippeastrum*, this generic designation being in reality adopted from Linnæus, who at least supplied the idea. It is necessary here to be explicit. In the "Paradisus Batavus" of Paul Herrman, published 1698, is a description of a plant called *Lilium americanum puniceo*, the Red American Lily. This plant Linnæus named *Amaryllis equestris* and it is so entered in the "Hortus Kewensis," and under the same name is figured in the "Botanical Magazine" of the year 1795 (t. 305) and the "Botanical Register," 1817 (t. 234). The flower of this species is somewhat irregular in form, and the spathes of two leaves stand up like a pair of ears, and thus, according to story No. 1, the specific name *equestris* refers to a fancied resemblance of the flowers to the head of a horse. But story No. 2 alters the case. In a description of the lovely *Amaryllis reticulata*, by Dr. Sims, in the "Botanical Magazine" of the year 1803 (t. 657), the learned editor says, "We take this opportunity of correcting a mistake of the late Mr. Curtis, in saying that Linnæus gave the name *equestris* to the Amaryllis referred to as such. The fact is, this name was given from the remarkable likeness the front view of it has to a star of some of the orders of knighthood." Thus the Hon. and Rev. William Herbert followed out the suggestion of Linnæus when he made a bold separation between the Amaryllis of Africa and those of America, renaming the western group *Hippeastrum*, the Equestrian Star, the justification for which will be found at page 144 *et seq.* of his treatise on the Amaryllidaceæ. The distinction is not geographical merely, but is founded on minute details of structure and the order of the leafing.

It is proper here to say that to Dean Herbert we are not solely indebted for scientific knowledge of the Amaryllis. Of the labours of the professional botanists it is not needful to speak in a special manner, because we must refer to them again and again in the treatment of a subject of this kind. But at this point I feel bound to mention that, concurrently with the study of these plants by Dean Herbert, they were collected and cultivated with spirit and discretion by Mr. Griffin of South Lambeth, to whom the "Botanical Register" was often indebted for figures of the more characteristic species. Mr. Ker named the pseudo-genus *Griffinia* in honour of this gentleman.

In a few of the references cited it will have been noticed that the Amaryllis has been at one time designated a *Narcissus*, and at another time a *Lily*, and again the compound term *Lilio-narcissus* has been used. The distinction between a true Amaryllis and a true *Lily* rests on the position of the ovary. For the casual observer—or say, for a visitor to the flower show—there are some obvious distinctions that will be found of service. The *Lilies* have leafy flower stems without spathes; the Amaryllis have naked flower stems, and the flowers spring from a spathe such as Parkinson would describe as a "skinny husk." But these distinctions have no scientific value, as the orders are at present defined, for the exceptions would not prove the rule; they would destroy it.

To give an account of the several species would needlessly prolong this discourse. But a certain number must be referred to because of their importance as cultivated plants. One of the earliest and most distinct is

Amaryllis Reginae, which was flowered by Fairchild of Hoxton in the year 1728. A folio pamphlet containing a history of the plant was written by James Douglas, who named it *Lilium Reginae*. Its first appearance in the "Botanical Magazine" occurred in the year 1799. The flower has a short funnel and a capacious limb, the colour is crimson, and the star is fully displayed.

A. vittata was first figured in the "Botanical Magazine" in 1788 (t. 128). The flower is always smallish, with a decided funnel, and the petals are elegantly striped, and the progeny, even at two or three removes, partakes of this character.

A. reticulata was introduced in 1777 by Dr. E. W. Gray, and was figured in the "Botanical Magazine" in the year 1803 (t. 657). It is of the most elegant form, approximating to that of a *Convolvulus*. The tube of moderate length, the limb delicately reticulated in shades of rich lively rose.

A. equestris dates from 1710. It is a fine flower of medium size, with short funnel, the limb crimson or scarlet, displaying a bold green star. A variety of this, named *major*, grown by Mr. Griffin, and figured in the "Botanical Register" of 1817 (t. 234), very strikingly resembles some modern hybrids of *A. pardina*, and in place of a green star it has a bold white centre, the outer portions of the limb being of a fiery vermilion colour.

The more celebrated *A. aulica* was first figured in the "Botanical Register" in 1820 (t. 444). It was imported from Brazil by Mr. Griffin, and flowered with him at South Lambeth for the first time in December, 1819. In this the elements of a crown are perceptible, and the leafage is peculiar. The form of the flower is far away from what would be termed the florist type, the petals being narrow and

separated. But in a variety named *platypetala*, obtained from the Organ mountains by Mr. Harrison of Aigburgh, near Liverpool, about the year 1825, the most splendid floral characters are developed. The colour of this variety is rich deep crimson with a bold green star that is sometimes prolonged to the extremities of the divisions, which are short, smooth, and so broad as to overlap and form a noble flower.

All the foregoing, and many more that I cannot stay to mention, have been registered as *Amaryllis*. But in the year 1822 the characters of *Hippeastrum* were set forth by Dean Herbert, and the new designation was adopted in the "Botanical Magazine" in the year 1825, when there appeared a figure of *Hippeastrum solandriflorum* (t. 2573). Some others appeared under the new generic name, as for example *H. ambiguum* and *H. breviflorum* in 1837.

Now, in the history of the flower it is proper to record another episode. In the "Botanical Magazine" it was an *Amaryllis* for a period of about thirty-five years. Then it became a *Hippeastrum* for a period of forty-five years. But in describing a splendid species discovered in Peru by Messrs. Veitch & Sons' collector, Mr. Pearce, in June, 1867, Sir J. D. Hooker named it *Amaryllis pardina*. Having done so, he felt bound to justify the proceeding, and he did so by saying that the differences recognised by Herbert were so slight and variable as to be of no practical value. Therefore the original generic designation was restored; Linnæus triumphed, and *Amaryllis* is herself again.

The introduction of *A. pardina* opens a new chapter in the history of this flower. Its name implies that it is spotted like the leopard, but that quality is not much valued by the florists. It is of more importance to say that this flower is distinguished by great breadth of petal and the absence of a funnel, a fact favourable to the expansion of the flowers to a symmetrical face. More than any of its race introduced up to the year 1867, *A. pardina* stirred the blood of the florists and gave new zest to the labours of the hybridists, who, however, soon discovered that, with all its fine qualities, it is not the model for breeding from that they would themselves have created had they been permitted to assist in the work of the third day as recorded in the Book of Genesis. But the model was ready for all that; like many other desirable things, it was made with the rest on the third day and remained to be discovered. This was secured in Peru by Mr. Pearce. It appears that the King of the Belgians, one of the most generous and enlightened patrons of horticulture in this flowery world, admired the flower when it was shown at South Kensington in the year 1869, and it was named in honour of his visit *Amaryllis Leopoldi*. It is as truly the king of the *Amaryllis* as *Lilium auratum* is the queen of the Lilies. It possesses all the elements of a perfect florists' flower in breadth of petal, depth of colour, a sharply defined star, and petals superbly tipped with white or an approximation thereto. It is sufficiently defective as a florists' flower to afford work for the hybridist and excitement to the critics, and to give peculiar interest to the splendid series of varieties that chiefly by its aid have been raised by Messrs. Veitch & Sons of Chelsea. The hybrids figured in the year 1865 in Van Houtte's "Flore des Serres" were, in a way, wonders of their time; but we have got far beyond the flowers with funnels and indefinite green stains, and look for expanded flowers of the most perfect symmetry both of form and colour, and with novel markings to give the charm of variety to collections.

At this point it seems proper to remark that in cross-breeding plants varieties occasionally occur that have the individuality, the vigour, and the power of determining the characters of future generations that we associate with species. For all that we know to the contrary they are species, and although brought about by human agency, have nevertheless been brought about in Nature's way, and with none but Nature's materials. Some such we have in an *Amaryllis* called *Acramanni pulcherrima*, raised by Messrs. Garraway of Bristol, in 1850, from *A. aulica platypetala* and *A. Johnsoni*. This *Acramanni pulcherrima* is a narrowish flower of fine quality, the colour rich deep crimson with a subdued green star. It has the potentiality of a species for the purposes of the raiser, and has influenced the hybrids immensely. One of the finest varieties in which we see the influence of this plant is that named *Dr. Masters*, in which there is scarcely a trace of green, while the form and colouring are delightful.

When we get amongst the varieties, however, it begins to be time to cease talking; therefore it seems proper to devote the last chapter of this discourse to the general subject of the varieties. And the great question in connection with that general subject is, By what rules are we to judge the hybrids? for a code of properties is very much needed. From the point of view of the critical florist the funnel is objectionable, but happily that is pretty well got rid of. The shorter the flower the more complete, generally speaking, is its expansion, and, above all things, expansion is requisite to the display of the colour. Now let us, as severe critics, find as many faults as possible with the hybrid *Amaryllis*. The funnel is objectionable, even in its present severe limitation. The petals are unequal, and the front petal especially needs to be remodelled. For our present purpose we may regard all the divisions of the perianth as petals, although we might with propriety call the three outer divisions sepals, and the three inner divisions petals. The length of the lowest of the three is noticeable as a fault in all the varieties. Another fault is the green colour that so frequently occurs, but occasionally this assumes a

beautiful form, and therefore I think it would be a mistake to condemn the green colour *in toto*. It will in due time change to white, and a soft creamy white would probably tell with great power if symmetrically associated with high crimson colour. In a good form of *A. Leopoldi* we see a well-defined star, and the petals are tipped with white. A self-coloured flower should be pure throughout, but we may recognise a star of good form and marginal colour corresponding, and thus we may have self-coloured flowers, starred or striped flowers, and tipped flowers. As a matter of fact we have all these already, but the persistency of the green colour is a common blemish.

A great point in the new race is the growth of leaves and flowers concurrently. This is an immense gain, and we must make it a point of importance in estimating the merits of a variety. It is likely, too, that as the plant learns to produce leaves and flowers simultaneously, it will also learn that the green star in the flower is no longer needed, and thus improvement of the leafage will operate to the advantage of the flower, and we shall obtain the white, and perhaps the yellow star, that seems to be so much needed for the attainment of perfection.

It may be properly urged that there are many beautiful species and varieties that are far removed from the properties thus suggested as desirable. It is no part of my business to condemn any of them; rather I would say, Let us rejoice at the infinite variety of Nature, and feast upon beauty that is as yet "unadorned," and therefore is "adorned the most." We have but to do with these as with other flowers. All the Roses and Pelargoniums and Azaleas that are at once beautiful and useful, and yet wanting in the properties that constitute floral perfection, are classed as "decorative," and are judged as such. These we hand over to the gardeners and the world at large. But all the ugly and useless flowers that Nature appears to have produced for her own private enjoyment we hand over to the botanists, and those learned people appear to appreciate our generosity. We say of such things, "Take them upstairs," and they forthwith go to delight the philosophers who dwell in our upper room. There are many beautiful species and varieties of *Amaryllis* that must for ever stand apart from the group that we judge as florists' flowers, and these cannot be disparaged by the operation within a certain circle of laws that have the sanction of experience, because consistent with the aims of Nature and the demands of common sense. The florists are sometimes regarded as a narrow-minded lot. But it will be found that their minds are broad enough to enable them to select for their own enjoyment the most beautiful flowers, and, if other people prefer the kinds that they reject, they are generous enough to leave them to the free exercise of their choice.

REVIEW OF BOOK.

The Herefordshire Pomona, Containing Coloured Figures and Descriptions of the Most Esteemed Kinds of Apples and Pears Cultivated in Great Britain. Edited by ROBERT HOGG, LL.D., F.L.S. Part V. London: Journal of Horticulture Office, 171, Fleet Street, London, E.C.

THE history, or, more correctly speaking, the literary description, of any branch of science, must in time come to an end; but the illustrations of that science are continuous, and where Nature is concerned, as in fruits, unending. Thus in former parts of "The Herefordshire Pomona" we have had papers on "The Early History of the Apple and Pear: Thomas Andrew Knight and his work in the Orchard," "Modern Apple Lore," "A Sketch of the Life of Lord Scudamore," a paper "On the Cordon System of Growing Pears," "The Crab: its Characteristics and Associations," and "The Orchard and its Products: Cider and Perry." All this history and quotations from all sources, here a line of poetry, there prose stories, and wonderfully wide reading have the writers shown; but all is now over—end it must, and end it is. But there were in every one of the four previously issued parts coloured portraits, or pictures drawn from the life, of chosen specimens of Apples and Pears. These are now continued in this part, and of these it entirely consists. History of cider-making must end, theory and practice of fermentation are done with, the orchard in its commercial aspect has been written of and is over, but how many parts of a "Pomona" would it take to insert pictures and descriptions of fruits worthy to be pictured and described? But though "of the making of books there is no end," yet of the making of a book of one kind there must naturally be an end, and the gorgeous "Herefordshire Pomona" is drawing to a close, for only two more parts are to be issued.

Of Part v., now under review, we have first a description and portrait of the Old Golden Pippin, so old that possibly these are the very Apples of which Shakespeare speaks when he makes Evans say, "I will make an end of my dinner, there's Pippins and cheese to come." Or they might have been stewed Pippins. Of this Apple there is a far and wide-spread notion, descending from the mistake of T. A. Knight, that it is now in the last stage of decay. I can only say that each year, or nearly so, I grow in

my own garden here in Wiltshire Old Golden Pippins as good as they possibly can be in shape, appearance of skin, and also in size and flavour. There is one point in Golden Pippins which they share with the Summer Golden Pippin—viz., niceness of shape, and these two in pleasingness of form excel to my mind every other Apple. There are no offensive ribs, and no squattiness, as in some Apples. The portraits—for there are three Golden Pippins represented on a branch—are among the best.

Plate ii. of this part represents five Pears, the most noticeable being Chaumontel (would England were warm enough to grow it well!) and Napoleon, of which a most accurate portrait is given. This is a Pear which is more juicy than rich in flavour, and is now excelled by many November Pears. The next plate (xxxix.) is of Apples—Red Hawthornden, which beautiful fruit we owe to Richard Smith & Co.; Sleeping Beauty, a Lincolnshire Apple; Schoolmaster; The Queen, once called The Claimant, a name judiciously dropped; Gravenstein, which I can thoroughly recommend for the southern and western counties at least, and Rymer. Plate xi. is of Pears, and though most of them are neither of particularly pleasing shape or colour, are well done, and an improvement upon those in Part iv. The larger of the two British Queens is an instance of this.

Plate xli. is one of Apples—Barcelona Pearmain, handsome and useful; Scarlet Nonpareil, which ought to be on all dessert dishes at Christmas time; Margil, small but pleasant eating; Cornish Aromatic; and last of the five, Cornish Gilliflower. There is an idea even in Cornwall that this Apple is dying out, and a belief that in other parts of England it will not fruit. Both of these are mistakes. It is to be bought when wanted, and its not fruiting is owing to that pertinacious pruning of pyramids which I hope is going out of fashion. If you closely prune Cornish Gilliflower you cut away the fruit buds, as it blossoms like Irish Peach, only on the end of each shoot. It is beyond all winter Apples in distinctness of flavour, and it bears well, though not every year, perhaps, in North Wilts. The plate that follows (xlii.) is one of the best of all, witness the accuracy of two of its portraits—Bishop's Thumb and Maréchal de Cour, improperly printed here under the fruit Maréchal *dele* Cour; this Pear is among the best twenty Pears known. Bishop's Thumb is an old favourite near Bath. In the remains of the once famous orchards which existed between the Great Western Railway station and the city many a well-grown standard of Bishop's Thumb reared its fine head; and now, though the orchards are to a degree built over, yet behind some small villa you will find in its little back garden a handsome standard of this kind of Pear. In my curate days I had one outside my then residence, and hoped devoutly never to have the Bishop's thumb on me, but only on my house!

Eight cooking Apples are represented on Plate xliii.—Hoary Morning; Gooseberry Apple, which nurserymen will not send you, but in its place Gooseberry Pippin, a little eating Apple, whereas Gooseberry Apple is large and a very late keeper. N.B.—I wish nurserymen would only supply fruits true to name, and not supply another in the place of one ordered. I wish this N.B. would be particularly observed, for many of us amateurs are sufferers in this way. I have sent to distant parts of England and been so disappointed. Lemon Pippin, rightly named from its Lemon-like shape, is No. 3; Green Woodcock and Striped Monstrous Reinette follow, and then two of the very best—viz., Northern Greening and Yorkshire Greening, neither of which can be too highly praised.

A very pretty Pear plate is No. xlv., leaves and fruit being well done. The little Citron des Carmes, the richly-coloured Beurré Capiaumont, pleasant-shaped Colmar d'Ete, Beurré de l'Assomption, in regard to which the section and the portrait of the whole Pear do not at all agree, the section being very inferior in shape and size. Fondante de Cuenne, "a Pear superior in flavour to Beurré Giffard" says Dr. Hogg, which indeed it can easily be. Plate xlv. gives us some cider Apples. 1, Joeby Crab, a queer name, said to be a corruption of "jovial." When a Herefordshire labourer becomes merry from too much cider it is a rural pleasantry to say to him, "Ah! you've been in the sun, you be soon got joby," hence "Joeby" Crab makes, or is supposed to make, strong cider. Next "Cuming," another queer name, though there is a place of that name in Radnorshire.

Next follows the well-known Somersetshire cider Apple, Kingston Black, or, as it is more commonly called, Taunton Black. I have seen between Taunton and Bridgwater whole orchards of nothing but this Apple; the trees large in size and very shapely, each tree alike, and the fruit abundant, and in good years larger in size than the portrait here given. The exceedingly rich and unusual colour of the Apple is very striking, so deep a crimson on one side that there is some excuse for its being called "black." I have never seen any cider Apple so large. Next is another

Somersetshire cider Apple, the Cadbury or Royal Wilding. There are two Cadburys in Somerset, North and South, near Castle Cary, and a hill called Cadbury near Congresbury, and in that neighbourhood these Apples used to be, and perhaps are now, grown in the hedgerows. Two other Wildings fill the page, Wilding Bittersweet and Green Wilding, but neither has a history.

A plate, No. xlvi., of perry Pears naturally follows. Butt Pear and New Meadow and Parsonage, old but unhistoric. Aylton Red, Pint Pear, and Pine Pear equally without a history; while Arlingham Squash is no doubt from a village of that name in Gloucestershire near the Severn. We return in plate xlvii. to Apples Benoni, Fearn's Pippin, Trumpington, the first and last of supposed American origin, but why the last with its English name, a name of a village so well known to all Cambridge men, should be supposed to be American I can scarcely comprehend. Pearson's Plate, Ord's Apple, and Lucombe's Pine are all of undoubted English origin. These six Apples are all highly coloured though small.

Now we come to the last picture, last and one of the best. We have in it five fine Pears—Urbaniste, from Malines or Mechlin in Belgium, as also Deux Sœurs, a Pear which sprung up in the garden of two sisters, and hence received its affectionate name. De Maraise and Belle Julie, both raised by Van Mons: the latter Pear has this great recommendation, "it is a great and certain bearer." The last figured and described in this part of the "Pomona" is Jewess, raised at Malines, and fruited in 1843. It received its name from growing against a wall which bounded the street called "Rue des Juifs." Such in little is a description of the "Herefordshire Pomona." Naturally enough the letterpress is different and not quite so interesting as the former parts, but in usefulness it is not excelled by any part that has yet appeared.—

WILTSHIRE RECTOR.

ROYAL BOTANIC SOCIETY.

MARCH 28TH.

THE first spring Show of the present year was held in the conservatory and corridor at the Royal Botanic Gardens, Regent's Park, on Wednesday last, and though the exhibits were not quite so numerous as on some previous occasions, yet in the majority of cases the quality was all that could be desired. A very bright and interesting display was produced, and the arrangement was tasteful, the corridor being particularly attractive.

Bulbs.—The competition in the classes for these was not very keen, but the plants shown were generally of good quality. For twelve Hyacinths Mr. J. Douglas, gardener to F. Whitbourn, Esq., Great Gearies, Ilford, Essex, was first with handsome examples of General Havelock, Grand Lilas, Von Schiller, Lord Derby, Vuurbaak, Fabiola, Ida, Marie, La Grandesse, Koh-i-Noor, Grandeur à Merveille, and King of Blues. Mr. H. Eason, gardener to B. Noakes, Esq., Hope Cottage, North Hill, Highgate, was second with a good collection but with smaller spikes. The last-named exhibitor was also first with twelve Tulips in the amateurs' class, being closely followed by Mr. J. Douglas, who also gained the first prize for the only collection of twelve Narcissi, healthy and well flowered. Messrs. Cutbush & Sons, Highgate, had the best twelve Tulips in the nurserymen's class, Messrs. H. Williams following in that class, but taking first with twelve Hyacinths, and being followed by Messrs. W. Cutbush & Sons and R. J. Wood.

Amaryllises.—In the open class for six Amaryllises Mr. E. Baxter, gardener to W. S. Parker, Esq., White Lodge, East Barnet, won the first prize with Empress of India, The Baron, Foxhunter, Crimson King, Lizzie Brooks, and Novelty; healthy strong plants with large flowers. Mr. J. Wiggins, gardener to H. Little, Esq., Uxbridge, and Mr. R. Butler, gardener to H. H. Gibbs, Esq., St. Dunstan's, Regent's Park, were second and third respectively with good plants.

Cyclamens.—Several good collections of these were staged, the first-prize and twelves in the amateurs' and open class from Mr. Wiggins being particularly vigorous and well-flowered. Messrs. Clarke and E. Baxter followed in both classes, the former with very satisfactory specimens, healthy, and bearing very large flowers.

Mr. J. Douglas was placed first in the open classes for nine hardy Primulas and the same number of herbaceous plants, the former including plants of *Primula nivea*, *P. cashmeriana*, *P. marginata cœrulea*, and *P. rosea*; the others comprising specimens of *Pulmonaria virginica*, *Fritillaria Meleagris alba*, *Muscari botryoides*, *Sanguinaria canadensis*, and *Narcissus Princess*. Mr. G. Wheeler, gardener to Lady L. Goldsmid, St. John's Lodge, Regent's Park, for hardy plants, Solomon's Seal, Spiræas, and *Pulmonaria officinalis* being notable. Azaleas were not largely represented, and the plants generally were not so good as usual. In the amateurs' class Mr. A. Ratty, gardener to R. Thornton, Esq., The Hoo, Sydenham, was first with healthy specimens; Mr. E. Baxter second, and Mr. Wiggins third. In the nurserymen's class for six Mr. H. James, Castle Nursery, Lower Norwood, was first with very neat specimens. Messrs. H. Williams, J. Douglas, and R. J. Wood, Haverstock Hill, were the prizewinners with Lilies of the Valley, showing large potfuls bearing numerous flowers.

Messrs. H. Williams & Sons, Fortis Green, Finchley, E. Baxter, and R. Butler were the prizetakers in that order for six Chinese Primulas, but none of the plants were of remarkable merit. Mr. J. Douglas secured the first prize for the only collection of twelve pots of Crocuses—viz., fine specimens of such varieties as *Purpurea grandiflora*, *President Grant*, *Marie Stuart*, and *Golden Yellow*. For six *Deutzias* Mr. J. Douglas took the lead with the large plants that are now so well known at exhibitions, they were flowering most freely. Mr. Wiggins was second with smaller but well-flowered plants, and Mr. Eason was third.

Messrs. Paul & Son, Cheshunt, were the only exhibitors of six *Roses* in pots, and gained the chief prize with fine plants of *Edouard Morren*, *Caroline Kuster*, *Madame Victor Verdier*, *Madame Thérèse Levet*, *La France*, and *Duke of Teck*.

Miscellaneous.—The collections and groups not in competition formed the chief portion of the Show, very prominent being the superb bank of *Hyacinths* from Messrs. J. Veitch & Sons, Chelsea, for which a large silver medal was awarded. The plants were the same as those shown at Kensington on the previous day, and are noted in the report. A large silver medal was also awarded to Mr. B. S. Williams of Upper Holloway for groups of *Cyclamens*, *Hyacinths*, and *Tulips*, which were also at Kensington. A small silver medal was awarded to Messrs. J. Carter & Co., High Holborn, for a large and tasteful group of *Cinerarias*, *Deutzias*, *Dielytras*, and *Primulas*. A similar award was also granted to Mr. Wiggins for a group of well-grown *Cyclamens*, and bronze medals to Mr. H. James, Slough, for a group of handsome *Cinerarias*; and to Mr. H. Clarke, Twickenham, was awarded a bronze medal for a collection of *Cyclamens*. A small silver medal was adjudged to Mr. Anthony Waterer, Knap Hill, Surrey, for a handsome collection of hardy *Primulas* and *Polyanthuses*, with a few plants of *Andromeda japonica*. A similar award was granted to Messrs. W. Cutbush & Sons, Barnet, for an extensive collection of *Hyacinths* and *Tulips*, and to Messrs. Paul and Son for a group of *Roses*.



[By the most skilful Cultivators in the several Departments.]

KITCHEN GARDEN.

OF all the years we have practised kitchen gardening we have experienced no spring so backward as the present one, and we cannot conceal the fact that our spring vegetables are more backward and less promising than they were six weeks ago. For the past three weeks we have had frost nightly, sometimes as much as 20°, and never less than 8°. Accompanying this were some most destructive winds, which penetrated everywhere, and the consequence is that the majority of protectors of an ordinary description were useless. Potatoes sheltered under fern, branches, and leaves in the open borders were destroyed in one night; Cauliflower plants put out in shallow trenches and covered with inverted flower pots appear as if boiling water had been poured on them; Onions coming through the ground have the points of the young shoots quite withered; spring Cabbages, which gave every indication of forming large white centres by this date, are now only a drooping mass of useless leaves; spring Broccoli, which should have been in by the hundred, have no heads—in short, vegetables at the present time are a complete wreck. Hope is our only consolation, and perseverance must be our practice. Many seeds consigned to the ground immediately before the frost came are not yet showing any signs of life, yet it is hoped they are safe. Judging from all accounts this state of matters must be general, and many will be at their wit's end to know from whence to draw a supply of produce.

Whenever the weather will allow quick-growing vegetables should have the greatest attention. Spinach is one of the quickest crops to become useful, and where it is valued large quantities of seed should be sown on the first favourable opportunity. Asparagus may be expected to make rapid progress as soon as the weather is favourable. Where no other kind of manure is available soot and salt mixed together and applied at the rate of one handful to each root weekly will be productive of much good. Where Potatoes have been cut down let them have time and they may yet prove productive. Later-planted tubers which were not far enough advanced to be checked will now give the first crops. The growths of these should be protected as they are seen above ground. All seeds not yet sown should be kept in the bags until there is a certainty of their being safely used. Ground which has been occupied with late crops should be trenched or

dug and prepared for the next crop. All work which can possibly be done should be forwarded. There will be many arrears to bring up by-and-by, and these when they can be done should not be interrupted with any kind of work which might have been accomplished in the time of frost.

Under glass activity should be everywhere the rule. The majority of vineries and Peach houses have now been started into growth, and there are no better places than these in which to forward vegetables of all kinds. Gentle hotbeds, too, should be made everywhere, and with whatever material can be had for their formation. If only a few cartloads of hot manure can be procured any kind of refuse will do to increase its bulk. With the assistance of this and frames and lights young Celery plants, spring-sown Cauliflowers, Lettuce, early Brussels Sprouts, Cabbage, Radishes, and everything of the kind may be brought forward. The Radishes and Lettuces will soon become ready for use, and the other plants can be forwarded to plant out in the open when the weather becomes favourable. We have many thousands of young plants now in these positions, and these will be of the utmost use further on. Large quantities of French Beans should be sown in every available space; Tomatoes coming into bloom and swelling their fruit may have a temperature of 70° by night and 80° by day; Cucumbers will do well under the same conditions. Use the syringe on fine days to expel insects. Pot Vegetable Marrow and Egg-plants. They all require rich soil and a genial atmosphere at this time.

PLANT HOUSES.

Azaleas.—Plants that have been forced should after flowering be assisted to make their growth. A good place for them is a Peach house or vinery at work, or any position where slight shade can be given and a moist night temperature of 55° or 60° maintained. It is decidedly preferable to encourage them at this season than to subject them to hard forcing when wanted to flower during winter or early spring, which not unfrequently ends in failure. Plants that make their growth and set their flower buds early force into flower when wanted with ease and certainty, in fact unfold their blooms almost naturally as soon as heat is applied. When these plants have started fairly into growth and their roots are active potting can be done if required. Before commencing this operation see that the soil is sufficiently moist, so that no water will be needed for some days after repotting. Use clean pots and afford liberal drainage, which should be carefully placed in the pots and covered with a layer of moss. Good fibrous peat, with a liberal admixture of silver sand, is the most suitable compost for these plants. Remove the old drainage carefully, but do not disturb the remaining portion of the old ball. The new soil must be pressed firmly into the pots round it, so that water when applied will not pass through it and leave the old soil dry, which means serious injury and even death if the error be not quickly detected. If repotting is not necessary apply weak liquid manure, or, better still, give two or three applications on the surface during the season of some artificial manure purposely prepared for plants in pots. This in many instances will prove as beneficial as repotting. Keep a sharp look-out for thrips, and on the first appearance of the insects wash the plants with the solution recommended a few weeks ago.

Forced Shrubs.—*Deutzias*, *Prunuses*, and other similar plants that have ceased flowering should be cut close back and started in growth quickly. When fairly started they can be given larger pots if needed. Use for potting rich loam, with one-seventh of manure and sand. If repotting is not required employ stimulants, for the stronger their growths, provided they are ripened, the more beautiful these plants are when in flower. Cuttings of *Deutzias* strike readily in heat, and if rooted at once will the second year make valuable plants for decoration in 5-inch pots. The *Prunus* cuttings should be taken off with a small heel, or they will fail to root.

Ghent and *Mollis Azaleas*, *Rhododendrons*, and other hardy shrubs that have been forced early, should have positions in cool houses to make their growth until they can be safely placed outside. This is necessary if they are required again for forcing the following autumn and winter. If placed directly outside from the flowering house they seldom recruit themselves under two years.

Dielytras should be gradually hardened off to be finally planted outside. *Spiraea japonica* can be thrown away after flowering if a judicious system of preparation by division is practised annually to raise the required stock for forcing; if not they can be hardened, and when safe planted out for two years to recruit themselves.

Zonal Pelargoniums.—Those that bloomed in the autumn and early winter and have been kept moderately dry and at rest for

some time past can now be cut back and encouraged by more moisture and a little warmth to break into growth. The old soil can then be much reduced, and the plants placed in the same or smaller pots as they may require. Plants that discontinued flowering during the winter and have been carefully watered and kept in a temperature of 45° will, if afforded a little more heat, again flower freely in a week or two. Give these and others that have been flowering for some time weak stimulants every time watering is necessary. Young plants that were rooted in autumn and kept quiet during the winter in 3 and 4-inch pots should now be repotted, and if they are wanted to come into flower at once place them in a temperature of 50°. Those not wanted to flower should be kept cooler, and the points of the shoots pinched out. Keep them as close as possible to the glass, and admit air on all favourable occasions after the roots are working in the new soil. Pot firmly with good loam, sand, and a little manure. Insert cuttings singly in thumb pots of free-flowering varieties to grow for autumn and winter-flowering, and place them on a shelf in a temperature of 60°, where they will root readily and quickly.

THE FLOWER GARDEN AND PLEASURE GROUND.

Planting and Pruning Roses.—Where the Roses bought in during the winter are still laid in by the heels no time should be lost in properly planting them. They will be found to have formed many new fibrous roots, and care should be taken not to injure these when planting. This difficulty may be obviated by covering them with a small quantity of light soil obtained from the frame ground. The majority of dwarf Roses are worked on the Manetti stock, and in this case the union must be covered with soil, or failure will eventually result. When properly planted the budded Roses emit vigorous roots near the junction, and this in a manner becomes independent of the Manetti stock. Established dwarf and standard Roses may now be finally pruned, and the latter should be well secured to stakes, as they seldom thrive if allowed to twist and blow about. When pruning cut away all very weakly growths, thin out those retained if crowded, and in the case of standards it may be necessary to regulate the heads by shortening back some of the main branches to a good inner growth. Strong growths on standards may be left 12 inches long. Moderate-sized shoots—say the size round of a lead-pencil—may be cut back to the third or fourth bud, and others in proportions, giving the preference to those outwardly disposed. Dwarfs are most apt to develop extra strong shoots, and as hard pruning only aggravates the evil these are best slightly shortened and firmly pegged down. In this way they will flower freely, and the weaker growths will be strengthened. The following season they should be cut clean away, and be replaced by other vigorous growths should there be any formed. We treat all alike, shaping our course more with regard to the growth of the individual plant rather than the section to which it may happen to belong, and find we rarely make a mistake.

THE BEE-KEEPER.

UN-GET-AT-ABLE HIVES.

MR. PETTIGREW concludes that we used the above term as applicable to straw skeps "only as a figure of speech," and not as a word really conveying our "own sober thoughts," and that we must know that "hives un-get-at-able are unknown in the apian world."

When speaking of straw hives as un-get-at-able we used the word comparatively, and we still hold that the skep compared with the bar-frame hive is un-get-at-able. If we attempted to read carefully and thoroughly the pages of a book, or we will say of this Journal, before using a paper knife, we may manage with much trouble, certainly to make ourselves cognisant of much of its contents, but we could not succeed at all to our satisfaction. It would be un-get-at-able. Its pages must be cut and opened one by one in order that they may be comfortably digested. The uncut book or Journal is the skep, the bar-frame hive has its pages cut, and every wonderful lesson spelt out on those pages is fully exposed to the reader so plainly that we might say, "He who runs can read them." As we of the bar-frame school have been always willing to admit, the skep has its advantages. These have over and over again been dilated on. We should like to have a hive made of the same material—straw, which could be so arranged that every comb could be separated from its neighbours, and one by one be lifted out either for examination or for other of the many purposes for which

the combs are employed in the bar-frame apiary. But at present we find that our book must have a wooden binding, and therefore we must do our best to protect the binding from the action of the weather. But to return to Mr. Pettigrew's letter. We have endeavoured, at least in one point of view, to show that the word he complains of is not other than accurate, and not misleading. Mr. Pettigrew is a veteran bee-keeper, and, doubtless, he can remember men who fifty years ago were well informed in the mysteries of bee-keeping; but he cannot surely convince either himself or the readers of this Journal that during those fifty years, while all other sciences have been rapidly developing, the science of bee-keeping has been at a standstill.

Large harvests of honey were, and now are, obtained from the straw skep. This we admit, but it was, and is, obtained in a far less inviting form, either in or out of the comb, than that taken from the bar-frame hive. Let anyone compare the best straw super of comb honey, or bellglass filled over the straw skep, with the beautiful piles of 1 lb. or 2 lb. sections now seen at all our bee shows; or let him compare the method of slicing up combs and straining the honey through sieves to the employment of the honey extractor, and say which honey or which method he would prefer.

It is needless for us to compare the two kinds of hives when required for queen-raising. Mr. Pettigrew says he finds no difficulty in breeding queens, and in extracting queens as they arrive at maturity; but can his large skeps be divided and subdivided as the bar-frame hive can to form nuclei, or nurseries for the various young queens where their fertilisation and breeding powers can be ascertained, and whence they can be given to any hive where and when needed? Again, we know how easy it is to turn up a skep for examination, and by carefully getting it into one particular position so that the sun shines evenly between the combs its condition may be fairly scrutinised. But on a dull day there is not so much light thrown on the subject. We hardly know whether this is a truism or a pun. We only hope that the next time Mr. Pettigrew has an examination of a bar-frame hive made before him he will notice how much easier it is to see a comb and its occupants and contents when held up to broad daylight, than it is to examine any particular comb in a well-populated skep.

Mr. Pettigrew has seen harvests of honey taken from straw hives which would please and astonish us and other modern bee-keepers. We already have proved that such harvests of honey are obtainable. In the year 1876 we had a straw skep which gave us over 140 lbs. of surplus honey, but it was in large supers, and had to be cut up before retailed. A London firm gave 10d. per lb. for it, and it was a fair price too. Half the quantity in neat sections would now sell for nearly an equal sum. We do not for a moment doubt that similar or even larger harvests will be obtained from bar-frame hives, as they have already yielded such results to the gratification of their owners. *Experientia docet*, and the fifty years' experience which Mr. Pettigrew has had enables him to prognosticate a good honey season. We must all agree in hoping that the anticipation may be realised, and that all bee-keepers when they make up their accounts at the close of this year may have a large balance in their favour.

Although we advocate the use of the bar-frame hive as the hive of the day, we do not for a moment wish to disparage the skep. If cottagers and others who still continue its use would get the surplus honey made over it into a more saleable form, it would be greatly to their interest. A tray of sections worked on the top to which the bees have access through a piece of excluder zinc would be of nearly double the value of the same weight of honey stored in glasses or straw caps. The excluder zinc should be fastened over a hole cut in the top of the skep (where a feeding hole has not been left in it when made), and the perforations should be five-twenty-fourths of an inch in diameter. The zinc is known as No. 12 in the trade.—P. H. P.

BRITISH BEE-KEEPERS' ASSOCIATION.

THE usual monthly meeting of the Committee was held at 105, Jermyn Street, on the 14th inst., Mr. T. W. Cowan in the chair. The minutes of the last meeting having been read, confirmed, and signed, it was resolved that the Association's annual Exhibition be held on Thursday, Friday, Saturday, and Monday, July 5th, 6th, 7th, and 9th. The Hon. Secretary announced that the Duke of Wellington had kindly granted the use of his riding school at Knightsbridge for the purpose of the annual Show.

The Honey Market Committee presented their report, recommending the appointment of a honey salesman, and suggesting that a suitable place should be provided where samples of honey might be sent. Pending the appointment of a honey salesman Mr. Stewart undertook to receive samples of honey and to make arrangements for its sale. It was resolved that Mr. Stewart be empowered to incur the necessary expense in advertising, &c., for the extension of the honey market.

The question of providing suitable rooms for the Association's business was discussed at some length. It was the general opinion of the meeting that suitable rooms for the holding of meetings, for a bee-keepers' club, and for the reception and sale of honey should be obtained. It was resolved that inquiries should be made for such rooms, and that advertisements should be inserted in the daily papers.

The Honorary Secretary reported that he had been unable to obtain a grant for the purpose of holding an exhibition of bees, hives, honey, &c., in connection with the Bath and West of England Agricultural Show at Bridgwater. It was resolved that the Secretary be empowered to visit Bridgwater and endeavour to secure a site for the holding of an exhibition of bees, hives, honey, &c., at the time of the Bath and West of England Agricultural Show, and that in the event of his being successful the following do constitute a special committee for the management of this Show—viz., Mr. A. H. Martin, Worcestershire; Rev. J. G. Dangar and W. N. Griffin, Devon; Mr. W. H. Dunman, Dorset; Mr. C. Kent, Cornwall; Mr. C. Tite, Somerset; Rev. W. E. Burkitt, Wilts; Rev. J. Cooke, Gloucestershire; Rev. J. E. Sale, Hereford; Mr. L. O. Lewis, Carmarthenshire; Miss Swinton, Brecon.

TRADE CATALOGUES RECEIVED.

A. G. Dawson, Alma Buildings, Macclesfield.—*Catalogue of Improved Bee Hives and Bee-keepers' Appliances.*

James Cocker & Sons, Aberdeen.—*Catalogue of Florists' Flowers for 1883.*



* * All correspondence should be directed either to "The Editor" or to "The Publisher." Letters addressed to Dr. Hogg or members of the staff often remain unopened unavoidably. We request that no one will write privately to any of our correspondents, as doing so subjects them to unjustifiable trouble and expense.

Auricula Seed (*T. T. Weston and Others*).—The Auricula seed that we undertook to distribute for the benefit of a sick gardener was all disposed of within a week of the announcement being made, and if there had been twice as much it would all have gone in the same short period of time. "Single-handed" has no more seed for disposal.

Lawn Sand (*C.*).—We have not been informed of the composition of Watson's or Fowler's lawn sand, and scarcely expect to have the particulars supplied to us. The sand can be readily purchased from vendors of horticultural requisites. We do not know of anything else of a similar nature for destroying weeds on lawns.

Honeydew on Camellias (*J. W.*).—As we stated in answer to a correspondent last week, this is caused by insects. If you look carefully over your plants you will find that they are infested with either aphides or scale, both of which will cause the sticky appearance on the stems and branches of which you complain. The latter will most probably be the cause, as at this season of the year the scale will have commenced activity. If you have climbers or plants near your Camellias that are infested with insects, the honeydew may have fallen from them. Syringe the plants with a solution of petroleum, thoroughly mixing 4 ozs. of the oil in 4 gallons of water. If your plants have made much young tender foliage use half an ounce less of the oil to a gallon of water.

Gardenia Buds Deformed (*W. J.*).—Your plants are evidently healthy from the appearance of the shoot sent. We have noticed on several occasions buds deformed the same as yours when they have been produced from the small side shoots in early spring, but not to the same extent as they appear to have done upon your plants. A check when the buds are in an embryo state, arising from the soil being kept too wet, causing torpidity of the roots, is sure to result in deformity, especially if the plants are kept in a high temperature, and thus their top growth is forced too rapidly for the sluggish roots to support the flowers. This is the most probable cause of the failure in your case, but using paraffin too strong when the buds are small and tender always prevents the development of the flowers.

Books and Reading (*J. S.*).—You have not the slightest idea of the magnitude and cost of production of such a work as you propose. According to your programme it would be the most voluminous and costly work in the language, and, so far from its preparation being "easy," it would be extremely difficult. However competent the "few men" might be, the work of editing would be no ordinary task. The question is one that must be closely and carefully considered by experts, as public discussion would be of no benefit whatever. If all those who practise gardening were as commendably earnest as you are such a work might be undertaken with a fair prospect of success; but we are compelled to say that the great majority are more or less apathetic in matters of this kind. You will perhaps be surprised to learn that half the works on gardening that have been published of late years have not defrayed the cost of production, and those who have produced them have lost more than their labour. It is true that not a few of the books are, as you say, of a trashy character. You propose something better, and your suggestion shall be well considered by those who are competent to discuss a matter of such importance.

Fungus in Greenhouse (*A Louth Subscriber*).—We are not surprised to hear that "the action seems very peculiar" in the "soil and manure." The material is not in a fit condition for any greenhouse in its present rank and offensive state; it is swarming with eggs, insects, and worms, and with the

numerous fungi peculiar to fresh dung and refuse. Such undecayed wet stuff acts as a direct poison on plants, and supplies the eggs and seeds of the worst plant parasites. The black-spotted Pelargonium leaves which you describe as covered with small "ergots, really very beautiful to look upon"—so thickly spotted, indeed, that one of our staff took them at first sight to be had examples of an ally of the Hollyhock disease—have been examined by Mr. W. G. Smith, who describes them as the sporangia of a dung-borne fungus named *Pilobolus roridus*. This fungus is extremely common on rank dung; it is called *Pilobolus* because it has a habit of elastically ejecting its sporidia in the air, and roridus from the appearance of the tops of the fertile fungus threads, which resemble dewdrops. A sporangium is a spore case or little flask containing the seeds of the fungus. They are shot through the air in *Pilobolus* as an aid towards perpetuating the species. You say you are "alarmed at the present aspect of things," and the "ergots" have "spread over the whole of the place, living and dead alike." Your own comments show better than anything we can say the improper condition of the soil and manure inside your greenhouse.

Removing Tendrils on Young Vines (*E. D., Worcester*).—We do not consider it a good plan to pinch off the tendrils from the leading growths of young Vines so closely as is practised by many persons. We remember once noticing some thousands of remarkably fine Vines in pots in Mr. Rivers' nursery at Sawbridgeworth. The pots were standing on the hot-water pipes, and the growths trained about 18 inches apart up the roof above. The grower of these Vines was justly proud of his work. They bristled with tendrils, some of them a foot long and nearly as thick as quills. From a few of the Vines, however, the tendrils had been pinched off closely with the object of noting the effect. Only a dozen or so were so treated, and in every instance they were weaker than the others, which led the cultivator to remark: "Depend upon it if you want the Vines to grow strong and well you must let them put out their horns."

Pruning Peach Trees (*A Swedish Subscriber*).—It is difficult to give advice in a case of this kind without knowing anything about the condition of the trees. A safe course for you to pursue would be to rub off any growths from the shoots that have cast their flower buds, except one or two of the most promising at the base of each, and when these have grown 5 or 6 inches the useless portions can be cut out. You will thus avoid overcrowding the trees with a number of weak shoots, and at the same time not incite gumming by pruning too soon. It is essential that the growths of the present year be very thinly disposed, in order that every leaf shall be exposed to light and air, otherwise the shoots will not assume a fruitful character, and the flowers will fall again next year. Remove as much of the barren wood as is necessary to insure full exposure to the growths succeeding and no more.

Pits and Frames (*R. S.*).—It is not easy to answer your question categorically, as so much depends on the nature of the crops you desire to cultivate and the time they are required for use, also on the means provided for affording heat. We can only say, that as a rule when the heat is imparted by hot-water pipes brick pits are preferable to wooden frames, but when only fermenting materials are afforded moveable frames are usually the most convenient. We think it a pity you removed the pits, whether they were heated by hot water or not, as they are so valuable for other purposes than early forcing, and a frame or two in addition to them would have probably cost less than the amount incurred in the alterations. We have both brick pits and wooden frames, and scarcely know which we could spare the best, as both are about equally useful.

Frozen Fruit Blossom (*B. G., Hants*).—The circumstance of your "not understanding our statement that fruit blossom will expand after the organs of fructification have been destroyed" does not alter the fact. We have examined fruit blossoms too closely to make any mistake on the point. There are, we fear, millions of flower buds of early-blossoming Pear trees apparently sound and fresh, but dead at the core. The peduncle and petals are not killed, and hence the flowers will expand, it may be as freely and appear as beautiful as if there had been no frost. The petals are much more hardy than the stamens, and these in turn appear more hardy than the pistil. We have dissected many blossom buds this week, and found in several instances the pistil killed, while the stamens were fresh. In a case of this kind it is absolutely impossible that fruit can follow. Had the pistils been sound and the stamens killed there would have been a ray of hope, as pollen from other flowers might have been wafted to these partially injured blossoms and resulted in their fertilisation. Examine the matter closely for yourself, and you will be fortunate if you do not soon experience what you at present "cannot understand."

Sand for Potting (*F. C.*).—Neither of the samples you have sent is silver sand, which is quite white and very much finer than even your roadside sample. This, if well washed by stirring it in a pail of water, pouring off the water and adding fresh until the last applied is quite clear, then drying the sand, would be useful for all ordinary purposes of propagation, so would the sea sand if the rougher particles were sifted out. For mixing with soil for potting this would do well as it is, also for mixing with soil for striking very large cuttings of any kind either in pots or the garden. The flowers of any particular Peach often vary somewhat in size and tint, and no one can determine the identity of your trees in their present state. We have seen flowers of the Royal George both larger and smaller than those you have sent, and equally dissimilar in tint. The weed has arrived quite fresh this time, and we shall possibly be able to identify it, though, as we have frequently stated, we do not undertake to name plants without flowers. Could you not have told us the height it attains, and the size, form, and colour of the flowers it bears? It shall be closely examined and referred to again.

Petunias for Exhibition (*A Pansy Amateur*).—A shelf close to the glass of your vinery will be suitable for the Petunias so long as the plants are not shaded in the slightest degree by the growth of the Vines. These plants require unobstructed light, and cannot be well grown without it, also free ventilation and a genial atmosphere. The temperature of the vinery will be right for the plants until the Vines have made considerable growth; after that time, or towards the end of May if the weather be favourable, the Petunias will be better in a pit or frame, keeping them rather close for a few days, and gradually inuring them to more air until they can endure free ventilation, with the lights removed occasionally during very mild weather. If you do not possess a frame you must make the best of them in the vinery by assigning them the lightest position in the house. Shift the plants into 6-inch pots before they become root-bound, and again into 8-inch pots when the roots are seen protruding freely through the drainage. Let the soil in the pots, and that to be used be moderately moist when the repotting is done. Apply water cautiously, yet sufficiently, until the roots take possession of the fresh soil, then more copiously, according to the vigour of the plants and the state of the weather. Do not pinch the shoots and repot at the same time. Liquid manure will not be needed until the pots in which the plants are finally established are full of roots, and it may then be given once or twice a week instead of again repotting. At this time, too, very liberal supplies of water will be needed, the pots to be stood on

a moist base. This is especially important in hot weather. The soil for the first shift may consist of half turfy loam, the remaining half of peat and leaf soil, with sand to make the compost porous; for the final shift you may use two-thirds loam, and substitute decayed manure for the peat, adding also a fifteenth part of bonemeal. Continue stopping the shoots and tying to small stakes inserted at regular distances with the object of training the plants in the form of half-globes; but the stopping must cease six weeks before the show. As the fixture is early, in all probability 7-inch pots will be large enough, but this can only be determined by the condition of the plants. Varieties are of far less importance than good culture, and it is very unwise for anyone who intends exhibiting to limit himself to the number of plants to be staged. At the least a third more ought always to be grown, so as to provide for contingencies and make a selection for the exhibition table. We do not know the variety you name, the person from whom you obtained it will no doubt be able to give you the information you need respecting it. If any plant is less vigorous than the others, grow it in a smaller pot.

Stopping Vine Laterals—Twin Bunches of Grapes (Irish Rector).
—An extract from your letter will probably render our reply useful to others beside yourself. You observe:—"Mr. Barron delays the stopping of the shoots much longer than Mr. Taylor—the latter recommending the point to be nipped out as soon as it can be done—and in trying to do this I had made the discovery for myself of the method of combining two bunches described by "Druid," for in one or two cases I nipped off more of the shoot than I intended, and now the eye at the base of the first bunch is beginning to push." There is not so much difference in the practice of Mr. Barron and Mr. Taylor as you appear to suppose. Mr. Barron could not show so clearly by an illustration the method of stopping without allowing the lateral to extend somewhat before its point was removed; and he says, "The operation should be performed as soon as the shoot attains the requisite length by pinching off the tip at the point indicated (in the figures on p.p. 81-83 in his excellent book). There is thus scarcely anything to take off, and no consequent check to the growth of the Vine. It is very bad practice indeed to allow the shoots to grow to such a length as to render it necessary to use the knife in stopping them." This is sound teaching, and in removing "scarcely anything," his advice is really identical with that given by Mr. Taylor in his valuable little work. As both these cultivators have dressed the same Vines in the Royal Horticultural Society's Gardens at Chiswick, you will not find any great difference in their methods; and we shall not be wrong in saying that if Mr. Barron were to dress the Longleaf Vines he would follow Mr. Taylor's present system, and if Mr. Taylor were to dress those at Chiswick he would do the work the same as it is done now under the direction of Mr. Barron. We are not surprised that a cultivator so observant as yourself should have noticed the method described by "Druid," and figured on page 53, of making two distinct bunches appear as one. It is not only perfectly practicable, but we have seen clusters exhibited that had been produced in the manner there shown; but the practice is by no means general, and it is not likely that they will be often staged as single bunches.

Pruning Vines (H. S.).—The method of pruning must be determined by the state of the Vines and the varieties of Grapes that are grown. Nine-tenths of the bunches of Grapes that win prizes at exhibitions are the produce of Vines that have been pruned on the short-spur system, and that method is applicable to all free-bearing varieties when the Vines are in good condition—i.e., make strong yet short-jointed growth, with prominent buds at the base of the matured laterals. Vines that are excessively luxuriant may occasionally with advantage be pruned on what is termed the long-spur system, because the lowermost buds are often pointed and weak instead of being round and bold. We have no doubt that, as a rule, the best buds or eyes where the wood is ripe and firm containing little pith, produce the largest bunches, but they are not always the most compact and best-shaped examples, and good cultivators rarely find it necessary to adopt the system of pruning to those prominent buds that may be 6 inches or more from the main rods. At the same time such varieties as the Duke of Buccleuch, Gros Maroc, and frequently Gros Guillaume, bear better crops when a portion of young wood is retained than by cutting all off to within half an inch or so of the base of each lateral; but it must be remembered that this young wood cannot be fruitful unless the canes have been trained so thinly in the summer that the foliage could develop under the full influence of unobstructed light. Provided the roots of Vines are kept near the surface of the border and the foliage is not overcrowded the short-spur system of pruning is the best to adopt for all such free-bearing Grapes as the Black Hamburgh and Muscats—in fact for the majority of Grapes. The long-spur method, especially if practised by inexperienced amateurs, would almost inevitably lead to overcrowding, and possibly to such an extent that the Vines in a few years would be practically ruined. The long-rod is different from the long-spur system of pruning, and as a rule we should prefer it if we found occasion to change from the orthodox practice.

Vines in Pots (Idem).—"Will not pot Vines if moderately cropped produce fruit year after year—like a Peach tree—in a pot? And if not why not?" We print your question as we do not remember ever having an inquiry so briefly and concisely put on this subject. If you had a house large enough to allow of the leaves of your Vines in pots to develop under the direct action of the sun, and if the pots were large enough or ample support were given for the sustenance of the Vines, and these in other respects received proper attention, we have no doubt they would produce fruit "year after year." But we doubt very much whether you possess either the skill or convenience for rendering that system of culture profitable. Why they cannot be grown in pots year after year "like Peach trees" is this: The leaves of a Vine are some ten times larger than those of a Peach tree, the growth is ten times stronger, and requires ten times more support. If you can afford space for these growths and dispose them for the sun to shine on all the leaves, and at the same time supply the Vines with the necessary food for sustaining their vigour, you may adopt the plan you indicate and expect fruit every year, more or less; but we should fear something would happen to cause it to be less rather than more as the Vines grew older. Under skilled culture Vines in pots may bear moderate crops for two or three years, but we cannot hold out any hope that you can have them bearing "like Peach trees" for an indefinite period.

Names of Plants (T. P. Stanmore).—1, Davallia divaricata; 2, Nephrodium decompositum var. quinquangulare. We do not undertake to name varieties of Begonia Rex, many of them too closely resembling each other for anyone to do so except by comparison in a very large collection. (R. F. Watson).—1, Epacris miniata; 2, Correa cardinalis; 3, Acacia Riceana; 4, Lantana, spray withered; 5, Nicotiana Tabacum var.; 6, Tradescantia variegata. (E. Molyneux).—Fuchsia splendens, a pretty Mexican species. (W. M. A.).—1, Pilea muscosa, bad specimen; 2, Fuchsia, species not determinable without flowers; 3, Sedum Sieboldi variegata; 4, Forsythia viridissima; 5, Euonymus japonicus aurcus variegatus; 6, Sempervivum, probably S. montanum, but specimen insufficient for identification.

COVENT GARDEN MARKET.—MARCH 28TH.
MARKET quite still. No alteration.

VEGETABLES.					
	s. d.	s. d.	s. d. s. d.		
Artichokes.....	dozen	2 0 to 4 0	Lettuces.....	score	1 0 to 1 6
Asparagus, English	bundle	12 0 0 0	Mushrooms.....	punnet	1 0 1 6
Asparagus, French	bundle	25 0 30 0	Mustard & Cress..	punnet	0 2 0 2
Beans, Kidney....	100	2 0 0 0	Onions.....	bushel	2 3 2 6
Beet, Red.....	dozen	1 0 2 0	Parsley.....	doz. bunches	3 0 4 0
Broccoli.....	bundle	0 9 1 6	Parsnips.....	dozen	1 0 2 0
Brussels Sprouts..	½ sieve	1 6 2 0	Peas.....	quart	0 0 0 0
Cabbage.....	dozen	0 6 1 0	Potatoes.....	ewt.	6 0 7 0
Capicums.....	100	1 6 2 0	Kidney.....	ewt.	6 0 8 0
Carrots.....	bunch	0 4 0 0	Radishes....	doz. bunches	1 0 0 0
Cauliflowers.....	dozen	2 0 3 0	Rhubarb.....	bundle	0 4 0 0
Celery.....	bundle	1 6 2 0	Salsafy.....	bundle	1 0 0 0
Coleworts....	doz. bunches	2 0 4 0	Scorzoneria.....	bundle	1 6 0 0
Cucumbers.....	each	0 4 0 8	Seakale.....	basket	1 0 2 0
Endive.....	dozen	1 0 2 0	Shallots.....	lb.	0 3 0 0
Fennel.....	bunch	0 3 0 0	Spinach.....	bushel	3 0 0 0
Herbs.....	bunch	0 2 0 0	Tomatoes.....	lb.	1 6 2 0
Leeks.....	bunch	0 3 0 4	Turnips.....	bunch	0 2 0 3

FRUIT.					
	s. d.	s. d.	s. d. s. d.		
Apples.....	½ sieve	2 0 to 7 0	Grapes.....	lb.	2 0 to 8 0
".....	per barrel	20 0 40 0	Lemons.....	case	10 0 20 0
Apricots.....	doz.	0 0 0 0	Melons.....	each	0 0 0 0
Cherries.....	½ sieve	0 0 0 0	Nectarines....	dozen	0 0 0 0
Chestnuts.....	bushel	10 0 12 0	Oranges.....	100	6 0 10 0
Currants, Black..	½ sieve	0 0 0 0	Peaches.....	dozen	0 0 0 0
" Red....	½ sieve	0 0 0 0	Pears, kitchen..	dozen	1 0 2 0
Figs.....	dozen	0 0 0 0	dessert.....	dozen	1 0 2 0
Filberts.....	lb.	0 0 0 0	Pine Apples, English	lb.	1 6 2 0
Cobs.....	100 lb.	0 0 0 0	Raspberries.....	lb.	0 0 0 0
Gooseberries....	½ sieve	0 0 0 0	Strawberries....	oz.	0 6 0 9



POULTRY AND PIGEON CHRONICLE.

ENSILAGE.

It is said that there is nothing new under the sun, and although securing green crops by preservation in the silo is of very ancient date, yet the practice has recently been resuscitated, and to all appearances will eventually prove not only interesting in its details of management to the amateur, but of large practical benefit to the home farmer, as owners of estates have usually parks or pastures whereon herds of cattle and sheep are maintained both in summer and winter either by grazing or preserved produce. In taking the first glance at this subject it seems more practicable in the hands of those representing the management of the estates of noblemen and gentlemen than by the occupying tenants of farms possessing only limited means at command, especially as many of the silos that are recommended are expensive in formation. We hope to be enabled to place the subject before them in such a manner that both may be enabled to benefit by the system and details of management which we are prepared to practically explain. There is one important point to be remembered, that it is not upon all farms that the system under notice is required. For instance, it will no doubt be less required on those farms where no dairy cows are maintained; on the other hand, it is especially adapted for many of those fine grazing farms in the midland and western counties, many of which possess but little or no arable land in connection with the holding, in consequence of which they are unable to procure root crops for feeding during the winter and early spring months. In the latter case there can be no doubt that ensilage gives a better material for a butter dairy than anything which can be obtained without purchase. In fact, in many dairies the difficulty of providing, on the purely pasture farms, of food best adapted for the production of either good milk or butter is so great and so expensive that it almost necessitated the damaging system of letting the cows go dry for several months in the winter and early spring. This is a serious evil, detrimental to the welfare, safety, and condition of the cows, and also to profitable management.

After these prefatory remarks we will proceed to give the best information upon our subject, which we have obtained from the best sources at home and abroad during the past two years in which it has been tried by experiments. The results attained will not yet settle the question entirely as to the best mode of proceeding, but will go far to induce some of the most intelligent and persevering farmers and others to improve as much as possible upon our present knowledge of the subject.

Ensilage may well be described as the preservation of various kinds of green fodder, such as grass of pastures, water meadows, and the produce also of the arable land, like Clover, Lucerne, Rye Grass, aftermath, Maize, and other forage plants in a state by which they will contain nearly the same properties and feeding value as when brought fresh from the field in a green state in the summer and autumn months. We will take first for consideration the making of the silo, which is, in fact, a pit underground, or a waterproof tank either partly or wholly above ground. It is probable that the best constructed silos upon the most durable principle will be most desirable for those who can afford the cost and necessary expenditure; because, when properly constructed, there is no reason why they should not last for many years with but small repairs. As regards material, we think the best and most durable, as well as reasonable in first cost, will be concrete from 12 to 18 inches in thickness for the sides, ends, and floor, but faced inside with cement, in order to offer a smooth surface to the substances buried, and at the same time insuring the well being watertight either from within or from without. The soil in which the silo may be constructed should be quite dry, or otherwise drained to prevent injury and decay to the walls on the outside

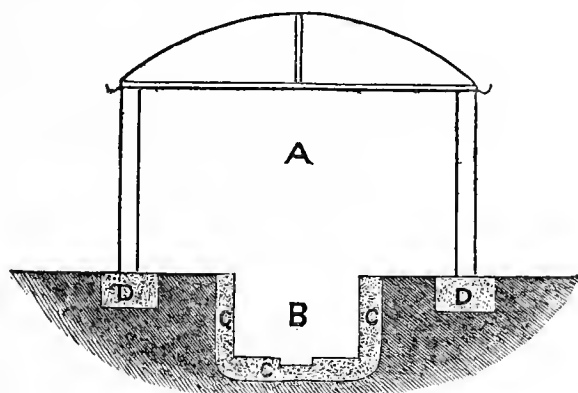

Fig. 67.—DUTCH BARN AND SILO.
A, Barn; B, Silo; C, D, Concrete.

Opinions still differ as to the most convenient width, depth, and length of the pit or tank, whether built under the ground level or above it. We think the best size will be found to be about 12 feet wide and 12 feet deep, but the length of the tank must be considered as a question of the quantity of fodder to be buried. In case of large quantities, then convenience dictates that there should be divisions, if continued for any considerable distance, say 15 or 20 feet for them; each tank would then be 15 feet long, 12 feet wide, and 12 feet deep, placed in continuation end for end, or at a reasonable distance apart side by side, with room for cartage between them.

The sides of the tank it is recommended should be constructed with a slight slope outwards, or "batter" as it is called, of about half an inch in the foot, so that the tank may be rather widest at the top. The object of this is to obtain compactness in the mass of ensilage and the entire exclusion of air; and as the fodder sinks the sloping sides will allow the weights at top to sink also and assist in rendering the mass more solid by giving more effect to the pressure used at the top of whatever materials it may be formed. These may consist of 2-inch wooden planks and blocks of concrete not over 75 lbs. each, or earth laid thereon. We prefer the latter, especially as the covering to the silo may well be covered like a Dutch barn with corrugated iron roof, such as recommended by Pearson & Company of Glasgow, and represented in the annexed figure. So that after filling the silo with the green forage the space above, 15 feet up to the eaves may be occupied with hay or corn at harvest time; and when the silo is covered with earth the horses would in that case find a footing for drawing in the loaded carts. We must further state that as green fodder yields a certain amount of liquid juice in the silo, the floor should be made with a slight incline towards one end, and a small well-hole will be useful to hold the liquor which escapes from the ensilage at the lowest end. This may be emptied first by reaching in and removing the mass, and may be used as a nutritious liquor, mixed or diluted with water, for the dairy cows. The advantage of not making the silos larger than

the cattle require, and of which they can consume the contents within a few days or a week, is correct management, because the ensilage would generally become mouldy and distasteful if not used within the time named. This fact must therefore decide the best size for the silo.

We will now refer to the practice of ancient date—namely, digging a pit in dry soil, such as sand without stones, firm clay, or chalk, for storing corn, &c., in Asia. This plan is common amongst the small or tenant farmers of the interior of America for storage of green fodder and vegetables, such as Cabbages. The plan is to dig and excavate the soil 8 feet wide, 8 feet deep, and of proportionate length, the ensilage to be well trodden down but not cut into chaff—except in the case of Maize with coarse stalks—whether it is composed of coarse prairie grass, Clover, Rye, &c.; but before covering with earth, fern or straw is laid over the ensilage. The earth may then be made up in a conical form, which answers the double purpose of weighting and compressing the mass and shedding the water from the silos. In this way, also, Potatoes, Mangold, Carrots, and other roots are stored during the winter, and it answers well in a climate where the frost is often much more intense than in England. Cabbages are placed in layers with their roots upwards, and then covered with less earth than is required for Potatoes. An American farmer tells us that the Cabbages, especially the best Drumhead Savoys, keep very sweet and perfect for three or four months. We name these latter plans for the advantage of those who cannot afford the expensive silos now becoming fashionable amongst the highest and wealthy class of farmers and dairymen.

(To be continued.)

WORK ON THE HOME FARM.

Horse Labour.—Full employment for the horses has been the rule of late, and if the weather continues fine the frosty mornings, which had hindered the plough for a time, will probably have the effect of making the land work more easily and facilitate the seeding of various crops. Although we lost much time throughout the winter and much land could not be sown in due season with Wheat, yet during this month the seed has gone in well, because the ground was generally damp, which is favourable for Wheat-sowing at any time if the seed can be properly buried and the land worked off in good form. It sometimes happens when the winter has been favourable that the month of March is unpropitious, and in our farm memorandums for the year 1862 we note that the teams of horses only did three days' work on the land during that month. There is no doubt that in case the last part of this month proves dry the prospect of the Wheat crop will improve.

We continue sowing White Victoria Oats, the sample being good and weighing over 45 lbs. per bushel. The Early Dun Peas, also, are now being sown in good season. The land for Potatoes is now being prepared, so that planting of the second early varieties may be commenced, the early sorts having been put in the beginning of March. From this time the Magnum Bonum will be the sort to plant upon all dry and friable loamy soils, after that the Champion. Both of these sorts produce much haulm and foliage when highly manured. We must therefore call attention to an excellent article on the subject of manuring in this Journal March 16th. It indicates a new departure in manuring for second early and late varieties as regards manuring, illustrating the advantages of the use of kainit or the German potash salts and superphosphate, only 2 cwt. per acre of each of these manures being required to produce full crops of excellent quality; indeed, much better than when 2 cwt. of nitrate of soda or guano had been added. It is not stated the distance between the rows at which the sets were planted. Therefore we assume that the sets may be put closer than we stated as our practice last week—namely, 36 inches, and 18 inches in the lines. We infer, also, that nearly all sorts which yield but little foliage, but the early varieties in particular, will bear a full dressing, such as we recommend through our own experience—viz., 2 cwt. of kainit and 3 or 4 cwt. of the best Peruvian guano mixed per acre.

As we are now drawing near to the time for drilling Mangold seed, we recommend the early season as the best, especially for the slow-growing sorts like the Golden Tankard, which contains the greatest feeding value of any sort grown for cattle-feeding. It is, however, objected that the roots do not come so large nor produce such heavy weights per acre as the Yellow Globe and Long Red, but this is to be improved upon by leaving the plants nearer together in the rows and early sowing. It is even recommended by some growers as a good plan to grow alternate lines of Long Red and Golden Tankard. But in alternate culture we should prefer to grow Golden Tankard and Red Intermediate Carrot in alternate rows.

Live Stock.—Sheep, especially ewes and lambs, have improved of late; both mutton and lamb are selling at high prices, and will reward the farmer for good and careful management. Upon grazing land, and especially the vale farms whereon the lambs are usually sold at light weights, they may now with probable advantage be held on and made up to the weight of 9 or 10 stones of 8 lbs., and pay better than by selling them as usual at 10 lbs. or 12 lbs. per quarter. Bullocks of all ages, from two years and over, will now pay well for breeding

as well as feeding. Those which have been held on for two years of age will not only pay well for feeding under cover in consequence of their growing as well as fattening, but they attain the weights required by the butchers, about 90 or 100 stones, at a period when cattle are not usually obtainable from the grazing districts of the midland or western counties. We have now strong hope that we may have a dry and favourable summer after a cycle of eight wet seasons, such a cycle as we have never known before during the past sixty years. Still farmers may have a care in feeding the grass lands with sheep, either in the irrigated meadows or low-lying strong land pastures, for even after a dry summer the autumn rains frequently fall heavy and render the pastures unsafe, for the sheep will take in the fluke, and should seldom be trusted on such pastures after midsummer.

SOIL-EXHAUSTION—STRONG-GROWING POTATOES.

THERE is one thing about disease-resisting Potatoes that must be apparent to all—they are all exceedingly strong growers, and are possessed of capital foraging powers, so much so that they are certain to utilise every particle of available plant-food that is within their reach. This foraging power has been hitherto looked on by the majority of farmers as an evil, for experience has proved that after a heavy crop of roots and tops ordinary soil with ordinary treatment will give inferior crops of corn. But is this necessarily the case? Are such strong-growing Potatoes as Champion and Magnum Bonum exhausters of the soil, robbers and dissipators of plant-food? Nine out of every ten farmers would answer—"Yes," but undoubtedly the nine would be wrong, as we hope to be able to show.

That strong-growing Potatoes yield the best crops, extirpate weeds, and by reason of their strong roots leave the soil finely pulverised, is recognised and placed to their credit. But we submit that these acknowledged good points do not embrace all the good points of strong-growing Potatoes. One other ought to be added—they are conservers of plant-food. Instead of robbing and dissipating, they organise, store up, and save what under ordinary conditions would be lost. That much more is removed from the land in a heavy crop than in a small one is evident and requires no proof. That ten tons of Champions or Magnums will take twice as much potash, phosphoric acid, and nitrogen from the soil as will five tons of Regents or Paterson's Victorias will be admitted. In this sense Magnum Bonum will certainly rob the soil, and, by so much, leave it poorer. But poverty so caused is not grudged, for the crop affords the means for restoring the fertility. None care to husband the soil's resources by lessening the crop.

But there is the useless portion—the tops. If Magnum Bonums yield twice the weight of tubers that Regents or Victorias do, they give three times as much tops. Not only so, but these tops go on growing and taking from the soil weeks and even months after the earlier kinds have either ripened off or decayed because of disease. After this happens the land is in the condition of bare fallow. Indeed, we ought to qualify that statement by saying it is much more subject to loss, for while bare fallow is not manured, green fallow is, and as weakly-growing Potatoes are poor foragers they leave much manure unused. Now under such conditions there is much waste of the most valuable part of the manure.

Let us glance at what happens on bare fallow. It gains nearly 7 lbs. of nitrogen from the rain that falls on it; but the same rain washes out fully 40 lbs., which is lost. On cropped land this loss is very much less, because the nitrates are utilised as fast as they are formed. In the case of crops early ripe or early removed there is always a heavy autumn and winter loss, because it is found that nitrates are most rapidly formed in autumn. Now, nitrogen as found in organised matter, or even as ammonia, is not subject to this loss—it is only when changed to nitrate that the loss occurs. This change is always proceeding, but more rapidly in warm than in cold soil. Hence the change is most rapid after midsummer.

Now this loss is a serious matter. Nitrogen is worth, and costs in the market, £100 a ton. How are we to save it? The old way was to grow a late crop of some rapid-growing plant and to plough it in. This was called green manuring. It is a very good plan too; and if farmers and gardeners would sow early-cleared land with this end in view they would certainly save money, for a penny saved is quite as good as a penny gained, and a pound of nitrogen so saved will do away with the necessity of buying that pound.

The loss of nitrogen is least on pasture land, and next on land occupied with Mangolds and Turnips, simply because these go on using up the nitrates formed late. No exact experiments that we know of have been conducted to show what is the autumn and

winter loss of nitrates after a crop of Magnum Bonum compared with that after one of Regents or other early sort. A good guide is afforded by the crop that follows. It is always, when nothing is done to balance the fertility, small—so small that we cannot be wrong in concluding that the strong-growing shaws are more conservative of nitrogen than even Mangolds or Turnips. In other words, nothing will so save from loss valuable manure as will a crop of strong-growing Potatoes. But, of course, this will avail us nothing if we do not utilise this nitrogen. If the shaws are carted off the field and heaped up anywhere out of the way for ever, as is by far too common a practice, or burnt, as is certain almost to be the other course adopted, we, of course, get rid of this saved material, and decidedly in such a case the land is robbed and the plant-food dissipated. But this is a terrible, a ruinous mistake. What would we think of the man who, having a great crop of straw, burnt or tumbled it into a hole out of his way? We should think him mad. But when it is done in the case of Potato haulm nobody seems to think it wrong. Properly treated big crops of shaws may be utilised as the most profitable of green manurings, the most effectual savers of slippery nitrates.

The haulm of Champion and Magnum Bonum Potatoes cannot be ploughed in as can a thick sward of Rape or Clover. They can, however, be put up with ordinary manure fermented, rotted, and then applied to the land. We could name one northern farmer who thus uses his Potato haulm with much benefit to his purse. He used to dress his corn land in spring with superphosphate, potash salts, and sulphate of ammonia. This gave him first-class crops on very poor soil. First-class crops meant much straw, much straw meant many cattle, and many cattle meant much manure. This farmyard manure was liberally applied to the Potato and Turnip crops. But since he began to grow these strong-growing Potatoes he has partly reversed this order of manuring. A half manuring of ordinary manure is now given to Potatoes and Turnips, and in addition, the former are treated to a mixture of potash salts and phosphates, the Turnips to phosphates only. But the Potato tops are made up into large heaps as soon as the crop is lifted, with as much long manure as makes the heap heat moderately, and as much urine from the tanks as makes it moist. A month or two afterwards this is cut into thin slices with a hay knife, driven out and spread in frosty weather, and ploughed in as soon after as possible on his corn land. Oats follow Potatoes; Barley, Turnips. By this means he finds that though he sells more off the farm in the form of Potatoes, corn, and cattle, he gives no more stableyard manure than formerly, buys a third less sulphate of ammonia, and yet he has better crops than before. And why? Simply because he has learned to save what others waste; and that, so far from strong-growing crops being wasters of plant-food, they are savers.

We intended saying something in this paper on the special wants of special crops and the peculiarities of different soils; but we fear the editorial scissors, and stop.—S. H.

[We will make room for matter of the kind indicated.]

METEOROLOGICAL OBSERVATIONS.

CAMDEN SQUARE, LONDON.

Lat. 51° 32' 40" N.; Long. 0° 8' 0" W.; Altitude, 111 feet.

DATE.	9 A.M.					IN THE DAY.				Rain.
	Barometer at 32 nd and Sea Level	Hygrometer.		Direction of Wind.	Temp. of Soil at 1 foot.	Shade Temperature.		Radiation Temperature.		
		Dry.	Wet.			Max.	Min.	In sun.	On grass.	
1883.										
March.										
Sun. 18	29.622	36.8	33.2	S.W.	37.0	43.0	39.2	65.4	26.3	—
Mon. 19	29.779	36.8	35.4	N.E.	37.1	43.4	33.6	63.3	31.1	0.292
Tues. 20	29.670	39.4	38.2	S.	38.1	41.2	36.4	46.7	37.2	—
Wed. 21	29.637	38.8	36.9	E.	38.3	42.3	36.8	58.8	36.4	—
Thurs. 22	30.115	31.4	31.0	N.E.	38.1	37.3	29.5	85.3	29.6	—
Friday 23	30.208	32.3	30.6	N.E.	37.0	41.1	27.2	87.3	23.8	—
Satur. 24	30.011	30.7	29.3	N.W.	36.8	46.2	22.4	88.4	19.3	0.019
	29.860	35.2	33.5		37.5	42.1	30.9	79.7	29.1	0.311

REMARKS.

18th.—Fair and dry, but not very bright.

19th.—Fine until noon, afterwards rain.

20th.—Fair, but overcast.

21st.—Dry, dull, and cold; moonlight night.

22nd.—Slight sun in early morning; bright cold day, with strong N.E. wind.

23rd.—Fine, with very bright sunshine and cold wind.

24th.—Fine and bright, showers of sleet in evening.

The temperature continues exceptionally low. The average for the past three weeks is lower than the average for the coldest part of January, and the minimum on Saturday (22° 4') is the coldest this year. The barometer was, however, falling rapidly on Saturday evening.—G. J. SYMONS.



5th	TU	Royal Society at 4.30 P.M. Linnean Society at 8 P.M.
6th	F	
7th	S	
8th	SUN	2ND SUNDAY AFTER EASTER.
9th	M	
10th	TU	Royal Horticultural Society, Fruit and Floral Committees at
11th	W	[11 A.M.]

MELON CULTURE IN POTS.

HERE are men who hold the opinion that good Grapes are more easily grown than good Melons, and I am inclined to agree with them; but it must be remembered there are Melons and Melons. To be plain, there are some grown that are most delicious, and there are many grown, and these far outnumber the former, which are positively unfit to eat. Who has not heard visitors to private gardens observe when seeing a crop of Melons, "Oh! I do not like Melons?"

Those who make the remark in my presence are generally asked if they have ever tasted a good one. At one time I used to imagine that the judges at exhibitions must experience great difficulty in awarding the prizes for Melons, especially where many are staged. In reality there is little difficulty about the matter, as not one-tenth require a second taste. Grapes which are not of sufficient merit to win a prize may yet be of excellent table quality, but this is seldom the case with Melons, and therefore if we say good Grapes are more easily grown than good Melons we do not err.

Why so many fail to grow Melons to perfection it is difficult to explain, as after all they can be, and are, frequently grown surprisingly well by comparative novices in a variety of soils and under various conditions. Some grow Melons in turfy loam with and without manure mixed with it; others in loam taken from under the turf, not because they prefer it, but because the turf must be returned in order to preserve appearances; and others have to be content with ordinary garden soil. They are amenable to house, pit, and frame culture, and may be planted in mounds of soil, in temporary brick pits, in boxes and pots, and in every case success may result. The fact is, with Melons, in common with other popular plants and fruits, certain composts, positions, and temperatures may be desirable, but are not absolutely necessary, everything really depending upon the intelligence of the cultivator. I am very fond of growing Melons, and have tried various schemes with varying success rather than be without them, consequently I am in a position to offer advice on the subject. I propose to dwell briefly upon several methods of culture rather than confine myself exclusively to that which I may think the best, well knowing that what is possible in one case is impossible in another, and by including all I may perhaps benefit a greater number. It is only of late years that Melons have been so extensively grown in houses, as formerly they were principally grown in pits and frames. The latter structures are still utilised for them by perhaps

the majority, but as the systems pursued must necessarily differ they may well be included in separate communications.

Considerable pains should be taken in preparing the plants for all methods of culture. We sow the seed singly in 3-inch pots, using a compost of two parts of loam to one of leaf soil. The pots are plunged in a bottom heat of about 70°, and watered if the soil is dry. Excessive moisture in the case of the earliest sowings is apt to rot the seed, neither do the seedlings require much water at the roots for the first few days. When in rough leaf they are supported with stakes and raised on the beds or stood on the walls, thus bringing them nearer the glass and much strengthening them. We always try to avoid giving the plants a check in any way, and therefore should they be in advance of their intended site they are shifted into 6-inch pots, employing soil previously warmed and composed of loam and a little manure. In this manner they continue to improve, and when finally planted are soon well established. We endeavour to raise more than are required, but do not keep the weakest surplus plants standing about in a semi-starved state with the idea of utilising them for a later crop, a by-no-means uncommon proceeding. Far better it is to raise a fresh batch of plants and keep these growing and clear of any other kind of plants which may be insect-infested. None but clean plants should be commenced with, as Melons must be kept free of the insect pests, to which they are peculiarly liable, as much as possible if success is to be assured.

There is no necessity to plant a whole house at one time, neither is it advisable where space is limited and the supply required to be regular. If we put out a dozen plants at once, no matter how many varieties are included, there is eventually almost certain to be an undesirable supply—too many ripe at once, whereas if the grower had made three sowings and plantings, say at fortnightly intervals, this would have been avoided. No difference whatever need be made in the atmosphere and temperature of the house at the ripening stage, but rather less water may be given at the roots of the most forward without affecting those swelling off their fruits. We devote three houses principally to Melons, the plants for the earliest crop being obtained from seed sown about the middle of January, and these are in their fruiting quarters at the end of February. The next were raised three weeks later, and this season were planted March 15th, while the last batch were sown about the same date. All are supposed to perfect two or more crops each, and we ought not to have a break in the supply from the commencement to the end of the season.

Where space is limited, or if variety be an object, I recommend pot culture, this method admitting of a greater number of plants being trained on a given space, the restricted root-run naturally having a corresponding influence upon the top growth. It is surprising what a number of good fruits may be secured from a row of plants in pots; indeed, some of our most successful growers—notably Mr. Coleman at Eastnor Castle and Mr. Austin at Ashton Court—grow Melons extensively in pots, not, however, because space is limited, but because they believe it to be the most profitable method. It may be their skilful treatment has most to do with the result; at any rate the careless

cultivator will not succeed with them, as one hour's neglect in the matter of supplying the large amount of water plants in pots require will undo the work of several weeks. I do not practise pot culture here, but in my previous situation, where house room was more limited, all our Melons were grown in pots. The only house available was about 12 feet wide, low, span-roofed, and running from east to west. Along the south front a pit about 1 yard wide was formed, this enclosing pipes for bottom heat. A larger pit 6 feet wide, without bottom heat, was built on the opposite side, and for each portable staging was made, this being used during the autumn and winter for ordinary plant-growing. In the front pit a row of Melons in pots were disposed about 1 yard apart, the pots plunged in a mixture of leaves and manure, and the top growth trained up the roof and stopped about midway over the pathway between the two pits. On the opposite side or the front of the large pit next the path were more Melons in pots. These, as will be seen, were a considerable distance from the glass, and were trained obliquely and towards the glass on the south side, the upper part of the trellis being 2 feet above the termination of the front row of plants. Cucumbers were grown at the back of the large pit and trained up a trellis attached to the north roof of the house, and at the ends of the house two rows of Tomatoes in boxes were grown. As a matter of course this crowding of crops involved much labour, and the Cucumbers especially were not easily reached; but in the end we felt well repaid for our trouble, as, in addition to maintaining a good supply, we secured first prizes for Cucumbers and Melons at local shows, and for Tomatoes at metropolitan meetings. I had previously found that Melons might be grown satisfactorily in an atmosphere suitable for Cucumbers or Pine Apples. Some of the best Melons I have yet seen were grown in pots on high back shelves in a Pine stove and trained up the roof. A strong heat, plenty of light rather than a fierce sun heat, and abundance of moisture at the roots, appears most necessary for Melons.

For shelves 12-inch pots should be employed, but the pots should be the largest available when stood on strong benches or plunged in heating material. The compost we prefer consists of fibrous clayey loam, the turves being cut rather thick and stored in a heap for at least three months prior to use, and to every two bushels of this is added when roughly broken up a shovelful of lime. If poorer loam were necessarily employed we should add a little artificial manure according to the strength recommended by the vendor. A moderate amount of drainage only is necessary, over this being placed some of the roughest of the soil, and then more is added and firmly rammed down so as to bring the ball of the plant when in position to within 4 inches of the top of the pot. Fine soil is placed in immediate contact with the roots, while the remaining space is filled with rougher soil, which is made as firm as possible. The pot being only filled to within the above depth of the top permits of a top-dressing of manure being given when the crop commences swelling.

I must not omit cautioning beginners against employing cold soil. It should, prior to potting, be heated to the same temperature as the house in which the young plants are growing, and to effect this I know of no plan to equal that of heating several bricks in a furnace and burying these in the heap of soil. The

balls of plants to be shifted into fruiting pots should be in a moist state, and care must be taken not to saturate the surrounding soil or the roots will not readily penetrate it. When in full growth abundance of water, always of the same temperature as the house, should be supplied, those not plunged often requiring two or three soakings daily. When the fruits are swelling weak liquid manure should be given at every watering, or, better still, an occasional spoonful of a good artificial manure such as that supplied by the Crown Manure Company, or Standen's Manure, should be spread over the surface of the pots and carefully watered in.

The trellis for training may be fixed about 12 inches from the glass, the wires being strained across the house, and 10 or 12 inches apart, or, as I prefer, two rods may be fixed, one along the front and the other about 4 feet from this in the same direction, and to these short lengths of wire may be attached. The growths are trained to within 1 foot of the top of the trellis before the point of the leading shoot is pinched out. All the leaves on the main stem should be preserved intact, but the side shoots formed below the trellis should be rubbed out as fast as they appear, as in this case they heal quickly, whereas if allowed to remain till it is necessary to cut them out there is the danger of bleeding and eventual injury to the stems from the spread of the canker thus caused. The main growth up the trellis will form abundance of side shoots, which also should be early thinned out where at all crowded. Nearly every lateral will produce fertile blooms, which should be impregnated when four or more are expanded at the same time. Pinch back the shoots at the first joint beyond the fertile blossom, and do not syringe when these are being set. Maintain a temperature as near as possible to 70° by night, to rise in the daytime to 85° with air. Further cultural details will follow. Nearly every variety is adapted for fruiting in pots, but the old Victory of Bath is early and good, and I much like Colston Bassett, Hero of Lockinge, and William Tillery, green-fleshed; with Blenheim Orange and Reid's Hybrid, scarlet-fleshed. — W. IGGULDEN.

MAKING AND RENOVATING LAWNS.

(Continued from page 156.)

THE ground having been prepared and levelled, it will further be necessary to bring the surface into good tilth, whether it is to be laid with turf or sown with grass seeds. If the ground be poor it will be desirable to apply a dressing of well-decayed manure, and point it in with a fork. After this the ground should when the surface is dry be trodden well and raked, so as to produce an even surface. Obnoxious weeds, such as Ranunculus repens, Plantain, Dandelion, Docks, Knot and Couch Grass, it is needless to point out, should be rooted out and cleared away, also any rough stones.

The next consideration is whether to lay turf or sow grass seeds. If good turf can be had this will afford a satisfactory result in a shorter time than sowing seeds, but few care to sacrifice their best turf even for a lawn. Where turf cannot be had from better places than roadsides it would be preferably left there along with its numerous weeds and coarse grasses. Good turf, however, being obtainable, it should be properly cut. All the turves should be of an equal thickness and size, about 3 feet long and 1 foot broad, cutting it as level and as square as possible, otherwise the work will be more tedious and indifferently performed. If there be any great inequality in a turf place it aside for piecing, as more time is spent in adjusting a badly cut turf than is needed to lay a dozen proper ones. When the turves are all laid, or, if the

ground be extensive, when a good portion is done, a turf-beater must be used to beat down any inequalities and join the root side of the turves with the soil. After this roll it with the heaviest roller at command. If the weather be dry water well after beating, and when the surface is dried sufficiently roll it again. The watering will need to be repeated if the weather prove dry, for drought will cause the turves to shrink and curl. The best season to turf is in the autumn, in mild weather during winter, and in the spring before much growth is made, as it then has the benefit of the cooler and moister atmosphere.

So limited being the supply of really good turf and such good and clean grass seeds are now furnished by the principal seedsmen, that it is truly astonishing what fine lawns are formed in a few months by sowing the mixtures, which are assorted so as to suit every description of soil and location. As one having had long and rather extensive experience in forming lawns by sowing grass seeds both in mixtures and in obtaining the seeds separately, and apportioning the quantities of each as seemed best suited to different soils, I consider that good mixtures are not only the cheapest but in many cases superior in result to any that can be formed by private individuals.

The greatest evil in sowing grass seed to form a lawn, &c., is the insufficiency of the quantity used. Sometimes the quantity is as low as 40 lbs., and, omitting Clovers, rarely exceeds 50 lbs. per acre. This is not sufficient to form a good sward quickly, and although it may ultimately form one, the turf is both rough and open for some time, not standing well for cutting either with the machine or scythe, and the growth of weeds is considerably encouraged. With properly prepared ground, a suitable and full quantity of seeds duly sown and cared for, a good lawn may be formed by the middle of the first season superior in appearance to a lawn formed by laying turf; but it will not, of course, stand the same amount of wear. In order to obtain a quick and certain result there must not be any parsimony in seed. The quantity should not be less than 60 lbs. per acre, and may be apportioned as follows, which, though rather expensive at first, has proved thoroughly satisfactory:—*Cynosurus cristatus* (Crested Dog's-tail), 16 lbs.; *Festuca duriuscula* (Hard Fescue), 8 lbs.; *Festuca tenuifolia* (Fine-leaved Fescue), 8 lbs.; *Lolium perenne* (Fine-leaved Perennial Rye Grass), 20 lbs.; *Poa nemoralis* (Wood Meadow Grass), 2 lbs.; *Poa nemoralis sempervirens* (Evergreen Wood Meadow Grass), 4 lbs.; *Poa trivialis* (Rough-stalked Meadow Grass), 2 lbs.

If the lawn is to be used for tennis, &c., add 4 lbs. of *Cynosurus cristatus* and 4 lbs. *Festuca duriuscula*, reducing the *Lolium perenne* to 12 lbs. and the Clover to 4 lbs.; White Clover (*Trifolium repens*) and 2 lbs. Suckling Clover (*Trifolium minus*) will be ample. For an ordinary lawn 8 lbs. *Trifolium repens* and 2 lbs. Suckling Clover will be necessary. Where the ground is shaded by trees substitute *Poa nemoralis* and its variety for similar quantities of the two *Festucas*, not, however, excluding them, but reducing their quantities according to the extent of the shade. On light soils *Avena flavescens* may be added to the extent of 2 lbs., *Festuca rubra* 4 lbs., and *Lotus corniculatus minor* (Birdsfoot Trefoil) to the extent of 1 lb. in lieu of 3 lbs. White Clover, the Perennial Rye Grass being reduced to the extent of the additions of *Avena flavescens* and *Festuca rubra*. *Festuca ovina* (Sheep's Fescue) should be used on high ground. On heavy wet soils add 8 lbs. *Agrostis stolonifera*, and take 4 lbs. of White Clover only instead of 8 lbs.

The best time to sow grass seeds is during calm weather about the middle of April, and when the ground is dry, with an early prospect of rain. It is indispensable that the seeds be distributed as evenly as possible, and be very lightly raked in. If this be not done birds will reduce the number of the seeds before they have time to germinate. Roll well after sowing, and when the grass is well up dress with soot, half a peck per rod being sufficient. If soot cannot be had guano may be used at the rate of 4 cwt. per acre, or 3 lbs. per rod. Do not cut the grass very closely at first, but switch it over with the scythe a few times before using the machine, and roll well, but not when very wet or dry. After midsummer the grasses will have made good progress, and may be regularly machined.

RENOVATING LAWNS.

The dark green colour of the grass in pleasure grounds is sometimes absent in winter, having a brown sere appearance, and is long coming in spring, which arises from the grass on lawns becoming weak and thin from the frequent cutting. Poverty of grass is a consequence of the poverty of the soil. Various plans to destroy moss are in vogue, but none can be effectual until the land is thoroughly underdrained, as by carrying off all surplus and particularly stagnant water the atmosphere and heat are enabled to penetrate the soil. This is one of the most efficient modes of destroying moss and all moisture-loving plants. As those decrease another class of plants are invigorated, and supplant them. But something more than drainage is often needed. If the surface be much infested with moss remove as much as practicable with an iron rake. Clear it off and dress with quicklime at the rate of half a bushel per rod; afterwards apply a dressing of well-decayed manure, or preferably reduced vegetable refuse, freed of sticks and stones by sifting, three bushels of which per rod is not too much. Rake in well, and the rains will soon wash it out of sight, or the grass will grow so as to hide it. If the grass be scanty sow 12 lbs. *Cynosurus cristatus*, 4 lbs. *Festuca duriuscula*, 4 lbs. *Festuca tenuifolia*, 2 lbs. *Poa sempervirens*, 4 lbs. White Clover, and 2 lbs. Suckling Clover, raking in lightly, and rolling well down. The quantity is for an acre on a very bare lawn; a lessened quantity can be taken according to the condition of the grass. Do not cut the grass very closely until midsummer is past.

If the grass be plentiful yet poor it will only be necessary to give a good dressing of compost. The accumulated refuse of gardens mixed with a sixth of lime and turned over a few times will when sifted form a capital dressing, and may be placed on so as to entirely cover the surface about a quarter of an inch deep, or about 40 cartloads per acre. This allowed to be washed in by rains will soon make a decided improvement in the lawn, and should not be rolled until the grass has made good growth. This will be a more permanent improvement than any artificial manure, from its adding to the staple of the soil, yet the appearance of soil or compost may deter its employment. In that case a very decided improvement may be made in lawns, whether they be mossy or bare and poor in growth of grass, by a dressing of artificial manure, of which there are now so many, and all, so far as I have tried, good, that no particular mention need be made of any; but for lawns equal proportions of soot, wood ashes, and lime all in a dry state and thoroughly incorporated, and applied in spring at the rate of half a peck per rod (or where the moss is strong and the grass thin and weak doubling the quantity) will be advantageous; and if we add as much native guano (dry earth-closet manure) as there is soot, wood ashes, and lime, we have when thoroughly incorporated, as it may be when dried, a highly fertilising and durable manure. It is readily used, and, if kept dry, is as portable as guano. It is good for grass, capital for flowers, unequalled for fruit trees from the Vine down to a Gooseberry bush, and suits vegetable crops well. In the case of lawns that have become much infested with weeds and coarse grasses, it will be advisable to break up and dig or trench as deeply as the good soil allows. The burying of the surface will mostly be sufficient to destroy all weeds, excepting some of the deeper tap-rooted kinds, and these should be carefully removed. A good dressing of manure should then be given and pointed in, the ground well trodden and sown with grass seeds as before advised. This will be a more certain and in the end cheaper mode of proceeding than seeking to eradicate the weeds by hand, as an entirely different appearance will be given by sowing a proper mixture of lawn grasses.—G. ABBEY.

EUPATORIUM WEINMANNIANUM is a most useful plant for winter. If cuttings are taken now and potted singly when rooted into 60-size pots in equal parts of loam and leaf soil, and shifted on into 48-size pots. Pinch back the shoots to make them bushy, and when danger of frost is over plant them out on a sunny border in good rich soil. About the commencement of September take them up and pot them, and keep rather close and shady for a few days, when plants 2 or 3 feet in diameter will be the result

Eupatorium riparium is another useful plant, but it blooms rather later.—A. YOUNG.

TYING VINE LATERALS.

TYING down the growing laterals of Vines is an operation in the execution of which but few young men in their earliest experience escape coming to grief. Their enthusiasm very often leads them to tie too tightly, and if the shoots do not break at the time they often do so when the Vine becomes full of sap during the succeeding night, and are found suspended the next morning. To old Vines the loss of a few laterals is not of very great consequence, as other shoots will generally spring from the old spurs; but it is a serious matter when the laterals are thus broken off a young leading rod, as on these depend the formation of the future spurs. The laterals from young rods are generally very apt to break, more so than those from old spurs, and therefore extra care should be taken that they are not pulled down too far at first, for if once broken no spur can at any future time be produced at that point of the rod.

If Vines were all trained about 2 feet from the glass very little tying would be found necessary till the shoots were in a more hardened condition, and I believe they would do better too, preventing the possibility of the leaves coming into contact with the glass, and, as pointed out by a recent writer on the Vine, they are in a more equable temperature. The great majority of Vines are trained about 15 inches from the glass, and consequently tying at an early stage of their growth is absolutely necessary to prevent the tips of the shoots coming into contact with the roof. The Vines should be examined as soon as the shoots are a couple of inches long, and all but one at each spur rubbed off, leaving those shoots growing out sideways. These should be stopped as soon as the bunches are visible, leaving two leaves in front of the bunch. When they are getting too close to the glass take a fine strip of raffia or other tying material, and tie one end of it loosely to the lateral as near to its extremity as its strength will permit, pull it just so far as clear the glass a few inches, and fix the other end of the raffia to the wires at a convenient point. In about a fortnight, if it is found necessary, it may be pulled down a little further, and this is done by cutting the raffia close to the lateral, placing it another joint out towards the end, and tied without disturbing the end fixed to the wires. At a third tying in the same way the shoots may be finally brought down to the wires and secured by the same piece of material, which operation can generally be done about the time the Vines are in bloom. There is some saving of material by this mode of tying, it is quickly done and looks neat. Those who are building vineries would do well to place the wires at least 20 inches from the glass, so that no tying would be needed till root-action has commenced, and the base of the lateral sufficiently hard to stand the strain of tying.—R. INGLIS.

MOISTURE-LOVING PLANTS.

In my last notes (page 311, vol. v.), through a printer's error I was made to represent the American Mayflower (*Epigæa repens*) as belonging to the natural order Liliaceæ. *Chrysobactron Hookeri* was what I intended my remarks to apply to as regards natural affinity.

Resuming the subject, the genus *Gentiana* comes next in alphabetical order. Taken collectively, all *Gentians* may be said to be moisture-loving—that is to say, more so than ordinary border plants. None can endure even slight periods of drought without suffering often beyond recovery.

Gentiana acaulis.—The *Gentianella* is no exception to the rule. It always enjoys a retentive soil. Generally it may be said to require a pure air for success. Near large towns we seldom see it satisfactory. It has another peculiarity. Where it chooses to flourish it is as easy to manage as common Daisies, growing in any odd places, often margining kitchen garden walks. If there be a secret it is in keeping its roots cool and not disturbing it above once in two or three years. A noted grower told me that in districts where the subsoil is dry a good plan is to place a common tile under each patch when planting.

I lately had the pleasure of seeing the new variety of the *Gentianella*, *G. acaulis* v. *albus*, in flower in the Birmingham Botanic

Garden. Mr. Latham told me a friend of his sent it from the Alps, having gathered it himself, and says it is abundant. It seems to be a good white, though not pure, and is larger in habit and size of flower than the type. In the various gardening journals I have as yet seen no record of its blooming; and although I know it is in a few gardens, yet I believe in no case except this can it be in sufficient strength for blooming, judging from the condition the plants were in, coming from the continental nurserymen who supply them.

G. asclepiadæa.—The finest specimen I have seen of this was growing in a partially shaded peat border in Mr. Rawson's garden at Bromley Common, Kent. It is a profuse-blooming species of very good habit, growing about 1 to 1½ foot high. Flowers of a brilliant dark blue, in bunches of two to six, near the apex of each stem, of the same shape as in *G. acaulis*, but not so large nor of such texture. Of this species I would only add that Mr. Rawson had the generosity to divide his plant, giving me nearly half of it, but I never succeeded in establishing it, though I endeavoured to give the same treatment as Mr. Rawson's. I attribute my failure with this, as with several other imported *Gentians*, to want of care in removal. Every available piece of root should be had, if it be necessary to dig 3 feet for it.

G. bavarica, (fig. 68), the gem of all the higher alpine species, is not so difficult to manage as is generally imagined. It may at



Fig. 68.—*Gentiana bavarica*:

once be described as a swamp species. Daily in spring and summer it requires water to the extent of flooding. I should imagine from the conditions under which it flourishes that it would make a very good companion for the Sundew (*Drosera rotundifolia*), as I have seen the latter growing on Keston Common, Kent. The Bavarian *Gentian* is much in the way of our lovely vernal species, but is generally smaller in habit of growth, though having flowers equally large of a more brilliant hue. The leaves of the vernal species are wedge-shaped and acuminate, those of the Bavarian oblong and obtuse. The latter has not the purplish tinge on the aged leaves that our species has.

The giant *G. lutea*, and its allies *G. punctata* and *G. Burseri*, enjoy a good deep moist border where they can root to the depth of 3 feet. In such cases a well-grown plant of *G. lutea* will sometimes attain 3½ to 4 feet, flowering up quite 2 feet of the stem for upwards of two months. It is the officinal species. A plant was shown me by Mr. Ellacombe, of Bitton Vicarage, with broad, Plantain-like leaves, not in flower, but in good health, having in general appearance some affinity with the *G. lutea* section, which he informed me he had sent him from Kew as the true *G. affinis*.

I described to him at the time the growth and flowering of a *G. affinis* that I raised from seed purchased of Mr. Thompson of Ipswich, which is totally different from the Kew specimen. Mr. Thompson's species enjoyed a place by the side of the swampy Bavarian species. It grew about 1 foot high, quite erect, having rather distantly oblong-lanceolate, obtuse, dark green leaves, about 1 inch long. The flower-stems were terminated by clusters of rather small, but quite expanded, purple-blue flowers. On the whole a very meritorious species, and well worth a place in the bog garden.

G. Kurroo, the Indian Gentian, is one of the most distinct species I have seen. It carries a bunch-like whorl of closely arranged, sheathing, lanceolate, recurving leaves, terminating the stem-like rootstock, which does not divide. The flowering stems decumbently radiate from amongst the older leaves, are bracteate, and bear singly at intervals very beautifully striped, well-formed, azure-blue flowers. They open only when the sun is bright. I will only mention one more, *G. auvernensis*, recently sent out by Messrs. Backhouse. It is after our British *G. Pneumonanthæ*, but far superior in size and brilliancy of flower, enjoys drier parts of the bog. The above have been selected from a list of thirty-one kinds, but many have not been fully tried. I hope, however, at some future date to draw attention to some of these.—M. B.

POTATOES FOR TABLE AND MARKET.

(Continued from page 255.)

WALES.

In the following notes the figures 1, 2, and 3 indicate first early, second early, and late varieties; the months the time of planting; and the asterisks those varieties that are considered the best for market purposes by the respective cultivators.

ANGLESEA.—1. Early in February to early in March. *Mona's Pride*, **Veitch's Ashleaf*, **Myatt's Prolific*, and *Early Oxford*. Soil.—Medium to heavy. 2. March. **Beauty of Hebron*, **Fortyfold*, **Covent Garden Perfection*, and *St. Patrick*. 3. Middle of March to middle of April. **Magnum Bonum*, **Scotch Champion*, and **White Rock*. Manures and Application.—Generally ordinary farmyard or stable manure well decayed. For early kinds I usually dig the manure in during the winter, and open a trench with the spade for planting, using a dressing of well-decayed leaves or garden refuse in the trench. Kidney varieties are always started half to three-quarters of an inch before planting. Medium and late varieties are usually planted on the manure. General Culture.—The usual practice in this island, where Potatoes are largely grown for sale, is to spread the manure between the ridges opened by the plough from 32 to 36 inches apart. Artificial manures are comparatively little used for Potatoes. Providing the weather is favourable, the bulk of the planting is over by the first week in April. Seaweed is often used on light or sandy land near the sea, and with good effect. I have not observed Potatoes to be more liable to disease when planted directly on the manure than if it is dug or ploughed in previous to planting and the tubers not in direct contact with it. I am of opinion that it is better to grow more of the early varieties, such as *Myatt's Ashleaf* and other kinds ripening early, before the disease generally appears than is usually done. In cold wet seasons such late sorts as *Champion* and *White Rock* are often cut down when in full growth. The kinds last mentioned are the principal field Potatoes in this island; *Magnum Bonum* on the same land is excellent in crop and quality, but not nearly so much grown. *Beauty of Hebron* is good in quality and crop, and is early.—JOSEPH ELLAM, *Bodorgan Gardens*.

CARDIGANSHIRE.—1. Second week in February. *Suttons' Ashleaf*, **Rivers' Royal Ashleaf*, and **Myatt's Ashleaf*. Soil.—Rich light soil. 2. First week in March. *Suttons' Woodstock Kidney*, *Suttons' King of Potatoes*, and *Snowflake*. Soil.—Medium soil. 3. Third week in March. **Suttons' Magnum Bonum*, *Suttons' Reading Hero*, and **Schoolmaster*. Manures and Application.—A dressing of lime and old hotbed manure for the garden crop. General Culture.—For main field crop work the ground well in fine weather, and have the soil as fine as possible. Give a good dressing of lime, and open trenches with the plough 30 inches apart. Apply a good dressing of farmyard manure in the trenches, setting the Potatoes on the manure 12 inches apart, and cover with the plough, leaving the ground in ridges. *Suttons' Magnum Bonum* has proved to be the best Potato for the main crop both for quality and quantity; it resists the disease better than any other kind, and it becomes a great favourite in this neighbourhood.—JAMES VEAREY, *The Gardens, Gogerddan Hall, Aberystwith*.

CARMARTHENSHIRE.—1. February. **Rivers' Royal Ashleaf*, *Early Rose*, **Myatt's Prolific Ashleaf*, and *Gloucestershire Kidney*. Soil.—Light, and a damp climate. 2. March. *Fortyfold*, *Lapstone*, *Gryffe Castle*, and *American Snowflake*. 3. March. **Magnum Bonum*, **Scotch Champion*, the best late Potato grown, *Victoria*, and *Schoolmaster*. Soil.—Medium. Manures and Application.—For early and second early sorts a good dressing of decayed manure should be dug

in the ground a short time before planting. For late sorts, after the ground is dug trenches about 9 inches deep should be opened, some rather fresh manure being laid in the bottom and the Potatoes planted on it. General Culture.—Should the Potato haulm appear above ground before all danger of frost is over, a little soil drawn over it on a dry day will protect it. During April the ground should be hoed and forked to keep it loose, and when about a foot high they should be finally earthed up.—JAMES TICEHURST, *The Gardens, Dynevor Castle, Llandilo*.

CARNARVONSHIRE.—1. First or second week in March. **Veitch's Improved Early Ashleaf*, **Myatt's Prolific Ashleaf*, and **Covent Garden Perfection*. Soil.—Light and medium. 3. Not later than middle of April. **Magnum Bonum*, **Scotch Champion*, and *Pater-son's Victoria*. Soil.—Medium. Manures and Application.—We find nothing so good as good farmyard manure well decomposed.—WALTER SPEED, *Penrhyn Castle, Bangor*.

DENBIGHSHIRE.—1. March. *Veitch's Early Ashleaf*, **Myatt's Prolific Ashleaf*, *Rivers' Royal Ashleaf*, and *Beauty of Hebron*. Soil.—Light loam, resting on gravel; sideland facing south. 2. End of March. **Captain White*, *Mona's Pride*, *Snowflake*, and **Dalmahoy*. Soil.—Light and boggy vegetable soil, water 2 feet below the surface. 3. End of March or first week in April. **Lapstone Kidney*, **Magnum Bonum*, **Scotch Champion*, **Dunbar Regent*, and **Victoria*. Soil.—Very light, gravelly, very steep, sideland facing north. Manures and Application.—Farmyard manure dug in previous to planting. Peruvian guano strewn broadcast before earthing-up; all the better if a shower of rain after the guano is strewn before earthing-up. General Culture.—I never plant too early. Keep the ground clean and well stirred with a hoe. The distance apart for early Potatoes is 18 inches each way, and for late varieties 2 feet between the sets, 2½ feet between the rows. Of *Dalmahoys* last year on the bog here twelve tubers carelessly picked off the heaps weighed 14 lbs., sound, and white as snow. *Snowflake* was also good on the same ground. *Magnum Bonum* gave a good crop of inferior quality. *Mona's Pride* was also good. My favourite, the *Fluke*, I cannot grow here, although I have had tubers 14 inches long; they are always taken with disease.—ABRAHAM HUTTY, *Chirk Castle Gardens, Llangollen Road, Ruabon*.

1. First week in March. **Veitch's Improved Ashleaf*, *Myatt's Prolific*; **a seedling kidney* raised here and grown largely, being highly prized on account of its productiveness and superior flavour; **Covent Garden Perfection*, **Mona's Pride*. Soil medium; subsoil gravel. 2. First week in April. **Woodstock Kidney*, **Beauty of Hebron*, *Schoolmaster*. 3. Second week in April. **Suttons' Reading Hero*, a grand advance on our late varieties and valuable for market, **Magnum Bonum*, **Scotch Champion*. Manures and Application.—Farmyard manure is dug in all vacant ground during autumn and winter months in readiness for spring planting at the time of planting the sets. I usually find good results accrue by applying a good sprinkling of wood ashes and soot in the drills with the sets. For exhibition purposes I find *Clay's* and *Amies'* manures can be applied with good results.—J. CLARKE, *The Gardens, Brynkinalt*.

FLINTSHIRE.—1. Middle of March. *Myatt's Prolific Ashleaf* and **Mona's Pride*. Soil.—Light. 2. End of March. **Schoolmaster*, *Porter's Excelsior*, and *Rector of Woodstock*. 3. First week in April. **Reading Hero*, **Magnum Bonum*, and *Grampian*. Manures and Application.—Good decayed cow manure dug-in in the winter.—J. FORSYTH, *Havarden Castle Gardens*.

GLAMORGANSHIRE.—From February to the middle of March. *Old Ashleaf*, *Myatt's Ashleaf*, *Mona's Pride*, and *Rector of Woodstock*. Soil.—Light rich medium soil resting on gravel. 2. Middle of March. *American Rose*, **Walker's Early*, **Schoolmaster*, and *Snowflake*. 3. Middle to the end of March. **Dalmahoy*, **Pater-son's Victoria*, **Scotch Champion*, and **Magnum Bonum*. Manures and Application.—Good stable manure. In the garden it is dug into the ground previous to planting, and in the field it is spread in the drills and the Potatoes are planted upon it. General Culture.—The Potatoes in the garden are planted in drills 4 inches deep, and from 2 feet to 30 inches apart (according to the variety), and a foot between the sets. The only treatment they receive after this is to keep the ground clean by frequent hoeings and forking it between the rows previous to earthing them up. Those in the field are planted in drills 32 inches apart, and 15 inches from set to set. They are kept clear, drill-harrowed, grubbed, and finally earthed up with the plough.—A. PRTTIGREW, *Castle Gardens, Cardiff*.

1. February. **Veitch's Improved Ashleaf*, *Myatt's Prolific Ashleaf*, *Suttons' First and Best*, and *Beauty of Hebron*. Soil.—Light from choice. 2. March. **Gloucestershire Kidney*, *Covent Garden Perfection*, **Prince Arthur*, and *Porter's Excelsior*. Soil.—Medium. 3. April. **Magnum Bonum*, **Schoolmaster*, **Champion*, and *Pater-son's Victoria*. Soil.—Heavy, but medium would be preferred. Manures and Application.—Ordinary manure, composed chiefly of horse and cow droppings, such as may be had from any farmyard, is the principal manure used for Potatoes here. It is spread over the surface and dug deeply into the whole of the ground. Of artificial

manures bone phosphate is the best, but it is only placed in the drills and then no other manure is used. General Culture.—Planting medium-sized tubers whole has given better results than using small tubers, or cutting large ones into many small pieces. Having the rows too close is a great mistake. Two feet from row to row and 1 foot between the sets is not too wide for compact-growing kinds, and from 6 inches to 1 foot more is allowed the late varieties. Earthing up with a four-tined fork, opening the soil well and leaving it rough and free, is better practice than scratching up ridges with a drag hoe. The quantity may be increased by lifting prematurely to avoid the disease, but the quality suffers in consequence.—J. MUIR, *Margam Park*.

MERIONETHSHIRE.—1. End of March. Veitch's Ashleaf, *Myatt's Ashleaf, and *Beauty of Hebron. Soil.—Light, 700 feet above sea level. 2. End of March. Covent Garden Perfection, *St. Patrick, Dalmahoy, and Fortyfold. 3. Middle of April. *Schoolmaster, *Reading Hero, Magnum Bonum, and Paterson's Victoria. Soil.—Light, stony, 500 feet above sea level. Manures and Application.—Stable manure applied under the Potatoes in the rows as planting progresses. General Culture.—First early varieties are planted on south borders from 22 to 24 inches between the rows and 1 foot between each set in the rows; second earlies 3 feet between the rows and 1 foot between the sets, thus allowing room for a row of Broccoli or winter Kale between the rows of Potatoes. The late varieties have field cultivation, and are planted in rows 30 inches apart and a foot between the sets.—GEORGE COOKE, *Nannau Park Dolgelly*.

MONTGOMERYSHIRE.—1. March 15th. Veitch's Improved Ashleaf. Soil.—Medium. 3. April 12th Scotch Champion in field. Manures and Application.—Lime and soot dug and ploughed in. We only grow two varieties for household purposes.—WM. LEE, *Powis Castle Gardens, Welshpool*.

PEMBROKESHIRE.—1. February and March. Veitch's Improved Ashleaf, *Rivers' Royal Ashleaf, Walnut-leaved Kidney, and Gram-pian. Soil.—Light soil kitchen garden. 2. March. *Gloucester Kidney, Covent Garden Perfection, Snowflake, and Dalmahoy. Soil.—Medium kitchen garden. 3. April. Schoolmaster, Paterson's Victoria, *Scotch Champion, and *Magnum Bonum. Soil.—Medium farm. Manures and Application.—Manure from the stables for garden use, and farmyard manure for field crops. General Culture.—Early crops are grown in rows 2 feet apart, the sets 1 foot apart. Field crops are planted 30 inches apart, 1 foot in drills. In the ordinary way all those sorts named are good croppers and do well here. Of Scotch Champion we had a grand crop last year in the open field.—GEORGE SCLATER, *Stackpole Court*.

RADNORSHIRE.—1. February and March and April. Old Ashleaf Veitch's Improved Ashleaf, *Rivers' Royal Ashleaf, and *Myatt's Prolific. Soil.—Light. 2. April or first week in May. *Trophy, *Triumph, and Bresee's Peerless. 3. April or May. *Scotch Champion, *Magnum Bonum, and Paterson's Victoria. Manures and Application.—Good stable or farmyard manure worked in the soil in autumn or winter, and a moderate dressing of lime cast over the drills at planting time, and in covering the Potatoes the lime is mixed with the soil, and proves very beneficial. General Culture.—In planting the early and second early varieties I put about four Potatoes or sets in a yard, the rows being 24 inches apart. I always select them as near one size as I possibly can to avoid cutting. In planting the late varieties I generally put three sets in a yard, particularly of Scotch Champion and Magnum Bonum. I find that distance suits them well, and in favourable seasons I have a very good crop. I generally allow 30 inches between the rows of the late varieties.—HENRY THOMAS, *Boulthbrooke, Presteigne*.

LA GROSSE SUCRÉE STRAWBERRY.

Of several varieties tried for early forcing the above has again been the best. It is a very free setter, and invariably carries a good crop of large and well-coloured fruits. We find if ventilation is left on for an hour or two before gathering the fruits and the house is kept comparatively dry it will compare favourably with any other variety for flavour. Vicomtesse Hericart de Thury under the same treatment has been useless; we have not gathered a good fruit yet, although several plants were started in each batch. Can it be the soil that has something to do with it? as some gardeners succeed in forcing it well. Later batches are showing well, but even at its best, when early forced, the fruit is small when compared with such varieties as La Grosse Sucrée.—G. SUMMERS, *Sandbeck Park*.

HOME-GROWN LILY OF THE VALLEY.—Having tried on a small scale to grow Lily of the Valley for early forcing, I read with much interest the article by "R. T." in the Journal for March 29th. I previously felt quite satisfied with my success, now I feel quite

disappointed. Six dozen spikes in an 8-inch pot I had thought impossible from one clump. Will "R. T." give fuller details? I feel certain many like myself would feel thankful for full cultural directions from the time the roots are first lifted from the bed until the plants flower. I quite agree that home-grown clumps force easier and give better foliage if the crowns are thoroughly ripe.—A. J. SANDERS.

CARNATIONS AND PICOTEES IN BEDS.

As I before stated, October is the best month to plant these but owing to the wet autumn I for one have been compelled to let them stand over, and now for the last three weeks it has been a continued frost here. This has prevented planting in the open. Now that there are signs of a change for the better I shall, as soon as the weather permits, commence planting. In my last note I described how to plant them so as to be suitable for layering. To those who find it difficult, like myself, to perform the back-bending required in layering, I can recommend the plan started by my esteemed friend Mr. Dodwell—that is, to dig the plants up when ready for layering, place them in pots with a good ball of soil attached, and layer them in the usual way. Since adopting this plan I have found the plants root well, with fewer deaths amongst them than when grown in pots. Another thing, I have been able to get seed to ripen from the lifted plants, which I have never been able to do with plants grown in pots, where the flowers have been hybridised after layering has been done, the flowers of which always prove deaf or barren.

Ground root plants of Carnations and Picotees are invariably stronger than when grown in pots. In this case it is wise to tie each plant to a short stick to prevent them being broken by the wind, until sticks are placed to them, when they can be tied up in the usual way. The growers in the Newcastle district grow them all in beds, with the result that they have the finest flowers from the ground roots the second year. They call it growing them on the bush. Another thing, they are able to have them in flower soon enough to compete at the National Carnation and Picotee Show at Manchester.

Looking over my list of Carnations and Picotees which I grew in 1856, I find that I still grow the following in scarlet bizzares:—Admiral Curzon (Easom), Sir Joseph Paxton (Ely), True Briton (Hepworth). Mr. Ainsworth (Holland) I grew at that time, but it soon died out, the reason in my opinion being that it was raised from an unripened seed. In crimson bizzares I grew the following, which I still grow:—Lord Milton (Ely), Black Diamond (Haines); this has sadly depreciated. Jenny Lind (Puxley) is a weakly sort with me now, formerly a very strong grower. In pink and purple bizzares I still find Sarah Payne (Ward), as then, the best in its class, it being the only one of those grown in 1856 which I now grow. In purple flakes I grow the following, which I grew then:—Squire Meynell (Bubbins), Squire Trow (Jackson), Premier (Millwood). In scarlet flakes I only grow Sportsman (Hedderly), which I grew at that time, it being a flower now of the best quality, then as now one of the best scarlet flakes grown. It was a sport from Admiral Curzon, which was obtained in 1854 by Mr. Hedderly; it also sported with Mr. John Cliffe of Wortley, near Leeds, in 1855. Of late years Mr. Dodwell has also had another sport from the Admiral of fine quality, and which I have no doubt will be a telling sort in its class.

In rose flakes I only grow Lovely Ann, which I grew then. It was raised by the late Mr. Ely, and bloomed for the first time, I believe, in 1834. It was, and continued for a great number of years, the best flower in its class. Even now I consider it the best variety in its class as a seed-bearer, John Keet and Sibyl being raised from it. In Picotees I have only Mrs. Dodwell; it has, however, depreciated with me, and after several misgivings I have decided to try it another year.

I find that the greatest advance has been made amongst the Picotees, as very few of the Carnations are in advance of those sorts which have already passed out of cultivation—for instance, Admiral Curzon, although nearly forty years old, is still unsurpassed and the best flower in its class or any other.—GEO. RUDD.

FORCING FRENCH BEANS.

THE value of these is too well understood to call for any comment, while a few remarks from one whose duty it is to supply them the whole year round may not be out of place. For the autumn and winter supply we always grow them in 24-size pots. The soil we find to answer best is a medium loam with a third of dung from an old Mushroom bed. Our first sowing is made about the first week in September, the pots being half filled with the above compost and six or eight seeds placed in each. When

covered slightly with soil the pots are placed in a warm corner out of doors till the plants are up level with the rims of the pots, when they are filled to within an inch of the top with some of the same material as the seeds were sown in. This batch is then placed in the Bean pit where they are to be grown. A small stiek is placed to each plant, to which it is carefully tied as it advances in growth. This seems a small matter and somewhat fussy, but let anyone try, say, twenty pots with stieks and twenty without them. The result will prove that the extra trouble in sticking and tying will be amply repaid. After placing the early plants where they are to remain another sowing is made and placed beside them, and treated in every respect the same. Again another sowing is made every ten days until the outdoor crop is ready for use.

The pit we grow Beans in very successfully is a lean-to, rather flat, with scarcely head-room for a tall man. This pit is better adapted than would a higher structure, as it is easier kept at a given temperature and does not allow moisture to escape. To grow Beans well plenty of heat and moisture is essential. We keep up a night temperature of from 65° to 70°, with a corresponding rise by day, while on bright sunny days we often let it increase to 100° or more, with every part of the pit thoroughly saturated with water. Red spider is the greatest enemy with which the Bean has to contend, but if a bag of soot is placed in the water tank and a liberal supply given through the syringe this pest will not gain a footing. Judgment, however, must be used in this matter in the short days of November and December, or a good set will not be obtained. We find Osborn's as good as any variety for early work, while for later crops we use Sir Joseph Paxton and Williams' Prolific.—GEO. MERRITT.

HORTICULTURAL BUILDINGS—HOW TO SUCCEED.

IN gardens where quantities of small decorative plants are wanted, a good plan is to have long low pits in divisions for each set of plants. These are what we would erect if called upon to do so. Mr. Taylor says that so long as a plant can be kept moderately moist the less it is watered the better. A truer and more important fact never was written. To secure this pots should as far as possible be plunged, not only to secure this condition but also a uniform temperature for the roots, which is not of less importance. For this reason I would have beds rather than stages. Such plants thrive best near the glass; for this reason I would have low flat roofs and narrow houses with a path down the centre. If I had one such house 40 or 50 feet long for growing Cyclamens, Primulas, Cinerarias, Calceolarias, &c., I should prefer to put in a partition, and then in one end I could keep up conditions much more suitable for the Primula than the Calceolaria, and in the other a climate in which the Cineraria would not be drawn.

This is the one greatest mistake gardeners make. Anxious to grow everything good, unsuitable plants are grouped together, and then houses are voted unsuitable. Far better grow a select few, and have them well done, than a host and have nothing good. If Orchids are grown, what a mistake to grow Odontoglossums, Dendrobiums, and Cælogynes together! The chances are all will fail; then the house will be blamed. Let anyone try Apples, Peaches, Grapes, Melons all in one house, and compromise matters to suit all. You will suit none. Yet in the matter of other plants this is what is attempted. A very moderate man will grow good Hamburgh or Muscat or even Duke of Buccleuch Grapes if he has a house for each; but associate them, and the chances are he will, even though ever so clever, fail with one or other. Yet these are only varieties of one species, and the fault lies not with the erection—not even, it may be, with the cultivator—but with the selection of varieties. How much more is this the case when greatly differing species are crowded into one building!

Employers are often to blame. Knowing nothing of the difficulties of gardening they suppose success easily won. The gardener grows Azaleas better than anybody for miles; but Lord A or B's man has a Rose house, and keeps up a supply of Tea Roses all winter. So many Azaleas are not wanted. The gardener is directed to dispose of half, and to replace them with Roses. He may object. Roses must be had, and if they are not equal to my lord's the gardener is supposed not to be a "Rose man." This is no fancied occurrence. All sorts of things are wanted out of one building, and because it cannot be done employers are dissatisfied.

For special things special roof angles may be desirable, but when one set of gardeners maintain that an acute one is best for Peaches and another maintain the opposite, and both succeed, we may conclude that a degree or two makes little difference. The same may be said of Vines. My idea for both is that houses should be high enough and wide enough to give room for extended

development, and to have the roof at an angle to catch all the light possible in spring and autumn—enough will be certain when the sun shines at midsummer. For winter Cucumbers or very early or late Melons I should choose a steep-pitched roof for the same reason. For the same reason we should choose a flat one for Beans, Strawberries, and Potatoes. This may seem inconsistent, but when we remember that one class can be trained close to the glass and the other are dwarf plants plunged in pots or planted out, the inconsistency disappears.

The only really unsuitable buildings—real plant-killers—I have seen have been conservatories. I do not refer to the dark tombs built half a century ago, stone and glass, but those placed where the light of heaven is kept off by the house to which they are attached; where the roof is yards above the plants, and where the aridity caused by sunshine, often by currents from the house, dare not be counteracted by dampings to save such plants as the gas fumes have not finished, for fear of spoiling the unnatural decoration or causing a dampness.

But many young men, anxious to avoid the failures for which they see others so complacently blaming the house, and remembering the old proverb that a bad reaper never yet had a good reaping hook, may ask, "How are suitable conditions to be ascertained?" Well, experience is the teacher that has taught most, and in that school all must learn, and by very diligent application too. We learn more by failure than by success, but the experience need not wholly be our own. If we only knew what we have ourselves found out the best of us would be ignorant. We must fall back on the experience of others. Is there, for instance, one who has had remarkable success in the cultivation of any given plant? Probably he only learned success by experience, and that experience we must try to make our own if possible. Luckily that is not difficult, for men are not rare who have succeeded and who are willing to make known their experience and its results. Is it Orchids? There in small bulk is the experience of a successful grower condensed within the boards entitled "The Orchid Grower's Manual," and, though the epitomised experience of half a lifetime, may be had for the payment given for two or three days' work. Is it the experience of a thoroughly successful gardener with Grapes, Pines, Peaches, Melons that is wanted? There it is, the concentrated essence of a lifetime's experience bound up and entitled "Handy Book of Fruit Culture under Glass." Young men often grudge the price of gardening works, but they forget that it is not merely books they are buying but experience, and that for a few pounds they may obtain, not so much of a useful library as of the knowledge, experience, brains of scores of others. It is knowledge that is wanted.

But we would have our younger readers who wish to know "how suitable conditions are to be ascertained," not to trust altogether to either their own or to the experience of others, or they may often fail. In spite of the vast amount of accumulated experience embodied in garden literature—in spite of the accumulating experience weekly published in the gardening press, notably in the case of the *Journal of Horticulture*—there are many things yet that experience has not conquered. Moreover, many new plants are being yearly introduced, and in gaining knowledge of them by experience many are lost.

Our knowledge, then, must be something more than that gained by experimenting. These latter remarks are addressed to young men; indeed, in all we write young men are kept steadily in view, for they are most eager for knowledge and most apt to learn. They are in want of advice, and the wiser among them are ever ready to follow it when good. In this place a few general remarks must suffice; but in order to ascertain under what conditions a host of plants will be likely to thrive, it is not too much to say that a knowledge of botany, agricultural chemistry and geology, geography, and meteorology will be of inestimable assistance. For instance, a gardener receives an unknown plant from any given place in the world. He is told where it came from, but no more. The gardener who knows nothing of the above sciences—no matter what his mere experience may be, no matter how much of the experience of others he may be possessed of—is likely to be at his wit's end, and the chances are the plant is on the rubbish heap before long. But if he knows the latitude and longitude of the country it came from he will not err much in the temperature he gives. If he is versed in the meteorology of the place; if he knows whether it is moist all the year round or dry all the year round, or if the seasons are sometimes hot and sometimes dry, he has a guide in regard to the state of humidity required that the less well-informed man is without, and is all the more likely to succeed in consequence of his knowledge. If he has been well drilled in botany he may, even in the absence of flowers, be able to pronounce pretty accurately what the affinities of the plant are, and this may be all that, in addition to the other

points, is necessary to enable him confidently to treat his new plant in to the right conditions, and so secure success, instead of the failure which so often dogs the steps of the ill-informed man. Uniting his knowledge of botany with what he knows of agricultural chemistry, he would never think of giving a plant belonging to the Leguminosæ liquid manure rich in nitrogen, but he would give potash confidently. If it belonged to the Cruciferæ he would give phosphates; and if he won the success he deserves he can smile if the man who failed tells him that failure and success alike are wholly owing to some indefinable and imaginary peculiarity of "the house."

England was long called "the grave of Orchids." Till recently, in certain hands even yet, Orchids were killed wholesale. Why? Not because of peculiarities in the houses, but, on the confession of the most successful men, because of the ignorance of the cultivators in the matter of conditions. Want of knowledge destroyed, and destroys, shiploads of Orchids and many other plants besides.

We fall back again on this: "Knowledge is what is wanted," and of this we wish to convince every young man. Only the devoted student may ever hope to be a first-class gardener, ready to adapt himself to all sorts of conditions and to succeed in them all. Only those young men who now give up a certain portion of their time in the acquisition of knowledge may ever hope to thoroughly succeed. Too many look on the devoted student as a drudge. Never was a greater mistake. The man who devotes his winter evenings to the study of geography, garden chemistry, and the peculiarities of climates will soon feel an exquisite pleasure in the pursuit of knowledge that the haunter of concert-rooms, the theatre, or the alehouse knows nothing. He soon begins to feel that the money spent in books has been invested in a richly profitable speculation; while sooner or later—the sooner the better—those who have spent theirs in drink, tobacco, or for frivolous entertainments, will find that theirs has been far worse than thrown away.—SINGLE-HANDED.

VINES BLEEDING.

It has often been a disputed question as to whether bleeding in Vines is injurious or harmless, and anyone giving a decided opinion in the matter would no doubt be supplied with written proof that he was wrong, let his decision be which way it might. At present I do not intend to say anything definite, but I have a good case in hand now which might prove something to those interested. Early in February we pruned the Vines in a house here. At one end there is a plant of Foster's Seedling which had three main stems. To make room for a later sort one of these rods was cut away at pruning time. For a week or so the part cut remained dry, but after that the sap began to drop out of it, and for four weeks the flow was incessant. So much was this the case that my attention was attracted to it, and that an idea might be formed of the extent of its bleeding I placed a quart measure underneath to receive it. This was filled and overflowing in thirty-six hours, and there is no doubt many gallons must have passed from it. It has now stopped bleeding, and I am anxious to know what will be the result. The quantity of sap the Vine has lost is remarkable, and if any of your readers care to predict the consequences I will be glad to state the conditions of the Vine when the crop is matured.—J. MUIR.

PRUNING ROSES.

ONCE when chatting with one of your most constant and talented contributors on this subject he remarked, "If I cou'd I would prune in autumn." Well, the difficulty lies in the words "if I could." Certainly in the greater part of this country autumn pruning would be fatal, but I can well understand that if there were no frost it would be the correct thing. We must, however, if in the tailoring line, "cut our coat according to the cloth," and I feel quite certain we must, if Rose-lovers, prune them according to our localities. It may do well, as "A. C." says, to prune early at Reigate; but then Reigate has a different temperature to our Wiltshire downs. Neither do I think that the treatment that would be successful in the one would equally suit the other. To decide the knotty point a given number of similar Roses should be treated on each plan, and this for several seasons. These Roses should in all other respects be treated similarly, then a fair balance might be struck; but it is impossible to decide the point on a single season, which might have been exceptionally favourable to those pruned early or *vice versa*.

Here in Wiltshire I have frequently seen the blooms that opened early blotched in a peculiar manner on the outer petals; and a well-known nurseryman, who was judging at our local exhibition,

remarked to me that many of my blooms were touched by the frost. If this be really the case one would desire if possible—having regard simply to the production of good flowers, and not to the fact that these are required for an exhibition at such a date—to prune as late as possible, so that the buds might escape the nipping by late frosts. This year is peculiar. We had buds showing on some plants in the end of February, but since the first day or so of March we have had severe frosts almost every night, sometimes the thermometer on the ground registering 20° below freezing. All the shoots on the trees have been killed; but more, all those plants in which strong shoots were being sent up from the root have suffered in these shoots though protected in some degree by the foliage over them. These shoots have been rendered completely useless, being full of sap, and in not a few the shoot appears dead as far as the junction with the old stem. Now suppose all our Rose-pruning had been finished in February, I cannot help fearing that with the weather we have had since the 5th or 6th of March numbers of the buds that would have remained dormant would have been forced into activity and injured. The bulk of my own pruning has been done since the 24th of March, and with the check all the plants have had there is no fear of any bleeding. *A propos* of bleeding, I have often thought of having a hot iron at hand and searing the cuts. I have seen but never tried some French sort of gum for this purpose. Is such a substance of any use?

Believing that late pruning suits me best, and being anxious to lessen the chances of loss by bleeding as much as possible, I have for several seasons done much of my pruning in autumn. I have gone over all my plants, selecting on each from three to eight shoots as the best to make a head for next year's blooms, all the rest I have pruned away. By this plan I save many bleeding points, supposing the trees have made some growth in the spring, and so lessen the fears about it, and I am also able to get my final pruning completed far more rapidly than I otherwise could. I confess, too, that I do not always tie myself down to the dictum of pruning down to a bud pointing outwards. Sometimes I fancy a shoot pointing inwards may suit the appearance of a plant better, and I prune accordingly. I join Mr. Moorman in saying that I have for several years used the sécateur for pruning to the great advantage of my own hands, and I fancy without any detriment to the plants, and I agree with him the more I use it the more I like it.—Y. B. A. Z.



A FAVOURABLE change occurred in the WEATHER IN THE SOUTH OF ENGLAND on the 30th ult., when the frost winds that have done so much damage to vegetation ceased and a welcome shower fell. Since then there have been several days of spring-like weather, and the buds of Horse Chestnut and other trees have been suddenly awakened into life. Except a few very early-flowering Pears, the blossom buds of orchard fruit trees do not appear to have sustained any injury.

— WE are informed that the ST. PETERSBURGH INTERNATIONAL HORTICULTURAL EXHIBITION, announced to be held this year in May, is postponed until 1884, all the arrangements remaining the same. It is stated that this postponement has been rendered necessary by the approaching coronation of the Emperor and Empress.

— MR. S. TAYLOR, writing in reply to "Crux" relative to COCOA-NUT FIBRE AND WOODLICE, says:—"I use the refuse extensively for plunging Pines and other plants in, and scarcely ever see an insect, and having used it for nearly four years in the same houses I can venture to say it does not harbour woodlice. We have another house in which we use leaves for plunging plants in, and the woodlice breed by the thousand in them; and unless decayed leaves are wanted for soil I should advise your correspondent to substitute the fibre instead of leaves or manure. Nearly all kinds of cuttings strike readily in it."

— THE lease of the premises, 6, Bankside, London, S.E.,

where MESSRS. J. JONES & SONS, hot-water engineers, have carried on business for upwards of forty years having expired, they have secured more central and convenient premises at 42, Farringdon Street, E.C., this being the present address of the firm, and where their business will in future be conducted.

— THE Exhibition of the ABERDEEN ROYAL HORTICULTURAL SOCIETY for the present year will be held on July 19th and September 14th and 15th, over 170 classes being provided for each Show. The prizes are mostly of moderate amount, silver medals being, however, offered in addition.

— MR. P. H. BARBER, writing in answer to a correspondent who sought information about MOSS LITTER, states there are several kinds—viz., those sold by the German Moss Litter Co., the Lightning Moss Litter Co., and Versmann's Moss Litter Co. The last he thinks perhaps is the best. Being a dark colour it does not show the dirt, but of course it is there just the same, and in consequence gets very foul; at the same time it is very cold and clammy in winter and hot in summer. Being mossy stuff it absorbs the moisture. The address of the Versmann's Moss Litter Co. is 63, Queen Victoria Street, London, E.C.

— THE NUNEATON FLORAL AND HORTICULTURAL SOCIETY will hold an Exhibition of plants, flowers, fruits, and vegetables in the cricket field, Nuneaton, on Thursday, July 12th of the present year, when numerous prizes will be offered.

— WE regret to announce that MR. GEORGE SMITH of the TOLLINGTON NURSERY, HORNSEY ROAD, died on the 26th ult. at the age of seventy-one. He was a well-known florist, and has succeeded in raising many handsome varieties of popular plants, especially amongst Zonal Pelargoniums and Fuchsias.

— THE "LILY OF THE VALLEY: ALL ABOUT IT, AND HOW TO GROW IT," is the somewhat pretentious title of a very small pamphlet of thirty-two widely printed pages (W. Roberts, 170, Strand). The matter on raising, sorting, and forcing single crowns is that which is usually practised; but the writer has something to learn on the process of growing and forcing clumps, or he would not denounce it. The practice, he says, "probably has one or two good points—certainly not more, as the clumps cause a waste of space, inasmuch as rarely 50 per cent. of them flower. Therefore, for all practical purposes forcing in 'clumps' is not to be recommended." We wonder what one of our correspondents, who grows six dozen spikes from a clump in an 8-inch pot, thinks of this teaching! It is true there are spikes and spikes, but some that our correspondent has sent us are equal to any we have seen from imported clumps, and similar to the fine examples grown by Messrs. Hawkins & Bennett of Twickenham.

— AT a meeting of the promoters of the GRAND NATIONAL DAHLIA SHOW, held on March 13th, it was determined to accept the liberal offer which had been made by the Crystal Palace Company in reference to the Show of 1883; and on the occasion of the Autumnal Fruit Show of the present year (August 31st and following day), to hold an exhibition of Dahlias at the Palace on a scale at least equal to that of 1882. The Crystal Palace Company offers to provide, as before, a sum of £50 towards the prize fund if the growers and admirers of the Dahlia will subscribe a like sum for the same object; and as there are certain additional and unavoidable expenses it is imperative that the subscription list should exceed this amount. Subscriptions should be forwarded to Mr. Thomas Moore, Hon. Secretary and Treasurer, Botanic Garden, Chelsea, London, S.W., from whom, also, further particulars can be obtained.

— A PARISIAN correspondent writes:—"To the note of 'Ei-Cætera' in your issue of March 15th I might perhaps add that

BROCCOLIS DIFFER FROM CAULIFLOWERS not only by their 'degree in hardness' but even by their appearance—that is, the foliage is rather stiff and not so broad. It nearly resembles, so to speak, the paper foliage plants so well made in Paris, and has not the elegantly recurved and undulated lines of Cauliflowers, especially some broad-leaved strains. Besides, there is also a question of taste, and Broccolis have on the continent the reputation of being much less delicate in flavour than Cauliflowers. Broccoli is in its flesh somewhat granulated and strong-scented, Cauliflower is melting and creamy. But this is a matter of taste."

— THE same correspondent observes:—"In the same issue I see an answer to 'J. E. O.' about ornamental Grasses. I take this opportunity of highly recommending the Coix genus, and especially COIX LACHRYMA (Job's Tears) and C. EXALTATA. They are very elegant in a border or a conservatory when in pots, and very effective when cut to mix with flowers in vases. The plants have an average height of 12 to 18 inches, and the pearl-coloured fruits, pendulous and glittering, are very attractive. They are also much in request for chaplets and necklaces. They are most easily cultivated, being hardy in your climate. Sow the seed in hotbeds or on a sunny position out of doors, and plant out at the beginning of May."

— MR. CHAS. ROBERTS, Highfield Hall Gardens, near Leek, Staffordshire, writes:—"A few notes illustrative of the exceptional severity of the weather during the past month as observed here may have some interest. The cold set in on the 3rd of March and continued until the 29th. During the whole of that period the temperature in the shade has never risen higher than 43°, and but two nights in the month which the thermometer has not fallen below the freezing point. The lowest registered was 22° on Saturday morning, March 10th, and eight nights in the week we have registered 10° and 12°, and on twelve days snow has fallen more or less. Almost everything in the way of green vegetables in the kitchen garden is completely destroyed."

— THE charming little denizen of the Mexican hills, PINGUICULA CAUDATA, is (states the *Irish Farmers' Gazette*) "now flowering in the College Botanic Garden. It is indeed a veritable gem in its way. Fancy a compact and pretty Echeveria-like rosette of pale green leaves not larger than a florin, from the centre of which rises an elegant tapering scape some 6 or 7 inches high, curving slightly at top, and crowned with a flower as large and not unlike in form that of *Viola pedata*, and of a lovely magenta tint, and the reader will have a good idea of this lowly but truly lovely Butterwort."

— MR. ALFRED LANGLEY, late foreman in The Gardens, Acacia, Rawdon, near Leeds, has been appointed head gardener at Bedstone Court, the Shropshire residence of the Dowager Lady Ripley.

— IT has been arranged that an EXHIBITION OF SPRING FLOWERS shall be held in the Vestry Hall, TURNHAM GREEN, on Thursday, April 19th, similar in character to the very successful Exhibition which took place in the Vestry Hall in 1880 in aid of the funds of the West London Hospital. A Committee has been formed for the purpose of carrying out this undertaking, and it is intended that any profits arising shall be devoted to the funds of the Chiswick, Turnham Green, and District Horticultural Society. It is not the intention of the Committee to offer any money prizes on this occasion, but honorary awards and certificates of merit will be given to objects specially deserving. Contributions for exhibition are solicited, and space will be allotted on application to the Secretary on or before Tuesday, April 17th. The Committee announce that the most liberal support is already promised from the gardens of the Baroness de Rothschild, C. Bown, Esq.,

B. Hardy, Esq., H. Pearks, Esq., J. R. Starling Esq., Messrs. Fromow & Sons, the Royal Horticultural Society, &c. Visitors to the Show will receive tickets for promenade in the Royal Horticultural Society's gardens. The Exhibition of the Chiswick and Turnham Green Horticultural Society will be held in the Chiswick Gardens on Saturday, July 7th; the Evening Fête taking place on July 19th.

— A CONFERENCE OF CHRYSANTHEMUM GROWERS, nominated by the Committee of the Kingston-on-Thames Chrysanthemum Society, was held on Friday evening last. All the leading varieties were under notice, and some rather important decisions were arrived at. These the Secretary of the meeting, Mr. Moorman, was instructed to tabulate and submit to a future meeting for review and ratification, after which they will be published. The list of incurved varieties named in the recent election was somewhat reduced. Several so-called distinct varieties were declared to be either synonymous or so closely resembling others as to practically amount to the same thing; many varieties that have been recorded as too much alike were determined to be distinct; some names were considered fanciful, and were not recognised. In the case of synonymous varieties the name to be adopted was indicated, and the origin and date of introduction of many varieties were recorded. As an instance of the revised nomenclature, Refulgence (true) and Inner Temple were considered distinct, and the latter was recommended to be regarded as a synonym of Arigena. This is adduced as an example of the work in hand and which will when completed probably result in the compilation of a trustworthy and instructive catalogue that will be useful to all cultivators of this increasingly popular autumn flower. As much labour is necessarily involved in tracing the origin of the varieties, some time must elapse before the work suggested can be completed.

BULBS UNDER TREES.

As Mr. Richardson has drawn your readers' attention to the above subject, a few remarks as to how anyone having trees on lawns may have the ground beneath them gay all spring may not be out of place. On the lawn here we have trees of Purple Beech, Chestnut, Elm, &c., under which we planted three years ago last autumn quantities of Snowdrops, Crocuses, Daffodils, &c., in clumps, the soil being well stirred and enriched with manure and leaf soil, and the turf placed again over the bulbs. They flowered well the first season, but have been better each season since, the flowers being quite as fine as those from the newly imported bulbs, and the leaves considerably larger. I have frequent inquiries as to how we get them to live, as most people who have tried them on grass lose them in two or three years. Now the secret is in allowing the foliage to be thoroughly ripened and to die before mowing the grass under the trees where bulbs are so planted, as cutting off the foliage causes the bulbs to dwindle and die in a few seasons. As soon as the foliage has appeared above ground in spring we give frequent waterings of weak liquid manure, as the soil about the roots of large trees is very poor. I have not yet tried Hyacinths under similar conditions, but I intend doing so.—WM. PLANT, *Wood Hayes Hall*.

CARDIFF CASTLE CUCUMBER.

I AM very pleased indeed to hear such flattering accounts of this Cucumber from all quarters. Before I thought of offering it to the public I thoroughly tested its merits, and I was so convinced of its many good qualities that I told the Messrs. Ireland and Thomson, nurserymen and seedsmen, Edinburgh (the first distributors of it), that I would prefix my name to it as a kind of guarantee that it possessed all the good qualities that I stated in my description of it. After repeated trials I told them that I considered it to be one of the best varieties in cultivation, either for summer or winter work—an assertion which I am glad to say has been verified over and over again by many persons who have grown it. In answer to your correspondent "J. L.," I can assure him and others that the Messrs. Carter & Co. have the true stock of this Cucumber. They purchased all the seed I could save

of it last year; but it is quite possible that others may have saved seed from the original stock sent out by the Messrs. Ireland and Thomson, and retained my name prefixed to it as sent out at first. Large seed firms have got into the habit of late of naming varieties of vegetables after themselves, ignoring the raiser's name altogether. This I venture to say is wrong. It is confusing and misleading to purchasers, as has been aptly pointed out by "J. L.'s" note of last week.—A. PETTIGREW, *Cardiff Castle*.

IN reply to the inquiry of your correspondent "J. L.," on page 256, relative to the above Cucumber and Carter's Cardiff Castle Cucumber, whether "distinct or identical," I, as advertising it under the name of Pettigrew's Cardiff Castle Cucumber, retained the name of the raiser. But it is not unusual now-a-days for firms to attach their names to anything that is new and good. This may be excusable when they are the original distributors, but when once an article is in commerce and largely grown for twelve months, some confusion is created if another name is prefixed or substituted for that of the raiser. As to the great value of the variety for market purposes there can be no doubt. I have grown a house exclusively of it for four years, originally from cuttings kindly supplied me by my friend Mr. Pettigrew for trial, but of course I could not distribute it until it had been placed one year in commerce.—RALPH CROSSLING, *Penarth Nurseries*.

NOTES ON CERTIFICATED ROSES.

A CORRESPONDENT under the *nom de plume* of "A Young Rosarian," writing your initial article on "Certificated Roses" as far back as page 127 of our Rose Journal, asks to be initiated into the mysteries of Rose culture. Now your readers will already have formed their opinion as to whether the writer has or has not passed that rudimentary stage his humility credits him with. I am only surprised that the many interesting subjects started in his article have not been noticed, and can only account for the unusual fact by the unusually depressing weather indisposing your readers from making any exertion indoors or outdoors unless absolutely necessary. It was only last Saturday that the snow disappeared, after lying for a considerable period in our west midlands.

I regret I have only time to reply briefly to "Young Rosarian's" question about H.P. Dr. Darwin. This Rose, in my opinion, is decidedly the best sent out in 1879. H.P. Abel Carrière runs too much to wood, and does not flower with me. The more I grow Charles Darwin the more I like the Rose; but, like that old dark favourite Prince Camille de Rohan, it will not thrive where others of a similar habit do well. Charles Darwin is one of the earliest as well as the latest Roses to bloom, and is alike good as an exhibition and garden Rose. I remember George Paul, its raiser, telling me the year he sent it out that he thought it would burn less than any of the dark Roscs, and my experience quite bears out the character foretold of it in this important respect. I should, however, mention that Charles Darwin, like most very early-flowering Roses, is very liable to mildew. I will ask to continue the subject on another occasion.—HEREFORDSHIRE INCUMBENT.

[A "Young Rosarian" is undoubtedly what his pseudonym implies, and he is earnestly desirous of information from experienced cultivators.]

CLIMBERS OR ROOF-COVERING PLANTS.

HARDENBERGIA COMPTONIANA.

FOR many years this plant was generally known as *Kennedyia Comptoniana*; in some gardens or nurseries it still bears the same designation; occasionally, too, it may be seen under the generic title *Glycine*, but that given above is the one now adopted by most botanists, and is gradually supplanting the others. It matters little, however, in a horticultural point of view what name a plant bears. "A Rose by any other name would smell as sweet" is a truism which applies to this as well as to many others that possess sufficient merit to insure them a permanent place in gardens. When trained to the roof of a greenhouse or conservatory, and bearing its long pendulous dense racemes of brilliant blue flowers, the beauty of this charming Leguminous plant can be fully appreciated, especially if it be associated with climbers bearing lighter or distinctly coloured flowers, as the contrast shows it to better advantage. If planted in a border the soil must be specially prepared, a compost of peat, light turfy loam, and sand being suitable, providing good drainage, whether it be grown in a pot or border, as, like many of its relatives, it cannot endure stagnant moisture about the roots. Some care, too, is needed to keep the plant free

from insects, particularly mealy bug, which has a great liking for it. Little pruning is requisite, except to remove the old bare or weakly shoots.

The flowers, though small, are borne in such dense racemes that their size individually is scarcely noticeable. The petals, keel, and standard are bright rich blue, the last-mentioned portion of the flower having a ring of white at the base, which renders by contrast the blue colour even more intense. The racemes vary from 4 to 6 or 8 inches long, but they do not often reach the largest size, except in old established plants, and young specimens are sometimes rather shy in flowering.

Hardenbergia Comptoniana is a native of Australia, and was

introduced to this country early in the present century. The woodcut (fig. 69) represents a spray from an established plant, and well shows the chief characters both of flowers and foliage.

NOTES FROM NORTH DURHAM.

THE month of March came in like the proverbial lamb, but only retained its lamb-like character for a few days. On the 5th we had in this district one of the heaviest gales and most severe snowstorms of modern times; indeed, that much-talked-of, but seldom seen, authority, "the oldest inhabitant" of our local fishing villages and ports, did not remember having seen such

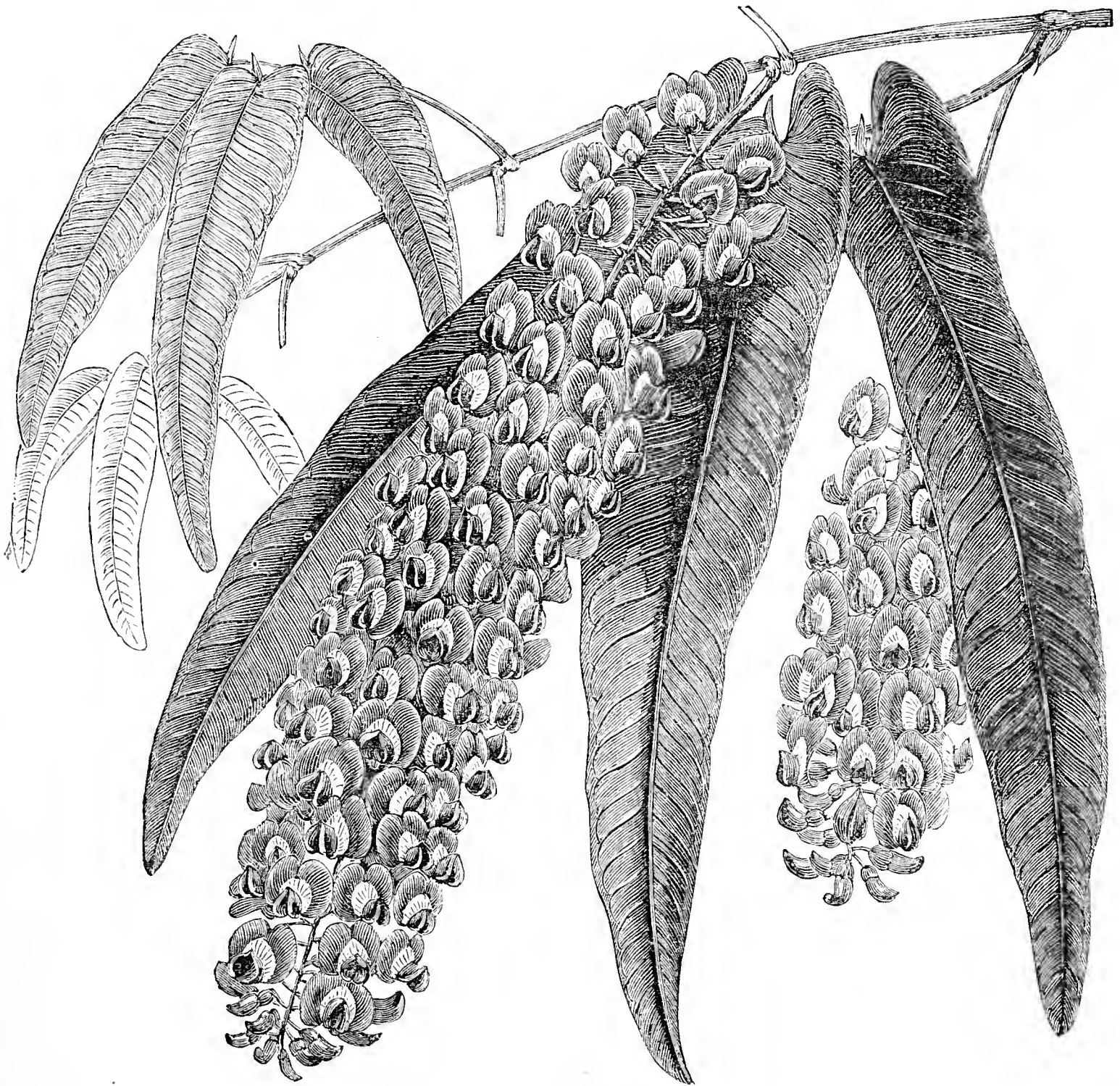

Fig. 69.--HARDENBERGIA COMPTONIANA.

weather in March. The snow drifted to such a depth that roads were rendered impassable, and remained so for some days in spite of the efforts of the local Highway Board. Every night we had from 8° to 20° of frost, and this continued until the 17th inst., when the snow ceased falling and the frost became less intense, though by no means altogether gone. The bright sunny days rapidly melted the mass of snow, except where it was drifted, and from where I write I can still see huge wreaths of snow lying on the headlands behind the hedges. After the snow went the frost returned again in all its "unmitigated barbarity," and the result has been a complete massacre of the innocent. To use a localism,

everything has "gone by the board." Since the 20th I have been confined to the house, and am only now able to look out of the window; but that is quite sufficient to justify me in believing all the woeful tales that have been daily brought in. Thousands of Wallflowers, or rather the skeletons of what were once Wallflowers, are seen in all directions. Evergreens look as if they had been singed by fire, particularly the common Laurel and Ivy; Laurustinus that were in bloom a month ago are now much injured. The tender bloom buds of Ribes are seriously damaged, and will not be so good as usual. Quantities of Myosotis have died, and even Pansies and Daisies have not escaped scot

free. How fruit and kitchen gardens have stood the shock I have no idea. Altogether it has been one of the most disastrous months ever seen in this neighbourhood, and has for slain and wounded no doubt put up the "best on record." The only consolation we have is that the last day of it is a most delightful spring day.

That usually correct correspondent, "Single-handed," seems to me to have gone a little astray in his otherwise able article on "Books and Reading" in the price of some of the books he mentions. He speaks of Williams' "Orchids," Hogg's "Fruit," and Burbidge's "Cultivated Plants" as if they were all pamphlets or shilling manuals. A book-list at hand quotes Burbidge at 15s., Hogg I think is half a guinea, and Barron is the same price; in fact, Taylor is the only shilling "manual" in the list mentioned by your correspondent. Nothing could be more disappointing to a young man than to find, after having been led to believe that he could buy Burbidge's "Cultivated Plants" for a "shilling or so," that he would have to pay more than a week's wages for it, for it really costs more than the amount that some young gardeners are receiving per week. Instead of a central library, which is a very good idea, I would suggest that gardeners could do themselves and each other much more good by forming a general benefit society. With a centre, say, in London, and branches throughout the country, which could, I am sure, be formed and worked quite as successfully by gardeners as unions are by engineers or elementary teachers. Few gardeners pass through life without being at some time or other "laid up" with sickness or out of place through no fault of their own; and many of them never have an opportunity of saving as much money as will keep them comfortable in their old age. All this sort of thing might be provided for. Then every local lodge or branch of the society might establish its own library at its meeting-room. I only throw out these remarks as a suggestion, someone may think them worthy of consideration; at all events the subject itself is.

Anent ventilation, it may interest your readers generally, and Mr. Taylor particularly, to know that an amateur in Sunderland is busily engaged perfecting an automatic ventilator, and is very sanguine of success. I cannot give any details, I only give the fact that he is doing so. He is a practical engineer and an enthusiastic gardener. I hope by-and-by to be able to say more about it.—PETER FERGUSON.

CULTURE OF THE KALOSANTHES.

THE Kalosantes is a most useful sweet-scented summer-blooming plant. It may be grown into large specimens for exhibition, or in 48 or 32-size pots for the decoration of the conservatory. The cuttings should be taken now and inserted singly in small 60-pots; place them in an intermediate temperature, when they will soon root. Transfer them into larger pots, employing a compost of two parts turfy loam, one of peat, and one of leaf soil, with a good sprinkling of silver sand to keep the soil open. As the season advances place them in a cold frame or pit, and close early to encourage free growth. Stop them twice during the season to make them bushy. In the autumn place them in a light airy house and gradually withhold water, which will cause them to form flower buds. If extra large plants are required do not let them bloom, but pinch the points out and shift into larger pots. Whilst the flower buds are opening ventilate freely, which will improve the colour. Some growers place their exhibition plants in the open air whilst the flowers are opening; but they are protected from wind and wet, and shaded from bright sun.—A. Y.

HISTORICAL JOTTINGS ON VEGETABLES.—No. 3.

RHUBARB AND SEAKALE.

IN the earlier months of the year, when tarts and puddings cannot be made from fresh fruit, there is a steady demand for the stalks of Rhubarb, which even those who are somewhat critical will condescend to eat while they are young. As the season advances these become larger and coarser, their price diminishes, and they are chiefly purchased by the poor. A youngster of a few years old may be frequently seen coming from market trailing a bundle of stalks as tall as itself. This is not a vegetable yielding any notable quantity of nourishment, but it is agreeably refreshing, though to some persons Rhubarb proves unwholesome, owing to the oxalic and malic acid it contains. One authority advises us to counteract these by taking a little magnesia after any pastry containing Rhubarb. Undoubtedly it is a slight laxative, for which reason our forefathers, fancying from its connection with the medicinal Rhubarb that it was still more aperient than it is, used

to be chary of eating it. Even the name was thought to be objectionable, and tarts composed of Rhubarb were said, rather absurdly, to be made of "spring Apples." If Rhubarb once passed thus for Apples it now sometimes does duty for Grapes, champagne being manufactured, and we may suppose approved, which is prepared from Gooseberries and Rhubarb in this country.

The ancient Greeks, as we are informed, were well acquainted with the value of Rhubarb, and the Chinese probably at an earlier date, but neither of these peoples employed it as an article of food, only as a medicine, and it was the same with those who first grew Rhubarb on our English soil. Gerard appears to have been a little confused about it, not distinguishing, perhaps, the true species from what was called "Monks' Rhubarb," the *Rumex alpinus*, brought by the monks from Switzerland or Germany. Before Gerard's time both kinds may have been grown here, and Mr. Glasspoole refers to the mention of "reuberbe" seeds in a letter dated 1534, addressed to Cromwell, Secretary of State to Henry VIII. These were brought to England from Barbary. Whether Cromwell or his gardener succeeded in rearing plants we cannot tell. Tusser puts it down as a suitable species for the herb garden, but he may have meant the "Monks' Rhubarb," substituted by these reverend adulterators for the roots of the true Rhubarb, or at least mixed with them. Nor do I much believe the story copied one from another by sundry old books on gardening, that in the sixteenth century the people boiled the entire leaves of Rhubarb and ate them as we eat Spinach. There is no sufficient evidence of any usage of the stalks until the middle of the reign of George III., or about that period; and the attempts to produce English Rhubarb in order to compete with the imported drug did not prove very successful, nor is the English root of much value at present, although we possess methods of culture far in advance of those known two hundred years ago.

Parkinson, author of several curious works upon botany, had seeds of the common garden Rhubarb (*R. rhaponticum*) in 1629, but it did not spread for a long time, even in the vicinity of London. *R. palmatum* and *undulatum*, species also grown in gardens for the sake of the stalks, did not come over until many years afterwards, and people ate Rhubarb, as stated above, with considerable caution. Mr. Myatt of Deptford, a member of a family that is historic in market gardening, might claim to have done much to bring Rhubarb into notice by his persistency in sending supplies to the Borough Market about the beginning of this century. Kent gardens and others also in Surrey or Middlesex continue to yield tons of Rhubarb annually, for this vegetable, it was found, could be cultivated near London, where choicer vegetables refused to grow in consequence of the smoke. But the builders are fast banishing even Rhubarb. I saw a patch of it growing a few years since on the last plot undisturbed of the formerly extensive market gardens belonging to the Catleughs, situate near Sloane Street, and between the King's Road, Chelsea, and Brompton Road. The progress of horticulture has displaced the old types of Rhubarb, giving us hybrids of superior texture and flavour.

Another vegetable that we naturally associate with the beginning of the year is Seakale, the appellation suggesting a maritime connection which is inexplicable to those who have not read the early history of the plant, or seen it growing on those spots where it flourishes even yet in a wild state, although it is now scarcer on our coasts than in bygone days. It is rather a curious fact, and one seemingly supported by good evidence, that the Romans used Seakale as a provision for voyages, but did not generally eat it upon shore. For this purpose, however, they cut the plants on the sandy beaches where it mostly occurs, and then stored it in barrels, with the addition of oil or spice, some think. Along the south coasts of England Seakale has been gathered by the inhabitants for many centuries, some skill being shown in watching for the right period, because after a certain stage of growth the wild plants become very unpalatable, probably also unwholesome, a bitter principle being developed during the summer. Devon, Dorset, Sussex, and Kent have been mentioned as counties to which the plant is or has been partial.

In its characteristics Seakale is precisely the opposite of the vegetable first noticed. Rhubarb is rich in acids, and this plant in alkalis, being therefore easy to digest, and, in fact, very much akin to the Cabbage tribes, though some connoisseurs think it almost equal to Asparagus. On the continent it is not thought much of, and the price with us is seldom low enough to bring it upon the tables of middle-class folk. Yet Seakale is, we think, a vegetable that might be advantageously eaten by most during the season of spring. To Philip Miller, whose "Gardener's Dictionary" names this plant in 1731, and whose memory yet lingers in the Apothecaries' Garden at Chelsea, belongs the repute of having been the first to commend it as an esculent. It was,

indeed, referred to, but very slightly, by the old herbalists Gerard and Turner. Gerard calls Seakale the "Sea Colewort," and Turner designates it "Dover-cole," because he had picked plants near Dover. Both noted the fact that the species could grow without earth amongst the sand and pebbles. The eighteenth century was well advanced before Seakale came into any market. A correspondent of "Notes and Queries" states that it was introduced to Bath by Mr. Southcote, of Stoke Fleming, about 1775, and soon after sold at Exeter for half a crown a root. Another correspondent quotes a statement that some years previously a parcel of the roots had been sent to Covent Garden Market, but, the label being lost, they were thrown aside as doubtful. Near the end of that century Dr. Lettsom, who had a garden and shrubbery at Grove Hill, Camberwell, that attained considerable repute, grew Seakale, and recommended the culture of it from his own experience. He may have prompted Curtis's pamphlet upon this vegetable, which appeared in 1822. In one page Curtis alludes to the indifference or dislike shown to Seakale whenever it had been sent to the London markets. Quite a change has taken place these recent years.—J. R. S. C.

REVIEW OF BOOK.

Choice Stove and Greenhouse Flowering Plants.
Third Edition. By B. S. WILLIAMS, F.L.S.,
Victoria and Paradise Nurseries, Upper
Holloway.

THE fact that two editions of this work have already been sold out is sufficient indication of its merits, and now a third edition has been issued to meet the continued demand. It has been considerably enlarged, carefully revised, and numerous illustrations are added which render the book more attractive and instructive. Upwards of thirteen hundred species and varieties of flowering plants succeeding either in a stove or greenhouse are described, the cultural details being both lucid and practical. It is this which renders the work of so much value to amateurs and to gardeners generally, for in the 378 pages is embodied the long experience of a most successful cultivator whose handsome specimen plants have carried his fame throughout Great Britain and the continent. The chapters preceding each division of the book upon heating, shading, soils, potting, watering, propagating, insects, construction of houses, and miscellaneous introductory matters are excellent, conveying much valuable information under their respective headings.

As an example of the method adopted we extract the following remarks upon *Habrothamnus elegans* and its variegated form, the latter being one which Mr. B. S. Williams sent out a few years ago, and which the woodcut faithfully represents.

"*H. elegans*.—This plant is a member of a very large family, and is an old and well-known species, thriving under almost any treatment. It is especially useful for covering a pillar, rafter, or back wall in a conservatory. The leaves are alternate, entire, oblong-lanceolate, about 3 inches long, deep green above, pubescent beneath. The flowers are tubular, about an inch in length, of a deep reddish purple colour, and are freely produced in dense racemes. If the flowers are artificially impregnated they produce beautiful bunches of large deep red berries, which make the plant doubly ornamental. Cuttings of this plant root with the greatest ease. It is a native of Mexico, growing at an elevation of nearly 4000 feet.

"*H. elegans argentea*.—This variety is useful alike for its beautiful variegated foliage as well as its flowers, which are the same as *H. elegans*. The leaves are soft creamy white, tinged with rose, and relieved with irregular blotches of light green. This ornamental foliage forms a charming contrast with the deep reddish purple flowers."

MOLES IN GARDENS.—Having been successful in driving moles from a garden by a very simple method, you may, perhaps, find space for it

in your valuable Journal, from which I have gained so much information. After having found the main run which the moles used I gathered as many Elder leaves, green and fresh, as I could hold in my hands, and after well bruising them until they smelt very strong I placed them in the main run, pushing them in with a small stick. I did this six years ago, and not a trace of a mole has been since seen. This remedy was told me by an old gardener many years ago, and also one to destroy wasps, which I will send another time.—H. Y.

CHOICE HARDY PLANTS IN FLOWER.

NARCISSUS.

THE Daffodils are beginning to reveal their beauties regardless of biting winds and frosts. The Hoop Petticoat (*N. Bulboc-*



Fig. 70.—*Habrothamnus elegans argentea*. Garden variety.

dium) is almost the first; and what a lovely thing it is with its narrow acute perianth segments and its huge corona of the deepest yellow! Where this thrives well it is a gem, but it is fastidious. It enjoys a stiff soil, cool and moist, and I think it does as well at the Oxford Botanic Gardens as anywhere, forming dense clumps.

The various forms of the common Daffodil (*N. pseudo-Narcissus*) rapidly succeed the preceding. The typical form is scarcely out in the cold dull climate of Cheshire, but minor is. I refer now to the true minor of Linnæus, which is decidedly distinct from

the kind usually sent out as minor, which is nanus of Haworth. The true plant is decidedly the best, although the one called nanus is pretty enough. They both nod to the earth, and the flowers are about the same size. The true minor has narrower more acute perianth segments, cup rather longer with a more rounded tube, and the leaves are rather shorter and broader, and I think the flowers are more bent to the soil—even touching it—than nanus. The latter is undoubtedly a form of minor, and was considered such by Haworth, for he also named it minor var. *conspicua*. A duplex form of nanus is also in bloom, very dwarf, with flowers rather more erect. All three are most desirable little plants and well worth growing, most easily managed, simply requiring to be planted in rich soil, and if in clumps the effect is greatly enhanced.

I have another in bloom named *minimus*, which is very much smaller, with longer peduncles; flowers slightly pendulous, about three-quarters of an inch long and not quite so wide, with a deep yellow copiously fringed cup. It is indeed a little gem, very rare but easily grown; and between this and minor there is an intermediate form much smaller than the latter but larger than *minimus*. Burbidge gives a good figure of the last in his Monograph, and he remarks that Herbert in his "Amaryllidaceæ" gives figures of two forms still smaller than the recognised *minimus*. This is so in plates 39 and 41 of that work, one of which is named *pumilus*, and is very small. It is a pity these have been lost to cultivation. Mr. Barr has a variety now in flower named *pallidus præcox*, and which Parkinson evidently had a knowledge of, and most lovely it is. The flowers are not quite so large as those of the type; the outer divisions shorter than the cup, of a pale sulphur, while the cup is slightly deeper in colour, the tube dilated at the base, smooth, with a moderate fringe. I suppose this has the advantage of early flowering over *pallidus* itself, which with me has flower stems only about 2 inches high; but we must make some allowance for the climatal difference between this part and London. Mr. Barr, however, says he thinks *præcox* has not been in cultivation in this country since the days of Parkinson. *Moschatus* is a pretty variety, distinct in form and colour; the outer divisions are oblong, rather blunt, creamy white, while the corona is long, clear yellow, with the tube fluted and the margin freely fringed. It has a strong and not disagreeable perfume. All the above are varieties of the common *N. pseudo-Narcissus* (with the exception of the Hoop Petticoat) of our woods in meadows, although distinct from each other, which has caused them to be regarded and described by the older botanists as distinct species.

LEUCOJUM VERNUM.

This is a chaste little harbinger of spring, with its pendant white flowers with green tips, most freely produced, as it is most easily suited as to soil and position, merely requiring—as far as my experience teaches—a light rich soil. I believe there is a double-flowered variety, which, however, I have not seen; but Mons. de Graaff informed me he had it in flower last year, and two bulbs were purchased from him; but I am afraid they will not gratify us with flowers this season, still it must be very pretty.

SAXIFRAGA STRACHEYI.

This is perhaps the finest of the Himalayan Saxifrages, at least, of those introduced to our gardens. It is a great pity indeed that it will not quite endure our climate without some protection, such as is afforded it by a frame; but its beautiful thyrsoid trusses of flowers are far more handsome when they expand in a cool house. I am sure it is a very excellent plant for the decoration of the cool greenhouse, while the graceful curvature of the primary and secondary branches of the spike is very effective. A very enthusiastic admirer the other day remarked that it was equally as attractive as many Orchids. So it is, but not so showy as many other Orchids. I have flowers on one spike which measure $1\frac{1}{2}$ inch across, pure white, with red glistening discs and red stamens. I have never yet succeeded in seeding it, but am trying again this season. *S. thyrzanodes* is new to me, having been sent, I believe, into this country by that indefatigable cultivator Herr Max Leichtlin of Baden-Baden, and it is quite distinct from any other kind I am acquainted with. The leaves are very large and covered with long hairs. Flowers in dense heads, clustered, with the ramifications but slightly curved, not quite so large as those of *Stracheyi*, but very fine, pure white with red stamens. It is very floriferous, and, like the last species, requires slight protection.—CESTRIAN.

ROSE WILLIAM ALLEN RICHARDSON.

IN reply to an inquiry by "A Young Rosarian," page 128, I give a short account of the above Rose. It was first distributed

in 1878 by Madame Ducher at Lyons. The growth is very vigorous, with long branches, much resembling the variety *Rêve d'Or*, with a dark glossy foliage. It bears at the tips of its branches trusses of lovely flowers of moderate size, and of a deep clear orange yellow outside. Under glass the colour changes to reddish orange. I do not know any Rose of that peculiar colour. The plant has to be well protected against the cold and frost in spring. All our Maréchal Niels and Noisettes are killed by only 10° Reaumur of frost.—HEINRICH SCHULTHEIS, *Steinfurth-Nanheim Hessen*.



HARDY FRUIT GARDEN.

Spring Pruning.—So frequently has it been attested that newly planted trees must remain unpruned till spring, that the practice has probably been adopted by many of our readers. To such the time has come for action, and a little advice will serve to help many a hesitating beginner. Pyramidal trees often come from a nursery with 2 or 3 feet of the bottom part of the stem bare of branches, and this is the case not merely with trees one year from the graft, called maidens because they have never been pruned, but of trees three or four years old, said to be in a fruiting condition and proportionately costly. In either case the upper part must be sacrificed for the sake of the future tree, and the stem severed at 2 feet from the base if the bark is hard and the buds unlikely to burst freely into growth, as is often the case in trees that have been crowded together in nursery rows till they have become almost unsaleable; but the soft bark and more prominent buds of younger trees admit of the stem being left 6 or 8 inches longer. We have so treated hundreds of young trees of Plums, Pears, Apples, and Cherries, and have never known them fail to make a free strong lateral growth from the union of stock and scion upwards.

Dwarf-trained trees must be pruned in accordance with the form they are eventually to take. Peaches, Nectarines, Apricots, Cherries, and Figs are all best of the ordinary fan shape. If they are maidens with single stems cut the stem asunder at the fifth or sixth bud from its base; but if they are a year older shorten according to their strength and position, taking care to leave the lower branches longest. For example: if a tree has three branches on each side, if the bottom ones are shortened to 2 feet the next two should be pruned to 18 inches and the top pair to 1 foot, in order to maintain an equal distribution of vigour.

Palmette verrier is the best form for large trees of Pears and Plums on walls and fences. The stems of maidens must be pruned to three buds, or four if either of the bottom buds appear doubtful, the object being to secure a pair of side shoots yearly till the tree fills its allotted space. Older trees with side branches must have them shortened in a similar manner to other dwarf-trained trees, and the central or stem growth shortened to three buds above the upper pair of branches.

Cordons of a year old from the graft must be shortened to about 2 feet from the base. If older, they are shortened more or less as the general appearance of the tree requires; more, if the stem is not well furnished with spurs, or the tree is weakly; less, if it is robust and well furnished with lateral growth.

Standards must have the young growth shortened to 16 or 18 inches, and thinned if necessary, five or six shoots being enough to form the main branches of the largest trees. Prune every shoot to an outer bud in view of forming a handsome spreading head, and examine the supports of each tree as you prune it, for it is important they should be carefully secured till the roots are well established in the soil, both for the health of the tree and its subsequent appearance.

Bush trees may be shortened in proportion to their strength, 2 feet being a safe maximum length. If they are intended to have dwarfed closed pruned branches more may be retained than if the growth is to be eventually left unpruned like a standard. In either case keep the centre clear of growth, so as to admit a free play of light and air among the branches. Some sorts of fruit are of such a close erect habit of growth as to be quite unsuitable for bushes, and require much care in pruning every main branch to an outer bud, and in training while the growth is young and pliant. To do this well requires much care and watchfulness, but with this there is no reason why every kind may not be trained perfectly to whatever form taste or fancy may suggest.

If by any mischance Raspberry canes were planted unpruned in the autumn, at once shorten them to 18 inches.

FRUIT FORCING.

Figs.—The Fig is a gross feeder, and making roots very rapidly, yet caution is necessary in the application of stimulants in dull sunless weather, even to plants in pots. In houses which are close and low, therefore unfavourable to the drying of the foliage, syringing should be practised between 1 and 2 P.M., and if done thoroughly red spider will not increase much. All watering in dull weather should be done early in the day. Attend well to thinning and stopping side shoots, as these, in the production of the second crop of fruit, will repay the attention given in the formation of spurs. Train all leading or terminal shoots forward where there is space to fill, and ventilate carefully on all favourable occasions, avoiding too high a night temperature, which may be kept at 60°, a few degrees higher in mild weather, and a few degrees less on cold nights, with a rise of 5° to 10° from fire heat by day and 15° to 20° from sun heat, giving air at 75° and closing at 80°. Trees growing in inside borders in succession houses should be encouraged to make surface roots by mulchings of half-decomposed manure, supplying water copiously, and keep the mulching constantly moist. Syringe twice on fine days, stopping and training as the growth proceeds, following the semi-extension system if space admits and fine fruit be a primary consideration. Stop young plants intended for culture in pots when about a foot in height.

Cherry House.—Attention will now be required in tying-in those shoots where it is considered advisable to reserve them for supplying any deficiency. Syringe the trees freely twice a day in fine weather, but once only in dull weather, and then early. The syringing should be done regularly until the stoning is completed, but immediately this is effected the fruit should be kept dry to prevent its cracking; and to prevent too dry a condition of the atmosphere available surfaces about the house should be sprinkled occasionally—no fear of injury resulting from dampness if the house be properly ventilated above 55°. See that there are no insect pests on the trees, as it is of the greatest importance to insure a crop of the finest description that the trees be perfectly clean before the fruit commences ripening. Aphides are best destroyed by fumigation, which must, however, be done moderately on the evening of a calm day, being careful to have the foliage dry. When the fruit commences the last swelling the border should be well supplied with water or liquid manure as necessary, trees in pots requiring special attention in this respect. The temperature at present may range from 40° to 45° at night, the heat being turned on early so as to have the temperature 50° by 8 A.M., admitting a little air at the top of the house at 55°, increasing it to 60°, and this is reduced by degrees, taking it off at 55°. In sunny weather abundance of ventilation should be given both at the top and front of the house, the temperature not being reduced below 70°.

Vines.—Late houses started early in February will now be making rapid progress and will need the final disbudding, stopping, and tying before the young shoots reach the glass. Where space admits stop them two or three joints beyond the fruit, and allow the first laterals to fill all vacancies. The shoots, however, should be trained sufficiently wide apart to admit of the full and even development of the foliage, and its due exposure to light and air. Give inside borders a thorough soaking with tepid water or liquid manure, and secure as much sun heat as possible by early closing. Muscats in flower should have a rather high and dry atmosphere to insure a good set, but a too dry condition of the atmosphere should be guarded against by damping available surfaces occasionally in bright weather. Carefully fertilise the blooms with a camel's-hair brush at a high temperature after the bunches come into flower, and reduce the strain on the Vines by the removal of the surplus bunches. Grapes in the early house now in their last swelling should have a final examination, and if any of the bunches are likely to bind take out a few of the least promising berries. When the Grapes begin to colour gradually reduce the moisture, giving air liberally by day and night, but close for a couple of hours in the afternoon, with sun heat to secure the proper swelling-off of the berries, afterwards admit air for the night, a circulation of rather dry warm air being essential to high flavour and good finish.

THE FLOWER GARDEN AND PLEASURE GROUND.

Choice Annuals.—Seeds of these sown at once will give a number of plants, which, if properly treated, will surpass those sown much earlier, these being almost certain to experience an injurious check before they can be finally planted out. The most important are Asters and Stocks of sorts, Phlox Drummondii, Dianthus, single

and double Zinnias in variety, French and African Marigolds, choice Eschscholtzias, Godetias and Clarkias, annual Chrysanthemums, Portulacas, Tropæolums, Sunflowers, Tagetes, Helichrysums with other Everlastings, and ornamental Grasses. A mild hotbed is most favourable for the germination of the seed, which may be either sown on finely sandy soil disposed to a depth of 4 inches over the surface of the bed, or in boxes, pans, or pots of similar soil. In every case the soil should be made firm and well moistened prior to sowing, and the seed must be scattered thinly, pressed into the soil with the back of a spade or other smooth hard substance, and be only just covered with more of the fine sandy soil. If darkened with mats, paper, or other material to hasten germination this should be removed directly the seedlings are visible, and a light shading substituted during clear days. Give air moderately at first, afterwards more freely, and prick out the seedlings into sifted soil on other beds, or in boxes or pans, before they are much drawn. Plants thus obtained can be readily transplanted, and soon become established in their flowering quarters. Golden Pyrethrum and Perilla nankinensis may yet be sown either in pans or boxes, or broadcast in a frame on a slight hotbed. In the former case it is generally necessary to prick out the seedlings into boxes or frames, the Pyrethrum about 3 inches apart each way, a less distance sufficing if sown late, or if required for carpet beds.

Ricinus and Japanese Maize may now be sown, the former singly in 4-inch pots, and the latter singly in pots a size smaller, this being preferable to sowing thickly. Both kinds germinate quickly in a moist heat, and the former especially should in the early stage of growth be kept near the glass, otherwise they become drawn and weakly. Both are effective yet cheap ornamental-foliaged bedding plants, and suitable either for groups, back rows, or for dotting among dwarf-growing bedding plants. Mignonette and Sweet Peas are generally in great demand for cutting purposes, and if a small quantity of seed be sown thinly in 3-inch pots, placed on a shelf in a cool or moderately warm house, or in a frame till germinated, the seedlings being thinned out in the case of the Mignonette to about three in a pot, hardened off, and eventually planted in a warm mixed border before becoming much root-bound, a considerable gain will be effected. Both kinds should also be sown in the open ground, but most other annuals may well be kept out of the ground till it becomes warmer.

Pricking-out Seedlings.—Lobelias, Ageratums, Antirrhinums, Pentstemons, Cineraria maritima, and Petunias when large enough to handle should be pricked out in pans, boxes, or beds of good fine soil, allowing space in each instance to admit of their being finally transplanted with a small ball of soil about the roots. Dibble them in up to their seed leaves, taking care to properly fix the soil about the roots with the point of the dibble, give tepid water through a fine-rose pot, shade from bright sunshine, and keep them close until re-established. Seedlings of Chamæpeuce, Centaureas, Dahlias, Eucalyptus, Grevillea robusta, Solanums, Acacia lophantha, Polymnia grandis, Ferdinandia emincns, Cannas, and other subtropical plants may be potted off singly into 3-inch pots. Wigandia and Nicotianas should be pricked off into pans or boxes, and potted later on. All should be kept growing, and many, according to their vigour, will require a liberal shift, or they soon become stunted.

Various.—Old roots of Dahlias placed in heat will have pushed up several growths, and these when about 3 inches long may be taken off with a heel and easily struck in a not over-moist heat; or cuttings can be made without heels, providing the growth is not hollow. The old stools can later on be divided, each division having a shoot and a tuber attached, and be potted off singly into 6-inch or 8-inch pots. With Dahlias one strong growth is preferable to two or more weakly ones, and by putting out well-rooted plants an early start is made. The tuberous-rooted Salvia patens may be treated very similarly, the tops and side shoots striking readily in heat, and soon form strong plants. Take out the points of autumn-struck shrubby Calceolarias and Gazania splendens, and should the stock be too small these tops can be struck in heat. Coleuses, Ageratums, Lobelias, Heliotropes, Koniga, Verbenas, Iresines, Alternantheras, and Pelargoniums now strike quickly, and the tops of each newly struck plant should be taken off when large enough to form cuttings. Potting or boxing-off is generally performed when topped plants are breaking, as at this stage the least check to the growth is given. Old stools of Cannas started in heat may be split up, every crown if potted and kept in a little heat soon growing to a good size.

With a view to preparing Zonal Pelargoniums for the beds in the flower garden advantage should now be taken of the mild weather to transfer them to the cold frames, so that the plants may be gradually hardened off and not receive a check when the bedding time arrives.

THE BEE-KEEPER.

THE ART OF BEE-KEEPING.—No. 9.

(Continued from page 185.)

SECTIONS.

THE so-called sections now so generally used for the storage of surplus honey in the comb are of various sizes and styles of manufacture. Those most used run from 1 lb. to 2 lb. sizes. Some are sent out by the makers in pieces for nailing, others with the ends dovetailed ready to go together without nails, and others in one piece for folding, the only joint being dovetailed. Which of these is to be selected by the bee-keeper must depend on circumstances. If certain sizes are preferred in the market, of course these must be worked; and hitherto the 1 lb. size seems most in favour. We prefer the larger sizes as being in the end less costly, requiring less handling, and turning out fully more weight per hive than the smaller sizes.

In all cases we prefer nailed or dovetailed sections to folding ones, notwithstanding the craze that exists for the latter as an ingenious piece of work. We never yet found one-piece sections that would stand uniformly square and remain so, and both for nice packing and glazing it is necessary that they be truly square. But their worst fault is in the slit that affords a passage to the bees. In the 1 lb. sizes this slit is nearly the full length of the top and bottom bar, and is less objectionable; but in the larger sections it is no longer, and it thus leaves more or less of the top and bottom bars in contact, which causes the death of many bees while handling them on the hive. Then, in, say, a 7-inch section with a 4-inch slit, the bees feel hampered for passage ways, and consequently leave more holes through the combs. But the worst fault is in the trouble required in glazing the finished sections. The slit has to be cut out to the whole length of top and bottom bar before the glass can be got into its proper place; and to do this with wood at all cross-grained is not so easy. Dovetailed or nailed sections may be a trifle more trouble to put together, but this is more than counterbalanced by their superior advantages. They can be easily set square, they afford the full passage way to the bees, and they can be glazed without the least trouble.

Our next difficulty is in selecting the best form of case for holding them while on or in the hive. Figure 58, page 413, May 29th, 1879, shows as good an arrangement as we know of for holding the sections when being worked either in the hive proper or in a similar hive used as a top storey. The frame as shown contains four sections, each measuring $6\frac{1}{2}$ by $4\frac{1}{4}$ inches, holding when filled $1\frac{1}{2}$ lb. In using this size of section in the new standard frame the top bar may be omitted so as to keep it level with the other frames, and lugs must be nailed on the top of the side bars to form supports.

We may here point out an objection to the use of the above form of frame, which applies also to various forms of the racks or trays for holding sections in supers proper. If the combs are expected to be well fastened to the bottom bar, and, indeed, to have no passage left, the bottom bar must be very thin. As a rule the section wood is thin enough, but a glance at the figure shows that it is doubled in both rows of sections by standing, as it does, on another of equal thickness. In such cases the holes left in the comb for passages are generally pretty large and numerous, reducing the calculated weight of the sections, and spoiling their appearance. To get the best results, then, the sections should have nothing under them more than supports at their ends. As formerly stated, we never had more perfectly finished combs than when the bottom rails were of thin glass.

Figure 59, same page as above, shows the arrangement we find most convenient. The sections rest at their ends only on ledges a quarter of an inch deep. The slip between them, and the corresponding ones at the sides, are for the support of the tin separators, and their height is calculated according to the thickness of the wood in the bottom bar of the section. Thus, for sections one-eighth of an inch thick we add one-quarter of an inch for a bee passage, and this gives three-eighths of an inch as the height at which the separator should be supported. An equal passage is of course allowed at the top. A stronger form of tray is made by having the sides all round of a uniform depth, say 2 inches, and having the separators cut away at the ends, so that they hang on these sides to the proper depth. The central division may be done away with without much inconvenience, and the sections brought close together in the middle. We do this with the larger sections, measuring 7 inches by 5 inches, so as to bring the two within 14 inches the width of the most common stock sized sheets of tin. And in the case of 1 lb. sections we have two supporting rails, so

as to hold three sections in a line. As these measure usually $4\frac{1}{4}$ inches each, we have $12\frac{3}{4}$ inches as the length of the three. This will allow of four supports for the separators of fully one-quarter inch each in width and yet be within the same 14 inches.

Where a nice flat finish in the combs is no object, as when the honey is to be used at home or crated for market without glass, the separators may with advantage be omitted. They certainly hinder to some extent the work of comb-building by breaking up the cluster, and they tend to produce thinner combs.

It is to be understood, of course, that the section tray may be of any size, though generally used large enough to nearly cover the top of a standard hive—that is, to hold three rows of 1 lb. sections, seven in each row, or two rows of the larger sizes. The end sections are closed with glass, and a wedge keeps all firmly together.

The only other matter of importance in their preparation is to see that each section has a guide of comb foundation fastened exactly in the middle of the top bar. The foundation used for this purpose should be of the very thinnest and clearest obtainable. We now use for this purpose a special make, having four and a half cells to the inch—that is, neither worker nor drone cell. Last season's experience almost warrants us in declaring it the best super foundation yet made. In no case was it used for brood, and in every case it was readily accepted by the bees. To those who hesitate to dispense with the old-fashioned honey board between the super and the brood frames, or the newer invention of queen-excluding zinc, both of which are a great hindrance to the bees, such a make of foundation should prove a great boon. To obtain the full advantage, however, it should be used large enough to nearly fill the section, otherwise drone cells might be built below.—WILLIAM RAITT, *Blairgowrie*.

DANGERS AND DIFFICULTIES.

THE severity and continuance of the frost and cold weather have made bee-keepers anxious about their bees. Such anxiety is pretty general, and not to be wondered at. Earnest inquiries are made by apiarists on all hands as to what probable and possible injury has been done by the severe frost and cold weather in our apiaries. Like others we have had, and still have, grave fears as to the injuries done to bees by the frost at this very unseasonable time. The danger most feared is that of chilled brood—in other words, unhatched brood chilled to death in the centre of stock hives. Dead or chilled brood soon becomes foul; and a little of this in the centre of a hive at the beginning of April would be disastrous in the extreme, for nothing excepting the loss of queens is so discouraging to bees and disappointing to bee-masters as foul brood. The presence of foul brood in a hive of bees puts an end to all prosperity. Strong hives well covered are seldom hurt by the severest of our winter storms, but winter storms in the breeding season are far more dangerous; the difficulty, as already indicated, is to keep the brood warm enough.

Another danger at this season is the loss of bees by reason of age. Bees die at the age of nine months, and many arrive at that age and die in April. Last autumn in England bees ceased breeding at an early date, and comparatively few were hatched later than the end of July. Dead bees may now be found on the bottom boards of hives, and, if these be swept off, the boards do not remain clean long. No treatment could prolong their lives. This is the case every year; but in ordinary seasons more bees are born than die, and therefore during the spring months hives become numerically stronger; but in cold seasons, such as the present one, bees are so discouraged and so unable to attend to brood that they decline to set eggs, and hence hives become naturally weaker and weaker, and many collapse entirely. Many hives in this country are exposed to this danger at the present time, having few bees and no brood. Some five or six years ago we had a long cold spring—so cold that bees could not be tempted to leave their nests for food offered to them. Breeding did not begin till the end of April, and in many hives all the old bees died before young could be hatched. In some apiaries all the hives were lost, in others four and six out of eight hives died—not from want of food, but loss of bees. It was a year of great loss and extinction of hives owing to the non-production of young bees in spring to take the places of those which died of age.

At this time (now that the weather has become more temperate) all hives should be examined in order to ascertain which will survive and which are likely to succumb. A short time ago the readers of the Journal were told that hives with only two seams of bees in March are more likely to die than to live; and all stocks which are reduced to two seams of bees now are in greater danger of extinction, because the living bees are a month nearer their end than they were in March, and, moreover, it will be three weeks before eggs set now can be hatched. All weak hives have

great difficulties ahead. The skill of bee-masters will be tried in saving all his stocks. Hives with only two seams of bees should be united to other weak stocks. Far better is it to have one stock likely to live and do well than two or three likely to die even under good nursing. The process of uniting bees at this season of the year is simple, and can be done in the apiary in the warmth of mid-day sun, or in a room of the house by candlelight. In uniting bees in cold weather the summer and autumn process of driving them is not followed. In cold weather bees are loth to leave their warm quarters and run over cold combs into empty hives. Hence the drumming process is dispensed with, and the work is more easily and speedily done otherwise. A little warm syrup is sprinkled over the bees to be united; about ten minutes after they have had the syrup they will be found setting loosely over and amongst their combs; then the bees to be surrendered are easily shaken out of their hives and united to the others. As we do it the work does not occupy more than half a minute. With straw hives, the combs of which are fast enough, we shake the bees by one or two sudden jerks into the other hive or on to its board, and place the hive on the board. Bees thus united seldom, if ever, fight in spring. We do not remember ever having made an unsuccessful effort to unite bees. With bar-frame hives the bars of combs with bees attached are lifted out one by one, and the bees swept from them into the other hive by a hand brush. The sooner such unions are made the better; and the sooner bees are induced to recommence breeding the more likely are they to survive their weakly condition and do well. By the time one hatch of brood is produced the weather will be warmer, brood will require less heat from bees, and larger sheets of brood will be produced. Meanwhile all hives should be warmly covered, regularly fed, and every attention given to them; and if chilled brood be found in any hives it should be cut clean out and burned or buried, and fresh sound combs fitted in the places of the combs cut out. It is easier to do such work than to describe how it is done.—

A. PETTIGREW.

TRADE CATALOGUES RECEIVED.

Vilmorin, Andrieux, & Cie, 4, Quai de la Mégisserie, Paris.—*Catalogue of Seeds.*

Jules de Coek, Ledeborg, Ghent, Belgium.—*List of Palms.*



*** All correspondence should be directed either to "The Editor" or to "The Publisher." Letters addressed to Dr. Hogg or members of the staff often remain unopened unavoidably. We request that no one will write privately to any of our correspondents, as doing so subjects them to unjustifiable trouble and expense.

Correspondents should not mix up on the same sheet questions relating to Gardening and those on Poultry and Bee subjects, and should never send more than two or three questions at once. All articles intended for insertion should be written on one side of the paper only. We cannot reply to questions through the post, and we do not undertake to return rejected communications.

Books (J. S.).—We are obliged by your letter, which is just such as we expect to receive, and do receive, from thoughtful men. Everything you have said shall be borne in mind. If we published everything we receive we should inevitably subject the writers to criticism of a kind from which they would be glad to be relieved. At the same time we endeavour to insert all letters that contain matter that can be profitably discussed by our readers. We shall be glad to hear from you at any time, and in anything we publish we will take care you are not subjected to unfair criticism.

Tubs for Orange Trees (Mac).—Pitching the tubs inside will not injure the roots, neither would Stockholm tar—not coal tar, and both will preserve the wood. The latter would perhaps be the more convenient to apply. It is quite contrary to our custom to recommend any particular kind of hives for bees.

Pettigrew's Cardiff Castle Cucumber (Old Subscriber).—It has been frequently advertised in our columns, and is referred to in our present issue.

Potatoes (C. R., Stafford).—We are obliged by your note, but it reached us too late for publication in the section in which it ought to have appeared, and cannot now be included in the lists. Had we received it in time it would have been readily inserted. We shall be glad to have a note from you at any time, and except under such special and unusual circumstances as in the present case it is sure to be published.

Cropping Vines (Mount View).—A fair crop for your Vines, so far as we can understand their condition, would be about 1½ lb. to each foot run of rod; they may perhaps, however, carry 2 lbs. We have seen 3 lbs. finish well to each lineal foot of stem, but the Vines were very healthy and vigorous. A profit

can be made by Grape-growing by persons who grow them for market solely, and know what varieties realise the best prices at a given time, but amateur cultivators seldom find them particularly remunerative. The laterals should be 18 inches apart or thereabouts up each side of the rod, or a space of that distance between them on both sides; 9 inches apart is decidedly too close. The best Grapes that are grown in Sheffield have the laterals 18 inches apart, more or less, as no one can have them at the exact distance.

Inarching Rose (R. G. M.).—You may inarch at any time when the growths on both plants are a little firm—that is, not succulent, cutting a long and rather deep slice from the shoots to be united, binding them together and covering with moss or grafting wax. You may cut down the *Marechal Niel* as low as you like, perhaps the lower the better, provided (and this is important) that there are healthy buds for starting into growth. We cut down the growths of a plant after flowering to the base of the rafters every year, and young shoots issue and cover the roof the same season, giving quantities of fine blooms the following spring.

Application of Potato Manures (S. S.).—The rule for all artificial manures is to sprinkle them evenly in the drills at planting time. Such a mixture as you refer to should be applied at the rate of about 1 lb. to 8 yards of a row, the rows being from 26 to 30 inches apart, which is the usual width for field Potatoes. If part farmyard manure is used the nitrate had better be left out till the Potatoes are ready for hilling-up, otherwise half should be given at planting time and half afterwards. The reason for this is that nitrate salts, being very soluble, are liable to be washed away before the plants can utilise them. On your porous subsoil sulphate of ammonia would probably prove more effective than nitrate of soda. Light warm soils, especially in the southern counties, are apt to be poor in nitrogen, and this should be borne in mind, especially when land is not "in good heart" as it is termed. Any seedsman or dealer in horticultural requisites will procure, if he does not keep in stock, any of the manures you mention. It would be unfair for us to name any particular dealer, and consequently, as we have many times stated, it is contrary to our rule to do so.

Marechal Niel Rose (M. H. B.).—Both cutting off the leaves and using the oil stove may have caused the young foliage to fall, these stoves when highly heated being injurious, while cutting off any great quantity of fresh foliage at once would certainly check the action of the roots and the flow of sap into the branches. We think you must have erred in defoliating the tree to the extent that your letter indicates. All you can do now is to apply tepid liquid manure to the roots, and maintain a healthy gaseous atmosphere in the house, syringing the plant early in the afternoons of bright days, when the house should be closed. The right time for syringing and closing can only be determined by the weather, but it should be done in time for the temperature to rise to 80° afterwards, and in order that the house and plant may be fairly dry before nightfall. No shading whatever will be needed—at least until the flowers commence expanding.

Shading Greenhouse (Harborne).—There are too distinct methods of shading—namely, portable in the form of roller blinds; and permanent by applying a mixture to the glass. We prefer the former, but the latter answers very well for large houses and various plants, such as Ferns, Palms, and Camellias. For flowering plants we employ light canvas blinds, and only use them when the sun is bright. The best mode of affixing the blind is undoubtedly, in our opinion, on a light iron framework a foot above the glass. The plants do not become "drawn" under such a shade nearly to the same extent as when the material rests on the roof; still with attention and judgment the latter plan answers very well. A very good wash for applying to the glass is made as follows:—Ingredients: 1 lb. of wheat flour, half pound of whiting, and 1 lb. of common candle or Russian tallow. Make the flour into a paste, and then put in the candles while the paste is hot, crush the whiting into a powder, mix with cold water, and then add to the paste, also adding as much Brunswick green as you need. When required for use warm it in a pail and paint the glass when the sun is shining upon it.

Marechal Niel Rose Unsatisfactory (H. T.).—Your plant which has made such extensive growth, and only been planted eighteen months, is evidently overtaxed. A bloom at every joint of one shoot alone 30 feet long, to say nothing of the other portions, amounts decidedly to a too heavy crop for a young plant. We should have shortened the growths considerably, and next year you would have had powerful root-action and a healthy permanent plant. The resources of the roots will now be directed, and wisely so, to the four young growths at the base. These you had better encourage, and the parts now producing flowers cut away as soon as the blooms have faded. You will do well also to apply tepid liquid manure to the roots. If the young shoots had not started we should have advised you to cut your plant down now, with the object of inducing the production of basal growths. You are fortunate in having them, and perhaps some of the blooms may also expand as the weather improves. Mildew occurred in the cool division of your house because the temperature was favourable for the germination of the spores. It is often very troublesome in Heath houses.

Laced Polyanthuses (G. R.).—We state again what we have probably stated fifty times before, that we know of no material so unsuitable for packing flowers in as dry cotton wool. You would have been surprised if you had seen the withered condition in which your flowers arrived. If a little moist wool had been tied round the stems, and the packing had consisted of a portion of a Cabbage leaf or Spinach, they would have reached us as fresh as when cut from the plants. So far as we can judge they appear to be very good border flowers, the body colour being rich and the lacing prominent, but this is too feathery, not sufficiently defined for the standard of merit of the florist.

Muscat Vines (A Subscriber).—Your Vine appears to have done extremely well, and there is danger in over-cropping it. You did not state the length of the rod; however, if you estimate the Grapes at 1½ lb. per foot run of rod that weight will be ample to leave on such a young Vine. The laterals, or side shoots, should be about 15 inches apart on each side of the rod, those not required to be removed. Still if they are very numerous only remove two or three a day until the proper reduction is made. You are doing quite right by stopping as you state. Continue the practice of pinching to one leaf, as it is made from this time throughout the season. It will do no harm whatever to the Vine, but probably good, to train the growth along the back wall; but you may stop the shoot at the top of the rafter if more convenient. We do not sufficiently know the circumstances of the case to speak more positively on this point.

Home-grown v. Foreign Lily of the Valley (C. W.).—Acting on your second letter we do not publish your first. No doubt the imported clumps to which you refer were fine, but we doubt if they excelled the home-grown examples of "R. T." You describe clumps with "three or four dozen of euor-

mous spikes," while our correspondent states that he counted "over six dozen in an 8-inch pot." We have seen spikes grown by "R. T.," and if you can have samples sent to us from the grower to whom you refer we will tell you which are the finer.

Marechal Niel Rose Withering (*E. Mason*).—We have never had so many inquiries relative to the failure of this Rose as during the present week, and we are not sure that you do not indicate the cause of failure in more than one case. Alone of those who have sought information you say your Rose is planted in an outside border and the stem brought within the house like a Vine. If this is so in other instances where the growths have withered we have no doubt whatever as to the cause of the injury. It is the action of the late severe frost and extreme cold winds on the exposed stem chilling and checking the flow of sap. No injury might result so long as the plants remained dormant, unless the frost was unusually severe, but after the sap commences to flow even a slight frost is liable to do injury when the stem is exposed. We have known a valuable plant killed by frost in this manner, and have seen Vines seriously injured. All stems both of Vines and Roses grown in the manner indicated should be encased in haybands at all times, and especially should the coverings be made effective at the commencement of growth in the spring.

Pruning Azaleas (*E. B.*).—As a rule these plants need but little pruning, and all that is required can usually be done with the finger and thumb. This appears to have been your practice, but you have commenced pinching too soon. When the flowers fade they should be picked off to prevent the formation of seed pods, but the growths starting from the base must be carefully preserved. If the plants grow quickly and vigorously the young shoots, or the strongest of them, may be pinched when about 2 inches long. If this is done early in the season the succeeding growths will have time to mature and form flower buds. Weak shoots must not be pinched at all, or the plants will not flower freely another year. You certainly did wrong by pinching the growths in the manner you state; only exceedingly vigorous plants could endure such close pinching without injury.

Potatoes (*W. J. P., Lancashire*).—It is most difficult, if not impossible, for anyone to name Potatoes from half a dozen tubers. You sent five tubers, and they have been very carefully examined. Our opinion is that three of them are Mona's Pride, and the other two resemble Myatt's Prolific. Mona's Pride has purple sprouts, those of Myatt's being faintly tinted with purple. Even if the two tubers that resemble Myatt's were taken out of the centre of a heap or sack their growths would necessarily be more or less white; but if all the tubers you have sent have been similarly exposed to light, then they represent two varieties. Taking the tubers before us as a fair sample, our opinion is that the bulk consists of Mona's Pride, the remaining portion being Myatt's Prolific, this being as good, if not better, than the other for growing on farms. Both are early varieties, though not quite so early as the old Ashleaf, but are more prolific.

Roses not Expanding (*J. F. M., Herts*).—We are sorry to see such unsatisfactory buds and abortive flowers as you have sent us. There is a very expressive but not over-elegant term, "Gardener's Greed." This we believe to be a case that comes under that denomination. The plant, like many others of this grand but much-abused Rose, has been overcropped, and has not sufficient strength to support the numerous blooms. The same result then follows as in the case of overcropped Vines—namely, failure. Further, the buds some time ago received a check in some way; if near the glass they were possibly frozen, or the house may have been too damp—certain it is that they have been injured. We are sorry to see such a mass of decay, and the more so as this we consider the finest variety of Marechal Niel. The plant should be pruned rather severely as soon as the flowers have faded, with the object of encouraging the production of strong growths. We presume it is planted out, and vigorous root-action should be promoted by fresh soil and manure.

Rose Leaves Falling (*F. J. J.*).—It is not unusual for the old leaves of Marechal Niel to wither when fresh growths are advancing; we may, indeed, say it is quite usual for them to do so, and natural. They, however, sometimes fall prematurely from plants that are overcropped with flowers. The leaves you have sent indicate a lack of vigour in your plant. In all probability it would be well to remove as much surface soil as you can without seriously disturbing the roots, and add fresh compost—turfy loam, to which a fifteenth part of bone-meal is added, or the quantity of Clay's Fertiliser recommended on page 246. You would thus encourage the production of fresh roots for appropriating the food you could afterwards apply in liquid form. Making the soil quite black with soot—that is, spreading it on nearly an eighth of an inch thick, and applying water at a temperature of 100°, is excellent for root-bound Roses. We have seen water applied at a temperature of 130° every time it was given for several days consecutively, and the growth of the plants was vigorous and of that deep dark green hue that cultivators like to see.

Annual Marguerites (*C. E. B.*).—The plant referred to is *Chrysanthemum segetum*, that grows wild in corn fields in some districts, usually where the soil is somewhat moist. It has bright yellow flowers, single, 2 inches in diameter, which were in demand last year for various decorative purposes, many being used in some of the designs at the exhibition of table decorations at the Royal Botanic Gardens last July. Sow the seed in the open ground in deep rich soil, thinning out the plants freely when they are large enough to be handled. If we desired a bed of "Corn Marigolds," the popular name of the plant, we should sow in rows a foot apart, and thin out the plants to 6 inches asunder.

Scale on Camellias (*Ignoramus*).—We have carefully examined the leaves you have sent, and we have no doubt whatever that the glutinous matter on them is caused by insects, and is not an exudation from the plant. When sap globules appear on the foliage of some plants, such as Vines and Azaleas, it is indicative of vigour. The plant from which the leaves and shoot before us were taken is the reverse of vigorous. It has in all probability been allowed to produce too many blooms and become partially exhausted. Its enfeeblement has been increased by the scale insects appropriating the already insufficient supply of sap. We are almost certain these are very numerous. If the plant is large there are thousands of them, as on the small shoot you fortunately sent we counted ten fine specimens. Closely examine the base of the buds through a magnifier and you will have no difficulty in finding these filthy insects. You say the leaves have been sponged "thoroughly clean." That must have been some time ago, and although you may have cleansed the leaves you certainly did not remove the insects from their axils. It is there and in the scales of the buds that they congregate, secreting themselves so as to be almost invisible, except to a sharp and educated eye. In this case you had better dissolve 2 ozs. of soft soap in a gallon of rain water, then add an ounce of petroleum, mixing or incorporating the fluids by violent agitation. Then brush the insecticide well into the axils of the leaves and round the buds and the base of the young growths; sponge also all the foliage, and give the plant a good syringing, but by some means prevent much of the solution reaching the roots. You had better also repot or top-dress your plant by removing some of the soil and add-

ing fresh compost to the roots. It must be syringed frequently, kept moist and shaded, and next year should not be allowed to carry so many blooms. The variety generally flowers very freely, and we have known many plants exhausted by the want of timely removal of a number of buds. You had better adopt measures for preventing the insects on the infested plant spreading to other Camellias in the house, or they will soon all be in the same unfortunate condition.

Rabbits and Shrubs (*G. C. E.*).—Your letter shall be answered next week. Thanks for the enclosure.

Names of Plants (*Rev. A. K. C.*).—A small flower of *Denbrobium fimbriatum*, an East Indian species, which you may grow either in a basket or pot.

Bees Dying (*T. Williams*).—If you had said when you commenced feeding and the quantity of food you gave we could have better understood the case. Our impression is that you did not commence feeding soon enough. Certain it is your bees have been starved to death by want of an adequate supply of proper nourishment.

Decayed Comb (*Clifton*).—If the fallen combs are as you say rotten remove them, and either unite the bees with another stock or feed them well. See Mr. Pettigrew's article in our present issue.

COVENT GARDEN MARKET.—APRIL 4TH.

OUR market has been a little more active without alteration in prices. Some good new Grapes are to hand.

FRUIT.

	s. d.	s. d.		s. d.	s. d.
Apples.....	½ sieve	2 0 to 7 0	Grapes	lb.	2 0 to 8 0
"	per barrel	20 0 40 0	Lemons	case	10 0 20 0
Apricots.....	doz.	0 0 0 0	New Grapes ...	lb.	8 0 12 0
Cherries.....	½ sieve	0 0 0 0	Nectarines.....	dozen	0 0 0 0
Chestnuts.....	bushel	10 0 12 0	Oranges	100	6 0 10 0
Currants, Black..	½ sieve	0 0 0 0	Peaches	dozen	0 0 0 0
" Red.....	½ sieve	0 0 0 0	Pears, kitchen ..	dozen	1 0 2 0
Figs.....	dozen	0 0 0 0	dessert	dozen	1 0 2 0
Filberts.....	lb.	0 0 0 0	Pine Apples, English	lb.	1 6 2 0
Cobs.....	100 lb.	0 0 0 0	Raspberries	lb.	0 0 0 0
Gooseberries ...	½ sieve	0 0 0 0	Strawberries ...	oz.	0 6 0 9

VEGETABLES.

	s. d.	s. d.		s. d.	s. d.
Artichokes.....	dozen	2 0 to 4 0	Lettuces	score	1 0 to 1 6
Asparagus, English	bundle	12 0 0 0	Mushrooms	punnet	1 0 1 6
Asparagus, French	bundle	25 0 30 0	Mustard & Cress ..	punnet	0 2 0 3
Beans, Kidney ...	100	2 0 0 0	Onions.....	bushel	2 3 2 6
Beet, Red.....	dozen	1 0 2 0	Parsley.....	doz. bunches	3 0 4 0
Broccoli.....	bundle	0 9 1 6	Parsnips	dozen	1 0 2 0
Brussels Sprouts..	½ sieve	1 6 2 0	Peas	quart	0 0 0 0
Cabbage.....	dozen	0 6 1 0	Potatoes.....	cwt.	6 0 7 0
Capicums.....	100	1 6 2 0	Kidney.....	cwt.	6 0 8 0
Carrots.....	bunch	0 4 0 0	Radishes... doz. bunches	1 0 0 0	
Cauliflowers.....	dozen	2 0 3 0	Rhubarb.....	bundle	0 4 0 0
Celery.....	bundle	1 6 2 0	Salsafy.....	bundle	1 0 0 0
Coleworts.....	doz. bunches	2 0 4 0	Scorzonera	bundle	1 6 0 0
Cucumbers.....	each	0 4 0 8	Seakale	basket	1 0 2 0
Endive.....	dozen	1 0 2 0	Shallots.....	lb.	0 3 0 0
Fennel.....	bunch	0 3 0 0	Spinach.....	bushel	3 0 0 0
Herbs.....	bunch	0 2 0 0	Tomatoes.....	lb.	1 6 2 0
Leeks.....	bunch	0 3 0 4	Turnips.....	bunch	0 2 0 3



POULTRY AND PIGEON CHRONICLE.

ENSILAGE.

(Continued from page 269.)

ALTHOUGH we have stated various points connected with the construction of the silo, yet we may have to remark upon it again further on. We, however, now desire to refer to the various modes adopted for filling the silo. It is important that everything be in readiness for the operation before commencing the work. When once filling is commenced the sooner it can be completed the better; for in the case of all green or succulent forage, heating, which must be avoided, will commence immediately the bulk has accumulated, and at the end of each day's work the covering planks should be put on.

In order to show the practical advantages of certain kinds of fodder for ensilage we will first name coarse water meadow grasses, and even sedges, which grow on the edges of the water carriers or banks and borders of brooks and rivers, for these when in full leaf will make useful ensilage. We have often known them cut up with straw in the summer time, mixed and given as chaff to dairy cows, and answer well for producing milk: these

will therefore when preserved in the silo be available. The next item to be named is Rye, just as it is coming into ear; in fact it may be followed by a crop of yellow Indian Corn or Maize of the coarse-stalked sorts. The Rye will be ready some time in May, quite soon enough to grow a full crop of Maize afterwards, for it is only required for cutting while in full growth, and will produce, when well manured and grown thickly on the land by drilling and hoeing at 18 inches apart, a heavier weight than almost any other crop; thus the land will yield two full crops of ensilage in the year. We wish, however, here to state that all crops should be cut into chaff as it is put into the silo, for it may then be trodden down quite close, so that when properly weighted at the finish the air may be entirely excluded, which is the first object to be attained. The cutting should be done by either steam or horse power to complete the work as soon as possible. The "chaff" should be cut about 1 or 1½ inch in length and trodden down by a horse or working ox. All kinds of Clover, Rye Grass, Trifolium and aftermath, Vetches, Sainfoin, Peas, or Beans in bloom, or Lucerne and Green Rape—even corn, such as Oats or drege, or any corn crop intended for feeding cattle or horses on the farm, or crops too late to fully ripen, may be profitably utilised and made much more valuable than by any other plan. If the weather sprouts the corn in sheaf and it cannot be harvested in the ordinary way, it may be cut up and stored as ensilage although in damp condition.

On this subject Mr. C. A. Kemble reported as follows in the *Agricultural Gazette* of March 26th last:—"On September 9th, 1882, I commenced cutting 25 acres of Black Tartarian Oats. Owing to the wet season which followed I was unable to harvest the crop in the usual way. I determined therefore, by way of experiment, to adopt and fill a silo, and fill it with Oat sheaf chaff. I sent my teams into the field on the 6th November, and on that date began to fill the pit, cutting the straw into chaff about 1 inch in length. The Oat sheaves were in a thoroughly sodden condition, and the corn in them had so generally 'sprouted' that apparently all was worthless except as manure. We continued cutting and filling at intervals, and trod in the final 'chop' on November 11th. Nine loads were cut up in this way, which I estimated at 13½ tons. While filling the pit I carefully mixed with this wet chaff 3 cwt. of salt and 100 lbs. of 'Simpson's Spice.' Having filled the pit I had a layer of dry straw laid on the chaff, then boards fitted over the straw. Again over this I spread layers of sawdust and oak cavings, and placed several tons of freestone on the top. This pit was opened on March 14th in the presence of many leading agriculturists, amongst whom we noticed Sir John Heron-Maxwell, Bart., of Springkell, N.B., who, it may be remembered, brought this subject prominently before the meeting of the Royal Agricultural Society of England in December last. After the covering boards, &c., had been removed a very little of the preserved fodder was slightly fusty. Breaking further into the mass a fragrant odour soon pervaded the homestead in which the experiment was tested, for a hot cloud of vapour escaped from the ensilage, and reminded one by its smell of a newly heated hayrick. An ordinary thermometer was plunged into the mass towards the centre, and registered 110°. Some of the ensilage was immediately carried to cattle and horses, and was readily eaten by them."

This case shows that in a northern climate in the worst of seasons a crop of Oats need not be entirely lost as food for the live stock. It appears from many experiments that the fodder to be stored for ensilage may not only be put into the silo with the morning dew on it, but that it may be sodden with rain, and yet not injure the value of the material when it comes out for feeding purposes when judiciously treated. But the home farmer must remember that so far as ensilage in this country has

been attempted it has been under uncertain conditions of storing, and it is therefore better to proceed by way of experiment than to incur heavy cost, at any rate until as practical farmers we may be more certain of results.

In the samples of Trifolium ensilage we have seen there was a peculiar acidity in the odour, the colour being about nut-brown or that of hay moderately heated. From all that we have noticed as to the use of salt strewed over the ensilage during the filling of the pit, this had not injured it, and the cattle and dairy cows ate it readily. It is, however, not yet decided that salt is a necessary application in the silo. We think that at present on many farms the making of hay for sale will hold in check the extent of storing for ensilage; still it must be viewed as a matter of great consequence in the saving of fodder crops, especially as hay fit for ready sale can only be made in comparatively fine weather.

(To be continued.)

WORK ON THE HOME FARM.

Horse Labour.—Having now a farm on hand, some fields left in a couchy state by the outgoing tenant were half ploughed during the winter. On some of this land the rafters have been turned over or reversed, and the land worked fine, much of the couch having been removed, and the land sown with the best Victoria Oats. As these weigh over 45 lbs. per bushel and are very small, only 3½ bushels of seed per acre are needed. A dressing of 4 cwt. of corn manure from one of our best artificial manure factories per acre will be given about the second week in April. The land in some parts will not be quite clean after harvest. As, however, these Oats will be ripe before the Wheat, perhaps ten or twelve days earlier, the land will be scarified between the stocks of corn at harvest and sown with stubble Turnips before the sheafed Oats will be carted, the sheaves being removed on to the sown land, in order to complete the sowing of the whole field before carting the crop. In this way for more than forty years we have often grown eighteen sacks per acre; last year, however, this sort of Oats gave nineteen sacks per acre, and the crop was carted by the end of July, although the general harvest was not an early one.

The planting of Magnum Bonum Potatoes should now be commenced if it has not been already begun; and in order to prevent delay at planting time we fork out some few bunches of couch grass, if any manure is spread in the furrows with the sets, 3 cwt. of Peru guano and 4 cwt. of kainit per acre, mixed with damp ashes or sand if the weather is dry and windy. We plant cut sets, for whole tubers throw too many shoots even when the tubers are small. We prefer to plant the lines 3 feet apart, and the sets 1½ foot apart in the lines. In case the soil be poor gravel or sand we would apply 1½ cwt. of bone superphosphate per acre between the lines before earthing up.

The cultivation for Mangold may now be continued so that the seed can be drilled by the 20th of April. If the land is very dry we drill on the flat, applying artificial manure with the seed, not over 4 cwt. of bone superphosphate with 2 cwt. guano mixed with ashes per acre, and if the land requires more manure apply 2 cwt. nitrate of soda just before the second hoeing when the plants are strong.

Hand Labour.—Although the weather has been severe and will delay much of the work that is generally done in the spring, such as felling oak timber and the barking or stripping the trees, mild weather is required to allow of the bark being taken off freely, after which dry weather is necessary for drying the bark. Some men will now be employed in seeding the Lent corn with Clover seeds, Bennett's seed barrow being used for the purpose. Where the Wheat is to be sown after the Clover lea we prefer to sow Clovers alone, taking 10 lbs. Red Clover seed and 4 lbs. Alsike as the mixture per acre, without any Rye Grass seed with them, except in case of the hay being required for sale. We then use Rye Grass, as the hay makes in less time and with less risk than when composed of all Clover. It also sells better to town customers.

Live Stock.—Unfortunately the foot-and-mouth disease continues to spread in some districts. This is very unfortunate for the farmers, as the closing of the markets prevents in a great measure the natural competition amongst the butchers, to the prejudice of the breeders and feeders. Sheep have done much better during the month of March than previously, but on the water meadows and high pastures the prospect for grass has much diminished since we have experienced the cold cutting winds and snowstorms. With a dry season hereafter, which seems very probable, food for sheep and cattle may be scarce, although there are generally large stores of roots on many farms. The home farmer will do best to prepare for a dry summer, which will right also if it happens the reverse. It is a singular fact that we have had eight showery and wet seasons in succession, the like of which has not occurred during the present century. If the summer should be ever so dry we ask the home farmer not to be deluded into a false security by feeding sheep on lands which has coathed and rotted them in the wet seasons, for we know some of the finest water meadows in the kingdom which never can be fed by sheep after midsummer without risk of taking the fluke; and, again, on the dry parkland pastures, although sheep would not always take the coathe, yet they are sure to deteriorate the turf by eating out the finest sorts of herbage, like White Clover. Breeding sows will now be farrowing, and the young pigs will require care and shelter and

good feeding. They should not generally have much root food, especially of Mangold, without meal mixed with the roots cooked by steam.

BOTTLED MILK.—A new milk company has been formed in New York for supplying pure milk delivered in bottles. The cows which furnish the milk are healthy and well fed. They are inspected regularly by veterinary experts, as are also the stables and drinking water, by members of the Board of Health or other suitable persons. The milk is inspected every day to see that the temperature is right, and that it is clean and perfectly sweet. The milk is packed in glass bottles holding a pint or quart, and these are sealed and then surrounded by ice. The seals are never broken except by the consumer. The price received is 10 cents per quart, while ordinary milk usually retails at 8 cents, though it varies, according to the supply at different seasons, from 6 to 10 cents. Cream is also bottled and sold by the same system at 40 cents per quart. The Secretary of the Company states that except just after a fall of snow it is next to impossible to deliver clean wholesome milk to New York families by the ordinary methods. Most of the milk is sold from 40-quart cans with wide covers, and in retailing it through the street the covers are removed for every quart of milk sold, and while the milk for each customer is being taken out with a long-handled small dipper, the street dust which often fills the air like clouds, is blown into the milk in spite of the best efforts of the milk pedlar. The Company has been organised but a short time, but is gaining the confidence of its customers. The physicians are the best friends of the Company and the enterprise, as they find it is about the only milk they can safely recommend or use freely.—(*American Cultivator.*)

POULTRY AND PIGEONS

OUR FOREIGN EGG SUPPLY.

It is a well-known fact that England is largely dependent upon France, and in a lesser degree upon Belgium and Holland, for her supply of eggs and poultry. The quantity and value of the eggs imported into this country has for years past been increasing rapidly. The table which we give below, compiled from the Board of Trade returns, showing the number and value per great hundred (120) of the eggs received from France alone, will give some idea of the growth of this trade during recent years, and is a conclusive proof, if any be needed, that it is high time the farmers of England began to consider poultry as being a source of profit quite as worthy of their attention as their Shorthorns, Southdowns, or Berkshires. From the Board of Trade returns for March it appears that no less than 199,922,640 eggs, valued at £619,236, were imported into England during the first three months of the year 1882, and this compares with a total of 170,977,040 eggs, valued at £569,456 received during the same period in 1881. It seems to us that English farmers would have no great difficulty in diverting into their own pockets a large proportion of the considerable sums of money which now find their way across the Channel in payment for the eggs we receive.

The table which is annexed goes back to the year 1856, with the view of showing the enormous increase in the importation, and the gradual augmentation in value per great hundred. From 1856 to 1874 inclusive the returns are given for alternate years, and from 1874 to 1879 yearly:—

	Number of Eggs Imported.	Value. £	Average Price per 120. s. d.
1856	177,230,600	278,422	5 8
1858	134,685,000	303,617	5 5
1860	167,695,400	478,658	6 11
1862	232,321,200	593,813	6 1
1864	335,298,240	835,028	5 11½
1866	438,878,880	1,105,653	6 0¼
1868	383,969,040	1,009,285	6 3
1870	430,842,240	1,102,080	6 1½
1872	405,701,040	1,394,152	8 2½
1874	538,087,440	2,915,725	8 11¼
1875	580,212,360	2,078,659	8 7
1876	502,534,800	1,864,135	8 10¼
1877	441,369,920	1,602,038	8 9
1878	448,190,400	1,599,776	8 6½
1879	412,935,720	1,391,609	8 1

A study of this table will show how, with slight variations, the price of eggs per great hundred has gradually risen from year to year. Whereas for the ten years from 1856 to 1864 the average price was 6s., it rose from 1864 to 1874 to 7s. 1½d., and during the five years from 1875 to 1879 the average was within a fraction of 8s. 1d. It is, we think, fair to assume that the average price of 6s.

per great hundred was remunerative to our French neighbours, or it is not probable that the trade would have increased nearly threefold. It may also be remarked that, with an increased demand and a more certain and well-established market in this country, the price rose rapidly; and although the next ten years show an average value of only 7s. 1½d. per great hundred, the price that in 1870 was only 6s. 1½d. was in 1871 7s. 9d.; in 1872, 8s. 2¼d.; in 1873 (the highest average attained), 9s. 0¼d.; in 1874, 8s. 11¼d. For the next five years the value remained somewhat stationary, with perhaps a slight tendency to reduction, while the same remark holds good in reference to the number of eggs imported. We can fairly deduce, however, from the figures given above, that our French neighbours must have pocketed very large profits from the egg trade with this country during the last ten or eleven years, and therefore that, if English farmers had given to poultry-farming, or rather to egg-producing, the proper and necessary attention, they would have profited by no small proportion of the money that found its way abroad. It is certainly difficult to see why egg-producing, which is so large a source of profit to our neighbours, should prove itself a source of loss when undertaken by British farmers.

From the table given above it appears that fifteen or sixteen eggs are annually imported from France for every head of population in Great Britain; and if it is taken into consideration that the French do not import any eggs from other countries for their own consumption, and that they are greater consumers of eggs than the English, probably requiring twenty eggs per head of population, it will at once be seen what an important industry egg-producing is in France. It should be observed that the average price, from year to year, is the price at which eggs are imported into this country. A deduction for profit to several men must be made, and this leaves a greater margin for profit to the producer in this country as against his competitor abroad. We purposely make no mention of the freight from France to London, as this item of expense will be fully compensated by the cost of carriage in England, unless farmers succeed in making special arrangements with the railway companies for quick transit at reduced rates.—(*British Trade Journal.*)

POULTRY WITH SCALY LEGS.—I am happy to inform the Editor of the *Journal of Horticulture* that the remedy which he recommended for the scaly legs of poultry in the paper of Feb. 1st has been quite successful. The scales came off in large pieces, and the legs are now clean and healthy. I am much obliged for the advice.—A. S.

[We shall be glad to know whether it is the sulphur or vaseline remedy that has proved efficacious.]

OUR LETTER BOX.

Incubation (*An Old Reader*).—Artificial hatching occupies just the same time as the natural process. For full details of incubators see "POULTRY," published at this office weekly, price 1d.

METEOROLOGICAL OBSERVATIONS.

CAMDEN SQUARE, LONDON.

Lat. 51° 32' 40" N.; Long. 0° 8' 0" W.; Altitude, 111 feet.

DATE.	9 A.M.					IN THE DAY.				Rain.
	Barometer at 39° and Sea Level	Hygrometer.		Direction of Wind.	Temp. of Soil at 1 foot.	Shade Temperature.		Radiation Temperature.		
		Dry.	Wet.			Max.	Min.	In sun.	On grass.	
1883.										
March.										
Sun. 25	29.817	35.6	31.8	S.W.	36.8	44.4	27.2	86.1	23.5	—
Mon. 26	29.233	36.3	32.4	N.W.	37.3	46.2	32.2	92.2	29.4	0.033
Tues. 27	29.510	35.1	33.0	N.	37.7	45.2	26.3	94.4	23.3	0.010
Wed. 28	30.079	36.3	32.9	N.	37.4	45.8	27.7	94.4	23.9	—
Thurs. 29	30.144	42.8	37.4	S.	37.6	48.6	28.4	87.3	24.1	0.038
Friday 30	29.436	46.2	44.8	S.	39.0	52.6	42.0	55.4	37.9	0.108
Satur. 31	29.928	40.0	37.4	N.W.	39.5	57.0	32.5	101.4	28.5	—
	29.740	38.9	35.7		37.9	48.5	30.9	87.3	27.2	0.189

REMARKS.

- 25th.—Bright and cold.
- 26th.—Very fine bright morning; overcast in afternoon; thickly falling snow from 4 to 5.30 P.M.
- 27th.—Very cold, frequent showers of snow, with bright sun at intervals.
- 28th.—Bright and fine throughout.
- 29th.—Fine and bright, with much wind and dust.
- 30th.—Dull and rainy until 5 P.M.; fine starlight evening; much warmer.
- 31st.—Fine, calm, bright day.

A fine but rather wintry week. Temperature rather more than 3° above that of the preceding week, but yet about 3° below the average. The last day of the week and of the month was warm and spring-like.—G. J. SYMONS.



12th	TH	Royal Society at 4.30 P.M.
13th	F	Quekett Club at 8 P.M.
14th	S	Royal Botanic Society at 3.45 P.M.
15th	SUN	3RD SUNDAY AFTER EASTER. Ghent International Exhi-
16th	M	[bition (8 days).
17th	TU	
18th	W	Society of Arts at 8 P.M.

EARTH TEMPERATURES.

WHEN treating of bottom heat it is usual to begin by quoting figures which prove that during the growing season the heat of the soil is higher than the air. As this fact is now perfectly well known, it is not necessary to take up space proving what is regarded as a truism. We will, therefore, at once plunge into the subject of bottom heat, and the effect of soil-warmth in promoting the growth of plants.

In hot countries the heat of the soil frequently becomes so high as to be absolutely destructive. Under such circumstances cultivators have to keep down earth heat by irrigation, and on a small scale by mulching, in order to rescue the land from utter sterility. Unless during exceptionally hot seasons and on thin soils with a hard or rocky substratum underneath, a too high earth temperature is seldom experienced by British gardeners, unless in the cultivation of some few alpiners or plants from northern climes. Generally speaking, it is want of heat that we in our northern latitude suffer from, and especially so in those districts where clouds prevail and the sun seldom reaches through to warm the cold earth below.

Increase of bottom heat is equal to increase of air heat; but while glass houses or sheltering walls and plantations have to be erected at considerable cost in order to secure a higher air temperature, higher earth temperature may be secured by applying the facts which science has discovered, and which cost us little. It is well known that dark surfaces absorb heat, while white surfaces reflect it. Acting on this, we in 1882 darkened the surface of half of the space wherein our earliest batch of Potatoes grew, and also part of our Onion beds. The Potatoes in our darkened section were fully a week earlier than those grown on the undarkened part. The soil was a brown loam. On ordinary garden soil, deeply darkened because much humus is present, such artificial darkening would not, of course, have an equal effect. In the case of the Onions the crop was very superior, not so much in weight as in ripeness and quality, to the portion grown on the undarkened part. But other means were taken to keep up the earth heat, which will presently be mentioned. Had the season been at all an average one the results would have doubtless been even more marked. As it was there was remarkably little sunshine after June.

The last time that Tomatoes were grown out of doors here was in 1878. The climate is against their doing well. In that year all were grown on a border

raised 1 foot by means of bricks—experiments the year before having shown the advantage of raised soil. Half of this border was darkened by impalpable charcoal dust, and half left *au naturel*. Charcoal dust (moulders' black used in ironfounding) was used instead of soot to guard against error; the use of soot, though securing the absorption of sun heat, having proved too stimulating and causing a luxuriance that was likely to be attributed to a wrong cause. Even common coal dust we have found effective. The plants grown in the darkened soil ripened fruit eleven days earlier than those under natural circumstances, and produced nearly double the crop, for the others failed to swell all they set—the early autumn frosts stopped them.

The year before, on the same place, half were planted on the level ground, half on soil raised 1 foot. The year 1877 was extremely wet and sunless in this locality, but even the little sun we had warmed the raised border so that the plants benefited considerably, although no ripe fruit was got from either batch. The extra warmth, however, caused a healthier growth, and the plants produced a few green fruits, those on the flat remaining stunted and fruitless.

On cold clays advanced gardeners have long practised planting fruit trees on raised mounds, experience having proved that better ripened wood and increased quantities of better fruit are thereby secured. The reason is that such mounds acquire a higher temperature than the soil on the flat. We think this fact has not been recognised in all its bearings, or raised borders would be more frequently seen. In these days, when root-cultivation is well understood and generally practised, it would be well worth while planting wall trees at least on borders raised out of the cold bottom to where the sun would early supply the earth with much-needed heat. Especially in the case of trees on dwarfing stocks or as cordons could this be done, as such require borders of no great dimensions.

Barren cankered trees have been cured of their disease, and their barrenness replaced by fertility, by simply having their roots lifted out of the cold under soil and placed near the warmer surface. Dr. Lindley, quoting from the Memoirs of the Caledonian Horticultural Society, in his "Theory of Horticulture," mentions a case of this kind. Mr. Reid of Balcarras cured cankered trees by taking their roots out of soil which at 3 feet deep was during the summer months 44°, at 18 inches 50°, at 9 inches 57°, and at 6 inches 61°. In a raised border where the soil was dark we, ten years ago, found a thermometer indicate 67° 6 inches from the surface; near by, on the level, it was only 59°. The border, it should be added, had a slope of 25° or thereby. Such figures show that it is throwing away natural heat to make vinery or other borders on the ground level, flat, and 3 feet deep. Rather would we recommend raised borders with a slope to the sun, shallow, and roots close to the surface. Such would cost much less, for excavation would be saved, and less soil necessary. Indeed, as we shall show further on, it would enable us to keep cooler atmospheres, and that means less coal, less labour, and fewer insects.

Earth heat may be considerably increased by cutting off the cold under soil from the warmer upper. In our district it is labour lost in ordinary seasons to put Vegetable Marrows out as is done with success in the

sunnier south. Even on sun-warmed raised borders they seldom do well; but when a foot of fresh stable-yard manure is put under the upper foot of soil success, even in such woeful years as last (1882), is nearly certain. Six plants of Muir's New Hybrid were last year planted on the level and nursed for a month under handglasses. They never bore a fruit, though pinched and trained as carefully as Melons. The earth heat was never over 57°. Six on a raised vinery border with a good slope bore twenty-nine fruits, although the spot was more exposed than in the first instance. The earth heat reached and remained some time at 61°, but was not over 59° till August (June and July were very wet), and none ripened. Only nine reached full size. In a position more exposed than either of the other two, six other plants were placed out on a border raised 1 foot by that thickness of very fresh hot stable litter under the soil. This material was laid flat 3 feet wide, 1 foot under the surface. Four days after—the weather was very bright then and also hot (18th May)—the plunged thermometer stood at 72°, a month after it was 67°, and at that it remained till the end of August. What it was in September I was too ill to ascertain, but in October it was still 60°, and that after a peculiarly sunless season. But, in fact, by July the heat was protected by the covering foliage. The produce was, up till September, forty-five fully grown fruits, many of which in a very bad year and on an exposed spot in a peculiarly exposed late locality, ripened. After August the gathered produce was as my man expressed it, "a big barrowful," some of which were being used in February, and all this because of extra bottom heat alone; this heat being secured for only a little trouble, the manure remaining being as good as at the beginning, for it was never wet enough to lose its virtue. No doubt the raising of the border contributed to the result, and also the heat in the manure when first buried. This raised the heat at once. The non-conducting nature of the material and the thick leafy covering preserved it, and this made all the difference between a moderately good crop in a season and in a locality where without such assistance the plants only cumbered the ground. The use of blacking might have secured a degree or two more, for when this was tried on French Beans the plants produced a moderate crop of beans by the third week in August; without it they only produced half-formed pods, which never came to be of any use at all, they were so late, so stunted, and tough.

Very much may be done to secure a higher earth temperature than natural by the use of coverings. By covering at night the surface of a 14-inch pot, plunged in ashes with dried sphagnum at one time and sawdust at another, the soil maintained a temperature of 63° through July and August. One exposed at night was barely 60°. Mr. Thomson of Drumlanrig mentions the following striking instance of how earth heat may be preserved. In October he covered a vinery border with 18 inches of wheat straw laid on like thatch. At midwinter the earth heat was 60°. An uncovered border was as low as 40°. The difference to the plants, supposing both to be forced into growth, would be very considerable. The sap feeding the one would be 20° below that of the other. Under such conditions the one would do well, the other might fail—and failure from such a cause has resulted before now.

Watering tends to lower earth temperatures: rain

has the opposite effect. This may seem a paradox. Watering is only resorted to during drought. But under such conditions the water applied evaporates rapidly, and there is nothing that lowers the temperature of the soil so rapidly as evaporation. But when rain falls the atmosphere is saturated, and evaporation proceeds slowly or even not at all. Then we must remember that heat descends slowly. It is this fact which accounts for the coldness of the under soil. Heat inclines to ascend. But when rains fall in the summer it carries heat down into the soil. It changes the air in the soil, too, by displacing it. As the rain afterwards leaves the soil, warm air follows. Thus rain warms, and artificial watering cools, the soil. This fact is taken advantage of by those who find their climate too hot for the particular plants they cultivate.

Watering, for this and other reasons, should not be indulged in unless absolutely necessary. Many check all growth by their perpetual dribblings. After watering, as soon as the soil is dry enough, means should be taken to preserve not only the water but the earth heat by checking evaporation. In hot seasons short grass, manure, leaf soil, cocoa-cut fibre, &c., may be employed as a mulching. But even a hoeing, in order to produce a loose layer of surface soil, will do much to check evaporation, while it will allow sun heat to pass on. In the case of many tender plants this is a very important matter.

Draining raises earth temperature. Soil that is wet is also cold. Instead of using sun heat to raise its temperature it employs it to evaporate the water. Wet soils are always cold, and a plant on a cold soil draws up cold sap, which keeps the plant cold no matter what the air heat may be. Nay, a watery diet produces even a greater degree of cold, for, in order to get rid of the superfluous water in the over-diluted food, the plant must evaporate more than is necessary, and thereby renders itself colder still. It is this that makes corn on wet land late. Draining, then, is of paramount importance, for thereby the soil is warmed, the sap plants draw up warmed, and this is seen to be as good as an increase of air heat for the plants. Corn, vegetables, fruit mature sooner and improve in quality as they do when transplanted to a better climate.

We spoke of the better Onions that we raised by darkening the soil, and hinted that another method was used to promote a higher ground temperature. That other method was to keep the surface soil constantly stirred with the hoe, especially after being battered by rain. Even in such a sunless year as last the results were markedly superior; but in sunny years we have even seen a greater difference.

In the application of bottom heat by means of hot water or fermenting material sometimes too much is given. It is necessary to guard against this. Often Seakale and Asparagus are "drawn" so much as to be useless by too much bottom heat. A safe rule is to keep within 5° of the earth heat in the warmest summer month outside for most hardy plants. But "drawing" is not always an evil. In the case of forced Lily of the Valley, for instance, drawing is systematically practised.

The earth is a vast storehouse of heat. By coverings much of the heat thus stored might be utilised. To some extent this is already done. By mulchings of manure Roses are protected. Many tender herba-

ceous and lowly alpines are kept at a temperature much above that of the air by coverings of cocoa-nut fibre, leaf mould, or even ashes. These are all, more or less, good non-conductors, especially when kept dry; but it is here many protecting materials fail. Perhaps the best article ever heard of is the waste of flax—pob it is called. For mulching, covering frames, Potato pits, water pipes, few things equal it, for it is hardly possible to make it wet. Such acts by keeping the comparatively warmer earth separated from the much colder air, just as the layer of litter in summer kept the different temperatures of the upper and under soil apart, and prevented the one neutralising the other. All act as protectives by conserving the earth heat.—SINGLE-HANDED.

(To be continued.)

THE GLADIOLUS.

THERE would seem to exist some wish to enforce the Clôture in respect of difficulties and failure in the culture of Gladioli, and a desire to have expression given in your pages only to what can be said in their favour; but that this is a case in which "speech is silver, silence golden," I utterly fail to see. Those who write of deterioration and loss are charged with discouraging the cultivation of the Gladiolus. I beg leave to view the honest opinions of those who have fairly tested this unrivalled flower in quite another light. To be forewarned is to be forearmed, and in any speculation where such warning is founded on incontrovertible facts it ought to be courted rather than suppressed. Then let such as wish to prosecute inquiry do so at their own hazard, and time will show whether they are of the category of the wise who profit by the experience of others, or if they come to acknowledge themselves of another class who purchase wisdom, and that dearly, by their own. With no other object than to record the experience gleaned during another year from my own efforts and from observation of those of several others, I ask space for these remarks. I shall nothing exaggerate, nothing conceal, and will advance no statement that I cannot substantiate.

"How well your Gladioli have done this year!" was more than once remarked to me last autumn. When I replied that in no respect had they done better, but in a very material one worse than for the last seven years, I stated bare truth. The small stands that were not a little admired at two of our leading exhibitions were shown without much room for selection, as my plants were just coming into flower. I had to destroy the balance of the former by introducing perforce a weak spike of La Perle, a variety at its best, as I have yet seen it, unworthy of being staged with those it accompanied. The second and larger lot could have been more weighty had I availed myself of the duplicates allowed by the schedule. About one-fourth of my limited stock never appeared above ground, and the blank beds were an eyesore the whole season, receiving on that account less attention than I usually bestow on them. Then going off, as usual, at all stages, the roots of those I exhibited in not a few cases among the others, I was left with little over half the number I planted. So no inconsiderable outlay has been incurred to raise my total to something approaching what I had twelve months ago. But this cannot be maintained. It may do for those who regularly allow a liberal sum annually for Gladioli, but it is impossible for those of limited means to face the inevitable drain if they would keep up a select stock of even a moderate size. While looking on at the sale of Dr. Paterson's Orchids in Edinburgh, a gentleman unknown to me touched me on the shoulder, remarking, "If you would go in for some of these, and grow them as well as you do your Gladioli, you would find them a much more profitable investment." Once and again the Doctor himself has made the same observation to me. And it is true. What I have expended on Gladioli, which have completely disappeared, would have gone far towards erecting and sufficiently stocking a considerable Orchid house. A useful structure at least would

have been to the fore where nothing remains. We have had irrefutable evidence on these lines from the southern part of the island. I think I can without undue assumption speak for the north.

My neighbour, whom I have before credited with being second to no one I know as a cultivator of this flower, has again suffered less loss on the whole than I. But few, certainly no one less ardently in love with the Gladiolus, would in his circumstances expend over and over again upon it what he has done, this season being no exception. We had both resolved to practise restraint, and again have we succumbed to the syren's wiles. He no less emphatically than myself denounces the folly of any friend entering upon a speculation where the ultimate result is certain loss. For, whatever may be the case in a more favoured part of these islands, I plainly assert such loss as certain in Scotland. How do facts bear me out? I know of gardens where large collections have entirely disappeared, and not a few where they are rapidly doing so. But three weeks ago I saw the remains, grown small by degrees and beautifully less both in number and size, of an extensive lot, comprised in two small boxes, and this where cultural skill is not wanting in the numerous departments of a large establishment. I can point to a case in another part of the country where the stock was relegated to the garden borders, and not many were to be seen there. In both these cases full facilities for ripening off the corms, as has been recommended in the Journal, are at command. I cannot say whether the recommendation was put into practice or not. In my short notice of a nursery lately the omission of a few words made my mention of the Gladioli misleading. I wrote: "I was not at all surprised to find a collection of Gladioli telling their usual and unvarnished tale." The remaining few were indeed on their last legs, and shrunk shanks these were, the one weak point in fact in an establishment strong everywhere else. The collection of a model cottage gardener near me, comprising among others of a better class such sorts as Isabella, La Fiancée, Madame Furtado, Queen Victoria, that will not now do for competing stands, has last season all but succumbed. A house in the trade to which we used to look for our best corms has struck them out altogether. I know personally no amateur in Scotland but my friend here, and I have heard of none who has persistently kept up the losing struggle for eleven years, and no one but myself for fully half that time, whose collection embraces the very best of the old and a good many of the newer varieties. I do not think that I shall follow so long on the present terms. And when, in the face of such facts, one is told, as one of your most esteemed correspondents and myself were last year, of a stock that by "perpetuation of the corms" had gone on increasing for years in succession—such increase, for reasons it matters not what, was not then there to be seen—I acknowledge that there is made a demand stronger than I can meet for the exercise of that virtue which believeth all things.

Two extensive collections I am acquainted with—that of Mr. Campbell, nurseryman, Gourrock, and that at Newfield, Kilmarnock, the residence of Wm. Finnie, Esq. Mr. Campbell and Mr. Gray (gardener at Newfield) were the successful competitors at our leading shows last season, as they have been for years. But neither of these will maintain the "perpetuation" doctrine. Mr. Campbell's stock last year embraced fully two thousand flowering plants; Mr. Gray's somewhere about the same number. Both are raisers of capital seedlings now in commerce. The Mrs. Finnie and the Sir Garnet Wolsley of the latter gentleman were prominent in his grand stands at Edinburgh. Sir Garnet is one of the best flowers I know, splendid in shape, faultlessly smooth in the edge, and long in spike. Many other fine seedlings I saw in flower when I had the pleasure of visiting Newfield last autumn, and seedlings and bulbets were growing everywhere, even on the benches in the houses where handfuls of soil had been left containing minute cormlets that had escaped the sieve, and, as I was told, in the adjoining woods where refuse soil had been east. A passion for Gladioli exists at Newfield; as many as one hundred spikes had been cut just before my visit for the decoration of the mansion. I refrain from entering upon some interesting details. Such an enthusiasm is well supported by Mr. Gray,

whose ripe experience enables him to grow his bulblets by thousands promiscuously, and with facility to name them accurately as they flower. Mr. Campbell's seedlings Duke of Leinster, Duchess of Leinster, and Provost Binnie are also sent out. I believe they are of very high merit. The recommendation of the raiser is sufficient to all who have the pleasure of knowing him. I hope to see them and Mrs. Finnie in my own garden this year. I was surprised to see in his grounds at Cove Gardens somewhere about half a hundred vigorous plants of my favourite Ondine, and about as many of the charming variety Marquis of Lothian, all raised from bulblets.

Allow here a slight divergence. Of the English varieties I flowered last year Agnes Mary, Cymbeline, Duchess of Edinburgh, Flora, Hesperia, Jessica, Marica, Miss Salway, Mrs. Kynartin Mainwary, Pietum (one of the most useful), Queen Mary and Una, Earl Russell, James Kelway, and some others I have had some seasons, but have never seen, nor do I now hope to see them, in perfection, if at all, from the corms I have, as they have commenced that decrease in size which unmistakably announces waning energy, and sooner or later an inevitable farewell.—A NORTHERN AMATEUR.

(To be continued.)

THE GARDEN WATER SUPPLY.

If I were asked, What is the general rule as to watering garden crops? I should feel bound to answer, Just enough water is given to prevent actual suffering from drought; anything beyond this is an exceptional effort for a special purpose. If my querist were to go farther and ask, Do you consider the general practice satisfactory? I must again reply, Decidedly not; and the well-known fact of a free quick growth being a chief factor in the development of all culinary vegetables, and which is only imparted by abundant moisture in a fertile soil, gives weight to my answer. For stronger evidence patent to everyone we have only to revert to the wonderful growth of vegetables in the wet summer of last year, and as a farmer I may add the equally satisfactory fact of a double crop of hay and root crops of extraordinary abundance. But perhaps it is in an unusually hot dry summer that the inadequate supply of water to the requirements of so many gardens is shown most clearly; stunted growth, premature running to seed, mildew, tough flaccid flavourless vegetables that ought to be crisp, succulent, and sweet; crops of such brief duration that serious intervals occur in the supply which it is the pride of all good gardeners to maintain fully of every vegetable in its season.

In striving to remedy this unsatisfactory condition of things the two most important points are ample means for the storage of water and suitable facilities for its subsequent distribution. Chemists teach us that water exposed to the air absorbs fertilising gases suitable for the food of plants, and common sense tells us that water warmed by the summer sun is much better for plants than cold spring water fresh drawn from a well or pump. It should therefore always be stored in an open tank or pond sufficiently elevated to admit of its being conveyed through pipes to convenient points of the garden. When I began making the garden at Oldlands it was at first proposed to obtain water by a branch connection with the main pipe conveying spring water to the house from a reservoir some 50 or 60 feet above the highest part of the garden site; but eventually I was able to make a pond immediately below the reservoir to catch the waste water which I found escaping by soakage from a group of springs surrounding it, and thus obtained an abundant independent supply, which is taken to all parts of the garden through an iron main pipe 1 inch in diameter with suitable branches and hydrants. Enough 2-ply indiarubber hose in lengths of 60 feet was procured to reach every part of the garden, with suitable brass unions for screwing together and upon the hydrants, and a copper pipe with a tap, jet, and rose for the watering, and I thought my arrangements complete. For a time all went well, one man doing the work of half a dozen, and the newly planted fruit trees and shrubs grew so freely and well as to repay the outlay for hose in a single season. But after a couple of seasons' wear the hose was cracked and split in several places, and the conviction grew upon me that the extra 10*d.* per foot

which would have purchased the leather hose would have been a wise outlay at first. Gladly do I give your readers the benefit of this little item of dearly bought experience, in order that they may avoid my inevitable vexation, for the indiarubber hose soon became useless.

The other exception to what has proved an otherwise satisfactory apparatus is the failure of the taps. This is owing partly to pressure and partly to silica disturbed by rain and remaining suspended in the water for a long time after every disturbance. Now silica, however microscopical in size, is nevertheless quartz crystals, and its wearing action upon the tap soon becomes apparent in a slight dripping of water, which increases very much in proportion to the frequency with which the tap is used, and sooner or later it becomes useless. At first grinding the worn shaft of the tap with emery powder was tried, but the remedy was so brief in its duration that new taps soon had to be resorted to. After trying many sorts brass plumber's cocks have been selected as best. They are bought with a screwed end for screwing into the iron pipe, so that a new tap can always be put on in a few minutes by any of the workmen. A stock of the various sizes is always kept in readiness, as a leakage in a dry summer among the thirty taps in constant use is a serious matter. The average price of the taps may be given at about 6*s.* I have given these particulars about the hose and taps for the assistance of beginners, who are frequently at a loss in such matters.

It is not every garden that is so fortunately situated in relation to its water supply as this is, but there is none for which suitable arrangements cannot be made which in almost every instance would prove to be quite as much in the interest of employer as of the gardener. Storage of water and facility of watering means saving of labour as well as benefit to crops. It has been the writer's lot to have a full experience of waterbarrels drawn by horses or men; deep wells requiring two men at the pump that with a little outlay for horse gear might have been profitably worked by horses standing idle in the stable; waterpots carried throughout the whole of a long hot summer's day by "all hands," all for want of a moderate expenditure in the first instance when the garden was made. On the other hand admirable arrangements have been met with. Gardens in flat low-lying districts have had rain water stored in raised cisterns or ponds sufficiently elevated for its distribution through pipes. Such ponds are readily made above the common level by puddling the soil excavated for the raised banks wherever it is suitable, and most soils, excepting gravel or sand, make good tenacious puddle. Excellent dams containing a large proportion of silica have been made for several ponds made here within the last few years; or a strong spring of water has been turned to account by pumping it into a cistern close by, whence it flowed to lower open cisterns made about the garden.

For many gardens on hills the hydraulic ram is a great boon. Many scientific books profess to explain its value and use, but most of them rather puzzle than assist an ordinary inquirer. In the "Gardener's Year Book" for 1877 Dr. Hogg gave a very clear and useful account of it. He said, "This is an invention which has been in use for a great number of years, and, because few people understand it, it is not as much in use as it ought to be. It often happens that though a spring of water cannot be obtained near a house, one is found at a lower level. The question then is, How is the water to be raised to the high level with the least possible trouble and expense? It is in such cases that the 'water ram' is of invaluable use. It can be put to work in any place where a fall of water of 1 foot or upwards from a stream, brook, or spring can be obtained. It will force water to a vertical height equal to from twenty to thirty times the height of the fall, drive the water to any horizontal distance which may be required, and work day and night without any attention whatever."—EDWARD LUCKHURST.

BOOKS FOR YOUNG GARDENERS.—Several eminent men have been criticising the actions of young gardeners in your paper for several weeks past; may I remark that I think it would be more useful to have given them something for their benefit? We want to know the best books on gardening and botany, chemistry and drawing, and the

best instruments for the same, and the cheapest places for purchasing. If there are black sheep in our flock, the white ones will willingly accept any advice offered that will be of substantial value.—G. A. B., a Foreman.

NICOTIANA AFFINIS.

THIS attractive relative of "the fragrant weed" is fast becoming a great favourite with all who have learnt its character, and that it will still further grow in popularity cannot be doubted, as its qualities are not at present fully known. For beds and borders during the summer it is very useful, flowering most profusely, and yielding in the evening a most pleasant fragrance that can be perceived at a considerable distance. Another method, however, which Messrs. H. Cannell & Sons adopt at Swanley, deserves special notice, as it greatly increases the utility of the plant. Seed is sown in September, and the young plants so obtained are potted singly and grown on to flower during March, April, and May, at which time they prove most useful for conservatory decoration, their large white sweetly scented flowers being greatly appreciated. Indeed, by successive sowings of seed probably plants could be had in flower nearly all the year. They are easily grown, a rich light compost of turfy loam, leaf soil, sand, and well-decayed manure suiting them, and abundance of water is needed, so that it is advisable to drain the pots carefully.

As regards the origin of this plant there is a little mystery. English horticulturists are indebted to W. Cullingford, Esq., Phillimore Gardens, Kensington, for its introduction; and he, it is said, obtained the seed from Hyères, and there the history ends, for we have no reliable information as to its native country or when it first appeared in cultivation.

PROFITABLE POTATO-GROWING.

I SEE by the letter of "Single-handed" on page 238 that my remarks about the Potato fungus have not been quite understood by him. I could not, of course, go much into detail on the form sent, but I shall be pleased to afford further information. A short time ago Messrs. Sutton published a statement of the cost of cultivating an acre of Potatoes, showing as a result of the operation a considerable profit. I do not wish to discourage anyone from growing Potatoes—quite the reverse; but instances have come to my knowledge, and have been practically experienced by myself, where the profits have fallen short of those mentioned by Messrs. Sutton, and sometimes the grower has experienced a loss.

There are several things to be taken into consideration in Potato culture. In the first place the grower, if a beginner, should only have two or three acres, for there is generally something to learn in the cultivation of a new crop, and then there is the difficulty of marketing a large quantity of Potatoes. A grower who has a connection and knows where to place his crop has an advantage over one who does not, and if he lives near a large town and has a retail connection he is still better off. Then there is the disease to be considered. I find that by confining my growth to Early Rose and Magnum Bonum I avoid the disease altogether—at least, for all practical purposes. In my experimental ground in 1881 I had four sacks of Early Rose Potato and no disease whatever, and ten sacks of Magnum Bonum and only three diseased tubers, and last year the result was pretty much the same. I watch the Early Rose, and dig up before they are much injured, and the Magnum Bonum I am not afraid of. Not much manure is used, and that I prefer put on in the autumn. That is the right way for garden cultivation, but I am in doubt about it for field cultivation. The land round Cirencester is not by any means rich, and would not grow the crop mentioned by Messrs. Sutton without help.

I will now make a comparison of the probable result of the cropping of two cultivators, A and B. We will suppose that A spends altogether £25 an acre in rent, taxes, and cost of cultivation, &c., and that his crop is 5 tons. Now if he sells his Potatoes at £5 a ton only he makes no profit, and supposing he by economy keeps down the expenses a little there is but a small margin of

profit. I am supposing that he uses ten loads of farmyard manure. Now suppose B, instead of ten loads of farmyard manure, uses twenty and spends £2 an acre on artificials, and by that means produces a crop of 8 tons. He will have three more tons for sale, value £15, out of which deduct £4 10s. for the extra manure, and he will have a profit of £10 10s. an acre, which I think he ought in a general way to get. I am supposing that only Magnum Bonum and other disease-resisting kinds are grown.

In my remarks a short time ago in the Journal I said that a person, like B, who grows his Potatoes with a large quantity of manure, ought not to plant any of them in the following year, because the mycelium of the fungus will be very likely to be largely developed in them, and tend if planted to materially injure the prospects of a crop in the following year. The mycelium of the fungus is often present when the Potato apparently has nothing the matter with it, but such Potatoes are apt to have a diseased germ and throw out a diseased shoot in the following

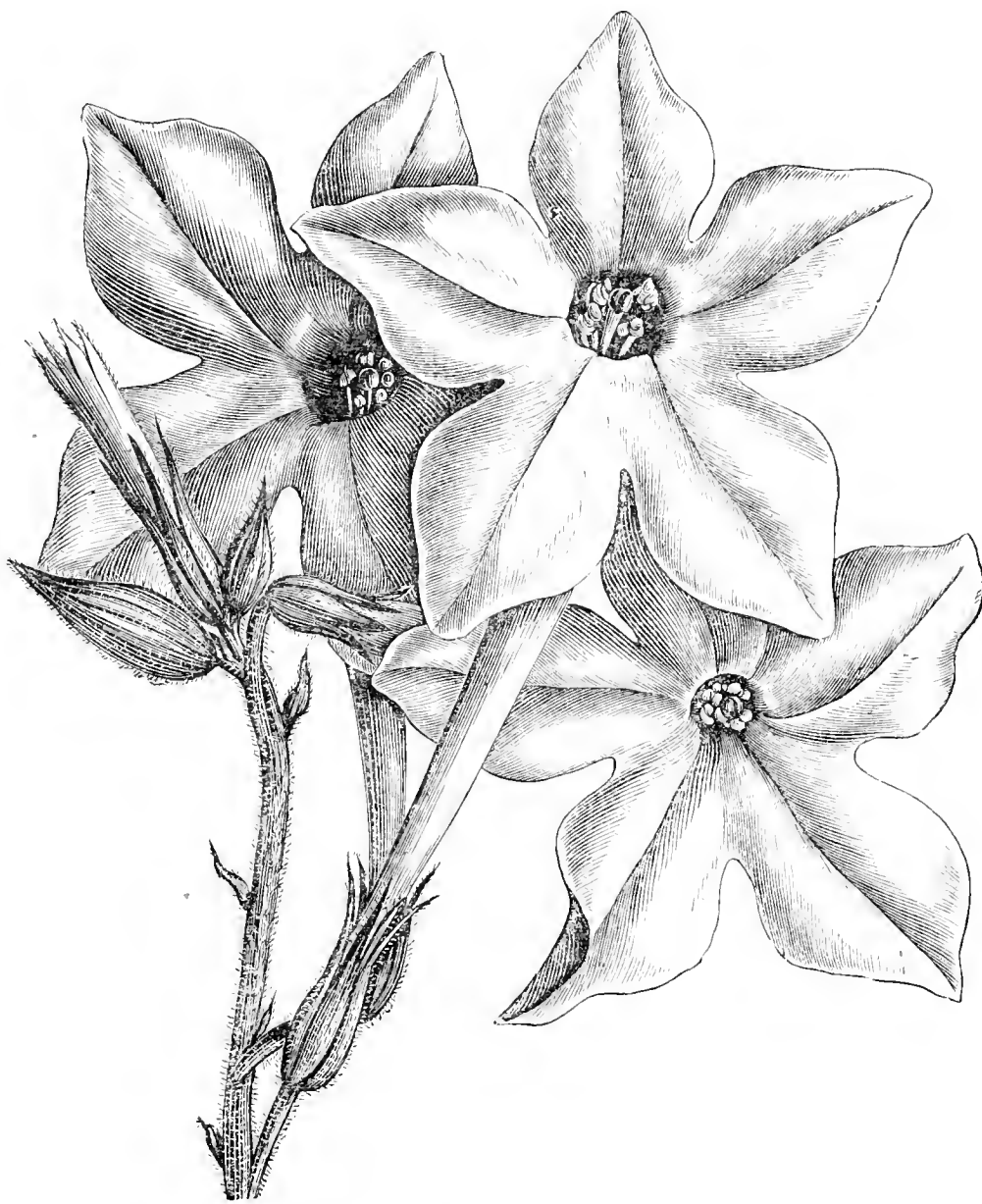

Fig. 71.—NICOTIANA AFFINIS.

spring or early summer, and so spread the disease. Potatoes may have the mycelium of the fungus in them and yet be perfectly wholesome; they are not what is called diseased, but merely have the seeds of disease in them. It is a common remark, "Oh, my Potatoes were all right when I dug them up, but they went off afterwards." This is to a certain extent a figure of speech. The mycelium of the fungus is present in all such cases when the Potatoes are dug up, and large quantities of them are consumed under such circumstances, but they are not injurious. The cultivator should grow the Potatoes which he intends to plant the following year in another field without much manure, or send to a nurseryman for them.—FREDERICK BRAVENDER, *The Firs, Cirencester*.

FINE CINERARIA BLOOMS.—An idea seems to have become somewhat prevalent in many localities that the finest strains of many

florist's flowers, especially Cinerarias, are only to be obtained from the continent. I have seen many proofs in England, Ireland, and France too, to the contrary; the latest being some really fine Cinerarias, a few days since, in the conservatory of Mrs. Malcolmson, Minella Gardens, near this town. A gentleman amateur, of more than local fame, at the time measured some of them, and found them a little over 3 inches in diameter—in size, form, colour, and substance the finest strain I had ever seen—obtained from a noted English firm. One, especially, with the pure white eye of March Past, certificated by the Royal Horticultural Society, but magenta crimson, was very notable.—W. J. M., *Clonmel*.

MAKING AND RENOVATING LAWNS.

(Continued from page 273.)

ALTHOUGH laying turf and sowing seeds have been adverted to, it is necessary to refer more particularly to draining the ground and preparing the soil. The beauty of a lawn consists in the evenness of its surface and the richness of its verdure. This latter can only be produced in well-drained soils. Where there is water in the subsoil, whether that be stiff or sandy, drains must be provided for carrying it off. For most soils drains 30 inches deep are ample, and their distance apart will need to be determined by the "drawing" power of the soil. If the soil be a stiff clay 12 feet will be suitable, and if such be intermingled with stones 3 feet greater distance will suffice, whilst where the subsoil is sandy or of a porous nature 18 to 21 feet distance apart will meet every requirement of the case. Two-inch pipes are the smallest that should be used, and 3-inch are in every way preferable from the drains being longer serviceable. It is essential that the mains be correspondingly larger, and all have proper falls and outlets.

The next most important consideration in making a lawn is to have the soil of an even depth throughout, so that the grass may be marked by regularity of growth. If in forming an even surface it be necessary to take some parts down and fill up others, the top soil should in each case be first removed and laid aside in order that it may be again returned after the inequalities are rectified, the bad soil being taken out from the hills and put at the bottom in the hollows. This is not always done—the good soil where the hills were is not 3 inches deep if that, and in the hollows it is as many feet, and then it is wondered why the lawn should be so patchy—a bright green in some places, and so brown and poor in others. Hungry subsoil should never be spread near the surface for a lawn.

In the matter of improving the texture of the soil a few remarks only will be made. Soil of a heavy tenacious nature would be much improved by an admixture of ashes, lime, brick, or other rubbish, incorporating it evenly with the soil as deeply as that is moved. If the soil not only be of a heavy nature but be thin with solid clay under it, it would be advisable to have as much of the clay burned as practicable, first removing the good soil and laying it aside, then removing the clay for burning, and before putting on the good soil loosen the clay below that removed for burning, and when the latter is effected spread it on the surface and mix it evenly with the soil by forking over a few times in dry weather only. This will be an enduring improvement, affording a better growth of grass, and in every sense a more satisfactory lawn.

Where the soil is of a poor sandy or gravelly character a good coating of clay or marl, a hundred cartloads per acre not being too much, spread on evenly and allowed to be acted on by frost will fall, and be in a fit state for mixing with the soil to the depth of about a foot. This will render the soil more moisture-holding, and contribute to the staying power of the grass in a dry time, and impart at all times a fresher appearance.

Except limestone soils there are few that would not be improved by a dressing of lime, which may be given at the rate of 4 to 6 tons per acre, and should not be dug in, but after being spread should only be harrowed or pointed in lightly with a fork, for it will sink quickly enough without being put down deeply at the commencement. If the soil be poor a good dressing of manure will help on the growth of the grass and secure its speedy establishment by encouraging a good root growth.—G. ABBEY.

ROYAL CALEDONIAN HORTICULTURAL SOCIETY'S SPRING SHOW.

THIS was held on April 4th and 5th, with extended and liberal prizes, proving one of the best this Society has held at this season. The weather was favourable, so that we may hope the receipts were satisfactory. The schedule is divided into eight sections, five of which are for gardeners and amateurs, two for trade growers, and one for foreign exhibitors. The general arrangement of the Show was much lighter in appearance than in former years. This has been attained through the simple and natural plan of arranging all

the larger plants in groups on the floor of the building, while keeping stages for the smaller plants, cut flowers, and fruits.

PLANTS.—We have merely noted those exhibits which were of some merit, some of the plants shown, such as Wallflowers, Polyanthus, Auriculas, Gueldres Roses, and Lilacs, being of the poorest description. In the class for a table of plants, 20 feet by 5 feet, only two competitors met, that of Mr. R. Grossart, gardener to Mr. Buchanan, Oswald Road, Edinburgh, being easily first. This was lightly arranged with Palms, Dracenas, and other fine-foliage plants, Orchids in variety. The edges of the table were relieved with alternate plants of *Isolepis gracilis*, Maidenhair, and variegated *Panicum*, all of which would have been of great effect had they been a little larger. For a table of hardy spring-flowering plants, 10 feet by 5 feet, Mr. C. Smith, gardener to Mr. Wilson, Restalrig House, Edinburgh, occupied the premier position, staging a great variety of Primroses, Iris reticulata, Daffodils, Anemones, and others. For six *Azalea indica* Mr. J. Patterson, gardener to Mr. Syme, Millbank, was first with neat well-grown plants. The sorts were *Model*, *Duc de Nassau*, *Duchesse de Nassau* (2), *Iveryana*, and *Roi Leopold*. Mr. Paul, Gilmore Place, Edinburgh, was second with specimens not nearly so well flowered. The same exhibitors were successful for two and one specimen *Azalea* respectively. There was good competition for prizes offered for plants in 8-inch pots, but in no case were the specimens good.

For eight stove or greenhouse plants, distinct sorts, six at least to be in flower, and not more than two *Azaleas*, Mr. Paul took the first place; a good *Anthurium Schertzerianum*, a couple of fair *Azaleas*, a very large and well-bloomed *Phajus Wallichii*, an *Amaryllis Johnsonii*, and a Countess of Haddington *Rhododendron*, were the more telling plants. For four stove and greenhouse plants, the plants staged were small, the first-prize lot of Mr. McLure, gardener to Mr. Milne, Toulty, Granton, being fresh and well-flowered. For six *Rhododendrons* in pots or tubs, and in the corresponding prizes for three and one plant respectively, some good specimens were contributed, Mr. R. Grieve, gardener to Miss Falconer, Falcon Hall, being first for six; and Mr. T. Donald, gardener to Mr. Younger, Grange Loan, Edinburgh, first for three. For four Cape Heaths Mr. J. Patterson was first with small though well-bloomed specimens, Mr. J. McCormick being first in the class for three of the same.

We come now to the Orchids, which filled a large table, and formed one of the features of the Exhibition. The prizes for these might be advantageously increased without any extravagance, as only 80s. were offered for six plants as first prize, 40s. for three, and 20s. for one. For the six plants Mr. Priest, gardener to the Marquis of Lothian, Newbattle, Edinburgh, gained the first place, the most prominent plants being a *Vanda tricolor* with six spikes, a large plant of *Dendrobium fimbriatum* var., and a good panful of *Masdevallia Lindenii*. Mr. Paul was the only other exhibitor, and staged good masses of *Cymbidium eburneum* with about a score of blooms, a large mass of *Cœlogyne cristata*, and a *Cymbidium Lowianum* with three lengthy spikes. For three Orchids Mr. Curror, gardener to Mr. Douglas, Eskbank, took first; and for one Orchid Mr. Grossart had the same position with an enormous mass of *Cœlogyne cristata* about 4 feet across.

Prizes were offered for six Pitcher-plants, but we could find no trace of these in the Show. Several distinct prizes were offered for Ferns, the most important being for six exotic Ferns, not more than one each of *Gleichenia*, *Adiantum*, or *Tree Fern*. Most of these were poor, but for three *Gleichenias* Mr. Paul staged three good and large examples of *G. semi-vestita*, *G. dicarpa*, and *G. flabellata*. Mr. W. Anderson, Pilrig Buildings, Edinburgh, staged three good *Filmy Ferns*, for which the first prize was awarded. These were *Trichomanes radicans*, *T. reniforme*, and *Todea superba*. The same exhibitor took first honours for six British Ferns in 6-inch pots with remarkably healthy examples of *Trichomanes radicans*, *Hymenophyllum tunbridgense*, *Asplenium fontanum*, *A. septentrionale*, *Polystichum lonchitis*, and *Asplenium lanceolatum microdon*.

Fine-foliage plants were not numerous and were mostly small—too small to have effect in the very large building in which they were staged. For four of these, excluding Ferns, Mr. J. Patterson was first with a large plant of variegated *New Zealand Flax*, a variegated *Aloe*, *Croton variegatum*, and a large *Latania*. The prizes for eight foliage plants, pots not exceeding 8 inches in diameter, brought out some well-grown plants. Here Mr. McCormick was first, closely followed by Mr. R. Grossart. The prizes for plants for table decoration also brought together a number of competitors. Mr. Grossart was awarded the first place for these, Mr. McIntyre being second. The whole of the plants of the various competitors were very much alike, and appeared to be rather small for the purpose denoted in the schedule. Prizes were offered for *Dracenas*, *Crotons*, and *Palms*, but none of the plants of these called for particular mention.

Mr. Gordon, Niddrie House, Liberton, was awarded the first prize for six *Roses* in pots with good plants, Mr. Patterson occupying the same position for three *Roses* in pots with not so large but fresher plants than in the foregoing. Prizes were offered respectively for twelve and six *Cyclamens*. The plants of these were not large, but very good as regards quality of bloom. For the twelve Mr. Gordon was first, and for six Mr. Low, gardener to Dr. Cossar, East Craig, Corstorphine. *Amaryllis* and *Pelargoniums* were not in good order. *Cinerarias* were rather poor in the quality of strain, the plants moreover being too small; while the Chinese *Primulas* were in all cases

past their best. A *Richardia* with about twenty spathes secured the first prize for this to Mr. R. Bell. Mr. T. Macdonald secured the first prize for four strong specimens of *Spiræa japonica*. A large table was occupied with *Mignonette*, most of which was really fine. For two standards Mr. J. Richardson, gardener to Sir R. Dick Cunningham, Bart, Prestonfield, was first, his plants having heads about 3 feet over and in vigorous health. Mr. S. Graham was second, also with examples of good culture. Mr. G. Greig was first for a single standard, very good, and Mr. McLure second. For two pots *Mignonette* Mr. W. Penn was first with close and dwarf bushes about 4 feet across, Mr. G. Greig second with stronger-grown plants but lacking the finish of the former, while to Mr. J. Richardson an extra prize was awarded for plants little behind either of the other prizewinners. *Lily of the Valley* was also numerously represented, being on the whole very good throughout, though the foliage was rather lacking in size. For three pots or pans Mr. McLure was first, Mr. Pearson being second with what had been much better "stuff" a week before. For one pot or pan of the same Mr. T. Grieve took first. *Dielytras* filled a large table. Some very good *Deutzias* were also set up close to the *Dielytras*, Mr. McCormick being first for two plants; and Mr. John Glass, Whitepark, in the same position for one plant. The prizes for six alpine plants brought out some bright collections. Mr. D. Forrester, Woodcockdale, Linlithgow, was awarded the first prize for *Primulas helvetica*, *viscosa nivea*, *rosea*, and *denticulata*, and *Narcissus Bulbocodium* and *Trillium grandiflorum*. Mr. G. Forrester, Polmont, was second with much the same kinds.

Bulbs.—The first four series of prizes were devoted to *Hyacinths* in twelves, eights, sixes, and sixes for amateurs only. Generally the *Hyacinths* were poor, wanting in length of spike, and with a general looseness of build apparent. For the twelve, Mr. McLeod, Blind Asylum, West Craig-Millar, was first, and Mr. McLure second. For eight plants, Mr. Syme, gardener to Mr. Lindsay, Ridge Park, Lanark, was first, and Mr. Pearson, Beechwood, Corstorphine, second. Both of these were superior to the plants in the twelves. Mr. Stewart, High Street, Haddington, took first in both the sixes with good plants. *Tulips* were shown in 9-inch pots, some two dozen bulbs in each. Though more showy as a whole, the quality of the flowers was not so good as where only three bulbs are grown in each pot. Mr. W. Penn was first for eight, and Mr. G. Greig first for six. For six pots of *Polyanthus Narcissus* (also in 9-inch pots) the competition was poor, Mr. Pearson taking the first prize. *Garden Narcissus* were staged by only one exhibitor, Mr. McLure.

Cut Flowers.—For twenty-four *Roses*, not less than eight sorts, Mr. J. Gordon was awarded the first place for good blooms. For twelve, not less than six sorts, Mr. Bowman, gardener to Lord Deas, Pittendriech, was first with lovely *Tea Roses*; Mr. Murray, gardener to Marquis of Ailsa, Culzean Castle, second, and Mr. Sheack third. Twelve *Gloire de Dijons* were staged, but poor. But if these were poor the *Maréchal Niels* were simply superb, the twelve staged by Mr. Pearson, Beechwood, being enormous globes of golden yellow. Mr. Dow, gardener to Sir D. Baird, Bart., Newbyth, was second with very good blooms, and a large number of boxes containing blooms of good quality were also staged. Prizes were also given for *Camellias*, of which there was a good display, and for *Rhododendron trusses*. For both hand and table bouquets Mr. R. Grossart was first with very good arrangements.

Fruit.—Some good well-kept *Apples*, a dish of good *Strawberries* from Mr. Dow, a good *Pine Apple* from Mr. McIntyre, and some examples of *Black Alicante Grapes* of extra merit were shown. The last were *Black Alicantes*, both first and second-prize lots being well kept, fresh, with the bloom and colour perfect. Mr. S. McKinnon was first, and Mr. Grieg second. Some *Strawberries* were shown in pots, but nothing noteworthy was noted of these.

In Class 5, devoted to *Vegetables*, a good collection of vegetables gained first prize to Mr. Potter, Seacliffe, North Berwick. It contained good *Leeks*, *Trebons Onions*, young *Carrots*, *Niddrie Protecting Broccoli* (white as *Cauliflowers*), *Mushrooms*, large *Brussels Sprouts*, *Seakale*, *Kidney Beans*, young *Potatoes*, &c. Mr. J. Stewart had first for a collection of *Salads*. Amongst other vegetables was a fine dish of *Mushrooms* from Mr. McIntyre, to which first prize was awarded.

The two classes set apart for nurserymen was the one for ordinary plants and the other for bulbs and cut flowers. The first prize in Class 6 was for a table of plants arranged for effect. Here Messrs. Ireland & Thomson were easily first with a table conspicuous by the richness and brightness of its contents; Messrs. Methven & Sons were second with a table containing plants of a commoner character. For twelve hardy *Rhododendrons*, distinct sorts, in pots or tubs, Messrs. R. B. Laird & Sons were first with enormous plants; were *fastuosa fl.-pl.*, lilac, fine; *Prince Camille de Rohan*; *Comet*, crimson; *Joseph Whitworth*, very dark; *Auguste Van Geert*, light rose; and *Jean Stern*, a light variety with large individual pips. The Lawson Seed Company were second with much smaller plants. For six *Rhododendrons* Messrs. Methven & Sons were first with good plants of *Grand Arab*, *Prometheus*, *Lord Wolseley*, clear crimson; *Barclayanum*, Mr. John Waterer, and Lord Palmerston. Messrs. R. B. Laird and Son were first for six greenhouse *Rhododendrons*, but the plants had been much damaged; a specimen of *exoniensis* was, however, in good order, and showed what the others ought to have been had they not been unfortunately shaken so much. The Lawson Seed and Nursery Company staged twelve *Coniferæ*, to which the first

prize was awarded. R. B. Laird & Son were first for table plants; Messrs. Ireland & Thomson for new or rare plants; Mr. Robertson, Munro, Portobello, for hardy plants.

Class 7 was devoted to Dutch bulbs and cut flowers. Messrs. R. B. Laird were first for twenty-four *Hyacinths*, and Mr. Sutherland, sen., second, the same exhibitor taking the prizes for twelve *Hyacinths*. For twelve cut *Roses* Mr. Wilson, Kendal, was first, also for twelve *Maréchal Niel Roses*, but these were not so fine as in the gardeners' competitions. For a hand bouquet Mr. Sutherland was first; for that of a bride Mr. Wilson, and for six buttonhole bouquets Mr. G. Sinclair, Prestonkirk.

Amongst the miscellaneous exhibits Mr. Wilson, Kendal, showed a stand of lovely *Niphetos Roses* and floral crosses and wreaths. Hardy flowers were numerously staged by Mr. Robertson Munro, and Mr. S. Sinclair. Messrs. Dickson & Co. set up a table of *Cinerarias*, and a basket of cut *Orchid flowers* was awarded a first prize. These were from The Woodlands, Perth.



WE may remind our readers that the eleventh quinquennial International Exhibition of the ROYAL BOTANICAL AND AGRICULTURAL SOCIETY OF GHENT opens on the 15th inst. in the old Flemish city, and closes on the 22nd. Although it will not, probably, be of such a marked international character as regards the exhibits as has been the case in some previous years, some of the chief English nurserymen not being expected to compete, the display will the better represent Belgian horticulture. Many persons from England will visit the Show, and we wish more could do so, if only to experience the frank, genial, hearty welcome they would receive from our friends in the "City of Flowers."

— AT a General Meeting of the ROYAL HORTICULTURAL SOCIETY, held last Tuesday, J. J. Wheble, Esq., F.R.H.S., in the chair, the following candidates were unanimously elected Fellows—viz., W. H. Clark, Miss Isabella Cockburn-Hood, Albert Cooper, Edward Dent, W. G. Emberlin, Luke Finney, Capt. C. R. Hargreaves, W. P. Hummerston, Robert A. Kemp, Dr. Kirby, James Lye, Charles Noble, Osbert Salvin, F.R.S., George Thomas, Sir Francis Wyatt Truscott, and Ernest White.

— CUCUMBER AND MELON DISEASE.—We have been asked to say that if any nurserymen or gardeners have their plants attacked by the above, or with cobweb fungus on seeds or cuttings, they can be supplied with a material that will probably destroy the disease, with instructions, gratis and carriage free, from E. W. Smith, 109, Cheapside, E.C.

— THE Leeds Horticultural Gardens Company (Limited) announce that they will hold a FLORAL AND HORTICULTURAL EXHIBITION June 19th and 20th in the Gardens. Schedules can be had on application to G. Bush, Secretary.

— "SALTBURN" writes to us as follows relative to VINES BLEEDING, but is the remedy a safe one?—"The bleeding of Vines will be stopped at once by moving the earth at the base of the stem and pouring down two or three pailfuls of cold water. The necessity of watering greenhouse, stove, or frame plants with water of the same temperature as the greenhouse, &c., has been over and over again insisted upon in this Journal. The above sentence relative to Vines bleeding explains the philosophy of the advice."

— WE understand the AURICULAS AT SLOUGH (Mr. C. Turner's) are in very fine condition this year, a collection of 2500 plants being in bloom, which admirers of this charming spring flower are invited to inspect.

— MR. MALLENDER, The Gardens, Hodsock Priory, sends us the following interesting note on the WEATHER IN NOTTINGHAM—

SHIRE :—" I thought it might interest some of your many readers to know that we are having more sunshine this season than we have had for several seasons past, and if it will continue as it has begun it will be a great boon to this country. We already have had this year 264.6 hours of bright sunshine here up to the end of March, and only twenty-nine sunless days. The rainfall for January was 2.51 inches ; for February, 2.73 inches ; for March, 1.15 inch, the last month being the driest here since July, 1881 ; but if the driest it was most severe. During the past eight years only four months have had a lower mean temperature—namely, January, 1879 and 1881, and December, 1878 and 1879. Snow fell on fourteen days. The thermometer in the shade fell below 32° on twenty-five nights, and on the grass on twenty-seven nights. The morning of the 10th the thermometer on the grass registered 34° of frost, which has only been exceeded twice in the last four years—namely, in December, 1879, and January, 1881. February was very mild and vegetation very forward, so that injury to the fruit blossom is very serious. The observations here are strictly kept, the instruments have all been verified at Kew, and a Stevenson's screen used, so that the readings may be relied on."

— THE CROYDON HORTICULTURAL SOCIETY will hold their seventh annual summer Exhibition on Wednesday, June 27th, in the grounds of Wellesley House, when prizes will be offered in 124 classes for plants, flowers, fruits, and vegetables ; but special provision is made for Roses, liberal prizes being offered in nineteen classes, besides the National Rose Society's silver medal for the best blooms in five classes, and a piece of plate value three guineas, presented by Edward Mawley, Esq., for the best twenty-four Roses, distinct.

— IN a parcel of MESSRS. CASSELL, PETER & GALPIN'S MONTHLY WORKS we have part 50 of *Familiar Garden Flowers*, giving coloured figures of the Gloxinia and Double Trumpet Daffodil, with descriptive letterpress ; part 73 of *Familiar Wild Flowers*, including the Thrift and Bladder Campion ; part 32 of *Paxton's Flower Garden*, which has coloured plates of *Trichopilia coccinea* and *Dendrobium albo-sanguineum*, as well as several woodcuts in the "Gleanings ;" part 1 of a re-issue of the *Dictionary of Cookery*, a useful work, abundantly illustrated ; and part 1 of the *Doré Gallery*, which is devoted to engravings selected from the editions of Dante, Milton, and others issued by this firm, and illustrated by M. Doré.

— WE are sorry to learn that the HORSHAM ROSE ASSOCIATION, after having been in existence for six years, and after having held six capital shows, has been dissolved owing to the want of public support.

— AT the next meeting of the METEOROLOGICAL SOCIETY, to be held at 25, Great George Street, Westminster, on Wednesday, the 18th inst., at 7 P.M., the following papers will be read :—" Cirrus and Cirro-Cumulus," by the Hon. F. A. Rollo Russell, M.A., F.M.S. "Notes on Waterspouts, their Occurrence and Formation," by George Attwood, Assoc.M.Inst.C.E., F.G.S. "Record of Bright Sunshine," by W. W. Rundell, F.M.S. "Note on Wind, Cloudiness, and Halos ; also on Results from a Redier's Barograph," by Edward T. Dowson, F.M.S.

— PRESERVED FRUITS.—A few weeks ago we published an account of the great fruit farm which Lord Sudeley has formed at Toddington in Gloucestershire, and which has been leased by Mr. T. W. Beach of Ealing Road, Middlesex. It is there stated that Mr. Beach has taken the whole of the produce of the five hundred acres, to dispose of it either fresh or preserved. Mr. Beach has had long experience as a fruit-grower and preserver, and he has found there is sufficient demand for pure jams to induce him to confidently expect the most satisfactory results both

for Lord Sudeley and himself. About Maidstone and some parts of Kent the "boilers down" of fruit are called "fruit-smashers," and this is not an inapt designation for them, for the fruit is really smashed, and a sort of preserve is turned out which no doubt finds favour with the masses of the population. Mr. Beach is not a "smasher," but a true preserver. We have seen some of his productions, and we do not exaggerate when we say that they are fit to take their place with the finest that can be turned out by the skilful confectioner. The Strawberries and Raspberries are especially beautiful, and remind us of the days of old, when a certain careful housewife superintended the making of her own jams, and gladdened our young hearts by dealing out the scum to us as a reward for our good behaviour while being permitted to view the process. These are really preserved fruits, not one of them being bruised, but each as perfect as when gathered, and all floating in a transparent syrup. The Plums and Apricots are of course broken up, the Gooseberries are whole. These preserves are made by Mr. Beach on a large scale for wholesale trading, and are put up in glass bottles of various sizes, some holding about two quarts, and from our own experience of these excellent productions we can strongly advise our readers when they require preserved fruits to inquire for those prepared by Mr. T. W. Beach.

— AT the Agricultural Hall, Islington, the BUILDING TRADES EXHIBITION now being held is both extensive and interesting, comprising a great variety of appliances and materials. Many horticultural builders and hot-water engineers also contribute largely, the principal being the following :—Messrs. Matthews and Co., Weston-super-Mare, a large stand of ornamental pottery, tiles, &c. ; Hopc & Co., Birmingham, boilers and samples of glazing ; W. Richardson, Darlington, has portable frames, greenhouses, and lath blinds ; John Warner & Co., Cripplegate, have a number of pumps ; Messenger & Co., Loughborough, have a large space devoted to boilers and greenhouses ; The Thames Bank Iron Company also have boilers, valves, pipes, and ventilators ; J. Thomas and Co., Queen Victoria Street, have a great variety of wire arches, fowl runs, &c. ; Jeffrey & Co., Oxford Street, also show ornamental wirework, greenhouses and garden seats ; and Mr. B. W. Warhurst, Highgate Road, samples of his various patent boilers.

— MR. C. S. FUDGE, Secretary of the SOUTHAMPTON HORTICULTURAL SOCIETY, writes :—" We have embarked in a scheme for securing a place for the Society's Shows for fourteen years at least. Although not such an arrangement as we could have wished, still it is the most favourable we could get, and at any rate will prevent our being built out for some time to come. The land we have secured is very well situated—just far enough to take it away from the worst of the town smoke, and yet near enough to secure a good attendance. It is ten acres in extent, abuts on to the beautiful Southampton Common, is well wooded with some fine trees, has first-rate approaches, and is close to tram line. The Society intends to celebrate its twenty-first anniversary by the public opening of the grounds. As evidence of the growth of this Society, I may mention that when I took my present office ten years ago the Society consisted of 160 members, with a total income from all sources of about £250. We now number over a thousand members, and last year our income amounted to over £1200."

ROSES—EARLY OR LATE PRUNING.

I QUITE fail to see the force of the observations on page 278 that it may be well to prune early in the south but less safe to do so in colder localities. In my view precisely the reverse is the case. I have pruned Roses for twenty-five years in a cold northerly district—a few in the autumn and the greater number in spring after the growths on the extremities of the shoots were often 2 or 3 inches long. The latter I have found by far the safer

practice, though during some seasons the early-pruned plants produced earlier blooms, which were acceptable. During all that time, and among the thousands of plants that have been under culture, I have not observed any material injury result from bleeding.

Early pruning results in the base buds starting into growth too soon, and if these are cut by such frosts as prevailed a fortnight ago the plants are permanently crippled; and these growths are produced earlier in the south than in the north, as I have had incontrovertible proof, having had something to do with Roses both south of the Thames and north of the Humber.

Mr. Moorman describes the safe plan, for a season like the present especially, on page 238. I went to see him a week after his letter appeared, and found him practising what he had preached, for he was then busy with the scateurs. Many of the early growths towards the extremity of last year's shoots were 3 inches long, and in some of them buds had formed. These growths had all been killed by the frost, but there were plenty of bold buds on the lower parts of the stem as safe as if there had been no frost. To these buds the shoots were being shortened, and a strong free growth will be the certain result if the weather be even moderately genial, as we may fairly expect it to be now.

I have also visited another garden in which the Roses were pruned in the autumn. The locality is south of the Thames and the position sheltered. On these Roses all the buds left had started previous to the frost, and at least 90 per cent. of the growths are killed. It is a question if some of the plants are not killed also, but there is no question as to their inability to afford even a half-satisfactory display of Roses during the ensuing summer.

But will not the plants that had grown so freely before Mr. Moorman pruned them bleed? I venture to say that not an ounce of sap will escape from a hundred of them. The frost, by killing the young growths, had checked the flow of sap, and that which is now supplied by the roots will be appropriated by the succeeding growths now just on the eve of starting.

Another question. Have not the plants been weakened by first being allowed to grow so freely, and then cutting off these growths by the armful or barrowload? The answer, though all persons may not accept it as satisfactory, must again be in the negative. The very production of the growths incited root-action in the same proportion; and although the extension of the new roots would cease for a time by the removal of the branches, the roots themselves would not die. "How do you know this?" some incredulous reader may soliloquise. I know it by having tested the matter on Roses grown in pots, and I am not quite sure that anyone is competent to refute it who has not made similar experiments.

But the Roses themselves under Mr. Moorman's care answer what may be termed the vitality question. They have always been pruned in the manner and condition indicated, and if the process were a weakening one the plants ought now to be miserable starvelings, and especially as they are growing in light gravelly soil and in a very dry position; yet, on the contrary, they are in the most satisfactory condition, the growth being surprisingly good. On stronger real Rose-growing soil I have had growths 6 feet long on plants that for years have been pruned after the bushes were a mass of green shoots. This, then, I submit is the safe mode to adopt; and whether it or any other method of pruning will result in a certain number of blooms being ready on a particular day for showing depends, I fancy, more on the weather during April, May, and June than on any particular time that the shoots are shortened. What do others say?—AN OLD HAND.

WEATHER AND WORK.

LAST month will long be remembered for its severity, and coming as it did after a mild February and a very mild January, we cannot yet estimate fully its effects on vegetation, which was more than usually susceptible to its influence. Roses which passed two terribly severe winters unscathed, because the cold came before they were excited into activity, are this season the subjects of considerable anxiety. Many of them appear to be growing all right at present, but it is very probable they will show the effects of ruptured sap vessels before long. They were in February getting quite into vigorous growth, and it was a question whether pruning had not better be done then. Nearly two months have passed and many are still unpruned.

Potato-planting was considerably delayed in its commencement, but with the dry weather and the extremely good condition of the soil we have made up arrears in this department. In accordance with our practice of late years no ground was dug before February, and as February was an extremely wet month none was dug then.

With the sunshine and frost in the early part of March all available strength was put on to digging whenever the ground was not too hard for the purpose, and the surface quickly became pulverised and in the best possible condition. Loth to lose a chance of planting the Potatoes while the weather was dry, as the season was getting along fast, I took a leaf out of Mr. Coleman's book, as detailed in this Journal for March 8th, and placed the sets on the surface, or rather drills were made about $1\frac{1}{2}$ inch deep, so that the Potatoes when laid down had their surface about level with the surrounding soil, and then they were earthed up about 3 inches deep. It will be seen I have not followed Mr. Coleman's plan exactly, but I am indebted to him for the idea of placing the tubers on the surface, and I have no doubt it will be an advantage on our soil, which, like his, is cold and heavy as well as shallow. We usually plant Champions 30 by 15 inches, but as the ridges will be higher than usual by the time they have received their final earthing, and of course more soil will be used for the purpose, we have given them a greater breadth between the rows and less between the sets. They are now 36 by 12 inches.

No manure has yet been applied, as in the ordinary way it would have been applied at the second digging and planting, but the ground is in very good heart, and we shall apply some artificial manure at the final earthing-up, which will take place as soon as the rows are visible.

I believe many a cottager's crop of Potatoes is spoiled by earthing up too late. The rows are often not more than 18 inches apart, the Potatoes are allowed to grow 6 or 7 inches high, by which time their roots meet between the rows, and earthing up at that time certainly does more harm than good.

Like "Single-handed" (see page 238), we plant late Potatoes before the midseason varieties, as will be seen by my report in the Journal, and that plan is generally practised about here by the cottagers, although I believe it is not common in many places. Peas, too, could not be sown in the ordinary way. The ground was too wet to dig, and had the Peas been sown they would have been quickly devoured by the little black slugs which eat out the centres and then curl themselves up in their shells. We therefore took out the soil a spade's width and 3 inches deep, making a little bank with it on the east side of the trench, a little dissolved bone was scattered over the bottom and covered with an inch of fine soil. The Peas were then sown, after being red-leaded, and they were covered with 2 inches of burned clay. Although they were a long time coming through, owing to the cold weather, they did come at last, and they look extremely well. A second sowing made a month later was done in a similar manner, and these are nearly as forward as the first in appearance, but being of the best class of Marrows will, of course, be longer in coming in.

Our Peach trees had many flowers expanded in February. We knew it was of no use trying to save such as were open then, so the frost was allowed full play, the covering, excepting a coping board, being deferred till the end of March. The result is that, although most of the early blooms are killed, those which were not expanded, and the foliage as well, were retarded, so that there is now a fair prospect of a crop from the late blooms. Peach blooms while dry are much hardier than many people imagine, and many a crop is spoiled by too much covering. Apricots are much more tender as well as earlier, and are gone beyond all hope.—WM. TAYLOR.

NOTES FROM MY GARDEN IN 1882.—No. 3.

ROSES.

A NEVER-ENDING theme, and yet, I believe, to the readers of the Journal a never-wearying one. There are so many aspects of it, so many different experiences, so much variety of opinion, that there is never to the true rosarian much fear of his getting too luxurious a diet—indeed he is pretty nearly in Oliver Twist's condition, ever asking for more; and therefore, however homely and egotistic my remarks may seem, I yet feel that I need not apologise to the readers of the Journal for placing them before them.

And I have this one great comfort in so doing, that I do not set up to be a Rose-grower *par excellence*, and, as is well known, am not an exhibitor. I do not, therefore, ask anyone to judge of my Rose-growing by the exacting requirements of an exhibitor. My soil is not naturally a good one for Roses; but as I have always maintained that this is quite a secondary point to climate, and as in our beautiful county we can put forward no plea of deficiency in that respect, I am sure that I could grow my Roses to the perfection required by the present high standard of our exhibits. As it is I have two objects in view in my Rose-growing: one is to have the opportunity of seeing and studying their various habits and whims, the other of growing the newer varieties, so that I may be able to see what is their character; and when they come before me in

judging they do not come as strangers, but as those whose acquaintance I have already made.

Owing to my space being somewhat limited I am also obliged to grow my Roses in beds somewhat closer than I believe they ought to be, certainly closer than I see them in most of the gardens belonging to my friends; but yet by a judicious supply, not only of manure but also of fresh loam, I think that this may be obviated.

The effects of frost on Roses I never saw more severely illustrated than by the condition of my beds last autumn. They had suffered much by the winter of 1880, and in pruning after that had cut very hard, sufficiently so, as I thought, to get below all damage done to the wood. There was an apparent vigour in them afterwards that deceived me into the belief that they had weathered the storm. Then came the sharp winter of 1881, and again I cut, as I thought, hard; but the appearance of the plants last summer showed me that their days were numbered. I do not know what would have been the case had I cut them right down to the ground and allowed them to shoot up from underneath, but evidently they were cankered by the action of the frost, and so I had to remove a good many; but the older established plants did not seem to suffer nearly so much, while Teas, which I had cut down quite close, started most vigorously and did well. Certainly this beautiful class deserves all the favour it is receiving, for it gives a Rose-grower greater length of enjoyment than any class. I have none in the house. There are some on the wall which produce early blooms, and then with three beds we get a continuous succession of flowers on until the frost cuts them off. In our southern counties, then, there ought to be a great future for the Tea Rose. The seedling Briar has materially contributed to this; for where many kinds used to be utterly devoured by the Manetti, a sort of Saturn eating up his own children, the seedling Briar acts as a kind foster-mother, giving sufficient nourishment but not injury by excess of food. I may mention here that I have great hopes that my grand tree of *Rêve d'Or* will once again occupy its old position. After the two severe winters of 1880 and 1881 I had to saw it right down to the ground, and had almost determined to grub it. However, I thought it best to let it remain, and it has rewarded my forbearance by starting afresh from the bottom. It has now run up some 10 feet, and I hope it may be able by-and-by to fill-in that side of the house. I have left the nails in the wall where it used to be, so that if any incredulous person doubts my story I can point to these in proof of it. I have sometimes heard complaints as to the non-flowering of this variety, but I have never found it so. My own plant, and many that have been budded from it, are as floriferous as possible. As in other cases there may be a less desirable variety of it, I can only certify as to my own.

It hardly comes within the province of 1882 to write upon the subject which I ventilated in the pages of the Journal some time ago—viz., the autumn or spring planting of Roses, because the results of experiments cannot be seen until by-and-by. I am, however, anxious to revert to it because I have received two very strong testimonies in favour of spring planting—*i.e.*, be it remembered, not of Roses which have been in one's own garden, but those which every wise rosarian will obtain when he requires them from the nurseryman. One is from a gardener well known in the pages of the Journal—Mr. Pettigrew, of the Castle Gardens at Cardiff (the Marquis of Bute), who says, "I have for years adopted the plan of laying-in plants in the autumn and planting them in the spring, and with much success." The other is from a well-known, and will be, if I mistake not, a better known amateur, Mr. W. J. Grant of Hope End, Ledbury, near Hereford. I give his own words—"I was almost tempted to give my experience in the Journal, but as the matter was taken up by older rosarians than myself I did not like to venture. All I know about Roses and Rose-growing I have learned from personal experience. As regards planting, the conclusion I have come to in the matter is that, if properly looked after, plants planted in March, say up to the 25th, are quite as well and in many respects better than those planted in October. The best blooms I have ever had were cut on the 1st of July, 1881, from cut-backs planted on the previous 10th of March, 1881. Had they been planted when received from the nursery in October, 1880, I should have lost half of them, as I did the winter before. This is my experience of a severe winter and a dry spring. Again, I planted two-thirds of my purchase of October, 1881, as soon as I got the plants 4th November, and the remainder in March, 1882. The latter did by far the best in every way. So convinced am I about it that in future I shall always plant in spring. I have about 150 plants now that I got in November, which I shall plant in March, and if you care to hear the result you shall."

Scientifically, I am told, spring planting is all wrong. But the stern logic of facts is difficult to get over. I have heard a great deal about root-action of plants in winter, and that if plants were

heeled-in that the moving of them in the spring would destroy the young rootlets. I have been planting about a hundred plants which were laid-in in November, some on the Manetti, some on the seedling Briar, and others on the Briar cutting, and in only six could I discern any root-action whatever. Nay, more, I had to transplant one or two in my own garden to fill up; and here I found also that there was no root-action, and yet on many of the plants thus laid-in there were shoots $1\frac{1}{2}$ inch long, as if there were some action going on. This is so far my experience, and I shall be curious to see what the result is.

I had a considerable number of new Roses in the garden, but I am sorry to say nothing noticeable enough to make me hope for any great addition to our lists. Madame Gabriel Luizet proved herself to be more than a summer Rose, and there is a most marked difference in A. K. Williams' vigour when grown on seedling Briar. Mr. Walters of Exeter was good enough to send me some of each, and nothing could be more vigorous than those grown on the Briar. Complaints are heard of its delicacy, and it will be a boon if this method of treatment overcomes that. There is much to be learned as to the suitability of different stocks for different varieties. There are two Roses, not absolutely new, but not very well known, which are admirable as climbing Roses—Longworth Rambler (Prince) and Selina, an American variety, and anyone wanting Roses to cover a house will find these very suitable and hardy.

It was not altogether a satisfactory year with me. That which I always look upon as a very valuable point in the Rose, the being able to gather good blooms in autumn, was sadly frustrated by the continuous wet. Especially was this the case with the Teas. Still, after all there is no flower which gives so long a season of pleasure to the grower as does the Rose.—D., Deal.

ZONAL PELARGONIUMS FOR WINTER BLOOMING.

IF I understand rightly, one of the objects of horticultural literature is to popularise and extend the growth of plants among the millions. If there is any flower that can be described as essentially "popular" it is the Zonal Pelargonium, sometimes erroneously called Geranium. I think the cultural treatment (*vide* page 259), so lucidly pointed out by Mr. Brotherston, has the opposite tendency. I am sure you will permit me to say how those popular flowers may be easily grown from the standpoint of the greatest pleasure for the greatest number. I freely admit, if propagation is commenced now as suggested, "a stove with a minimum temperature of 65°" would be very useful, but this would exclude every grower who happens not to have a stove and the command of such a temperature. I propagate later on—May or June generally, in a common frame, with a few feet of stable manure to give a night temperature of 60°. The sun will give a sufficient day temperature. Those who have no frame or heating apparatus of any kind need not despair if they wish to increase their plants, as any ordinary long box with friable soil will answer their purpose. Take a cutting 5 or 6 inches long of stout fairly matured growth—if soft lay it in the sun on a shelf for a few hours, and put some sharp river, road, or silver sand in before you insert them. Press the soil around the base, and then fully expose to the sun. If the soil is ordinarily moist do not water, as decay at the base is more to be dreaded than drought. If the box is 9 inches high—the height of a board, half full of soil will do, and the sides will protect them against inclement winds. An artisan in Lancashire once showed me a case of this description, with just the addition of sheets of glass over all, and I have never seen healthier cuttings than in his miniature frame or greenhouse. That was in August. He transferred them into 6-inch pots immediately, and plunged them in his flower beds. I saw them a month afterwards, and I venture to say that had he a propagating house and a specially built structure for subsequent growth he could not have had more sturdy, promising, well-shaped plants than these were the last week in September. I wrote to inquire at Christmas of his success. His reply was short—"I built a small greenhouse since I saw you; a small oil stove kept out the frost. I am enclosing you a few blooms." Finer blooms no connoisseur need desire. "Whatever men dare they can do," and as these flowers are within the reach of all, all should have them, even the very best. I cannot wholly agree that those named by your correspondent are such, and for a limited collection would suggest the following in addition, obtained by me from Mr. Cannell, Swanley, last July, potted and started into growth, and then plunged outside for six weeks before being taken in. The majority are blooming still. Of round flowers, crimson and rose, Clytie, Celie, Rose, and Spencer; purple and magenta, La France and Hebe are still in bloom; also salmons Madame Colson, Fanny Catlin, and Ceres. Of the oculated, Czarina and Miss Hamilton are best. Of pink and white I prefer Eurydice, Miss Strutt, and

Constance; while Clipper Improved and Eureka are the best winter whites I know.—W. J. M., *Clonmel*.

ROSES.

I HAVE grown for several years some thousands of Roses in my garden. They have been propagated upon every variety of stock, and have been planted in beds sheltered and exposed. The lesson I have learned has come from a variety of sources. The result is that I advise all amateur Rose-growers who do not give themselves up to the conceit of exhibition to discard all plants grown upon stocks. My experience shows that there is scarcely a Rose which is not better grown under suitable conditions upon its own roots than upon a stock, and I know of no Rose which will not grow well from cuttings, and be longer-lived and more floriferous, than Roses budded on a stock however vigorous. But success is entirely dependent upon treatment; starve a tender plant or grow it in sterile soil and you will have no blooms, and the weakling will shrink and die; but give it a suitable and rich soil, and it will thrive better than upon the most robust stock. With plants grown on their own roots there are no unwelcome suckers. Do what you may, in a year or two the foreign stock will send up nurselings of its own tribe; and if your plants die to the ground, as many of them will do in a rigorous winter or spring, there is no certainty, unless you expose the plant to the budded portion, whether the new shoots are Briars or bastards, the illegitimate offspring being in this case what you crave.

It is much easier to nurserymen to propagate plants by budding than by cuttings. A Rose tree may yield a hundred strong buds but not ten good cuttings, and in skilful hands less buds than cuttings fail. Hence stock-budded plants are in favour.

My words are for those who grow Roses in the garden, for those who love a bright show of beautiful flowers in the open sunshine and upon their tables. I have never exhibited a Rose; the pleasure of a day would not satisfy me. I require that the charms of the Rose beds should be had in natural luxuriance from June to November, and for every one who exhibits there are hundreds who grow Roses. In my case there is nothing selfish in my love of the flower; living a short distance from a large town my grounds are open for months for the pleasure of others. During the season many thousands of persons, the majority of them children, have the gardens thrown open to them, and not a bloom has been touched.

I am obliged to grow the great majority of the Rose trees upon foreign stocks because I cannot buy plants propagated by cuttings. I am told it does not pay to grow them in that way, and that budded plants upon the Manetti, if planted deeply, will throw out roots from the scion and will thus give me what I need. Well, this proves my case. It shows that plants will thrive upon their own roots. Nay, more, it condemns the fashion of stock-propagation; for there is this weakness in the grower's position—the scion will, it is true, produce its own roots, but the stock will produce its own scions. Hence, though we may thus get a tree upon its own roots, it is apt to be surrounded by a tribe of rapacious blood-suckers.

Would it not be worth while for some of our large nurserymen, or for one in a small way, to initiate a supply of Roses upon their own roots? I would buy some hundreds yearly were they to be had, and there are many who would be glad to get a supply.—W. SIMONS, *Merthyr Tydfil*.

GENTIANS.

IN the interesting note on Gentians, page 274, "M. B." has told exactly what I wanted to know about *G. bavarica*. We are trying many species of Gentians in the experimental gardens at Oakwood and here—some with complete success. If "M. B." will give me his address I shall have much pleasure in sending him seedlings of *G. aselepiadea*, both blue and white. It grows freely with us and sows itself about. I think one of the most beautiful of the family is what the late Mr. McNab grew so well in the Edinburgh Botanic Garden rockwork under the name of *G. gelida*, but which I believe to be *G. septemfida*. *G. Andrewsii* grows well. A plant from our garden was figured in the "Botanic Magazine," and sows itself. It is curious, considering its closed petals, that it should be one of the freest-seeding of Gentians. *Gentiana ornata*, of which we have only one small plant, shows

well with its beautiful pale blue flowers. *Gentiana verna* does fairly well. *Gentiana acaulis* "chooses to flourish" at Wesley in the damp loam. *Gentiana cruciata* sows itself about. *G. bavarica* has not as yet succeeded well, but I hope after "M. B.'s" hints that it will do so.—GEORGE F. WILSON, *Heatherbank, Weybridge Heath*.

CLIMBERS AS ROOF-COVERING PLANTS.

TACSONIA MANICATA.

As a greenhouse climber I know few more beautiful than this good old plant, yet we seldom see it recommended now. I have just been slightly pruning a plant that by-and-by will produce streamers of brilliant scarlet flowers. I find cuttings of the young

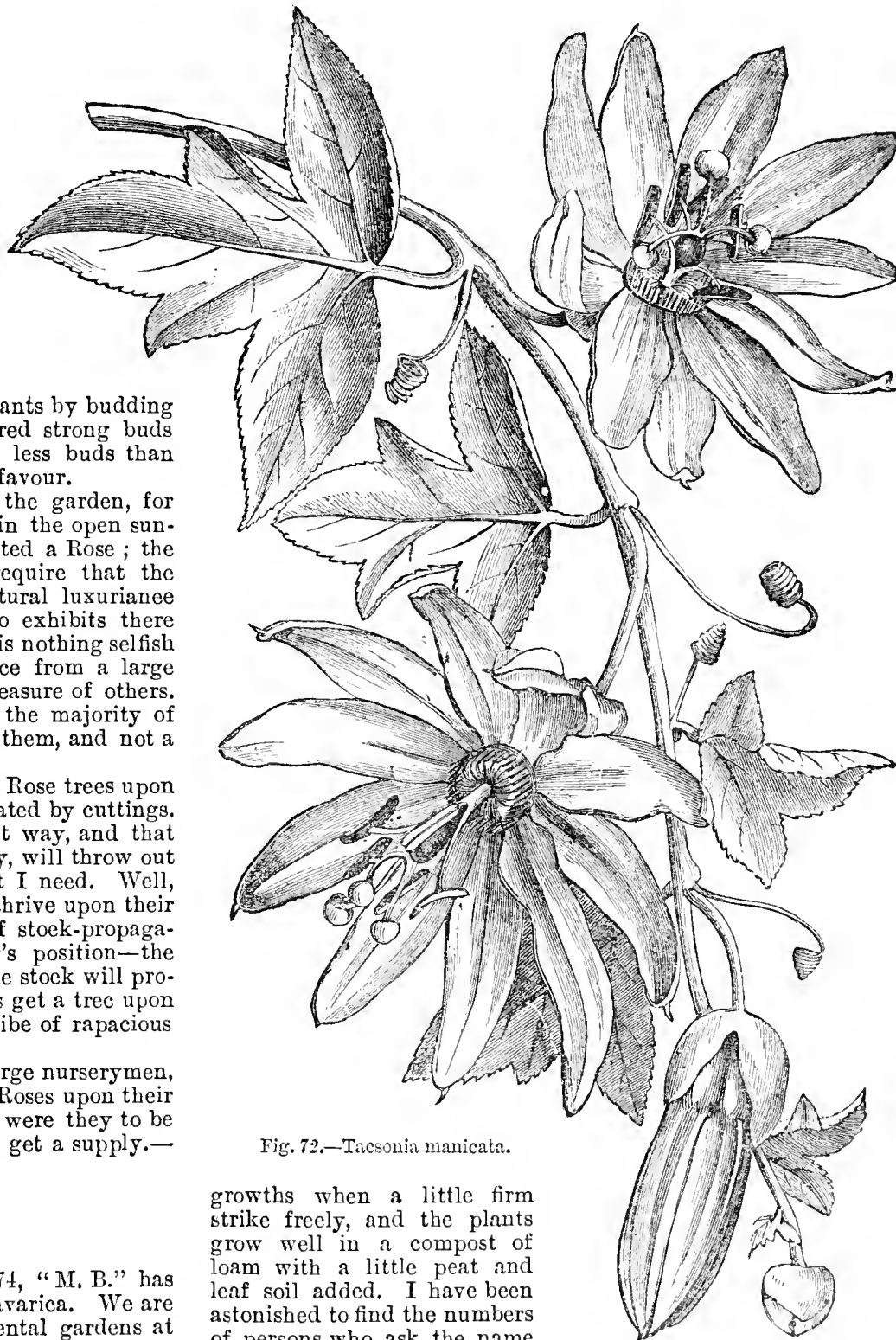

Fig. 72.—*Tacsonia manicata*.

growths when a little firm strike freely, and the plants grow well in a compost of loam with a little peat and leaf soil added. I have been astonished to find the numbers of persons who ask the name of this climber. I thought everybody knew, but this is certainly not so, and more might know and grow it with advantage. About the plant historically I know nothing, but I know it is very beautiful when well grown under a light roof.—J. BOSTON.

[This, commonly called the Gauntletted Tacsonia, is a native of Peru, and probably common there, for many botanical travellers have observed it. Humboldt and Bonpland brought some varieties from the city of Loxa; Hartweg says that it is found in hedges near that place, and it forms No. 1294 of Linden's Herbarium,

gathered by his collectors, Funck and Schlim, in the province of Merida, at the elevation of 7000 feet above the sea. It forms a rambling climber, with grey three-lobed leaves and large scarlet flowers, whose tube is almost concealed by three downy bracts, from which circumstance we presume Jussieu gave it the name of Gauntletted (or Manicate); it must be owned that the tube of the flower may not unaptly be compared to an arm thrust into a large loose glove. The coronet consists of two principal rows of short violet teeth planted on the green tube of the calyx lining. The species was introduced by the Horticultural Society in 1843.]

POTATOES FOR TABLE AND MARKET.

(Continued from page 276.)

In the following notes the figures 1, 2, and 3 indicate first early, second early, and late varieties; the months the time of planting; and the asterisks those varieties that are considered the best for market purposes by the respective cultivators.

SCOTLAND.

ABERDEENSHIRE.—1. January if the weather be favourable, if not February. Ashleaf Kidney, the earliest variety, or Veitch's. These are of dwarfer habit and earlier than Myatt's, which, however, gives the largest return. 2. February if possible. White Fortyfold, Coldstream, Ashtop Fluke, and Snowflake. 3. March, or the early half of April. Late planting gives watery roots, and more liable to disease. Regents, Victoria, Grampian, and Blue Fluke. The last keeps best, and when boiled mealy and of fine flavour. Manures and Application.—I am not so particular about manures as an open, deep, and well-pulverised soil. Anything open, such as leaves or decayed vegetables, are trenched in the ground, and either ground bones or guano is sowed over when the plants are a few inches high, sometimes sown in the drills at the time of planting. Much manure forces tops and destroys the quality of the Potato. General Culture.—Distances for planting $2\frac{1}{2}$ feet apart for early sorts, 3 or $3\frac{1}{2}$ feet apart for late ones, but not deep. Use sets either medium-sized whole, or large cut, and planted from 9 to 12 inches asunder. Draw the soil lightly over them; as they advance earth up, and when bones or guano is applied fork the whole ground between the lines. Keep earthing-up as long as there is soil to spare.—V. FARQUHAR, *Fyvie Castle Gardens*.

AYRSHIRE.—1. Second week in February if weather is suitable. Alpha, Veitch's Improved Ashleaf, Smith's Scodling, *Beauty of Hebron. 2. End of March. Robertson's Grampian, *Dalmahoy, *Red Bogs, Prince Arthur. 3. Beginning of April. Paterson's Victoria, Prince Regents, *Scotch Champion, *Magnum Bonum. Soil.—Medium. Manures and Application.—In autumn the ground is ridged $2\frac{1}{2}$ feet wide, digging in some stable manure, and when the planting season comes leaf soil is placed between the ridges, on which the sets are placed about 9 inches apart. Then the ground is levelled with forks. Nothing more is done till the shoots appear above ground, when the land is again forked between the rows, inclining a little soil to the young plants. In about a fortnight or so afterwards they are earthed up, not placing the soil too close to the neck of the haulm.—DAVID MURRAY, *Culzean Gardens, Maybole*.

BERWICKSHIRE.—1. From the middle to the end of February, weather permitting. *Ashleaf Kidney, *Rivers' Royal Ashleaf Kidney, *Woodstock Kidney, and Smith's Curly or Coldstream Early. Soil.—Light soil on south borders. 2. Middle of March, weather permitting. *Dalmahoy, Fortyfold, Rintoul's Pink-eyed Don, and *Schoolmaster. Soil.—Medium, and the same for the late varieties. 3. First week of April. *Magnum Bonum, Regents, *Champion, and *Paterson's Victoria. Manures and Application.—Good stable manure dug in with winter digging.—WILLIAM RICHARDSON, *Ayton Castle Gardens, Ayton*.

BUTESHIRE.—1. First week in March. *Myatt's Prolific Ashleaf, *Veitch's Improved Early Ashleaf, Mona's Pride Kidney, and Smith's or Coldstream Early. Soil.—Very light and sandy. 2. Last week in March. *Dalmahoy, *Rintoul's White Don, Fortyfold, and Schoolmaster. 3. April. *Paterson's Victoria, Regents, and *Champion. Manures and Application.—A little Peruvian guano is spread in the drills at planting, keeping it clear of the sets, and a fair dusting of bone meal when forking between the rows before earthing-up. General Culture.—The earliest Potatoes I have them sprouted about an inch before planting. The main and late crops are planted on ground which has been trenched and heavily manured for Peas the previous year, and the results are very satisfactory.—DAVID MCAUSLIN, *Brodick Castle, Isle of Arran*.

CAITHNESS.—1. March 1st to end. Ashleaf, Sandringham, *Magnum Bonum, and Royal Ashleaf. Soil.—Light, medium, and heavy. 2. April 12th to end. *Myatt's Prolific, *White Don, Rintoul Don, and Schoolmaster. 3. April 20th to end. *Champion, Dalmahoy, *Red-skinned Flourball, and *Fortyfold. Manures and Appli-

cation.—The ground is turned in winter and the frame manure applied, or sometimes fresh manure. We cut out drills 2 feet apart and place some peat soil in the drills, sometimes fresh turf with a little sulphur or lime or soot mixed.—JOHN SUTHERLAND, *Langwell, Berriedale, Wick*.

DUMFRIESHIRE.—1. End of February; ready to lift middle of June. *Myatt's Prolific Ashleaf, Beauty of Hebron, *Queen of the South, and Climax. Soil.—Light. Queen of the South is a really fine Potato. All who have grown it speak most highly of it, and I rank it one of the very best for early use. 2. 1st till middle of March. *Dalmahoy, *Schoolmaster, Fillbasket, and select Regents. 3. Middle of March till middle of April. *Scotch Champion, Magnum Bonum, *Reading Hero, and Scottish Queen. Scottish Queen I consider is the best late variety yet known, but the stock is very limited. Manures and Application.—Farmyard manure in some cases ploughed in during autumn, but more generally put into the drills when planting. About thirty cartloads to the acre, with 2 cwt. of guano and 3 or 4 cwt. of Morris and Griffin's Potato manure strewn on the farmyard manure in the drills also at planting time. General Culture.—I generally grow my Potatoes after stubble, the land being ploughed during autumn. The land is drilled 26 to 28-inch drills; the sets, according to the variety, being planted from 12 to 18 inches apart. The land is harrowed before the Potatoes appear above ground, after this the single-horse grubber is run between the drills frequently. So soon as the shaws are large enough the drills are well earthed up, sometimes being done two or three times.—WILLIAM KERR, *Dargavel, Dumfries*.

1. Middle of March. Alpha, Old Ashleaved, *Myatt's Kidney, and Lapstone Kidney. Soil.—Rather light. 2. 1st of April. *Dalmahoy, Schoolmaster, and Fortyfold Improved. Soil.—Medium. 3. Middle to end of April. *Walker's Regent, Victoria, and *Champion. Manures and Application.—Farmyard manure applied in moderate quantity some months before planting. General Culture.—In garden culture the manure is subtrenched-in. Deep drills are drawn at distances apart to suit the varieties—from $2\frac{1}{2}$ feet to 3 feet. The sets are deposited at a foot to 14 inches apart in the drills. Then full ridges are drawn over the rows at once, and never after earthed-up. I have grown enormous crops of Walker's Regent by planting large Potatoes at 3 feet by 15 inches apart in deep rather heavy loam. In this way no small Potatoes are produced. I once from a few rows grown thus threw twenty-four Potatoes into the scales, which they turned at 44 lbs., one of the number being $3\frac{3}{4}$ lbs. Not one of these was hollow in the centre, and they were greatly appreciated for baking. I consider cutting Potatoes for planting a great mistake, especially if the ground is very dry when planted and they do not get rain immediately. The superfluous eyes should simply be destroyed.—DAVID THOMSON, *Drumlanrig Gardens*.

1. About the 10th of March. Prince of Wales, Rivers' Royal Ashleaf, and Myatt's Prolific Ashleaf. Soil.—Heavy. You will best understand the nature of our garden soil when I state that our Apples, Pears, Plums, and Gooseberries all become overgrown with lichen and moss, and canker very badly. 2. Last week of March. Schoolmaster. 3. First week in April. *Scotch Champion and Skerry Blue. Manures and Application.—Manured for a crop of Cabbage with stable dung, and compost of leaf soil and lime occasionally, and the Potatoes being planted the year following without dung. General Culture.—I have tried about thirty varieties the last three seasons, but have not been able to find any of the newer sorts to do better on our land than those mentioned. I may here say that I consider Schoolmaster the best Potato in point of quality when cooked.—JOHN LESLIE, *The Gardens, Springkell, Ecclefechan, N.B.*

1. End of February. *Old Ashleaf, Rivers' Royal Ashleaf, Myatt's Prolific Ashleaf, and *Veitch's Improved Ashleaf. Soil.—Light and gravelly. 2. First or second week of March. Snowflake, *Covent Garden Perfection, Rector of Woodstock, and *Manhattan. 3. End of March. *Schoolmaster, Grampian, *Scotch Champion, and Walker's Improved Regent. Manures and Application.—I have tried the following manures, and have succeeded in growing first-class Potatoes with the whole of them:—1st, Guano mixed with the soil at the time of planting; 2nd, Salt and soot mixed, say one bushel of salt and one of soot, mixed with the soil at the time of planting; 3rd, Half-decayed leaves in quantity, say 6 inches deep under the sets of Potatoes, grows fine clear tubers. General Culture.—I have not used farmyard manure for many years, but have generally chosen ground that had been well manured the previous year. In the event of the soil being poor I have used leaf soil with a little soot. For some years I have also grown them in ridges, which is a great improvement to flat planting, especially in a locality where the rainfall is heavy. Attention ought to be paid in the saving of seed by keeping the best-shaped tubers. I have a few that I have grown for the last twenty years, and they are as good as ever.—JAMES DICKSON, *The Gardens, Castlemilk*.

FIFESHIRE.—1. From the middle to the end of February. Veitch's Improved Ashleaf, King of the Kidneys, *Racehorse, and Myatt's Prolific. Soil.—Our garden soil is light, but Potatoes do remarkably well. 2. From the middle to the end of March. Grampian, Fortyfold, *Rintoul's Pink Don, and *Dalmahoy. 3. The end of April.

*Late Regent, *Paterson's Victoria, and *Scotch Champion. Manures and Application.—Manure is put on during winter, and the ground thrown up into ridges 2½ feet wide. I prefer manure for the Potato ground from old hotbeds well decomposed. General Culture.—When planting time comes level the bottom of the drills and plant about 15 inches apart, and level the ridges on the seed. Hoe to keep down weeds; when ready fork between the rows and earth up.—PETER RINTOUL, *Raith Gardens, Kirkcaldy.*

FORFARSHIRE.—1. 1st April to the middle. Old Ashleaf Kidney, Sandringham Early Kidney, and *Myatt's Prolific. Soil.—Medium rich free soil. 2. 1st of March to the middle of April, according to weather. Fortyfold, White Don, *Schoolmaster, and *Magnum Bonum. Soil.—From medium to heavy, porous. 3. 1st March to middle of April, according to the state of the weather. *Paterson's Victoria and *Scotch Champion. Soil.—Light to medium, open gravelly subsoil. Manures and Application.—When the land is in good heart manure is given sparingly, but in light poor soil a heavy manuring is necessary to procure a paying crop, as well as thoroughly working the soil. Farmyard manure is preferred. General Culture.—All the kidneys for early use are started into growth before planting out, hence the reason why they are not planted so early, it being necessary to have a little sun heat in the soil to preserve the growth already formed. I find later varieties do best when planted early, providing the weather is dry. All the names given are sorts grown here for years, and among many other sorts I have found these the most satisfactory in every respect.—GEO. JOHNSTON, *Glamis Castle.*

KINROSSHIRE.—1. From 1st of February till end of March. Old Ashleaf, Myatt's Prolific Ashleaf, Rivers' Royal Ashleaf, and Veitch's Improved Ashleaf. Soil.—Medium. 2. From 1st of March till end of April. Lapstone Kidney, Snowflake, Fortyfold Red, and Schoolmaster. 3. From 1st of March till end of April. Regent, Paterson's Victoria, Magnum Bonum, and Champion. Manures and Application.—For the first earlies I apply manure in autumn or winter, with a little ordinary farmyard manure well decayed, and at planting time I give some leaf soil. For my second earlies and later I give ordinary farmyard manure, and sometimes the ashes of our prunings and any other rubbish that will burn. General Culture.—Last year after the early kidneys were over I had to begin the late ones, as my second earlies were entirely destroyed by the disease. Magnum Bonum and Champion stood well.—JOHN FORTUNE, *Blair Adam.*

EAST LOTHIAN.—1. Middle of March. Veitch's Improved Ashleaf Kidney, *Myatt's Prolific Ashleaf, Smith's Early Round (syn. Smith's Curly), and Coldstream Early. 2. In garden third week of April. *White Don (round), Early Fortyfold (round), *Grampian (round), and Covent Garden Perfection (kidney). 3. April to third week in May. Walker's Regent, Victoria, *Scotch Champion, and *Magnum Bonum. Soil.—In good condition for from 2 to 3 feet in depth. Rich in lime, naturally deficient in phosphates and potash. Subsoil generally gravelly or sandy, in parts disintegrated trap. Geological formation (underlying) old red sandstone. Manures and Application.—For Nos. 1 and 2 for three-quarters of an acre (imperial) 2½ cwt. superphosphate of lime, 2 cwt. chloride of potash, 1½ cwt. sulphate of ammonia, without dung, employed in a fine condition, mixed with equal proportions of dry fine soil, sown along the drills as Potatoes are planted. No. 3 in field, per acre, 15 tons cattle manure, 3 cwt. best bonemeal, 3 cwt. superphosphate of lime, 1 cwt. nitrate of soda. In certain conditions 3 cwt. chloride of potash is added. Sown in drills. General Culture.—In the case of first and second earlies our treatment in the garden is noted; in that of late varieties that of one of the most eminent farming families has been noted. A change of seed is found of great benefit with all kinds. Lawes' "Special" Potato manure is used somewhat extensively. The ammonia in this manure is obtained from sulphate of ammonia; it is adapted for the more loamy class of soils.—R. P. BROTHERSTON, *Tynninghame.*

MIDLOTHIAN.—1. Middle of January. Veitch's Improved Ashleaf and Coldstream. Soil.—Warm light soil; south aspect. 2. February. Grampian, Dalmahoy, and Regent. Soil.—Medium and dry soil. 3. March and April. Victoria, Champion, and Magnum Bonum. Manures and Application.—Manured for previous crop. No manure is given direct to the Potato crop. A dressing of lime previous to planting is beneficial.—M. DUNN, *Dalkeith Gardens.*

WEST LOTHIAN.—1. From the 1st of March to the middle of March. Smith's Round, *Veitch's Perfection, Mona's Pride, and *American Early Rose. Soil.—A free loamy soil, inclining to sandy subsoil. 2. Latter end of March. *Schoolmaster, Dalmahoy, *Old Round American, and *Myatt's Prolific Ashleaf. 3. First or second week of April. *Magnum Bonum, Regents, *Scotch Champion, and *Paterson's Victoria. Manures and Application.—One part cow dung, two parts horse dung, three parts old hotbed, mixed up with three parts leaves and one of stable litter, the whole thrown into a heap until it cuts with the spade, and spread in the rows when the Potatoes are planted. General Culture.—In choosing Potato ground the first

point is to get the highest part, with, if possible, a south aspect, keeping the same well exposed to the wintry weather with the surface loose and rough, planting when the ground is dry, and before giving a final earth-up going between the rows with a fork and raising the soil, but not turning it over.—JOHN MOYES, *Dalmeny Park Gardens, Edinburgh.*

STRAY NOTES.

MONSTERA DELICIOSA.

THIS handsome Aroid deserves to be more generally known and grown than it is. It is not only one of the most useful and effective of ornamental-foliage stove plants, but is also greatly esteemed for the luscious fruit which it produces when the plant has attained a fair size. In order, however, to thoroughly ripen the fruit, a high and moist temperature is necessary, in addition to which the fruit must be exposed to the sun's rays as much as possible.

My principal object, however, in writing this note is not to direct attention to its fruiting qualities so much as to its great adaptability for planting out to cover bare walls in plant stoves and tropical ferneries. In a large tropical fernery under my charge I had two plants growing most luxuriantly against the end walls, the long roots of which cling and penetrate into the interstices of the brickwork and descend for many feet into the rock beds below. The peculiar appearance of its roots thus ramifying and descending in every direction, coupled with the beautifully cut or slit-like formation of its handsome dark-green foliage, renders it a most desirable plant for the purpose I have mentioned; especially so when, as in our case, the interior of the fernery is arranged as naturally and as informally as possible. I need scarcely add that this Aroid, similarly to its congeners, requires abundance of moisture.

AMARYLLISES AT MESSRS. VEITCH'S.

During a hurried peep through the plant houses at Messrs. Veitch's the other day I was astonished on entering the Amaryllis house to behold such a magnificent display of new seedling varieties of these useful plants. The centre stage of this house was laden with a remarkably well-grown batch of these bulbs, nearly all of which were carrying a profusion of very fine and gorgeously coloured flowers. Both Messrs. Veitch and their able grower deserve the highest praise for their unceasing devotion to the great task of improving these, as well as many other races of plants.

STAPHYLEA COLCHICA.

My attention was drawn to a batch of this plant in flower in one of the plant houses at the above nursery. The plants were growing in small pots, each plant carrying on the summit of its stem, which was, as nearly as I can recollect, about a foot in height, clusters of lovely white blooms accompanied with bright green pinnate foliage. Judging from what I saw I should say this is a desirable plant for early forcing for decorative purposes. These examples had been forced.

CAMPHOR ASSISTING THE GERMINATION OF SEEDS.

It is, I believe, not generally known that most seeds are greatly hastened in their germinating process by being soaked, previous to sowing, in soft water, to a pint of which a lump of camphor about the size of a large nut has been added. I have tried this experiment on many vegetable seeds, such as Peas, Beans, &c., as well as Palms, Ricinus, and various other tropical seeds, which we often receive with very hard testas, many of which would require soaking for a long period in the ordinary way; but with the addition of camphor, as before stated, only a very short period of soaking is required. When time will permit I intend undertaking a series of experiments relative to the value of camphor, &c., in influencing or hastening the germination of seeds generally, and will, with the Editor's permission, communicate the results in these columns.—T. W. S., *Lee.*

ROYAL HORTICULTURAL SOCIETY.

APRIL 10TH.

GROUPS of Rhododendrons from Messrs. Lane & Son, Daffodils from Barr & Son, choice Orchids and stove plants from Mr. B. S. Williams, Anemones from Messrs. Cannell & Sons, and miscellaneous flowering and fine-foliage plants from the Society's Garden at Chiswick, constituted the greater portion of the display on Tuesday last, and well filled one side of the conservatory.

FRUIT COMMITTEE.—John Lee, Esq., in the chair. The following were also present:—Messrs. G. Goldsmith, J. Willard, L. Lyon, J. Roberts, Wm. Paul, J. E. Lane, W. Denning, A. W. Sutton, R. D. Blackmore, L. A. Killick, J. Woodbridge, F. Rutland, James Smith,

H. J. Veitch, Dr. Robert Hogg, and G. Bunyard. A cultural commendation was awarded to Mr. McIndoe, The Gardens, Hutton Hall, Guisborough, for a dish of Early Beatrice Peach, from trees which were started on November 22nd; they were of good size and well coloured. Mr. Fyfe, The Gardens, Ditton House, Thames Ditton, was awarded a cultural commendation for a box of particularly fine President Strawberries, the fruits being large, well-shaped, and beautifully coloured. Messrs. J. Veitch & Son, Chelsea, sent a dish of Morris's Incomparable Apples in good condition. A vote of thanks was accorded to Messrs. T. Rivers & Son, Sawbridgeworth, for a collection of sixty dishes of fresh well-kept Apples, some of the best being Betty Geeson, Melon, Beauty of Kent, Royal Russet, Lewis's Incomparable, Claygate Pearmain, Lord Burghley, Norfolk Beefing, and Blenheim Pippin.

FLORAL COMMITTEE.—Mr. B. S. Williams in the chair; the other members present being Messrs. G. Hinton, G. F. Wilson, J. Douglas, H. Bennett, W. Bealby, J. Laing, J. Cutbush, T. Moore, Shirley Hibberd, H. M. Ridley, G. Duffield, Harry Turner, H. Ballantyne, J. Doiny, James McIntosh, W. B. Kellock, H. Cannell, H. Ebbage, and John Wills.

A silver-gilt Banksian medal was awarded to Mr. B. S. Williams for a large and handsome group of Amaryllises, Orchids, and miscellaneous stove plants, amongst them being a specimen of *Tricopilia lepidula*, a rare species, for which a vote of thanks was accorded. One fine specimen of *Ada aurantiaca* attracted much attention, as it was in excellent condition and bearing twenty-five brightly coloured spikes. A cultural commendation was awarded to Mr. Baxter, gardener to Sir Trevor Lawrence, Bart., M.P., Burford Lodge, Dorking, for a fine plant on a block of *Brassavola Perrini* with about four dozen flowers, the sepals and petals narrow and cream-coloured, the lip rounded and white. A similar award was also granted for *Odontoglossum mulus* bearing a spike of fourteen handsome chocolate-barred flowers. A vote of thanks was awarded for a richly coloured variety of *Odontoglossum vexillarium*, and some fine flowers of *Lælia elegans Turneri* were shown. Mr. Parr, gardener to R. Sturgis, Esq., Givons Grove, Leatherhead, was awarded a cultural commendation for two good plants of the small-flowered *Cælogyne ocellata*, each with some dozens of spikes. A bronze medal was awarded to Messrs. H. Cannell and Sons for a beautiful collection of single Anemones very diversely coloured, with flowers of *Salvia interrupta*, *Nicotiana affinis*, and a score of plants of the rich purple double *Cineraria* Mr. Thomas Lloyd. Messrs. James Carter & Co., High Holborn, sent four plants of *Tropæolum tricolorum* trained on a balloon trellis and well flowered. A bronze Banksian medal was awarded to Messrs. Collins, Bros. and Gabriel, 39, Waterloo Place, London, S.E., for an extensive collection of Anemone blooms of the Victoria Giant strain, and *Anemone fulgens Dazzler*, a brilliant scarlet variety, for which a vote of thanks was accorded.

A silver-gilt Banksian medal was awarded to Messrs. Barr & Son, King Street, Covent Garden, for a very extensive collection of Narcissus flowers, representing all the different sections, and comprising a great number of varieties. Mr. H. Bennett, Shepperton, sent three plants of *Rose Her Majesty*, each bearing large, full, handsome, bright, soft pink blooms, of vigorous habit, and large foliage. A vote of thanks was accorded to Mr. H. Clinkaberry, jun., The Gardens, Forty Hill, Enfield, for a plant of *Odontoglossum Andersonianum* with a spike about 2 feet long, the flowers thickly spotted with rich chocolate on a white or pinkish ground. A specimen of *O. Wilckeanum* with large flowers was also sent. A vote of thanks was accorded to Mr. Ballantyne, gardener to Baron Schöder, The Dell, Egham, for a specimen of *Odontoglossum Pescatorei Veitchii* bearing a spike of ten superb flowers most richly blotched with crimson on a pure white ground. A silver Banksian medal was awarded to Messrs. H. Lane & Son, Great Berkhamstead, for a fine group of *Rhododendrons* and *Azaleas*, all being well flowered. Messrs. W. Paul & Son, Waltham Cross, Herts, sent plants of a new Hybrid Perpetual Rose, *Merveille de Lyon*, which has full creamy white blooms of good shape, the plants very robust, dwarf, and compact.

Messrs. James Veitch & Son were awarded a vote of thanks for a basket of plants of *Azalea rosæflora* (Rollissoni), which has bright reddish pink or deep salmon-coloured flowers, very close and neat in form, and very free. Mr. J. Aldous, Gloucester Road, sent a basket and bouquet of Daffodils, Ferns, and Selaginellas very tastefully arranged. Mr. R. Dean, Ealing, sent several handsome Primroses, Magenta Queen and White Queen being particularly good; with *Polyanthuses* Scarlet Gem and Orange Beauty, and *Myosotis dissitiflora perfecta*, a large-flowered form, and *alba* the white variety. A large group of spring-flowering plants was contributed from Chiswick, comprising *Cinerarias*, *Spiræas*, *Azaleas*, Ferns, *Begonias*, Tulips, Narcissi, Wallflowers, *Primula rosea*, Palms, and *Isolepis* very tastefully arranged.

A first-class certificate was awarded for the following plant.

Masdevallia Schlimi (Lawrence).—A most distinct species bearing two spikes, one with five and the other with four flowers, which are about an inch in breadth, the tails being 2 to 3 inches long, and bright yellow. The ground colour is yellowish, very thickly dotted with a peculiar claret hue. The leaves are thick and of moderate size, 4 to 5 inches long by 1½ inch broad.

SCIENTIFIC COMMITTEE.—Sir J. D. Hooker in the chair.

Peas, &c.—Mr. McLachlan showed Peas received from America attacked by *Bruchus Pisi*, also dipterous larvæ cases found about the

roots of *Dendrobium crassinode*, and a beetle (*Donacia* sp.) with *D. Devonianum*, the two latter received from Col. E. S. Berkeley.

Fossil Cone.—Mr. Boulger showed a specimen of *Pinites hexagonis* from the Gault, related to *Pinea*, which, like recent species, is still associated with *Sequoia*.

Narcissus sp.—Dr. Masters showed specimens from Prof. M. Foster, amongst which was the rare *N. rupicola* from Spain.

Sclerotia of Potato.—Mr. G. Murray replied to certain comments of Mr. S. Stephen Wilson upon his remarks at the last meeting. Mr. Murray adheres to his opinion that there is no sufficient proof of the mycelium arising from the plasm state, and asks, "If a seedling be so severely attacked why is it perfectly healthy?" He cannot yet pronounce what they are without further material.

Puccinia Buxi.—Mr. W. G. Smith showed specimen of Box badly attacked by this fungus, which will germinate on the slide in twenty-four hours.

Greigia Sutherlandi.—He showed drawings of flowers of this plant, pointing out the long and short-styled conditions, though the stamens were long in both cases. The flowers are provided with a circlet of glandular bodies of unknown purpose.

Violets Killed by Cold.—Mr. G. Lee of Clevedon sent Violets killed by the late severe cold weather.

Shrubs Injured by Cold.—Mr. Loder showed many kinds of shrubs severely injured by the late severe weather, the temperature having fallen to -3° on March 10th.

Camellia reticulata.—The Hon. and Rev. J. T. Boscawen sent a blossom, with the observation that "it had been out of doors unprotected for years against a wall with east aspect. This *Camellia* is by far the hardiest of all. Not a leaf has ever been injured."

Frost at Lamorran.—He also sent a list of temperatures for March, the lowest of which was 22° of frost on Saturday 10th.

LECTURE.—The Rev. G. Henslow drew attention to some *Azaleas*, the forms being now innumerable, but the old *A. indica* was very rare at the beginning of this century. *A. pontica* appears to have been the species with poisonous honey, and which stupified the soldiers of Xenophon. It has been used in its native country east of the Black Sea for medicinal uses. *Rhododendron ponticum* was supposed erroneously to be the deleterious plant. A third genus, *Rhodora*, of which *R. canadensis* was introduced by Sir J. Banks in 1767, is closely allied. Indeed, though called genera, they can all three be cross-fertilised, which proves them to be the same genus. Mr. Henslow then made some remarks on physiological affinity not always corresponding with morphological, in that plants may differ very much in structure, yet can be grafted or cross-fertilised. Thus *Garrya elliptica* is grafted on *Aucuba*, and *Hibiscus* will fertilise *Abutilon*.

Tulips with Virescent Petals.—The lecturer called attention to a curious phenomenon sometimes seen in Tulips, in that a leaf or petal may be half green and half coloured and situated on the stem; the coloured part ceases to grow, so that it checks the growth of the peduncle. This bends over, and may even crack and decapitate the Tulip.

ORCHIDS AT HIGHAM HILL, WALTHAMSTOW.

ORCHIDS are a speciality at the above establishment. Although not a large collection, the plants are unsurpassed for cleanliness and good culture under the care of Mr. Gilks, the head gardener. Commencing with the cool Orchids, there are four hundred vigorous and floriferous examples of *Sophranites grandiflora*, several fine plants being suspended close to the glass in the Cattleya house, which Mr. Gilks thinks is the proper place for them, as the flowers and growths are almost twice the size of those in the cool house. There are also about one hundred plants in a vinery just started, which are also showing vigorous growth. *Lycaste Skinnerii* is represented by many beautiful varieties; *Aerides japonicum* by about two dozen healthy plants. *Masdevallias* are represented by the following:—*M. amabilis*, *M. Veitchiana*, *M. chimera*, *M. coccinea*, *M. ionocharis*, *M. Peristeria*, *M. polysticha*, *M. Harryana*, *M. tovarensis*, *M. Nycterinia*, *M. bella*, *M. Backhouseana*, and many others. Hundreds of *Odontoglossum Alexandre*, *O. Pescatorei*, *O. cirrhosum*, *O. Rosii majus*, *O. Cervantesii*, *O. Halli*, *O. triumphans*, *O. Uro-Skinneri*, and a plant of the true *O. pardinum* and *O. Edwardsii*.

In the Cattleya house are suspended in baskets about one hundred plants of *Oncidium concolor* with 250 spikes of bloom; fine specimens of *Lælia purpurata*, *Cattleya Mendelii*, *Mossia*, *labiata*, *crispa*, *Warneri*, *Loddigesii*, *gigas*, *Lælia elegans* and *Dayana*. *Cymbidium Lowianum* is showing a spike of upwards of thirty blooms, a fine plant of *Dendrobium albo-sanguineum*, *D. Ainsworthi*, *Zygopetalum crinitum cæruleum*, a fine plant; several fine plants of *Anguloa Clowesii*, *Oncidium macranthum*, *Odontoglossum Londesboroughanum*, several dozens of *Leptotes bicolor*. Besides the *Sophranites* worth mentioning in the vinery are several fine pieces of *Lælia majalis*, growing in the full sun about 2 inches from the glass.

The East India house contains healthy plants of *Vandas suavis*, *tricolor*, and *Parishi*, *Aerides Lobbianum*, *A. crassifolium*, *A. odoratum*, *Angræcum sesquipedale*, a dozen nice plants; *Angræcum*

eburneum, Saccolabium guttatum Harrisonianum, healthy plants of *Miltonia candida*, *grandiflora*, *Paphinia cristata*, *Acrides Fieldingi*, *Saccolabium grammatophyllum* and *S. Ellisii*, *Phalaenopsis Schilleriana*, *Odontoglossum Roezli*, &c. These are only a few of the many fine Orchids grown here, and the collection is fast extending. One other point worthy of notice is the abundance of roots the plants have, which testify to Mr. Gilks' ability as an Orchid grower.—A. YOUNG.

FENCING AGAINST RABBITS.

I SHALL be glad to know what rabbits will not eat in the way of shrubs. I have a wood, and a garden of an acre and a half adjoining it. I have wired the latter in, but the rabbits still find their way in. I do not want to exterminate them altogether, but I should like to grow a few shrubs. My Roses are all done for; Larch and Spanish Chestnut, nine-tenths are destroyed. Hazel when first planted has a bad time of it, and even Laurels and Rhododendrons are terribly bitten. When is the proper time to insert cuttings of Laurels and other shrubs—spring or autumn? If any of your readers can help me in my trouble I shall be very grateful.—G. C. E.

[We do not think you can possibly render your garden satisfactory if rabbits have access to it, and at present they must either be very numerous or very hungry to eat Rhododendrons. They can be excluded by wire netting if it be fixed properly. The best method that has come under our notice is adopted with great success in the woods of a large estate where rabbits abound. When simply sunk in the earth vertically, no matter to what depth, the animals burrowed under it; but when the lower edge of the netting was bent at right angles (fig. 73), the flange facing

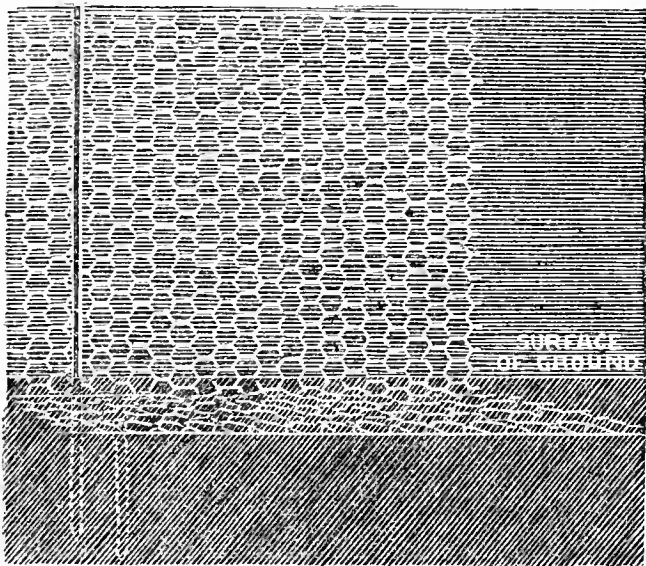

Fig. 73.—A Rabbit-proof Fence.

the point of attack, and covered an inch or two deep with soil, the netting was rendered rabbit-proof. These animals almost invariably commence scratching close to the netting, continuing perseveringly until they can pass under the fence; and as they do not appear to possess the sagacity for commencing their attacks 6 inches from it, the present method of fixing the netting forms practically a complete barrier, as not one rabbit in a thousand finds its way under the fence. If you adopt this mode of fixing your netting you may have flowers, shrubs, and rabbits, as if an animal by chance gets inside it may be easily caught. We have notes in hand on rabbit-proof trees and shrubs, which we shall if possible publish next week. Early autumn is the right time for inserting cuttings of evergreen shrubs.]



[By the most skilful Cultivators in the several Departments.]

KITCHEN GARDEN.

THE weather is now most favourable for operations in this department, and seed-sowing should be the order of the day.

Broccoli seed should be sown for main crops; the quantity must depend on the demand. In some cases a very small patch or a single short row of each variety may be sufficient, while in others a good bed of each may be required. Sowing a large quantity of one kind will never keep up a long supply, but small quantities of successional sorts will do this and give the greatest satisfaction. As these are given in every seed list we need not name them here. In all cases the seed should be sown on rich soil, and thinly, as the young plants may remain until they are planted in their bearing quarters. Brussels Sprouts, Cauliflowers, Savoys, and Cabbages should be sown at the same time; plants from the latter will supply fine tender heads late in autumn, and we find that delicate well-grown Cabbages are just as much valued very late as very early in the season. The main crop of Carrots should be sown at once. A heavy retentive soil is not favourable to the production of fine roots, but a moderately rich open soil will always afford clean produce. A thin coating of soot, salt, or lime dug into the soil before sowing will generally keep it free from destructive grubs during the season.

Cauliflowers from seed sown some weeks ago in frames should be hardened off as soon as possible, with the view of planting them out in the open. We find if planted when quite small they succeed much better than if kept in frames until they are 1 foot or more in height. If drills are drawn about 3 inches deep and plants about 3 inches high are inserted in them it is astonishing how fast they grow and how little check they receive.

Celery seed for main crop may be sown under a handlight or in a frame. Damp soil suits the plants at all stages of their growth. Early Celery plants which have been grown in heat should be gradually hardened for planting out in a few weeks time. Leek seed may be sown now for the main crop. These are always transplanted and need not be sown in any particular place. Seed should be sown at once if not already done, as a long season is necessary to thoroughly mature this crop. Parsley is indispensable in every garden; and in case of failure, which is by no means uncommon with this useful crop, two or three patches of it should be sown in different parts of the garden. Soil which produces clean Carrots will always grow fine Parsley.

Now is the time to sow Asparagus, Rhubarb, and Seakale seed; 18 inches from row to row, and 6 inches from plant to plant, are proper distances for all of them, inserting two or three seeds at those intervals. Crowding seedlings when very small, or in fact at any time, is ruinous. A small sowing of early Beet may also be made now; the Turnip-root variety matures earlier than any of the long sorts. Turnips are most valuable in the early summer months, but if sown too early they are liable to run to seed before any useful bulbs have been formed; but now the seed may be sown with certainty of success. The rows should be from 15 to 18 inches apart, and as Turnip seed always germinates freely, sow thin.

Midseason Peas should still be sown; and as they will be bearing at a time when the weather is generally hot and the ground dry, if sown in shallow trenches now these will be found very beneficial to the crops under the conditions just named. In light sandy soils good Peas cannot be secured in hot weather unless they are grown in trenches, but in heavy soils they should not be placed so far below the surface. All Potato planting should now be pressed forward. We are now planting our late kinds in rows 3 feet apart, and as soon as the autumn and winter Greens are ready a row of them will be put between every two of the Potato rows. Radish seed and Mustard and Cress should be sown frequently in small quantities at the front of a south wall. Harden off ridge Cucumber plants, and admit plenty of air to Potatoes now maturing in frames. Sow another good batch of Kidney Beans to precede the first crop in the open air.

FRUIT FORCING.

Peaches and Nectarines.—As the stoning process is being passed in the early house the night temperature at this critical period must be maintained steady at 60°, with a rise of 5° by day by artificial means, and a still further advance of 10° to 15° from sun heat. Where ripe fruit is wanted at an early date forcing should be carried on by an increase of the day temperature, raising the temperature early in the morning to 65°, and with a little air from this point allow an advance of 10° to 15° from sun heat, with moderate ventilation, and close at 75°, increasing the temperature to 80° or 85°, afterwards admitting a little air, and allow the heat to fall gradually to the night temperature, as the ripening of the fruit must not be accelerated by the maintenance of a high night temperature. Examine the trees twice a week, and gradually reduce surplus shoots as well as surplus fruits. The experienced cultivator can not only tell which fruits are likely to stand, but, knowing the capabilities of his trees, will be able to determine

the number each tree should be allowed to carry. As a rule, the fruit should be evenly disposed over the trees at the rate of one to every square foot of trellis covered by the branches.

Nectarines should not have much less space, but from their smaller size are too frequently left much closer, which accounts for the smallness of these as compared with Peaches. Very vigorous trees may be allowed to carry more fruit, and weakly trees less—each individual must have its capabilities considered. Tying down the shoots must be carefully attended to, the aim being an equal distribution of the sap over every part of the tree, judiciously stopping gross shoots and terminals when they have made a fair amount of growth. Those shoots retained to attract the sap to the fruit must not be stopped too closely. Fruits which by their weight have taken a pendent position should be turned and supported with laths across the wires of the trellis in a way that will insure the exposure of the apex of the fruit to the full sun. Inside borders must be liberally supplied with tepid liquid manure, and mulched with short manure to prevent the escape of moisture and encourage surface-rooting. Ventilate carefully during the prevalence of cold winds, proceeding with disbudding and thinning in succession houses, plying the syringe freely twice on fine days, employing clear rain water not less in temperature than that of the house. Trees in late unheated houses are now in full blossom, and apparently are setting well, having passed through the trying ordeal uninjured.

Melons.—Frost and snow have rendered constant fire absolutely necessary. As a preventive of red spider paint the pipes thinly with sulphur, encouraging plants swelling their fruits with a moist atmosphere and plentiful supplies of water or liquid manure at the roots, closing early, or about three o'clock on bright days, at 85° to 90°, allowing an advance to 95°. Afford supports to the fruits. Reduce the atmospheric moisture in houses in which the plants are in blossom and until the fruits have set. Add some more soil to advancing crops, and give air freely on favourable occasions to plants in flower. Attend to the stopping, tying, and thinning of the shoots as they require it. The lining of dung frames will require attention in removing the cold and replacing with fresh material.

Cucumbers.—Those now in full bearing should be cropped lightly where fine fruit is aimed at, placing the fruit in glasses to grow them clean and straight, affording copious supplies of liquid manure in a tepid state to the roots as they require it, and close early, using the syringe freely during favourable weather. Stopping, tying, and thinning will entail considerable attention, and must be promptly given. Where the demand is not great two or three-light frames will afford a good supply by planting them in succession and being careful not to overcrop, thinning out the old growths so as to induce the plants to make new. Have some light shading in readiness for bright and powerful sunshine.

PLANT HOUSES.

Palms.—These, whether they are grown in stove, intermediate, or cool houses, now demand attention, and should be repotted where they require it. Be careful not to overpot these plants, as they do not require so much root-room as many others. When turned out of the pots in which they have been growing remove the soil from amongst their roots if inclined to be sour, and add fresh compost. They will bear this treatment if done carefully, and the plants judiciously watered afterwards. If the soil and roots are in a healthy condition merely remove the drainage and loose surface soil, and then repot them in well-drained pots. In repotting press the soil firmly into the pots, and use a compost of rich fibry loam and coarse sand, to which is added one 6-inch potful of bone dust and the same quantity of soot to each barrowful of loam; the last-mentioned imparts a fine dark hue to the foliage of these plants. For the finer-rooting varieties, such as *Cocos Weddelliana*, use a little broken charcoal and about one-third of peat to the above mixture. This also applies to any of these plants in a young state. Where potting is unnecessary remove the surface soil and top-dress with fresh, and either feed with stimulants during the growing season, or give two or three applications from time to time of Standen's manure. Water carefully after repotting until the roots are growing, and then give liberal applications.

Climbers.—Whether grown in the conservatory or greenhouse these should, if not already done, have as much of the old surface soil removed as possible and fresh supplied. When planted out and confined at the roots, as is too frequently the case in such structures, it is only by liberal feeding and rich top-dressing that such gross-feeding plants as *Cobæas*, *Passifloras*, *Tacsonias*, *Clematis*, *Abutilons*, and others can be maintained in vigorous health. Plants of this description are capable of displaying much beauty when liberally grown, but when their growths are puny and

stunted the opposite is the result. The compost for top-dressing these varieties should consist of good loam and at least one-third of good manure, while peat should predominate for *Rhynchospermum jasminoides*, *Chorozemas*, *Lapagerias*, and other similar plants. The latter, which flourishes much better when planted out than when grown in pots, should have soil of a light fibry nature. *Passifloras*, *Tacsonias*, and other similar plants can now be pruned well back, and the main shoots tied in closer than has been the case up to the present time, or that they will require while growing and flowering. *Clematis indivisa lobata* if out of flower can also be well cut back. The majority of climbers of this description present a much more beautiful appearance when their growths are allowed to hang suspended from the main stems in a semi-natural manner than what they do when tied in stiffly. Roses and deciduous *Clematis* that are employed as climbers, and have started into growth and showing their flower buds freely, should be liberally supplied with stimulants every time watering is needed.

Hardwooded Heaths.—Those that require repotting should now be done without delay, so that the roots will have time to commence working again in the new compost before the sun has too much power. Those in good health should have other pots 2 inches larger than those in which they are growing. It is important that the soil be in a proper state of moisture before repotting, so that the plants will stand as long as possible without being watered after the operation is completed. The drainage must be carefully removed from amongst their roots, but the remainder of the ball must not be disturbed or the roots injured. Drain the pots liberally, and be careful to make the new soil firm, so that water will not pass readily through it and leave the old ball dry, or unsatisfactory results will follow. Do not pot the plants too high, and thus leave too little room to hold sufficient water to moisten the whole of the soil when watering is needed. After potting shade the plants from bright sunshine for at least a fortnight or three weeks, and keep the house or pit in which they are growing rather closer during that time. Exclude drying winds, which often prevail at this season of the year. Syringe the sides of the pots, and moisten the stage upon which the plants are standing several times daily, which prevents the plants drying so quickly, and watering after potting is avoided for a greater length of time, which is very beneficial in the cultivation of these plants. Keep a sharp look-out for mildew, and if it appears dust with flowers of sulphur at once. After potting, staking and tying may be proceeded with at once, but do not use more stakes than really necessary.

THE BEE-KEEPER.

FEEDING.

SOME weeks ago we sounded a note of warning as to the too early attempts to stimulate bees in spring. We said that it was much safer to continue stimulative feeding later on into the autumn, and to insure a plentiful supply of young bees to stand over the winter and to carry on the work of the colony into spring, than to commence forcing on the queens to lay too early in the year. No doubt we shall hear on every side of starved hives and chilled brood. Many commenced to excite their queens by constant gentle feeding towards the end of February and beginning of this present month. We saw letters in which the writers were rejoicing to see "lots of brood" in February. We were sorry to see it. The quieter the bees were kept the better it was for them. After such a mild winter it was to be expected that a frost would follow. It came—a chilling frost, causing the bees to huddle nearer and closer together. Where much brood had to be covered, the bees either perished from the effects of cold in trying to cover the brood, or, by deserting it, left it to be chilled to death. This must have taken place in very many hives all over the country. If this chilled brood be not cut out (a difficult matter in straw skeps), the presence of it in the hives as warm weather comes on must be disastrous. It may cause that terrible scourge to the bee-keeper, foul brood, to appear and decimate his stocks. The time has, however, now arrived when we may expect the advent of fine weather, and all hives should be carefully overhauled directly an opportunity offers. Where brood has been chilled, the part of the comb containing it should be cut out with a sharp penknife, and it would render matters still more secure if all the combs could be sprayed with thin warm syrup in which salicylic acid has been well mixed. Dysentery may have been engendered by the long forced confinement to the hives, and the

application of the salicylic acid solution will act either as a preventive or as a cure.

Before this long frost set in we had only seen that the bees had sufficient food to carry them on. We contracted still more the space occupied by each colony where practicable, gave extra warm coverings, and left them, intending not to commence stimulative feeding until the month of March showed what it meant to be. Now we shall begin to feed gently and continuously as soon as the weather causes full activity among the bees. The frost seems to have broken up, but a S.W. wind with rain is blowing at present date (March 30th). Care should be taken to provide a plentiful supply of aerated water, for a great demand will immediately ensue with the commencement of warm weather. Bees require large quantities of water when rearing brood, and they like it aerated. A dripping tap in a waterbutt, or places where water can trickle and spray over stones, are favourite resorts of the water-carriers. We once arranged a broken pan which could only hold a small quantity of water, with some pieces of sandstone and bricks in it. This stood under a leaky wooden tap, which let the water drip drop by drop from a butt into which the rain water from a barn roof was collected. This proved a most favourite spot to the bees, the broken bricks, sandstone, and sides of the pan being at times covered by them. We now have a small stream, the overflow from a pond. This has been dammed up a few yards from the hives, and caused to overflow down a heap of ragged pieces of sand-rock. This is also a capital contrivance, and much appreciated by the bees. In our former abode there were several ponds in close proximity to the garden, and here we have both ponds and streams, but the simple contrivances nearer home are most valued and frequented. The water, well aerated, can be easily collected without danger of drowning by the bees. So much for the water supply.

Now as to giving artificial pollen. Should we have warm sunny days after this long spell of frost, the fruit trees and other plants will soon render the use of artificial pollen unnecessary. But we may still have a short time during which it may be much appreciated. Pea flour is the best substitute for natural pollen, and is readily collected by the bees. The best way of giving it is to partly fill an old straw skep with clean deal shavings, and sprinkle a few spoonfuls of the flour over and among the shavings. This skep should be placed in the warmest and most sheltered spot of the garden, some 20 or more yards from the hives. We like to cover this skep with a garden light, or to put it in a frame with the light partly drawn. The glass keeps it dry and warm. In order to attract the bees to it when first used, we rub a little honey or syrup over the skep, and the sun soon brings out a strong smell, which invites the first bees passing by, and very soon a host of revellers will be tumbling and rolling among the shavings, collecting loads of the pea meal, and returning, white as millers, to be cleaned by their comrades at home. Where plenty of Crocuses are in flower we have amused ourselves and the bees by putting at various times during the day a good sprinkling of the pea flour in the tiny yellow cups. It is a pretty sight to see how the bees hover over the flowers to arrange the little pellets of meal, and then again dive down to add to the store. If you accustom them to come to one place for a time they will haunt that spot long after you cease to place the supply there—like Oliver Twist, asking for more; but when plenty of flowers are to be found, or where the Willow blossoms are abundant, the artificial pollen will soon be disregarded.—P. H. P.

BEES SWARMING.

THE bees of one of my hives swarmed on Sunday about one o'clock, and returned to the old hive in about fifteen minutes. In returning I substituted another hive with maiden combs in it in the place of the old hive, thinking that the bees would settle and go to work in the new hive; but no, they left that hive at noon on the following day and went into a stronger hive. There was some fighting, but it was soon over, and now all are working together in full harmony. I am puzzled as to cause of this disturbance, and I cannot solve it. Have you ever known such a freak among bees?—A. M.

[Yes, often. Your swarm was a "hunger one." Despairing of ever getting food at home, they resolved to leave it and cast themselves on the world outside. In hunger swarms every bee is dissatisfied with home fare and home life, and all forsake their hives never to return. The queen you found crawling on the ground on Sunday was probably an old one unable to follow the bees, and this explains their return to the old place. If the queen had gone with the bees they would not have returned. The histories of hunger swarms are painful to read and think about,

and apiarians should not add to their number by starving their bees.—A. P.]

TRADE CATALOGUES RECEIVED.

Bruant, Boulevard Saint Cyprien, Poitiers (Vienne), France.—*General Catalogue of Plants.*

Thomas Painter, Smallwood, Stoke-on-Trent.—*Catalogue of Dahlias.*

Ellwanger & Barry, Mount Hope Nurseries, Rochester, New York.

—*Catalogue of New and Rare Roses.*

J. Carter & Co., 237 and 238, High Holborn, London.—*List of Farm Roots and Grass Seeds.*



** All correspondence should be directed either to "The Editor" or to "The Publisher." Letters addressed to Dr. Hogg or members of the staff often remain unopened unavoidably. We request that no one will write privately to any of our correspondents, as doing so subjects them to unjustifiable trouble and expense.

Correspondents should not mix up on the same sheet questions relating to Gardening and those on Poultry and Bee subjects, and should never send more than two or three questions at once. All articles intended for insertion should be written on one side of the paper only. We cannot reply to questions through the post, and we do not undertake to return rejected communications.

Weather Notes (J. M.).—Thanks for your letter. We will readily publish the observations which you obligingly offer to send.

Turf "Pots" (T. H.).—These are very serviceable, as we have proved by years of experience. We hope to publish your letter next week.

Training Vines (F. J.).—Suspend the Vine a little below the front wire. Train the growths below the wires at distances of about 3 feet. You can bend the canes where you like after the wood has ripened. Syringe at present to encourage growth. Letters arriving on Wednesday morning cannot be satisfactorily answered the same week.

Pruning Roses—Lilies (J. B.).—Full replies can only be given when questions reach us in good time. You are quite right, however, in your suggested method of pruning. Shorten the growths as much as possible to good buds at the base of the shoots. We presume your Lilies are single crowns. In that case the fertiliser will be of no service, as flowers will be produced before fresh roots are made. Cover the crowns with moss and keep the soil constantly moist. The shelf may possibly be too dry, and light is not necessary until growth has commenced.

Culture of Water and Musk Melons (R. A.).—These require the same treatment as the varieties that are grown in this country, but will succeed in a somewhat lower temperature, and may be grown in what are termed cold frames in the summer. If you possess the number of this Journal of March 17th, 1881, you will find all the necessary details for growing Melons in frames. An article on page 205 of that issue will be of far greater use to you than anything we can say in this column. It can be had from the publisher in return for 3½d. in stamps.

Weather in Staffordshire (C. Roberts).—The insertion of the word "week" instead of "month," in your note on page 279, was, as you suggest, a printer's error of a nature so simple that it was overlooked. Though it would not mislead, you have done well to direct attention to the error, which is thereby rectified.

Destroying Snails (Snail).—There is no way of destroying these pests without first catching them, and heaps of bran, grains, fresh Cabbage leaves, half Oranges, mixed the pulp, are the different kinds of bait that are used for attracting them, these to be examined a few times after nightfall with the aid of a lantern. Cannot you protect your Ferns by standing the pots on smaller pots inverted in saucers kept filled with water? Snails we know like moisture, but we have never met with any expert swimmers, and we have saved many plants and seedlings by the simple method indicated.

Camellias not Expanding (C. W.).—We presume the plants are in tubs or pots, and in this case we have no doubt that either the roots are torpid or the soil is exhausted. The plants have simply many more buds on them than the plants have strength to support, and hence the non-expansion of the flowers. Had you removed a number of the buds in the autumn, those retained would have a better chance of opening. We are not, however, certain that they would have opened, because the examples sent afford evidence that the plants have been too dry at some time, which caused the petals to shrivel at the base, and when this occurs the flowers do not open freely. The outer petals, too, appear as if they had been injured by frost or extreme damp; but the initial cause of the failure is at the roots. Cannot you remove much of the old soil and add fresh—half turfy loam that does not contain lime, and half peat with a free admixture of sand and bonemeal? If you cannot do this cover the soil with soot, and water its virtues to the roots. A sprinkling of Standen's manure or bonemeal would have much the same results, but you really ought to endeavour to incite more vigorous root-action by fresh and snitable soil.

Renovating Vines (G.).—Both Mr. Wallis and Mr. Ward gave you good advice, and you will do well to act strictly in accordance with it. You have not "tried our patience" in reading your letter, and we are glad to perceive you have so far done what we believe to be right; but while you have told us much you have managed to omit just what we should like to know—namely, if the new border outside and the fresh material inside are really permeated with

surface roots. Vines may grow luxuriantly without any roots near the surface as yours did when the roots were 3 feet below it, and in such a case liquid manure would do no good; but if the border is interlaced with roots near the surface, then the Vines, if heavily cropped, will be assisted with the sewage. You will find it advantageous to keep the surface of the borders moist in hot weather by covering them with manure. Heat and drought drive the roots downwards however bad the soil may be there, and however good it may be near the surface. Sewage is good for everything you name, but should not be given to plants in pots until they are root-bound and need more support than the soil affords. You must also test the strength of the liquid on some common plants in pots that you can afford to kill, and Cabbages in the open ground, before applying it to Vines or plants of value. Sewage varies in strength considerably, and there is nothing like a few experiments for determining the question of its proper dilution for your purpose. It is valuable for all kinds of crops that require rich food, and the soil is tolerably well drained.

Oxide of Iron for Roses (M., Liverpool).—We do not know that we can do better than quote what Mr. William Paul has said on this matter in his excellent work "The Rose Garden" as follows:—"Opoix, a French apothecary, attributes the superiority of the Roses grown for medicinal purposes, in the neighbourhood of Provins, to peculiar properties of the soil, which contains iron in considerable quantity. We know, by the research of chemists, that the petals of the Rosa Gallica contain oxide of iron; and I have long thought that the iron which abounds in the soil of one of the nurseries here is an ingredient of importance in the culture of Roses. I would not say that it is indispensable, but beneficial, and am almost confident that it heightens the colour of the flowers. On turning up the soil its ferruginous nature is in places distinctly seen. In an undrained field adjoining the nursery the water frequently collects on the surface in the form of a thick brown liquid, like so much rust, which is covered here and there with a film, on which the sky is distinctly mirrored. When the soil in this nursery is hoed or forked, the rapid increase of growth of vegetation is striking beyond measure. This practice is known to promote growth in all soils, but the extent to which it does so here is, I think, due to the oxygen of the air changing the iron contained in the soil from a substance pernicious to vegetable life into one favourable to its development." We have not had experience in applying iron to the soil; if any of readers have we shall be glad to hear from them on the subject. But we know that some soils contain too much iron for vegetation, and it is important that the nature of the soil be ascertained before any applications of this nature are made.

Clematis cirrhosa (W. J. X.).—As we have a woodcut in hand of this Clematis, we give it (fig. 74) as it will indicate the characters better than mere verbal description. The flowers are small, white, and pendulous from the axils of the ovate or elliptical leaves, and are produced freely at the points of the



Fig. 74.—Clematis cirrhosa.

branches. The species is related to *C. calycina*, and was first noticed by Clusius in Andalusia and Gibraltar, being also found in other parts of Spain. It is said to have been cultivated by Gerard in 1596, and was grown by Miller at the Chelsea Botanic Garden for more than forty years in the open ground. Though hardy, however, it is usually grown in a cool house.

Chrysanthemum Crimson Velvet and King of Crimson (Secretary).—We thought we had made it clear some time ago that King of Crimson is not a new but an old variety. It is totally distinct from and many years older than Crimson Velvet. Whether the latter has been confounded with the former or not by the writer you quote we cannot tell, possibly it has. We should not like to say that he "knows nothing about Chrysanthemums," but we admit freely our belief that his knowledge of the varieties and their peculiar cultural requirements is by no means equal to your own. We have grown both these varieties, and we know of none richer and brighter in colour, Crimson Velvet being perhaps the more glossy of the two. This we scarcely consider a true reflexed variety. The majority of the flowers are reflexed, but well-grown examples incurve more or less. In fact, when it was first sent out by Mr. Salter (we think in 1865) it was said of it, that as it did not "incurve very closely it showed its colour well." We have had partially incurved flowers, though we have never seen one sufficiently incurved for including in a stand of that section; but we have seen several that could not have been excluded from a stand of reflexed blooms; they were, however, too small. King of Crimson, on the contrary, we do not think possible to produce with incurved petals, nor have we ever seen it with tasselled florets like Triumph du Nord. As for its being a Japanese variety that is out of the question, as these forms were, we think, not grown to any extent before 1867, whereas King of the Crimson was as well known in 1849 as it is now. We should not be surprised to learn that this very useful and effective variety is about forty years old. It is admirably adapted for specimens, and some very fine examples of it are usually seen at the Southampton Show. Although we cannot publish your letter at present, it shall not be destroyed. We have had no complaint from the cultivator you name.

Surplus Garden and Farm Produce (J. S.).—If you have no other land for growing Mangolds, &c., for stock than is shown in the plan you have

sent—that is, in the walled kitchen garden, neither you nor anyone else can have any substantial surplus of either farm roots or garden vegetables for sale, if the family and stock be well supplied. Many owners of small gardens estimate garden produce at much more than its selling value. They have regard to the purchasing price, forgetting that in the majority of cases two profits have to be made before the vegetables reach the consumer, except in the case of a small local demand, and then the selling prices are usually low. If your fruit trees are in a fully productive state you may perhaps during some years have a little fruit to spare; and you may possibly raise a few hundreds of very early Lettuces planted in the autumn close to those walls which have a warm aspect, and very early Potatoes may be obtained much in the same way. If you can get such crops as these ready a few days before the markets are well supplied you will find the advantage of enhanced prices. By working on this principle—that is, turning any special natural advantages that your garden may possess to the best account, you may occasionally make a few pounds off a comparatively small space; but it is practically impossible for you to have any "great portion" of surplus produce of the different crops throughout the season. Your question on Potatoes as you have put it is unanswerable. No one can possibly estimate the produce per acre of "various sorts," and in this case we should certainly not grow "various" sorts, but should find out one or two varieties that succeed best in the soil, and grow these exclusively. If you could obtain, say, 3½ tons of Myatt's Prolific, or 6 tons of Magnum Bonum per half acre, you would do very well. If you turn to page 77 of the Journal, the issue of July 27th, 1882, you will find the record of a crop of the former of twice the weight we have indicated, and the manure that was used in producing it. This, however, was quite an unusual yield. In growing Potatoes or anything else as much depends on the skill of the cultivator as on the nature of the soil. If you have only two men—the figure you have made being so obscure that no one here can tell whether it is meant for a 2, 3, or 5—you will not have to search long for work waiting doing.

Climbers for East Aspect (C. S. R. V., Surrey).—A trellis of stout wire will answer best for your purpose. Before covering the house front with Portland cement drive in iron staples 4 feet apart, leaving them far enough out to project through the cement, so that the wires can be fastened to them after it is put on. A row of staples at top and bottom and five rows between, or forty-two staples for each space of 20 by 24 feet. Strain the wire diagonally so as to make a diamond pattern, both for stability and neatness, and give it two or three coats of paint. The climber you mention is probably *Ligustrum coriaceum*, of a distinct, compact, and very neat habit of growth, but for the beauty of its flowers and bolder appearance *Ligustrum japonicum* is decidedly preferable, only it requires rather more care in pruning and training to keep it within bounds. Four feet apart is close enough for the permanent health and vigour of the climbers, and this distance will enable you to have eight plants arranged in the order they are named—*Lonicera flexuosa*, the sweetest of all Honeysuckles; *Ligustrum japonicum* (Japanese Privet), *Jasminum officinale* (White Jasmine, very fragrant), *Escallonia macrantha*, *Lonicera brachypoda*, almost as sweet as *L. flexuosa*, *Berberis Darwinii*, *Jasminum nudiflorum* (Yellow Jasmine, flowering in winter and early spring), and *Ceanothus rigidus*, quite hardy enough for an east aspect in Surrey, and very lovely in spring with densely clustering pale lavender flowers. One, three, five, and seven are deciduous, the others arranged with them alternately are evergreen. Let the growth mingle, and you will thus have a clothing of green foliage in winter, and the fresh growth and beauty peculiar to the other seasons of the year as well. Plant carefully as soon as possible in rich soil 3 or 4 feet deep and wide, and see that there is an outlet for rain water, which is apt to accumulate about the foundations of buildings.

Top-dressing for Melons (W. J.).—Soil saturated with urine is an excellent and powerful manure, and would form a good top-dressing to any plants and crops that required more support than the soil in which they are growing affords. For Melons and Cucumbers bearing heavily, also Vines and fruit trees, Tomatoes, Strawberries, Chrysanthemums, and such-like gross feeders, it would, judiciously applied as to time and strength, be useful. You had better place a portion of it on the surface of the soil in which some common plant, a Zonal Pelargonium for instance, is growing, with the object of testing its strength. By this means you can easily ascertain to what extent the soil will need to be used with it for applying to more valuable plants. So long as plants are growing freely and satisfactorily they require no rich top-dressings, and it is not until pots and borders are crowded with roots and the soil partially exhausted that assistance in the form indicated can be profitably applied. In all probability your preparation will need to be mixed with three times its bulk of soil, and perhaps more. This is a point you can easily determine by a few simple experiments on plants in pots and garden crops.

Names of Fruits (F. J.).—Cobham.

Names of Plants (A. M.).—The Primula is *P. scotica*, and the Narcissus is *N. minor*. (*J. Smith*).—*Corydalis bulbosa*. Flowers of two *Dendrobiums* have been sent us by a correspondent who does not give us any name or initials to which we can reply. The white flower is *Dendrobium crepidatum*, and the other *Dendrobium pulchellum*. (*F. R. F.*).—1, *Myrsiphyllum asparagoides*; 2, *Callistemon rigidum*; 3, *Eupatorium odoratum*; 4, *Allium neapolitanum*.

Supering (M. B. D.).—A few days after your hive has its combs covered with bees a super should be put on it. Judging from your description of the state of the hive, we think it will be ready in about ten days for supering. The bees would enter the super more readily through the bars than through the crown holes in the wooden top if it could be fixed securely on the bars. Your hive appears to be very healthy and prosperous.

COVENT GARDEN MARKET.—APRIL 11TH.

BUSINESS still remains better, with good supplies of indoor fruits and vegetables.

		FRUIT.			
		s.	d.	s.	d.
Apples.....	½ sieve	2	0	7	0
".....	per barrel	20	0	40	0
Apricots.....	doz.	0	0	0	0
Cherries.....	½ sieve	0	0	0	0
Chestnuts.....	bushel	10	0	12	0
Currants, Black..	½ sieve	0	0	0	0
" Red.....	½ sieve	0	0	0	0
Figs.....	dozen	0	0	0	0
Filberts.....	lb.	0	0	0	0
Cobs.....	100 lb.	0	0	0	0
Gooseberries....	½ sieve	0	0	0	0
Grapes.....	case	5	0	12	0
Lemons.....	case	10	0	20	0
New Grapes....	lb.	8	0	12	0
Nectarines.....	dozen	0	0	0	0
Oranges.....	dozen	100	6	10	0
Peaches.....	dozen	0	0	0	0
Pears, kitchen..	dozen	1	0	2	0
" dessert.....	dozen	1	0	2	0
Pine Apples, English	lb.	1	6	2	0
Raspberries.....	lb.	0	0	0	0
Strawberries....	oz.	0	6	0	9

VEGETABLES.

	s. d.	s. d.		s. d.	s. d.
Artichokes..... dozen	2	0 to 4	0	Lettuces..... dozen	1 3 to 2 0
Asparagus, English bundle	12	0	0	Mushrooms..... punnet	1 0 1 6
Asparagus, French bundle	25	0	30	Mustard & Cress .. punnet	0 2 0 3
Beans, Kidney.... 100	2	0	0	Onions..... bushel	2 6 3 6
Beet, Red..... dozen	1	0	2	Parsley..... doz. bunches	6 0 8 0
Broccoli..... bundle	0	9	1 6	Parsnips..... dozen	1 0 2 0
Brussels Sprouts.. 1/2 sieve	1	6	2 0	Peas..... quart	0 0 0 0
Cabbage..... dozen	0	6	1 0	Potatoes..... cwt.	6 0 10 0
Capsicums..... 100	1	6	2 0	Kidney..... cwt.	6 0 10 0
Carrots..... bunch	0	4	0 0	Radishes.... doz. bunches	1 0 0 0
Cauliflowers..... dozen	2	0	3 0	Rhubarb..... bundle	0 4 0 0
Celery..... bundle	1	6	2 0	Salsafy..... bundle	1 0 0 0
Coleworts....doz. bunches	2	0	4 0	Scorzonera .. bundle	1 6 0 0
Cucumbers..... each	0	4	0 3	Seakale..... basket	1 0 2 0
Endive..... dozen	1	0	2 0	Shallots..... lb.	0 3 0 0
Fennel..... bunch	0	3	0 0	Spinach..... bushel	5 0 6 0
Herbs..... bunch	0	2	0 0	Tomatoes..... lb.	1 6 2 0
Leeks..... bunch	0	3	0 4	Turnips..... bunch	0 2 0 3



POULTRY AND PIGEON CHRONICLE.

ENSILAGE.

(Continued from page 289.)

IN opening this subject we remarked that it was of ancient usage. Professor Thorold Rogers has, however, lately given information on the antiquity of the silo, and in an article in "Macmillan's Magazine," says, "It is plain that it was known five centuries before our era." It is mentioned by the poet Euripides, and described by nearly all the Latin writers on agriculture. There is no doubt the use of it was known to the Jews in the time of the prophet Jeremiah, or at any rate so far as it related to the storage of grain in pits. Coming down to our time Burnaby, in his celebrated "Ride to Khiva," mentions that the grass in the Steppes of Russia was preserved for winter use, being buried in the earth. As we have before stated, it is a general practice in America to reduce the forage of any kind into the state of chaff before putting into the silo, as it packs and may be trodden closer. Our own opinion, however, is that in this country it is really necessary only in the case of Indian Corn, Sorgum, and one or two other coarse-stalked substances, for the extra cost of labour entailed will prove enormous; and satisfactory results having been obtained in this country with whole grass and other haulm or forage without chaffing, we think it may be well to proceed on that basis, and that our forage may also be placed in the silo in either a wet or dry state just as it may be cut and brought from the field; for a gentleman who has recently read a paper at the Botley and South Hants Farmers' Club, Mr. F. Willan, says, "Pits were filled last year, either wholly or partially, with grass cut and carried in the rain. I have seen myself a pit which was so partially filled, and I could detect no difference in the ensilage."

There can be no doubt but ensilage in the chaff state will be more easily removed from the silo than compressed grass or other fodder in the uncut condition, and likewise be more easily mixed with other food; but the whole ensilage can be readily cut down by the hay knife as required for use, and not disturb or expose the remaining portion as when in chaff. We must now refer to comparative value of ensilage for feeding dairy cows, fattening cattle, horses, and sheep with dry food and fodder, or such as hay, meal, cake or bran, &c. We, however, anticipated that more beneficial results from the feeding of dairy cows than other stock, in accordance with our idea. We have before us a statement made by a gentleman on Lord Walsingham's estate, who took for an experimental purpose five pedigree shorthorns which had been fed daily with 6 lbs. of crushed Oats and 3 lbs. of bran, mixed with chaff

composed of two-thirds Barley straw and one-third hay. He says, "The five animals yielded on December 10th sixty-eight quarts of milk, which the lactometer showed contained 12° of cream. We commenced feeding with ensilage on December 11th; besides the ensilage and chaff the Oats and bran were given as before in each instance. It must now be observed that on December 14th, three days after the ensilage was first given, the milk had increased by two quarts, with a rise of 1° of cream. This went on until the 20th. On the 21st the cows gave seventy-one quarts of milk, with 14° of cream—another rise of 1°. New year's day brought us seventy-six quarts and 16° of cream. On the 5th and 6th the increase continued; so that on January 10th, when the test ended, the record was the same as on the 8th, when eighty-two quarts of milk with 16° of cream were obtained. It will therefore be seen, that although in the middle of winter the month's trial when concluded, the milk return had been raised by fourteen quarts per day and the quality of the cream to the remarkable extent of 4°.

Another trial in America is reported from an American paper, *The Cultivator and Country Gentleman*. In November and December four milch cows were selected; two of them were fed on ensilage for twenty-one days, and the other two were fed on dried fodder well cured, and both being the produce of the same field and part of the same crop. At the end of twenty-one days the cows were changed, and those fed on ensilage were now fed on fodder and *vice versa*. During this test each cow, whether on ensilage or dried fodder, received 1 lb. of Indian cornmeal, 1 lb. of wheat bran, and 1 1/2 lb. of oilmeal at each feed night and morning. Each cow had all the ensilage or dried fodder they would eat. The cows were fed, watered, and milked at the same hour each day. The results in milk and butter churned therefrom were:—

	Milk.		Butter.
	lbs. ozs.		lbs. ozs.
Ensilage and meal produced	1456 8	50 8 1/2
Dried fodder and meal ditto	1322 15	53 3 1/2
Increased produce from ensilage.....	133 9	6 5

Most of our readers will think it important to ascertain the actual difference between ensilage and hay, and on this matter we find an excellent analysis by Mr. Francis Sutton, the analyst to the Norfolk Chamber of Agriculture, and was as follows:—

	Hay No. 1.	Hay No. 2.	Ensilage No. 1.	Ensilage No. 2.
Albumen	7.40	10.62	11.71	10.43
Sugar, gum, oil, and extractive matter	11.15	13.65	20.86	23.33
Digestive fibre	26.73	26.35	32.24	31.17
Indigestible fibre	43.74	40.25	25.26	27.14
Inorganic and mineral matter	10.98	9.13	9.93	7.93
	100.00	100.00	100.00	100.00

After commenting on the fact that the soluble albuminoids or flesh-formers are, together with the digestible fibre, so much more largely present in the ensilage than in the hay, he says: "These facts are of great importance, and well worth attention by stock-feeders, as it is evident that the occurrence of these nutritious constituents in a really soluble form is so much labour of mastication and digestion saved to the animals that are fed on such food as compared with dry hay. It is abundantly evident, so far as these analyses can show, that the silo has produced a succulent easily digestible food, full of aroma and nutrition, from a very poor quality of grass. Several experiments show that fattening bullocks also prove the advantage of ensilage if a fair portion of dry food, such as crushed Oats, Barley, or bran, is given with it."

We have yet another valuable practical benefit to be derived from the feeding sheep with ensilage, but especially ewes, both before and immediately after lambing; and when we come to consider that in the winter months how injurious root food often proves for feeding pregnant ewes, it is likely to prove in the future what we had always hoped for and desired in such cases, to find a vegetable food equally valuable, or nearly so, to succulent autumn grass. In accordance with these ideas we find Mr. H. Woods stating in a lecture given by him before the Wayland Agricultural Association, that Mr. Thos. Gayford of Wrotham, near Thetford, carried out a trial of feeding with ensilage on ten in-lamb ewes, one of which had previously been a very bad milker, and says, "I am glad to report the effect of the ensilage food on the milk of the ewes is most decided, and the ewes gave an abundance of rich milk, which was of a golden colour and as rich-looking as if it came from the udder of a fresh-calved Alderney cow. And it is particularly noteworthy that the ewe which had always given so little milk on her previous lambings improved so

much under ensilage food as to give as much as any ewe in the general flock." In conclusion we must observe that various great authorities have given some statements of their opinions as to the probable value of ensilage, none being decidedly opposed to it. Amongst them are Dr. Voelcker and Sir J. B. Lawes, with other celebrated chemists abroad, but their evidence and opinions are of a too lengthened character for our columns on the present occasion; we have therefore chosen that our paper should only bear as much as possible upon the practical value of ensilage to the home farmer up to the present time. There is, however, a large and important future before us, in which a much greater number than have yet appeared will display their intelligence and researches into the subject of ensilage both of agriculturists, chemists, and others at home and abroad, which we hope to notice on a future occasion.

WORK ON THE HOME FARM.

Horse Labour.—Horses have lately received little hindrance in the work and tillage required for both Potatoes and Barley as well as White Oats. We must, however, call special attention to the cultivation and seed time for Barley. We like to till the land into a fine and pulverised surface for Barley, but do not expect a good malting sample if the seed is drilled later than the 14th of April, nor if the land is deep and loamy and in too high condition, especially after roots fed off by sheep eating cake, &c., but still there in some safeguard in drilling $2\frac{1}{2}$ bushels per acre at 11 inches apart between the lines. On one of the best conducted farms we have ever seen on the range of chalk hills (reaching from the eastern counties down to Devonshire) all the corn was drilled at 12 inches, but especially upon the white and shallow hillsides near the downs. Capital malting samples of Barley had been produced on this system for the long period of forty years, during which had observed the cultivation, and on contiguous farms the corn drilled at 7 inches seldom yield a malting sample. We do not hesitate to sow the White Canadian or White Victoria sort instead of Barley on good tillage after the 20th of April, for in the year 1858 we had a remarkable illustration of the comparative result of the advantage of growing these early varieties of White Oats, especially the Canadian, in preference to Barley. Part of a field being cropped with Barley and part with these White Oats the land being previously treated and prepared in the same manner was sown at the same time, at harvest the Oats were ripe three weeks earlier than the Barley. Upon threshing the crops the Oats yielded eighteen sacks per acre, and weighed 45 lbs. per bushel, while the Barley only gave nine sacks per acre of thin inferior grain. Both samples of corn were sold in the same market on the same day at 28s. 6d. per quarter. The value of the Oat straw as fodder was much greater than the Barley straw. The result of this comparative crop added to our former experience in the matter quite decided us in giving up the culture of Barley on loamy land in a high state of cultivation. We had noticed for some years previously and heard many farmers complain that they could not grow the Barley so good in sample as formerly even on kind soils well adapted for its culture. This arises in our opinion from two or more causes—first, Barley will not bear excessive manuring on any soil, but we fear that a constant repetition of the crop every four years has much to do with the ill success complained of.

Hand Labour.—The men will be employed in cutting and stripping oak timber, the women in setting up bark to the poles. But we advise the home farmer or steward to use equal caution in cutting and clearing Oaks amongst the ornamental timber in parkland pastures, for unless to the practised eye it is very difficult to estimate the exact result of removing certain trees until they are down; mistakes are often made in this way, but as they cannot be set up again the mistake is irreparable. On the other hand we know many parks in various districts so crowded with timber that it is more like coppice land, and the pasture for want of sun and air becomes sour and unprofitable; and it is further objectionable, for it is useless for gentlemen to say we have magnificent trees in our park if they are hidden by a crowd of unsightly growth.

Live Stock.—On the vale farms the young lambs, whether Downs or Long-wools, will now feel the effects of the late frosty weather which reduced an early-looked-for crop into a later one, for the Rye and Grass in the water meadows were so severely checked in growth that they are later for feeding than usual; still there is generally, where due care has been taken, either some Swedish Turnips still left, or otherwise, which is better, some of the Golden Tankard Mangold. The latter is the best for spring food, as the quantity of saccharine matter contained makes them not only fattening food, but if fed in moderation with Bean or Barleymeal is not likely to scour the animals either of ewes or lambs. The only thing against Mangold for wether lambs or tegs is that they produce stoppage of urine for lambs in high condition at half growth. On some farms stubble Turnips are grown instead of Rye, to be hurdled off just as they come into bloom. The hybrid Scotch variety is used for the purpose, and they stand the winter well and bloom later. The lambs running forward eat off the leaves and blossoms and do remarkably well. The roots, although only small, are passed through the cutter for ewes mixed with cake cakemeal, both ewes and lambs going out daily into the water meadows or early

Italian Rye Grass. After the Rye or stubble Turnips are fed the land is ploughed and worked fine and drilled with Mangold seed and superphosphate without other manure, for when the roots are fed and the stalks, &c., remaining are ploughed in after cake feeding the land usually produces a full crop of Mangold. All milking dairies will now have a large portion of the cows dropping their calves at this time, and with well-bred stock the calves are valuable, especially of the Devon, Hereford, or Devon and Shorthorned cross, to go on and suckle for veal, and they are usually sold at a moderate price, for the dairyman gets rid of them at a few days or a week old, except a few heifer calves from the best milking cows to save for the increase of his own dairy stock.

EASY LESSONS ON DAIRYING.—This is the title of a very useful little 4d. pamphlet by the Rev. Canon Bagot, LL.D., published by Messrs. W. H. Smith & Son, London and Dublin, who labours so commendably in improving the dairy industry, in Ireland especially. A significant hint has prominence on the title page of this manual—namely, that Great Britain and Ireland are now paying £14,000,000 per annum, or £38,000 daily, for foreign butter. The following subjects are treated in the pamphlet in a brief clear manner:—The dairy, cows, milk and milking, cream and cream-setting, Lavel's separator, churning, colouring of butter, butter worker, salting and packing, calf-rearing, winter dairying, and dairy accounts. Landed proprietors and clergymen might well bring this concise and useful manual to the notice of the farmers and cow-keepers of their districts with mutual advantage. It is a miniature text-book on the important subject on which it treats.

OUR LETTER BOX.

Mustard in Fields (A. W., Sussex).—The best time for sowing White Mustard as a field crop is the end of March or beginning of April. The land should be clean and worked fine, also manured with 1 cwt. of nitrate of soda and 2 cwt. of bone superphosphate per acre; 20 lbs. of seed will be sufficient for an acre sown with Bennett's broadcast seed barrow. For a full account of the cultivation, uses, &c., of this crop we recommend you to obtain the back number of this Journal dated October 9th, 1879.

Cream Cheese (Inquirer).—A first-rate article may be made from a quart of cream, to which add a pint of new milk. Then warm it in hot water to about 90° Fahr., and add a tablespoonful of ordinary rennet. Let it stand till it thickens. It should then be broken slightly with a spoon and placed in a frame according to size required—about 8 inches square is usual, and 4 inches deep, in which a fine canvas cloth has been placed; and then it should be pressed slightly with a weight. Let it stand for twelve hours, after which it may be lifted out and replaced in a fine muslin cloth over which a little salt has been powdered. In a day or two it is fit for use. Or the cheese may be enveloped in small straw or rush mats after being powdered with salt.

METEOROLOGICAL OBSERVATIONS.

CAMDEN SQUARE, LONDON.

Lat. 51° 32' 40" N.; Long. 0° 8' 0" W.; Altitude, 111 feet.

DATE.	9 A.M.				IN THE DAY.				Rain	
	Baromet- er at sea and Sea Level	Hygrome- ter.		Direction of Wind.	Temp. of Soil at 1 foot.	Shade Tem- perature.		Radiation Temperature.		
		Dry.	Wet.			Max.	Min.	In sun.		On grass.
1883.										
April.										
Sun. 1	30.321	43.6	40.0	E.	39.6	53.7	33.0	73.5	27.6	—
Mon. 2	30.147	44.3	41.0	N.E.	39.4	63.2	29.8	98.4	24.7	—
Tues. 3	30.215	45.7	42.8	W.	40.4	65.6	36.0	103.0	30.4	—
Wed. 4	30.262	54.2	51.2	N.W.	42.0	64.0	42.8	96.4	35.3	—
Thurs. 5	30.254	51.5	47.7	N.W.	43.4	68.9	40.4	107.9	34.5	—
Friday 6	30.536	48.5	43.0	N.E.	45.0	66.3	41.8	102.8	42.3	—
Satur. 7	30.670	42.4	39.4	N.	45.7	56.5	34.2	95.1	32.2	—
	30.344	47.2	43.6		42.2	62.6	36.9	96.7	32.4	—

REMARKS.

- 1st.—Hazy at first; dry, fair, and calm.
- 2nd.—White frost in early morning; fine, bright, warm day.
- 3rd.—Fine and clear early; 8 A.M. thick fog, and dark till about 10 A.M., afterwards fine, bright, and mild.
- 4th.—Hazy and dull at first; fine, warm and very calm.
- 5th.—Fine and warm; wind in evening.
- 6th.—Fine and bright; cold N.E. wind.
- 7th.—Fine and bright, but cold.

The past week has been remarkable for the extremely high temperatures by day, the maxima averaging 62.6° against 48.5° last week, and 42.1° the week before. The nights have remained cool; in fact the average minimum temperature has been 36.9°, and in the week ending January 6th it was 43.2°. Of course from these remarks it follows that the weather has been very trying, the daily range averaging 26°, and being on the 2nd more than 33°. The barometer has been very high, and there has been no rain.—G. J. SYMONS.



19th	TH	Chiswick and Turnham Green Spring Show.
20th	F	
21st	S	
22nd	SUN	4TH SUNDAY AFTER EASTER.
23rd	M	[11 A.M. National Auricula Show.
24th	TU	Royal Horticultural Society, Fruit and Floral Committees at
25th	W	Royal Botanic Society's Second Spring Show.

A GOOD TIME COMING.

TO persons in a hypochondriacal frame of mind the words of our heading may have a mocking sound, but to those of sanguine temperament they will be inspiring. We do not claim to belong to either section, being neither predisposed to depression nor undue elation, but endeavour to survey calmly the circumstances that bear on the matters in which we with our readers are interested. Dark days have been experienced by many. Seven years of leanness of the land must in the very nature of things have exercised an untoward influence on the industry of horticulture; but have we not hope that we are on the dawn of a brighter future, and that the "good time" that so many have waited for so long and as yet so hopelessly is nearer than it was a year ago?

The past winter has been less unfavourable to the cultivators of the soil than several of those immediately preceding it; and the present spring, though it has been marked by cold wave of pronounced intensity, may yet have happy results. The dry keen winds have purified the soil and rendered it amenable to working, while the low temperatures may prove the salvation of the fruit crops, and we may yet have a golden harvest. So it may be in the more important products of the field. With a bountiful yield of grain—and we think there have never been recorded nine bad harvests in succession—the whole aspect of things would be altered and marvellously improved.

Horticulturally speaking there are not wanting signs of increased prosperity, though they may not be perceived alike by all. There may be, and we fear it is a necessity of the case that there must be, some who feel the pressure of the past too keenly; but taking a wide view of the subject, there is undeniable evidence of a better, firmer, brisker tone prevailing. The past planting season has been one of the best on record: it is, indeed, questionable if there has ever been a period during which the planting of trees useful and ornamental, including deciduous and flowering shrubs, has been so extensive as the one just closing. In the seed trade, which is of greater magnitude than many suppose, we have evidence that business has never been so brisk before as during the present season, while the sale of plants and flowers is certainly increasing. Individual purchases may possibly not be so large as of old, but the number of cultivators is becoming greater every year, and plants and flowers appear to be more and more appreciated as necessary adornments of homes and individuals.

The foreign trade in cut flowers and popular decorative plants is now immense and growing, a greater aggregate amount being invested in the wares of the horticulturist than was ever invested before. The demand for large plants because they are large is less marked than formerly; but for anything of special merit and rarity purchasers are readily found, and sums given that were unheard of in the "good old times." When we find two plants realising nearly £400 at a public auction, as was the case a short time ago in the sale rooms of Messrs. Stevens—namely, *Cattleya Trianae* Osmani 215 guineas, and C. T. Dodsoni 185 guineas, and a piece of a plant, as a piece of the former did, realising 107 guineas, we can hardly think we are living in the dark days of horticulture.

We are compelled to add, and we do so with regret, that the prospects of trade are better than those of gardeners. We could tell of five hundred worthy and competent men now either out of employment or waiting in nurseries for engagements. It is well that this fact, for a fact it unquestionably is, should be widely known, as it may possibly be the means of preventing hasty action in relinquishing a charge lightly. A safe course is to move slowly in this matter, as it is better to endure now than to suffer afterwards.

We know of only one remedy for this great excess of gardeners, and that is the employment of more *bonâ fide* labourers in gardens instead of encouraging and training so many young men to make cuttings and water plants. This would be better for all—for the young men themselves, who would find more lucrative employment; for employers, who by encouraging local labour would improve their districts; while the bone and sinew would be kept at home instead of migrating to towns, too often to find worse homes than in their native villages. This, the plethora of gardeners, is the one defect in the otherwise good promise of horticulture in the future, for the industry, we are constrained to think, is entering on an era of prosperity at home and abroad.

BEDDING-OUT.

THE season for bedding-out will soon arrive, and it is well to have things in order before commencing. Some gardeners do not decide what they are going to have in the beds until the plants are in the flower garden, and then they find they have less than was anticipated. A gardener ought to know in the previous autumn what the beds will contain for the following summer, with the number of plants required for each bed, and then inconvenience will be reduced to a minimum.

A few hints on the planting of beds may be of use to young gardeners. I daresay that nineteen out of twenty, if set to plant a round bed, would go to the middle of the bed first, which is wrong, and it is very seldom a perfect bed is produced if commenced in that way. If a bed is planted properly it will keep a good shape. It must be always remembered that sufficient plants should be placed in the bed to cover it entirely, so that no bare earth is seen from the centre to the edge. I know many young men think that bedding plants will do anyhow; or if they see a good flower garden the expression is, "We have not time to bother after the beds as you do;" but it really takes no more time (only forethought) to plant a bed well than improperly. Many flower gardens look unsatisfactory through the season owing to their being planted too

hurriedly. I was once remarking how bad some of the plants were looking through being put out too early, and was answered, "Oh, we have not the time like you; we want to get ours done," when they had not a twentieth part so much to do as we had. But those are the expressions we always hear when there are failures through carelessness.

When planting a round, oval, or any other shape, mark out the distance from the side of the bed to where the edging plants are supposed to finish; about 18 inches is a good distance, as that allows a double row of edging plants. Then draw a line round the bed, and in that line place the first row of plants. Plant the Pelargoniums slantingly, as that causes them to grow more compactly. After the first row is planted work round with the next row, and so on until the centre of the bed is reached, finishing off so that the bed does not have a pointed appearance. All edging plants except Centaureas and those of a dwarf habit do best when they are laid sideways, as they are more easily pegged down. In carpet beds the design must be drawn first, then place in the plants as most convenient to the workman.—A. YOUNG.

DISBUDDING PEACHES.

I do not know if Mr. Taylor has practised the system of disbudding Peaches or other trained trees as soon as the buds can be detected and picked out with the point of a knife or finger nail. I have adopted this method for many years past, often leaving only two shoots—one at the top to lead up the sap, and the other at the base, which is closely and evenly trained-in to supply fruit-bearing wood the following season. However, I never made it a rule to remove or retain any given number of shoots, but always have made it a point to have little denuding of wood or foliage during the swelling or maturation of the fruit. When the shoot to be left for next season has grown to the length required the top is nipped out, which aids in consolidating and maturing the growth. The fruit buds are also well thinned, leaving those best exposed to the light about an inch apart. By this practice I have reduced labour, always had trees in perfect health, and at no time from trees setting during January and February did I ever observe fruit dropping, or experienced any difficulty in having abundance to thin. But with late crops in unheated houses or where the structures have been crammed with the plants I have sometimes noticed that all the fruits have not set freely.

Having made the system so simple I have had no difficulty in teaching a youth in a few lessons to do the work expeditiously and admirably; cordons, horizontal, fan, and other training all yielding to the system without difficulty. Plums trained on open walls I have had very satisfactory when treated as I have described for Peaches, but more wood was generally left on the trees to shelter the embryo fruit during inclement weather, then good crops were secured. I began this practice (by experiment) when an under gardener in Wiltshire, but have made the system pretty general since about 1864. I having undertaken the renovation of a very old garden last July, erecting new ranges of glass, and planting afresh the walls and borders with young trees, it is my intention to adopt the system which has served me so well, economised so much labour, and maintained a neat evenly balanced growth. With Vines on the close-spurred system I have picked out all the buds except what were really wanted, but never saw any advantage from the experiment.—M. TEMPLE, *Carron-house, Stirlingshire.*

THE GLADIOLUS.

(Continued from page 293.)

I WOULD advise in the choice of varieties that such catalogues as that of Mr. Campbell be consulted, in which he follows the example of the Messrs. Vilmorin in specifying the earlier and

the later-flowering sorts, and that the latter be avoided. Further, it is my firm conviction that many corms are committed to the ground that have no chance of growing. It takes considerable experience to know readily really sound corms. If a flakiness or scaliness appear in the circle round which the roots emanate decay is there within. If pressed firmly this bottom will often yield more or less, and it may sometimes be pushed quite up into the decayed heart of the corm, while the skin retains its beautiful silvery appearance. The latter, which tyros rely upon, is no proof at all of soundness. I have returned this year to two quarters of imported corms of 1881 varieties badly affected, but most deceitfully beautiful. The decay of the interior is sometimes to be learned from a livid colour round the eye, from which the new shoot ought to spring, or round the base of the old stem. Sometimes a smaller or larger discoloured blotch on the side of the root tells the same tale. Completely, or at least sufficiently, baring the corm is necessary to arrive at the truth, and this I never hesitate to do. In all such cases as the above healthy growth is hopeless; at best a feeble effort, but defers the evil day.

To the bulblets then—certainly not to perpetuation of the corms—we, in Scotland at least, must look. Here occurs to me a fact worth mentioning. Everyone who has really practised the culture of the Gladiolus must have observed how of some variety now and then one plant, not necessarily the most likely, produces a spike that in colour and form surprises him. In giving me at the Edinburgh Show last year a warm invitation to Newfield, Mr. Gray as one inducement promised to show me a spike of Lacepede, which, to quote his own forcible words, "will make you jump." It certainly surprised me, and reminded me of one I had some years ago. No others have ever approached them that I have seen anywhere. Like instances crowd upon me. Judged by such standards I have never had in perfection but one Ambrose Verschaffelt, one A. Brongniart, one Horace Vernet, one Lacepede, one Legouvé, one Mary Stuart, and not one Madame Desportes. I did not see a really good specimen of A. Brongniart last year. Madame Desportes I have given up as hopeless; besides being one of the worst keepers I never had it good. Last autumn a spike of William Cunninghame astonished me. That root is gone, but I have a few bulblets from it. My neighbour has had that variety for a year or two, but has never had one sample to compare with mine in refinement of colour, size of bloom, or length of spike. He has vowed to discard Henry XIV. for the last two years. It has never been worth keeping with him. I had a Schiller last season superior to any we have ever seen. I have never had Le Vesuve worth looking at. My friend two years ago had one that haunts our memories.

I could easily multiply such instances. I advance as a solution that there are in commerce what for want of a better term I shall call "strains" of the same variety of Gladiolus, and that a majority, by no means an inconsiderable one, of the roots we plant, where these have not retrograded in our own hands, are the developed bulblets of corms that have more or less advanced in deterioration. On what other supposition are these departures from the original excellence of a variety to be explained? It cannot be merely from some fortuitous condition occurring in a strictly uniform treatment. I shall be glad were the subject deemed worthy of consideration in your columns. Meanwhile, on the supposition that I am correct, I would make the suggestion to my brother amateurs—others of professional experience may practise such caution already—that they carefully preserve the cormlets of such plants alone as produce perfect flowers if they are to be satisfied with the Gladiolus only in perfection. But I fancy that this is a much farther-reaching topic than we amateurs realise, and embraces the whole field of propagation. We know how advice is urged that we propagate several flowers by cuttings only from healthy plants producing properly formed and coloured blooms. If my memory serve me right this was not very long ago suggested in the Journal in taking buds of Roses only from a shoot that had produced a perfect flower. And I suspect we ought in every case to adhere rigidly to such counsel. How does this impinge upon such a question as "strains" of the Auricula? Are not offsets of General Niel, Glory, Lovely Ann, White Rival likely—nay, may I not say certain—to

inherit the debilitated constitution, the deformed frame, the sickly pallor of an unhealthy parent, and to perpetuate in and through themselves the abnormal declensions of their progenitor? Mr. Gray told me that he destroyed his whole stock of one variety of *Gladiolus* as it was never satisfactory, and obtained it elsewhere. I had a few years ago to throw out all that I had of the Pansy David Caven, which, treat it as I would, never gave me a proper flower. It is nothing uncommon to hear varieties of this and of other flowers denounced or spoken slightly of by some which others highly esteem and show in capital form, and that in places closely adjoining. And I was told last year of one *Auricula* that will not form plants of any size with an experienced cultivator, the variety being in general robust enough. I submit, gratefully subject to correction by more competent authorities, the above theory as an attempt at solving an undoubted fact and a seeming mystery.

But I have strayed perhaps too far from my more immediate subject. I offer no apology for expressing opinions distasteful perhaps to some, welcome I trust to many, as truth should be to all, very saddening to myself, who hold the *Gladiolus* when in perfection to be peerless among flowers in commanding beauty. If I have framed a strong indictment, the charge of high misdemeanour for which the bewitching traitress is arraigned before the tribunal of your readers is notoriously flagrant, and is assumed to be well established. Be it distinctly understood that no evidence for the defence can be admitted as valid obtained from any of her family whose term of residence in this country is not sufficient to entitle them to rank as naturalised citizens of the realm, or from any of her kindred whatever with whom the witness has not had at the least a second or third year's acquaintance. We must worship Truth before Flora, and our faithful devotion to the latter cannot ultimately suffer from our love and adoration of her diviner sister. Therefore, as a closing word, let me tell my friends, in Scotland at any rate, who long to add the *Gladiolus* to their other favourites what is before them. The field is open to all, but, so far as experience has gone, they will under present conditions discover that while it is beyond compare a thing of beauty, its culture will not prove a joy for ever.—A NORTHERN AMATEUR.

NORTHWARDS—CLOVENFORDS.

GRAPE-GROWING EXTRAORDINARY.

As our Belgian friends have provided matter of interest to British readers in the great Exhibition of plants at Ghent, which is reported in another column, it will not be inappropriate as a *quid pro quo* to submit for the perusal of the skilled continentals a description, however feeble, of an example of culture in another form, that, I do not hesitate saying, was fully equal in its way to anything that has ever been seen even in horticultural Belgium. They have provided a great spectacle of plants, many of them of marvellous beauty and commanding merit; but much as their best specimens astonished those English visitors who saw them for the first time, the remarkable example of Grape culture now under notice would have equally astonished the most expert of Belgian cultivators had they seen the crop that haunts my memory as one of the most splendid achievements in practical horticulture that it has been my good fortune to see in any country.

A great and growing interest in Grape-culture exists in Belgium now. Last year an enthusiastic amateur of that thrifty nation visited England with the object of seeing some of the best examples of Grapes growing in our island. Among other places he went to Clovenfords, and although he was much too early to see the crops to advantage, his verdict was a shout of amazement—"Bon! Bon! Magnifique!" The verdict of some of the best of British gardeners who saw the crops in September was of the same character. They were astounded by the weight of fruit

they saw in a house of Gros Colmans, one describing it as amazing, another as astonishing, and a third as murderous—a term that will be well understood as indicating that no Vines could perfect such an exhausting weight of produce. Almost every gardener who saw this crop in September believed it was impossible the Grapes could colour and finish well. As I was almost alone in ruling to the contrary, I may as well state why I felt certain the crop would ripen, as a verdict without a reason for it is of little worth.

Heavy as was the crop, and at the first glance crushing, yet a closer inspection showed it was safe. The evidence of this to my mind was the stout sub-laterals that were bristling from the growths beyond the bunches. These denoted that the fruit was not receiving the whole of the strength of the Vines, but that there was a reserve left for the prolongation of growth. This should always be so. If, when Grapes approach the colouring

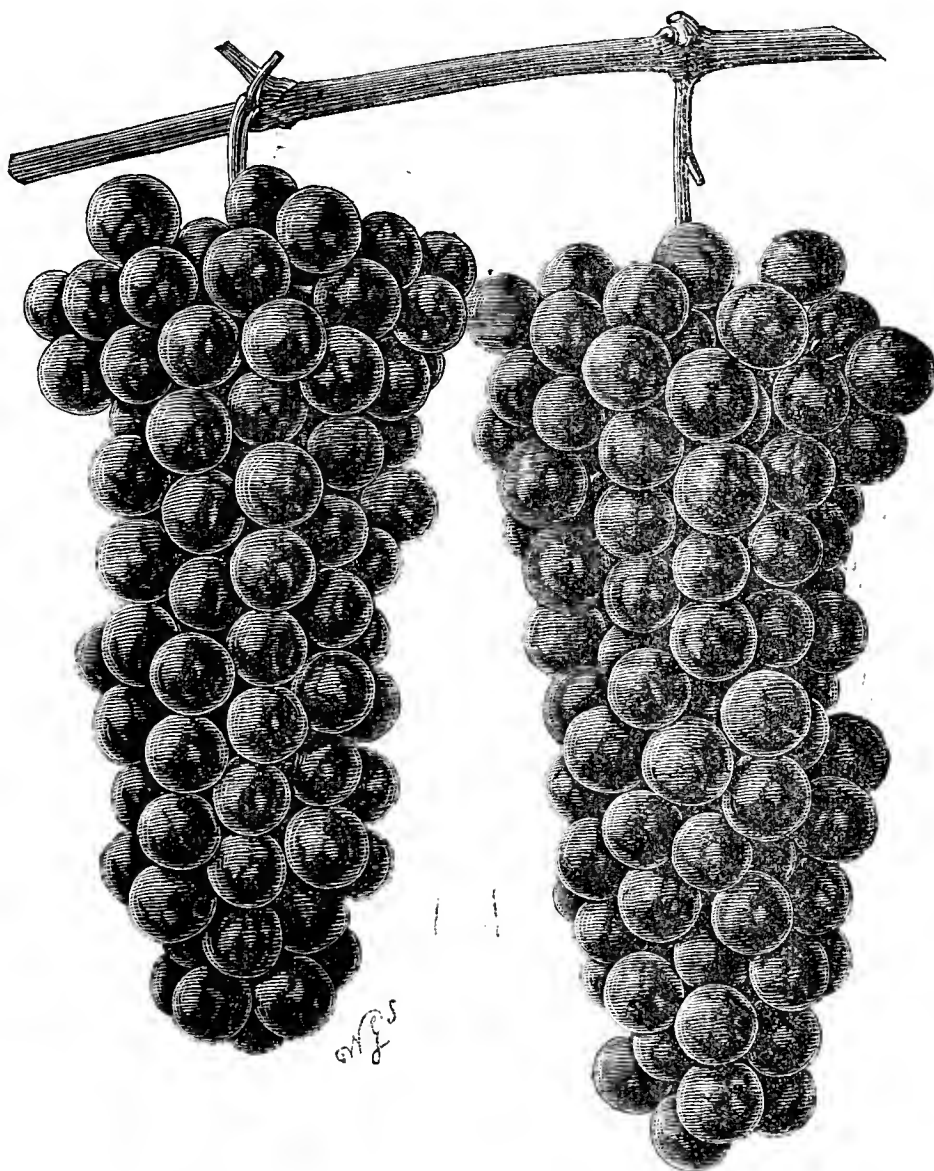

Fig. 75.—Lady Downe's Seedling as grown at Clovenfords, the shoulders being trimmed off. Weight about 4 lbs.

stage, the laterals cease growing entirely, we may be certain that the crop is too heavy, and the fruit will either fail to colour or to swell freely or regularly, or, if possible, there is a still worse alternative—it may shank. A crop of fruit is to the tree bearing it what the "governors" are to the steam engine. If there is a surplus of steam in the cylinder, or, what amounts to the same thing, a relief of pressure of the load that is being dragged along or driven, the governors at once rise, extend to a horizontal position, and move with great rapidity. If the power of the steam is taxed to the utmost by the resisting pressure, down fall the indicators, which revolve slower and slower until the whole machinery stops, unless the pressure is relieved. It is precisely so with a crop of Grapes. The fruit must first be supported, and not until it has had its share of sustenance is there a further extension of growth. If the crop is light in proportion to the strength of the Vines lateral growths will extend freely and move

quickly; but if, when the fruit is swelling, there is no further growth—no young laterals—we have clear proof that the pressure of the crop is too great, and unless this pressure is relieved by removing some of the bunches either the fruit will fail to swell, ripen, or finish well, or the Vines will be injured. So long as a Vine continues growing with easy freedom it is not overcropped, let the crop be as heavy as it may, but if it ceases growing when the fruit is swelling it is too heavily weighted, however apparently light a crop. Such are the thoughts that have arisen from an inspection of this wondrous house of Grapes in the celebrated Tweed Vineyard, and it may possibly be of service to some reader to “think aloud” on a matter which is undoubtedly of considerable importance.

But to the description of this world-famed establishment. Its situation is undoubtedly beautiful—a depression sheltered in the not very remote distance by a grand range of hills. The soil, judging by the natural vegetation, does not appear to be of a particularly fertile character, and the surprise becomes the greater, and the skill of the cultivator the more striking, when we enter the houses and see the remarkable crops of fruit. Altogether there are fourteen glass structures heated by twelve boilers and five miles of piping. This indicates that the houses are not small. Two lean-to's are each a thousand feet long, but the most imposing are the five grand span-roofs, each 200 feet long, 18 feet wide, and the same in height, with very steep roofs, having an angle of, perhaps, 70° or 80°, and the glass reaching almost to the ground. Two of these houses are planted with Gros Colman, two with Lady Downe's Seedling, and one a mixed house, a great portion of one side being covered with the noble Duke—the Duke of Buccleuch, and the remainder with Black Hamburgs. A half-span house is furnished mainly with Alicantes, and some other large structures are occupied with a grand lot of Orchids. The Grapes, however, demand primary notice. The crop of the season was estimated at six tons, and it is a question if that quantity was not considerably exceeded.

In one house alone the crop of Gros Colman was computed at 4000 lbs., and in the others of the same variety at 3500 lbs., or nearly 3½ tons in the two structures. A pound bunch was extremely difficult to find here, but hundreds must have weighed from 3 to 4 lbs. each—handsome well-shaped examples with huge berries, not angular clusters with great shoulders jutting out that we often see now-a-days, for the sufficient reason that such monstrosities cannot be packed for enduring a four-hundred-miles journey and arrive at their destination in the best condition for sale. This is a matter of vital importance, for bad packing is the great cause of the low prices that so many amateurs obtain for their produce.

The Vines under notice are planted inside, the roots having access to outside borders. Many of the Vines had been partially lifted in the autumn outside, the inside border having been surfaced with loam and dressed with 1½ ton of Mr. Thomson's manure. Into this the roots had come, forming a dense network of white fibres, visible enough by rubbing off a film of surface soil with the hand, revealing undoubtedly the secret of the extraordinary weight of magnificent fruit. This inside border, too, it may be added, was almost as hard as if it had been the drill ground of a regiment of soldiers; in fact, had it been light and soft the millions of bristling fibres would not have been there.

Few of the Vines are confined to one rod; some have two, some three, others four or five. The house was originally planted with the present variety and Alicante alternately, but the latter proving the least satisfactory was eventually removed and the spaces occupied with extra rods of Gros Colman. These are trained about 3 feet apart, none of them at wider intervals, but many of them were nearer 2 than 3 feet asunder; but then there is this important proviso, the laterals were not crowded. Every leaf had room to develop under the direct action of light, and wherever the sun could reach a leaf was provided to receive its rays. This is the great desideratum in Vine-dressing—no foliage that the sun cannot reach, and no great gaps between the leaves through which the rays pass. Stiff stilted advice for stopping the laterals at so many leaves beyond the bunch, neither one more nor less, is little short of pedantic, and the distance for training the rods and the laterals can be easily determined by the size of the leaves.

Vines trained on this principle, with a firm border netted with roots, like a bed of couch, having an abundant supply of proper food, bear such crops as some persons who fail conceive incredible. For example, on a portion of one rod the foliage of which covered a space of 6 feet by 3, there were ten bunches of Grapes that I am positive weighed in the aggregate more than 20 lbs. I willingly excuse anyone who may conceive this to be an error in judging weights. I have made no mistake for all that, but have

recorded an absolute fact; indeed, I have no doubt that the crop within the space named weighed 25 lbs. This is Grape-growing, for the berries were as fine as the bunches and the crop. Gros Colman is the variety still under notice. I will now state, what to many will be still more difficult to admit, that on a similar space in another house there was about the same weight of that magnificent Grape the noble Duke; but more of this anon.

Less imposing, but not less remarkable, was a house of Lady Downe's containing two thousand bunches that would weigh as many pounds, shapely as if cast in moulds, and in the best possible condition for quick and safe packing, while the berries were as regular and fine as the bunches were symmetrical. As everybody, presumably, has not yet seen Mr. Barron's new work on the Vine, the engraving, fig. 75, will show the character of the engravings, and at the same time that of Lady Downe's Grapes as grown by Mr. Thomson, for the bunches represented were grown at Clovenfords. “What! two bunches on one lateral!” does someone exclaim with horror. Yes. Why not two pretty bunches weighing 2 lbs. each instead of one awkward cluster weighing 4 lbs.? The cultivator of the Grapes figured knows why. He knows that while one sample would not be more exhausting to the Vine than the other, this compact pair will reach London in better condition than one ill-formed cluster of the same weight would, and realise more money. And as to the dread of two bunches on one lateral, it must be remembered that some Vines will carry these more easily and safely than others will a crop at the rate of one bunch of the same size to two laterals. The question of cropping is a question of the condition and constitution of the Vine. A weak, ill-supported, immatured rod can no more carry a weight of Grapes equal to a rod of the opposite character than a worn-out cab horse, value 30s., can draw a load equal to that of a strong well-conditioned brewers' dray animal value £100.

I have more to say about Clovenfords, but when I shall say it nobody knows, for when these notes appear I expect to be among the Belgians, and they are, to use a not over-elegant yet expressive phrase, such “jolly good fellows,” that there is a little uncertainty when I shall get “back to old England again.”—J. WRIGHT.

LILY OF THE VALLEY—HOME-GROWN CLUMPS.

THE details of growing Lily of the Valley for early forcing have been given several times in the pages of this Journal during the past few years. However, I may briefly state that our “clumps” are not forced until they have passed a season in pots. We grew them for several years in pots, and under this system have them full of flower spikes and foliage. I send a specimen of the foliage of plants just going out of flower (our latest batch), and which I think the Editor will bear me out in saying ought to produce fine spikes next year.—R. P. BROTHERSTON.

[We have never seen such stout dark green foliage, which resembles that of the Eucharis. The leaves before us measure 9 inches long, and as nearly as possible 4 inches wide, the leafstalks being three-quarters of an inch in circumference. Each of the faded spikes of flowers contains eighteen bells. Certainly such vigorous plants “ought to produce fine spikes next year.”]

GHENT INTERNATIONAL SHOW.

APRIL 14TH TO 22ND

EVERY five years horticulturists from almost every nation in Europe assemble in Ghent, and plants from nearly every clime are arranged in the casino and gardens, forming the Quinquennial Exhibitions that have long enjoyed such wide celebrity. These famous Shows are held under the auspices of the Royal Agricultural and Horticultural Society of Ghent, which was formed fifty-five years ago, and held its first Show of fifty plants in a smoke room. The progress that has been made by the Society, and the work it was established to promote, has been marvellous. From the very small beginning that was made truly great results have been achieved. The pioneers of the organisation were few, and we believe not powerful, except by their capacity for labour, and the skill of subsequent adherents in administration, for the Society is now strong, and that it is rich is evident by the very large amounts that have been provided for the medals that constitute the prizes at these exhibitions. But in addition to its own funds substantial grants are made by the province of Flanders, the municipal authorities of Ghent, and by the Government. It appears to be the custom of the latter to make a grant to any public object to which the communal and civic authorities subscribe, to the extent of one-third of the amount—that is to say, should those authorities each subscribe 20,000 francs towards a public park, statue, or horticultural exhibition, the Government would grant 10,000 francs. We have not yet adopted this method of raising money in England

for similar objects, nor is there much hope of the nation becoming "educated" sufficiently to acquiesce in such a disposition of the public funds; and there are also invariably special donors, including the King and Queen, who provide liberally in a few classes. Under these circumstances it is not surprising that imposing schedules are arranged, that of the present Show containing nearly three hundred classes, nor that the number and value of the medals amount to a somewhat formidable total, though it must be admitted that the sum appears greater as represented in francs of 10*d.* each than it would in pounds sterling. Nearly nine hundred medals are enumerated in the schedule of the present Exhibition, of which about 130 are gold, the aggregate value of the latter being 17,000 francs. Objects of art are also provided in two classes, and we observe one money prize of five hundred francs offered by the Federation of Belgian Horticultural Societies. The six silver cups, too, offered by Mr. Bull add materially to the prize list, so that altogether the aggregate value of the prizes offered on the present occasion amounts to 30,000 francs. This sum, however, was not all disbursed, for it would have been little short of a miracle had there been competition in every class of a schedule so comprehensive. Such, then, is the provision made for the eleventh Quinquennial Exhibition of the Royal Horticultural Society of Ghent.

Before recording the results we may not unfittingly glance at the character of these shows. As has been stated on previous occasions, Belgian exhibitions are managed very different from gatherings of the same nature in England. They are, in fact, great ceremonial floral fêtes, in which the military figures prominently, and banquets, meetings, receptions, operatic performances, &c., appear to form an integral part of the proceedings. As entertainers the Belgians excel. Thoughtful, hospitable, and affable, they appear to anticipate every want and provide for every taste, while undoubtedly they possess the aptitude for making everybody as far as is possible happy. They invite all nationalities, and there is no wonder the invitations are so freely accepted, as this year they were especially, all the rooms in the chief hotels having been engaged for weeks before the Show. They manage, too, to find occupation, honorary and congenial, for the greatest possible number of visitors, and thus identify them with their work. In the work of prize-adjudication, for instance, what would be done in England by ten judges is in Belgium allocated to a hundred jurymen, divided into groups, and each having its foreman or president. On the present occasion the jurors numbered 128, invited from Germany, France, Italy, Holland, Russia, Switzerland, and England. There were also about forty from Belgium. The English jurors numbered twenty—namely, Messrs. Bull, Cannell, Deal, Hogg (Dr.), Goldring, Hibberd, Hill, Johnson, Ker, Laing, Masters (Dr.), Moore (London), Moore (Glasnevin), Richards, Turner, Veitch, Warner, Williams, Wright, and Wynne, nearly all of whom answered to their names at the roll-call. After the delivery of credentials these important personages begin their work. The plants are placed in their allotted positions by the exhibitors on the day preceding the Show, and their merits are determined. At noon the next day the Show is opened by Royalty, Her Majesty officiating on the present occasion on account of slight indisposition of the King. The city is *en fête*, the national flag flying everywhere, and the streets crowded. Her Majesty and suite also visited the celebrated nurseries of MM. Linden and Van Houtte.

The Casino in which the Show is held is a Grand Hall of Harmony, the headquarters of a great musical society, and the gardens attached are for the use of the members. Thus music and flowers are associated, not in name only and in a casual manner, for the two Societies—the Musical and Royal Agri-Horticultural—are amalgamated, forming one grand organisation; and herein is the secret of the great number of supporters of the Society under which the present Show is held. Great flower shows, then, ought to be provided, especially as they only come once in five years, in what might be termed the chief horticultural province in Europe. Great the present Show undoubtedly is, and it represents in a striking manner the remarkable horticultural resources of the province in which it is held. Except a fine bank of Cyclamens from Mr. B. S. Williams, a small typical group of hybrid greenhouse Rhododendrons from Messrs. Veitch, a bright contribution from Mr. Cannell, and bouquets from Mr. Brown, Richmond, nothing came from England as on the occasion of the last Exhibition in 1878. But it is clear the Belgians can make an exhibition of their own at once great, bright, and beautiful. Messrs. Foster & Pearson were also successful exhibitors, but not of plants.

The plants are arranged in a series of buildings, the principal hall being about 250 feet long by 100 feet wide, flights of steps on one side leading to a platform entrance to other rooms. From this platform the effect of the grand masses of Azaleas, relieved by stately Palms—some in groups at the sides, the leaves reaching to the roof 25 feet above, others on separate pedestals, so as to show the characters of the plants to advantage. Tree Ferns, also isolated, tower above rich masses of flowers, amongst the brightest of which are Imantophyllums; while highly coloured Crotons and bright fine-foliaged plants, stately Yuccas, sturdy and chastely marked Bromeliads, and noble Cycads impart a diversified character to the richly furnished hall. No formal report of the Exhibition will be attempted, but only the character of the collections with a selection of varieties of special merit in some of the classes can be briefly particularised. For twenty new plants in or out of flower the gold medal was awarded to M. Van Houtte. One of the most striking plants in the group is *Pritchardia*

grandis vera—not *Licuala grandis*—under which name, it appears, many plants of so-called grand *Pritchardias* have been grown. The true form is highly distinct, very beautiful, and when it attains size will be majestic. M. Van Houtte also stages the new hardy Palm *Washingtonia robusta*, for which a medal as such is given in another class. *Alocasia Van Houttei* has noble leaves, *Nepenthes Mastersi* fine richly coloured pitchers; *Aralia Kerchovei* is a stately plant with leaflets 6 inches long, an inch wide, and deeply toothed; *A. regina*, with the slender leaves and dark colour of *A. Chabrieri*, is extremely elegant; and *Selaginella grandis* is no doubt the grandest of the genus. M. Auguste Van Geert worthily wins the silver-gilt medal in the same class with several plants the same as those enumerated, including the *Pritchardia*, and the addition of Messrs. Veitch's new plant *Leea amabilis*, the most striking new fine-foliaged plant in the Show.

A gold medal was granted to M. Van Houtte for a new plant introduced by the exhibitor. This plant is named *Attacia palmatifida*. It has palmate green leaves an inch in diameter and deeply lobed, the stems being 18 inches high, and in character somewhat resembles an *Amorphophallus*. The medal for a new flowering plant raised from seed is awarded to M. Rosseel for a beautiful *Imantophyllum*. Messrs. Van Houtte and M. Auguste Van Geert won Mr. Bull's fifteen-guinea and ten-guinea cups in the order named. M. Van Houtte staged a grand specimen of *Dracaena Lindenii*, *Licuala grandis*, *Anthurium splendidum*, the first time it has been staged. It has dark green much-corrugated foliage, and gives promise of making a stately and imposing plant. *Pothos aurco-maculata* we never saw so good; for covering walls in stoves it is admirably adapted, and grows with great freedom. *Heliconia aureo-vittata* is also in beautiful condition, and *Dracaena venosa* (it ought to have been *maculata*), appears very distinct by yellowish irregular blotches on a green ground. M. Van Geert has similar plants, with the addition of the highly distinct *Asplenium-like* Fern *Alsophila Rebeccæ* and *Kämpferi Gilberti*, a dark green white-margined-leaved plant like a small *Funkia*. The *Compagnie Continentale d'Horticulture* exhibits a remarkable group of new plants not for competition, of which *Massangea hieroglyphica* is one of the most stately, the leaves, 4 feet long and 3 inches wide, being clearly marbled with cream on a bronze-green ground. *Aralia gemma* is extremely graceful, with leaves a foot long, with much-divided leaflets, the terminal an inch wide, ovate, and deeply toothed. *Vriesia bellula* is a very dwarf free-flowing plant, the sheaths being coral-red at the base, greenish-white above, and the spikes only 6 inches high. *Amorphophallus Lacouri* has its divided green leaves as if blotched with whitewash, *Tillandsia fenestralis* is distinct, and *Echeveria decora variegata* has large leaves half cream and half green. For this group the great gold medal was awarded.

ORCHIDS.

These from an English point of view was the weak point in the Exhibition. In the gallery a novel idea was adopted representing an old tree with its branches shortened to lengths of 3 or 4 feet, at the end of each an Orchid being fixed with moss. Some two dozen of these had a decidedly pretty effect, and an improvement on the idea might result in something very effective. In the classes there appeared to be good competition, several groups being staged, but the plants generally are small and lacking in that depth of colour of foliage and general vigour we are accustomed to see at home. One group especially contains good *Dendrobiums*, and we observed fairly good spikes of such *Odontoglossums* as *Alexandrae gloriosum*, and triumphans, a good plant of *Cymbidium Lowianum*, very fine blooms of *Cypripedium Laurenceanum*, and a few good *Phalænopses*. Orchids are evidently increasing in numbers in Belgium, and doubtless there will be a great display at the next great Show in 1888. MM. Vervaeet et Cie. are the gold medalists for Orchids; M. Vuylsteke stages a well-flowered group of *Odontoglossum Alexandrae*, perhaps the best grown plants in the Show, even if they are small. M. Dallièrre secures the gold medal for *Nepenthes* with small plants.

PALMS.

No plants are more extensively grown in Belgium than Palms, hence we find eleven classes for them and seven gold medals. The plants staged are truly magnificent both as regards size and quality. Perhaps the king of the collection is a marvellous specimen of *Ceroxylon andicola* (the Wax Palm) in the great collection of M. Ghellinck de Walle of Azalea renown. This Palm is considered the finest cultivated example of its kind in the world, some twenty beautifully arched leaves averaging about 20 feet long. Amongst single Palms, elevated on pedestals, remarkable for development, *Corypha australis*, from M. D'Haene, has a spread of 20 feet, and wins the chief prize; *Phoenix reclinata*, a grand example 15 feet across, *Astrocaryum rostratum*, 10 feet high, bearing clusters of shielded fruits as shown on page 573 last vol.; *Pritchardia macrocarpa* is splendidly represented by a handsome specimen of this noble Palm. In the amateurs' class of twenty-five plants M. Ghellinck de Walle exhibits such a group as can only be seen in Belgium, the specimens being not more remarkable for their size than their splendid condition. Besides the grand *Ceroxylon* above mentioned, *Sabal Blackburniana*, *Livistonia australis*, and various *Chamærops*, *Areca Baueri*, &c., are of noble proportions. Noticeable also are grand examples of *Livingstonia Hoogen-dorphi*, *Cocos Bonneti* (fine for a pedestal), *Lantana rubra*, *Livistonia*

robusta, and Kentias. In the corresponding class for nurserymen splendid specimens are also arranged by all the exhibitors, whose catalogues may well be consulted by those who are interested in these plants, and the same remark applies to the exhibits in the smaller classes, as it is not possible even to enumerate them here. Gold medals are awarded to MM. Ghellinck de Walle, D'Haene, Spae, and Moens, in the several classes.

In the class of Palms for arranging in the open air in the summer, *Chamaerops humilis* excluded, M. Van Houtte exhibits a new Californian Palm, *Washingtonia robusta*, having a general resemblance to *Pritchardia filamentosa*, but more robust and evidently a free-growing variety that promises to be of great decorative value.

M. Moens secures the amateurs' gold medal for ten new Palms, very striking and elegant being *Chamaerops humilis bipartita*, which is particularly slender, light, and graceful. In the class for new non-flowering plants both the medals go to M. Massange de Louvrex for *Vriesia Brameri*, a strong grower with green darkly veined leaves, and *Massangea tigrina* beautifully marbled.

CYCADS.

Like Palms these are extremely popular, and five gold medals were offered in six classes. Very striking groups and splendid examples are exhibited, among the finest being *Zamia caffra*, with grand leaves; *Z. Frederici Guilielmi*, with a stem 18 inches in diameter and healthy head; *Z. Katzeri*, highly distinct; *Z. horrida glauca*, *Z. Altensteini*, fine; *Z. Lehmanni glauca*, very ornamental; *Z. recurvata*, excellent; *Z. Vroomi*, large; and *Cycas neo-caledonica*, very elegant. A grand specimen of *Lepizodamia Perofskiana* commanded attention; it is very like *Macrozamia spiralis*, if not identical with it. Gold medals are awarded to MM. Ghellinck de Walle, Vander Woner, De Smet, and Wartel.

FERNS.

Although unquestionably many valuable collections are arranged, and some imposing specimens, they do not on the whole excel those staged at the best English exhibitions, except as regards the Tree Ferns, several of which are extremely fine. MM. D'Haene, Van Houtte, Van Geert, Ghellinck de Walle, and De Smet are among the chief prizetakers. Filmy Ferns are exhibited in cases, the plants consequently not large, but the number of varieties included show how an interesting collection of these most elegant plants can be accommodated in a small space. For these a gold medal is granted to M. De Smet.

The most attractive Fern in the Exhibition, and to which the silver-gilt medal for a new variety raised from seed has been awarded, is a variety of *Gymnogramma schizophylla*, 2½ feet in diameter, with beautifully arched fronds 2 feet in length, and equal in elegance to any Filmy Fern. It is exhibited by M. Maron, and is extremely beautiful—without doubt the best Fern in the Exhibition.

ORNAMENTAL STOVE AND TEMPERATE HOUSE PLANTS.

M. Van Geert wins the great gold medal with a grand collection of ornamental-foliaged plants. *Raphis flabelliformis variegata*, a grand example; *Dracæna Lindenii*, superb; *Zamia Van Geerti*, splendid; beautiful *Anthuriums*, *Sarracenia Drummondii*, and Ferns are prominent in this admirable group. In the class for greenhouse plants in flower M. Van Geert wins the Queen's prize with an imposing group, amongst which huge golden-headed *Acacias* show to great advantage. It is somewhat surprising that these plants are not more extensively grown in England. A huge pyramid of *A. armata* shows how elegantly bright such plants are. A noble standard of *Sparmannia africana*, with a head 6 feet through, is the conspicuous centre of another group.

DRACÆNAS, CROTONS, AND BEGONIAS.

The former are the more popular, having four classes and three gold medals, only one gold medal being provided for the latter. The response we are quite unable to consider satisfactory, and far finer plants are constantly staged at home. The most effective *Dracæna* is *D. Lindenii*, of which there are many fine examples, in every respect healthy and in grand colour. This plant does not always grow freely with us, but that would now appear to be entirely the fault of the cultivators. We observed no other *Dracænas* calling for notice, except a small houseful of very healthy plants from M. Pynaert.

Very healthy, well-grown, fresh, and highly coloured *Crotons* are arranged, a few of the most effective being *musaicus*, with glowing red leaves a foot long and 2 inches in diameter; *interruptus elegans*, both bright and curious; *Montfontainensis*, pseudo-trilobed, deep red leaves; and *Albert Truffaut*, ivory white, buff, and green, leaves 1 foot by 3 inches. M. Pynaert stages an excellent group of ornamental-foliaged *Begonias*, his collection of these plants being very great, and many of them very rich and handsome. Half a dozen good and distinct varieties are *M. Ferrais*, *M. Justinian Brettonneau*, *Zenobia*, *M. T. Bonnel*, and *President Belle*. The gold medal for *Coleuses* is awarded to M. Bruyère, Lille, who exhibits very striking varieties quite distinct from any in commerce in England. M. Auguste Van Geert is the premier exhibitor of *Sarracénias*.

AZALEAS.

These plants being grown so splendidly and extensively, we were not surprised to find twelve classes and nine gold medals for the

A. indica type, and four classes and three gold medals for hardy Azaleas. To indicate half the plants that are of superior merit in the several classes were impossible. We have never seen anything approaching such a display of these plants in England. The specimens are umbrella-shaped, on stems ranging from 2 to 8 feet high, and with heads of the same diameter—dense masses of flowers so closely packed that thousands have not room to expand, and yet they are of great size, the plants growing with a vigour that is quite wonderful. In the class in which the plants are remarkable for their vigour and floriferousness we must notice a beautiful white—*Pucelle de Gand*. Near it, and exceedingly rich, is a variety of sterling merit, named *Hooilzincikii*, flowers purple suffused with crimson, highly effective. *Roi des Belges*, double red, is glowing and massive, but grander still is *Souvenir du Duc de Brabant*. One of the best of the double rose-coloured varieties is *Juliette*, *Rosette* having larger but less double flowers; striking double crimsons, *Duchesse Adelaide de Nassau*, with purplish upper petals, and *Triomphe de Hanneau*. The best variegated-flowered sorts are *Souvenir du Prince Albert*, *Sigismund Rucker*, and *Beauté Supreme*. Of whites, *Apollon*, *Leonie Van Houtte*, and the variety above-named; as a double white, *Bernard Andreas alba* is not surpassed. Of rose-coloured singles, *Reine des Roses superba*, very deep, and *Oswald de Kerchove*, crimped petals, are amongst the most striking. As single scarlets, *Flambeau* is particularly dazzling, but *Roi d'Hollande* has finer flowers, while *Marquis of Lorne*, orange scarlet, and *Eclatante* must not be passed without note. These are rich indeed. *Dame Melanie*, pale salmon, is much admired. *Cedo Nulli* is perhaps the deepest purple. *Comte de Flandre* is remarkable by its purple top and rosy crimson lower petals, a lovely double cerise being *Grande Duchesse de Bade*. *Madame de Grevé* is conspicuous by its deep salmon blotch on a blush ground, like a light show *Pelargonium*; *Madame Ghellinck de Walle*, pale salmon, margined white; *Bijou de Paris*, white, faintly flaked; *Jean Vervaene*, white and salmon, sportive, one of first-rate excellence. Grafted Azaleas—that is, concentric rows of distinct colours, are very striking, notably the red and white varieties of *Souvenir du Prince Albert*, worked by M. Vervaene.

New Azaleas.—The first prize was awarded to M. Van Houtte for six plants. They comprised *Baron N. de Rothschild*, double, plum colour, grand; *Prince Rudolphe*, semi-double, scarlet, brilliant; *Marshal Wilder*, blotched white; *Comte de Germany*, single, crimson-scarlet, splendid; *Comte de Paris*, salmon-peach, fine; and *Madame Planchon*, white, rose-flaked. For the best new seedling Azalea M. Van Houtte was again successful with a charming semi-double variety, named in honour of an accomplished English florist, *John D. T. Llewelyn*; its colour is flesh, suffused with salmon, and deeply blotched. *Vervaene's Perfection de Gand*, rosy crimson; *M. Lubruse*, deep rose; *Mdlle. Louise Vervaene*, double white; and *La Tendresse*, single white, will be heard of again. The best new hardy plant raised from seed in Europe is *Azalea mollis Bienvenue*, a rosy salmon of great excellence, exhibited by M. Vuylsteke. In the class for four Azaleas not in commerce M. Van Houtte is again to the fore, Mrs. B. S. Williams, a double white, being the best of the quartette, and the most charming white flower yet raised. He was second also. *Princess Beatrice*, white, smooth and beautiful; and *Princess Alice*, a free charming rose, being admirable. Gold medals were won by *Comte Kerchove de Denterghem*, and MM. Ghellinck de Walle, Rosseel, Beaucarne, Vuylsteke, D'Haene, and Vervaene.

Hardy Azaleas.—A large bed 20 feet by 10 feet of *A. mollis* is the chief floral feature of a very large building, the plants, including some fine standards, being huge bouquets of flowers without the relief of a particle of foliage. There is a great similarity in many of the varieties, but the following are a few of the most distinct and good: *Chevalier A. de Reali*, *Charles Kekule*, *Baron de Constant Rebeque*, *Alphonse Lavallée*, *Comte de Gomer*, *Baron Edmond de Rothschild*, *Comte de Quincey*, *Albicans*, *Comte de Kerchove*, and *Flava amœna*. A corresponding bed was filled with Ghent Azaleas, the smaller flowers of which have foliage associated with them. The most distinct and effective varieties exhibited are *Gloria Mundi*, *Daviesii*, *Ardentissima*, *Queen Victoria*, *Marie Dorothée*, *Jenny Lind*, *Souvenir de Royghem*, and *Graf von Méran*.

CAMELLIAS.

These are far less numerous than Azaleas, yet the plants are much superior to those seen, when they are seen, at English shows. They vary in height from 18 inches to 6 feet, and are wonderfully flowered, the foliage being as bright and healthy as the blooms are fine. Evidence of tying the plants into form is rather too apparent, but they are in fine condition for all that, Belgian leaf soil (of which more anon), abundance of water, and judicious shade having contributed to the very satisfactory results. In the class for six new varieties the medal was awarded to Mr. De Schryner, but the varieties are not superior to others in cultivation.

CAPE AND NEW HOLLAND PLANTS.

M. Van Houtte won the gold medal with a bright group of healthy well-flowered examples, of which the following are the more noteworthy and deserving extended culture:—*Cytisus elegans*, elegant indeed, and laden with long golden sprays; *Metrosideros semperflorens*, crimson, and *angustifolia flore-pleno*, white with yellow anthers, highly effective; *Choysia ternata*, a fine standard, charmingly telling; *Acacia cordata*, buff, one of the most chaste and neat of the genus, a

standard plant being beautiful, and in fine contrast another of *Clianthus magnificus*. *Pultenaea flava* is also pretty in the group, and *Correa atrovirens*.

ORNAMENTAL-FOLIAGED PLANTS.

Magnificent collections are staged by M. Van Houtte, including all the finest of the *Anthuriums*, *Dieffenbachias*, *Marantas*, *Crotons*, &c.; and by M. Dallièrè. The specimens in this collection, notably *Anthuriums*, *Phœnicophorium seychellarum*, *Marantas*, *Croton magnolifolium* with leaves 18 inches long and 9 inches wide, being remarkable by their high culture. For M. Dallièrè's splendid group the 500-franc prize of the Federation of Belgian Horticulturists is awarded. No less than thirteen classes and twelve gold medals were apportioned to *Agaves*, *Yuccas*, &c., and very fine collections, healthy and handsome plants, are staged, *Yuccas oleifolia variegata* and *quadricolor* being remarkable by their sturdiness, health, and clearness of colour.

VAN HOUTTE MEMORIAL PRIZE.

An object of art is offered by the English Committee, founded for honouring the memory of the late M. Van Houtte, the conditions being six stove and greenhouse plants in flower, distinct genera. M. Van Houtte wins both prizes, the other being for *Imantophyllums*. The collections of these impart brilliancy to the Show, many very superior varieties being exhibited. Among the finest we noticed *Marie Van Houtte*, *Madame Bonner*, *Madame L. Van Houtte*, and *Louise Kremer*.

AMARYLLISES AND HYACINTHS.—Several classes and medals were devoted to these. The truth must be spoken about these, and it is this: The former do not approach either in size, form, or brilliancy of colour the newer varieties in the collections of Messrs. Veitch and B. S. Williams. In one collection there are many attractive flowers, the white stripe down the centre of the segments being clear and telling; but regarding the collections as a whole it is clear the English have got the whip-hand of the Belgians in *Amaryllises*. The *Hyacinths* exhibited are not equal to those staged at our spring shows; the spikes, to use a cultivator's term, appear to want "pulling out" more, yet the large banks are very gay.

RHODODENDRONS.—Great provision was made for these—twelve classes and seven gold medals. Many well-bloomed shrubs were exhibited, large and small, and which contributed, as may be expected, materially to the effect of the Exhibition. They are not, as a rule, equal to the masses arranged at the best English shows. One of the most attractive varieties at Ghent is *Minnie*, bluish tinted with lilac, and a very conspicuous amber blotch, truss compact and plant floriferous. The first-prize medal for new varieties was awarded to M. Van Houtte, *Marie Van Houtte* white, and *Lord Napier* purple being very superior.

Kalmia latifolia is admirably grown; the plants have deep green foliage, which, however, is almost hidden by the huge trusses of paper-white flowers.

Roses are fresh but small, the best of them not sufficiently meritorious for securing third prizes at the London shows; but there is a large number of cut blooms of *Maréchal Niel* of very good quality. *Phormiums* are apparently favourite plants here, quite a large number of excellent specimens being grouped in the gardens.

VARIOUS PLANTS.

Tropæolum tricolorum is well grown, Indian club and mophead-shaped plants covered with crimson bugle-like flowers being very effective, and *T. brachyceras*, with yellow diminutive "*Nasturtium*" like flowers a quarter of an inch in diameter, mixed with the above is extremely pretty. Miniature Orange trees abound, grown and fruited in a wonderful manner, many of them not exceeding 18 inches in height, yet bearing twenty fruits. The foliage is also healthy and good. They are grown in 5 and 6-inch pots, and undoubtedly reflect credit on the cultivators. *Spiræa japonica* is well represented, the golden variegated variety having especially fine plumes. These are much more dense and massive, but fewer in number than with the older species. *Cinerarias* are grown most vigorously, the heads of flowers 2 feet across resting on extraordinary foliage, some of the leaves being a foot in diameter. Of *Mignonette* there are remarkably sturdy plants of a most distinct type, so distinct as to be compared with *Spinach* by some English visitors, to whom it appeared to be considered more novel than attractive. Mr. Cannell of Swanley exhibits plants of his new double white *Mignonette*, that is increased by cuttings, the spikes being of great length, and very noticeable by their whiteness. A band of double *Cinerarias*, enclosing cut blooms of *Zonal Pelargoniums* by the same exhibitor found many admirers. Standard-trained specimens of the plant that was a few years ago so popular for edging flower beds, *Gnaphalium lanatum*, are decidedly novel and not unattractive. They are in tubs 15 inches square, the stems of the plants being of the length, thickness, and hardness of a walking stick, and the Mushroom-shaped heads, closely pinched, $4\frac{1}{2}$ feet across. There is also a pair of pyramids $2\frac{1}{2}$ feet in diameter at the base and 6 feet high, faultless in shape and finish. *Aspidistras* are both numerous and splendidly cultivated, the plants being 3 feet across, with large deep green leaves clearly variegated.

This is the favourite plant for corridors, and is very largely employed in continental hotels. Green *Dracænas*, such as *Cordyline indivisa*, are of unsurpassable quality, the plants, large and small, having the same rich deep green hue that is indicative of high cultivation. The same remark applies to *Aralia Sieboldi variegata*, plants in 6-inch pots having a spread of 3 feet, with rich green clearly margined leaves. They are very handsome, and would form a fine feature in the London parks. *Indiarubber* Plants almost startle us by their size, vigour, and small pots in which they are grown. They are 4 or 5 feet high, with stems like broom-handles, and huge, glossy, leathery leaves quite down to the soil. *Deutzia gracilis* is represented by highly meritorious plants in tubs, very dwarf, 2 or 3 feet high, and 3 to 4 feet in diameter, excellently bloomed, and with fresh healthy foliage. *Zonal Pelargoniums* are far below the *Swanley* type, and only the extremely dwarf and wonderfully floriferous varieties, *Leopold II.*, *Archduke Wodolf*, and *Princess Stephanie* exhibited by M. P. Snoek merit notice here. *Golden Tricolors* and *Bicolors* are also comparatively inferior. In the same house is a choice collection of succulent plants in excellent condition, presumably from the establishment of M. De Smet. *Gloxinias* are few and poor, the season being too early; but the *Gesnerias refulgens*, *Blassi*, and *Donckelaari*, with *Tydaea Beelzebub*, are very rich in colour. *Belgian Pansies* have a starved appearance, and hardy plants, including *Polyanthus* and *Auriculas*, are miserable—mere apologies for these plants as they are represented in English gardens. *Caladiums* are wonderfully well grown considering the earliness of the season, and admirers of these handsome-foliaged plants may grow the following:—*Sir Walter Scott*, *Virginale*, *Leopold*, *Robert*, *Felicien David*, *Comtesse de Condoxa*, *Gratiosa*, *Impératrice Eugénie*, and *Jean Linden* as among the best shown at Ghent. *Bromeliaceous* plants are much finer and more numerous than we ever see them in English shows, and the rich colours and chaste markings of these plants render them highly ornamental. Arranged about the grounds are many magnificent *Bays* in tubs, representing patient care and admirable culture. Columns and pyramids 15 to 20 feet high, grown in tubs 3 feet in diameter, are marvels of training and healthy vigour. Standards on stems from 6 to 10 feet, with heads of almost the same diameter, are similarly excellent. The gold medal is won by M. De Smet.

CUT FLOWERS.

Floral "crowns" are remarkable. These are oval-shaped wreaths for funerals, the shortest diameter being 3 feet, length $4\frac{1}{2}$ or more, yellow *Roses*, *Orchids*, *Violets*, *Lilies*, and *Roses* being arranged on a ground of *Ferns*, and *Periwinkle* leaves to form the frame 7 or 8 inches in diameter, with a pair of leaves of *Cycas revoluta* fringing the interior, their stems at the base being hidden with *Orchids*. One of the wreaths is composed wholly of small white *Camellias*, two or three hundred blooms being employed, and *Vinca* sprays. Another is of *Violets* and white *Lilac* spirally arranged, this undoubtedly being very striking. Among the smaller wreaths, such as are made in England, a mixture of yellow *Roses*, black *Pansies*, and *Lily of the Valley*, with sprays of *Box*, has a remarkable effect. Baskets of flowers are large, free, and beautiful, white *Lilacs* and *Roses* being the favourite flowers, lightly arranged with *Ferns*. Bouquets are not better than those seen in our provincial shows, if as good; but an arrangement of unopened *Orange* blossom, each bud mounted on wire, is novel. Centrepieces furnished with *Orchid* flowers, standing on mirrors margined with *Lilies*, appear to be representative examples of table decoration, and in their way are excellent; but a gigantic basket of white *Lilac* with a few coloured sprays, shows to advantage by the side of the richer flowers and their elaborate setting. Some English wreaths and bouquets are exhibited by Mr. Brown, Richmond, but his flowers, being seriously injured in transit, he could not arrange them to anything like advantage; he had prizes, however, we believe, in all the classes in which he competed—one gold and two silver-gilt medals. Mr. Brown will in all probability exhibit bouquets again in Belgium on some future occasion, but we think he will not compete in the classes for floral wreaths.

Many horticultural structures are on view, and garden requisites of every kind. The continental houses are, as a rule, lighter than those made in England, in fact too light, hence it was that the structures of Messrs. Foster & Pearson secured the gold medals for their admirable samples of greenhouses and frames. The boilers on view were excellently made, the rivetting and finish being superior to the majority of English workmanship; but the waterway of almost all of them is too restricted, and there is a probable contingency of the apparatus "clogging" prematurely in the case of hard water and hard firing.

We have not detailed half of the Exhibition, but have said sufficient to show its magnitude and excellence. Once again we record our acknowledgements of Belgian courtesy and hospitality, and express an earnest hope that a brilliant future is in store for Belgian horticulture.

The chief banquet was very complete and splendid, 220 persons attending. An idea may be formed of its character by the fact that each person was apportioned ten wineglasses, or a total of 2200. The opera adjoining the banquet hall was afterwards attended, and the evening will not soon be forgotten by the invited guests.

Gold medals were awarded to Messrs. Veitch for *Rhododendrons*, Williams for a grand bank of *Cyclamens*, and Cannell for the groups

above referred to, Foster & Pearson for garden structures. In addition to the objects of art (memorials of the late M. Van Houtte) won by M. Louis Van Houtte, he also secures M. Raust de Berchem's prize in memory of the Comte de Gomer for variegated plants. The King's medal is won by M. Van Geert, and the Queen's by Madame Boddaert Van Cutsen for Orchids.

The Exhibition remains open until Sunday evening next. There is thus time for the majority of our readers to inspect it; and as the weather is at present bright and the sea calm, those who may be able to run over will greatly enjoy the trip. The two nurseries, MM. Linden's and Van Houtte's, are alone worthy of a journey to Belgium.

REMOVING VINE TENDRILS.

I WAS struck with your reply recently to a correspondent on the above, and hoped to see some further remarks on the subject in a subsequent issue. If, as stated in the instance quoted, the young Vines were so much stronger and luxuriant where the tendrils had not been removed, would it not be worth trying on established Vines? In all my experience I have been taught to remove these tendrils as a matter of course, and never remember having seen plants otherwise treated; but I intend to satisfy myself by allowing one to produce its "horns" *ad libitum* and note the results in comparison with its companions. If it should hold good with Vines, why not for Melons and Cucumbers?—C. H.

VENTILATION.

I WAS much afraid that my few remarks on this subject had failed in their object, which was simply to elicit some definite opinion from competent men. Certainly Mr. Warhurst and "C. P. P." commented on what I had written, partly favourably and partly otherwise, but when I saw a rather long article from Mr. Iggulden I thought we might find something conclusive. I wish to thank him for the lenient manner in which he has treated a heretic like myself, but there are a few points upon which I should like to set him right.

In the first place he appears under the impression that I am buying my experience in ventilation by killing Phalænopsids, but I had nothing to do with either buying or killing those plants. But to come to the Cucumber question. On that point he assumes that, however the non-ventilating system may answer in summer, it will not do in winter. In a conversation with a very experienced and successful grower I mentioned this; and although he was inclined to smile at the idea of ventilating Cucumbers in summer, doing so in winter he regarded as quite unreasonable. This grower usually sows his main crop of Cucumbers about the end of September, and during the ensuing dull months is very careful not to unduly force them, but to secure plenty of healthy and sturdy foliage. He usually commences cutting about Christmas or a few days after, and the same plants continue to produce heavy crops of fine fruit until the following autumn, when they are cleared out; afterwards the houses are thoroughly cleaned and started again, but never from sowing to clearing out is any air given.

The above is perhaps a fair sample of the procedure of the principal growers, but there are many who have merely flue-heated houses who do not start until the turn of the year.

Could Mr. Iggulden under his ventilating system grow Cucumbers, and a large proportion of them fit for the exhibition table, at 2s. 6d. or 3s. per dozen, and reap a handsome profit? Again, although Mr. Iggulden does not consider himself a scientific man, he wishes to make his meaning clear, but to my mind he has not quite done so, for his article is headed "Why We Ventilate," but after carefully reading the same I cannot find in it any reason why he does so. He also makes some observations about novices and experts which I cannot quite understand; but I think that if he or any other extreme ventilation theorist would for a season grow Cucumbers side by side with some of our Prescott watch-makers or St. Helen's copper or glass-workers, he would at the end of the trial find the novice represented by a person he would little expect to find in that position.

I may add that my side of the question is no new-fangled theory, but for at least a quarter of a century has been proved beyond dispute in this neighbourhood to be the best and cheapest way of producing heavy crops of first-class Cucumbers at the least expenditure in the erection of the houses, and afterwards of fuel and labour, combined with the greatest immunity from insect plagues and I think if Mr. Iggulden could visit this locality and take a walk with me through a mile or two of Cucumber houses, in a few hours he would find his opinions on the ne-

cessity of ventilating Cucumbers considerably modified.—J. J., Lancashire.

ROSES—EARLY AND LATE PRUNING.

THERE can be no question about it, at least to myself. "An Old Hand" says, "I quite fail to see the force of the observations on page 278 that it may be well to prune early in the south, &c." There is truly no doubt that "An Old Hand" does fail "to see the force of my observations" if he construe them, as he seems to do, in the light of making me an advocate for early pruning. When I remarked "It may do well, as 'A. C.' says, to prune early at Reigate," it seems to my dull intellect that the possibility of its being the best time, even at Reigate, was exceedingly doubtful, whilst the whole tenor of the observations was in favour of late pruning. I am sorry to have been misunderstood, and can only hope that "An Old Hand" is singular in the deductions drawn from my few lines. Personally I would drive off pruning as late as I possibly could.—Y. B. A. Z.

TURF "POTS."

As the time of the year has arrived for potting small seedlings and cuttings, such as Lobelias, Pyrethrums, Ageratums, Petunias, and Verbenas, a few remarks of our mode of potting the above may be of service, especially where space is limited. We find

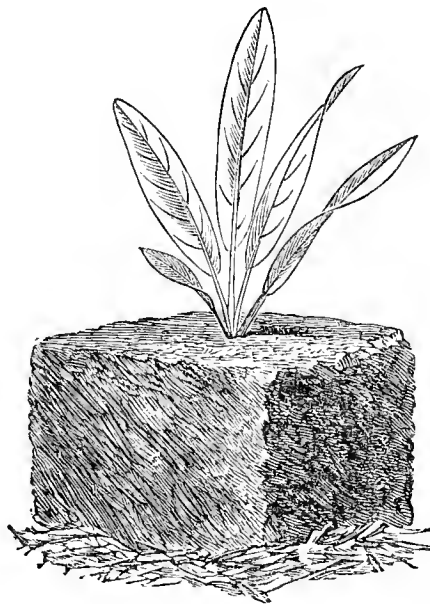

Fig. 76.—Turf pot.

turf pots answer well, instead of thumb pots, placed on a gentle hotbed in a frame with about 3 inches of soil to plunge the turves in. Pack them as closely together as possible, and shake a little sifted garden soil lightly over to fill the crevices, which prevents the turf becoming too dry. Almost any old turf may be used cut close to a hedge where it is not noticeable. We cut our turf in blocks about 3 inches thick, and those are cut in small squares the size required for the different kinds of plants, 2 inches square for Lobelias, Pyrethrums, and 3 inches for Petunias, and Verbenas. We scoop out the centre of the square, having some fine soil ready for pressing around the seedlings. They root very quickly in the turf, and are bedded out without any check.—T. H.

[We have prepared many thousands of plants for the flower garden in the manner described, and always found them in every respect more satisfactory than plants grown in pots.]

INSECTS ANNIHILATED.

I TRIED the mixture of soda, soft soap, and petroleum as advised by "A Gardener," at page 149, but although the water used was soft and the directions were followed minutely, there was a scum on the surface. The mixture killed some of the insects to which it was applied, but the scum had the effect of slightly burning the foliage. I then tried to draw the liquor off by means of a tap at the bottom of the tub, leaving the scum behind. This was better, and I found I could use it on most plants at double strength without the slightest injury to foliage. Eucharis, with some old thrips on which had baffled all smoking, Gardenias in small pots, with a suspicion of red spider, and cuttings of all sorts were dipped with such perfect results that I have now made up my mind to give up growing insects altogether.

The mixture is now made as follows:—A nine-gallon cask with the head out is placed on end, with a tap inserted near the bottom. A pound of good soft soap is put into it, and four gallons of soft water boiling. This is stirred with a stick till the soap is dissolved, then one pint of petroleum is poured in slowly while the water is kept violently stirred with a stick. Then four gallons more soft water is added. I think it is immaterial whether this last lot of water is hot or cold, but it must be soft. In five minutes after stirring the scum has risen to the top and the mixture may be drawn off through the tap, leaving, however, a little more than sufficient to cover the tap at the bottom. This must be treated as waste, and on no account must any of it be used on the plants.—
WM. TAYLOR.



WE deeply regret to announce the death of MAJOR-GENERAL H. Y. D. SCOTT, C.B., F.R.S., late of the Royal Engineers, which took place on Monday morning at his residence, Silverdale, Sydenham, aged sixty-one. He retired from the army in 1871, and became Director of Buildings at South Kensington, acting as architect to the Royal Albert Hall and Science Schools. He was Secretary to the Royal Commissioners of the 1851 Exhibition. At his death he had just finished superintending the construction of the Great International Fisheries Exhibition. He was elected a member of the Council of the Royal Horticultural Society on 13th June, 1865, in place of the late Sir Joseph Paxton. He became Secretary in 1866, and resigned with his colleagues in 1873 when the Council resigned in a body. The deceased gentleman has been a frequent contributor to our pages, and has recently written under the *nom de plume* of "Inquirer."

— "D., Deal," sends the following list of the ROSE SHOW FIXTURES at present arranged:—June 27, Cardiff; 27, Croydon; 28, National Rose Society, Southampton; 29, Canterbury; 30, Reigate; July 3, National Rose Society, South Kensington; 4, Maidstone (?); 5, Farningham; 5, Bath; 6, Sutton; 6, Tunbridge Wells; 7, Eltham; 7, Birchham; 7, Crystal Palace; 10, Wirral; 10, Oxford; 12, National Rose Society, Sheffield; 17, Leek; 18, Darlington.

— A CORRESPONDENT writes that "the long continuance of cold east winds following the snow that fell last month has seriously affected the crops of EARLY POTATOES IN THE CHANNEL ISLANDS. Large areas have been injured, and the growth of the tubers greatly retarded thereby. It is expected that the Potato harvest will be at least a month later than usual."

— THE BATH FLORAL FETE COMMITTEE will hold a spring Show on Wednesday, May 9th; a Rose Show on Thursday, July 5th; an autumn Show, Wednesday and Thursday, September 5th and 6th; and a Chrysanthemum Show on Wednesday and Thursday, November 14th and 15th. Numerous prizes will be offered, including three silver cups and a gold medal at the Rose Show.

— WE regret to announce the death of MR. JOSEPH C. SPYERS, which took place at Torquay on the 10th inst. Mr. Spyers was well known as Sir Trevor Lawrence's Orchid-grower, and the fine condition of the Orchids in the Burford Lodge collection has long testified to his skill as a cultivator of these plants. It appears that on his return from the Edinburgh International Exhibition last autumn he had an attack of bronchitis, which terminated in consumption, that the most careful nursing and best advice failed to arrest.

— MR. A. C. ROFFEY, Secretary of the CROYDON HORTICULTURAL SOCIETY, requests us to state that their next summer

Show, to be held on June 27th, will be the sixteenth held by the Society; and the autumn Show, which takes place on November 14th and 15th, will be the seventh.

— "It is stated," says the *British Mercantile Gazette*, "that there are no less than 40,000 square miles of almost unbroken FORESTS IN NORTH CAROLINA—Pine, Chestnut, Oak, Maple, Beech, and Hickory timber in their finest growth. Within the next ten years it is estimated that the timber alone in North Carolina will exceed in value the present total valuation of all the property in the State, including land. The State grows nineteen varieties of Oak, and its Pine forests are of the heaviest. New railroads are now in course of construction, and this will open up the whole region to the northern and eastern lumber markets."

— WE understand that the WIRRAL ROSE SOCIETY will this year hold its principal Show in St. George's Hall, Liverpool, on Tuesday the 10th July, and that Canon Holc and the Rev. H. H. D'Ombraim will again judge the nurserymen's classes. The Duke of Westminster has honoured this Society by becoming its President. The move from Birkenhead Park to St. George's Hall is a very good feature in this year's programme, as the Hall is a magnificent one for the purpose, within a hundred yards of the railway station, and most convenient for distant exhibitors.

— THE following sensational description of "AN ANGRY TREE" recently appeared in the *Times*:—"A singular species of Acacia is growing at Virginia, Nevada, which shows all the characteristics of a Sensitive Plant. It is about 8 feet high, and growing rapidly. When the sun sets its leaves fold together, and the ends of the twigs coil up like a pig-tail, and if the latter are handled there is evident uneasiness throughout the plant. Its highest state of agitation was reached when the tree was removed from the pot in which it was matured into a larger one. To use the gardener's expression, it went very mad. It had scarcely been placed in its new quarters before the leaves began to stand up in all directions like the hair on the tail of an angry cat, and soon the whole plant was in a quiver. At the same time it gave out a most sickening and pungent odour resembling that of rattlesnakes when teased. The smell so filled the house that it was necessary to open the doors and windows, and it was a full hour before the plant calmed down and folded its leaves in peace."

— THE Secretary of the Science and Art Department, London, writes:—"With reference to the communication addressed to you on the 3rd February last on the subject of a forthcoming INTERNATIONAL HORTICULTURAL EXHIBITION AND BOTANICAL CONGRESS to be held at St. Petersburg, I am directed to acquaint you that the Lords of the Committee of Council on Education have now received a communication from the Foreign Office, stating that in consequence of the Czar's coronation the proposed Exhibition and Congress are postponed until the 5th May, 1884."

— MR. IGGULDEN in advocating MIXED PACKETS OF PRIMULA SEED writes:—"Chinese Primulas have been wonderfully improved of late years. I cannot, however, overlook the fact of the varieties being distributed in a manner so as to debar the majority of would-be admirers growing but a modicum of them. Instead of distributing in single packets only at almost prohibitive prices, why not give those who must not expend large sums with the seedsmen, an opportunity of purchasing those undoubtedly superior novelties in mixed packets? For 5s. we ought to procure sufficient Primula seeds to produce plants enough for the requirements of all moderate-sized establishments, and in variety equal to Calceolarias and Cinerarias. The Messrs. Sutton & Sons of Reading evidently recognise the propriety of meeting our wishes in this respect, as they now offer packets of mixed varieties at a moderate price. The first season I tried one of their packets of 'special hybrid Primulas' I was not so

favourably impressed with the variety included, there being too many, in fact, of one or two vigorous but inferior sorts. This season, however, the plants resulting from a 5s. packet have been most satisfactory. We had fully eighteen varieties, including the richly coloured Ruby King, Suttons' Pearl, Rosy Queen, Reading Pink, good Fern-leaved varieties, and several of the new spotted sorts. The majority were of compact sturdy leaf-growth, and though on the whole the display might not have been so gorgeous as when two or three varieties are grown in quantity, we prefer to sustain the interest in the batch by being able to point out the beautiful features of each variety."

— AT a recent meeting of the Committee appointed by the Minister of Agriculture to report upon the condition of the PHYLLOXERA AND THE FRENCH VINEYARDS, M. Tisseraud, the Director of Agriculture, gave some very interesting information as to the ravages of the phylloxera up to the present time. It would appear that nearly two million acres of Vines have been destroyed, and that 1,500,000 acres more have been attacked, and are more or less affected in their yield. About fifty thousand acres have within the last year or two been replanted and the young Vines dosed with sulphate of carbon, while thirty thousand acres newly planted have been protected by submersion; forty thousand acres more have been planted with American Vines. But though there has within the last year or so been a slight increase in the area of newly planted vineyards, the total is very trifling compared to what has been destroyed. M. Tisseraud mentions, however, as an encouraging circumstance, that Vine-growers are forming many associations for the purpose of conducting experiments as to the best mode of combating the phylloxera; that these associations now have 12,338 members, and that they received last year subsidies amounting to £43,000 from the Government. The Committee has decided that no remedy has yet been discovered entitling the inventor to a premium of £12,000 offered by the Government some years ago, but recommends the use of sulpho-carbonates and the submersion of the Vines as palliatives of the disease. The cultivation of the American Vine is authorised in twenty-three arrondissements, and it was mentioned incidentally in the course of the meeting that seventeen fresh districts were invaded last year. The Committee has prepared a Bill which will be introduced into the Chambers this session for guarding against the invasion of the Algerian Vines by the dreaded insect.

— A CORRESPONDENT of an American contemporary gives the following list of FLOWERING PLANTS FOR SHADY PLACES:— "Among the choice native plants delighting in a cool shady spot, moist if possible, is the genus *Cypripedium*, and the most showy species are *C. spectabile*, with large, showy, rose-coloured flowers; *C. pubescens*, the larger yellow Lady's Slipper; *C. parviflorum*, smaller yellow Lady's Slipper; and *C. acaule*, stemless, with pale rosy bloom. The Rattlesnake Plantain (*Goodyera pubescens*), frequenting cool northern slopes, is well adapted for cultivation in shady spots. The showy Orchis, *O. spectabilis*, transplants readily, and is very conspicuous when in bloom. Several of the genus *Platanthera* are also valuable, requiring but little attention. All the above must have a nicely prepared bed of peat to grow in, else their fleshy roots will decay after the first season. Ferns are always in order in just such a locality, and harmonise well with other plants, especially if placed on a little mass of rocks. Clumps of the early white Anemone, *A. nemorosa*, transplant easily, and are very satisfactory in a cultivated state. The same might be said of all the Violets—the Bloodroot (*Sanguinaria canadensis*), Dwarf Dogwood (*Cornus canadensis*), Trailing Arbutus (*Epigaea repens*), although difficult to transplant, but especially desirable when it thrives properly; Liver-leaf (*Hepatica triloba*), the delicate little vine called Twin-flower (*Linnaea*

borealis), another small trailing plant known as the Partridge Berry (*Mitchella repens*), all the species of *Trillium* and Dog's-tooth Violet (*Erythronium americanum*). All the foregoing are natives, and are usually quite plentiful and widely distributed. The Lily of the Valley loves a shady nook, and the evergreen trailing vine, Periwinkle, is partial to the same spot. Double English Daisies and Primroses are the better for a partial shade, and a clump of Fuchsias will grow and bloom freely with little sun."

LONDON NURSERIES IN APRIL.

ALTHOUGH the leading London nurserymen, Messrs. Veitch, Mr. Bull, and Mr. Williams, have made no attempt to secure any of the medals at the International Show at Ghent, few will suppose that they were not prepared to take a distinguished part in that great gathering of what is rare, choice, and excellent in the floral kingdom. On the contrary, those who have been accustomed to pay periodical visits to these three great establishments, will be ready to admit that their contents are richer and more numerous than they have ever been before. The proprietors of these famous nurseries are simply resting on their oars, as they can afford to do, leaving the course at Ghent clear to others who deserve all the honours they have won in the contest of the present week. As a great continental establishment, the *Compagnie Continentale d'Horticulture* (M. Linden's), also refrain from competing, but arranges a show of its own, which will doubtless be noticed, so, also, a brief record—a passing glance—of our home nurseries in April will not be inappropriate, nor certainly unacceptable to our readers on the eastern shores of the North Sea.

MESSRS. VEITCH'S NURSERY.

We are apt to forget, in the absorbing topics of the day, what has been done by British horticulturists at past international exhibitions. Memory takes us back to Ghent in 1868, and recalls the valuable collection of plants staged by Messrs. Veitch there, and amongst them the then new and still prized *Clematis* John Gould Veitch and *Pandanus Veitchii*. Coming to the Quinquennial of 1873, we remember the great contests for twenty newly introduced plants, in which this firm secured first honours, the as popular as ever *Aralia Veitchii* commanding great attention. Also at this Show they secured both first and second prizes in the class for the best new plant in bloom with *Tillandsia Zahni* and *Masdevallia Harryana*; and still again they excelled all competitors in the class for the best seedling plant obtained in Europe with *Cypripedium Dominionum*; and yet again *Dracæna amabilis* won for them the first honours in the class for new plants not in bloom, and which we said at the time would prove one of the most useful decorative plants, and it has; in fact, for general "wear" and usefulness it is scarcely surpassed by any of the grand new varieties of recent years. In the great Centennial Exhibition at Brussels in 1876, although in accordance with the custom then established, Messrs. Veitch did not enter the competitive lists, the groups of plants staged were of such striking merit that the great gold medal, offered by the Comte de Flandres for the foreigner who contributed most to the effect of the Exhibition, was awarded to the firm. Then at the last Quinquennial in 1878 two honorary groups were sent from this nursery—namely, new and rare plants of great richness, and the grandest collection of Hyacinths ever seen in Belgium, and for each group gold medals of the first class were unanimously awarded.

These are only a few of the Belgian honours that occur to us that Messrs. Veitch have won, and without doubt there is material in the nursery now that would have enabled them to surpass all former efforts—namely, the magnificent *Amaryllises*, a brilliant remnant of the grandest show of these flowers that the world has ever seen; *Nepenthes* in thousands, quite a bewildering mass of splendid pitchers, which certainly has no equal in Europe; and such a wealth of Orchids as is seldom seen even in this famous establishment; *Dendrobiums*, a few striking examples left of the late remarkable display; gorgeous *Cattleyas*; *Odontoglossums*, thousands of spikes, embracing all the finest forms in this fine genus; *Cypripediums*, *Phalænopses*, *Lycastes*; a magnificent specimen, probably the finest ever seen, of the beautiful *Cymbidium eburneum*; *Angræcums*, and many others that cannot even be enumerated; then the glowing masses of *Anthuriums*, with fine-foliaged plants and Ferns in the finest condition; and *Camelias*, which are not surpassed at the Ghent Show, are a few of the prominent features of the nursery at the present time. Of plants not in bloom that cannot be overlooked is a wonderful importation of specimens of *Cattleyas Trianae* and *Mendelli*, the

finest plants and in the best condition of any that have yet arrived in this country. This firm, which taking it in all its branches is the largest in the world, is, if possible, stronger than ever, and the head quarters have never been seen in better condition than during the present month.

MR. BULL'S NURSERY.

The energetic proprietor of this establishment, which has attained such a high position in the horticultural world, also refrains from competing at Ghent. He is a donor of prizes there,

and not only so, but in the aggregate the most valuable of all that were offered for competition at the Show in question. But he has won his spurs at previous gatherings. If we remember rightly Mr. Bull first competed in Belgium in 1876, at the Brussels Centennial: and it is to be hoped he was satisfied, for he received the large gold medal for the scientific and general merit of his collections; large gold medals for six, also for three new plants; and four large silver-gilt medals, also a silver in other classes—not a bad beginning. Then at the Ghent Quinquennial in 1878 he exhibited in ten classes, winning five gold, four silver-gilt, and



Fig. 77.—ODONTOGLOSSUM GLORIOSUM VAR. PICTUM.

one silver medal—not a bad ending. Mr. Bull thus also has earned repose. His new nursery is now almost startling by its contents, especially Orchids in superb condition. House after house is crowded with them, and the display of flowers is as charming as it is extensive. Many fine varieties of *Odontoglossum Alexandræ* arrest notice, one of a distinct violet hue being particularly commanding. *O. Ruckerianum* is very distinct and beautiful, and a grand variety of *O. gloriosum* is of extraordinary merit, as may be seen by the woodcut (fig. 77). A batch of the pure white *Cœlogyne cristata alba*, a glowing mass of *Ada aurantiaca*, and rich *Masdevallias* contribute effectively to the general display. *Cypripedium Warneri* is as free as it is beau-

tiful, small plants in 4-inch pots bearing several handsome flowers. *Sarracenias*, too, cannot be overlooked. But amidst all the flowers visitors pause to admire the wonderful vigour of a houseful of *Odontoglossum vexillarium*, which are growing as freely as German Irises—quite a unique and unequalled collection of this fine Orchid. A very large and lofty three-quarter-span new house contains an unusually fine display of *Vandas*, and these with *Cattleyas*, *Sobralias*, and numerous others are so healthy that it is impossible not to recognise the value of 3-inch hot-water pipes taken along the sills close to the glass, in addition to those below, thus securing an equable temperature that renders the house extremely pleasant. The roof-heating was particularly advan-

taguous during the frost winds that lately were so violent and protracted. New and rare plants continue to form a feature here, and more will be heard of them in due time. At present it can only be said that Mr. Bull's establishment was never so well furnished as it is now; but home rather than public exhibitions appear to be getting fashionable, and the different collections of plants are eminently worthy of inspection.

MR. WILLIAMS' NURSERY.

If other exhibitors have earned a period of repose surely the proprietor of the renowned Holloway Nurseries has done so, for long, perseveringly, and successfully has he engaged with honour in this exhausting work. At Ghent in 1873 we remember his plants, *Todea superba* especially securing unbounded admiration, while his *Cyclamens* caused a sensation; but it was at Brussels in 1876 that he achieved his greatest triumphs. Here are the records: The large gold medal offered by the King for contributing most to the splendour of the Exhibition, the great gold medal of 1000 francs for Orchids, gold medal of 500 francs for miscellaneous plants, with two gold medals for Ferns, and two for new plants, also one for *Odontoglossums*, also four or five silver-gilt medals for other exhibits. Then at Ghent in 1878 he had a magnificent group, which worthily secured him the great gold medal there. It is not well to forget these triumphs, and the veteran has done his share in the contests of past years, and contributed powerfully to the success of many exhibitions.

During the past and present months the great attractions at the Holloway Nurseries have been the Orchids, the extensive collection of which always yields something of interest to the visitor. The *Amaryllises*, to which so much attention has been paid by Mr. Williams in recent years, and with such marked success, and the bulbs, the last including *Hyacinths*, *Tulips*, and *Lilies* of the Valley, that assisted in forming the handsome groups at the Royal Botanic Society's recent Show and the spring meetings of the Royal Horticultural Society at Kensington. To enumerate all that is good amongst these would far exceed our present purpose, but a few may be briefly noted. First of the Orchids. The cool houses containing the *Odontoglossums*, *Masdevallias*, and similar plants have been particularly gay, the collection being very large and including many superb varieties of the leading species. *Odontoglossum Alexandræ*, *O. Pescatorei*, *O. Rossi majus*, and scores of others are represented by admirable forms, while the *Masdevallias* include fine examples of *M. Lindeni*, *M. Harryana*, *M. Veitchiana*, *M. ignea*, the useful *M. tovarensis*, and the similarly useful and freely flowering *M. Shuttleworthi*, which is fast becoming such a favourite with Orchid-growers. Several choice *Dendrobes* have been also flowering in the warmer houses, together with *Cypripediums* and miscellaneous Orchids, amongst which that shown in fig. 78 (page 325), *Trichopilia lepida*, was very noteworthy; it is a rare species with large flowers, the lip of a soft rosy hue margined with white.

The *Amaryllises* comprise some superb varieties, much care having been exercised to improve the colours, with the result that scarlet and crimson tints of unsurpassed richness have been obtained. The flowers, too, are very neat in form, the outline even, the substance good, and they are freely produced, many heads having five or six blooms each. The bulbs indicated their quality and the culture they had received by the massiveness of their spikes and the clean appearance of the flowers, the colours fresh and clean. In so brief a glance as this we cannot do more than note that the superb collection of Ferns and miscellaneous stove and greenhouse flowering and fine-foliage plants are in most satisfactory health, the new *Rhododendron* house being a valuable addition to the numerous structures already so well occupied.

BIRMINGHAM SPRING SHOW.

APRIL 11TH AND 12TH.

THE third annual Exhibition of this Society took place in the Town Hall, and was in every way equal if not superior to former years. The centre stage was well filled with Orchids, Azaleas, Roses, Genistas, Clematises, and many other flowering plants, relieved with Palms, Ferns, Dracenas, and other ornamental-foliaged plants. The stages on either side of the hall contained fine examples of *Spiræas*, *Deutzias*, *Rhododendrons*, *Cinerarias*, with collections of *Tulips*, *Hyacinths*, *Narcissi*, *Auriculas*, *Polyanthus*, &c.

Among the local prizetakers were Messrs. C. Winn, L. Hayman, C. E. Mathews, Walter Showell, the Right Hon. Jas. Chamberlain, and W. H. Hill. Mr. L. Hayman was first with well-grown *Hyacinths*, Messrs. Hayman and Crook respectively for *Tulips*. For six Azaleas Mr. Hill was first with good plants. Orchids were represented by some very choice and rare kinds from the Right Hon. J. Chamberlain, M.P., Mr. Winn, and Mr. Elliot. For six specimens Mr. Winn took honours, including fine examples of *Dendrobium*

Wardianum, *D. thyrseiflorum*, *Odontoglossum Pescatorei*, and *O. vexillarium*. Following these very closely were Mr. Chamberlain's, including well-flowered plants of *Dendrobium nobile*, *Cattleya Skinneri*, *C. Mendelli* very fine in colouring, and *Masdevallia Lindeni*. Mr. Chamberlain also exhibited a splendid group occupying the end of the stage in front of the orchestra, not for competition, containing some very rare and beautiful specimens, the majority being especially noteworthy for superior colouring. Over seventy plants were employed in this group, of which the following deserve especial mention:—*Odontoglossum Ruckermanum* in two varieties. *O. polyxanthum*, *O. Andersonianum*, *Dendrobium crassinode* var. *Barberianum*, *D. Cambridgeanum*, *Masdevallia cæstrade*, *M. Shuttleworthi*, *M. Veitchiana*, *Cypripedium niveum* and *C. calceolus*. For stove and greenhouse plants Mr. Chamberlain was first, his collection including a very fine *Rhynchospermum jasminoides*. *Auriculas* and *Polyanthuses* were far below the standard, which is much to be regretted, as they ought to be a feature of such a show.

The local nurserymen were well represented. Mr. R. H. Vertegans of the Chad Valley Nurseries contributed some pretty baskets of Himalayan Cowslips. Besides the type *P. denticulata* were the vars. *P. d. cashmeriana* and *P. d. pulcherrima*. *P. rosea* was also contributed in very good flowering condition. Mr. Vertegans also sent two new Azaleas of the *A. mollis* type, named *Ido* and *Dante*, and a collection of *Hyacinths* and *Tulips*, also his new double *Cinerarias* *Vortigern* and *Terra Cotta*. Mr. Hans Niemand occupied a corner of the hall with a very choice and effectively arranged group of stove, greenhouse, and other plants, which were greatly admired. He also exhibited the new *Balsam Impatiens Sultani* in very good character. One very important point in connection with this *Balsam* is that it strikes easily from cuttings. Messrs. Pope & Sons showed *Auriculas*, *Polyanthuses*, and *Pelargoniums*. Mr. T. Hewitt of Solihull occupied another corner with a very effective group consisting of ornamental-flowering plants. Messrs. R. Smith & Co. of Worcester sent a collection of double and single *Clematises* and *Rhododendrons* relieved with the delicate-foliaged Japanese Maples. The latter were very fine and formed one of the features of the Show.

The general arrangements were well conducted by the Committee, and they may be congratulated on the success of their labours.

POTATOES FOR TABLE AND MARKET.

(Continued from page 303.)

In the following notes the figures 1, 2, and 3 indicate first early, second early, and late varieties; the months the time of planting; and the asterisks those varieties that are considered the best for market purposes by the respective cultivators.

SCOTLAND.

MORAYSHIRE.—1. The time of planting will vary according to the state of the ground, but as soon in March as possible. *Veitch's Improved Ashleaf*, *Lee's Hammersmith Kidney*, *Myatt's Prolific Ashleaf*, and *Beauty of Hebron*. Soil.—The soil best adapted for the cultivation of first-class Potatoes is light loamy soil, and that which has been in pasture for some years generally producing the best crops. 2. *Fortyfold*, *Grampian*, *White Don*, and *Striped Don*. 3. **Magnum Bonum*, *Schoolmaster*, **Scotch Champion*, and **Paterson's Victoria*. Manures and Application.—The manure most suitable for the production of good Potatoes is well-decayed stable manure, and it ought to be thoroughly incorporated with the soil before planting. Artificial manures are so common now that it is difficult to choose the best, but I prefer *Amie's*, and it ought to be applied at the time of planting. General Culture.—The distance between the rows is from 2 feet 3 inches to 2 feet 9 inches according to the variety, and from 9 inches to 1 foot between the sets, which are placed 6 inches deep. After planting all the attention they require is to have the hoe run through them as they require it, and to have the soil well loosened before earthing-up. The lifting of the crop commences as soon as the haulm shows signs of ripening, and as dry a time as possible is chosen for the job. They are stored in narrow pits and kept well covered until required for use.—JOHN WEBSTER, *Gordon Castle Gardens*.

1. Second week in February, weather permitting. *Rivers' Royal Ashleaf*, **Myatt's Prolific Ashleaf*, **Early Rose*, and *Ice Cream* (*Farquhar*). I plant only a very few *Early Rose*; quality only second-rate. Soil.—Medium. 2. Middle to end of March. **Dalmahoy*, **Fortyfold* (*Taylor*), **Fortyfold* (*Clark*), and *Snowflake*. 3. 1st to middle of April. **Grampian*, *Schoolmaster*, **Magnum Bonum*, and *Scotch Champion*. Manures and Application.—Mixture of stable and farmyard dung and old hotbed manure, consisting of equal parts of stable dung and Oak leaves. Sometimes I manure when trenching in the autumn, and sometimes when planting in spring. I have found the crop equally good with both modes of manuring. I have had a splendid crop of *Fortyfolds* with manure fresh from the stable. General Culture.—I generally trench the land in the autumn two spits deep, and if the ground is not manured at that time I level the trenches and point it over in spring, planting and manuring as we go along. I prefer this to dibbling, as sometimes the seed does not reach the bottom of the hole made by the dibber; and if the soil is at all wet the vacancy below the Potato does not fill. Cut sets I like to dust with quicklime, as that prevents slugs from preying on them.

The after culture is simply earthing up in the usual way, and keeping down weeds.—JOHN CLARK, *Brodie Castle, Forres.*

NAIRNSHIRE.—1. First week in April for all of them. Myatt's Prolific Ashleaf, Veitch's Improved Ashleaf, Taylor's Fortyfold, and Snowflake. Soil.—Light. 2. Schoolmaster, Dalmahoy, and Daintree's Seedling. 3. Magnum Bonum, Paterson's Victoria, and Champion. Manures and Application.—Planted after Cabbages, Peas, &c., which had been well manured the previous year; ground ridged in autumn; a sprinkling of dissolved bones or any other artificial manure when planted. General Culture.—They are earthed-up when planted, kept clear of weeds by hand-weeding, nothing else being wanted until they are lifted.—JAMES MAITLAND, *Cawdor Castle.*

RENFREWSHIRE.—1. First to second week in March. Smith's or Coldstream, Veitch's Improved Ashleaf, and Early Dwarf-top Ashleaf. Soil.—Medium for first and second earlies. 2. Second to third week in March. *Dalmahoy, Rector of Woodstock, and *White Don. 3. Any time in April when ground will suit. *Regents, *Patersons, Victoria, and *Scotch Champion. Soil.—Heavy. Manures and Application.—The early varieties have no manure save a dressing of leaf soil dug in. The second earlies follow the previous Onion crop, with a slight dressing of decayed grass and leaves. The late varieties have a good dressing of sand spread over the ground, then a coating of light manure is dug in. General Culture.—The soil in this neighbourhood is generally heavy, and not very well adapted for growing good-flavoured Potatoes. Second earlies and late varieties succeed best, especially Victoria and Champion, which are the chief sorts grown by farmers here; they keep long, and often bring good prices.—JOHN METHVEN, *Blythswood Gardens.*

ROSS-SHIRE.—1. February and March. Veitch's Improved Ashleaf, Myatt's Prolific Ashleaf, Rivers' Royal Ashleaf, and Oxford Early. Soil.—Light. 2. March. Dalmahoy, Rintoul's Early Don, Walker's Improved Regent, and Fortyfold. Soil.—Medium. 3. March to first week of April. *Regent, *Paterson's Victoria, *Champion, and *Magnum Bonum. Manures and Application.—Farm manure in whole, or in part supplemented by bone dust or dissolved bones applied before planting, either dug or drilled in by the plough. General Culture.—The soil is deeply stirred and well broken up by spade or plough and grubber, and thoroughly cleared of weeds before planting. After the plants push through the ground weeds must be kept down by the hoe, and when from 4 to 6 inches high carefully earth them up in dry weather. Rotation of cropping and a change of seed are both of great consequence to success.—ROBERT MASSIE, *The Gardens, Ardross Castle.*

ROXBURGHSHIRE.—1. March, first week; Potatoes not cut. Old Ashleaf, Myatt's Prolific Ashleaf, Rivers' Royal Ashleaf, and *Red Kidney. Soil.—Light soil, southern or western exposure, so as they do not get the morning sun. 2. The last week in March and first week in April. *Beauty of Hebron, Schoolmaster, Snowflake, and American Breadfruit. Soil.—Medium, clay subsoil. 3. Generally about the first week in May in the field. *Scotch Champion, *Magnum Bonum, and Paterson's Victoria. Soil.—Very heavy soil. Manures and Application.—Well-made cowdung mixed with beaver. General Culture.—I approve of planting all early Potatoes whole, not forced before being planted. The old Ashleaf is my earliest out of eight varieties. Red Kidney is the best-cropping early Potato that I know. The crop is always enormous.—JOHN GALLOWAY, *Minto Gardens, Hawick.*

STIRLINGSHIRE.—1. 1st of March. Old Ashleaf, Myatt's Prolific Ashleaf, Mona's Pride, and Coldstream Early. Soil.—Free light porous soil, gravel bottom. 2. 15th of March. *Schoolmaster, Suttons' Flourball, Fortyfold, and Climax. 3. 1st of April. *Magnum Bonum, *Scotch Champion, *Rock, and *Paterson's Victoria. Manures and Application.—Two-year-old leaf soil is employed, covered to the depth of about 8 inches, and roughly dug-in about November. Forked slightly before planting. The early varieties are planted in drills about 3 inches deep. Late and second earlies dibbed in about 5 inches deep. General Culture.—Magnum Bonum if allowed 3 feet between the rows I consider the heaviest cropper, and with me of first-rate quality from November onwards. Fortyfold cannot be surpassed for quality, but is subject to disease some seasons, and here it gives good crops, the only place I have seen it worth growing. The old Ashleaf is the earliest I know of the kidneys, and Coldstream of the round kinds.—THOMAS BOYD, *Callendar Park Gardens.*

1. February if the weather is fine. *Myatt's Prolific Ashleaf, Old Ashleaf Kidney, and *Taylor's Early Fortyfold. Soil.—Light soil well manured. 2. 15th March to the end if the soil is in good order. *Schoolmaster, *Drummond's Prolific, and *Grampian. Soil.—I consider the medium soil is best for Potatoes such as I have recommended as second earlies. 3. 27th March, and April about first week. *Magnum Bonum, *Paterson's Victoria, and *Reading Hero. Soil.—For late varieties I prefer a heavy soil, giving a little lime. Manures and Application.—I consider stable manure the best for Potatoes on strong soil with a little lime. I have been successful at shows with other

varieties, which I could not recommend to give a supply for home use or market; they only look well on the exhibition table. Those I have recommended suit my soil and climate best. My soil is cold, and I ridge it in September and apply stable manure.—WILLIAM MURRAY, *Park Hall, Polmont.*

SUTHERLANDSHIRE.—1. Beginning of March. Veitch's Improved Ashleaf, Myatt's Prolific Ashleaf, Mona's Pride, and Rivers' Royal Ashleaf. Soil.—Light. 2. Middle of March. *Fortyfold, Schoolmaster, and *Rintoul's White Don. Soil.—Medium. 3. Beginning of April. *Rock, *Regent, and *Paterson's Victoria. Manures and Application.—In old gardens where there is usually much undigested manure in the soil I consider it best to plant the Potatoes without anything in the way of farmyard manure if the piece of ground has been fairly well manured the year previous. Should manure be required we usually give a dressing of half-decayed leaves, a dusting of bone dust, or a dressing of lime, as we think necessary. General Culture.—Potatoes are valued here according to their eating qualities, and we find none give more satisfaction than the old standard sorts. We have tried a good many of the new sorts, but have discarded nine-tenths of them. We usually find, that although they look well for exhibition purposes, they are not liked when cooked and sent to table. Too much attention has of late years been given to the production of new Potatoes suitable for exhibition purposes only. If Potato raisers would make table qualities the primary consideration, and appearance a secondary matter, it would be a great advantage to the public, and growers would have less hesitation in investing in the purchase of new kinds at fancy prices.—D. MELVILLE, *Dunrobin Castle Gardens.*

WIGTONSHIRE.—1. February 24th. Myatt's Prolific Ashleaf, *Mona's Pride, and Veitch's Improved Ashleaf. Soil.—Light, high, and dry. 2. March, first week. *Covent Garden Perfection, Gloucester Kidney, and *Schoolmaster. Soil.—Medium. 3. 1st of April and onwards. *Magnum Bonum, *Scotch Champion, and Skerry Blue. Soil.—Medium. Manures and Application.—The only manure used is from the stable. For late Potatoes a good dressing is given, and the ground ridged up early in autumn, keeping the manure under the ridge as much as possible, with the view that the plants may not reach it until they have made some progress. For early and mid-season varieties manure is applied to the previous crop. General Culture.—I always plant on the drill or furrow system, and lay the sets along, breaking the soil well over them, always keeping the soil well hoed, and Potatoes are earthed up twice in the season. The early sorts I keep covered with soil as long as possible on account of frost, which generally visits us late. This is a large Potato-growing district, Magnum Bonum being the favourite variety for market, the Champion often being hollow in the centre.—JAMES DAY, *Galloway House, Garliestown.*

ORCHIDS IN FLOWER AT BRENTHAM PARK.

A DESCRIPTION of the Orchids at Brentham Park appeared in the Journal some time ago. It is considered the finest collection in Scotland. The following were flowering in March:—*Ada aurantiaca*, several specimens; *Angræcum citratum*, *Ellisii* showing fine spike, *sesquipedale*; *Cattleya atalanta* (?), *Trianae*, and *Trianae alba*, one very striking large-flowered variety of the last with large purple lip, finely edged, and deep orange-lemon throat; *Cirrhopetalum picturatum*, *Cœlogyne cristata* *Lemoniana*, *C. ocellata maxima*; *Cymbidium pendulum*, *Cypripedium Boxalli*, a fine form of dark variety; *Druryi* showing flower; *villosum*, a fine form of; *Warneri* showing; *Dendrobium Ainsworthii*, *D. crassinode Barberianum*, *Dominianum*, *D. Farmeri aurea*, *D. fimbriatum oculatum*, *D. Findleyanum*, *D. luteolum*, *D. primum gigantum*, *D. Wardianum*, some fine vars; *Lælia harpophylla*, several samples; *Lycaste Skinneri*, several, including *alba* (rare); *Masdevallia Estradae*, *Harryana*, several; *igneae*, several; *Lindeni*, several; *Shuttleworthii*, *trochilus*; *Maxillaria grandiflora*, *Miltonia Warscewiczii*, *Odontoglossum blandum*, very rare; *O. cirrhosum*, *O. cordatum*, *O. crispum*, *O. gloriosum*, *O. Halli*, *O. membranaceum*, *O. nebulosum*, *O. nevadense*, very rare; *O. Pescatorci*, *O. pulchellum majus*, *roseum*, *O. Rossi majus*, *O. Sandersianum*, *O. tripudians splendens*, *O. triumphans*; *Oncidium bicallosum*, *O. Cavendishii*, *O. cucullatum*, *O. serratum*, *O. unguiculatum*; *Phalænopsis amabilis*, *P. grandiflora*, *P. rosea*, *P. Schilleriana*; *Pilumna fragrans*; *Vanda lamellata* *Boxalli*, *V. suavis* (Veitch's variety) *tricolor* (Dalkeith variety), and *Zygopetalum intermedium*, fine variety.

VICOMTESSE HERICART DE THURY STRAWBERRY.—Your correspondent, Mr. G. Summers, says on page 276 that he finds the above variety useless for early forcing. I think he must have taken his runners from barren plants, for I have been gathering fine fruit and a good crop from my first batch, which have been ready for the last week—fine fruit weighing 1½ oz., good in colour and flavour. *La Grosse*

Sucrée I have not forced. I have Vicomtesse for first, President for second, Sir C. Napier third, and James Veitch for late. If I were compelled to grow only two varieties I should choose Keen's Seedling and President, both good bearers and of excellent quality.—S. TAYLOR, *Acacia, Rawdon.*

STIRLING CASTLE STRAWBERRY.

IN an article by Mr. L. Castle upon "Extensive Fruit Farming," page 170 of your Journal, the above variety is mentioned, and some doubt is expressed as to when and by whom it was raised. I would have answered the query sooner, but knowing that the raiser, now dead, had sons who are gardeners, I thought they might have observed the article and answered it. This Strawberry was raised here. It is a seedling from Keen's Seedling, and was raised nearly forty years ago by Mr. William Laing, a market gardener in this town. As near as I can ascertain it was sent out in 1849. The original tree of that most excellent Apple Stirling Castle is still alive and carrying heavy crops.—G. MCDOUGALL, *Stirling.*

ROSE SHOWS.

THE statement which continually crops up in your columns and elsewhere that amateur Rose-growers are wrong in using any plants but those on their own roots, will generally be found to come from one who does not exhibit. Exception has been taken by non-exhibitors to the results of shows of all sorts. For instance, live stock are said to be so fattened as to injure their reproductive powers. Dogs are said to be bred for appearance only, to the detriment of their qualities in the field; and poultry for the sake of colouring without regard to their usefulness. I hope I am right in supposing that your correspondent, Mr. W. Simons, has no such objections to bring against Rose shows, though his expressions, "the conceit of exhibition," and "the pleasure of a day would not satisfy me," do not sound flattering to exhibitors. I do not see, by the way, the force of the latter remark. Have not exhibitors as many pleasant days of Roses as others?

The only objections I have ever heard against Rose shows are (1) that they have encouraged the production of scentless Roses, and (2) that the exhibition of fine blooms of weakly bad-growing sorts is apt to deceive and disappoint a beginner. As to (1), surely the principal charm of the Rose is its appearance. If Rose shows have not decreased the number of fragrant Roses they cannot be said to have done any harm in this case; and can anyone possibly say that lovers of Roses have suffered by the production of the scentless *Baronne de Rothschild*? As to (2), a beginner may find warning of weakly growing sorts from any work or catalogue on the subject, or may question any Rose-grower; and I fancy if it were not for Rose shows we should nowhere be able to feast our eyes upon such beauties as *Xavier Olibo* and the like.

Surely exhibitors "love a bright show of beautiful flowers in the open sunshine and upon their tables," and also "have them in natural luxuriance from June to November" as well as others. And why should it be hinted that they are "selfish in their love of the flower?" Many, I should say most—perhaps all, amateur exhibitors take great pleasure in admitting their poorer neighbours to see their Roses, and one great professional at least (I speak only of my own knowledge) does the same. Exhibitors of Roses work very hard, and have much more trouble (considering the comparative value) in satisfactorily putting their specimens before the judges' eyes than the exhibitors of live animals. A well-known breeder of Game fowls said to me one day, "Why, I have no trouble at all about the showing of my birds. I put my bird into the basket, and off he goes alone by train, to Plymouth we'll say. I read in the paper he has taken first prize there, and he comes back without any trouble on my part. He is brought to my house, I take him out of the basket, he has a little bread and milk, flaps his wings and crows, and back he goes into the basket again, and off once more to—Hull we'll say this time, and takes the £50 cup there. It's no trouble whatever."

Now, when I thought of my anxieties and disappointments, not only for days before, but especially from 4 A.M. of the day of the show till actually turned out of the tent by the judges (can this be "the pleasure of a day" alluded to by Mr. W. Simons? At all events it's a longish day), I began to think the Game-cock exhibitor had the best of it. But when I saw that long-legged bird himself, and reflected that it was the show system that had made him unfit even to cross with my Dorkings, I was comforted, thoroughly believing that Rose shows have improved the Rose, and have not made exhibitors selfish.

I began to write, intending to answer your correspondent's remarks upon Roses on their own roots; but I have been led into

a long digression from fancying (unnecessarily, I hope) that Rose shows and exhibitors were mentioned in disparaging terms in his letter. Being now fearful of intruding on your space I will wait another week, in the hope that some more able advocate than I am will show the advantages and necessities of "worked" Roses.—A. F. M.

P.S.—Some of my Roses which were pruned since the severe weather have bled considerably, the sap globules shining like diamonds in the sun, and in some instances running down the stem; but the discharge has ceased, and I do not fancy much harm is done by it.

GARDENERS' BENEFIT SOCIETY.

I QUITE agree with Mr. Peter Ferguson in what he says about a gardeners' benefit society. I am glad that someone has at last brought it before the readers of this Journal. I have often thought I should like to mention the subject myself, but felt incompetent to do it, and I have as often wondered that there was not such a society in existence, as it would be the means of causing more unity amongst gardeners. It would also be the means of imparting knowledge one to another; for instance, one may grow Grapes well and fail with Cucumbers, the same *vice versa*, therefore the two would gladly help one another. I think if such a society was once properly started it would soon become one of the strongest in the kingdom; but one thing I would like to suggest, if ever it does come to pass, that the meetings be not held at public houses.—J. SMITH.

NOTES FROM ASHTON COURT.

THERE is always much to admire in the extensive gardens at Ashton Court near Bristol, Mr. Austin, the gardener in charge, being generally admitted to be one of the best "all round" gardeners. Everything that is taken in hand is well done, and pages might be written both upon the success attending the fruit and vegetable culture as there practised under by no means favourable circumstances; and also the fruit, vegetable, and plant culture in the many houses and pits in connection with the kitchen garden and pleasure grounds. At present my remarks will be brief, but later on I hope to have much that is instructive and interesting to communicate.

ORCHIDS.

Orchids of all kinds are in good condition, and appear unusually floriferous. Lately the most conspicuous is a remarkably fine specimen of *Dendrobium Cambridgeanum*, and which I believe has no equal in this country. The pseudo-bulbs produce their flowers on the current season's growth, the foliage being still green, and these on the plant in question are from 10 to 11 inches in length, about sixteen in number, and carry on the average eleven blooms each, or in the aggregate upwards of 180. The habit of growth is drooping and handsome, the colour of the sepals and petals of the flowers rich orange, while the lip is principally crimson. The specimen has not been removed from the basket for years, but much of the compost, which consists of rough peat, sphagnum, crocks and charcoal, is annually carefully removed and fresh supplied. After flowering the plant is gradually ripened off, and is eventually removed to a cool house, where it remains till it commences to form fresh growths. This takes place early in November, when it is returned to a light position and an ordinary stove temperature, and kept moderately moist. Under these conditions it annually perfects growth of a very free-blooming character. Unfortunately the blooms do not long retain their freshness, but are extremely effective while at their best.

Among the *Dendrobiums* there are several imported plants of *D. nobile*, which, though smaller in flower than the ordinary type, are very highly coloured and free-blooming. *D. heterocarpum* also varies considerably, is less showy, but, being remarkably sweetly scented and floriferous, is deserving of general culture. *D. Pierardi*, *D. macrophyllum* in variety, *Oncidium sarcodes*, *Cymbidium eburneum*, *Phalænopsis Schilleriana*, and *Cypripediums* in variety, all contribute to the enlivenment of the Orchid house. Cool Orchids are fully appreciated, and are being increased accordingly. These, which include many *Odontogloss*, *Oncidium*s, *Lycastes*, *Laelias*, *Cypripediums*, *Cœlogynes*, and *Ada aurantiaca*, are grown in a lean-to house with a northern aspect. Judging from their appearance the minimum of sunshine they receive is quite sufficient, as abundance of light (which is always the strongest on the north side), moderate-sized pots, and judicious watering are all that are necessary for the formation of sturdy growth and strong flower spikes.

STOVE PLANTS, VASES, COVERING WALLS.

No large stove plants are grown, but the houses are filled with innumerable highly coloured and serviceable half-specimen Crotons, Dracenas, Pandanus, and other fine-foliage and flowering plants. A hanging basket completely surfaced with Peperomia, the centre filled with a highly coloured *Ananassa sativa variegata*, and another similarly filled with *Panicum variegatum* and a bushy and brightly coloured *Croton Youngi*, were singularly pretty and effective. So also was a back wall of a plant stove and pillars of a doorway which were faced with a charming mixture of Lycopods, Ferns, principally *Adiantums*, *Peperomias*, *Fittonias*, *Panicums*, and small pieces of *Begonias* of the *Rex* type. These were dibbled into soil consisting principally of turfy loam and peat, enclosed with strong wire netting, and in this manner what might have been an unsightly wall is easily transformed into a most pleasing feature. Those who may attempt a similar experiment are advised to lightly shade the plants till they are established—newspapers are employed for this purpose at Ashton Court—and at all times to syringe freely in order to

maintain the requisite amount of moisture at the roots. I have previously seen walls covered somewhat similarly, but at Ashton Court saw the *Gardenia* utilised as a wall plant for the first time. So well does this answer the purpose, that the thought at once suggested itself, "How strange that no one else appears to have tried it in the same way!" *Camellias* are generally considered well adapted for covering walls in a cool house, or in the open, as at Ashton Court; but in this position in reality are much inferior to the *Gardenia*, whether in or out of bloom, and are much less accommodating in habit. Mr. Austin has planted the latter in a narrow border filled with loam, peat, and charcoal, and they are now about 10 feet high, of proportionate width, well furnished, and giving promise of abundance of bloom, which will be produced for several months.

CAMELLIAS AND AZALEAS.

Camellias planted in the conservatory and in pots are in excellent condition, and several large specimens planted against high terrace walls and in the open shrubberies are very healthy and



Fig. 78.—*TRICHOPILIA LEPIDA*. (See page 322.)

have abundance of buds, *C. Bealii* in particular being crowded with them. *Rhododendrons*, again, are largely represented in the grounds and also in the conservatory. In the latter house they are grown in pots, and are extremely handsome. The best were *Auguste Van Geert*, with large trusses, colour chocolate purple spotted; *Limbatum*, white, with crimson margin; *Prince Camille de Rohan*, white, shaded with rose; *Fair Rosamond*; *Hendersonii*, purplish crimson; and *Brayanum*, bright rosy scarlet.

Azalea mollis in variety is largely forced, and wonderfully fine they prove, and are much superior to the Belgian *Azaleas* for pots.

STAPHYLEA COLCHICA.

Of this perfectly hardy deciduous shrub Mr. Austin has about fifty plants in various stages of growth, and rightly considers it invaluable for early forcing. More dwarf than *Lilacs* and as free blooming, the panicles of pure white blooms being produced somewhat similarly, as sweetly scented as a *Tuberose* or *Gardenia*, it must inevitably become wonderfully popular both for private

gardens and markets. It is easily forced into bloom, and judging from its appearance and my experience with a panicle of bloom, it will prove serviceable in a cut state for bouquets as well as vases. Mr. Austin made no mistake in purchasing largely, and neither will others who may follow his example.

The *Roman Hyacinths* are largely grown for furnishing cut blooms, while the large-flowered *Hyacinths* are extensively grown for conservatory decoration. Of the latter in a large collection the finest were, *La Joyeuse*, single red; *Baroness Von Tuyl*, *L'Innocence*, *La Grandesse*, *La Franchise*, *Elfride*, single white; *Grand Lilas*, *Czar Peter*, *Pieneman*, single blue; *Laurens Koster*, double blue.—W. IGGULDEN.

BULBS UNDER TREES.

MR. WM. PLANT, under this heading (page 280) explains how we may lose by the scythe bulbs thus planted, and there is little

doubt that this is the correct explanation of the cause of failure where they have been tried. I have two large Horse Chestnuts, but not on a lawn; they are in a border, and the scythe of course never goes under them. Snowdrops in large quantities, Daffodils and Tulips also grow under them, and have done so for many years; the Tulips, though covered by them, may perhaps be scarcely considered directly under them, at least not under the branches, and I need not say they are not florist flowers. In some of the parks in Wiltshire I have seen the grass under the forest trees—Beech for instance—quite carpeted with the wild blue Hyacinth or Bluebell, and a lovely sight it is. I fancy, too, I have seen the cultivated Hyacinth also, but at any rate my belief is they would succeed. Some of the woods, too, in Wiltshire are also carpeted with the wild Hyacinth for acres together. Is it, perhaps, any explanation of the fact that bulbs may do well under trees where many things decline to grow, that the bulbs come into bloom before the trees come out into leaf, and so are not continually shaded from the sun as any growth of the later months is?—Y. B. A. Z.

TREES AND SHRUBS NOT INJURED BY RABBITS.

It is extremely difficult to name trees and shrubs that rabbits will not eat; in fact I find they will nibble at everything, especially if newly planted, and they have a partiality for trees or shrubs from fresh ground, even if they have access to any quantity of the same kind growing on the spot, and prefer in all cases the foliage or wood of young to old plants. It is interesting and instructive to observe the inquisitiveness of the rabbit in the case of importations of fresh trees or shrubs to their haunts. I never planted a tree or a shrub but they have skipped across to it after all was quiet. They would sniff at the fresh soil and cleanse their nails in it, then at the tree or shrub and try its quality; but the following trees and shrubs have survived where ground game abounds.

The most valuable of all evergreens is the Rhododendron, especially *R. ponticum*, which being in many instances semi-prostrate in habit forms excellent cover, doing well in shady situations. Rabbits are very fond of burrowing under the bushes, more so than under any other, which may be accounted for from the ground being dry. Pheasants as a rule nest in isolated specimens in preference to those in the mass. The Rhododendron will grow in any loamy soil, doing well in all except those of the limestone formation. *Andromeda* and *Kalmia* are not eaten by rabbits, while *Azalea pontica* and *Box*, which does well in shade and light or gravelly soil, are not eaten. Elders also thrive, and *Eunonymus europæus*. Yews though somewhat cut, and Portugal Laurels injured in severe winters by the rabbits, recover, and make handsome evergreens. Sloe or Blackthorn is not much cared about, and the Bird Cherry (*Cerasus padus*) is not eaten. Birch is not touched, and Alder not seriously. Beech, though in some request, generally makes headway, and so does the Mountain Ash or Rowan. Bitter Willows are exempt from their ravages. The only Conifer that grows without serious disfigurement is the Corsican Pine, and this with Rhododendrons forms handsome plantations.

There is often great difficulty in forming plantations and shrubberies where ground game is plentiful, from their being little provided for the use of the animals in severe weather, or when their ordinary supply of food is cut off by snow. The damage done may often be much mitigated by planting as nurses thickly the kinds of tree or shrub the rabbits are most partial to, such as the Broom and Ash. They are also very fond of Whin or Gorse. In making plantations where there is much ground game the plants should in the first instance be strong, and their stems for at least a yard high ought to be made proof against the ravages of rabbits, by coating them with some pigment, nothing being better than fish oil with a fourth of coal-tar added. The oil is the crude material, to be had at most fishing towns of note.—G. ABBEY.

DOUBLE VARIETIES OF PRIMULA SINENSIS.

THESE flowers are too well-known and justly appreciated to necessitate any eulogistic remarks from any pen. Sufficient evidence of this is easily acquired by a knowledge of the demand not only for the plants but for flowers in a cut state in the market. On this account they are very largely grown by skilled market growers, especially the old Double White, named *alba plena*, and it is surprising to notice their great superiority to the majority of the plants so frequently seen in private gardens. The great difference of effect, like everything else, is regulated by the causative operations at work in the production of such dissimilar

results, and leads us to ascertain the best methods adopted in their successful cultivation.

Raising double-flowered Primulas from seed is anything but a profitable occupation for the many. A few experts may fairly succeed, and give to the world, as the result of their patient labours, truly good and novel varieties; but as a rule all good florists' flowers are the reward only of much patient and intelligent work, such as cannot ordinarily be effected. Neither are cuttings of Primulas so freely produced as is the case with many softwooded plants, otherwise we should more frequently find them in smaller collections. There are two fairly successful methods of increasing these plants—viz., by earthing-up the side shoots, and by cuttings. Presuming that we have old plants to deal with at the present, which is the best possible time to handle them, it will be necessary, if the plants have been subjected to a temperature higher than 65°, to harden them off in a lower temperature for a few days, when the shoots should be cleansed from all the old persistent footstalks, of which there are usually an abundance. I have found Grape scissors very convenient for the purpose, after which the pots should be filled with soil up to the active crowns of the plants, and if an incision is made in each shoot it will facilitate root-action. The soil employed for layering—good fibrous yellow loam, leaf soil, and coarse silver sand in equal parts—should be well watered round the shoots. The plants should then be placed in a close pit or house with a moist temperature of from 65° to 70°, and be kept shaded and moist. They will be well rooted in about three or four weeks after being treated, and may be severed from the parent plant and potted singly in small pots, using the same compost, placing them again in the same temperature until they are well established, when they may be gradually hardened off. It is very beneficial to keep the small plants as near the glass as possible, and well shaded. By this means with care there is no reason why every shoot should not be quickly converted into a well-established plant.

They may also be increased by cuttings, and this is a very convenient method when there is a constant demand for young plants. They can be taken from the plants with a good chance of success any time between March and August. In all cases the cuttings should be well hardened before being removed from the parent plants, and with a portion of the mature wood attached. Each cutting should be carefully cleaned, and inserted singly in well-drained small pots filled with soil like that described for the layering process, with a copious supply of coarse silver sand upon the surface, and for this as well as most other purposes the coarse Bedford sand is preferable. The pots should then be plunged in the propagating case with a bottom heat of from 65° to 70°, a higher temperature being, judging from my experience, not desirable. The cuttings should be well watered, after which they will require but little or no more water until they are rooted. If so it should be given carefully, allowing as little as possible to rest upon the foliage. They will usually root in a fortnight or three weeks. They must be kept well shaded during sunshine. It is not absolutely necessary to have a hotbed to plunge the pots in, as the cuttings will root freely enough under a handlight in the same temperature. After being well rooted they may be removed and gradually hardened off, and kept in the small pots until the latter are well filled with roots.

Supposing this stage is reached by the middle or end of June, they should then be shifted into larger pots, say 54 or 48 sizes, using as compost for potting fibrous loam, leaf soil, and sand; if the 48-sized pots are to be the flowering size, the mixture will be more useful to the plant if an equal part of well-decayed cow manure is added. They may then be grown in a cool house near the glass, with a cool base for the pots to rest upon. The necessity of perfect drainage cannot be too strictly enforced, no small amount of success depending upon this receiving proper attention; or they may be placed in a cold pit or frame facing north, or in a shaded position, when they should be kept close for a time, only giving air during mid-day. The time of placing them in the cold frame must, of course, be regulated by the weather. If cold and dull, they are best kept in the house rather later, or until favourable weather sets in. If the pit is very deep the pots should be arranged upon other inverted pots; and in places where only a small number is grown this will be the wisest course to adopt, as it insures a more copious supply of air amongst the plants, and allows of perfect drainage. Ventilation should be effected by tilting the lights from below rather than sliding them down.

During the month of August and early in September, if the nights are warm and moist, it will greatly benefit the plants if the lights are entirely removed, replacing them again early the following morning, as the dew which usually prevails during the night appears to suit them, and during these months I find they

make very rapid growth. It is likely that if the plants are developing properly they will require repotting, which should, however, not be done till the old pots are well filled with roots, as they do not like to be overpotted. The pot employed for the final shifting may be 6 or 7 inches wide inside, just giving them a fair increase of root-room, using the same kind of soil. If it is necessary to keep them in the 48-sized pots, they may be fed with weak liquid manure twice a week, which will materially assist them. In any stage of growth particular attention must be given to watering. When in active growth they must never be allowed to get dry, and copious supplies may be given them providing the drainage is efficient. Owing to their propensity for perpetual flowering the young plants will constantly be throwing up flower spikes, which should be at once removed, so as to give the plant the benefit of all the strength to be derived during the growing period, otherwise its cumulated resources will be very small when most required for winter blooming.

As the autumn approaches and the nights grow cold, it will be necessary to remove the plants to their winter quarters in the greenhouse; and it is as well to say here that they may be kept and flowered during the winter months in a much lower temperature than is generally supposed to be the case. During the season 1880-1, owing to the inefficiency of the hot-water apparatus in a cool greenhouse, the writer had Zonal Pelargoniums killed by frost, while strong and well-grown plants of double Primulas did not apparently suffer the least, as far as could be judged from their appearance. It must not, however, be inferred that such a low temperature is well suited for them. For ordinary conservatory and greenhouse decoration they are well adapted, being of a most floriferous disposition, while at the same time for expediting flowering they can be placed in a higher temperature, and will flower equally well. The varieties described below are all well worth growing, and will give a great supply of flowers if cultivated as they deserve to be.

Alba plena.—This is the oldest double-flowered variety. It is of very free growth, producing good trusses of flowers in abundance, and is still largely grown almost exclusively for market owing to the purity of colour.

Fimbriata alba plena.—An improvement upon the last, with larger trusses of flowers, which are individually larger and more duplex, with finely fimbriated edges; the plant is also stronger in habit, but the flowers are not such a pure white, being tinged with pink.

Rubra plena.—A form similar to the first with the same habit, but not quite so free-flowering; flowers bright rosy-purple.

Emperor.—A splendid variety belonging to the Fern-leaved section. The foliage is very handsome; the flowers are very double, of a deep rosy-purple colour, each forming a perfect rosette, and produced in crowded spikes, which last for a considerable time. This is one of the showiest of the rubra group.

Empress.—This is the counterpart of the last, with light green Fern-like foliage and strong trusses of large very double and pure white flowers, beautifully fringed. Rather more delicate than the Emperor, but easily grown and very pretty.

Exquisite.—Very dwarf and compact, with a strong disposition to be all flowers. The trusses are very abundant, while the large flowers are very double, white, delicately shaded with rose. A charming variety, but the flowering must be checked or the plant exhaust itself.

Candidissima.—A vigorous-growing kind, with full and bold trusses of flowers rising well above the foliage, pure white, well formed, with fimbriated edges. The boldness of the trusses is very distinctive, and I regard this as one of the best white-flowered varieties.

Miss Eva Fish.—A strong-growing and large-foliaged variety, producing enormous spikes of flowers, which are very large, scarcely covered by a half-crown piece, white, marbled and edged with purple. Most distinct, showy, and well adapted for bouquets, as the footstalks are very long.

King of the Purples.—A very telling and free variety, with good trusses of very double flowers of a deep magenta-purple colour—perhaps the deepest-coloured double variety, and of good form.

Lord Beaconsfield.—Plant of vigorous habit and very floriferous. Flowers large, of perfect form, bright rosy salmon—a most effective colour. This should be extensively grown.

Princess of Wales.—A very free grower, producing stout erect trusses of flowers, large and very double, pure white, with finely fimbriated edges. This is a very distinct kind, as the leafstalks and flower scapes are deep red, which is in striking contrast with the flowers.

White Lady.—This is one of Mr. Gilbert's new varieties recently sent out by Messrs. Osborn & Son of Fulham. It is a free grower, with very large trusses of pure white flowers, or the flowers are

sometimes striped or blotched with red, when they have a novel appearance. Besides these there are many other varieties of equal value for the purposes for which these are commended.—
PROFESSIONAL.



[By the most skilful Cultivators in the several Departments.]

HARDY FRUIT GARDEN.

Protection.—The great range of temperature of late—very hot days and very cold nights—has made us watchful of trees in exposed situations, especially of Pears with forward blossom buds, which are very liable to damage. In such dry weather, however, protection is only required in exceptional cases, for wherever the trees have walls, fences, or buildings to screen them from cold winds very little more is required. Extreme cold and wet prove so fatal to blossom, and while they continue dry blossom left uncovered is more likely to set its fruit than that which is enveloped in mats every night. A wall of cordon Pears facing due east is screened from cold wind by a belt of trees running parallel to it at a distance of 30 feet, and never has any other shelter, yet most of the trees afford an annual crop of fruit. Blossom and foliage stiffened by frost suffer most when the bright warm rays of the rising sun fall directly upon them. A gradual thaw saves them, hence the value of anything to intercept the direct brightness of dawn—a mat for trees, and a little litter such as fern or hay for bushes.

Top-dressing.—When Raspberries, Gooseberries, and Currants are thoroughly established and in full bearing there should be no more digging among them, but an annual heavy top-dressing of manure either from the farmyard, stable, piggery, or old hotbeds. If this is not yet done no time should be lost about finishing it as soon as possible now. First examine the surface, and if the roots have become fully established in last year's dressing, then a heavy dressing is required now; if not, a light one will suffice. Let the value and importance of this dressing be fully understood. It attracts the roots from the cold subsoil to the warm surface, maintains the bushes and canes in full health, vigour, and fertility, keeps out drought, keeps down weeds, and saves the annual winter's digging, which is such an expensive matter in extensive plantations. The soil of Strawberry beds has become beaten down by the heavy rain of the past winter. Let it be loosened slightly at the top with hoes and a liberal dressing of artificial manure be applied to the entire surface of the bed, so as to be washed in by spring showers, and thus provide a store of nutriment for the new growth.

FRUIT FORCING.

Figs.—Where Early Prolific and Early Violet are grown in pots for the first supply the fruit will soon commence ripening, when water must be reduced; but in the case of Brown Turkey, Negro Largo, and White Marseilles (the three best Figs for forcing), it must be supplied some time longer, giving liquid manure twice a week, and syringe them once or twice a day. Those ripening must not be wetted, as it spoils the quality of the fruit and its appearance also. Ventilate freely when the air is not cold. It is better to allow the temperature to rise somewhat above the ordinary maximum than admit cold air in quantity. If the day be likely to be fine shut off the heat early in the morning, so as to allow the pipes to become cool, and turn it on again at closing time. Increase the night temperature to 65° on mild nights, and 60° or a little lower on cold nights, 65° to 70° by day, ranging the temperature from 75° to 80° by day, with an advance to 85° or 90° after closing. Trees in succession houses must be well attended to in thinning, stopping, and regulating the side shoots, also the terminals when they are near the limit of the trellis. Keep the surface of the soil in pots and of borders well mulched, supplying water liberally, of which healthy Fig trees take great quantities. Syringe twice a day, and close with a strong heat about 2.30 P.M. on fine afternoons. Pinch out the points of the shoots of young plants which were potted last month, and when the pots are full of roots shift into 10-inch pots. Drain well, and employ a compost of turfy loam with a fifth of old mortar rubbish and a sixth of well-decayed manure, keeping the plants rather close and

warm, but near the glass, so as to insure early free growth and become thoroughly ripe before autumn.

Vines.—In order to keep the stock of late Grapes in good condition as long as possible, or until the early Grapes are ripe, the bunches will require frequent examination—viz., two or three times a week. Thoroughly clean bottles from which the Grapes have been removed, re-fill with clean rain water, to which add a piece of charcoal, and transfer the bunches still remaining to the clean bottles and water before the old wood commences to make roots in bottles in which they have been some time, and an impure sediment formed. If growth takes place remove it promptly, keeping the room dark, well ventilated, and as cool as possible. Grapes in the early house will now be colouring, and should be given a somewhat drier atmosphere with increased ventilation; but the floors, mulching on the borders, and all available spaces must be kept thoroughly moist as a means of securing the thorough swelling of the berries and the foliage healthy. If red spider has appeared, lose no time in applying the usual remedy—i.e., coating the heating apparatus thinly with a mixture of sulphur and skim milk, and afford tepid liquid manure to inside borders generously, performing all watering early in the day, and ventilate freely to allow surplus moisture to escape before the house is closed in the afternoon. The Vines in midseason and late houses are now making rapid progress. Keep the growths carefully tied down as they advance; stop them two or three joints beyond the bunch, the laterals at the first joint, but those beyond the bunches may be allowed to extend until the trellis is fairly covered with foliage without crowding. Ventilate early to prevent scorching and insure thick leathery foliage, closing with a brisk sun heat, and dispense with fire heat as far as practicable. Supply tepid liquid manure to inside borders abundantly. Late Hamburgs should be allowed to come on naturally, as, unlike the thick-skinned varieties, they keep well if not ripened until September is advanced. New borders being in readiness, or if they have to be made for planting this spring, they should at once be prepared, so as to be ready for the Vines by the close of this month. Let the borders be well drained, about 2 feet 6 inches deep and 3 feet wide to start with, planting inside if possible, but with means of allowing the roots to pass outside after the inside border is fully occupied with roots. Shake the soil from the roots, disentangle them, spread the roots well on the surface, and cover with 6 inches depth of soil, supplying water at 90° to 100°. Shade lightly for a few days, and keep close until the Vines begin to move, then ventilate according to circumstances. Transfer young Vines into fruiting pots as they become fit, using a rough compost and plenty of drainage. Pot firmly, and although slight shade will be beneficial for a few days until the roots have laid hold of the fresh soil, train near the glass, as they must have full exposure to sun to secure short-jointed wood.

Strawberries in Pots.—The present is the season of fine Strawberries, and to have the fruit swell off well the labour in watering is considerable. Plants in good health will need examining twice a day or oftener, while those in flower should have a free ventilation, avoiding sudden changes of temperature, as the tender organs of the flowers are soon damaged. Work all plants forward in a gentle heat in the first stages of swelling the fruit, thinning the fruit, nay the blossom, where extra fine fruit is desired to a dozen or so of the largest, giving abundance of atmospheric moisture as long as the fruit remains green, and when it changes to or assumes a whitish appearance a temperature of 70° to 75° artificially, and 80° to 90° by day, they will swell off to a great size; but when red the night temperature should be lowered to 60°, and air freely admitted with a warm atmosphere by day to insure high flavour, dispensing with water as much as possible at the roots, only giving enough to keep the foliage fresh.

THE FLOWER GARDEN AND PLEASURE GROUND.

Lawns.—No further time should be lost where these are to be either formed or renovated. The ground is best prepared in dry weather, when the soil can be evenly distributed and made of the requisite firmness. Turf should be laid in showery weather, and it then soon becomes established. Spring-laid turf is apt to shrink during hot dry weather, and when this happens it is advisable to fill up the cracks with fine soil. Whenever it is absolutely necessary to lay down turf during hot weather the surface of the prepared ground should be composed of rather fine good soil, and be moistened prior to being covered with the turf. The latter should be heavily beaten, a quantity of fine soil be worked into the crevices, a good soaking of water given, and the whole thinly mulched with short stable manure. Lawns are more cheaply formed by sowing grass seeds, suitable mixtures and the requisite quantities of which are supplied by leading

seedsmen. Sow during showery weather, well rake in, and then heavily roll. Where the turf is too thin well rake the surface and sow a liberal quantity of suitable seeds, lightly dress with a mixture of fine soil, wood ashes, road grit, or other available fertilisers, and well roll in. Mow at first with scythes, and later on the machines may be employed. The mowing machines ought to be set to work before the now fast-growing grass gets too long to be cut by it, and the edges of the turf ought to be all cut. All the annual trimming of Laurels, Conifers, Box, Hollies, and other evergreens ought now to be completed, and transplanting be discontinued, unless skilled hands with suitable machines for the purpose are employed. Newly planted trees, especially those transplanted late in the season, will require abundance of water at the roots during the prevalence of hot dry weather, and if they can be frequently watered overhead with an engine or syringe so much the better.

Flower Beds.—Those not filled with spring-flowering plants, and which have been roughly dug during the winter, will now be in a good condition for the reception of any hardy or half-hardy plants that may be employed for summer decoration. Violas may be lifted, divided, and replanted in fresh and well-manured positions, and those wintered in frames and which have been hardened off may also be finally bedded out. The blue varieties, of which some of the best are Favourite, Tory, Blue Perfection, and Blue King, are very effective when planted in mixture with silver variegated, bronze, or golden-leaved Pelargoniums, or form good edgings to almost any kind of bedding plant, blue Verbenas, Ageratums, and Heliotropes excepted. Of the yellow Violas, Sovereign, Lutea grandiflora, Major, and Ardwell Gem are to be commended for edgings and mixtures. Echeveria secunda glauca may now, providing they have been wintered in a cool frame or house, or merely protected with mats and boards, be now bedded out. They are still very popular for the margins of raised beds. No clay, cow manure, or other mixtures are now considered necessary for fixing these in position, all that is done is to make the margin firm and sloping slightly inwards. The Echeverias, moved without any soil, have their stems cleaned, and are then firmly dibbled into the sloping margins so as to be slightly above the level, facing outwardly and clear of danger from the mowing machine. Sedum glaucum also forms a neat margin to raised beds. This should be pulled to pieces and dibbled in thinly. The hardy silvery-leaved Stachys lanata divided and replanted singly or in a double line proves an excellent edging for large beds, and for cool positions the beautiful Tussilago Farfara variegata is well adapted. It spreads in all directions, and the crowns, with about 3 inches of root attached, should be lifted and replanted about 10 inches asunder in lines or circles before the leaves are developed. Antennaria tomentosa, a close-growing, hardy, silvery-leaved plant well adapted for the groundwork of carpet-bed designs or for edgings, should be freely divided and dibbled in about 2 inches apart each way.

The green carpeting plants *Herniaria glabra*, *Mentha Pulegium gibraltarica*, *Sedum Lydium*, and *Veronica repens*, may all be divided and dibbled in rather thickly in good fine soil, in order to increase the stock prior to bedding-out time; or they, and also *Sedum glaucum*, may at once be dibbled in where they are to remain, all being available for forming the groundwork of carpet-bed designs. *Dactylis glomerata* varieties and *Festuca glauca* are elegant Grasses well adapted for edgings, and these may be freely divided and finally dibbled in or disposed thickly in an open position till required. The variegated Thyme, hardy Vincas, *Cerastium tomentosum*, *Arundo donax variegata*, and the golden *Lysimachia* are all improved and increased by division and replanting.

THE BEE-KEEPER.

BEER, BRANDY, AND BEES.

SCIENCE has proved beer and brandy bad for the human system if science has proved anything at all, yet swarms of the human race may be said almost literally to buzz round the beer barrel and the whisky cask. Our best bee-masters seem to have agreed with the old farmer, that "what is bad for me can't be good for them;" but bees, industrious as man, seem to be equally infatuated with anything alcoholic. A hundred years ago Bonner observed this fact and took advantage of it. He advised would-be bee-keepers to take a glass of good ale, and to rub a little over the face and hands when they intended to manipulate their bees.

This advice has been ridiculed and laughed at, but there is something in it, as the following case will show. Last summer the publican in our village had a swarm of bees. He knew nothing about them, and, we daresay, never will. As a consequence, I and another, to prevent them dying during the wet inclement summer months, had to attend to them. One day we discovered that the ends of the combs were so bent that the bars could not be moved. To rectify this each was detached from the top bar and pressed into its place; but the bees got too little smoke, so we got too many stings. Strange to say, however, the publican, whose system we may just say—and, writing *incog.*, no personality is indulged in—is saturated with alcohol, got none, although they crawled over his face and hands in scores. Now, why this taming down so very suddenly? and why the haunting of beer barrels by bees, which everyone must have observed? The smell of any alcoholic liquor seems to have as great an attraction for bees as honey itself. Bonner turned this to good account before the use of smoke was known, at least in this country. Is it not possible to turn it to good account still? or have we found a more excellent way?—NOVICE.

THE STRAW STEWARTON HIVE.

THE principle of the Stewarton hive has, I believe, been approved by all competent and unprejudiced bee-keepers who understand it. No other hive has been less spoken against, and those who use it properly and practically admire it the most. Though we have never used this hive in our apiary we have always admired its arrangements for supering and enlarging, which are its main characteristics or essential features. The original Stewarton is made of wood, and therefore is objectionable and too costly. It is not extensively and widely known. Last season something was said about straw Stewartons, and one termed a "Pettigrew Stewarton" was exhibited at one of the bee shows. Though I knew nothing of this hive or its inventor I resolved to have some straw Stewartons made to order after my own pattern. The pattern cost a good deal of thought, because I wanted to get the best possible kind of Stewarton hives at the lowest possible price. Capable and beautiful hives easily worked and understood were what we sought. To begin with we ordered thirty-two hives. They have been made as ordered, and are now in our possession, and are greatly admired by all the apiarians who have seen them. I am much pleased with them, and cordially invite all bee-keepers near Manchester to see them. Believing that the straw Stewarton hive in various modifications will in future years be largely used in the apiaries of England, I will here attempt to describe those we have had made.

They are 15 inches wide and 13½ deep, inside measure, and therefore are rather less in size than a bushel measure, which is 16 by 14 inches. The wooden runs are 1½ inch wide, to which 12 inches in depth of straw in well-rounded rolls is well and firmly sewed. The bottom rolls are doubly stitched, giving the hives a fringe and finish, which add to their beauty. So far as appearance goes the hives now referred to are unsurpassed. The bars across the tops—nine in each hive—are neatly let into the top rims, 1 inch broad and half an inch apart.

The common wooden Stewarton has its bars grooved, and slides to run into and between the grooves, and these with the bars form the crown of the wooden Stewarton. Such slides have always appeared to me to be objectionable, because the bees are apt to cement them to the bars, and thus make their removal rather difficult and dangerous. For our straw Stewartons we have no slides and no grooves. The bars and hives are covered with moveable straw lids, exactly corresponding with and slightly overlapping the sides of the hives, and the lids are fastened to the hives by three or four wire nails 5 inches long. The nails go right through the lids into the straw rolls below the rims, and are easily pushed in and as easily withdrawn. Such lids can be removed from the tops of hives to admit supers with the greatest possible facility and speed, and placed on the top of the supers.

Our supers are made of wood 3¼ inches deep, and of course 15 inches wide, to correspond with the hives. The bars in the supers are 2 inches wide for honeycomb and three-eighths of an inch asunder. Supers in straw would be better for, and better liked by, the bees and more easily fastened to the hives than wood ones, but honeycomb in such large supers would be more likely to be disturbed and loosened by the yielding nature of straw. Wooden supers are firmer and better for bars than straw. For fastening such wooden supers to the wooden rims already described we shall use wire staples, going into each through gimlet holes.

In good seasons two or three supers may be placed on one hive, and often it may be advantageous to use of them as an eke to

enlarge a hive from below. Another advantage of my Stewarton is this, that the lids have centre holes in them 4 inches wide with moveable lids to cover them. In removing hives to the moors or in sending them a distance from home, ventilation at the tops is absolutely necessary. By covering the holes in the centres of the tops of the hives with wire gauze or fly-proof wire, also their doors, bees may be safely sent any distance without fear of suffocation; and if the Stewarton principle of supering be departed from small supers may be filled, and boxes of sections may be filled through the small holes in the lids, as in the case of bar-frame and straw hives; but the Stewarton principle of supering answers so well that we think it should be well understood and followed as closely as possible. By using thin pasteboard over the bars and cutting it to fit small and square supers—indeed supers of all shapes and sizes, the Stewarton principle may be advantageously used throughout the whole range of supering.

In feeding bees in hives such as I am now describing how easy it will be put on empty supers, lift off their lids, and put what food we want to give them on the bars. Though we like the hive much because it is nice-looking and offers great facilities for work to both bees and their masters, its great and grand feature lies in the fact that it is made of straw instead of wood. Last year a bee-keeper—a very intelligent gentleman who keeps straw hives—came to see me. We then advised him to try the bar-frame system. He came again on Easter Monday, about a fortnight ago, when he told me he had not followed my advice because he had been at exhibitions—seen many bar-frame hives, and talked with several bee-keepers who had used them, and who told him "All that Pettigrew has said against wood as a material for hives is quite correct."

As to the cost of my straw Stewarton hives I may be permitted to inform the readers of this Journal that each hive with super complete and carriage here cost about 6s. If the order were repeated a second lot would cost as much.—A. PETTIGREW.

UNITING HIVES.—Acting on the advice you kindly gave me last week I have united my weak hive to another, and on taking out the comb I found four large slugs living comfortably in the hives. It may be a caution to other bee-keepers.—CLIFTON.



* * All correspondence should be directed either to "The Editor" or to "The Publisher." Letters addressed to Dr. Hogg or members of the staff often remain unopened unavoidably. We request that no one will write privately to any of our correspondents, as doing so subjects them to unjustifiable trouble and expense.

Correspondents should not mix up on the same sheet questions relating to Gardening and those on Poultry and Bee subjects, and should never send more than two or three questions at once. All articles intended for insertion should be written on one side of the paper only. We cannot reply to questions through the post, and we do not undertake to return rejected communications.

Flower Boxes (*A. J. Sanders*).—The boxes you require can be obtained from Messrs. W. Lovel & Son, Driffeld.

Frames for Blinds (*H. J. C.*).—You could obtain such frames as you require from any of the principal horticultural builders who advertise in our columns.

Protecting Trees from Rabbits (*F. B., Leeds*).—In another portion of this Journal (page 326) you will see an article upon trees and shrubs which are comparatively safe from serious injury by rabbits. It is also there mentioned that a pigment of fish oil and one-fourth of coal tar is a suitable material for dressing the base of the trees to the height of about 3 feet.

Large Bunches of Grapes (*P. C.*).—This subject has been fully discussed and illustrated in these pages during the present year in the following numbers, which can be obtained from the publisher post free 3½d. each:—January 18th, page 59; March 8th, page 203; March 15th, page 218; and March 22nd, page 239.

Orchid Flowers (*J. J., Lancashire*).—The Orchids you sent were all very good varieties, *Dendrobium Devonianum* being uncommonly fine. *D. Wardianum* was also large, but we figured a finer variety in this Journal, page 317, vol. ii. The *Phalanopsis grandiflora* was excellent, and the *Odontoglossum cordatum* was also of a fine variety, and with a spike of twenty-seven blooms must be very handsome.

Evergreen Climbers for a Cool House (*M. E. B.*).—The *Begonia fuchsoides*, which is probably the plant you refer to, would be suitable for a

greenhouse or conservatory, and looks extremely well trained up pillars or rafters. You may also grow *Lapageria alba* and *rosea*, *Lonicera sempervirens*, *Rhynchospermum jasminoides*, *Sollya heterophylla*, and *Acacia verticillata*.

Temperature for Early Strawberries (*E. S. R.*).—The structure you mention would no doubt be suitable for Strawberry forcing if sufficient heat could be maintained. At starting the night temperature should not exceed 50° or 55°, but as the growth advances and the flower trusses show increase it to 60°, the day temperature with sun heat rising 10° higher. With a pit such as that you propose building a covering of mats would be necessary in severe weather. The extract you give is correct.

Seedling Auriculas (*J. G.*).—The flowers you sent are not up to the show standard, except the two selfs, which are fairly good. You should attend one of the National Auricula Society's shows, and you would then be able to form some idea of the quality of the seedlings you have raised. There has been some slight alteration in the matter you mention, but the difficulty complained of has been removed, and you should now obtain each copy about the usual time.

The Buck-Bean, Menyanthes trifoliata (*W. O., Farnham*).—This is one of the most lovely of our native plants. It grows in marshy places, and is very plentiful in Britain, producing an abundance of its white-bearded rose-coloured blossoms in May and June. The whole plant is intensely bitter and somewhat nauseous, and its bitter properties depend on a principle called *menyanthin*, which has a pure bitter taste, is soluble in alcohol and water, but not in pure ether, and is chemically neutral. Besides its bitter properties, which are equal to those of *Gentian*, it possesses also cathartic properties, and in large doses acts as an emetic. It is a cheap and very valuable medicine, and ought to be more generally used. In a scarcity of Hops this plant is used in the north of Europe to give a bitter to the beer, 2 ozs. supplying the place of a pound of hops. Some people smoke the leaves. *Villarsia* (*Limnanthemum*) *nymphæoides*, also a native of this country, has the same properties.

Destroying Gooseberry Caterpillars (*M. N.*).—The communication to which you refer appeared on page 317, vol. xxxviii., and the substance of it was as follows:—"I commenced using Fir-tree oil at the end of May or beginning of June, half a pint of the oil mixed with 2½ gallons of soft water. The trees at the time were much infested with the caterpillars; one-half of them I syringed with this mixture, and the other half I watered with hellebore tea out of a common watering can with a fine rose. The caterpillars on the whole of the trees disappeared in a day or two, but within a month they reappeared on the trees that had been syringed with the Fir-tree oil, whilst those that had been watered with the hellebore tea were left untouched for the remainder of the year. I destroyed the caterpillars again with the Fir-tree oil, but they reappeared in August."

Lathræa squamaria (*C. C.*).—The plant of which you send specimen is a member of the Broom Rape family, *Orobanchaceæ*, and bears the name of *Lathræa squamaria*. It is a perennial, and somewhat parasitical in habit, being usually found at the roots of trees, especially Hazel and Elms, but we once had a quantity of it amongst some common Laurels. You will scarcely succeed in cultivating it except by chance, as it seems to display a peculiar partiality for particular places. Its common name is Toothwort, which refers to the virtue it was at one time supposed to possess of curing toothache. The specific name indicates the scalliness of the plant generally.

Syringing Vines (*F. J.*).—We do not syringe our Vines after they have fairly started into growth, except once after the fruit is set to cleanse the foliage, and again once or twice after thinning and before colouring for the same purpose. We have no means of knowing whether you can keep your Vines free from red spider without syringing. Some persons can and others cannot, and there is no doubt that the insects are much more numerous in some districts than in others. Frequent syringing with water containing lime is injurious.

Substituting Gravel for Grass amongst Shrubs (*W. Dumbell*).—The gravel amongst the shrubs will not be nearly so effective as grass, and the grass would be far more favourable to the growth of the trees than gravel. We have, however, seen Yews and Hollies thriving well with a slight covering of gravel around them, they being kept to formal shapes by cutting. In your case we should remove the shrubs altogether were gravel decided on, and if the shrubs are retained keep the grass.

Vines Scorched by Ammonia Vapour (*J. M. B.*).—A dressing of night soil an inch deep on an inside border is excessive. No wonder every leaf was burnt and scorched. You did well to remove the bunches promptly, and instead of planting young Vines we should cut the present year's shoots back to an eye or at most two from their base, and they will start again freely in a short time, making a vigorous growth, as the roots will be active. With proper care there is every prospect of the Vines making and ripening a good growth, and giving satisfactory crops another season, as there are few plants possessing such strong recuperative powers as the Vine. The Vines being only two years old are likely to give better results than fresh canes.

Pruning Raspberries (*W. X.*).—It is very advisable to encourage the production of good fruiting canes rather than to seek a crop of fruit the first year. Shorten the recently planted canes to within a foot from the ground, and mulch over the roots with good manure. If the young growths which issue are numerous, thin them when a few inches high, not leaving more than four or five to each stool. The shortened canes may produce a few clusters of fruit, which may be permitted to ripen, as they will not materially affect the new growths, which will then be well advanced and growing vigorously.

Peaches Falling in First Swelling (*A Subscriber for Many Years*).—The cause of the fruit not swelling is imperfect ripening of the wood in the previous season. It is not unusual for trees in this condition to blossom and even set the fruit freely; but the fruits remain stationary for about a fortnight, and then more than two-thirds fall. This is indeed a very common case, often attributed to imperfect fertilisation, but is really imperfect organisation of the blossoms—a consequence of the non-ripening of the wood and the imperfectly formed fruit buds. "The trees being in excellent health, making plenty of good wood and healthy foliage," warrant our attributing the non-swelling of the fruit to the above cause. Syringing whilst the trees were in blossom is not in any case advisable, more especially in an unheated house. They should have been kept dry, and air freely admitted whenever the weather was favourable. It is usual for the corolla to adhere to the fruit for some time after setting, being cast as the fruit swells. We should ventilate freely when the weather permits, thereby insuring a sturdy well-solidified growth; and by early closing raise the temperature to 80° or 85° after the fruit is gathered, along with a somewhat dry condition of the atmosphere, and toward evening admit a little air by both top and front lights, so as to cause a circulation of air through the

house, which will cool the atmosphere gradually and insure rest for the trees at night. This will undoubtedly insure the ripening of the wood. The result can hardly fail to be satisfactory another season.

Leucadendron argenteum (*J. C.*).—Your plant is a native of the Cape of Good Hope, and a relative of the *Proteas*, under which generic name it has been described by several authors. By the Dutch colonists it was called *Witteboom* or *Silver Tree*, and was much used for firewood. It has also been largely planted, and has become comparatively scarce in a wild state. In this country it has been cultivated for about 180 years, so that it is by no means a novelty. Greenhouse treatment suits it very well, employing a compost of peat, sand, and light turfy loam, supplying water carefully. You will find a coloured figure of the plant in the "Botanical Register," plate 979, vol. xii., 1826.

Maidenhair Fern—Cyclamens and Primulas (*Amateur, D. P.*).—The two first of these you may succeed in keeping in a room; but the last, if you have the single forms of *Primula sinensis*, will probably soon lose their leaves after flowering. The *Primula* is usually treated as an annual, and it is necessary to sow seed now for a fresh supply of plants another season, though your best plan will be to purchase the plants. The Maidenhair Fern should have a cool light position in the room, not too near the fire nor exposed to the sun. Water it carefully, never allowing the soil to become dust-dry nor excessively wet. Observe if the water passes into the saucer freely, as that indicates whether the drainage in the pot is satisfactory. If there is any stagnation turn the plant out, and re-arrange the pieces of pots, or place some fresh ones in. The *Cyclamen*, which you say has now lost its leaves, can be kept dry for a few weeks, then give a little water, and when growth is commencing increase the supply.

Carbolic Acid v. Weeds (*Inquirer, Armagh*).—Mr. Luckhurst, who has had much experience in destroying weeds in the manner suggested, has stated in our columns that half a pint of the acid diluted with a gallon of water destroys strong weeds of two or three years' growth, and a third less acid to the same quantity of water is sufficiently powerful for small weeds. The water is first placed in a garden can with a fine rose, the acid measured and poured into it. No stirring or further mixing is requisite, but it is immediately poured over the weeds through the rose, care being taken to make the entire surface of the path wet in order to destroy the weeds. A gallon of water with the acid will do 9 square yards of path. This will enable anyone to make a clear computation of the quantity of acid required to do a given area. Care must be taken not to let the acid touch the hands, clothes, or boots. You had better not use the acid for destroying weeds on land that has to be afterwards cropped, as sufficient to kill the weeds would also prevent the growth of the crops you might desire to cultivate.

Striking Cuttings of Tuberous-rooted Begonias (*Inquirer*).—Fill a third of the cutting pot with pieces of broken pots, over which pure soil consisting of equal parts of leaf soil and silver sand, with a layer of peat sand on the surface, made level and pressed lightly down about an inch below the rim of the pot. In this insert stout cuttings 2 or 3 inches in length, made in the usual fashion by trimming off one or two of the lower leaves and cutting off the bottom close under a joint. Press the sand about the cuttings, water well, and place the pot in a brisk lively temperature of 70° or 80°. Shade from the sun, and in a few days the cuttings will emit roots, and should be sufficiently forward for potting in a fortnight. Such cuttings grow so readily and freely that we are somewhat at a loss to account for your failure. It might arise from the insertion of cuttings taken from plants growing in a high temperature in cold sodden soil, by exposure to cold cutting air in transit to a hotbed, by placing them in too low a temperature, or by taking the cuttings from plants growing in a much lower temperature—say 15° or 20°—than that which we advised for the cuttings.

Names of Plants (*A. P.*).—*Doronicum pardalianches*. (*J. H.*).—1, *Davallia elegans dissecta*; 2, *Alonsoa incisa*; 3, a variety of *Polyanthus*; 4, *Omphalodes verna*. (*J. C.*).—*Leucadendron argenteum*; see reply above. (*W. R.*).—*Maxillaria* (*Bifrenaria*) *Harrisonæ*, a very fine variety of a handsome Orchid. (*C. C.*).—*Lathræa squamaria*; see reply above. (*G. Y.*).—We have repeatedly stated that we do not undertake to name varieties of florists' flowers, and the *Azalea* you sent were, moreover, completely crushed owing to their being packed in so slight a box. (*Sheffield*).—1, *Chorozema cordatum*; 2, *Cuphea platycentra*; 3, *Eupatorium odoratum*; 4, *Eriostemon scabrum*.

COVENT GARDEN MARKET.—APRIL 18TH.

A BETTER trade during the week, with prices firmer.

FRUIT.

	s.	d.	s.	d.		s.	d.	s.	d.
Apples.....	½	sieve	2	0 to 7 0	Grapes	lb.	5	0 to 12 0	
"	per	barrel	20	0 40 0	Lemons.....	case	10	0 20 0	
Apricots.....	doz.		0	0 0 0	New Grapes ...	lb.	8	0 12 0	
Cherries.....	½	sieve	0	0 0 0	Nectarines..	dozen	0	0 0 0	
Chestnuts.....	bushel		10	0 12 0	Oranges	100	6	0 10 0	
Currants, Black..	½	sieve	0	0 0 0	Peaches	dozen	0	0 0 0	
" Red....	½	sieve	0	0 0 0	Pears, kitchen ..	dozen	1	0 2 0	
Figs.....	dozen		0	0 0 0	" dessert.....	dozen	1	0 2 0	
Filberts.....	lb.		0	0 0 0	Pine Apples, English	lb.	1	6 2 0	
Cobs.....	100	lb.	0	0 0 0	Raspberries.....	lb.	0	0 0 0	
Gooseberries	½	sieve	0	0 0 0	Strawberries ...	oz.	0	6 0 9	

VEGETABLES.

	s.	d.	s.	d.		s.	d.	s.	d.
Artichokes.....	dozen		2	0 to 4 0	Lettuces	dozen	1	3 to 2 0	
Asparagus, English	bundle		12	0 0 0	Mushrooms	punnet	1	0 1 6	
Asparagus, French	bundle		25	0 30 0	Mustard & Cress ..	punnet	0	2 0 3	
Beans, Kidney	100		2	0 0 0	Onions.....	bushel	2	6 3 6	
Beet, Red.....	dozen		1	0 2 0	Parsley.....	doz. bunches	6	0 8 0	
Broccoli.....	bundle		0	9 1 6	Parsnips.....	dozen	1	0 2 0	
Brussels Sprouts..	½	sieve	1	6 2 0	Peas	quart	0	0 0 0	
Cabbage.....	dozen		0	6 1 0	Potatoes.....	cwt.	6	0 10 0	
Capicums.....	100		1	6 2 0	" Kidney.....	cwt.	6	0 10 0	
Carrots	bunch		0	4 0 0	Radishes....	doz. bunches	1	0 0 0	
Canflowers.....	dozen		2	0 3 0	Rhubarb.....	bundle	0	4 0 0	
Celery	bundle		1	6 2 0	Salsafy.....	bundle	1	0 0 0	
Coleworts.....	doz. bunches		2	0 4 6	Scorzoneræ	bundle	1	6 0 0	
Cucumbers.....	each		4	0 8	Seakale.....	basket	1	0 2 0	
Endive.....	dozen		1	0 2 0	Shallots.....	lb.	0	3 0 0	
Fennel.....	bunch		0	3 0 0	Spinach.....	bushel	5	0 6 0	
Herbs	bunch		0	2 0 0	Tomatoes.....	lb.	1	6 2 6	
Leeks.....	bunch		0	3 0 4	Turnips.....	bunch	0	2 0 8	



POULTRY AND PIGEON CHRONICLE.

PLOUGHING-IN OR FEEDING GREEN CROPS.

No one, we expect, will doubt the value of green crops in our farming practice; they may, however, differ as to the mode of utilising them. A very old practice was to plough them under the soil as a method of manuring it. This plan has, however, but few advocates at the present time from various causes by which the home farmer may be surrounded, one of which is the necessity of providing green food for the sheep stock and forage for soiling cattle, horses, &c., at the homestead. But we wish to call particular attention to one fact—namely, that in every case the object is of manuring the land with the whole growth ploughed in, or by the residue after consumption, which is one of the chief benefits to be derived from the cultivation of green crops, excepting where roots, forage, or vegetables are sold off for consumption in the towns.

Although this subject at first sight may appear a limited matter, it is, however, when fully considered as a practical agricultural question in connection with different soils and climates as well as positions an extremely wide, important, and interesting one in all its bearings. To do justice to it and carry out our objects and intentions we shall have to inquire into and make use of the chemistry of agriculture in reference to the chemistry of plants, in order that we may understand how the death and decay of one genus of vegetation will contribute to the profitable growth of cereals and other crops grown for profit by the farmer.

In the Journal of the Royal Agricultural Society of England we have several essays relating to ploughing in green and root crops for manure, one of the best being from the pen of Mr. Peter Love in the year 1868, and in relating his own experience he gives information of a valuable kind for the study of the home farmer. He says, "I remember that it was pretty generally recognised among intelligent farmers that the ploughing-in of 18 tons of Turnips per acre, after being crushed by a clod-crusher, gave 12 bushels more of Barley per acre than if the said Turnips had been first passed through the animal and the elements to form mutton and wool extracted. It is also pretty certain that a ton of Turnips will produce 14 lbs. of mutton and about 1 lb. of wool; but the outlay on sheep, risk of losses, and cost of attendance must be taken into account."

This is a part of the question of immense importance at the present time, for there are so many farms untenanted, and the cost of cropping and stocking of the land which may come to hand on an estate, is a serious question for consideration by the home farmer, and any plan of cultivation and cropping, stocking, &c., which will require the least investment of capital without reducing profits must be extremely desirable, especially under the circumstances of the proprietors being persons of limited means or capital. It is, therefore, our intention and endeavour to treat our subject, keeping steadily in view economical investments and full profits.

We again quote from Mr. Love's essay upon a very important point of cultivation, the best and cheapest mode of cleaning strong land foul with couch or water-grass. He says:—"The results obtained by ploughing-in Turnips in 1842 induced me to try White Mustard in 1843 on a small field of 8 acres. Soil a stiff clay upon blue lias clay subsoil, as foul with twitch as

possible. It was ploughed about 7 inches deep in the winter, then scarified with broadshares about 3 inches deep the last week in March, and after being well harrowed sown with White Mustard seed by a broadcast seed-barrow at the rate of a bushel to 3 acres, covered in by very light sced-harrows. This crop was just coming into bloom the last week in May, and 26 inches high, when it was ploughed in about 4 inches deep, and 100 bushels of lime (after being slaked with salt water) applied per acre; then after one turn of the Norwegian harrow resown with Mustard, care being taken that all ploughed in within the day should be resown on the same day as it was ploughed. All was finished on the last day of May. On the 8th of July we began ploughing in 6 inches deep this second crop, which was above 46 inches high. We used the drag weight and chain to lap the whole under the furrow; immediately after ploughing we gave one turn of the Norwegian harrow, then resowed the Mustard as before. The whole field was finished on the 12th of July. The third crop was just breaking into bloom on the 24th of August, and the length above 5 feet. This was ploughed in 8 inches deep with four horses at length, followed by a two-ringed presser following only one plough, thereby giving each furrow a double press. After one turn of the Norwegian harrow the land was left to settle down for the future Wheat crop. As for the couch-grass, except a few blades in the first crop of Mustard, we saw no more of it except the rotten roots as we were ploughing in the last crop. Wheat was sown on this land in October. The produce at harvest was all that could be desired, and the land perfectly clean. After one 8-inch ploughing, and a shallow scarifying in the following March, it was drilled with White Oats and Clover seeds. The crop of Oats was magnificent, and in some parts injured the seeds.

"During the succeeding seven years of my occupation of this farm, if I had to deal with any piece of very foul strong land I cleaned it in this way. The application of 1 cwt. of nitrate of soda to the first crop of Mustard will almost double it, and of course much increase the two following crops, as well as their power to smother the twitch and other weeds." The cost of this is given in contrast with a bare fallow, which Sir J. B. Lawes tells us loses much fertility during tillage.

	£ s. d.
Cost of an acre of bare fallow manured with 20 tons of farmyard manure	8 2 0
An acre producing three crops of White Mustard and ploughed in with 1 cwt. nitrate of soda and seed, &c.	5 3 0
Saved by this system	£2 19 0

Trifolium, Vetches, Trefoil, &c., or any forward crop, such as Rye, may also be grown as a first crop, and after being fed off by sheep two crops of Mustard to be grown afterwards may still be obtained, and eaten off or ploughed-in the same season. Mr. Love again says: "Now I venture to affirm that the foulest and poorest possible piece of strong land (sand land excepted) may be cleaned by growing white Mustard with 1 cwt. of nitrate of soda per acre applied to the first crop, and three crops in succession ploughed in, let the season be either wet or dry. The soil will be left as capable of bearing a crop as if 20 tons of farmyard manure had been applied to a bare fallow." Now whether sandy land can be cleaned in this way may be doubtful, but it is well known that all fen or peat, light gravel or loam, and all clays can. Mr. Love also says: "When land is partially cleaned in the autumn it may be perfectly cleaned and manured by growing three crops of Mustard to be folded. An acre will then keep an average of twenty sheep for fifteen weeks, which will give a result as follows: ;

	WHITE MUSTARD.—Dr.	£ s. d.
Cost of autumn cultivation		1 0 0
Ditto as above for three crops		5 3 0
Total cost of cultivation, &c.		£6 3 0

CONTRA.—Cr.

Twenty sheep kept fifteen weeks, at 4d. a week each..	£	s.	d.
Value of excreta left	2	10 0
Gross return..	£	7	10 0
Cost of cultivation..	6	3 0
Leaving to meet rent and taxes a balance of					£	1	7 0

This account by Mr. Love will of course differ under certain circumstances, which are ever changing. We introduce it, and ask the home farmer to make his own calculations; and he will notice that only rent and taxes are spoken of, but it is necessary for a fair calculation to include tithes, also interest on capital, value of sheep, risk of losses, cost of attendance, implements connected with folding, and other items. Again, in making a fair comparison of the cultivation when green crops are fed by sheep, the process of folding is a slow operation, and impedes—in fact prevents—the regular ploughing and seeding as compared with ploughing in the crop; for in that case the work of ploughing and re-sowing is so continuous and done simultaneously that the weather, should it be wet or dry, offers little or no impediment: but this is not the case when folding with sheep, for in dry weather the land would be too hard and work roughly, and in wet weather it would be trodden into a cold state and work unkindly. Even if the weather did not interfere, the daily folding of sheep would make patchwork of the land, and really prevent any simultaneous re-seeding of the crops. Mr. Love, in his statement of the case as between ploughing-in green crops and feeding them by sheep, has made no allowance for the difference of after crops; for in case we were to allow that the next crop would be equal in both cases (which we are not justified in doing), still the second and third crops of corn, &c., after feeding would not compare with the magnificent crop of white Oats before alluded to, for the sheepfold does not yield a lasting manure like green crops ploughed in.

(To be continued.)

WORK ON THE HOME FARM.

Horse Labour.—This is now the busiest period of the year for the horses, and especially as the weather has lately been so favourable not only for the seed-time, but also for making fallows and cleaning the land from couch, &c., which has accumulated upon many farms, and especially those on which there has recently occurred a change of tenancy, which has been in a great measure caused by a succession of unfavourable seasons for fallowing. We must also call the attention of the home farmer to the policy of preparing for a dry season, inasmuch that in the course of nature the wet seasons having now prevailed for a period of eight years, we must expect that as nature is got into our debt we shall ere long be repaid by a dry season, and probably more than one. It is therefore recommended that as fast as the land is ploughed it should be worked fine—the sooner the better, if not simultaneously—whether it is ploughed for seeding with Lent Corn or Mangolds, Potatoes, or even early Turnips, Carrots, Kohl Rabi, and Cabbage. Where it is usual to retain a portion of the Swede Turnip crop for feeding during the present and following month, it is important that they may be kept in good condition as food for sheep or cattle. For we recollect having made a serious mistake many years ago by pulling the roots to prevent their throwing up seed stems and flowers, and thus depreciate the feeding value of the bulbs; but at that time the dry weather continued so long through April and also far into the greater part of the May month that the roots became so dry, shrivelled, and tough that the sheep disliked them, and that they could not be cut with the Turnip cutter or slicer, being so hard, which caused us great inconvenience before they could be consumed. This circumstance taught us the lesson of not trusting the weather either in a dry or a wet time, and ever after when we required to hold Swedish Turnips for feeding on the land we crowned them down by cutting off the stems and greens close to the bulb, and in this way by remaining in the land they could not then sprout or throw up any greens, and thus they maintained their feeding value until a late date, for we frequently fed them off by sheep by cutting with Gardner’s cutter, and feeding in troughs as late as the end of June and first week in July. With respect to the preparation of land for Carrots, we know many farmers who say, Sow early in March. We say, Sow the first or second week in May, as this saves at least one hoeing if not sown upon a stale fallow, for we prefer to drill the seed after one ploughing, as the best and heaviest crop we ever grew was after Trifolium cut up, and the land ploughed, worked, and seeded the same day. This we have done with great success up to the 20th of May, or it can be done after a crop of Rye cleared off early, and this plan has the advantage of the seed getting a fair start with the weeds, which are not nearly so troublesome as when seeded early on a stale surface. The seeding of Clover if it has not been done at the time of sowing the Lent corn should now be effected, and we prefer before all other plans to seed the Wheat land, which was grown after Potatoes or roots fed off, and we have found the Clover take well in this way by seeding with Bennett’s seed barrow on the

surface, and then work the surface fine with the new pointed chain harrow, and after the frosts we have late experienced the surface will work very fine and effectually bury the seed, but leaving the land rolled to finish the work.

Hand Labour.—This still consists of work connected with timber-cutting if there is a fall of timber on the estate this year, setting up bark, tying and preparing the lop and tops of the trees for removal as faggots and cord wood. Some men will be employed in connection with seeding the Clover, sowing artificial corn manure on the surface of Wheat land, which could not be dunged in the autumn owing to the wet state of the land. Women will be employed in planting Potatoes, and weeding; for the latter we do not approve of the use of the ordinary spud, which only cuts off the tops or crowns of deep-rooted weeds like docks or thistles, and these spring up. We therefore furnish a small pickaxe, with a point at one end and a cutting edge 2 inches wide at the other. In this way the deep-rooted weeds are lifted out, and the annuals cut off at the surface of the land.

Live Stock.—As this is the time when a large number of calves are dropped and the weaning of them either for fattening or as heifers to come into the dairy, it is of importance not only as to their food and the rearing and accommodation for them, but as we have frequently stated our method of young calves it is not our intention to say more upon it now. There is, however, an idea started, which has lately attracted some attention, and most deservedly so, that of non-castration of bull calves when intended for sale as beef at two years old or younger. We have frequently noticed that two bull calves of the same age and quality, particularly of Shorthorns or Herefords, the one steered and the other not castrated, and we have found that the bull, although fed in the same way as the steer and kept under cover tethered in stall, would make at two years old or under much the heavier bullock—in fact it would yield from 15 to 20 per cent. more beef than the steer. This plan of castration has been carried out in consequence of the beef being of the best, and that bull beef is far inferior; and that is the case if the animal is allowed to arrive at maturity and be used for stock or stud purposes. It is, however, quite another matter when young animals are fed for the shambles only, and sold for beef at two years old or under and fed upon the same plan; and it is said with truth that the beef, if really well fattened, has proved equally valuable to the butcher and consumer whether the animals were castrated or otherwise. Now this is a very important consideration in several respects, for castration, especially if not performed at the right time and in a proper manner, has a serious effect upon the growth and well-doing of the steer, whereas the young bull may continue to thrive well without loss.

OUR LETTER BOX.

Preserving Mushrooms (X. R.).—Wipe them quite clean, take out the brown, pare off the skin of the large ones, lay them on paper, and put them in a cool oven to dry. Keep them in paper bags in a very dry place. When wanted for use simmer them in gravy, and they will swell to nearly their former size; or you may simmer them in their own liquor till it dries up in them, shaking the pan; then dry them on tin plates, with spice or not as you think proper. Tie down with a bladder or keep them in a dry place or in paper.

METEOROLOGICAL OBSERVATIONS.

CAMDEN SQUARE, LONDON.

Lat. 51° 32' 40" N.; Long. 0° 8' 0" W.; Altitude, 111 feet.

DATE.	9 A.M.					IN THE DAY.				Rain
	Barometer at Sea Level	Hygrometer.		Direction of Wind.	Temp. of Soil at 1 foot.	Shade Temperature.		Radiation Temperature.		
Dry.		Wet.	Max.			Min.	In sun.	On grass.	In.	
1883.										
April.										
Sun. 8	30.567	45.5	41.0	N.E.	45.1	57.7	35.8	95.2	34.5	—
Mon. 9	30.448	45.0	40.7	N.	45.2	60.5	29.3	84.5	25.8	—
Tues. 10	30.423	45.3	39.3	N.	44.8	55.4	39.6	101.7	35.6	—
Wed. 11	30.390	41.7	38.8	N.W.	44.7	59.4	32.9	90.3	32.4	—
Thurs. 12	30.223	46.2	44.4	N.	44.9	60.3	38.7	109.8	35.3	—
Friday 13	29.936	43.5	40.3	S.W.	45.2	49.4	40.2	58.7	39.0	—
Satur. 14	29.879	44.6	43.1	N.W.	45.6	52.7	40.3	63.4	37.0	—
	3.267	44.3	41.1		45.1	56.5	36.6	86.5	34.2	—

REMARKS.

- 8th.—Fine and bright, with cold wind.
 - 9th.—Fine, bright, and cold; hazy in evening.
 - 10th.—Fine and cold.
 - 11th.—Bright in morning; afternoon dull, but warm.
 - 12th.—Fine, with much bright sunshine.
 - 13th.—Cooler, and very dull.
 - 14th.—Gloomy, with slight fog.
- April continues absolutely rainless, with high barometric pressure and large range of daily temperature. The dullness of some days has prevented the maxima being as high in this as in the previous week, but they continue above the average and the minima continue below their average, the daily range being still very nearly 20°.—G. J. SYMONS.



26th	TH	Royal Society at 4.30 P.M.
27th	F	Quekett Club at 8 P.M.
28th	S	Royal Botanic Society at 3.45 P.M.
29th	SUN	ROGATION SUNDAY.
30th	M	
1st	TU	
2nd	W	Rochdale Auricula Show.

BELGIAN AND ENGLISH LEAF SOIL.

NEARLY everyone who receives such plants as Camellias and Azaleas from Belgium is more or less surprised by the luxuriance of their growth and the great masses of healthy roots that crowd the soil in the pots. This is obviously a mixture of leaf soil and sand chiefly. Sometimes there may be a little peat and a suspicion of light loam, but decayed leaves form the basis of the compost; and that it is well adapted to the requirements of those plants with many others, none can dispute who has seen the quick and admirable manner in which they are grown. It is equally evident, too, to persons who endeavour to imitate the compost in which the plants arrive, and use leaf soil principally in repotting them, that they no longer flourish as they did before, however carefully they may have been tended in other respects, such as watering, assigning them positions, and placing them under conditions the most favourable for their well-being. The fault rests in the soil, and the conclusion is arrived at that Belgian and English leaf soil are essentially different in their constituents; but in what particular respect they differ, and why the foreign product is so good and the English so inferior, has not yet been made so plain as is desirable to cultivators in this country. Although I am not quite certain I can make a matter perfectly clear that is as yet obscure, something may perhaps be said that will lead to the subject being better understood, and without question much more valuable leaf soil may be obtained in England than that which is commonly used.

Some gardeners have become so dissatisfied with leaf soil that they have relinquished its use in plant culture, considering it worthless. The material at their disposal may have been worthless, just as bad bread may be even worse than useless; but neither true bread nor true leaf soil merits such an opprobrious designation. The truth of the matter appears to be this, that Nature makes good leaf soil, but man by his method of preparing it spoils it. That is rather a bold statement, but I am prepared to prove its accuracy.

First, however, it may be well to glance at the nature of leaf soil. It may be described under the term "humus." Those gardeners who denounce this matter as useless may have a certain amount of supporting testimony from some agricultural chemists. Even Liebig has written disparagingly of humus, and only considered it useful, if useful at all, in the earliest stage of a plant's growth; but if all the scientific persons in the world were to demonstrate the absence

of fertilising constituents in leaf soil, I should with all due respect decidedly prefer the evidence of the magnificent Azaleas I saw at Ghent last week. These are not young plants in the first flush of youthful vigour; on the contrary, many of them may be described as matured trees, yet the "food for young plants" sustains them in a manner in which the best specimens grown in English peat cannot be properly placed in comparison. So far from leaf soil possessing little or no value, it is the very foundation of the success of the Belgian cultivators, and has more than anything else contributed to their prosperity and the world-wide fame of their establishments. Leaf soil, then, or humus is decayed vegetable fibre, that undoubtedly contains fertilising properties, because amongst other things it slowly and steadily generates carbonic acid, and in addition it possesses a greater power of absorbing water than any other kind of soil, a circumstance of no small value for cultural purposes.

It is very desirable that a clear conception of the nature of humus be understood, and, so far as I know, the subject has nowhere been so thoroughly, fairly, and exhaustively discussed as in a series of remarkable articles in the last volume of this Journal by an accomplished gentleman whose death was announced last week—Major-General Scott, C.B., F.R.S. The results of that searching examination of the subject was summarised as follows:—Humus is valuable, because "1, as an absorbent of moisture, which materially increases the fruitfulness of a soil; 2, by attracting and physically fixing ammonia, which would otherwise be washed away; 3, by chemically fixing ammonia by the aid of the acids which are generated as its decomposition proceeds; 4, by providing a long-continued, if feeble, supply of carbonic acid, which helps to distribute the phosphates, &c., which are imperfectly disseminated through a soil; 5, by assisting, through the disintegrating influence of the carbonic acid which it generates, in breaking down hard insoluble substances containing potash and silicic acid, &c.; 6, by supplying carbonic acid to bring about the transference into the organism of the plant of the food with which the rootlets come into contact."

Having shown the value of humus—leaf soil, its preparation next demands attention. This is a matter of infinitely greater importance than the majority of cultivators conceive. For years I have been endeavouring to find out the essential difference between Belgian and English leaf soil, and at length after several visits to Belgium I have succeeded in my object. Two or three years ago, in a conversation on leaf soil and Azaleas with Mr. Barron at Chiswick, he observed, "Leaves for leaf mould should never be heated." That remark was not lost. As soon as possible Azaleas and Camellias that had been struggling for life in prepared—that is, spoiled leaf soil, were potted in some that Nature had made—that is, where the leaves had decayed, not fermented. The result was almost magical, and a new lease of life was given to the plants, which commenced rooting in the fresh compost in the most satisfactory manner, the leaves in both cases having been gathered from the same trees. Quite recently I have had the pleasure of discussing this subject with one of the most experienced of Belgian horticulturists—Mr. Van Geert of Antwerp, and he not only urged the absolute necessity of using naturally decayed, not fermented, leaves in the form of soil, but alluded to

other matters in connection with this subject that are worthy of record. I am particular in acknowledging my indebtedness for information, because I know nothing more unfair, nothing more regrettable than the practice that exists of appropriating information in a clandestine manner in the manufacture of articles founded on the experience of others and passing them off, in whatever form and under whatever guise, as the genuine productions of the operator.

To resume. For comprehending the relative differences between the two kinds of leaf soil alluded to, it is necessary that the full import of the terms employed—"decay" and "fermentation"—be clearly understood; for although the mechanical results of both are the same—decomposition, yet there is a great chemical difference attending the two processes of reducing leaves to soil. During the heating or fermentation of leaves in large heaps, acids and gases are formed in the absence of oxygen that are inimical to plant-growth either positively so by their nature or practically so by the excess in which they are presented, this excess being most indubitably injurious. Decay without fermentation is a steady process of oxidation, different from putrefaction, being dependent on the presence of oxygen or air. It is this that gives the brown colour to the mass similar to that produced by scorching by fire. This is true leaf soil—humus, in its best form for the use of plants, and it can be obtained from the surface of the ground in Oak and Beech woods as well in one country as another.

Mr. Van Geert mentioned to me a fact which at the moment I thought singular—that leaf soil the produce of trees grown on sandy land is very much superior to that obtained where the trees grow in deep rich ground; and not only so, but the quantity is much greater in the former case than the latter. Leaves that fall from trees on rich land quickly decay to what may be termed the vanishing point; but leaves falling on poor sandy land decompose slowly, and leave a residue of valuable brown vegetable matter perfectly sweet and of considerable fertilising power. The reason for the difference noted may be twofold. First, a sandy soil is usually dry and water passes from the surface freely, hence the decay of the leaves would naturally be less rapid than if resting on a saturated base. Secondly, trees grown on poor sandy or thin gravelly land contain more ligneous fibre, are less "sappy" and closer in the grain than trees are on richer soil; and the leaves also doubtless vary in the same way, those grown on sandy soil containing more fibre than the more succulent foliage of luxuriant trees. However, whatever the cause of the difference in the quality and quantity of the decayed matter, the facts of the case are worth recording.

Mr. Van Geert further stated, and the hint may be useful to collectors of vegetable matter from plantations, that leaf soil taken from ditches or hollows where it naturally accumulates in large quantities is very inferior to that gathered on the level surface where it has been fully exposed to the air. Leaf soil, then, should never be taken from ditches, as some of it there found is worthless, if not worse than that—injurious.

Just one other hint of the excellent horticulturist, and this, too, a little curious. It is this. If there are any old hollow pollarded Willows which have stood for generations the vegetable matter enclosed in their shells is the best of all leaf soil, and should be pre-

served for any choice plants that it is desired to grow quickly, or for restoring to health any that are in a sickly condition.

This is the teaching of a gentleman whose long experience and great success entitles him to be listened to with respect, and the condition of his plants in his small Antwerp nursery—from the Azaleas and Camellias to the magnificent Palms *Corypha australis* and *Latania borbonica*, that were not surpassed at Ghent, to the beautiful Bays, and the general stock in his larger establishment at Calmpthout—shows that he practises more than he preaches, and this is more than can be said of everybody now-a-days at home or abroad. I thank Mr. Van Geert for his hints on leaf soil, which will be of service to many readers. Perhaps on another occasion I may refer to the Belgian method of growing Azaleas.—J. WRIGHT.

PROFITABLE POTATO-GROWING.

ABOUT two years ago a Committee of the House of Commons sat for some time to inquire how the great losses to this country by the Potato disease could be prevented, or, if not prevented, considerably reduced. They examined a great number of witnesses both scientific and practical, collected together a large body of evidence, and published a report with certain recommendations; but since then nothing has been done, and I fear unless public attention is drawn to the matter the subject will drop out of sight altogether. That would be a pity. The successful growth of the Potato is an important question for this country. Potatoes form a considerable portion of the food of the people, and, as I say in my book on the Potato disease, they are a crop which we ought to be able to grow in this country as well or better than they can be produced in any other, but we must set about it in the right way and make the best use of our opportunities.

There is no doubt our losses have been much less since the introduction of what are called disease-resisting Potatoes. It is possible, as I before remarked, with care and confining your growth to one or two Potatoes to escape loss by the disease altogether, but we very much want some more disease-resisting Potatoes, particularly one which would come in about the same time as the Early Rose. The Potato-crop Committee recommend the establishment of several stations in different parts of the country to grow new varieties of the Potato and make experiments, &c. There is no need for this. It would cost a considerable sum of money, and I think the end in view would be more readily obtained by offering a few £100 prizes for the class of Potatoes required. I think we should soon have them. I would offer £100 for the best early disease-resisting Potato, and £50 for the second; £100 for a second early to come in about the same time as Early Rose, and £50 for the second; £100 for a late round, and £50 for the second; and £100 for a late kidney-shaped, and £50 for the second. All these to be for seedling Potatoes not in commerce, to resist the disease well, and to be of fair quality. In addition to this I would offer £200 for a Potato which would entirely resist the disease. I thought I had found the philosopher's stone, for I have one which I grew for five years entirely free from the malady, but alas! this spring I found one diseased tuber.

Raising seedling Potatoes is an interesting amusement to those fond of gardening. The seeds are sown on a cool hot-bed in spring (now is a very good time), and when the seedlings are 3 or 4 inches high they are transplanted to the open ground at the end of May or beginning of June, and well earthed up whilst growing. The produce varies very much. Sometimes you have a dozen or more tubers under a root nearly large enough for cooking; at another time disease takes the young plants before they have made much growth, and then the young Potatoes are only about as large as peas.

But to return to the original point. Our agricultural affairs are in a very depressed condition, and we want a little assistance from the Government. The Americans are collecting and disseminating information all over their country as to the most

profitable crops to grow and the best way of growing them ; indeed they are straining every nerve to excel us in the growth of agricultural produce, and we, I think, must look a little more to our own interest in that way if we do not wish to be left behind other countries in the race. A Minister of Trade and Agriculture would, I think, be of service to the country at the present time. He would be the proper person to communicate with on the Potato disease subject, but at present there does not appear to be any recognised authority to whom we can write on the subject with any prospect of its being attended to.—FREDK. BRAVENDER, *The Firs, Cirencester.*

THE VALUE OF DRAWING TO YOUNG GARDENERS.

I WILL endeavour to the best of my ability to give "G. A. B." an answer to his question on drawing (page 294). The knowledge of drawing, if not an actual necessity for a gardener, is often very useful. For instance, he may have to lay out a garden—in such a case he would find geometry valuable. In carpet bedding, again, it is almost indispensable. Doubtless such work has been and is done by men who have never studied geometry, but I should say a man with a knowledge of geometry, provided he knows the habit of the plants he is using, would do the work easier than a man with an equal knowledge of plants but not of geometry. He may also want to have a glass house erected. With a knowledge of building construction he would be able to furnish sectional plan and vertical section, which a builder would understand better than if he told him what he wanted. These are only a few of the many cases I could name where drawing is a great help.

I think all young gardeners who live within reach of a science and art school or class should join it. By doing so they have the benefit of a qualified teacher, and of course learn quicker than if they have to teach themselves. They have also the chances of Queen's prizes, certificates, and value of marks in books or instruments. If young men in bothies would join these classes I can assure them they would find it a most useful as well as a healthy way of filling up their long evenings in winter. Let one in a bothy join such, I feel sure he would soon have company.

I will mention some of the inducements offered to students by Government. In the art subjects, which comprise freehand, geometry, perspective, and model drawing, there are two classes of certificates—viz., "Excellent" and "Good." With the former you have a Queen's prize value from 7s. to 15s.—you are allowed to choose your prize. For "Good" you have certificate only. Then, if you send up the work you do at school to be examined you get the value of 1s. 6d. for each mark, awarded in books or instruments of your own choosing. For the science subjects, which are too numerous to mention, there are first and second-class certificates awarded. With a first-class you have a Queen's prize value 7s. 6d. in the elementary stage. There are also marks awarded for school work in some of the science subjects if there is any drawing connected with it.

May I be allowed to mention here that the writer of this in three winters underwent seven examinations, and was awarded six certificates with three Queen's prizes, and with teacher's prizes and marks has upwards of £6 worth of books and instruments? But there are many who are not within reach of these advantages ; but that is no reason why they should remain ignorant of the art subjects at least. To any such I say, Procure Rawle's book on geometry (second grade), 1s., and a corresponding set of class sheets by the same author, 1s. Good instruments are rather expensive. A box of fairly good ones of German make may be bought at a pawnbroker's for 10s. or 12s., but if you want the cheapest buy those of English make, which cost double. Drawing-board and T square cost about 3s. 6d. Set squares, protractors, and scale are generally included in the box. Knight's "Second Grade Perspective," 1s., is very good, as also are Burchett's and Dennis', each 2s. 6d. I think. I have made out rather a large outlay for a young gardener, but remember it is property that does not depreciate much in value.

For freehand and model drawing little expenditure is required. For copies for freehand they have only to look through the pages of the *Journal of Horticulture*. What could they have better than figs. 71 and 72 in the issue beside me? For models many household utensils may be used—circular canisters for cylinders, square ones for prisms, ornaments, chairs, books, buckets, watering cans, flower pots, and plants and flowers that have bold outlines. I should mention a knowledge of the laws of perspective is very useful to anyone drawing from models.

Of the science subjects botany and chemistry are the most useful to a gardener. I have mentioned building construction ; I must mention applied and theoretical mechanics, or the parts of them that treat of water and uses of various kinds of timber and metal. I will give one instance. Suppose he wanted to put up a rod of iron that was to bear a tensional strain. In such a case he would have been taught to use wrought iron and not cast. Suppose the case was the reverse, and the bar had to bear a compressive strain ; then he would use cast in preference, cast iron being six times stronger in compression than in tension.

Anyone who has studied these subjects at home and would like to stand the Government examinations, can do so by giving a few months' notice to a school where there will be an examination held, so that the authorities of the school can apply for papers.—A GARDENER.

PLANTING SEAKALE.

THE time has now arrived for planting Seakale, one of the principal crops in a kitchen garden. In selecting the sets, which should now be starting into growth, great care should be taken not to plant any that are showing the least signs of decay, for these never produce satisfactory crowns. Pieces about the size of a tobacco-pipe stem or a little larger are the best to insure good crowns if properly cared for after planting. Larger sets produce larger crowns, but, when forced, as a rule they throw up a straight flower stalk without any leafstalks.

The ground for Seakale should be well enriched with moderately decayed horse or cow manure, and should be made firm, especially light soils, either by treading or rolling. Plant the sets 1 foot apart in rows about 15 inches asunder. Another method I have found good, especially where the garden is sometimes scarcely adequate to produce a supply of vegetables for the season, is to plant them between rows of Cabbages for pulling for early use before the headed spring Cabbages come in. This system answers admirably, as the Cabbages shelter and keep the soil moist about the young sets, although care must be taken not to tread on the crowns of the sets. Plant every set firmly, and let the crowns be level with the surface—better a little below than above the surface. When large enough the sprouts should all be removed except one, selecting the strongest. No further labour will be required, with the exception of keeping the crop hoed until the foliage covers the ground ; then the less done amongst it the better, as it is not good to damage the foliage.—J. P.

CULTURE OF MELONS.

ON page 271 I remarked that Melons are amenable to various methods of culture, and I now propose to further discuss that part of my subject relating to house culture. According to my experience one of the most frequent causes of failures or partial failures with Melons is a deficiency of bottom heat. This is especially the case where heating material has to be relied upon. In numerous places well-prepared stable manure, or this and leaves added, are made into hotbeds or disposed in pits, and the heat usually lasts long enough to give the plants a good start ; but by the time the crops are near the ripening period the heat has subsided, the beds being in fact much colder than even the night temperature of the house. In some instances a single, or may be two hot-water pipes are either chambered over or are covered with rubble with the motive of maintaining a brisk bottom heat for the Melons ; but the question is, Are they so efficacious as they are supposed to be? I believe not, or at any rate not to so great an extent as generally imagined. If the heating apparatus is well under control—that is to say, if so arranged as to admit of those in charge turning off the top heat in various houses, including the Melon house, so as to direct the heat from the boiler entirely into the bottom-heat pipes, the case might be different. As it is in our case, and in many others, in hot sunny weather the

heat from the top heating pipes is oftentimes unavoidably most injurious, and tending to create an undesirable dry overheated atmosphere, one result being to greatly encourage the ravages of the much-to-be-dreaded red spider, while the lower running bottom-heat pipes may be almost cold owing to the fires being completely stopped. I believe it is this comparative coldness at the roots which most frequently results in the loss of plants by canker, or the collapse of the plant just when the ripening stage is reached. Maintain a good bottom heat, and there is little danger—other conditions being favourable—of either happening, and but little necessity for extra precautions in the shape of guarding against wetting the stems or the soil near the “collars.” The best Melons I have yet cut were treated as far as watering was concerned almost similar to Cucumbers.

What is required is a brisk bottom heat not lower than 70°, and if higher so much the better. We cannot feel assured of this amount of bottom heat, and therefore plant in heaps of soil raised above the level of the ordinary brick pits, and by maintaining a high temperature we benefit the Melons both at the top and at the roots. Where slate benches or wooden stages covered with slates are disposed over the rows of hot water which heat the house, these, as I have proved, are excellent positions for Melon-growing. Slates are good heat-conductors, and the mounds of soil placed on them in a well-heated house seldom if ever become too cold for Melon-growing. Pots for this position are sometimes preferred to heaps of soil. The latter, as a rule, when formed with a rounded upper surface, and rammed as hard as possible—a practice considered imperative by many growers—may easily, and very frequently do, get too dry. Our clayey loam when very dry is not easily moistened again—in fact, ordinary waterings then prove a waste of labour. To obviate this difficulty we for a time tried square heaps of soil with a flat upper surface, and this was certainly a step in the right direction, but we still wasted much water and lost all the outside roots. Subsequently I saw the method adopted at Longleat, and this I decided to imitate in the future.

Mr. Taylor forms square raised pits, over bottom-heat pipes, with loose bricks, these being simply arranged so as to be strong enough to enclose the soil, the corners being “keyed” together—that is to say, each course is disposed so as to interlace at the corners, this also preventing the occurrence of any weak seams. The weight of the bricks insures sufficient solidity, and the arrangement admits of the walls (4½ inches wide) being taken down and rebuilt, so as to leave a space for an addition of fresh soil as well as on the surface. Then, again, the bricks absorb moisture and retain heat, and instead of the outside roots dying they appear to rapidly increase when in contact with the warm moist bricks. With these loose brick walls there is no excuse for overwatering or neglect, as the soil can always be tested to any depth.

At Longleat two plants are grown in a house 27 feet by 16 feet, and frequently one of these is cut away to allow the other to extend. We have not come to this extension system of Mr. Taylor's yet, but where at one time six plants and even twelve plants were grown we are now content to grow three, the third plant in each instance being a variety on trial. Our temporary brick pits are first formed about 31 inches square, or three and a half bricks to each side, no bricks, however, requiring cutting at this size, and they are five bricks in depth. A layer of broken bricks are placed on the grating over the pipes, and the pits are filled to near the surface with roughly chopped turfy loam, to which has been added a dressing of slaked lime. If we wish to plant at once, heated bricks are buried in the soil, these quickly warming it, and when inserted the strong Melon plant has the soil heavily rammed about it, and is at once fastened to a strong stake connected with the trellis. The leading growth is kept carefully trained, all side shoots being rubbed out up to the trellis. The point of the leading growth is taken out when halfway up the trellis, or at a length of 4 feet, and the laterals are thinned out if required so as to have one only for each wire, these being 12 inches apart, and running parallel with the front. The laterals are not allowed to fruit, but are trained to and stopped at about half their allotted length of wire. From this stopping abundance of fertile blooms will result, and a heavy crop easily secured. In most cases, however, we are content with a few fruits—say six to each plant. This number the plants are strong enough to perfect and yet continue to extend both the leading shoot and the leading break of the laterals, these being stopped when near their limits. In this manner, incredible as it may appear to some experienced growers, a continuous supply is maintained from a single plant. This fact is annually demonstrated at Longleat, and it is by no means an uncommon occurrence to see Melons in various stages of growth on the same plant, those fully matured in the case of the

Eastnor Castle variety ranging from 5 lbs. to 8 lbs. each in weight. The loose pits—and which should always be built on a level firm surface where the extension system is adopted—require to be occasionally enlarged and fresh soil added; and this and frequent applications of liquid manure, or light dressings of some kind of artificial manure, coupled with the free uncrowded top growth, maintains the vigour of the plants, and is most conducive to the production of successional crops of fruit of high quality.

If a quick and heavy crop of Melons be required off a limited space, the more common method of disposing the plants 3 feet to 4 feet apart either on isolated mounds or a continuous ridge of soil is to be commended. In this case the upper surface should not be much rounded off; in fact, if turves are available the fronts should be formed with these. A trellis 6 feet deep is sufficient, and the leading growth should be stopped at least 15 inches short of this. The laterals resulting generally prove fruitful, and these should be thinned out where crowded, laid in obliquely, and stopped at the first joint beyond the fruit; and later the sub-laterals may be all rubbed out with the exception of the end one, these being stopped at the first joint. If this stopping and rubbing-out is not closely practised in all cases, the neglect will involve the use of the knife, and, in addition to wasting the energy of the plant, the risk of the loss of the plant is incurred from canker or decay consequent upon excessive bleeding. Large thinly-disposed foliage is as much necessary in the case of Melons as in Grape Vines.

In the case of these closely grown and comparatively weakly plants care should be taken to set as many fruits as possible on each plant at the same time, as they seldom perfect fruits which may have been set a day or two later than the first two or three impregnated. The best time to impregnate the fertile blossoms with the pollen of the male or non-fruiting blossoms is about 11 A.M., or after the house has been ventilated sufficiently long to have well dried the flowers. It is advisable to discontinue syringing till the crops on the different plants are set, but a moist atmosphere created by damping the beds and walls when the house is closed for the day will not interfere with the setting.

We do not shade Melons beyond lightly syringing a little thin lime water over the glass during the prevalence of very bright sunshiny weather. If we can manage it without very hard firing we maintain a night temperature of 70° during the day, 75° to 80° without air, and 85° with air. At this season of the year and onwards not much if any air is required on dull days, unless the bloom requires setting, and in this case it is given early. Cold draughts ought always to be prevented, the aim being to maintain a humid atmosphere and comparatively high temperature, and the better to insure this we close early—say about 2.30 P.M., and syringe freely. Water either for syringing or application to the roots ought never to be below 75°, and the heaps of soil ought to be kept constantly moist, though not saturated, while the fruits are swelling, the supply being reduced and a drier atmosphere being maintained when they are ripening off. I have still other matters to allude to, but for the present must content myself with repeating that the varieties William Tillery, Earl of Beaconsfield, Eastnor Castle, and Hero of Lockinge are grand green-flesh varieties, and Blenheim Orange and Reid's Hybrid are good scarlet-flesh varieties, all being suitable for present sowing.—W. IGGULDEN.

SHOW DECORATIVE PELARGONIUMS.

I DO not know whether the value of such decorative Pelargoniums as Maid of Kent, Mermerus Improved, Duchess of Bedford, and Gloire de St. Mandé, are as well known to gardeners as their merits entitle them to be. They produce their flowers most profusely. The trusses are large, and the individual pips of good quality. As plants, they are dwarf and spreading in habit, and—a point of great importance to hard-working gardeners—they are very easy to cultivate. We have some plants ten months old in 6-inch pots measuring 2 feet across, and produced under the most ordinary conditions.

As the time has arrived for inserting cuttings to form good plants for next spring and summer, a few notes on their cultivation may be useful just now. Healthy growing shoots about 3 to 4 inches in length make the best cuttings. A good compost for the cuttings may consist of equal parts loam, coarse sand, and Mushroom-bed refuse rubbed fine. Leaf soil is a very suitable medium for the same purpose. I have employed it for some time under certain circumstances and find it excellent. It is used by itself. Several cuttings may be inserted in 5-inch pots, or, preferably, singly in the thimble size. Our stock is placed in a vinery to form roots. The shade of the Vinc does them no harm. When well rooted the plants are transferred into 4-inch pots, the soil

used being one part turfy loam, to which is added a third part of cow manure, with a 6-inch potful of bonemeal to each barrowload of the compost. A few coal cinders are placed in the bottom of each pot for drainage. In potting, the soil is rammed quite firmly.

At this stage it must be explained that, in order to have good plants for flowering the following spring, a continued and uninterrupted growth must be secured. These newly potted plants must therefore be placed in a structure where they will grow freely and quickly, though means must be taken to keep them from becoming drawn. When well started into growth the growing point must be pinched out; and again when the shoots produced from that pinching are long enough, the points of these must also be removed. With the help of a little liquid manure when the pots become filled with roots the first potting should last until autumn, when another shift into 6-inch pots will be sufficient over the winter and into the flowering season. During the winter months the temperature ought never to be below 45°. Assistance from manure, either employed as a surfacing to the soil or given with the water, will be necessary when the days lengthen. The plants will not need stakes if properly grown. Unless required for flowering in winter they should be destroyed when the crop of bloom is over, yearling plants flowering the most satisfactorily. The season of flowering may be prolonged by striking a batch of cuttings in July. These should not be shifted into their flowering pots until spring. The points to be observed in order to be successful, are these—to select healthy-growing cuttings, and to keep them growing without check from first to last.—R. P. B.

SULPHURIC ACID VERSUS CARBOLIC ACID FOR DESTROYING WEEDS.

By an inadvertence I am made in answers to correspondents, page 330, to recommend carbolic acid for destroying weeds. I have never done so, but did some time ago call attention to the value of sulphuric acid for that purpose. As some confusion appears to exist in the minds of many gardeners concerning the two acids, it may be well to explain what they are, and something of the uses to which they are applied. Carbolic acid is a substance resembling creosote, and is obtained by the distillation of coal tar. I have used it quite recently mixed with oil as a disinfectant with much success among animals, but have never known it to be regarded as useful for the wholesale destruction of weeds. Sulphuric acid or oil of vitriol, on the contrary, is a well-known destroyer both of vegetable and animal life. It is obtained by an elaborate process from sulphur and nitrate of soda, which is fully explained in Brande's "Dictionary of Science," where, too, in a lengthy account of its various properties, it is stated that "its affinity for water is such that it rapidly absorbs it from the atmosphere, and when mixed with water much heat is evolved. It acts energetically upon animal and vegetable substances, generally charring them, and often, as in the case of sugar, with singular rapidity." I may add that when using it for destroying weeds, I have noticed that the heat imparted by the acid to water is so great, that it may instantly be felt outside a waterpot after the half pint of acid is poured into a gallon of water.—EDWARD LUCKHURST.

CANKER IN FRUIT TREES.

I KNOW from your invariable kindness and patience you will allow me to bring the above subject before your many able and trustworthy practical contributors.

I have been a diligent and close reader of "our Journal" for thirteen years past, and am familiar with all it has so interestingly taught in that time, and I trust I may truthfully say I know of no subject that needs more discussion than the above.

I have recently been through many gardens and orchards round London to the extent, in some cases, of over twenty miles out, and anything more disheartening can hardly be seen than the numbers of Plum, Apple, and Pear trees that, after being watched and tended for years, are crippled, or useless, or dead through canker. I think this evil more than all others combined disheartens both amateurs and business fruit-growers. I was recently in an orchard where Cherries were magnificent, fruitful, healthy, very large trees; but nearly all the Apples, Plums, and Pears were dead or dying by canker.

I know by my own practical experience that some kinds of Plums, Apples, and Pears do not canker anywhere, but, unfortunately, I know of very few varieties of which this can be said. Would it not be a very great good for you and some of your able contributors to give in "our Journal" lists of Plums, Apples, and

Pears that would flourish, fruit, and not canker on any part of the London clay or gravel, say from five to fifteen or twenty miles round the metropolis? I mean trees on free stocks and standard form. I am familiar with all the good obtainable books and treatises on fruit trees in our language and some of the best in French, but not much help on this subject is to be obtained.

No doubt wet autumns in which the trees keep growing until sudden and severe frost sets in is the chief cause of the mischief; but still there are some varieties that resist even these changes, and what are certainly needed are lists of these varieties from



Fig. 79.—*Primula scotica*.

experienced men to point out clearly all that are so known, and "our Journal" is the one that should give them.—CANKER.

[We shall be glad if our readers, not near London alone, but in different parts of the country where fruit trees are liable to canker, will name those varieties that are not affected, or only slightly, stating also the soil and conditions under which the trees are grown. Will our correspondent oblige by naming those that he knows by his "own practical experience do not canker anywhere?"]

PRIMULA SCOTICA.

A CORRESPONDENT sends us flowers and leaves of a remarkably fine and early variety of this charming little Primrose—indeed, by far the best we have seen, and of which a faithful representation is given in fig. 79. In a communication accompanying the flowers it is stated that "it increases very rapidly and is very useful for spring bedding, but the plants have suffered a little from the cold this season."

We felt some doubt respecting the identity of the plant, but

after carefully examining it we can only consider it to be a superior form of the Scottish Bird's-eye Primrose, which is found in pastures in Orkney, Caithness, and Sutherland. It was first discovered by Mr. Gibb of Inverness at Holborn Head, but it has since been found in several districts, and has also been observed in arctic Lapland, Norway, and Sweden. The typical form is of moderate size with neat purplish flowers, but in the specimen engraved the whole plant is much more vigorous, the flowers larger and of a richer crimson-purple hue, these alterations being doubtlessly due to cultivation, and show how worthy this Scottish wilding is of being cultivated in gardens.

ROSES ON THEIR OWN ROOTS.

I REGRET to find that no rosarian has written, in answer to Mr. W. Simons, to defend the system of growing Roses upon stocks, and in the hope that some authority will do so I venture to start the discussion.

I mentioned last week that growing Roses upon their own roots was generally recommended by those who do not exhibit; the reasons of this being, first, that one who takes a pride in his Roses will generally try to propagate them himself, and he will find budding the cheapest, quickest, most interesting, and most effective mode of procedure; and, secondly, that one of Mr. W. Simons' persuasion will perhaps say, "Oh! I grow quite as good Roses on their own roots as exhibitors do on their stocks!" but till brought to the test of the show table, that is but a statement. Again, though there may be lovers of the Rose who make its culture a study and yet do not exhibit, it is not, I think, taking too much for granted to suppose that those who do gain prizes at Rose shows are best acquainted with the most successful way of growing them, and most qualified to speak of it.

Mr. W. Simons, for instance, has the following in his letter:—"If your plants die to the ground, as many of them will do in a rigorous winter or spring, there is no certainty, unless you expose the plant to the budded portion, whether the new shoots are Briars or bastards, the illegitimate offspring being in this case what you crave." I cannot say to whom the word "you" in the above passage is intended to be applied, but it seems to me a little "rough" on those of your readers who flatter themselves that they can distinguish a Briar, or even a Manetti shoot from that of a Rose.

I was surprised also at Mr. W. Simons' lament that Roses on their own roots were not to be bought from our large nurserymen. Mr. Cranston of Hereford, who must be one of the nearest large professional growers to Merthyr Tydfil, has quite recently had a special advertisement of them in your own columns. And this leads me to agree with a reason Mr. W. Simons gives, and a very good one, why "stock-budded plants are in favour"—namely, that none but nurserymen in quite a large way, like Mr. Cranston, can afford the wood necessary for cuttings. From a thicket of maiden Manettis he might spare sufficient for a certain amount of certain sorts, but he must go to budded plants to get them.

It seems to me that the advantages of budding Roses over growing them on their own roots are economy, certainty, earlier maturity, and (last, but not least) better blooms at all stages, in most cases.

1, The fact that one bud will produce a Rose tree by budding, while something like half a dozen will be required for a cutting, as acknowledged by Mr. W. Simons, will show the economy of budding.

2, Greater certainty in propagation is also acknowledged for budding. "In skilful hands less buds than cuttings fail."

3, As to earlier maturity, the cutting makes little growth and no flowers worthy the name the first year. Neither, it may be said, does the stock, which is planted to be budded on. We come, then, to the second summer. In that year most budded Roses are at their best; some are only seen at their best at that stage. Can the same be said of cuttings? I doubt it; though I do not wish to deny that a few, and some of them good Roses, do succeed eventually on their own roots.

In five years' time five Briars a foot or two high, planted against the south wall of my house (quite a large one for a country rectory) and afterwards budded with Maréchal Niel, Rêve d'Or, Lamarque, Solfaterre, and Belle Lyonnaise, completely covered it to the roof. The soil is poor, and no manure was given till last year, by which time the wall was covered. Could this effect have been produced by cuttings? And if it be admitted that the blooms of budded plants are better the year after budding than those of cuttings planted the same time as the stocks, the growing of cuttings in a large way would make much difference to nurserymen, who derive a large portion of their profits from the sale of the cut blooms of their maiden plants.

4, Especially I would maintain also that the blooms of budded plants are, with a few exceptions, always better than those of cuttings, and that this is particularly the case with the choicest sorts. I may be shown a good growth, and perhaps a fair amount of bloom of Jules Margottin; but I have a soul above Jules Margottin, and I ask, "Where is your Horace Vernet?"

Mr. W. Simons says, "My experience shows that there is scarcely a Rose which is not better grown under suitable conditions upon its own roots than upon a stock, and I know of no Rose which will not grow well from cuttings, and be longer-lived and more floriferous than Roses budded upon a stock however vigorous." The question is, Will other rosarians allow this statement to pass unchallenged, or do they really endorse it? Will Marie Cointet and Xavier Olibo "grow well from cuttings?" That any Roses on cuttings are so floriferous as worked Roses is not my experience; and, by the way, I may mention that I have noted in my rows of Roses of the same sort—a Briar and Manetti alternately, a marked difference in the amount of autumn bloom in favour of the Briar. I do not know much about other branches of horticulture, but when I find that Peaches, Plums, Apples, &c., and even Clematises and Cacti, are grown upon other stocks, I do not suppose they are so propagated for the fun of the thing or the interest of the operations, but because it is found to be suitable to the well-being and usefulness of the plant—the point in general being, that we obtain thereby earlier maturity and fruitfulness. I shall be very glad if my crude remarks have the effect of drawing some experienced rosarian to write upon this question, even if it be to contradict me.—A. F. M.

ASPARAGUS CULTURE UNDER DIFFICULTIES.

PLANTING time for new Asparagus beds has come round again, and it is not improbable that where failures have occurred some doubt may exist as to the best course to adopt to avoid them in future; some account of an instance of failure which proved a stepping stone to success may, therefore, prove useful now.

I may as well own at the outset that till some eight years ago I had never had any difficulty about Asparagus, always having been able to produce it abundantly without the adoption of special means, and had always regarded it as amenable to the most simple method of culture either forced or in the open garden. But then came my failure; and although that I have now set matters right and have plenty of Asparagus, I must still acknowledge the correctness of my former conviction of the ease and simplicity of its culture generally, yet I am bound to own that there are exceptional cases requiring special care and a little extra labour—nothing more, in order to ensure success.

The primary cause of my failure was undoubtedly ignorance of the nature of the soil—a poor, thin, silicious one on the Hastings sand formation, and quite the reverse of what is known as a heavy soil in the common acceptation of the term. Yet I found subsequently that it would settle into a hard inert mass, quite as impervious to moisture as clay, and consequently in time it proved equally fatal to Asparagus roots. At first all went well enough. The soil was efficiently drained and enriched with farmyard manure, extra care being taken to mix it thoroughly with the soil. The Asparagus, planted in single rows 18 inches apart and a foot apart in the rows, grew freely, and for four years all went well; but then traces of debility and incipient decay became apparent, and upon examination it was found that as the manure beneath the plants had become absorbed by them, the soil had gradually settled down more and more closely about the roots, till drainage had come so slow that they had perished.

Prompt measures were at once taken to form new beds in another part of the garden, where thorough mechanical division had meanwhile been imparted to the soil by repeated heavy dressings of coal ashes as well as manure after every crop. I therefore had now a sound and reliable basis to work upon, and had only to turn to my muck heap for an abundant supply of the best compost in the world for Asparagus culture, which may roughly be stated to consist of two parts of garden refuse, one of dung, one of coal ashes, and about a half part of lime well mixed together. A layer of this 8 inches in thickness was spread over the entire surface and well worked into it, and it was then planted with fresh strong young seedling plants, which threw up stalks of such vigour in the first year as showed clearly how suitable the soil was for them. Especial care was taken to prevent the young growth being damaged by wind, supports being tied along each side of it. It should be added that frequent applications of sewage doubtless contributed materially to the robust dark green hue of the growth, and these waterings were given without hesitation from the fact of its being well known that the soil was now thoroughly porous and the drainage efficient.

Subsequent annual dressings of the rich fertile compost have brought the beds into a full bearing condition and maintain them in perfect health and vigour.

Let me repeat here that the culture of Asparagus is a simple and easy matter, beset with few difficulties under any circumstances, and with none in the most exceptional case that may not be overcome by the exercise of a due amount of caution and watchfulness. No special nostrums are wanted nor extraordinary expenditure called for to insure success. Sea sand, seaweed, salt, are all good, but neither of them is indispensable. I once knew a worthy gentleman who attributed his fine Asparagus to an annual bargeload of seaweed, which he was at some trouble in having brought from the sea up the river near which he lived, yet part of the bed which, unknown to him, had manure instead of seaweed was decidedly superior to the remainder.

The French system of Asparagus culture has been exalted to the skies; why I know not, for in what is it superior to ours? Certainly neither in economy of labour or time. The comparative degree of excellence to which it is possible to bring the Asparagus under either system may be said to be the best test, and the palm for size may certainly be awarded them, but for flavour, delicacy, and abundance English-grown Asparagus certainly bears favourable comparison with the somewhat more showy produce of our sensational neighbours. To tell the owner of a small garden that, in order to grow good Asparagus, he must plant it singly, keep 16 square feet of surface sacred to the roots of each plant, and that only after five years' careful culture his plants will be in full bearing, is enough to debar him from having anything to do with it, nor is space in our largest gardens so abundant as to be thus thrown away.

One word to amateurs about forcing Asparagus. Many would like to have a supply early in the year who do not attempt to get it from a mistaken idea that it is an expensive affair quite beyond the scope of their means. But it is not so. A lively hotbed of leaves or dung, or, better still, of both mixed together, just large enough for a single-light garden frame, is all that is required. Put on the box directly the bed is made, insert a trial stick, and when the most violent heat begins to subside, at once cover the surface of the bed with 4 inches of your most tenacious soil, tread it firmly, then cover lightly with 6 inches of rich soil, upon which pack strong Asparagus roots as thickly as possible, cover with soil, protect the glass at night with mats, and you will soon have a rich supply. Roots thus forced are worthless afterwards, but by sowing an annual bed and using three-year-old roots in succession all outlay is avoided.—EDWARD LUCKHURST.

LILY OF THE VALLEY FOR FORCING.

THE culture of Lilies for this purpose is so simple that a very few lines will suffice to point out the main features to be observed in order to secure the results longed for by Mr. Sanders with regard to quantity of spikes in a given potful, or to obtain size of foliage and spikes as noted in your last issue (page 314). Even people who ought to know better begin at the wrong end. They seem to think if the plants are well treated until forcing commences the foliage and spikes will be ready to respond to the treatment, no matter how neglected the plants may have been during the previous summer. But in my experience (which without any boasting may be termed a pretty large one) the crop of one season depends entirely on the growth of the year preceding.

For some time I have been well assured of an early crop for next year, both flowers and foliage being in a forward state of development. Later batches are receiving every attention in order to secure like success with them. Keeping the above in view as a primary principle, it may be stated that the only means of securing a large number of spikes in a pot is to have the roots in the same pot for at least a couple of years. Further, if an 8-inch pot is the size aimed at, it ought to have been filled by transplanting from a well-filled 6-inch pot. It then only requires sufficient heat, light, and abundance of liquid manure during the season of growth (which commences with the shooting of the buds) in order to get every leaf to form a bud containing a spike. This treatment also secures large foliage and spikes with numerous bells. The soil to grow them in should be a strong loam enriched with a third part of cow manure.—R. T.

ZONAL PELARGONIUMS.—Will you kindly allow me to say in reply to "W. J. M." (page 300) that the remarks on the culture of Zonal Pelargoniums to which he takes exception are founded on somewhat over ten years' experience?—that the writer had tried various plans, and found that recommended to give the best results, whether as regards the quality of the flowers, the quantity of trusses produced, or continued production through the winter months. As to varieties,

your correspondent must surely be ignorant of those named in my article. I think it very doubtful if such kinds as Lady Sheffield, Earl Manvers, Aida, and White Vesuvius will ever be superseded as winter bloomers. I may say that these and others named have more than once been thrust aside for new comers, and always to our loss. I may again note that there is no difficulty in producing blooms up to Christmas; it is during January and the first half of February that the break occurs. If "W. J. M." wants simplicity let me introduce to him a plan of striking cuttings in May and June much simpler than a frame heated with dung. It is simply to insert the cuttings in an open border out of doors. Of course I do not recommend that as a good way of getting up stock for blooming in winter; but for those who want to do the thing simply without regard to after results no better way can be obtained.—R. P. BROTHERSTON.

NATIONAL AURICULA SOCIETY. SOUTHERN SHOW.

ON Tuesday last the annual Exhibition of the National Auricula Society was held in the conservatory at South Kensington, in conjunction with the Royal Horticultural Society's Promenade Show. Competitors were numerous, and though a few classes were weak, in the majority the entries were very satisfactory, and, more important than all, the health of the plants and the quality of the blooms in the leading classes was all that could be expected. A few rough flowers were observable, and some northerners appeared a little backward, but these were exceptions. As usual, the chief interest centred in the class for twelve Show Auriculas, the two champion growers, the Rev. F. D. Horner and Mr. J. Douglas sharing the honours equally, both contributing most praiseworthy plants; but the premier, selected from Mr. J. Douglas's stand—viz., Conservative, was deservedly admired by all, the substance, symmetry, and freshness of the blooms being most pleasing.

The single specimen classes were remarkably well filled, and the Judges had a very difficult task to select the best where so many were good. Green, grey, and white-edged varieties occupied considerable space, and included amongst them many plants of great beauty in every respect. As stated below, the number of plants in these three classes was about 150. Selfs were also abundant and good, but though several very meritorious collections of Alpines were contributed, we have seen a large display of these varieties at some previous shows. Polyanthuses were well shown, the competition being close, and the plants both vigorous and freely flowered.

SHOW AURICULAS.

Twelve Varieties.—Equal first prizes were awarded in this class to Mr. James Douglas, gardener to F. Whitbourn, Esq., Great Gearies, Ilford, and to the Rev. F. D. Horner, Kirby Malzeard. In Mr. Douglas's collection were the following:—Douglas's Conservative with six fine clean pips, which was selected as the premier Auricula in the Show; Trail's Prince of Greens, Spalding's Blackbird, Heap's Smiling Beauty, Headly's George Lightbody, Campbell's Pizarro, Douglas's Mabel, Simonite's John Simonite, Turner's C. J. Perry, and several seedlings. The Rev. Horner's plants included Page's Champion, Walker's John Simonite, Read's Acme, Horner's Green Linnet, Headly's George Lightbody, Simonite's Mrs. Douglas, Horner's Beatrice, Horner's Monarch, Horner's Heroine, Lightbody's R. Headly, Spalding's Blackbird, and Kay's Meiklejohn. Mr. Pohlman, Halifax, was third, and J. T. D. Llewelyn, Esq., Penllergare, Swansea, was fourth.

Six Varieties.—The premier award was secured by Mr. E. Pohlman, Halifax, for vigorous plants of Horner's Ajax, Headly's George Lightbody, Trail's Prince of Greens, Pohlman's Brunette, Trail's Beauty, and Read's Acme. Mr. J. Douglas was a close second with smaller plants but neat clean flowers, Douglas's Conservative, Duke of Albany, and several seedlings being the varieties. These were the only entries in this class.

Four Varieties.—Mr. J. Collier, gardener to R. K. Penson, Esq., Durham House, Ludlow, was first with Read's Acme, Headly's George Lightbody, Trail's Prince of Greens, and Kay's Topsy, fresh and neat, but of moderate size. S. Barlow, Esq., Stakehill House, Castleton, Manchester, was a close second; W. Brockbank, Esq., Didsbury, Manchester, third; Mr. W. Bolton, 84, Wilderspool Road, Warrington, fourth; Mr. F. Fife, Southern Hill, Reading, fifth; and Mr. R. Dean, Ranelagh Road, Ealing, sixth, that being the number of entries.

Two Varieties.—Mr. S. Barlow was first with Lee's Colonel Taylor and Barlow's Carbuncle. R. K. Penson, Esq., Ludlow, was second with Headly's George Lightbody and Trail's Prince of Greens. Mr. W. Brockbank third with Mellor's Reliance and a seedling. Mr. C. Turner fourth with Topsy and Beauty. M. Rowan, Esq., 36, Manor Street, Clapham, fifth with Lovely Ann and Pizarro, and Mr. W. Bolton sixth with Simonite's Frank Simonite and Trail's Prince of Greens.

Fifty Plants, not less than Twenty Varieties.—Mr. J. Douglas took the lead in this class with a handsome collection of healthy plants, the blooms fresh, even, and clean. The best varieties were Simonite's Frank Simonite, Turner's Charles J. Perry, Sim's Eliza, Campbell's Pizarro, Trail's Beauty, Campbell's Admiral Napier, Cunningham's John Waterston, Kay's Alexander Meiklejohn, Douglas's Dr. Kidd,

Horner's Sapphire, and several seedlings. Mr. C. Turner, Royal Nursery, Slough, was a very close second with fresh bright-looking plants, the flowers good, and the varieties numerous. C. J. Perry, Mrs. Sturrock, Aurora, Eliza, Glory, Vulcan, Clipper, Smiling Beauty, Prince of Greens, and some others were remarkable for the great size of their trusses, some having ten or twelve blooms. J. T. D. Llewelyn, Esq., Penllergare, Swansea, was third with smaller plants.

Single Specimens.—Green-edged.—Rev. F. D. Horner was first and fourth with seedlings, Mr. E. Pohlman second with Leigh's Col. Taylor and sixth with Lytton's Emperor; Mr. R. K. Penson third with Leigh's Col. Taylor, seventh with the same variety, and eighth with Simonite's Talisman. Forty plants were staged. *Grey-edged.*—Mr. E. Pohlman was first, fourth, and seventh with Headly's George Lightbody; Mr. J. Douglas was second and eighth with the same variety, the Rev. Horner third with the same, Mr. W. Brockbank fifth with Kay's Alexander Meiklejohn. Fifty plants were staged. *White-edged.*—Mr. J. Douglas first and sixth with Conservative, fourth with Silvia, fifth with Dr. Kidd (all his own raising), and eighth with Reid's Acme; Mr. W. Brockbank was second with Reid's Acme, and the Rev. F. D. Horner third with Walker's John Simonite. Fifty-nine plants were staged. *Sels.*—The Rev. F. D. Horner was first, second, third, and fourth with Horner's Heroine, sixth with Spalding's Blackbird, and eighth with Ringdove; Mr. E. Pohlman was fifth with the last-named variety, and Mr. Brockbank seventh with Mellor's Cymbeline. These were very numerous, over one hundred plants being exhibited.

SEEDLINGS.—Green-edged.—First Mr. Barlow with *Greenfinch*, a very refined flower, the green, black, and paste being equally divided. Second Rev. F. D. Horner with *Monarch*, a large flower, with the body colour very dark, rich deep green, full size. *Grey-edged.*—First Rev. F. D. Horner with *Ajax*, a good variety, with rather too much ground colour; black, good grey edge. Second Mr. J. Douglas with *Miss Lodge*, a pretty variety with a silvery edge; good form. There was no award in the *White-edged* class. *Sels.*—First Mr. Barlow with *Adonis*, reddish-purple, very flat and smooth, fine tube; and second with *Carbuncle*, reddish-maroon, petals well formed, good white and gold tube. No certificates were granted when our reporter left the Exhibition.

SEEDLING POLYANTHUSES.—First Mr. Brockbank with *Black Diamond*, a splendid flower of full size, fine gold edge; and second with *Nonpareil*, a well-formed flower, the centre and edge reddish-maroon—a beautiful variety.

ALPINE AURICULAS.

Twelve Varieties.—Mr. C. Turner won the chief prize with a handsome collection, comprising E. S. Dodwell, Raphael, Vesuvius, Diadem, Sensation, Mariner, Phoenix, Tennyson, Artist, Superb, Mrs. Thomson, and National. J. T. D. Llewelyn, Esq., and Mr. J. Douglas were second and third respectively. One collection from Reading was disqualified because some of the flowers were pin-eyed.

Six Varieties.—Mr. C. Turner was again first with fine specimens of Troubadour, F. A. Dickson, John Dickson, Sensation, Mariner, and John Bull. Mr. E. Pohlman, Halifax, was second; Mr. Llewelyn third; and Mr. Douglas fourth.

Single Specimens.—Gold Centre.—Mr. C. Turner was first with Dr. Hogg, second with Unique, third with Vesta, fourth with Roystercr, fifth with E. R. Cutler, and sixth with John Brown. *White or Cream Centre.*—Mr. C. Turner was first with Olivette, second with Bayard, third with Mabel, fourth with J. T. D. Llewelyn, fifth with Talisman, and sixth with Milton.

Only three collections of twelve Fancy Auriculas were staged by Mr. J. Douglas and Mr. W. Bolton, who secured the first and second prizes in that order for fairly good plants. Mr. R. Dean was third, also with fair plants.

POLYANTHUSES.

Six Gold-laced Varieties.—The competition was good in the classes for these plants, Mr. S. Barlow taking the first prize with neat specimens of Barlow's Sunrise, Cox's Prince Regent, Hufton's Lord Lincoln, Sander's Cheshire Favourite, Crownshaw's Exile, and Buck's George the Fourth. W. Brockbank, Esq., was a close second, having Elliott's Sir Sidney Smith, Sander's Cheshire Favourite, and Buck's George the Fourth in fine form. Mr. J. T. D. Llewelyn and Mr. Douglas were third and fourth respectively.

Three Varieties.—Mr. Barlow was again first with George the Fourth, Cheshire Favourite, and Exile; Messrs. Brockbank, Douglas, and Llewelyn following in that order.

Single Specimens.—Mr. Brockbank was first with Cheshire Favourite, third with George the Fourth, and sixth with Lancashire Hero; Mr. Llewelyn being second with Exile, and Mr. Barlow fourth with John Bright.

Twelve Fancy Polyanthuses.—Mr. Dean was awarded the first prize for very attractive plants, Sovereign, Viceroy, Grenadier, Cloth of Gold, and The Bride being the best of the varieties. Mr. W. Hooper, Vine Nursery, Bath, and Mr. J. Douglas, were second and third, each showing good plants.

Primulas.—Twelve plants, not less than six distinct species. Mr. J. T. D. Llewelyn secured the first and second prizes in this class with good collections, in the first being fine plants of *P. Sieboldi*, *P. verticillata*, *P. rosea*, *P. auricula*, *P. japonica*, *P. cortusoides*, *P. Pallasii*, *P. cashmeriana*, and *P. involucrata*. In the second

collection were *P. calycina*, *P. farinosa*, *P. commutata*, *P. obconica*, *P. longiflora*, *P. denticulata*, *P. dolomites*, and *P. decora*. An extra prize was awarded to Mr. Dean for a collection of well-grown plants, chiefly varieties of *P. cortusoides*.

THE "UNIVERSAL" GARDEN ROLLER.

A GOOD garden roller is at all times a useful implement in every garden establishment, and the various uses to which it is applied in rolling turf, gravel, and pulverising heavy soils when dry for the preparation of seed beds, render it necessary that the weight of the roller should be capable of being varied at pleasure, according to the use to which it is to be applied. The rollers we have been used to hitherto have been simply a more or less thick open cylinder of cast iron, the weight of which could not be conveniently increased or diminished at pleasure without some clumsy contrivance for loading it with ill-adapted materials. In the roller which has been introduced by Messrs. Barford & Perkins of Peterborough under the above name we have a great improvement

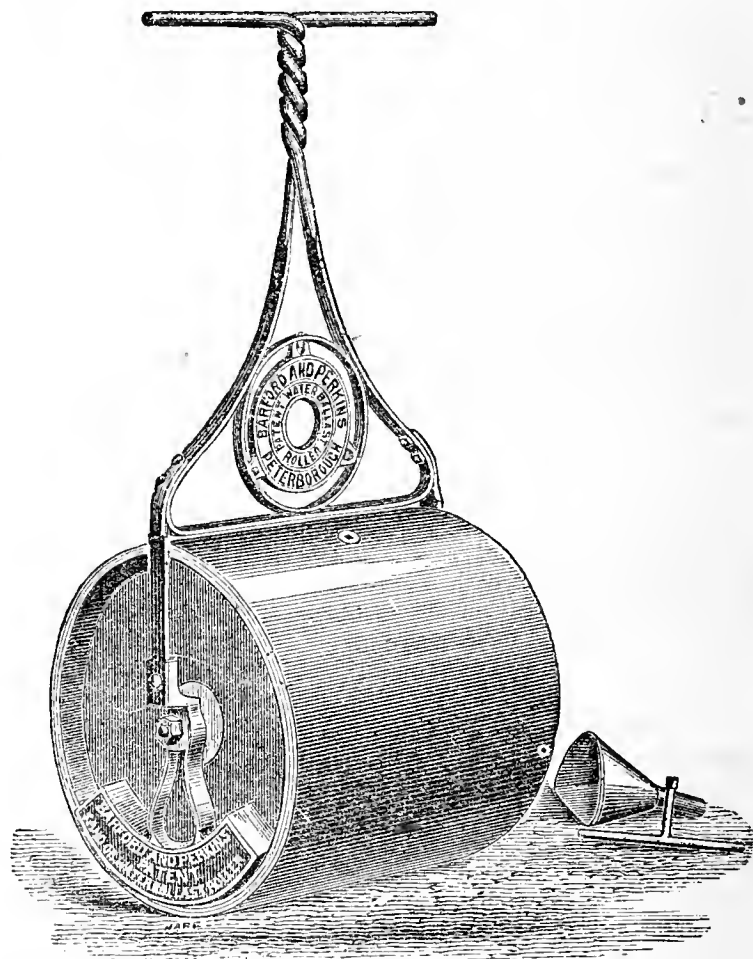

Fig. 80.—The "Universal" Garden Roller.

on the old system. It consists of a closed cylinder capable of being filled with sand or water, so that its weight may be regulated for any special use to which it is to be applied. If a light weight is desired the roller can be used empty; if a greater weight, then the cylinder is filled, according to the increased weight which is required, with either water or sand, and these can be removed at pleasure when they are no longer required. The mode of filling is through a funnel, which is supplied with the roller, and which is introduced into a hole in the cylinder by removing an iron screw plug of about 2 inches in diameter. By this hole the roller is also emptied. We can with confidence recommend this roller, having experienced the practical working of it. It is represented in the annexed engraving, with the funnel for filling the cylinder and the key for unscrewing the plug.

MY SUBURBAN GARDEN.

A COLUMN FOR AMATEURS.

IF the weather in the north has been worse than in the south during the month of March I pity the dwellers, at least those who are alive, in that bitter clime. The frost and ice winds killed almost all my outdoor flowers, and nearly killed me; it filled the hospitals and made life miserable. A month or more ago I was to tell of my "mountain of gold." It was but for a few days only most beautiful, and ought to have been a mass of brilliancy for

weeks. It is a very simple matter after all—just a mound of Ferns, a rough rockery; but the Ferns are deciduous, and to make my mound bright when they are sleeping I have it filled with Winter Aconites. Of all the bulbous plants for towns none excels this, and few kinds are more sparingly planted. We may pass a hundred gardens and find none of this, the earliest and brightest of spring flowers, in them. My brother has a large place in the country, and the ground under the trees is full of Winter Aconites, which cover the surface like a ray of sunshine. There are thousands—millions of them, thicker than stars in the firmament, and not less sparkling. They appear to grow anywhere—in hollows, on hills, under trees, and in the open; and than the mound in my suburban garden I have nothing throughout the year that is more admired, and somehow it has become known amongst my friends by the fanciful name above indicated. But do not the Aconites injure the Ferns? No. They do them good by sheltering the young uncurling fronds just as they are sheltered in their native woods, while the pretty green foliage of the bulbs just continues long enough to cover the soil until the Fern fronds meet across the spaces.

The Aconites I plant anywhere and everywhere, digging them up some time after flowering and planting them in tufts. "Oh, that wo'n't do, sir," remarked a spring assistant whom I hired for a time; "they must be set in Hoctober, the books says so." I am afraid this good digger thought there was something the matter with me when I determined to go on planting in spite of the books, and the next day he brought me his books to "see for yourself, sir, beggin yer parding"—three bulb catalogues. I explained to him his books were quite right, but I was not wrong. He evidently failed to see the force of this logic, and there may be others like him; but that the Aconites transplant well after flowering, at least well enough for me, hundreds of plants show that have been established in that manner. However, I advise all who have gardens in or out of towns to do what the "books" say—purchase Winter Aconites and plant them in October.

Wallflowers are excellent town plants, and the late arctic wave has told me what I never knew before, that the dwarf single yellow is the hardiest of them all. Most of the dark kinds are in rags—killed, but not one of the yellows is materially injured. These cheerful and fragrant old flowers are indispensable for spring; but to have fine plants and hardy, the seed must be sown early in April, and the plants grown in the poorest soil and most exposed position at command. Sowing late, and growing in rich soil to make up for lost time, is a practice that can scarcely commend itself to those who think about the matter. Perhaps, however, not being a Vine or an Orchid question, it is not worth thinking about. Is not this the cause of so many failures in common things? and are not common things often the most important?

Gladioluses have bothered me not a little. I have bought them over and over again, but as my man says, they always "get the measles." But the Gladiolus disease is worse than that malady, for it appears incurable. A few of the varieties I can grow—those that produce cormlets freely. These cormlets I preserve and sow thinly in drills 6 inches apart. April is the time for this. The plants come up quickly, and there they remain until a few flower; then in the autumn the bed is dug up and I have a few hundreds of corms that never fail to produce fine spikes. By sowing a few cormlets yearly a supply of useful Gladioli has been maintained for many years; but for this mode of raising them I apprehend my stock would have been extinct long ago. This is all I have to say at present, and perhaps it will not be worth printing.—M.



At a general meeting of the ROYAL HORTICULTURAL SOCIETY, held last Tuesday in the Conservatory, Major F. Mason, Secretary, in the chair, the following candidates were unanimously elected Fellows—viz., Levi Cohen, Miss Dent, Frederick Du Cane Godman, F.R.S., Henry S. Keating, Frederick Wm. Steward, Lady Truscott, Mrs. Tuckwell, Arthur Wm. Walker, James Willing.

— A RATHER UNWELCOME CHANGE IN THE WEATHER has occurred, bright days having been suddenly followed by showers of hail and snow just as the Pear blossom is expanding. Last

Monday London had quite a wintry aspect, and it was even worse in some parts of the country. A Kentish correspondent wrote to us on Tuesday as follows—"Our fruit prospects here were of the most promising kind, Apples, Pears, Plums, and Cherries one mass of blossom; but, alas! to-day I fear our brightest hopes are blasted, for during nearly the whole of this afternoon this neighbourhood has been visited by heavy snow and hailstorms, and at 11 P.M. the thermometer registered 2° of frost, with every prospect of more before morning. Very cold easterly winds, too, have prevailed here for several days past." Yesterday (Wednesday) the cold was less intense, the wind having subsided, but the Pear crop is undoubtedly in jeopardy.

— FOR some time past negotiations have been in progress for the ROYAL HORTICULTURAL SOCIETY TO HOLD EVENING MEETINGS of the Scientific Committee in Burlington House, and through the courtesy of the Council of the Linnæan Society the Council of the Royal Horticultural Society have succeeded in procuring a *locus in quo*, and the first meeting will be held on the evening of May 8th. The meeting-room and library of the Linnæan Society are placed at the disposal of the Council on that evening and also that of June 12th, when all Fellows of the Royal Horticultural Society are entitled to attend and to introduce a friend. These meetings are not in any sense to be regarded in the light of flower shows, though flowers, fruits, and other objects of horticultural interest are to be exhibited, but they will only be introduced so far as they go to illustrate the papers that may be read or the addresses that may be given. These meetings will no doubt have great interest for many of the Fellows of both Societies, and we cannot but regard it as a good sign of the times when we see Science and Practice thus going hand-in-hand for the common good. Further particulars as to the meetings will be duly advertised in the gardening and daily papers.

— THE CHISWICK AND TURNHAM GREEN HORTICULTURAL SOCIETY held a Spring Show in the Vestry Hall, Turnham Green, on Thursday last, when groups of plants were contributed by a number of local supporters. No prizes were offered, but a very pretty display was produced with miscellaneous flowering and fine-foliage plants. The weather unfortunately was very unfavourable, and the attendance of visitors not very large.

— MR. J. SMITH writes:—"Like Mr. J. Muir I have a case of VINES BLEEDING in a house of Black Hamburgs, some of the rods having been pruned rather late. These have bled very freely, but the border was excessively wet, and I put that down as the fault. I shall carefully note the results."

— THE ROYAL HORTICULTURAL SOCIETY OF IRELAND held a very successful Spring Show on the 19th inst. in the grounds of Mr. Edward C. Guinness, and though the weather was somewhat unfavourable the attendance of visitors was good. Azaleas were a prominent feature, Mr. Laidley, gardener to W. Jameson, Esq., Montrose, securing the Society's cup for healthy well-flowered plants, and the same exhibitor was the most successful with a group of exotics and several other classes. Roses in pots were shown by Messrs. W. J. Perry, Richard Pim, and the Rev. F. Tymons. In other classes the principal prizes were secured by Mr. Smith, gardener to the Lord-Lieutenant, Vicc-Regal Lodge; Mr. G. M'Cullagh, gardener to Viscount Powerscourt; Mr. Jenkins, gardener to Alexander Comyns, Esq., Ardcaune, Glenageary; M. M'Geary, gardener to Captain Riall, Chantilly, Loughlinstone; and Dr. George McMaster, Brookville.

— MR. PRINCE sends us the following note on RHODODENDRON NUTTALLI, which would have appeared sooner had it been addressed to the Editor, as we particularly desire all matter for publication should be, and not to any individual connected with this Journal:—"This plant, rarely seen in the largest collection

of plants, and very rarely flowered, is now in bloom at Highfield, the residence of H. Wardle, Esq., Burton-on-Trent. One cluster of seven large blooms is now open, and another prominent truss to open. Lovers of rare plants and Rhododendrons would be delighted with a sight of it, and such would be welcome by the owner.'

— THE COLNBROOK AND DISTRICT HORTICULTURAL SOCIETY will hold an Exhibition of flowers, fruits, and vegetables in Ditton Park, Windsor, the seat of the Duke of Buccleuch, on Wednesday, July 25th.

— MR. BAIN, for the last twenty-three years gardener to Sir Chas. R. Boughton, Bart., Downton Hall, Ludlow, has taken the Brereton Nurseries, Staffordshire, and is succeeded by Mr. Bohill, foreman from Whittingham, East Lothian.

— A CORRESPONDENT writes:—"The quickest grown and the finest specimens of the semi-double ZONAL PELARGONIUM GUILLON MANGILLI I have yet seen, are in the houses erected by an enthusiastic Frome amateur. Some of these plants are about ten months, and others twelve months old, and on the average are 42 inches high, exclusive of pots, and of good proportions. They were struck in heat and gradually shifted into 10-inch pots, in which they are flowered. The soil consists principally of loam and a little decayed manure and road grit or sand. During the summer the plants were stood in an open sunny spot and were housed before severe frosts were anticipated. Throughout the winter they were principally grown in an ordinary plant stove, this being a very light structure, and the temperature, light, room, and good attendance, supplemented with an occasional supply of Standen's manure, exactly met the requirements of this invaluable winter-flowering Pelargonium. At any time during the winter the pillar-like plants in question yielded abundance of fine trusses of blooms. At the present time they are crowded with trusses, and present a very gay appearance. The variety is erect-growing and branching, consequently but little stopping is necessary after the foundation is laid. Mr. Wm. Taylor has done much to bring this Pelargonium into prominence, and no doubt is well pleased to see others in this and other matters so ready to follow his lead."

— THE usual monthly meeting of the METEOROLOGICAL SOCIETY was held on Wednesday evening the 18th instant, Mr. J. K. Laughton, M.A., F.R.A.S., President, in the chair. T. G. Bowick, E. C. Clifton, H. Culley, Dr. W. Doberck, A. N. Pearson, Prof. H. Robinson, and J. E. Worth were balloted for and elected Fellows of the Society. The following papers were read:—1, "On Cirrus and Cirro-Cumulus," by the Hon. F. A. Rollo Russell, M.A., F.M.S. The author pointed out that next to frequent readings of the barometer and a knowledge of the distribution of the atmospheric pressure, observation of the character of clouds, especially of cirrus, is of the greatest use in attempting to forecast coming weather. Observation of cirrus can plainly be made use of in a telegraphic system of weather forecasts as easily as observation of the barometer, and the employment of a number of scattered cirrus-observers largely increases the probability of this form of cloud being noted. 2, "Some Notes on Waterspouts; their Occurrence and Formation," by George Attwood, F.G.S. 3, "Records of Bright Sunshine," by W. W. Rundell, F.M.S. This is a discussion of the sunshine records made in the United Kingdom during the years 1881 and 1882, from which it appears that there is more bright sunshine upon the coast than there is inland. 4, "Note on Wind, Cloudiness and Halos; also on Results from a Redier's Barograph," by E. T. Dowson, F.M.S.

— AT the same meeting a paper "ON THE COLD WEATHER OF MARCH, 1883," was read by W. Marriott, F.M.S., who remarked

—"The weather of this month will long be remembered for its very cold, dry, and windy character. The winter had been very mild, dull, and wet, and continued so to the beginning of March. A sudden change took place, however, on the 6th. A severe northerly gale set in on that day, accompanied with snow showers and a keen biting wind. This gale was most violent in the North Sea, and caused sad havoc among the fishing fleet on the east coast, no less than 382 men and boys being drowned. The temperature fell considerably, the maximum being below 40° almost all over the country, and in the north of England only a trifle above the freezing point. The same conditions prevailed for the next two or three days, the temperature, however, falling still lower, and on the 10th the minimum occurred in the central and northern districts. The most remarkable weather of the month took place from the 21st to the 24th. Owing to a brisk fall of the barometer over France an easterly gale was experienced over this country, and as the temperature was low and the air very dry the wind was exceedingly bitter and keen, and its effect upon the human frame was most distressing."

ANTHURIUM SPLENDIDUM.

ANTHURIUMS rank amongst the most noble and beautiful of ornamental-foliaged stove plants. All the forms are handsome, and no one seeing the finest examples of such as *A. crystallinum*, *A. Veitchii*, *A. Warocqueanum*, *A. Thibautianum*, and others can fail to admire them. All those named are quite dissimilar, and the one now figured differs widely from them all. It is one of Mr. Bull's introductions, and placed by him in commerce for the first time this season, with the following description:—"A strikingly beautiful stove Aroid, imported from South America. It is quite distinct from anything yet in cultivation, and a plant which cannot fail to become universally admired, the surface of the leaves being remarkably peculiar. It has a short thick caudex, from which spring up the cordate leaves, which have an open sinus, the lobes meeting behind. The course of the nerves is marked by a broadish band of deep lustrous velvety green, the intervening spaces of about equal width being in striking contrast of a pale yellowish green. The leaf surface is scabrous, and the portions between the ribs strongly bullate as if raised in papillose blisters. The veins on the under surface are angular, with tooth-like projections at intervals, while the whole under surface is punctate with small pallid dots." That is a very accurate description of a plant which promises to be a valuable addition to the fine genus to which it belongs. As the plants increase in size the foliage will in all probability be still more imposing. Even in a comparatively small state it is striking by the lustrous sheen of its peculiar surface, and the appearance of the plant is certainly not overdrawn in the illustration.

CLEMATIS INDIVISA LOBATA.

THIS has been the prettiest and most useful plant with us for more than eight weeks past. It was planted in quite a small state in the early autumn of 1881, so that it is scarcely two years old, and yet it has covered more than two-thirds of a span-roofed greenhouse. The centre bed of the house in which it is growing was carefully made, after being well drained, with whole turves of loam, and a sprinkling of charcoal on each layer of turf to keep the whole sweet and porous. A little fine soil was used for planting with, and the plant started away without a check. By the middle of January it had made about 20 feet of growth, when it showed about a couple of dozen flower buds, the whole of which expanded beautifully, just as it were to let us see its worth. It was greatly admired and praised by all who saw it. It kept on growing vigorously through the whole of last season until its allotted space was completely covered, when it had to be checked, or it would have made the house too dark. Often through the season were we compelled to cut away handfuls of growth so as to keep it in bounds, and yet it kept extending.

Owing to an alteration being effected in the house last October we were necessitated to take the plant completely off the trellis at the expense of some fine shoots—for it is hardly possible to disentangle its growths without injury, as the leafstalks take such a firm hold upon the wires, its own shoots, or anything that may be convenient—and twine it in bundles round a post. We imagined this cruel treatment might affect its flowering, for it was entwined

in masses nearly a month round the post; and when we commenced to tie it up again to the altered trellis it had made many new growths, some of them more than 2 feet in length and quite blanched. We were agreeably mistaken, however, in our surmise,

for it commenced showing its flower buds, and kept on showing them until the whole plant was one mass of buds. It opened its first flowers this year about nine weeks ago, and to-day (16th inst.) there are still a few left. For eight weeks of that period we cut

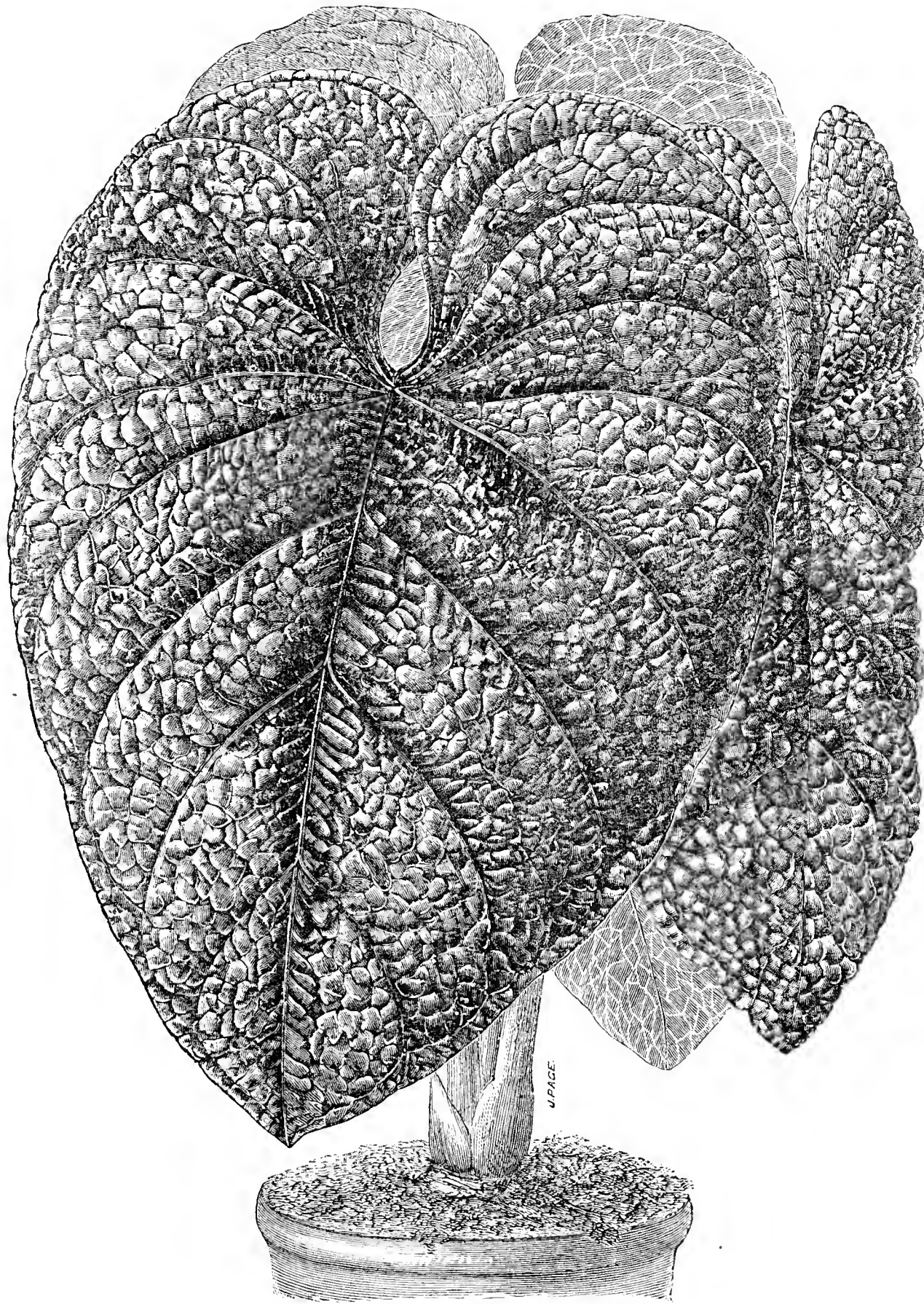

Fig. 81.—ANTHURIUM SPLENDIDUM.

basketfuls of its beautiful white star-like flowers almost daily, yet they were scarcely missed, so completely was the plant covered. It was literally one sheet of white, and justly admired by all who saw it.

It has one chief recommendation. I am told its flowers carry well, and that is a great consideration to many a gardener. I would say to all who have a spare piece of trellis in the greenhouse, conservatory, or any cool house—for our greenhouse never

has any artificial heat applied to it except to keep out frost or during cold cutting winds, which are very prevalent in this part—to grow a plant of this Clematis, either planted out or in a pot, and they shall be rewarded next February and March with an abundance of beautiful white flowers, all the more acceptable because white flowers are generally very much in demand at this particular season.

The Journal has already of late on more than one occasion, and

very properly too, strongly recommended its more extended culture, and I think it is so pretty, so useful, and so easy to grow that it cannot be too much praised.—HORTULANUS SECUNDUS, *Lochgilphead, N.B.*

ROYAL HORTICULTURAL SOCIETY.

APRIL 24TH.

THE conservatory bore an extremely bright appearance at this meeting, the numerous handsome groups of Orchids, Amaryllises, Rhododendrons, Clematises, and Daffodils producing a diversified display on one side, while the Auriculas on the other side also contributed largely to the attractions. During the afternoon there was a good attendance of visitors, notwithstanding the unfavourable weather.

FRUIT COMMITTEE.—John Lee, Esq., in the chair. The following were also present:—Messrs. Z. Stevens, J. Woodbridge, R. D. Blackmore, J. Willard, J. Burnett, S. Lyon, C. Silverlock, Philip Crowley, and G. Paul. Mr. J. Read, Moat Mount, Mill Hill, sent a new hearting Curled Kale, for which a first-class certificate was awarded. Mr. J. R. Allis, gardener to Major Shuttleworth, Old Warden Park, Biggleswade, showed a fruit of a seedling Cucumber, which was passed. Mr. C. Kershaw, Brighouse, sent samples of Kershaw's Paragon Rhubarb.

FLORAL COMMITTEE.—George F. Wilson, Esq., in the chair. The following were also present:—Messrs. J. Wills, J. T. D. Llewelyn, J. Douglas, Shirley Hibberd, John Fraser, W. Bealby, W. B. Kellock, John Laing, J. Dominy, H. Ballantine, James Hudson, H. Cannell, J. Cutbush, H. Ridley, P. Duffield, H. Turner, G. Baker, and J. McIntosh.

Mr. B. S. Williams, Upper Holloway, contributed a pretty group of Orchids, which included fine specimens of *Dendrobium densiflorum* with ten fine spikes; *D. Wardianum* with five long growths loaded with flowers; *Lycaste Harrisonæ alba*, a pure white variety of this fragrant Orchid; *Odontoglossum vexillarium splendens*, very dark-coloured; *Odontoglossum Halli*, fine variety; *Scuticaria Dodgsoni*, a new Orchid with brown-blotched flowers; and *Masdevallia Harryana*, large and of good colour. A fine collection of Cyclamens of their Giant and Brilliant strains, the flowers very large and richly coloured, the plants vigorous, and the blooms extremely abundant; they were tastefully arranged with Ferns and Palms. A group of richly coloured Amaryllises, prominent amongst them being Dr. Masters, Mrs. Gordon, William Pitt, and Mrs. Broome. Mr. W. Rumsey, Waltham Cross, sent seven boxes of Rose blooms very fresh and bright, representing a large number of varieties. C. Bown, Esq., Erdsleigh, Harvard Road, Gunnersbury, exhibited a dozen well-flowered specimens of Azaleas, of moderate size, but very healthy and bright.

Mr. C. Turner, Slough, sent several new Azaleas—*Antigone*, double, white, streaked purple; *Comte de Kerchovc*, large, single, streaked and spotted salmon-red; and *Hermosa*, double, rich rosy crimson. A plant of a Decorative Pelargonium named Dresden China was also shown, and is remarkable for its bright rosy-streaked flowers. It will no doubt become very popular. G. F. Wilson, Esq., Weybridge, sent a collection of seedling Auricula and Primrose flowers, and a plant of *Lilium Thompsonianum*, which has pale mauve flowers thickly on the stems, which were about 2 feet high. Messrs. J. Sander & Co., St. Albans, showed plants of *Phalanopsis Sanderiana*, which has pure white flowers like *P. amabilis*; *Cypripedium ciliolare*, a dull purplish flower somewhat suggestive of *C. hirsutum*; and a pan of *Pinguicula caudata*, the flowers, however, being small and dull purplish in colour. Messrs. H. Lane & Son, Great Berkhamstead, exhibited a large group of well-flowered Rhododendrons and Azaleas, the former bearing particularly large trusses. Messrs. R. Veitch & Son, Exeter, sent plants of *Rhododendron exoniense*, which were flowering profusely, both large and small specimens, the neat white flowers having a slight pink tinge.

Messrs. James Veitch & Sons, Chelsea, had a handsome group of Amaryllises, comprising several very fine varieties, the most notable being *W. S. Parker*, rich deep scarlet; *Marmion*, bright scarlet; *Goethe*, scarlet, white centre; *Mrs. Burbidge*, rose, striped creamy white; *Thomas Moore*, bright scarlet, fine form; and *Adolphus Kent*, neat dark scarlet. Mr. Charles Noble, Bagshot, contributed a charming group of Clematises in 10-inch pots, the plants being trained on conical trellises 2½ or 3 feet high, and flowering extremely well. The most notable varieties were—Singles: *President*, dark purple blue; *May Queen*, bright mauve, lighter in the centre, neat; *Krao* (new), rich purple, white centre; *Princess Beatrice* (new), pale blue; *Marguerite Dunbar*, bright blue; *John Brown* (new), rich purplish blue, lighter centre; *Duchess of Albany* (new), pure white; *Lord Gifford*, bright mauve; and *Miss Bateman*, creamy white. Of the doubles, the best were *Proteus*, rosy purple; *Elaine*, blue; *Aurora*, rose; and *Undine*, purplish rose, neat.

Messrs. Paul & Son, Cheshunt, exhibited a grand group of Roses in pots, both dwarfs and standards, which attracted much admiration owing to their fresh healthy appearance and the abundance of their substantial blooms. *Edouard Morren*, *Comtesse de Serenye*, *Celine Forestier*, *Duke of Edinburgh*, *White Baroness*, *Magna Charta*, *Comtesse Riza du Parc*, *Duke of Teck*, and *La France* being especially

fine. Messrs. H. Cannell & Sons, Swanley, Kent, showed a stand of Zonal Pelargonium blooms, representing two dozen varieties, all with very large brilliantly coloured flowers. A basket of the double yellow *Chrysanthemum coronarium Aurora* was also notable, and with a fine stand of double Ivy-leaved Pelargoniums formed a most interesting collection. Messrs. James Carter & Co., High Holborn, sent baskets of *Primula cortusoides amœna* and *Viola Perpetual Blue*, with plants of *Clematis coccinea* and *Imantophyllum Mrs. Laing*. Mr. J. Graham, Cranford, Middlesex, showed plants of a very large double yellow Wallflower, named *Cranford Beauty*, which was dwarf and free. Messrs. Barr & Son, King Street, Covent Garden, contributed a beautiful collection of Narcissuses, Scillas, Anemones, Chionodoxas, Fritillarias, and Muscaris, associated with Ferns and Aralias. Mr. Anthony Waterer, Knap Hill, Woking, exhibited seven boxes of profusely flowered Primroses, very diversely coloured and bright.

A bronze Banksian medal was adjudged to Dr. Paterson, Bridge of Allan, N.B., for a fine collection of Orchid flowers, comprising some good examples of *Vanda tricolor Patersoni*, and *V. suavis*, together with *Odontoglossum cirrhosum*, *O. Halli*, and *Masdevallia Veitchi*. A vote of thanks was accorded to Mr. Z. Stevens, The Gardens, Trentham Park, for a plant of *Odontoglossum Stevensi*, a variety with large flowers, white, heavily spotted with light brown. Messrs. Jackson & Sons, Kingston, were awarded a vote of thanks for a species of *Odontoglossum*, very distinct, the flowers being yellow barred with bright chocolate. Messrs. W. Thomson & Sons, Tweed Vineyard, Clovenfords, sent a very handsome collection of Orchid flowers, for which a silver Banksian medal was awarded. The Orchids represented were *Vanda tricolor*, *V. suavis*, *Cattleya Mendelli*, *C. Mossiæ superba*, *Zygopetalum Clayi*, *Cattleya intermedia*, *Dendrobium Wardianum*, *Odontoglossum crispum*, *Halli*, and triumphans. A vote of thanks was also awarded for *Odontoglossum Andersonianum*, with a large branching spike of three dozen flowers.

A cultural commendation was awarded to Mr. J. Douglas for three pots of Hoop Petticoat Narcissuses; the pots were 6 inches in diameter, with six to nine bulbs, and bearing from twenty to thirty large rich yellow blooms. Such handsome little specimens are rarely seen, and their value cannot be over-estimated.

In addition to the awards noted above, the following medals and votes of thanks were accorded to the exhibitors named:—A silver-gilt Banksian medal and the first prize of £6 to Messrs. Paul & Son, Cheshunt, for their handsome group of forced Roses in pots; silver Banksian medals to Mr. C. Noble for Clematises, to Mr. Rumsey for Rose blooms, to Messrs. Barr & Son for Narcissus blooms, to Mr. B. S. Williams for a group of choice Orchids, to Messrs. H. Cannell & Sons for Pelargonium blooms, and to Messrs. Thomson & Son of Clovenfords for Orchid flowers. Bronze Banksian medals were awarded to Messrs. A. Waterer for a group of Rhododendrons, to Mr. C. Bown for a collection of Azaleas, and to Dr. Patterson for a beautiful collection of Orchid flowers.

Votes of thanks were accorded to Messrs. Thomson & Son for a plant of *Odontoglossum Andersonianum*, to G. F. Wilson, Esq., for *Lilium Thompsonianum*, to Messrs. H. Cannell & Son for *Chrysanthemum coronarium Aurora*, to Messrs. Collins & Son for Anemone blooms, to Messrs. Jackson & Son for *Odontoglossum* species, to Mr. Z. Stevens for a fine plant of *Odontoglossum Stevensi*, and to Mr. Hooper of Bath for blooms of Roses and Pansies.

First-class certificates were awarded for the following plants:—

Rose White Baroness (Paul & Son, Cheshunt).—Blooms large, full, white, substantial, very faintly tinged with pink in the centre. A handsome variety.

Narcissus incomparabilis pallidus Princess Mary (Barr & Son).—Flower very large; sepals and petals broad, pale yellow, nearly white; corona very wide, rich deep yellow.

Clematis John Brown (Noble).—Flower of moderate size, eight or nine sepals, rich deep purplish blue. Very free and effective.

Scuticaria Dodgsoni (Williams).—Leaves terete, curved, 12 to 18 inches long; the flowers with narrow sepals and petals, yellow, heavily blotched or barred with chocolate, the lip large pale yellow with mauve spots.

Lycaste Harrisonæ alba.—Distinguished from the species by the sepals and petals being pure white, the lip having a few longitudinal streaks.

Rose Merveille de Lyon (Turner).—A beautiful Rose of the Mabel Morrison type, but stouter and fuller, white tinted blush. Very delicate and pretty.

Azalea Antigone (Turner).—Flowers double; petals broad, white streaked and spotted with purple. Very distinct and attractive.

Odontoglossum polyxanthum grandiflorum (Mr. Woolford, gardener to W. Lee, Esq., Downside, Leatherhead).—A grand Orchid with very large flowers; the sepals broad, yellow, heavily blotched with dark chocolate; the petals also yellow, with smaller spots at the base; the lip roundish acuminate, shining brown edged with white.

Cattleya Gaskelliana (Thomson).—A beautiful Orchid, with large blush-tinted sepals and petals; the lip fringed, golden yellow in the throat, and tipped with rich crimson.

Amaryllis Adolphus Kent (Veitch).—Flowers extremely neat and symmetrical in form, colour intensely rich deep velvety scarlet. One of the darkest and richest varieties in cultivation.

SCIENTIFIC COMMITTEE.—Mr. Loder in the chair.

Grafted Conifer.—Mr. Noble sent a specimen to show protuberant

growth produced at the place where *Picea nobilis* was grafted on the silver *P. pectinata*.

Abies Nordmanniana Attacked by Insects.—He also sent a bough from a tree terribly infested by coccus, to which the entire tree appeared to be succumbing.

Lilium Thomsonianum.—Mr. G. F. Wilson showed a plant bearing several spikes of flowers, which have as yet been somewhat seldom seen.

Rhododendrons.—Mr. Boscawen sent several sprays of various forms, all having been grown in the open air, but amongst Fir trees, which Mr. Llewelyn observed constitutes an excellent protection—viz., *R. Thomsoni*, *R. fulgens*, a pink variety of arboreum introduced (he believed) by Sir J. D. Hooker, a white seedling of much beauty, and Mrs. Townshend Boscawen. Mr. Llewelyn brought out blooms of *R. arboreum album* or *ochraceum* (?), having a white waxy campanulate corolla, very slightly spotted with black, the foliage having an ochraceous tomentum below. The tree is 15 feet in height. He also exhibited trusses of *R. Thomsoni*, *R. campanulatum*, *R. arboreum*, *R. Wallichii*, and *R. niveum*, all being in bloom now in the open air. He observed that all these would have been over at this time had not the buds been held back by the cold for a month before the March frost began. They are now blooming as if there had been no frost.

Arum italicum.—Dr. Masters showed a specimen of this plant found at Folkestone, a new locality; it elsewhere occurs in the Isle of Wight and Penzance. The leafstalks are much larger than in the common *A. maculatum*, and the arrow-shaped blade has rounded lobes at the base; it also produces its foliage much earlier in the year.

Primula elatior.—Mr. Boulger showed various specimens of this plant, received from Mr. Christie of Saffron Walden, described as scentless, but have a marked smell of Apricots. After a coppice had been cut it appears to run into several monstrous forms, such as fasciated, &c. He noted that single flowers appear to arise from lateral points on the rhizome, while the pedunculated umbel appears to be more terminal. This latter form, Mr. Henslow observed, is the one horticulturists now aim to develop, at the same time suppressing the isolated flowers. He also showed a supposed hybrid between *P. officinalis* and *P. elatior*.

Plants Exhibited.—Mr. Lynch showed the following plants:—*Cineraria Webbiana* from the Canary Isles, the night-flowering white *Nicotiana affinis*, *Tulipa Borszczowi* from Central Asia ("Botanical Magazine," 1882, No. 6635).

Sclerotium in Potato.—Mr. A. Stephen Wilson forwarded tubers diseased, and several microscopic slides of preparations of the *Sclerotia*, which were forwarded to Mr. Murray for examination and report.

LECTURE.—The Rev. George Henslow first called attention to the large series of *Primulas* exhibited, of various true species sent by Mr. Llewelyn, and numerous groups of crosses of *Primroses* as well as of *Auriculars* shown by the National Auricular Society and other horticulturists. He described the peculiar features residing in *Primula*, *Cyclamen*, and other members of the family, in that the stamens are opposite to the petals instead of alternating with them. This violation of the law of alternation was explained by the ordinary suppression of a second whorl of stamens. Next the dimorphic condition was described, commonly known as pin-eyed and thrum-eyed, which Mr. Darwin had shown to be co-related to cross-fertilisation. Then the symmetry of the flower was explained, and how under cultivation the whorls have their parts increased to sixes, sevens, or more together, greatly enhancing the beauty of the flower, while the colour becomes distributed into whole or self-colouring and laced-edged kinds. Curious malformations occur in which the calyx becomes coloured and produces the duplex form, or it may be partially green as well, giving rise to the var. *Smaragdina*, or pass into leaves, when it is called "Jack in the Green."

The lecturer next invited attention to some new forms of *Narcissus* exhibited by Mr. Barr, one of which, *Incomparabilis pallidus* the Princess Mary, received a first-class certificate. It possesses a remarkably broad yellow cup or crown. *Leedsii*, *Purity*, is a good white form; while *Incomparabilis Mary Read Vincent* had an entirely orange cup. Fine specimens of the Hoop-Petticoat *Narcissus*, or *Corbularia*, were shown, differing from ordinary *Narcissi* in having "declinate" stamens like those of *Amaryllis*.

THE INSECT ENEMIES OF OUR GARDEN CROPS.—No. 3.

BOTH the Gooseberry and the Currant have come into greater cultivation during the last few years, as it appears to me. The reason, I suppose, is an increasing demand for the fruits, especially for preserving. Owing to the excessive multiplication of cookery manuals of all sizes many housekeepers experiment in making jams, and waste perhaps nearly as much fruit as they use in numerous instances. Some, it may be, will associate a brisk demand for Gooseberries with the greater abundance of champagne (so-called), as in this age of luxury it has come to be the occasional beverage of colliers, so we are told. Explain it how we may, it is not uncommon to see not merely plots, but fields, planted out with these

bushes, and in the general way they yield satisfactory returns. They have, it is true, some troublesome insect enemies. I believe, on the whole, the Gooseberry is the greater sufferer from these. Some market gardeners—a few even in the London suburbs—pursue the old plan of putting rows of Gooseberries and Currants amongst fruit trees. Space is thus economised, but I think this is open to objection, because it may lessen the amount of light and air which the bushes obtain; moreover, various caterpillars and grubs that occur upon fruit trees in orchards, falling from the wind and other causes, are helped to ascend by the bushes, or may possibly feed upon them and cause further losses.

The insects that infest the Gooseberry are fewer than those that visit the Currant, and from their being rather conspicuous they ought not to prove troublesome where the bushes are carefully watched and attended to at those periods when these foes are best dealt with. Gardeners are now discovering this fact by experience, and I expect in the years to come we shall not hear as much about the Gooseberry caterpillar as we have in the past. There are two Gooseberry caterpillars about which we have frequent reports, and it is not always ascertainable to which the complainant refers, which somewhat interferes with our calculations concerning the prevalence of the two species. They belong, however, to entirely distinct groups, and in their habits they are also unlike. We may take first the caterpillar of *Abraxas grossulariata* (fig. 82), named in Latin from the Gooseberry, but in English called the Currant moth as well as the Gooseberry moth. I find the caterpillars are more partial to the latter than to the former. It is by no means exclusively a garden insect; the entomologist discovers it, often to his annoyance when seeking choice insects, feeding in lanes and woods upon a variety of plants. One of our leading entomologists considers its natural food to be the Blackthorn. It is an instance of a species taking a fancy to a garden plant, and occurring upon it more plentifully in a limited space than it does upon the plants that must have furnished it with food ere Gooseberries and Currants were cultivated.

The Gooseberry moth is one of those few species which show a



Fig. 82.



Fig. 83.

resemblance in colour and markings between the matured insect and the caterpillar. White is the ground colour of the wings, with streaks of yellow on the fore wings, and numerous black spots upon all, the size and shape varying much. Sluggish in flight, the moth flaps about the garden during the day, or rests upon walls, so during July they may be easily captured and killed, the removal of each female meaning the destruction of probably a hundred eggs or more. Mr. Newman has told us how he has watched them laying their eggs one by one upon the leaves of the Gooseberry and Black Currant; but though this is their more common practice, the eggs are also placed in small patches, as I have observed. Emerging in a few weeks, the young caterpillars feed until the commencement of winter, when they prepare for repose, frequently drawing together a leaf or two with silk, so as to form a sort of tent. But they also rest, especially in sheltered places, upon the twigs of their food-plant without any covering, rarely moving all the winter. I have seen them on Gooseberry bushes near London, looking quite sooty towards spring from the effects of the smoke. This, however, may help to keep them warm! Occasionally they hide themselves in empty flower pots, amongst the stones of a rockery, and so forth. After severe frost they may even be as stiff as to think like little stones if shaken in a jar, and yet revive to feed up through April and May, as is their habit, changing to chrysalis early in June.

These caterpillars attain a larger size than do the pseudo-caterpillars or grubs of the Gooseberry sawfly, which have also twelve sucker-like legs, beside the six horny legs near the head. In *A. grossulariata* there are but ten altogether. The head and legs are black, the body a creamy white, but with conspicuous stripes of orange or red, and black spots of various sizes here and there running into each other. If alarmed while feeding they double up and drop by a thread, hence it is not difficult to shake them off the bushes and secure them. Mr. Wood remarks that gentle taps are better than violent ones, because a sudden shake will bring down a party, when many will escape while some are being seized and

killed. But it is better to avoid having to remove the large caterpillars thus by dealing with them previously as juveniles. Should stray ones have been allowed to become chrysalids, they may be detected upon the twigs or branches by their bands of black and yellow.

Now there is not a single caterpillar upon the Gooseberry in the early summer that has not previously fed upon its leaves in the autumn, and if the insects were more generally searched for then there would be little trouble from them during the ensuing season. One gentleman, a naturalist rather than a gardener, has proposed the removal of all the leaves about September, whereby the new brood would be killed or starved. This is, however, an extreme measure. When the bushes are pruned caterpillars may be found and destroyed; they may also be killed by the application of dry sulphur, quicklime, or soot. The best time for this process would be when the bushes are moistened by dew. Syringing with a solution of soap or with some soapy compound is serviceable. And as it has been thought part of the brood winter upon the earth, or just below the surface (although I have seldom so discovered them), forking round the bushes and manuring may be of use.

Reserving until our next article a notice of the Gooseberry sawfly, I add a brief history of another Lepidopterous insect, the caterpillar of which feeds upon the Gooseberry. This is a "looper," like the species just described; in crawling, the fore and hind legs move in turn, so that the middle of the body is bent into a loop; and from this habit occurring amongst a large group they have also been called "geometers," or ground-measurers, the regularity of their locomotion being thus peculiar. Not sufficiently abundant to be injurious, the caterpillar of the V-moth (*Halia walaria*) nevertheless occurs in most parts of England in the Gooseberry during the autumn. It never attains to half the size of the preceding, but is a little slim caterpillar, greenish or buff-coloured, freckled with black warts. The moth flies in July. This is grey with a silvery gloss, a few black and white markings, and some very distinct deep brown spots near the tip of the wings, one of which is supposed to resemble the letter V.—ENTOMOLOGIST.

GARDENERS AND GARDENING.

GARDENING is not only one of the oldest, but one of the most elevating of pursuits. It is a pursuit that many people take great pleasure and pride in following, either as a means of acquiring a livelihood or as recreation. Although gardening has been practised since the creation of man, and deservedly held in high repute, it has, undoubtedly, made the greatest strides during the last half century. Gardening is now quite different from what it used to be even thirty years ago. The very prominent position it has now attained may be attributed, in a great measure, to cultivation under glass. The number of glass houses erected during the last half century is enormous, and the fashion is for everyone who can afford it to have one or more of such structures. In some instances I am afraid it has rather brought gardening and gardeners more into disrepute than otherwise. It frequently happens that the houses erected have been added without additional help being given, consequently something is neglected, or, at least, does not have that attention and care which is essential to all who attempt gardening if they wish to do themselves and their calling any credit. Moreover, some gardeners pay more attention to the glass structures than to anything else; others, again, care very little for the houses. But it is far wiser for a gardener to divide the time at his disposal to every department alike. Of course, as all practical gardeners know, there are some things that require, and must have, more attention than others. What I wish to impress more particularly is not to make too great a "hobby" of a few things and neglect others on their account. Again, the buildings and arrangements, especially in regard to heating, are often very unsuitable for the purposes intended. In some instances they are built merely to make a showy appearance, and sometimes without any reference being made to the gardener, in others more to utilise space and material at command. And lastly, the produce of gardens is often compared, not considering perhaps that in one of the cases there are specially built houses well adapted for the purposes.

Another very important addition within recent years, and one which, if it has helped to bring gardening more to the front, has added also to the gardeners' duties—*i.e.*, the bedding-out system. The evil is when thousands of these bedding plants have to be grown by inadequate means. Moreover, this style of gardening is often far too extensively practised. I would, therefore, say to all, Do not attempt what you know you cannot do as it should be done, and what you do attempt do well.

Again, one of the best, if not the most important additions to gardening, is the large collection of Conifers we now have to

select from for the embellishment of lawns, parks, and shrubberies. Either for grouping or as single specimens they are unrivalled. The smaller-growing kinds are grand too, and may be used effectively in many ways.

As to gardeners, they are, or at least are supposed to be, a wonderful class of men if the multiplicity of things they are expected to do in addition to the duties of the garden is any criterion to judge by. Gardeners have many difficulties and disappointments to contend with, even their own families often prove an obstacle to them. It is, however, a consolation to know that this is not always so; nevertheless, it is a well-known fact that the non-family man has the advantage. It has been truly said, "That the life of a gardener is one series of difficulties, many of these to be conquered, others apparently unconquerable." And again, "That disappointment is our daily fare, and without doubt that fare is good for us if we do not have too much of it." And finally, "That professional gardeners are often taunted for not recording their failures, but it must be remembered that many have to serve non-professional masters who are not enthusiastic learners, and have no sympathy with failures," though it is well known that failures are essential to success. Doubtless, as in other callings, there are good and bad gardeners, and some perhaps occupying good positions, with the best of houses and almost everything wished-for at their command, and, taking all things into consideration, not so successful as others with inadequate means. Indeed, gardeners having suitable houses for everything are very fortunate, for in most places something is not just as would be wished. I may here observe that my ideas are quite contrary to those who say a good man is sure sooner or later to meet with a good appointment. Influence, position, and opportunity are the gardener's best friends. Men lacking these requisites, be they good or bad, stand a poor chance of success. Hence the most deserving are not always the most fortunate, in fact the reverse is often the case.

Gardening having made great progress, the question naturally arises, Have gardeners made equal progress? Have they intellectually and financially advanced with the times? Intellectually I think I may say that they are well in advance. Financially I cannot speak so favourably. Taking into consideration the intelligence they are supposed to possess, and the high moral characters and attainments required, I must say that on the whole their services do not meet with that appreciation and encouragement they deserve. However, there are undoubtedly some whose services are well remunerated and appreciated.

Having now stated a few thoughts on this subject, I think it will be admitted by many that gardening as a business, dearly as many, if not all of us, have it at heart, is not so very desirable. However, as nothing worth the attainment is to be had without a little trouble, I trust the few remarks offered may not in any way discourage any young gardener, but rather stimulate him to further exertions. Consequently to all young gardeners I say, Persevere. Indeed, to be successful in any occupation a person must be assiduous. The successful man is he who is diligent and painstaking, and one who pays the greatest attention to every little detail in whatever he takes in hand. To inattention and impatience may be traced many failures. It is only by attending to little things that people are successful.

Another, and a very important requisite, is decision of character, without which a person will miserably fail in any undertaking. Through indecision and procrastination many promising young men have totally failed. To the same source many failures in gardening may be attributed. Let nothing connected with horticulture be beneath your notice. Devote all your spare time to improvement. Depend upon it nothing comes or is to be gained by wishing. In short, do all you can to merit success. Gardening prospects are certainly not so bright as we would wish them at the present time, agricultural depression in some instances having necessitated retrenchment, but doubtless there is a brighter prospect and a better future.—J. RICHARDSON, *Calverton Hall, Notts.*—(Abridged from a Paper read at a Gardeners' Meeting.)

ROYAL BOTANIC SOCIETY.

APRIL 25TH.

THE second Spring Show of the present year was held last Wednesday, the exhibits occupying a good portion of the conservatory, in addition to the corridor, which was filled. The competition was not very keen in any of the classes, but the miscellaneous plants and groups staged by amateurs and nurserymen were a great feature as usual. Altogether a very bright and agreeable effect was produced.

Stove and Greenhouse Plants.—A beautiful bank of healthy plants was formed by the exhibitors in these classes. In the open class for twelve Messrs. B. Peed & Son, Streatham, were first with handsome

plants of moderate size, but very well grown, the Azaleas being particularly good, Apollon (white), Eugénie Mazel, Jean Vervaene, and Comtesse de Flandres being the varieties. Mr. G. Wheeler, gardener to Louisa Lady Goldsmid, St. John's Lodge, Regent's Park, followed closely, Hibbertia Reedi, Leucopogon Richei, and Adenandra fragrans being very well flowered. Mr. H. James, Castle Nursery, Norwood, was a very good third, his plants comprising Dendrobium nobile with about six dozen large flowers, Anthurium Andreanum with six large spikes, and Erica affinis very healthy. Mr. H. Eason, gardener to B. Noakes, Esq., North Hill, Highgate, was adjudged a certificate for fair collection.

Auriculas.—Five good collections of a dozen Auriculas were staged in the open class. Mr. J. Douglas, gardener to F. Whitbourne, Esq., Great Gearies, Ilford, winning the chief honours with Campbell's Pizarro, twelve pips; Douglas's Mabel, Douglas's Conservative, Heap's Smiling Beauty, Campbell's Admiral Napier, Douglas's Duke of Albany, a deep maroon self with thirteen pips; Trail's Prince of Greens, with nine pips; Douglas's Miss Lodge, a grey-edge seedling with nine pips; Kay's Alexander Meiklejohn, Douglas's Lieutenant Charrington, a green-edge seedling with ten pips; and Spalding's Blackbird. Mr. C. Turner, Slough, was a close second with healthy plants; Mr. E. Pohlman, Parkinson Lane, Halifax, and Mr. J. Collier, gardener to R. K. Penson, Esq., Dinham House, Ludlow, being equal thirds.

Amaryllises.—For six plants Mr. H. Baxter, gardener to W. S. Parker, Esq., White Lodge, East Barnet, was placed first with good specimens of Madame Patty, W. S. Parker, Marquis of Lorne, Olga, Alexandra, and Percival. Mr. J. Wiggins, gardener to H. Little, Esq., Hillingdon, was second with plants nearly equal to the former in merit.

Pelargoniums.—In the open class for nine Show Pelargoniums Mr. C. Turner, Slough, was the only exhibitor, showing remarkably good plants, healthy, vigorous, and freely flowered, the blooms being very fresh, large, and richly coloured. The varieties were La Patrie, Duchesse of Edinburgh, Joe, Delicata, Sappho, Duchesse of Bedford, Duchesse de Morny, Venus, and Lady Isabel.

Cinerarias.—Mr. J. James, Woodside, Farnham Royal, Slough, was placed first for nine Cinerarias, and staged a beautiful collection, the blooms of great size, substance, and deeply coloured. Mr. Wiggins was second with very dwarf compact plants, but the flowers much smaller than the preceding.

Azaleas.—Mr. R. Ratty, gardener to R. Thornton, Esq., The Hoo, Sydenham, was first with a collection of six Azaleas in the amateurs' class, his plants being well-trained pyramids abundantly flowered. Mr. G. Wheeler was second with smaller and less formal specimens, Mr. Wiggins being third. Mr. C. Turner was first in the nurserymen's class with well-bloomed plants; Messrs. B. Peed & Son second with globular specimens a mass of flower; and Mr. H. James was third with smaller examples.

Hardy Plants.—Messrs. J. Carter & Co., High Holborn, were adjudged chief honours for twelve hardy plants, comprising neat examples of Symphytum officinale variegatum, Primula cortusoides amœna, Iris pumila azurea, Aubrietia Campbellsii, Primula viscosa, and others. J. D. Llewelyn, Esq., Penllergare, Swansea, was a good second, Narcissus triandrus, Ranunculus amplexicaulis, and Anemone Robinsoniana being very notable.

Roses.—Messrs. Paul & Son, Cheshunt, were awarded the first prize for nine Roses in pots, their plants being extremely fresh and vigorous. The varieties were Anna Alexieff, Comtesse de Serenye, Edouard Morren, Madame de St. Joseph, John Stuart Mill, Celine Forestier, Magna Charta, Madame Lacharme, and La France.

Only one collection of twelve Rhododendrons was staged, for which Messrs. H. Lane & Son, Great Berkhamstead, were awarded the first prize, their plants being well flowered and healthy.

MISCELLANEOUS.—A large silver medal was awarded to Mr. B. S. Williams, Upper Holloway, for a group of choice Orchids similar to that shown at Kensington on the previous day together with some fine Amaryllises and excellent Cyclamens. A large silver medal was awarded to Mr. Wiggins for a large group of Cyclamens exceedingly well grown, the flowers numerous, symmetrically formed, and richly coloured. Mr. C. Turner had a pretty group of Alpine Auriculas, comprising some of the best varieties. Mr. Edward Pohlman also had a collection of laced and shaded Alpine Auriculas. A silver medal was awarded to Messrs. Paul & Son, Cheshunt, for a group of Roses in pots bearing some handsome blooms. A large silver medal was awarded to Mr. W. Rumsey, Waltham Cross, for eight boxes of beautiful Rose blooms. A certificate was awarded to Mr. H. Hooper, Bath, for stands of Pansies and Rose blooms.

Messrs. J. Veitch & Sons, Chelsea, had a group of new Amaryllises, comprising most of those shown at Kensington on the previous day. Messrs. Robert Veitch & Son, Exeter, sent flowers of Rhododendron gloxiniflora, very distinct, neat in form, of moderate size, white, with a few purple dots, the trusses compact. They also sent plants of R. exoniensis very free. A large bronze medal was awarded to Messrs. H. Cannell & Sons, Swanley, for cut blooms of Zonal and Ivy-leaved Pelargoniums and plants of Chrysanthemum coronarium Aurora. A small silver medal was awarded to Mr. Young, gardener to Capt.

A. Patton, Alpha House, Regent's Park, for a beautiful collection of hardy flowers, comprising Narcissuses, Primulas, Fritillarias, Muscaris, and others, with a back row of Dielytras and Begonia semperflorens grandiflora, the margin being small Pterises and Isolepis. The general arrangement of this group was most pleasing and tasteful. A small silver medal was awarded to Messrs. Barr & Son, King Street, Covent Garden, for a very extensive collection of Narcissuses and other hardy flowers. A silver medal was adjudged to Mr. C. Noble for a handsome group of Clematises, and a similar award was made to Messrs. Cutbush & Son, Highgate, for a beautiful collection of Azalea mollis varieties, with Statics and other plants. Messrs. Collins Bros. & Gabriel sent a collection of Giant Ranunculus flowers and Anemone blooms.

POTATOES FOR TABLE AND MARKET.

(Continued from page 323.)

In the following notes the figures 1, 2, and 3 indicate first early, second early, and late varieties; the months the time of planting; and the asterisks those varieties that are considered the best for market purposes by the respective cultivators.

IRELAND.

ARMAGH.—1. Middle of February, soil permitting. Ashleaf, Veitch's and Rivers' varieties, *Flounder, *American Rose, and *Cumberland Kidney. Soil.—Medium, but in many parts of this neighbourhood heavy. 2. End of March and early in April. *Taylor's Fortyfold, *Early Cruftle, Dalmahoy, and Walker's Regent. 3. Beginning of April. *Scotch Champion, *Skerry Blue, the Rock, and *Magnum Bonum. Manures and Application.—We chiefly use good farmyard manure from 25 to 30 tons per acre. Have tried artificial manure extensively, but prefer the former. It is sometimes ploughed in during autumn, but more frequently placed in the bottom of the drill at planting. Our soil is a stiffish loam and difficult to work. General Culture.—Our system of culture is that usually adopted in field cultivation, frequently running through the growing crop with the grubber, and landing up with the plough. We have had such a deluge of rain in this part for the past few seasons we find it difficult to get anything done with the crop where land is heavy.—W. ALLAN, *Brownlow House Gardens, Lurgan.*

CARLOW.—1. November. Old Ashleaf and *Beauty of Hebron. Soil.—Medium on south border. I spread the manure on the ground, dig it in, and plant the tubers 6 inches deep, giving a light covering of stable manure. 2. February. Red Bog Scotch, Kemp, and *Early Oxford. Soil.—Heavy. 3. March. *Magnum Bonum and *Scotch Champion. Manures and Application.—Manure light from the stables. I prefer trenching and light manure for Potatoes; they are not so liable to disease.—JOHN SEWELL, *Ballin Temple, Tullow.*

CLARE.—1. 1st of February, according to the state of the weather. *Royal Ashleaf Kidney, best here for market first crop, and stands spring frost best; and Early Rose. Soil.—Light loam. 2. Middle of March. *Paterson's Victoria, the best for table; and Schoolmaster. Soil.—Heavy retentive loam. 3. End of March. *Champion and Magnum Bonum. Manures and Application.—Stable manure applied in November. General Culture.—The soil here, being a retentive loam and not such as we should choose for Potatoes, I have adopted a system of tillage practised in the north. I cast the manure over the soil in November, and mark out in beds 3½ feet wide, 1½-foot furrows, casting the furrows over the beds to the depth of 12 or 13 inches. The furrows carry off the surface water, and cause the beds to be sweet during winter. In dry weather in spring it is dug down and the Potatoes planted in drills without manure.—WM. WILSON, *The Gardens, Dromoland Castle, Newmarket-on-Fergus.*

CORK.—February. Rivers' Royal Ashleaf, *Gloucestershire Kidney, and Mona's Pride. Soil.—Medium. 2. March. Early Dalmahoy, *Grampian, and Fox's Seedling. 3. April. *Magnum Bonum, *Scotch Champion, and Paterson's Victoria. Manures and Application.—Good stable manure and soot dug in and thrown up as rough as convenient in November. I have also used burnt earth, wood, &c., with good results as a top-dressing before earthing up. General Culture.—I always prefer planting in drills made with the spade. When planted with a dibber I have often found the Potatoes come up uneven.—JOHN WOOLFORD, *Gardener to Earl of Bandon, Castle Bernard, Bandon.*

DOWN.—1. Last week in February. Old Ashleaf, Early Rose, and Snowflake. Soil.—Light loam. 2. Last week in February if the ground is dry enough; if not, as soon as possible after. Fortyfolds, Schoolmaster, and Regents. 3. Planted about the last week in March. *Scotch Champions, *Skerry Blue, and *Paterson's Victoria. Manures and Application.—Half farmyard manure with 2½ cwt. each of bone-dust and guano mixed. General Culture.—We grow but few Potatoes in the gardens here, as we have to supply the kitchen for about

three months only. We find the old Ashleaf Kidney, Schoolmaster, Fortyfold, Snowflake, and Champions the best liked. This is about the best Potato locality I am acquainted with, even in the most adverse season. In the home farm about 6 acres are grown annually, principally Champions, and they turn out from 10 tons in a bad season to 12 tons in a good season. They are planted in drills about 28 inches apart and 14 inches between the sets. In the line of manure they receive about $2\frac{1}{2}$ cwts. of bonedust, $2\frac{1}{2}$ cwts. guano, and half farmyard manure to the acre.—THOMAS RYAN, *Gardener to Earl Annesley, Castlewellan.*

GALWAY.—1. As early in the season as the weather permits. January, February, or early in March. *Veitch's Ashleaf Kidney. Soil.—Light sandy loam. 3. As early in the season as the weather permits—January, February, or early in March. *Champion, Magnum Bonum, and Schoolmaster. Soil.—Mostly reclaimed bog land for the Champions, which do well. High-lying loamy soil for Magnum Bonum, otherwise they would not be eatable. Manures and Application.—Half farmyard manure only partly decayed, and half guano with superphosphate mixed. General Culture.—Ashleaf Kidneys are planted whole, 2 feet apart in the drills and 1 foot from set to set, in ground manured for the previous crop, with a small shovelful of burnt ashes and leaf mould over each set. Champions are planted 3 feet apart and 18 inches between the sets; the manure spread in bottom of the drills and the artificial manure dusted over the sets, which are cut, but not too small, and planted and covered, but not too heavily at first. They afterwards receive two earthings and yield heavy crops. Magnum Bonum is the best spring Potato with us.—JAMES GARNIER, *Kylemore Castle.*

KILDARE.—1. February. Ashleaf. Soil.—Medium. 2. Coldstream. 3. March. Victoria, Magnum Bonum, *Champion. General Culture.—The land is ploughed and the Potatoes planted in drills 3 feet apart, 10 inches in the drill: Champions, 12 inches. Manure is placed over the sets. The ground is grubbed three times, and the Potatoes earthed-up as early as possible. Farmyard manure is employed.—J. ANDERSON, *Palmerstown, Straffan.*

KING'S COUNTY.—1. From the middle to the end of February, weather and condition of soil being favourable. *Ashleaf Veitch's Improved, *Beauty of Hebron, Snowflake, and *Early Rose. Soil.—Medium. 2. Middle of March. *Yorkshire Hero, *Schoolmaster, Dal-mahoy, and *Porter's Excelsior. Soil.—Heavy clay subsoil. 3. End of March. *Magnum Bonum, Paterson's Victoria, and *Scotch Champion. Manures and Application.—I have tried different methods of applying manure, and have invariably found the most satisfactory results from ground which received a good dressing of stable manure in the autumn, it being then thrown into rough ridges until planting time arrives, the soil here being wet and heavy. General Culture.—Defer planting until the ground is in a proper condition to receive the tubers, allowing plenty of room. Overcrowding is a great evil in the culture of the Potato. I do not earth up my Potatoes in the ordinary way, but when the stems are about 6 or 7 inches high I have the ground between the rows forked over, and only slightly inclined against the stems on each side as the work proceeds. The space between the rows of early varieties is then covered 2 or 3 inches deep with short grass mowings.—I. J. HART, *Birr Castle Gardens.*

REVIEW OF BOOK.

Artificial Manures. GEORGES VILLE. London: Longman & Co.

THIS, the second edition of a work famous in France and America, but less known in this country, is a series of lectures delivered at Vincennes some years ago by M. Georges Ville, and embodies the results of that gentleman's experiments at the place named. The work is characteristically French—that is to say, unbounded enthusiasm appears on every page. It has been said that nothing worth having can be gained without enthusiasm. This may be so far true, but when it acts like a runaway horse it is apt to take its victims too far, and this, especially in experimental science, has serious drawbacks. Possibly our prejudices may influence us, but an idea has taken possession of us that the pre-eminently English quality of the power to plod, plod on over mountains of difficulty, no matter how steep the path, and over quagmires however treacherous, is less apt to mislead either the plodder or his disciples. M. Ville thinks that though artificial manures are more extensively used in England, Frenchmen are better acquainted with their action. Taking Ville himself as an authority on the state of knowledge among French cultivators of the soil, we think our countrymen will stand a comparison with favourable results. Indeed, one cannot unbiassedly read through the enormous amount of collected information of experiments in scientific agriculture by Messrs. Lawes and Gilbert alone, to say nothing of other earnest workers, without feeling that it is indeed the English who know far most on the very subject Ville imagines us to be not well informed; and we may add that the knowledge gained on our side the Channel is of a real, solid, if of a somewhat doubting kind, and not a will-o'-

the-wisp born of enthusiasm, which, we may say frankly, is very characteristic of the book before us.

M. Ville is the friend of the farmer. This is apparent in the very preface. There is a table inserted there to show that farmers pay 12s. per cwt. for manure, the materials of which cost no more than 6s. $5\frac{1}{2}d.$, and which farmers might have for 7s. $2d.$ if they would form themselves into co-operative societies or mutual supply associations. Manufacturers will thank neither M. Ville nor us for the idea, but it is certainly a good one, and well worth considering.

The author (against the world) is fully convinced of the power of certain plants—the Sugarcane and members of the Leguminosæ for instance—to assimilate the free nitrogen of the air. This is proved by *logic* instead of by scientific tests. We are shown that certain crops contain much more nitrogen than is applied to them; that the nitric acid and ammonia supplied from the air cannot account for more than a fraction of the increase, and are asked to consider this as proof that the increase has been assimilated from the air in the form of free nitrogen. This is enthusiasm and not science. We can discover nothing to show that M. Ville has considered it necessary to ascertain whether the nitrogen always present in the organic remains of every soil has suffered diminution. Had this been done we imagine that even M. Ville himself would have doubted.

Our author is not, it appears from the following, quite sure of his own assertion. He proposes that £100,000, internationally collected, should be offered as a prize for a method of converting the free nitrogen of the air into an assimilable compound, and offers to head the list with £40. Very good. But if Peas, Beans, Clover, Lucerne, &c., already do so, and for nothing—nay, give us the richest of foods besides, the problem has been solved! Why then the £100,000? Ammonia sulphate at 1*l.* per lb., we are told, means cheap bread and cheap meat; but if Clover and Beans assimilate free nitrogen, why not cheap meat now? If such feeding secures manure rich in nitrogen and the Clover remains furnish more, why not cheap bread now? These questions M. Ville would have some difficulty in answering.

It is when theories are left behind for what actual experiments have proved that the teachings of Ville become of value as the common property of mankind. Experimenting at Vincennes with chemical manures, it was found that a liberal application of mineral manures on a soil unusually deficient in the mineral food of plants, without nitrogenous manures gave 18 bushels per acre. With no manure at all the yield was only 12. When nitrogenous manure alone was given 22 bushels was the result; but when the two were combined, $50\frac{1}{2}$ bushels was the amount of grain per acre. This experiment is illustrated with a diagram which shows at a glance even more decidedly than figures do the difference between the samples.

In another experiment at Champagne 32 tons of manure gave 14 bushels, but what Ville calls normal manure gave 36. On a sandy soil, which without manure at all gave only $2\frac{3}{4}$ bushels, and with 16 tons of farmyard manure $8\frac{3}{4}$, chemical manure gave 31 bushels per acre. An instance is given when in Italy on poor land a large quantity of manure gave from 9 to 11 bushels, but Ville's mixture gave from $27\frac{1}{2}$ to 33 bushels per acre. Almost all of these experiments have been made on land of a poor description; but, unfortunately, most of the land in England, as well as in France, appears to be in this condition. On richer soils equally striking results need not be looked for, but, taking the land as a whole, there is reason in the assertion that the proper use of chemical manures would render England and France independent of America. Startling though such an assertion may appear, it is less so when we consider that millions of acres are idle, or afford a scanty pasturage only, and yet are capable of raising good crops by the aid of manure, and that more than one-half our land yields only half what it might, and even the best seldom a full crop.

Tables are profusely given showing that perfect manure must contain nitrogen, phosphoric acid, potash, and lime, and when any of these are left out the crop suffers. Not only Wheat, but all other farm and many garden crops have been experimented on, and the same tale is told by all. It is shown, however, that the Legumines are not benefited by manurial applications, and Sugarcane but slightly so. Chemical manures raised the latter crop from 24 cwts. to 23 tons!

We are tempted to linger over the work, and to quote largely. As the work has been put into an English dress our duty to our readers is done by indicating the nature of the book, by warning them against some theories in it not sufficiently supported by evidence, and to the results of practical experiments. It would be well were all cultivators to procure this work and to study it carefully. It would be better still if it were studied in the light of what has been discovered by others. It is not always necessary to include lime as M. Ville insists, for on thousands of acres lime is already abundant. Moreover, it may be obtained in a cheaper form

than the sulphate. Even potash is not always wanted, even though Ville's experiments point that way. Some soils—that of the fertile Carse o' Gowrie, for instance—contain more potash than can possibly be used up in hundreds of years even with the most exhaustive methods of culture. In such cases it would be throwing money away to apply what is there already. Ville's advice to analyse the soil by trying on a small scale how long plants will give a maximum yield with this, that, and the other substance withheld, we can recommend as superior in every way to costly chemical analysis, which may tell what soil contains, but not what it will yield. We may also draw attention to the remarks on the difference between the market value and the cost of stableyard manure, but experience tells us that he is wrong when he tells us that chemical manure *alone* is superior to a mixture of chemical and farmyard manure. Chemical manure, properly used, will undoubtedly do a great deal towards increasing all kinds of crops by supplementing farmyard manure, and, by producing greater quantities of straw and fodder, increase even farmyard manure. Ville considers that a knowledge of the subject and its universal application would save us from forty to eighty millions sterling a year. As a first step towards sharing in the "plunder" we can conscientiously recommend a study of the work in question by every cultivator of the soil.



[By the most skilful Cultivators in the several Departments.]

KITCHEN GARDEN.

EVERY effort must now be made to keep ahead with the work in this department. Kidney Beans may be sown now in a sunny dry position. A few rows of Runners may be placed in the garden, as they make good screens, but the Dwarf Kidney varieties, of which Canadian Wonder is the leading variety, should be sown together on a border. The rows may be 18 inches apart and 3 inches deep, and if the ground is heavy some old potting soil should be placed over the seed. Sometimes, especially if the weather is wet, the first-sown Kidney Beans are very apt to damp off just as growth is beginning, and this is mainly caused through the soil with which they are covered being wet and heavy. The main crops of Beet, Salsafy, and Scorzonera should now be sown in mellow and deep soil. Planting late Potatoes should be finished as soon as possible.

Where late Broccolis occupy ground which is required for other crops do not wait for them all heading, but lift them and place in a shady corner. Water well, and they will form heads just as well as if left in their growing quarters. More Peas for producing crops in August should be sown, and a small sowing of Radishes and Mustard and Cress may be sown fortnightly for the next four months. Small quantities of Lettuces may be sown frequently. Nothing gives more satisfaction in a kitchen garden than having the different crops coming-in in succession. Perhaps the best guide in the case of Peas, Turnips, and Spinach is to always sow a little more seed as soon as the plants from the previous sowing can be seen above ground.

The Dutch hoe should now be often used in all kitchen gardens. Wherever the surface appears bard or weedy between any growing crop hoe at once. Earth-up spring-planted Cabbage and Cauliflower plants. In exposed situations this prevents them shaking about. Thin out all young seedling vegetables as soon as they have formed the first rough leaves. Long stems are useless, and are the result of crowding. Short, dwarf, robust plants, of all things, can only be secured by giving them sufficient room to develop, and they should always have this from the very first. Asparagus should have another slight dressing of salt or kainit, which we prefer to the former. We never measure or weigh this, but give a small handful to each root; it is shaken round a few inches from the stems.

As frames are cleared of early Potatoes, Carrots, &c., fill them with Vegetable Marrows, ridge Cucumbers, and any other tender crop. Vegetable Marrows will grow in the ordinary soil of the garden, but they fruit much better on an old dung bed, and so do ridge Cucumbers. The earliest Celery plants should now be barded off with the view of planting them in the trenches at an early date. Late plants will come forward rapidly if dibbled into the old Potato frames. Our plan is to plant a Marrow in the centre of each light and fill up all round with

small Celery plants, and these are taken away and planted before the Marrows have run very far.

Cucumbers under glass require to be stopped now once or twice weekly. The most fruitful way of treating them is to stop the shoots at every joint. Thin training has many advantages, and light cropping is the only way to secure a long succession of fruit from the same plants. When the roots appear to be very plentiful on the surface of the mounds a slight top-dressing of loam and manure should be put over them. Tomatoes under glass now require a good deal of pinching and training. Superfluous growth should have no headway. Do not syringe any plants in bloom. Give abundance of water at the roots, and those in full bearing should have copious supplies of liquid manure. Plants intended for open air culture should be gradually exposed to the outside atmosphere.

FRUIT FORCING.

Melons.—The fruit in the early house being nearly ripe will therefore require syringing less frequently, and in damping the house avoid wetting the fruit, as that would impair the quality and may result in its cracking. A somewhat high, dry, and airy atmosphere is most suitable during the ripening of the fruit. It is, however, important that the plants be clean and healthy, otherwise well finished and highly flavoured fruit cannot be expected; and to effect this the plants must have sufficient water at the roots, and the atmosphere must not be kept so dry as to injuriously affect the foliage. If the plants are healthy they will have set or made growth, on which a second crop of fruit may be taken without prejudice to the fruit now approaching maturity. The drier condition of the atmosphere will aid in the blossoms setting for the second crop, which should be fertilised, and after a sufficient number of fruits are set remove all blossoms, stopping and thinning the growths as necessary. When the ripe fruits have been cut stir the surface of the bed, add a little fresh soil if necessary, and give a good soaking of tepid liquid manure, syringing freely on all favourable occasions. Succession houses, pits, and frames will require daily attention in stopping, tying, thinning, and fertilising the blossoms. As pits and frames are cleared of early Potatoes they can be utilised for growing Melons—the plants being previously prepared. It will suffice to remove the soil, and then turning over the leaves, adding more if necessary, and, making a hillock of soil in the centre, put out the plants when the soil becomes warmed, shading for a few hours in the middle of the day if the sun be powerful until the plants become established, when shading should be discontinued. Continue to make successional sowings.

Peaches and Nectarines.—Mild moist weather is highly favourable to Peaches now taking their last swelling. A high and moist atmosphere will insure the swelling of the fruit to good size, and any time lost during the stoning process may now be regained by closing early on fine afternoons with liberal moisture. Syringe the trees early on fine mornings and again at closing time, or from 2 to 3 P.M. On no account allow the roots to want for water, as the great breadth of foliage enables the trees to absorb great quantities of tepid water passed through a heavy mulching, or even liquid of a stimulating nature, if the trees are not very luxuriant. Deficiency of moisture at the roots is the chief source, next to overcropping, of the premature dropping or ripening of the fruit before the last swelling is completed. Although Peaches ripen the best when the trees are restricted during the last swelling, the tying-down must be completed in time, for the purpose of exposing the fruit to all the sun and air required for the colouring, and where the trees have filled their allotted space the points of the shoots in advance of the fruit may be removed. Continue to disbud and thin the fruit in succession houses, and do not after this period leave the fruit in excess of the intended crop, as trees in vigorous health under judicious treatment will not cast more than a small percentage. Trees in late houses appear to have set every blossom, and require close and careful attention in removing the surplus fruit gradually. Syringe well and encourage free growth by closing early, or from two to three o'clock on fine afternoons. If apbides appear fumigate with the foliage dry on a calm evening.

Pines.—A moist and genial heat of 70° to 75° at night, and from 80° to 90° throughout the day, will be most suitable for fruiting plants, ventilating and closing the house at about 80°, keeping the heat at the roots regular at 90°, and carefully attend to watering the plants, as very much depends upon this being properly performed. Avoid strong stimulants, but these in a mild form should be given on every occasion of watering. Vigorous plants in 10-inch pots should be examined about twice every week if the weather be at all sunny. Remove all superfluous suckers as soon as they are large enough to have the heart screwed out, reserving one for stock on each plant, which is ample unless

the stock is to be increased beyond its present strength. Successional plants intended to show fruit in autumn should be encouraged to grow rapidly and sturdily, syringing them once or twice a week. As a rule a sprinkling may be given this season whenever the axils of the leaves are dry, but it should not be given so abundantly as to run down the collar of the plant.

PLANT HOUSES.

Store.—Allamandas, Bougainvilleas, Clerodendrons, Stephanotis, Dipladenias, and similar plants are now growing rapidly, and will require more water at their roots as well as more moisture in the atmosphere. The shoots will also require constant attention in tying if trained upon wires under the roof; if upon a trellis, do not tie the shoots until they show flower. For the accommodation of the two last small cords should be secured to the trellis and to the roof, and the shoots trained to them temporarily. The earliest plants of Clerodendron Balfourianum are coming into bloom, and if they were not repotted when breaking into growth supply them liberally with stimulants. Cuttings taken with a sharp knife close to the old wood and inserted in sandy soil, covered with a bellglass and placed in heat, will soon form roots. These if potted on until they are placed in 6-inch pots and grown rapidly will make valuable plants for forcing the following season. Cuttings inserted at once of the useful double white sweet-scented *C. fragrans*, and then placed when rooted in 4 or 5-inch pots, will make useful decorative plants by July. Place the cuttings in single pots, as nearly every one will root, and use for them a compost of loam, a seventh of decayed manure and sand. A little seed of *C. fallax* may now be sown in light soil; cover the seed well and place it in heat, and as soon as the plants are large enough place them singly in small pots.

The earliest Gardenias have flowered, and can be thrown away if plenty of young stock has been propagated to replace them; if not, prune them, and place the plants in brisk moist heat until they commence growth. Repot all that are to be retained for another year if they require it, as well as the young plants, which will need this attention from time to time. Stop the shoots as they extend, which is essential to the production of bushy young specimens. The tops of Crotons, Dracaenas, Dieffenbachias, and others that were rooted in 4-inch pots will now need a larger size, and must be potted as needed. The young stock that has been raised from portions of stem must be potted singly before the roots become matted in the pans. The same remark applies to *Ixoras*, *Rhynchospermum jasminoides*, and others.

Caladiums that require it should have larger pots if good specimens are wanted, but for decorative purposes they are the most useful in 5, 6, and 7-inch pots, while small varieties will succeed in less, provided they are well supplied with stimulants. Successional batches can now be started. The earliest Gloxinias are coming into flower. Shift others that were placed in small pots to commence with, as well as any small tubers that may have been started with the earliest batch. Introduce others into heat, and prick off seedlings as soon as they are large enough. Achimenes that were started some time ago are ready for transference to pans and baskets, and are handsome in the latter when well grown. Use for these a light compost of fibry loam, rough leaf soil, and a seventh of old Mushroom-bed refuse, to which is added a liberal quantity of coarse sand. As soon as they are established in their pans and baskets cut off the ends of the shoots, and insert them in 4, 5, and 6-inch pots, and place them in a close frame, and in about ten or fourteen days they will be rooted. The tops, if allowed to grow together, make beautiful plants for decoration, varying according to the variety from 9 inches to 1 foot in height, and furnished with flowers down to the rims of their pots.

Celosias and Cockscombs sown a short time ago should now be placed in 2-inch pots, using a light compost. Shade from strong sun until established, and place close to the glass in a night temperature of 60°. Plunge the small pots, if possible, to prevent them drying so rapidly.

THE BEE-KEEPER.

BEE-FEEDING.

"P. H. P." thinks that early stimulative feeding this exceptional season will prove to have been very disastrous. He evidently leans to late in preference to early stimulative feeding. But are not both necessary? I value the late feeding very much, but is the result of stimulative feeding in autumn as certain in

inducing the queen to continue laying as it is in inducing her to commence? I hardly dare "rush in" with an answer to this query while so many wise and successful apiarians appear to have settled this matter by stating that influx of supplies at any time will cause the queen, if healthy and young, to lay. Still it is reasonable to suppose that, after all the heavy laying of the queen during the hot months, it may be less easy to stimulate the queen late in autumn than it is to stimulate her early in the spring after the few months' rest in winter. Be this as it may, although I have steadily fed late in the year, I must confess that on examination I have often missed finding any brood.

I quite agree with "P. H. P." that "the quieter the bees were kept the better for them," that is to say in February of this year; but again, was it possible to keep them quiet in such a February as it proved to be? I could not keep mine in spite of darkening entrances and other contrivances. Well, then, if they would fly out there was the increased consumption of stores and the lessened number of inmates, partly from labour and partly from cold. Therefore it seems to me that early stimulative feeding by providing brood to fill up these losses was still the most judicious course to pursue. Moderate early stimulative feeding does not provoke the queen to lay, as she lays later in the summer, and my own experience of my hives at the end of February was sealed brood in one or two bars only. Surely if the bees could not keep two bars warm it would be wiser to join them with a neighbour. It is very certain that the bees packed and declined to leave the pack even to feed at the bottle; but this exceptionally severe weather taught me one thing—that is, that whenever severe weather comes on after mild in the early spring I shall heap on the quilts, covering over the feeding bottles with them.

I may add, that when I was able at the beginning of April to examine the hives again I found all the sealed brood, &c., had hatched out, that laying had ceased and only just recommenced, a few eggs having hatched. Still I cannot help thinking that my hives were the better for the few bees that hatched-out through my early stimulative feeding. I should be glad to learn the opinion of bee-experts. I am only a learner.—Y. B. A. Z.

AUTUMN FEEDING VERSUS UNITING IN AUTUMN.

LATELY there was a discussion in the Journal whether by autumn feeding batches of bees could be raised late and so live through the winter, securing strong stocks in early spring. Most writers seemed to think that such would be the result of stimulative feeding. Mr. Pettigrew, while not, perhaps, denying the possibility of this, did not think the game worth the candle evidently, but strongly advised what he called the strengthening of the stocks by uniting, as the superior plan. Here, having no bees to unite to the two solitary stocks (June swarms), feeding in orthodox fashion to secure late breeding was resorted to, and now six British Association standard frames are densely covered with bees. No feeding has been given this spring till March, but there is still a good deal of sealed store in both. I fancy they must have bred not only in autumn, but, being strong, having plenty of food, and enjoying a mild winter, all through. At any rate they are both strong stocks. So much for stimulative autumn feeding.

The person from whom we bought the swarm in June is a follower of Mr. Pettigrew—or rather was. The only honey he secured last year was from a skep inhabited by a swarm earlier and stronger than ours. This was driven the first week of September into a bar-frame hive, and had other two hives added by uniting. In October it was full of bees and combs, and had plenty of sealed store, as it was liberally and rapidly fed with sugar syrup. At that time it was so full of bees that it was with difficulty contracted to eight frames. Now there is not a third of the bees, in spite of what Bonner would have called "reinforcement," that is in ours. They have a large amount of sealed store, but still the death rate must have been very high. There is no disease apparent; they are comfortably housed, as much so as ours, and if ours are not populous because of the late-hatched batches that have lived, and our neighbours' weak because of the superannuated bees that have died, what is the cause of the difference? One possibility occurs. Bees fed into stocks with sugar only, late in the season, store no pollen. Mr. Pettigrew showed, not long ago, that such stocks, nevertheless, lived; but he did not show that without pollen or a substitute bees bred. The possibility that strikes us is that our neighbours may have bred none just for want of, if not sustaining and maintaining food, at least of that needed for nursing. Most insects are voracious consumers of nourishing food in the grub state. Look at the riddled leaves of Cabbages for instance. And nobody has shown bee grubs to be an exception. That sugar-fed bees breed proves

nothing when old combs are present if these contain pollen, but when the very combs are the product of sugar, and no pollen is present, matters are different—at least we fancy so. We should like experienced pens to discuss the matter, and would like to hear if Mr. Pettigrew can explain away the above results, for he is the champion of the practice that led to them.—NOVICE.

TRADE CATALOGUES RECEIVED.

William Paul & Son, Waltham Cross, Herts.—*Catalogue of New Roses for 1883.*

William Bull, 53B, King's Road, Chelsea.—*Catalogue of New and Rare Plants for 1883 (Illustrated).*

Dickson & Co., Pilrig Park Nursery, Edinburgh.—*Catalogue of Florists' Flowers.*

The Continental Horticultural Company (J. Linden), Ghent, Belgium.—*Illustrated Catalogue of Plants.*

Constance Kerkvoorde, Wetteren, Belgium.—*Catalogue of Fruit Trees, Roses, Evergreens, and Plants.*



* * * All correspondence should be directed either to "The Editor" or to "The Publisher." Letters addressed to Dr. Hogg or members of the staff often remain unopened unavoidably. We request that no one will write privately to any of our correspondents, as doing so subjects them to unjustifiable trouble and expense.

Correspondents should not mix up on the same sheet questions relating to Gardening and those on Poultry and Bee subjects, and should never send more than two or three questions at once. All articles intended for insertion should be written on one side of the paper only. We cannot reply to questions through the post, and we do not undertake to return rejected communications.

Clematis with Imperfect Flowers (H. E.).—It is very difficult to give an explanation of such results without the conditions under which the plant has been grown are fully stated. Probably it is due in your case to the recent cold weather, which checked the plants and prevented the flowers developing freely. The Anemone appears to be a form of *A. coronaria*, but it was so much shattered that we could not determine it satisfactorily.

Double Cinerarias (A. J. Sanders).—Although the flowers sent are not equal to the best named varieties, such as Thomas Lloyd, they are still very good indeed, and far above the average of double Cinerarias obtained from a packet of seed. Their excellence, however, is, we suspect, in a great measure due to superior cultivation, and such trusses and flowers are certainly meritorious productions.

Exhibiting Auriculas (E. D. O.).—There is no stipulated size of pot for showing Auriculas in. The majority of the best plants staged are in small 48's, or pots about 4½ inches in diameter at the top; but numbers of very fine examples are grown and shown in 4-inch pots. It is a great mistake, and a somewhat common error with beginners in the cultivation of Auriculas, to grow them in pots needlessly large.

Tacsonia exoniensis (C. D.).—This is a very beautiful and free-growing climber, so free that it will in a short time so completely cover the roof of a greenhouse that only such plants as Camellias, Ferns, Palms, and others which endure shade will flourish beneath it. We have no doubt *T. manicata* is sold by several nurserymen, but it is beyond our province to recommend dealers.

Insects on Strawberries (J. A.).—You erred by not having the plants clean before the flowers expanded. Light fumigations on two or three consecutive nights will not injure them, but dusting with tobacco powder would perhaps be a safer and more effectual plan of killing the insects. The delay in the delivery of the Journal does not rest with us. The numbers are published in time for the early trains on Thursday morning, and you had better complain of your agent. We will also make inquiries on the subject, to which you very properly call our attention.

Fungus on Pear Trees (F. S.).—In all probability the fungus on the leaves and embryo fruit is the result of frost, which has ruptured the sap vessels, and the exuding juices have formed a suitable medium for the germination of the fungus that is now infesting them. The frost in some districts was quite severe enough to do this, even in unheated orchard houses, where the growths were a little more advanced, and consequently more tender than in the open air. We know of no better and simpler method of destroying the fungus than mixing a handful of sulphur in a pail of water, and with this carefully syringing the trees.

Foreign Potatoes (J. S.).—No one who is required to make the most of a garden by the sale of surplus produce ought to be expected to cumber the ground with Potatoes that are obtained from foreign sources, as not half of these can be relied on to afford anything like lucrative crops. You are evidently placed in a position of some difficulty, but not more so than some other industrious men whom we could name, yet with the exercise of tact and the perseverance which we are convinced you possess we shall be surprised if you do not succeed. Some employers are slow to learn the value of a servant, but they learn it in time if he displays ability and continuously strives to make the best and the most of the means at his disposal. He then ceases to be hampered with unreasonable conditions.

Cerbera Thevetia (F. G.).—The plant of which you sent a shoot and flower is *Cerbera Thevetia*, a member of the natural order Apocynaceae, and a native of the West Indies, whence it was introduced to this country about 1735. In South America and the West Indies it is said to attain the height of 15 feet, but it is rarely seen larger than a small shrub in this country. The plant has an acrid milky juice, which, like some of its relatives, is supposed to possess poisonous properties. It is rare in cultivation, and we understand that there is no living specimen of it in the Royal Botanic Gardens, Kew. When well grown it must be very handsome, and perhaps you will favour us with a few remarks upon the system of culture you adopt, and we should be glad if you could favour us with another good specimen in flower.

Fungus (Country Parson).—The fungus you have observed is probably either the Yeast Plant or the Vinegar Plant, though we cannot determine which it be without seeing a specimen or being furnished with a full description. Both these fungi have been regarded as peculiar forms of species of *Penicillium*. The Rev. M. J. Berkeley in his "Introduction to Cryptogamic Botany" says—"It is quite clear that yeast is merely an abnormal state of a fungus, very different in habit and forced into a peculiar mode of development by its submerged position." Again, in another portion of the book he observes—"Yeast is in fact nothing more than a peculiar condition of *Penicillium*, which is capable of almost endless propagation without ever bearing perfect fruit." Under the microscope the Yeast Plant is seen to consist chiefly of small globules, while the Vinegar Plant consists of delicate interlaced threads.

Thrysanthus rutilans (R. C. D.).—Young shoots, not too soft, inserted singly in very small pots in a mixture of sand and peat, the former predominating, and surfaced with pure sand, emit roots freely if the pots are plunged in bottom heat of 85° in a warm propagating case or under a handlight in a heated frame or pit; or several cuttings may be placed in a larger pot and covered with a bellglass, but we prefer the former method, as the roots are not injured by subsequently repotting. The soil must be thoroughly watered before the cuttings are inserted, and again immediately afterwards to settle the sand round them. The requisite amount of shade and moisture must be afforded to prevent the leaves flagging, and eventually light and air must be gradually admitted to insure healthy sturdy growth. Gentle bottom heat is of great assistance to the plants after they have been repotted, with slight shade from the sun during the forenoons of hot days, a warm moist general atmosphere being maintained, with careful ventilation, sharp currents of air being injurious.

Auriculas (Idem).—A position on the north side of a wall would not be good for the plants "all the year round." It would be suitable from June to September, and during the remaining months of the year the frame should be removed to a warmer and lighter position. The soil in the pots being moderately dry frost rarely injures Auriculas in winter, but is decidedly injurious in spring after growth has commenced and the flower trusses are visible; protection must therefore at this time be afforded.

New Potatoes (F. B. C.).—It is quite impossible for us to say what quantity of a new variety of Potato you should have before sending it out. Unless a Potato has been successfully exhibited—that is, has attracted attention at the leading exhibitions, or has been tried and found valuable by a few cultivators of repute in various districts, it is not likely to be eagerly purchased. As much appears to depend on the art of advertising as on the intrinsic merits of a variety in conducting its sale. We could tell of a new Potato which after being tried at Chiswick and honoured with a first-class certificate by the Royal Horticultural Society, the raiser had great difficulty in disposing of, and we doubt if he obtained 3s. a peck for his stock of a ton or two, which he hoped would bring him a small fortune. A skilled advertiser would have obtained a far better return. Nurserymen as a rule do not give much for a new Potato. They have so many offered to them that they can afford to refuse to give more than a moderate price. We are obliged by your letter.

Heating a Vinery (J. M.).—Whether four rows of pipes will be an advantage we have no means of knowing, as from the great mass of correspondence with which we have to deal it is utterly impossible that we can keep in mind the particular contents of letters that we answered weeks ago. If correspondents have occasion to write again on any case that has been previously submitted, it is essential that the particulars be repeated. We have not the slightest recollection of the size of your vinery, and can only say, that as it is a great mistake to limit the extent of piping, you have probably been well advised in increasing the heating surface. Miles of piping are fixed with indiarubber rings and there is no leakage. When you receive the pipes and rings you will see how the fixing is to be done; but if you have had no experience in setting a boiler and attaching and arranging the pipes, you will act wisely by employing a man for a day who understands work of this kind.

Italian Gardens (Willesden).—The best advice we can give you is to apply to the Directors of the Botanic Gardens at Naples (Baron V. D. Cesati) and Rome (Dr. N. Pedicino), and they will readily give you the best information for visiting the leading gardens in their districts. There is no Botanic Garden at Venice. There are some good gardens near Florence, notably those of Prince Demidoff and Marquis Corsi Salviati; and M. Beccari, the Director of the Botanic Garden, might inform you of some others. You will find a list of foreign Botanic Gardens, their Directors and Curators, on page 226 of our "Horticultural Directory," price 1s., post free 1s. 3d. This you might find useful in your travels.

Sulphate of Ammonia (Reader).—If you read attentively an article on the effects of manure on different kinds of Potatoes on page 227, the issue of March 15th of the present year, you will find that in experiments with strong-growing varieties nitrate of soda was worse than wasted, and the results would have been similar with sulphate of ammonia. The tendency of the manure is to induce a free growth of haulm rather than of tubers, and in the case of very strong growers such assistance is not needed. With weak-growing Potatoes the case is different, as a certain strength of haulm is necessary for the production of a good crop, and about 1 cwt. of sulphate of ammonia per acre, or half an ounce per square yard, applied as a top-dressing during dull or showery weather before earthing the plants, might be beneficial. Peruse the article to which we have directed your attention, and then exercise your judgment in the matter. This is also an excellent stimulant for Onions, but if applied too freely or too frequently it is liable to make them "thick-necked." The finest bed of Onions that we saw last year was the result chiefly of occasional waterings with liquid manure made of sheep dung and soot, a peck of the former and a spadeful of the latter being mixed in a tub with thirty or forty gallons of water. Sow *Ne Plus Ultra* Peas when the plants of *Veitch's Perfection* are just unfolding their leaves, and you will have a succession of pods.

Temperatures for Grapes (J. T. S.).—Your vinery ought not to be lower in temperature than 60° at ten o'clock at night, and 55° early in the morning

before the sun reaches the house. As the growth extends the heat should be slightly increased, and a minimum of 60° in the morning (65° at ten o'clock at night) will be safe during the flowering period. These temperatures may be maintained until the crop is ripe. These are low night temperatures, but in districts where there is an average amount of sun and early closing is adopted they will suffice. The day temperature by fire heat alone should be 5° or 6°, and the sun temperature 15° or 20° above the minimum night figures. The house should be closed as soon as possible in the afternoon, provided the heat afterwards does not greatly exceed 85°; the house, if not the Vines, to be thoroughly syringed at that time for producing a moist genial atmosphere. The top ventilators may be slightly opened afterwards, and left open all night, increasing the ventilation in the morning in advance of the temperature as it rises with the power of the sun. Too many amateurs permit the maximum sun temperature to be reached before admitting air, which is an unsafe, even a dangerous practice. We know in some seasons and districts such Grapes as the Black Hamburg will ripen without fire heat, and perhaps your neighbour is favourably situated. If there is not sufficient heat for ripening the wood it certain the frost will not ripen it, and unless the wood matures before the leaves fall the Vines will fail sooner or later. When Grapes are ripe admit abundance of air, and, provided the night temperature does not fall below 50°, you will have no occasion to fire except for maintaining a dry buoyant atmosphere.

Heating a Pit (*An Old Devon Subscriber*).—You do not trouble us in the least; on the contrary, we are glad to hear from you, and shall be more pleased still if we can aid you. The boiler you name is good, and we should certainly heat the pit. The plan you sketch would no doubt answer—indeed your past experience assures you on this point; but is such an elaborate method necessary? We are inclined to think not. The requisite bottom heat for Cucumbers and Melons could be well supplied in such a pit with fermented manure and leaves, and unless there was a scarcity of such material we should only provide top heat by the pipes by simply taking a flow and return pipe, one over the other, along the front within the space to be formed by your proposed partition. Even if we had to supply both bottom and top heat from the hot-water apparatus we should prefer a more modern plan of distributing it—namely, by conducting the flow pipe as indicated for top heat, and the return pipe to the boiler in a chamber under the bed for bottom heat, both these to be 3-inch pipes if the pit is to be started in April, 4-inch if you commence in March. If fermenting material is sufficiently plentiful and good for affording bottom heat, then two 2-inch pipes would suffice for top heat. By our plan of arranging the pipes more heat with a less consumption of fuel would be supplied to the bed than would result by your more elaborate method, which we know by experience looks better on paper than it would act in practice. To produce sufficient heat for the bed you would have to heat the pipes unduly, and you would consequently invite an attack of red spider. A chamber 2 feet wide and 1 foot deep would suffice for distributing heat from the pipe, the space so enclosed to be covered with slabs or slates, with the joints left open and protected with rubble.

Names of Plants (*F. G.*).—*Cerbera Thevetia*. See reply above. (*W. D.*).—A poor variety of *Lycaste Harrisonae*. (*C. S.*).—The yellow-flowered specimen is *Justicia calycotricha*, the other is *Fuchsia procumbens*. (*M. B.*).—1, *Adiantum formosum*; 2, *Erica codonodes*; 3, *Ribes speciosa*; 4 will be referred to next week.

Address (*J. E.*).—The address you require is Mr. Pettigrew's, Bowdon, Cheshire. Those who have straw Stewarton hives to sell should advertise them.

COVENT GARDEN MARKET.

THE prices of fruit and vegetables remain the same as recorded in the table on page 330, last week.



POULTRY AND PIGEON CHRONICLE.

PLOUGHING-IN OR FEEDING GREEN CROPS.

(Continued from page 332.)

IN continuation of our subject we must now refer to another kind of vegetation usually grown for a double purpose, first as a fallow crop, and secondly the feeding of live stock; we mean the various root crops, such as Mangolds, Swedish and other sorts of Turnips, and Carrots. These crops are usually cultivated for the purpose of feeding sheep on the land, cattle in their boxes, dairy cows in their stalls, and swine in their pens. It is with a common consent amongst farmers considered best to do thus, and appropriate the bulbous root crops for feeding purposes only, and the custom is defended by them and said to be profitable, as corn-growing does not pay; and yet they are obliged to admit that roots are grown and fed off by stock in order to manure the land for corn-growing purposes. In fact, although the custom of growing roots and feeding them by sheep stock on the land is in full operation in almost every district in the

kingdom in which capital enough to carry out the system can be found for the purpose, still unfortunately it is notorious that within the last eight years large numbers of men who were considered good stock farmers have failed and succumbed to the times whilst carrying out this favourite style of farming. This is a serious state of things when practically considered in the interest of landowners, tenant farmers, or the agents and home farmers throughout the country, and especially upon those farms which are occupied under compulsory leases, by which the occupiers are bound to carry out certain systems of cropping and stocking not beneficial or suitable to the times in which we live.

Having said thus much we feel bound to endeavour and solve the problem, however difficult it may appear to those who have not studied the agricultural points involved in an altered style of agriculture. It is fortunate that the home farmer is only in a few instances allowed to adjust his system to meet all contingencies either of stocking or cropping, and thus be enabled to utilise his green crops in such a manner as may prove most profitable. This brings us to the point which we desire to explain. The question was formerly pretty generally recognised, as before stated, amongst intelligent farmers, that ploughing-in 18 tons of Turnips per acre after being properly broken down, gave 12 bushels of Barley (and other cereals in proportion) more than if the said Turnips had been first passed through the animal and the elements required to form mutton and wool extracted.

The first experiment which we have to notice is again from Mr. Love's essay before quoted from, in which he says—"A 12-acre field of light loam had been manured with 16 tons of farmyard dung per acre ploughed into a Wheat stubble, and thrice cultivated in the spring, harrowed and rolled, and then ridged up, and 2 quarters of bone-dust (well fermented after wetting with urine) drilled in per acre under the seed. The produce was a little over 18 tons of Turnips per acre. The crop on 3 acres was all carted off the land, that on 7½ acres eaten by sheep, and that on 1½ acre crushed with Crosskill's clod-crusher and ploughed in 6 inches deep. The whole was sown with Oats, and produced as follows: Where Turnips were drawn 7 quarters; where eaten 9 quarters, where ploughed in over 11 quarters per acre."

The next example is that of Mr. G. Murray, of Elvaston, Derby, in his "Essay on Ploughing-in Green Crops," as given in the Journal of the Royal Agricultural Society in 1868. He says—"My experience of ploughing-in green crops includes much variety of soil and difference of climate and of rainfall. In the north-western counties of Scotland, where dairy farming is extensively practised, the whole Turnip crop is got up by the middle of November, and all drawn off and consumed by cattle in the yards. Here the farmers are very particular to have the Turnip-tops regularly spread over the land, and at once ploughing-in, the depth of furrow never being less than 5 inches. In this state it remains till the month of January or later, when the land is generally sown with Wheat, and heavy crops are grown. It is, however, generally supposed that green manuring is most successful in a dry climate. I find the average weight of tops left by a good crop of Mangold or Swedes to be about 4 tons when taken up during the early part of November." This exhibits the value of the greens only if taken when they are at the fullest growth and before the roots have arrived at their greatest weight per acre. It also shows the value for ploughing-in a crop of late-sown or stubble Turnips when in full growth of greens, and before they have had time to form anything more than small bulbs. We have also to notice that recently, as stated in the *Hampshire Advertiser*, a paper had been read at a meeting of the Botley and South Hants Farmers' Club by Mr. Joseph

Blundell on "The Advantage of Manuring Land by Ploughing-in Green and Vegetable Crops."

The consideration of the subject was, however, confined in its application to the vale farms of the South Hants district. We cannot, however, limit the consideration of our subject thus, but shall endeavour and intend to show its value and importance when connected with the cultivation of farms in general upon a great diversity of soils; but our remarks will have especial reference to the chalk hills and limestone districts of various counties, and upon which soils it is often asserted that it cannot be profitably farmed unless by the maintenance of large flocks, and our observations will probably by some be considered quite opposed to the time-honoured and prevailing custom of consuming all green and root crops by sheep on the land. Regarding the ploughing-in of root crops, we find it stated at this club meeting that in various seasons, but particularly in 1872 and 1878, instances were related of the great success which had attended the ploughing-in of root crops for the Barley crop, especially when the roots, greens, and all had been passed through Gardner's Turnip-cutter, and thus completely buried, often using only a portion of the crop, say about 13 tons per acre, which has been found ample and sufficient for green manuring, the residue, if any, being removed for the feeding of dairy cows.

A valuable statement was made at this meeting by a member, who is said to be one of the most experienced and practical farmers of the South Hants district (Mr. James Withers of Snake-moor), who said—"About twelve years ago he had a very heavy root crop and not stock enough to consume it. He had a field of 15 acres—10 with Swedes and 5 with Turnips. He estimated the former at 24 tons per acre, and the latter at 16 tons per acre. The Swedes were fed off with sheep, which had half a ton of oil-cake, while the Turnips were chopped up and ploughed in. The whole field was sown with Barley, and he had considerably more per acre where the roots were ploughed in than he had where they were fed off and the sheep had eaten oil-cake, while a second crop of Clover was decidedly the best he had. He had 10 acres of roots last year, 5 of which were fed off, and the fold and 5 were chopped up and ploughed in. The whole 10 acres were sowed with white Oats, and the 5 acres ploughed in produced 7 quarters per acre, and the other part 5 quarters per acre. While in the two parts there was a difference of from 12 to 16 inches in the length of the straw, in the part where the roots were ploughed in; it was on a black light and loamy soil. A member asked him whether he thought it was wise to grow Turnips and then plough them in, and he thought he could answer the question. Some four years ago he purchased sheep when they were very dear. They cost him something like 10s. each for cake, and when he sold them out they fetched 12s. more each than the buying-in price. Thus, he had only 2s. per head to pay his rent, taxes, tithes, and the hay, &c., they consumed. He also said his profit on sheep last year was nothing." This closes our quotations from the experience of practical men on the points named; we have, however, yet to state a very interesting and important part of the subject.

(To be continued.)

WORK ON THE HOME FARM.

Horse Labour.—During April and greater part of March the horses have been continuously employed, and successfully too, for the work done has generally been well performed, and the land so dry that in a few exceptional cases of strong clay soil it is next to impossible to reduce it into a fine surface tilth. There is, however, plenty of land that will work freely where it is of a light and friable nature, so that the rough land must wait for rain, and if sufficient rain does not come in time for any proposed crop we must wait with patience and seed the land for another kind, such as early roots like Mangolds, Carrots, and Swedes. Since writing the above a fine rain has fallen, and will save much labour. Some of the Wheat lands we find on inspection are unusually thin of plant, and will therefore require some horse labour in harrowing and hoeing, and upon any Wheat which was drilled early at 12 inches between the lines harrowing may be done across the drills if free working land; otherwise on the strong clay soils it may be horse-hoed, so as to break the hard shell of the surface, which is found on most of such land. If, however, the seed was sown broadcast the land should be harrowed first, and then hand-hoed if it is very thin of plant, with 4-inch hand-hoes, because nearly all strong lands have weeds which are peculiar or indigenous to them, and should be cut up; otherwise where the plant of Wheat is deficient these weeds will surely overwhelm the crop. The hoeing must be done by careful men who are accustomed to this work, which requires a quick eye and steady hand, in order that every plant may be saved during the operation of hoeing. We used to find the women do this work best; it is now seldom that female labour can be obtained, especially for work requiring so much skill and nicety as hoeing broadcast Wheat. It is truly astonishing to see the progress thin Wheat will make in tillering and stalking out after being properly

hand-hoed or horse-hoed, and particularly if top-dressed also with nitrate of soda—2 cwt. per acre—or other concentrated manure; and this season it is more required than usual, for a very large portion of Wheat land was seeded without any dung being carted on to the land, as it would not bear the carts during the continuous rainy season from November to February inclusive.

Hand Labour.—Men will now be employed in sowing nitrate of soda upon the Wheat and Oats where the land has not been otherwise manured. The stores of Mangold should now be examined, and if any portion of the roots are decayed they should be picked out to prevent further injury, for when this has been done and the store heaps reformed and carefully thatched, the roots will keep good for use during the whole summer, and be found in good feeding quality until Mangolds of the new crop are available. Should the decayed roots removed from the store heap be of sufficient extent they may be laid out and ploughed in, after being broken down for manure. We did this last year as a dressing for white Oats, and the crop proved most abundant upon the portion of the field where they were ploughed in.

Live Stock.—There is still a great scarcity of sheep in the kingdom, and it will take years to make good the lost numbers; it will therefore be advisable for farmers who have a sufficiency of food to carry out the plan we have previously advised, to hold over the lambs which are usually sold at light weight, and instead of selling them to weigh only 10 or 12 lbs. per quarter, they may be kept with increased benefit until they weigh 18 or 20 lbs. per quarter. We note that Her Majesty the Queen has ordered that, on account of their scarcity, no lambs are to be used in her establishment. How far this idea may be approved and carried out by other householders is very doubtful. The prices for both beef and mutton have lately fallen, and will not probably reach the late prices again during the summer period; at any rate the farmers are running a considerable risk in calculating upon the return of extreme prices. Now is the time to consider which is likely to answer best—a milk-selling dairy, or a suckling dairy in which calves are purchased at a week or ten days old and kept for making veal. We hear some complaining of the milk-selling system as not answering their purpose, except close to towns, where it can be sold by retail near at hand. It is said that in those cases, even within three miles of a town or station, that the cost of delivery twice a day is a great tax upon profits at present prices. Now when we look at the top price for veal, calves, being now 6s. 4d. per stone, all things considered, must pay better than milk-selling. When good Devon or Hereford calves are suckled they will be sure to make the top quotations, and they can always be obtained at about a week or ten days old, at this time of year especially. The points in their favour are several. The cows will continue in milk longer when suckling calves than when the cows are hand-milked; there is less trouble or expense in suckling than in milking and delivery of milk. The detail, however, of management is important, but not difficult, for whilst young two calves may be put to one cow, and to get them used to meal-feeding in addition to suckling we give them balls (put into their mouths at first) composed of linseed meal and barley or bean meal. In a week or ten days they will readily take the food as pudding out of the hand, and soon after eat it out of a trough. Now there is nothing makes better veal than when calves are fed in this way, getting more milk and more pudding as they grow heavier, and when they will make from £5 to £5 10s. each they may be sold, nor is there any more profitable mode of consuming cake and meal.

SOIL-EXHAUSTION—SPECIAL WANTS OF SPECIAL CROPS.

RIGHT or wrong we look upon the editorial note at page 270 as an invitation to complete the paper headed as above. The subject is a rather extensive one, and the longer one peers into the distance of it the greater it seems, till the horizon limiting its area disappears entirely. But it is not our present intention to go very deeply into the subject, as those unacquainted with the subject might not care to follow, while those who are hardly need instruction. For those, then, who know little of agricultural chemistry we write, and for their sakes we will not travel too far.

Unwittingly, all that need be said of the wants of Potatoes has been already said, so that we may just as well begin where we left off. As one way of restoring land impoverished by strong-growing Potatoes, and that, perhaps, the most economical, it only remains to speak of the wants of such crops as generally follow Potatoes.

Hitherto Potatoes or Turnips have formed the beginning of a rotation, for to such crops farmers have been in the habit of giving all the manure applied to the land till again cropped with Potatoes or Turnips. With the old weakly growing Potatoes this was bad enough, for by the time the green crop had taken much of the manure the rain washed more away, and, a crop of corn and hay taken, the soil was generally exhausted—on light sandy soil utterly so. The pasture, which in some rotations, especially in the north, followed such, was certainly of the scantiest and most innutritious character. The soil being exhausted it could not produce either

meat or milk, except in quantities insufficient to pay the rent. This system must be altered if agriculture is to pay.

The past tense has been used, but it is to be feared that the vast majority still hold by the old ways in spite of efforts that have been made to uproot practices proved to be erroneous. Instead of giving all the manure to the Potatoes and Turnips, it will be found that it is far better to give only part, as shown when the special wants of special Potatoes, such as Champion, were spoken of. The other part can be profitably applied as we shall hereafter show.

Corn of some sort follows Potatoes or other green crop. In favourable districts Wheat is sown, in others Barley; in unfavourable localities, as in the wet west or cold north, Oats are sown. On very poor sandy soils sometimes Rye is grown. But no matter which of these followed; all belong to the natural order Gramineæ, and in practice it is found that the wants of these are similar. Among applied manures there must be nitrogen, phosphoric acid and potash. "Inquirer," if happily he were living, would add "and magnesia," and probably he would be right. Corn crops need more substances than these, but only on really very poor soil is it necessary to apply any other. Indeed, on land of average quality, manured even in the ordinary way, at least when a rotation is followed, more especially when the peculiar wants of each crop are supplied, not more than one or two of these need be applied to the corn crop.

The first want of corn is nitrogen. Except when Potatoes or Turnips have been very heavily manured with farmyard manure and a poor crop followed, or a big crop and the tops returned as green manure, nitrogen is almost certain to be present in insufficient quantity; hence it is always a paying practice to dress corn land in spring with from 300 to 450 lbs. of sulphate of ammonia per acre, according as the land is rich or poor. If nitrate of soda be used from 400 to 600 lbs. will supply nitrogen equivalent, or nearly so, to the above quantities of ammonia. On light soils, in wet districts, the ammonia should be preferred, for under such conditions the nitrates are more liable to loss. The best way to apply these is to sow them broadcast, one-half when the seed is sown and one-half after it has grown an inch or two—say in May, early or late according to locality. The quantities given should not be much exceeded even on very poor land, otherwise too great a growth might follow only to be laid. So when the land is in good condition, even though a slight dressing may be of great advantage, the minimum amount recommended may be too much. Circumstances must decide how much less is the proper amount.

By such applications as above the yield of Wheat has been raised from 14 or 16 bushels an acre up to 33, 36, and in one instance that came under our notice 43 bushels. This was in Fifeshire in the year 1868. On an undressed portion of the same field it was barely 20. But such results need not be looked for in every instance, or even in any considerable number. Still the fact remains that the judicious use of nitrogen increases grain crops greatly, and constitutes the special wants of Wheat, Barley, or Oats. Yet we have known heavy applications raise the yield of grain very little, even though producing a double crop of straw. Experiments lead us to conclude that when this happens phosphoric acid is short, as it almost always is, except when liberally applied as bone dust, superphosphate, or ground phosphates to the previous crop. As such applications prove almost specifics for Turnips and largely increase the yield of Potatoes, it is, perhaps, best to apply phosphates to these crops liberally, for they are not at all subject to loss as is nitrogen, and what the green crop leaves the grain crop will get. But when this has not been done on land when ears grow small and fill badly in spite of applications of nitrogenous manure, then be sure that the soil is poor in phosphoric acid—and it almost always is—and that dressings of superphosphate at the rate of from 3 to 4 cwt. per acre will be repaid with usury that no one ever dreamt of charging. Applied by itself—that is, without nitrogen, it increases the crop by a bushel or two, but when the two are combined the crop of corn as well as straw is frequently doubled and, on very poor soil, often trebled. Depend upon it, neither protection, lowering or abolishing of local rates or new land laws, will help the farmer half so much as will the judicious use of artificial manures as supplementing those produced at home. Similar applications benefit Oats and Barley quite as much as Wheat, and even more so.

Potash salts (in the form of kainit, or sulphate or chloride of potash) frequently benefit corn crops, but this chiefly on sandy poor soil deficient in everything. On really good land these do not seem to require to be added to grain crops, and when applied to Potatoes or Clover, or when the urine produced at home is saved, it is only occasionally that potash salts need be specially bought for application to corn crops. Good loamy or clay land, though almost always deficient in nitrogen, very often deficient even in phosphoric acid, is seldom without potash enough for full corn crops, and in instances not a few for all crops whatever. Nay, some soils that rank as poor—such as those on many traps, or when trap is largely mixed with the

soil as on the boulder clay in some instances, or when in the days of British glaciers these have thawed under summer suns—soils poor in everything else are not unfrequently rich enough in potash even for Peas, Clover, Beans, or Potatoes; but it is very easy finding out. Not by sending samples to a chemist, but by analysing it yourself. Do not be alarmed, nothing is easier. Try a portion of a field with each of the substances named, and all mixed, and should either produce no good effect it may be concluded that the soil contains enough of that, at least at present.—A. H.

(To be continued.)

OUR LETTER BOX.

Java Sparrows (Ella).—As a rule Java sparrows will eat nothing but canary seed, on which they thrive. They can with safety be put out of doors. It is very difficult to breed them in this country. The white variety is, however, more easy to breed.

Cabbage for Winter-feeding Dairy Cows (Subscriber, Co. Meath)—The best variety for this purpose, especially for butter-making, is the large Drumhead Savoy. The sooner the seed is sown the better. This sort, however, would not be suitable for planting so late as the month of July, for they grow more slowly than most other sorts, even when planted in good land, well cultivated, and highly manured. In ploughing up grass land in the month of July Cabbages of quick growth may be planted immediately the land is ploughed. Of the quick-growing yet productive sorts the two sorts we like best are Daniel's Defiance and the Oxheart. In ploughing grass land to be set with Cabbage plants a good dressing of dung should be laid out and spread, and then raked into every second or third furrow, and the plants set on the furrow immediately over the dung. It should be ploughed with the skim coulter, and deep enough to bury the turf or grass layer, and the presser to follow, and if the weather is dry the plants should be set as fast as the furrow is turned, the planters putting their foot down near the stem of the plant to keep the land firm and moist.

Alderney Cow (R. C.)—As soon as your cow has calved milk away all that you can after the calf has sucked, and give it to the cow to drink. Let her for the week after calving drink the water not hot but only a little warm. Give bran mashes and nice sweet meadow hay, but no root food for the first week, and afterwards for a while only sparingly. We have heard of and know persons who give cold water, and have not lost any cows, but not having tried that plan we cannot recommend it safely. The cow should be kept to the shed until the second week in May before lying out at night, but in case of fine weather may go out a few hours during the daytime about a week after calving. When weaning the calf at a few days old give it new milk sparingly for a week, then skim milk mixed with bay-tea and a little barleymeal mixed, and further have a bundle of hay hung up in its pen to learn it to eat. The management of Channel Island cattle you can obtain at this office, by applying for a back number of this Journal, dated May 19th, 1881.

Kohl-Rabi (J. W. R.)—The experience of Mr. W. Bennett of Cambridge, recorded in our columns three years ago, will answer your inquiry—namely, "Our practice is not to drill the seed before the 1st of May. We seldom use more than 2 lbs. of seed per acre drilled on ridges 27 inches apart, thinning the plants in the rows to about 16 inches apart. After ridging the land as if for Swedish Turnips we lay out in the furrows 10 tons of farmyard dung, and spread about 5 cwt. per acre of superphosphate, rapecake, &c. The ridges are then reversed, which buries the manure in the centre of the ridges. By this method of cultivation on land worth 30s. per acre to rent, we usually grow from 25 to 30 tons per acre of excellent bulbs, besides the greens, which are first-rate food; and where a dairy is kept they are of no small value to the milking cows, as they give no unpleasant flavour to the butter."

METEOROLOGICAL OBSERVATIONS.

CAMDEN SQUARE, LONDON.

Lat. 51° 32' 40" N.; Long. 0° 8' 0" W.; Altitude, 111 feet.

DATE.	9 A.M.					IN THE DAY.				Rain
	Barometer at 32 ^d and Sea Level	Hygrometer.		Direction of Wind.	Temp. of Soil at 1 foot.	Shade Temperature.		Radiation Temperature.		
		Dry.	Wet.			Max.	Min.	In sun.	On grass.	
1883.										
April.										
Sun. 15	Inches. 29.913	deg. 49.8	deg. 44.4	N.W.	deg. 45.0	deg. 60.5	deg. 38.6	deg. 103.7	deg. 35.7	In. —
Mon. 16	30.054	49.2	42.0	W.	46.0	58.5	29.8	105.3	34.8	—
Tues. 17	30.052	48.7	42.9	S.	47.7	57.0	36.5	102.3	34.8	—
Wed. 18	29.581	55.9	49.8	S.	46.8	67.2	42.8	101.3	35.9	0.596
Thurs. 19	29.591	46.4	45.6	N.	48.0	61.3	45.0	125	46.3	0.054
Friday 20	30.066	50.0	46.3	N.	46.8	58.9	43.1	99.5	41.7	0.023
Satur. 21	30.248	47.7	44.5	N.E.	47.2	52.4	42.3	100.1	40.3	—
	29.929	49.7	45.1		46.6	59.4	41.2	95.4	38.5	0.683

REMARKS.

15th.—Dull at first, fine afternoon and evening.
 16th.—Fine and bright; lunar halo 9 P.M.
 17th.—Dull morning, fine afterwards; moonlight night.
 18th.—Overcast and windy, slight showers.
 19th.—Heavy rain from 3 A.M.; dull and showery in forenoon, fair afterwards.
 20th.—Fair, but dull.
 21st.—Very bright in forenoon, overcast in afternoon.
 Temperature above that of the previous week, and rather above the average.—
 G. J. SYMONS.



3rd	TH	Linnaean Society at 8 P.M. Sale of Orchids at Mr. Stevens's
4th	F	[Rooms, King Street, Covent Garden.
5th	S	
6th	SUN	SUNDAY AFTER ASCENSION.
7th	M	[11 A.M.
8th	TU	Royal Horticultural Society, Fruit and Floral Committees at
9th	W	Bath Spring Show.

CALANTHES.

NO time in the whole year is more seasonable than the present to record notes about the cultivation of these Orchids, and no plants are worthy of greater care and attention. They will flower over a period of six months during the worst season of the year, and on this account are doubly valuable. But to insure this a number of plants are required, and these started at different intervals so as to flower in succession. *C. Turneri* is decidedly the best for late flowering, and *C. vestita lutea* is also valuable for the same purpose. We removed our last spike of this variety on April 10th, and it had then one or two fresh flowers upon it.

It has been advanced again and again that these plants being destitute of foliage during their season of flowering is a serious defect. Their peculiarity of flowering in this condition I regard an advantage rather than otherwise, because the plants can be tastefully arranged amongst Ferns, Zonal Pelargoniums, or any other suitable plants without taking up really any room in the house, and their pots and pseudo-bulbs can be hidden from view. If they retained their foliage after flowering they would require as much house room and care as *Phaius grandifolius*, but in their deciduous state their pots can be stored out of sight, or the soil shaken from the pseudo-bulbs and then placed thickly together in pans and stood amongst other plants until the time arrives for starting them into growth.

When *Calanthes* are required to flower early in October they should be well started in growth by this time and rooting freely. If not yet started they must be pressed forward with all possible speed. The present is a good time to pot and start the general stock to flower during November, December, and January, while the varieties mentioned above may be retarded for some weeks longer. It must be borne in mind that *Calanthes* are like many other plants, and when required in flower either early or late they must be trained to start earlier or later as the case may be. To have flowers over the longest possible period is not the work of one season, but the result of several seasons' care.

Calanthes are of easy cultivation, and none need fail if only a moderate amount of care and attention is devoted to them; but I have seen splendid batches of these plants ruined for two or three seasons by a few months of careless and ignorant treatment. By careless watering in their early stages, pseudo-bulbs only half the size of those made during the previous year are often produced. The idea is prevalent that these

plants are liable to degenerate; but this is a mistake, and the failure is attributable in the majority of cases to some defect in their cultivation.

In potting the pseudo-bulbs they can either be placed singly or a number together in each pot, according to the size of the specimens required. I prefer growing them singly, because I have always found when a number of pseudo-bulbs are grown in the same pot they do not develop and solidify so well, which is essential to the production of fine large spikes of bloom. When in pots singly they can be arranged more effectively amongst other plants than when a number are grown in large pots. If specimens are required it is not difficult to make them up after the spikes are well advanced without any injury to the plants or flowers. If the plants have remained in the pots in which they flowered up to the present time all the old soil can be shaken from them and their roots cut close back, leaving only sufficient to keep them steady in their new compost. In the case of *C. Veitchii* a small stake is employed to secure the bulbs to until they form roots from the new growths. In the cultivation of these plants it is a mistake to employ very large pots, those 5 inches in diameter being large enough for one or two pseudo-bulbs of the varieties of *C. vestita*. *C. Veitchii* may be placed in the same size or smaller, and afterwards in others a size larger if strong.

It is a common practice to place the plants at the commencement in the pots in which they are to flower, and by careful and judicious watering success may be attained. On the other hand, an injudicious use of the water pot is likely to render the soil sour before the roots have taken possession of it; and under these circumstances, instead of the pseudo-bulbs increasing in numbers and strength, they are sure to decrease. I recommend, in the case of *C. Veitchii* especially, shifting the plants gradually, as the finest I have ever seen were the result of this system.

The pots should be liberally drained, and then filled with the compost employed, placing a little silver sand just below the new growths starting at the base of the old pseudo-bulbs. The growths should be allowed to extend about 1 inch before being potted, and then allowed to rest upon the compost, and the pseudo-bulbs secured by the means indicated. The compost most suitable is equal parts of fibry peat and loam, a little cow manure previously prepared and passed through a fine sieve, to which is added a liberal quantity of coarse sand, broken charcoal, and a few small bones.

Watering must be very carefully done for some time after the pseudo-bulbs are first potted—in fact, until the roots have commenced growing freely. At first, if the house is kept moist and water syringed two or three times daily amongst the pots it will be sufficient. As soon as the roots are entering the compost just enough water should be given to prevent the soil becoming dust-dry, and as the roots extend more liberal applications must be given. When in active growth *Calanthes* require a copious supply of water and weak stimulants frequently when their pots are well filled with roots. They also require careful watering in their last stages of development until the foliage is entirely ripened, when water can be withheld. At first they should not be syringed until they have made plenty of roots, or their foliage is liable to become spotted, which will also result from overwatering; but when the season

has fairly advanced they will be much benefited by being dewed at least twice daily.

During their season of growth they require a warm moist atmosphere and shade from the strong rays of the sun. The material employed for this purpose must not exclude light. Ventilate daily during the growing season when the weather is favourable. The house should be closed early in the afternoon with a moist atmosphere.—W. BARDNEY.

THE REVIVAL OF ARBORICULTURE.

FROM time to time we have referred incidentally to the project of Dr. Lyons on re-forestation in Ireland, and have recorded several very generous offers of trees that have been made by persons and nursery firms in this country. We are glad to learn that sympathy with the important matter in question is not confined to Great Britain, and we have been desired by an esteemed contributor in France, Mr. E. P. C. Brace, to convey to Dr. Lyons an offer of fifty thousand Scotch Pines, to aid him in carrying out the work in which he is so laudably engaged. We have had much pleasure in complying with this request, and we append a letter from Dr. Lyons accepting Mr. Brace's friendly and much-valued gift.

“House of Commons, April 27th, 1883.

“DEAR SIR,—I am extremely obliged for your letter conveying that of Mr. Brace of Loir-et-Cher with offer of fifty thousand trees towards my project of re-forestation in Ireland, which has had such remarkable support from Scottish and English houses of great eminence in arboriculture. I am glad to find that my humble labours, which have found such noble response in these countries, finds appreciation in France, where forestry has attained such important development, and is a source of profit of some millions sterling per annum to the national exchequer. The circumstances of Ireland admit of her taking a large and profitable share in the future timber supply of the empire. Indeed, I am rejoiced to find that attention is being called to the subject in England too, and by so eminent and practical an authority as Sir John Lubbock. It may interest your readers to see the terms of Sir John Lubbock's motion on forestry in England, and then of my own resolutions in regard to Ireland.

“I enclose extracts from the Order Books of the House. I may add that on this day I drew a place in the ballot for 25th of May to place my motion before the House. In your correspondence with Mr. Brace will you kindly thank him in my name for his most munificent gift? I will have the honour of communicating with him direct myself as to the details of carriage to which he refers. I would be obliged if you could make room for this letter in your next, with the resolutions of Sir J. Lubbock and my own.

“Very faithfully yours, R. D. LYONS.”

The following are the terms of Dr. Lyons' motion :—

41. Dr. Lyons,—Resources of Ireland.—That, in the opinion of this House it is desirable, in view of the state of Ireland, that measures be taken to utilise her abundant, but dormant, natural resources, by—

1st. Re-forestation suitable tracts of her waste lands, and planting the great watersheds, in order to supply shelter and timber, and to control mountain floods, which are progressively denuding the soil, silting up primary and arterial drainage, with consequent deterioration of tillage and pasture lands, shoaling of navigable rivers, and banishment of fish further and further seaward, and by general reclamation of waste lands;

2nd. By fully developing the seacoast and inland fisheries, with all requisite improvements in engines of capture, and piers and harbours of refuge, in order to the better food supply of the people, and the extension of the commerce in fish;

3rd. By the extension of lines of internal communication by water and land, by steam or horse power, and the construction of new routes for traffic, where necessary, by the development of the fuel resources of Ireland, and the extension of industries in mines, minerals, and agriculture:

That, in the opinion of this House, means may be safely devised for the utilisation of part of the capital of thirty-two millions sterling, now lying comparatively idle in Ireland, for the development of her resources, by the issue of stock notes under the guarantee of the Irish or Imperial Revenues, and under the management of a Department of Productive Works, having the full confidence of the country.

There can be no question as to the extreme desirability of turning to account suitable waste lands in Ireland in the manner and for the purposes indicated; nor is there the remotest doubt that the work carried out with skill and judgment—choosing trees that are naturally adapted for the different

soils and situations, this being a matter of vital importance—that eventually great and permanent benefit would result to the country. Even in America, that great land of timber, the State authorities find it incumbent to give all the encouragement possible to the planting of trees, the disafforestation in many districts having had other unfavourable results, such as those embodied in the above motion, than a local scarcity of timber. On the European continent, too, waste lands are utilised in a far more systematic manner than in this country by planting trees. In Belgium we recently observed that the sides of every road and watercourse were fringed with trees of the Canadian Poplar, which thus occupy land that could not otherwise be turned to profitable account, and these trees, besides affording shelter and draining the land, are estimated to increase in value at the rate of 1s. each per annum, experience having proved that in thirty years each tree is worth 30s. In swampy ground trees at 8 feet to 10 feet apart grow luxuriantly, and in the period named an acre of them would realise at the least £800, and the ground then by the accumulation of vegetable matter would certainly be in better condition than before the trees were planted. There are without doubt thousands of acres of land in Ireland now practically valueless that might be similarly improved, while adjacent lands not thus occupied would be rendered more valuable for other cultivable purposes. We trust Dr. Lyons' motion will be favourably entertained, and that he will receive the support that is requisite to enable him to succeed in the important work in which he is so assiduously engaged.

The motion of Sir John Lubbock is of wider scope and more general purport, as follows :—

Sir John Lubbock,—To call attention to the state of forestry in this country; and to move for a Committee to consider whether, by the establishment of a Forest School or otherwise, our woodlands could be rendered more remunerative.

This will be brought before the House to-morrow (Friday, the 4th inst.) if the regular order of business is not further interfered with, and whether the Committee be granted or not, and we are decidedly of opinion it should be, the discussion will direct attention to a matter that has been allowed to slumber too long. It is little less than deplorable to witness the miles of woods that are practically valueless from a commercial point of view, whereas under skilled supervision they might serve all their present purposes, and in addition yield a substantial revenue to the owners, also, and necessarily, be of advantage to the trading and agricultural community. We have the incontrovertible evidence of facts in support of this statement. In many country districts timber has become so scarce, and consequently dear, owing to non-planting and the haphazard way in which woods are managed, that the carpenters' bills have become a serious item to farmers, and tradesmen have informed us of the great difficulty they experience in procuring suitable materials. There is no excuse for this, because woods judiciously managed are fairly remunerative. We are intimately acquainted with land that for years did not realise a rental of a shilling per acre, that is now covered with thriving plantations that are of substantial value to the owner. On an estate in a rich agricultural district some portions of woodland that were planted with Larch thirty years ago have, we have been informed by the Steward of the estate, yielded a return fully equal to the best agricultural land in the locality, and we have ourselves planted Larch on waste land that in twelve years produced poles of the value of a shilling each. When we consider the number of trees that can be grown on an acre, and the trivial expense requisite in tending them, we are impressed with the impolicy of allowing waste land to remain barren when so much of it is capable, by a small outlay, of being made satisfactorily productive.

The neglect of systematic arboriculture is a grave mistake. Sir John Lubbock is not directing attention to the subject a moment too soon, and it will be to the public advantage if means are devised to render the woodlands of this country remunerative. Whether “Forest Schools” are requisite for accomplishing this desideratum is a question open to discussion; but the circumstance must not be overlooked that our best nurseries where forest trees are raised on an extensive scale, and many well-managed estates of the nobility and

gentry, are "schools" where forestry is practically taught, and in which any intelligent student may make himself competent, as many have hitherto done, in the work in question. Yet unquestionably technical knowledge is very desirable, and it would be well if more attention were given to the subject of imparting instruction in elementary schools on this and other eognate matters relating to the cultivation of the soil.

CABBAGE-GROWING AND CABBAGE-CUTTING.

"WELL! that's zummat, I have been cutting Cabbages these forty years, and now don't know how to cut 'em to please our master!" Something like the above was once overheard after a lesson had been given in the art of gathering vegetables economically. It was but the natural, harmless, and excusable vent for wounded pride and a little pent-up rebellion.

I certainly learnt a lesson from my labourers in growing Cabbages when I first came into this neighbourhood, but when it came to cutting them I could see they had something to learn. The lesson in growing was merely to sow earlier than I had been accustomed to do. Early sowing is becoming more general now, but a dozen years ago I believe very few people outside of this county thought of sowing before August, and that is a fortnight too late. St. Swithin's Day is the favourite time here, and in all but exceptional seasons I think it is about the best time, but I generally sow a pinch of seed a fortnight earlier, and a little more a fortnight later.

Perhaps it was the want of a good reliable sort, one which would not run to seed, which so long prevented early sowing, and the first marked step towards obtaining this was doubtless made by our lamented old friend George Wheeler, who some forty years ago sent out "Wheeler's Imperial," and kept it true as long as his health would allow him to look after it. What was sold as "Wheeler's Imperial" by other nurserymen, as far as my experience went, was a different Cabbage altogether, and now I do not know where to obtain a true stock of it. Happily, however, it is not wanted, as "Ellam's Early Dwarf" is an improvement on it, and so far the seed appears to have been very carefully saved. My friend and neighbour Mr. Iggulden grew a variety the year before last, which he considered more desirable than Ellam's, because while the latter was riddled by caterpillars his favourite variety escaped, but I confess I should be rather doubtful of a Cabbage which was not good enough for caterpillars.

But to the lesson in cutting. It is the nature of the type of Cabbage to which Ellam's and Wheeler's belong to yield a good second crop after the first is cut. From two to five good Cabbages come on the one stalk, and these, if well managed, come into use quicker than spring-sown Cabbages do; in fact, if a couple of thousand plants are grown for such an establishment as I have to supply, by the time the crop has all been cut over once some of the second crop is ready for the knife. I have seen many a cottager nurse up his Cabbages as tenderly as if they were so many babies, have them ready for use at Easter, or in a mild winter sometimes early in February, and then in cutting he would allow his knife to slip through two or three of the leafstalks, and would take two or three more with the head than was good for cooking; and not only this, but I have witnessed the remaining leaves cut off the stalk purposely at the same time, the operator being under the impression that he was forwarding the production of the future crop. Well, I have tried both ways, and the difference between starting with a naked stem and one with three or four healthy leaves makes a fortnight's difference in the time of the second crop, as well as a difference in quantity and quality.

The right way is to cut squarely across the stem between two sets of leaves, taking just as much as is fit to cook, and treating every leaf left on as the mother of a future Cabbage. When the sprouts have grown considerably, and are able to take up as much as the roots can supply, then the old leaves may be pulled off to advantage, so as to admit light and air. It is admitted that in treating most other plants it is not good practice to entirely defoliate at once while growth is proceeding vigorously, and of course the same rule holds good with even cutting a Cabbage.

The same waste takes place with regard to winter greens.

The careless gatherer spoils a leaf or two of each sprout in cutting, and the cook always starts with the conclusion that there is something to throw away, so there is waste all the way from the stump to the pot.—W.M. TAYLOR.

FERNS IN BOTTLES.

A MOST remarkable example of Fern growth was recently brought under our notice, and the circumstances are so unusual that they are well worth attention. In the garden of Mr. Raynsford at Kingston-on-Thames for the past twenty years partly damaged soda-water bottles have been employed to edge the paths. The point of the necks had been broken, and this portion was plunged into the soil to the depth of about 6 inches, thus leaving 3 or 4 inches of the base of the bottles above the surface. Some of these bottles have been in this position for the whole of the

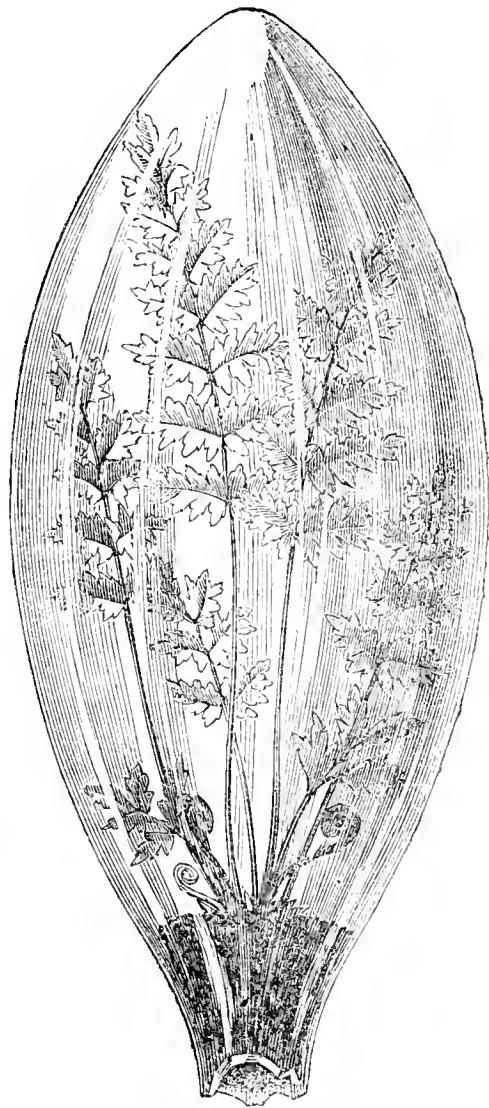

Fig. 84.—Fern in Soda-water Bottle (two-thirds of natural size).

time mentioned above, and others have been placed in at intervals to within the past year.

There is nothing extraordinary in all this. In hundreds of other gardens bottles have been similarly employed, but in this case the results now to be noticed are very unusual. In the majority of the bottles young Ferns appeared soon after they were placed in the ground, and these have continued growing until in some cases they have formed a dense congested mass of vegetation completely filling the bottles. The fronds remain green during the greater portion of the year and then die, giving place to young ones in the succeeding spring; and as previously stated, some have continued thus growing for many years past practically without any exposure to air, as the amount that could pass through the soil up the neck of the bottle would be extremely small. Several different varieties of Ferns are observable, chiefly forms of *Athyrium Filix-femina*, with the Oak Fern and a few others; and it is strange that the only Fern in the garden is *Scelopendrium vulgare*, of which there are no examples in the bottles. The soil, too, has not been renewed since the garden was first formed; therefore the only way in which the spores can have been conveyed to the garden is by the wind.

The bottle represented in the woodcut (fig. 84) is one of those

placed in the soil within the last year or two, and was selected because the young Fern can be more clearly shown. It should be added that of the four or five hundred bottles employed nearly two-thirds contain Ferns, the others being chiefly filled with Grasses and various weeds. In all cases the fresh healthy appearance of the plants indicates that they can well dispense with ventilation.

If a few Ferns could be induced to grow in bottles like the above they would form rather interesting little ferneries, especially for windows, as they could be inverted in pots or boxes, and would at least possess the advantage of requiring little attention or trouble.

LA GROSSE SUCRÉE STRAWBERRY.

When my note was penned with reference to the above I had in view Strawberries for early forcing, meaning thereby from early in the new year to the end of March, as after that time any variety of Strawberry will carry satisfactory crops without hard forcing. Your correspondent, Mr. S. Taylor (page 323) takes exception to my remarks with reference to Vicomtesse H. de Thury, and comes to the conclusion that I must have taken my runners from barren plants. Such was not possible, as we are most particular on that point. I obtained my original stock from one of our best private growers. I sent him some plants of La Grosse Suerée for trial, and in a communication received from him the first week of February of this year he says, "My Vicomtesse are colouring; La Grosse Suerée just set," which is the reverse of my experience of the two varieties here. Soil no doubt has much to do with it. President does well here as a later variety; also Admiral Dundas, large, and of good flavour. James Veitch has only size to recommend it. The same may be said of Auguste Nicaise, which we tried for two years. We have a variety on trial this year that we think highly of at present—namely, Dr. Morère. It is a strong grower, and carries a good crop of large fruit, which are now ripening. The soil here is strong magnesian limestone. I may perhaps say that I obtained my stock of Vicomtesse some three years since from Mr. Gilbert of Burghley. Early in the new year he told me he gathered a good dish on Christmas Day. He is forcing a quantity of La Grosse now. He says it is a "topper." It does much better than anything here.—G. SUMMERS, *Sandbeck Park*.

SELECT DAHLIAS.

No one who visited the National Dahlia Show at the Crystal Palace last year could fail being impressed with the striking beauty of the Dahlia as an exhibition flower, and those who subsequently had the opportunity of inspecting Mr. Turner's great collection at Slough would with equal readiness admit that Dahlias are excelled by no plants for rendering gardens gay in the summer and autumn months. Calling on Mr. Turner last October I found acres of ground occupied with Dahlias, and countless thousands of blooms. For fully three months the plants had been flowering, and vast quantities of flowers were cut and sent to London and other large towns daily for church and civic decorations. The trade for blooms alone appears to be immense, and here the doubles have the advantage over the singles, as they travel better and last longer. The small-flowered bouquet varieties are in great demand every year for the purposes indicated, and thousands of large bunches of their symmetrical blooms are required weekly in London alone during the Dahlia season.

Granting the special adaptability of single Dahlias for certain purposes of room-decoration, and their great beauty as border plants, yet the grand contour and marvellous symmetry of the best varieties of the double type must always command admiration. In respect of many flowers florists have reason to be proud of their work, but in none is their patience and skill better displayed than in the variedly coloured, highly finished, and almost faultless flowers under notice.

In inspecting the Slough collection some pains were taken to select a few of the leading varieties in their respective colours. Had these names been published at the time the list would have been of little service; but now, on the eve of the planting season, it may be useful to some readers who will shortly be procuring plants for their gardens. In Show Dahlias from three to six varieties were selected as the best in their colours as follows:—

Yellows—Acme of Perfection, Adelaide, Canary, John Neville, Julia Davis, and Prince Arthur.

Whites—Henry Turner, Georgina (new), Annie Neville, Julia Wyatt, and Mrs. Henshaw.

Crimsons—Alexander Cramond, James Service, John Wyatt, Mr. Spofforth, John Standish, and Joseph Green.

Scarlets—Major Cornwallis West (new), Drake Lewis, Charles Leicester, James Stephen (new), Miss Batchelor (new), and Walter H. Williams.

Purples—Ovid, Burgundy, George Smith, James Vick, Prince Bismarck, and James Cocker.

Maroons—George Rawlings (new), Prince of Denmark, Rev. J. Godday, Thomas Goodwin, and William Rawlings.

Orange and Buffs—Aurora, Chairman, Joseph Ashby, Queen of Spain, Sunbeam, and Vice-President.

Lilacs—Lady Wimborne, Mrs. Boston, and Rosy Morn.

Edged Flowers—Henry Walton, Hon. Mrs. Percy Wyndham, H. W. Ward, Mrs. Harris, Lady Gladys Herbert, and Royal Queen.

The names of these excellent varieties are given simply, as the descriptions of the flowers both as to character and tints are accurately rendered in catalogues.

Of Fancy Dahlias the following are twelve of the best *striped* varieties:—Annie Pritchard, Edward Peck, Frederick Smith, Gaiety, George Barnes, Grand Sultan, Henry Glasscock (sometimes produces crimson self flowers), James O'Brien, Magician, Professor Fawcett, Rev. J. B. M. Camm, and Robert Burns. Eight superior *tipped* varieties are Fanny Sturt, Jessie McIntosh, Lady Antrobus, Lady Paxton, Laura Haslam, Mrs. Saunders, Peacock, and Prospero. All these are fine for exhibition, and the tipped varieties especially are most effective in gardens.

Bouquet Dahlias constitute one of the most beautiful sections of the genus, and the varieties are not half sufficient grown in garden and shrubbery borders. The plants are so exceedingly floriferous, and the blooms so chaste, that they cannot be overlooked. The white varieties, such as Lady Blanche and White Aster, ought to be grown by the dozen for yielding flowers for cutting that are sure to be appreciated, and the brighter colours are most glowing. In addition to those named the following were noted as amongst the most attractive:—Adonis, rosy carmine; Comtesse Von Sternberg, yellow and white; Dora, primrose and white; Dr. Schwebes, bright scarlet; Fair Helen, white and lilac; German Favourite, crimson-lake, edged; Little Arthur, orange-scarlet; Prince of Liliputians, maroon; E. D. Jungker, amber; and Professor Bergeat, rosy crimson.

The varieties named would form an admirable if not a very extensive collection.—FANCIER.

THE GARDEN WATER SUPPLY.

AMONG the many practical and useful articles that have appeared weekly in these columns, few will command greater interest or prove more serviceable to gardeners who are, or were, seeking information on this subject than the able communication supplied under the above heading by Mr. Luckhurst (page 294). The information supplied therein proved very serviceable to us, as it appeared at an opportune moment, when we were discussing the subject of that important and indispensable adjunct to every properly equipped garden—"hose" and "stopcocks." A couple of years ago new indiarubber hose was purchased for the use of the garden here, and now it is worn out, although a good price was paid for it. The spell of dry weather experienced here until a few days ago warned us that we must obtain a new hose. Then the question arose, "Which is the most efficient, durable, and economical form of garden hose to obtain—indiarubber or leather?" Whilst thinking the matter over the Journal came to hand, and on opening it and reading the article above alluded to, we at once decided on obtaining a leather hose similar to that recommended by Mr. Luckhurst. Of course a leather hose is more costly than an indiarubber one, but we fully concur in your correspondent's statement that the additional outlay incurred will insure a more efficient and durable article, and afford greater satisfaction to employer and gardener.

Every garden is not so fortunate in its water supply as this one. Under my charge hydrants are fixed within reasonable distance of each other in flower, pleasure, and kitchen gardens. Equipped with a good hose a considerable saving in labour is thus effected—a great desideratum to those whose labour power is curtailed.—T. W. S., *Lee*.

LILY OF THE VALLEY FOR FORCING.—While thanking "R. T." for the few lines that are to guide me to success, I hope he will make the subject still plainer. It is evidently a very easy matter to "begin at the wrong end," since he himself has begun at the wrong end by not stating the first process to be observed—viz., when the crowns are placed in the pot or planted. For anything said to the contrary, imported clumps might have been used a season or two, and then termed "home-grown." I may state I am not quite igno-

rant in plant culture, or the culture of Lily of the Valley; but for the benefit of the younger members of our craft I think it necessary that plain instructions be given, so as to be easily understood. I may further state I am fully borne out in my views by more than one head gardener in this locality.—A. J. SANDERS.

USEFUL VEGETABLES.

ASPARAGUS KALE is a most useful vegetable for this time of year. Other Kales make way for the Potato crop, but this keeps up a supply till June, when it may be followed by Celery; and for my own taste I prefer Asparagus Kale to spring Cabbages. Unfortunately there are so many different vegetables sold as Asparagus Kale, that in buying seed one cannot tell what he is likely to get. All are good, but the true variety is very hardy and very productive. The last week in April or the first in May is the time to sow it. I have not yet tried friend Gilbert's Chou de Burghley, which is said to have the property of pleasing everybody, but I mean to give it a fair trial this season.

Coleworts are not so much grown as they ought to be in private establishments. There is generally plenty of ground vacant after second early Potatoes, too late for Broccoli and Kales, but in good time for Coleworts, yet such ground is often wasted.

Another flagrant piece of waste occurs when vegetables are gathered in frosty weather. In many gardens there is more Spinach, Parsley, Sorrel, &c., spoiled by being bruised while it is frozen than would suffice to supply a moderate-sized establishment.

I do not know what is the experience of others with regard to Parsley, but I am obliged to sow twice a year, and then cannot keep up a satisfactory supply. At one time it was very different to this. A plant would last several years, and be as good as it was at first. Have the recent improvements in appearance been gained at the expense of constitution?—W. T. L.

THE AURICULAS AT SOUTH KENSINGTON.

AGAIN has this most pleasant gathering of florists from the north and south taken place, and if no other end were gained by it than the friendly intercourse and exchange of views and opinions with one another we should all feel indebted to the organisers of the Exhibition for the treat they have thus given us. But much more has been done; and while I despair still of ever seeing the same *furor* on behalf of florists' flowers in the south that characterises the north, yet I am equally convinced that the encouragement thus given to this especial florists' flower must greatly increase its popularity, and therefore earnestly hope its success may be assured.

In the observations which as a florist of the old, and I believe the correct school, I may, in my notice of the Exhibition, say some things which may provoke controversy; yet, as my sole object is the welfare of the flower and the maintenance of its true character, I must be excused for not taking notice of any dissident remarks that may be made on my notes. Controversy on paper rarely does good: words are given a meaning that they were never intended to have: people read between the lines, instead of taking the lines themselves as they were intended.

I have seen it stated that the Exhibition was the best ever held by the Society. As far as the Auricula is concerned this is unquestionably a mistake; there were not so many exhibitors, nor were the flowers as good as they have been before. I ventured some little time ago to express the opinion that this would be the case. The cold blasts that we had in March I felt would so retard the flowers that many would not be able to put in an appearance, and that those flowers that were shown would exhibit the effects of that cold time. Now let us see how it was. In the class for twelve varieties there were this year four exhibitors instead of six last year; in the class for six there were but two exhibitors instead of seven; in the class for four there were eight exhibitors instead of ten; and in the class for pairs—the only one in which there was an increase—there were fourteen instead of nine, showing unmistakably the wisdom of making this class so as to admit small growers, although I cannot but think an unfair use was made by some exhibitors in the class. Then Messrs. Simonite, Booth, and Rudd were conspicuous by their absence amongst northern growers; and the Rev. E. Fellowes and Mr. S. Robins, among more southern growers, were unable to compete owing to their flowers not being in bloom.

And then as to the quality of the flowers, I can safely say without fear of contradiction that they were by no means equal to the quality of former years. There was hardly a first-class bloom of George Lightbody or Lancashire Hero in the Show; and although, as usual, the former flower carried off most of the prizes in the

single classes, yet in almost all instances there was the defect of that thin reddish line between the paste and body colour which this grand flower displays when it is not in first-rate condition. Then, again, if we take the two leading collections, Mr. Horner's and Mr. Douglas's, in the class for twelves, there were in one case seven and the other five blooms which were not of first-rate character. When we recollect that Mr. Horner has, I suppose, the finest collection of any amateur in England, and that Mr. Douglas has a house 50 feet long full of them (including Alpines), it must be evident that the season could not have been a favourable one when such growers were obliged to compete with blooms not in good form. It was in this class especially that the difference between the correct taste of the north and the not-equally-cultivated taste of the south was apparent, and I think in the interests of the true standard of taste the facts should be known. The two collections were most carefully judged by points (the only true way of judging), and one of them had five more points than the other, and in consequence was adjudged the first prize. A protest was immediately lodged, and the Judges were told that they were to consider them again, and that allowances were to be made for effect! Now effect means size and the number of pips on a truss, and it seems to me that to take this into account is to violate all true standards of judgment in florist flowers. It might be taken into consideration in a group of Azaleas or Pelargoniums, but it is utterly out of place in a class of Auriculas or a stand of Carnations or Picotees. It was impossible that the Judges could stultify themselves by altering the places which they had assigned after most careful judging, and so the collections were placed equal, the points being given to the second one for effect. It was an unsatisfactory method of meeting the case, as all compromises are more or less so, and I cannot but hope that at future exhibitions of the Society the absurdity of allowing points for effect will not be insisted on.

I have said that in the classes of four and two plants, exhibitors showed who I do not think in all fairness ought to be there. When one states that he has an overstock of a thousand plants that he wants to dispose of, it cannot but be that he must swamp the young exhibitor, who with his forty or fifty plants is desirous of gaining a place. He may be equally a good grower, but the certainty is that on the day of exhibition he who has a much larger number of plants to choose from must always have an advantage. In ordinary cases this of course is expected, but when classes are made for the especial purpose of allowing small growers to compete I hardly think it is desirable for the large growers to enter. I have no personal feeling in the matter. I have said the same thing with regard to Roses, in which I never exhibit; and I confess that I would much sooner win a third or fourth in sixes than be first or second in the smaller classes if I had a collection of such magnitude. I am aware that no rules can be made on the matter, and no hard-and-fast line as to what constitutes a large or a small collection, but that it must be left to individual feeling.

The opinions that one has formed of varieties already in growth are not likely to be modified in unfavourable seasons, but there are always times when some especial varieties come out stronger than at other times and others do not show to advantage. I have already said that it was not a good year for those fine varieties George Lightbody and Lancashire Hero; on the other hand, Colonel Taylor was shown in fine condition, and very beautiful it is when thus seen. Another variety that came out unusually well was Read's Acme. Some years ago, before this was sent out, I saw it at Mr. Booth's at Failsforth, and stated then in the Journal that I believed it would prove to be one of the best of the white edges. It has done so, and is, I think, far in advance of Frank Simonite, whom no "eye-opener" can quicken into loveliness; but I think the judgment of all Auricula growers will be with me when I say that all white edges must give place to Mr. Douglas's seedling "Conservative." It is a flower of first-rate properties, large, but not coarse, with a distinct white edge and good yellow tube. There is but one defect as far as very critical judgment can decide, and that is, that the paste has not the solidity which makes such a flower as Acme; it is not thin, the colour does not show through, but it has a granulated appearance. However, notwithstanding this it is, if it maintain its character, the best white edge in cultivation. The same may be said of Mr. Horner's Heroine amongst selfs. In point of form, flatness, colour, and size it leaves nothing to be desired, and its value may be seen from the fact that it secured in the classes for single specimens the first four prizes. A seedling from Mr. Barlow in the green-edged class, "Greenfinch," a very neat and refined flower, promises well. I believe that I am correct in saying that it is of the Kirkhy Malzeard brood. Although several prizes were awarded for seedlings I do not think that there was anything very noteworthy amongst them. Prince of Greens was shown well, and

a truss shown by Mr. Bolton not fully open, would, in a few days, be very fine; but I have never seen reason to alter my opinion about it; the green is lovely, but the deadness of the eye takes away all life from it, and while one would be always glad to have it, I should be sorry to give the high price that is asked for it. It seems almost impossible to combine in the white edges the beautiful violet body colour, such as in Frank Simonite, with the deep orange eye that is so highly prized by Auricula fanciers.

If cold had left its mark on many of the flowers so had heat also. Several growers grow them in heated houses, and the result is seen in long-drawn footstalks which will not stand without a crutch, and in selfs by the colour flying and giving them the appearance of shaded flowers. Commend me to one lady, whose gardener told me; "When I was leaving home Miss — said to me, 'You must take away all those sticks (which were necessary for carrying the flowers to the show) when the flowers are staged. I should be ashamed to think that ours required to be shown thus.'" This was the true spirit of a florist, and although it entailed a great amount of labour on the gardener he did it like a man. In the north these supports are considered a disqualification, and I hope yet to see them equally condemned in the south, where a more cultivated taste prevails.

Such are my jottings on the Auricula show. Whether my views are correct or not, I know that they are shared by some of the very best growers that we have; and while certain of the opinions I have given may not be acceptable to all, I yet hope that all who read these notes will believe that I have but one end in view, and that end can never be attained if we do not speak out what we think, I mean the maintenance of the Auricula as the very queen of florists' flowers.—D., Deal.

CRANSTON'S NURSERY SICK FUND.

I BEG to enclose you a copy of rules of a "Sick Fund" which we have recently established in these nurseries. Formerly it was customary to make collections for any of the employes who might fall ill, but the promoters of the Fund consider it a better means of encouraging their work-fellows to assist one another should sickness overtake them. All the offices are honorary, so that the only expense incurred in the management is a small item for printing.

The Company have given the Committee authority to compel all who may in future be employed in the nurseries to subscribe to the Fund. Upwards of 120 men and boys are employed here, and consequently subscribe. The amount of good accruing from such a combination in a large firm is, I think, apparent to all. If you deem it worthy of a notice in your valuable paper and can spare space for the same I shall be much obliged.—HENRY R. ILLMAN, Hereford.

P.S.—If by your notice of the Fund others are led to "go and do likewise," it will have had the desired effect.

[With this object we publish the Rules as follows:—

RULES.

- 1.—That the Fund assume the name of Cranston's Nursery Sick Fund.
- 2.—That all males employed at the nurseries shall become members.
- 3.—That all employes receiving 10s. and over per week shall pay in advance 2d., and under 10s., 1d. per week.
- 4.—That the benefit be 5s. per week to members paying 2d. per week, and 2s. 6d. to those paying 1d., for the first six weeks of their illness, and half-pay for the next six weeks. Any member receiving twelve consecutive weeks' sick pay shall not be entitled to any further benefit for another twelve weeks.
- 5.—That members unable to follow their employment through illness must send, or cause to be sent to the Secretary a notice of same, from which date they will be entitled to benefit.
- 6.—That any member being ill for three days only shall be entitled to a half week's pay, provided the visiting members and Secretary be satisfied as to his illness.
- 7.—That in the event of a member dying who has been in the Fund three months, his widow or friends shall receive a sum of 20s., or if before that time he should die from injuries received in following his employment, the same benefit shall be paid.
- 8.—That no member shall receive any benefit if found guilty of any criminal offence or assault, or should his illness arise from his own bad behaviour, or whilst in a drunken state, and this may be proved by any two members.
- 9.—That any member leaving the employment of Cranston's Nursery and Seed Co. be entitled to one-half the amount of his subscriptions for the current financial year, provided he has received no sick pay during that time.
- 10.—That none be considered members, nor have any claim upon the funds, after leaving the nursery employ.
- 11.—That two members of the Committee be appointed by the Secretary to visit the sick once in every week, ascertain the nature of his illness, and report to the Secretary. One of the visiting members to pay benefit and obtain receipt.
- 12.—That any member receiving sick pay shall not be from home after 6 P.M. from 1st October to 31st March, nor after 8 P.M. from 1st April to 30th September.
- 13.—That the funds be invested in the Post-office Savings Bank (for the exclusive benefit of the members) in the names of the two Trustees.
- 14.—That at the expiration of each year a statement of accounts shall be issued by the Secretary at a General Meeting, when it may be considered whether the Funds will warrant a further allowance to be made weekly (after

placing a sufficient amount to a reserve fund), also to determine what bonus shall be refunded to members who have not received any sick pay during the financial year.]

MUSHROOM CULTURE.

THE able and interesting series of articles upon Mushrooms that recently appeared in the *Journal of Horticulture* not only gave a great amount of valuable information as to their successful and profitable cultivation, but, judging from the numerous inquiries having reference to the subject, caused many readers of the Journal to try for themselves the method so carefully explained by Mr. Wright. Statements from correspondents fully corroborate the value and truth of the articles in question, and testify to the general interest they have awakened in Mushroom culture. At Oakbrook, Sheffield, the residence of Mr. Mark Firth, the system has been tried with very good results. Mr. W. K. Woodcock, the head gardener, having seen the crops produced by the skilful management of Mr. Barter, determined to give his system a fair trial in the open air; and about three months ago made up a bed, which when ready was duly spawned, and notwithstanding the recent very severe weather, so unusual in March, it is now in full bearing.

The Mushrooms are of very firm texture and good flavour. They have been gathered in abundance for the past three weeks, and at the present time the bed is well filled with clusters of fine Mushrooms, and promises a very abundant yield for some time to come. I counted three of the clusters, which are numerous, and found them to contain twenty, eighteen, and fifteen Mushrooms respectively, the greater portion being 3 or 4 inches in diameter. They grow so thickly together that many have not sufficient room to expand properly, and are therefore somewhat out of shape in consequence of being pressed so closely together. One or two fine specimens that had a little more space to grow in would be considerably over half a pound in weight.

The bed, which is ridge-shaped and covered with a good coat of litter, was not opened the whole of its length, a couple of yards or so on one side only being uncovered for my inspection. As it is about 10 yards long it will yield a very large crop indeed. Such excellent results in the open air at a time when the weather has been so unfavourable is very gratifying, and proves both the accuracy and value of the articles previously alluded to. If the system is carefully carried out there appears to be no reason why a good supply of Mushrooms should not be obtainable all the year round by both amateur and professional gardeners.

Since I saw Mr. Woodcock's bed a few days ago I have had a letter from him saying that he has gathered about 2 pecks from it since my visit. Several of the principal gardeners here have also been to look at it, and all are both delighted and astonished at the result. As you are aware by the short notice sent by Mr. Woodcock a little time ago, Mr. Walker has been growing Mushrooms in sphagnum moss. If you think a short article upon this method would be accepted I will either write one or get Mr. Walker to do so. He has had many inquiries by post since the notice appeared in the Journal.—J. H., Sheffield.

[We shall be obliged by further particulars relative to the method of culture indicated.]

THE LATE MR. SADLER.

WILL you allow me to call the attention of our hardy-plant fraternity to the fund now being collected for the family of the late Mr. Sadler?

The Edinburgh Botanic Garden rockwork and hardy plant ground was, as is well known, one of the early successes in alpine plant-growing. This was a hobby of the late Mr. McNab, and well carried on by his successor Mr. Sadler; hardy-plant growers have benefited by his work. Mr. Sadler died at the early age of forty-five, before he had time to make provision for his large family, who are left very poorly off. A relative, the scientific head of the Edinburgh Botanic Garden, called my attention to the fund. I have found friends disposed to contribute, and now ask the favour of the large circulation of your columns to make the fact that a fund is being raised more generally known. Dr. William Craig, F.R.S.E., 7, Lothian Road, Edinburgh, is the receiver of subscriptions.—GEORGE F. WILSON, Heatherbank, Weybridge.

CALADIUM ESCULENTUM.—Although we are informed the Caladium esculentum was first introduced from tropical America in 1739, there nevertheless seems to be some uncertainty as to whether that part of the world is in reality its original home or not. One might naturally infer from its rank and wild abundance in various parts of Africa,

where it appears to have flourished from time immemorial, to be indigenous there. The writer has not forgotten the immense area covered with *Caladium esculentum*, *Cyperus*, *Agapanthus*, *Dracæna*, *Richardia*, *Sansevieria*, and similar plants, which luxuriate about the creeks, lagoons, and lowlands on each side of the Orange and Limpopo rivers, in "the dark continent." Its vast quantities thereabouts is too common to excite wonder, except to the stranger. I have forgotten, if I ever knew, by what name it is there known to the natives. But this much I know of it, that along the Gold and Slave Coast in tropical Africa, where it grows from 8 to 10 feet high, the negroes eat it under the name of Eddoes. I also saw it in New South Wales, about the Darling river, and other parts of Australia, where it grew wild, as it does in Texas and Mexico. Again, I have seen the New Zealanders, as well as the inhabitants of Norfolk Island, where it seems to be equally at home, roasting it for food. As with the Maize, it may be considered a travelling plant; and, like it, only stops to settle where it finds the climate favourable.—W. T. HARDING (in *The American Gardeners' Monthly*).

STIGMAPHYLLON CILIATUM.

OLD plants as well as new are worthy of having their merits recorded, hence we direct attention to this attractive stove plant. It is only met with occasionally, but its cheerful yellow flowers



Fig. 85.—*Stigmaphyllon ciliatum*.

and pleasing foliage entitle it to a place in our stoves. It is an evergreen perennial, and was introduced from Brazil towards the close of the last century. Its habit is somewhat trailing, hence it requires some training; but it never looks so well as when growing against a wall and not fastened too closely. It is easily cultivated, requiring only a mixture of loam and peat, and frequent syringings, to prevent red spider attacking it. Cuttings of half-ripe shoots strike tolerably freely if inserted in silver sand and protected with a bellglass. It commences flowering in April, and continues growing and flowering for many weeks. Its sprays are pretty for associating with other cut flowers in furnishing vases, but they do not endure long when severed from the plant.

THINNING PEAR BLOSSOM.

I HAVE been gardening for over fifty years, but this is my first year to see almost every dwarf Pear tree, from 6 feet high downwards, in my garden, with a tuft of flower buds on the extremity of every branch. I have seen many flowery years, but this one for Pears quite surpasses them all. Then quoth I to myself, if I allow all these flowers to open I expect the trees will die by

exhaustion and my Pears will have to come from abroad, while if I pull off most of the flower bunches the trees may be strong enough to set some Pears, and with sun ripen them. So scissor armed in this lovely weather I set to work and clipped off three-fourths of the bunches of flowers of so many of my thirty to forty little trees. Had I done them all, a week would not have seen me through the work. Then quoth I to myself, I will clip away every bud from every branch cluster but the strong end or centre bud, which ought to be stronger in body (as he looks) than his side satellites, which I clip all away, thus reducing each flower bunch to the one centre bud, which, if the trees had any discretion at all, really ought to become a trump Pear (frost permitting).

Now, then, do tell me, if wise gardeners have reduced the pips or bunches of their Pear trees in such circumstances this spring, and observed more than average crops set, as they think, from using the scissors; or if other men have clipped away all the buds but the stout centre one, and observed this setting better than the flowers where merely few bunches were left on the tree. And although tackling so many trees (my gardener scoffs at my idea) is alarming, I will have a try at them as soon as you say "Go ahead, and you'll prosper."

I told you about a crazy branch of a Vine, led from my vinery to shade my conservatory from too much sun. Now that unearthing the Vine roots had started the conservatory Vine buds 3 inches before those in the vinery, the former have kept all ahead ever since, and have such shoots and bunches as never grew in my conservatory till now; though I would say I never had more poorly ripened wood in the latter than last year. "Some things no fellow can understand," any more than—J. MACKENZIE, M.D.

[We have heard of blossom being thinned with advantage to the succeeding crop of fruit, but the custom is to thin the fruit after the blossom has been shed. We have not heard of the plan of leaving only the central blossom. Instead of advising you to "go ahead," we would prefer that you halt in your manipulations, note carefully the results, and in due time oblige by allowing us to publish them for the benefit of others. The portion of the Vine in your conservatory is, we presume, the younger and more vigorous portion, hence the promising crop.]

REMOVAL OF A MEMORABLE ELM.

ON the Dover Road, also known locally as the "Old Road," a little to the south of the town of Gravesend, there was formerly an inn bearing the sign of the "Old Sun," familiar to travellers in the era when this road was lively with coaches before railways had been constructed. Beside this inn stood an ancient Elm of considerable size, largest of the remaining Elms in the vicinity, but this it has been now thought requisite to fell, since the condition of the tree was dangerous. The wood had been extensively attacked by the caterpillar of the Goat Moth, one peculiar circumstance being that the base of the trunk appeared to be sound, as there were no holes or outer fissures until the height of nearly 9 feet. On inspection, however, about 8 feet depth of water was discovered within, an accumulation consequent upon the heavy rains of the past winter. Under ordinary circumstances the grubs of a beetle, *Scolytus destructor*, make various channels through the bark to the interior of a tree, completing the ruin began by the Moth caterpillar, and bringing it to the ground piecemeal very frequently. In an instance like this, as the caterpillars, voracious as they are, do not actually clear the hollow space, it must be formed partly by the evaporation of its contents as gases, partly by a solution of them passing down the bole into the soil, I presume.—J. R. S. C.

CUTTING DOWN CAMELLIAS.

WHEN I wrote to you about cutting down Camellias on page 156, February 23rd, 1882, I did not intend to advise the cutting-down of all Camellias, but only such as were grown too tall for the house, or such as were like the two I had to deal with. They were not only infested with insects, but they were bare of young wood for more than 24 inches from the pots. By cutting the plants down they broke freely from the old wood and made healthy plants in one year, and in my opinion they could not have been similarly improved in six years by any other mode of treatment. Nor do I believe they would ever have broke so low down so long as there were a few growing branches left. I am rather surprised at "J. U. S." saying that unless plants are in vigorous health the less they are cut the better, as that is quite the reverse of my experience. I should have sent this letter last year, but several gardeners said it would be many years before my cut-

down plants bloomed again, so I waited for the result. This year one of the plants produced between thirty and forty blooms, and is as handsome and as healthy a specimen as ever grew, therefore it has only lost one year's bloom. I have had forty years' practice in cutting down trees, and if my experience would be any use to any of your readers at any time they shall have it with pleasure.—THE LITTLE MARKET GARDENER.



THE first evening meeting of the ROYAL HORTICULTURAL SOCIETY for 1883 will be held, by permission of the Linnæan Society, in their rooms, Burlington House, on Tuesday, May 8th, at 8 P.M., when the chair will be taken by the Right Hon. Lord Aberdare. Communications from Dr. M. Foster, F.R.S., on "Iris Susiana and its Allies; their Nature and Culture." Dr. Hogg on "Australian Apples." Mr. E. G. Loder, on "Hardy Cacti; their Habitats and Culture." Herr Max Leichtlin, on some novelties in the garden at Baden-Baden. Mr. W. Goldring, on "Cypripediums," are announced to be read. Two-guinea Fellows, whether ladies or gentlemen, may personally introduce one, and four-guinea Fellows two, visitors as guests.

— WE learn from the *Athenæum* that the FOUNDERS' MEDAL OF THE ROYAL GEOGRAPHICAL SOCIETY is to be given to Sir Joseph Hooker, F.R.S., "for his eminent services to scientific geography, extending through a long series of years and over a large portion of the globe, while engaged in voyages in the Antarctic and Australian seas, and journeys in India and Himalaya, in Morocco, and in the United States of America; and more especially for his long-continued researches in botanical geography, which have thrown light on the form of the land in prehistoric times, and on the causes of the present distribution of the various forms of vegetable life on the earth."

— THE new IMANTOPHYLLUM MRS. LAING, shown by Messrs. Laing & Co. of Forest Hill at Kensington on the 24th ult., is likely to prove a useful variety, the colour being a rich orange-red, the flowers well formed, and the trusses large. These plants, with Caladiums and Tuberos Begonias, are now receiving much attention from Messrs. Laing, and the last-named are promising for a grand display.

— YESTERDAY (Wednesday) MESSRS. W. PAUL & SONS' EXHIBITION OF ROSES IN POTS was commenced in the Royal Botanic Society's Gardens, Regent's Park, and will be continued until the 10th inst. About 400 healthy well-flowered bush-like specimens are arranged in the corridor, forming a most beautiful bank, the side stage being devoted to boxes of cut blooms, fresh, bright, and highly coloured. A large number of the best varieties are represented, including the new ones—Lady May Fitzwilliam, Queen of Queens, Distinction, and many others. Of the older varieties, Magna Charta, La France, Fisher Holmes, John Hopper, Marie Baumann, Countess of Rosebery, Niphotos, Pride of Waltham, Bessie Johnson, and Edouard Morren are very fine. Messrs. W. Paul have for several years contributed a handsome collection to these Gardens, but this season they have surpassed previous efforts, the plants being uncommonly vigorous, the flowers of great substance, and the colours rich. The Show will prove a great attraction to visitors during the present and next week.

— THE FARNINGHAM ROSE SHOW will take place on Thursday, July 5th. Fifty-five classes are enumerated in the schedule in eight divisions, open, for nurserymen, amateurs, ladies, and cottagers. Roses constitute the chief feature, but prizes are also offered for miscellaneous flowers, plants, fruits,

and vegetables. In the Rose classes the resolution of the National Rose Society with respect to too-much-alike varieties is adopted, and only one of those bracketed together in their catalogue of exhibition Roses will be permitted to be shown in one stand.

— THE new CLEMATIS KRAO, which was shown by Mr. C. Noble of Bagshot at Kensington last week, is an exceedingly distinct and striking variety, and the first-class certificate awarded for it was well merited. The flowers are of good form, the sepals broad and ovate, dark purplish shining blue, which is in marked contrast with the white stamens and pistils in the centre. This last character is a very uncommon one, as usually the dark flowers have light centres, and *vice versa*; and Mr. Noble states that this is the first dark one he has succeeded in raising with a white centre. It is a decided advance, and will unquestionably become a favourite in most collections owing to its distinctness.

— THE SOUTH ESSEX FLORICULTURAL SOCIETY will hold their annual summer Exhibition on Thursday, June 14th, when prizes will be offered in sixty open classes for plants, flowers, fruits, and vegetables, twenty-two classes being in addition specially devoted to amateurs.

— THE Hoop Petticoat Daffodil, NARCISSUS BULBOCODIUM, has long been a favourite in English gardens; but it is probable that finer specimens in pots than those from Mr. J. Douglas at the Royal Horticultural Society's meeting last week have never been publicly exhibited. They caused quite a little furore, and there was a cluster of visitors around the table bearing them and the Primulas nearly the whole of the afternoon. Pots 6 inches in diameter had twenty to thirty large flowers, and the decorative value of such specimens is inestimable. Six to a dozen bulbs were placed in the pots, a rich light loamy compost being employed, the plants being in most vigorous health and the flowers handsome.

— MESSRS. BACKHOUSE & SONS of York have sent us a sample of hearting CURLED KALE with the following note:—"The heads were gathered from the flat of plants intended for seed in an open quarter of our grounds. Considering that for twenty-eight nights in March we had continuous frosts, varying from 7° to 25°, under which vegetation shrunk terribly, we think the sample will be considered a fair type of this very useful vegetable. Being of dwarf compact habit helped it much in escaping the cutting effects of the bitter winds that cut most green things so badly." The heads are very compact, and so finely curled as to resemble Parsley. The variety is similar to that for which a first-class certificate was granted last week at South Kensington, as it is no doubt a very distinct and excellent form of the dwarf curled Kale.

— THE HORTICULTURAL SECTION of the Furniture Trades Exhibition now being held at the Agricultural Hall, though of moderate extent, is well worth a visit, as several firms contribute samples of garden appliances of considerable merit. The portion of the hall reserved for these exhibitors is that near the Upper Street entrance, a few also having stands in the galleries. Very notable are the numerous boilers shown by Mr. B. W. Warhurst, 33, Highgate Road, Kentish Town; while of other firms who exhibit the most noteworthy are Messrs. J. Warner & Sons, Cripplegate; Wrench & Sons, Ipswich; Messenger & Co., Loughborough; J. Matthews, Weston-super-Mare; J. J. Thomas and Co., Queen Victoria Street; and W. Richardson and Co., Darlington.

— IN a recent issue of *La Belgique Horticole* a coloured plate is given of a very distinct Bromeliaceous plant, SCHLUMBERGERA MORRENIANA, which was originally exhibited by Messrs. J. Linden at Ghent in 1878, and Brussels in 1880, under the name of Massangea Morreniana. On examining the

flowers, however, Professor E. Morren refers it to the above genus. It is a strong-growing plant, with leaves nearly 3 inches in diameter, and about 2 feet long, and arching or drooping, deep green on the upper surface, with darker irregular fine transverse lines, the under surface being streaked transversely with fine but closely set purplish brown lines. The flower stem is a foot or more in height, the bracts being large deep crimson, and the flowers pale yellow.

— SEVERAL good specimens of the rare and beautiful Fern *BRAINEA INSIGNIS*, are now very conspicuous in the fernery at Kew. They mostly have stems 3 or 4 feet high, with fine crowns of handsome arching pinnate fronds 2 feet or more in length, the pinnæ narrow, lanceolate, and dark green. These plants were imported about two years since from Hong Kong, of which island the species is a native, and there it was originally found by Mr. Braine, after whom it is named. This Fern is also remarkable for the quickness with which the spores germinate. Mr. J. Smith records in his "Historia Filicum" that some have been observed to germinate in forty-eight hours. Some of the Kew plants are now showing spores.

— THE following GARDENING APPOINTMENTS have been made through Messrs. John Laing & Co., Forest Hill:—Mr. J. McKenzie, late gardener to Mrs. Platt, Stoberry Park, Wells, Somerset, has been appointed in the same capacity to A. V. Somerville, Esq., J.P., Dinder House, Wells, Somerset. Mr. A. Campbell, late gardener to A. Peterson, Esq., Gipsy Hill, Norwood, has been appointed gardener to R. Melville, Esq., Hartfield Grove, Hartfield, Sussex. Mr. Clayton of Grimston Park informs us that his foreman, Mr. John Rose, succeeds Mr. Atkins as head gardener to Sir Robert Loyd Lindsay, Bart., Lockinge House, Wantage.

— C. M. MAJOR, Esq., Cromwell House, Croydon, writes:—"I see in your last issue a notice of *RHODODENDRON NUTTALLI* being in flower at Highfield. The way in which you speak of it leads me to believe that it might interest your London readers to be able to examine one nearer home, as I have a specimen with three trusses of bloom, also showing seven flowers in a truss, the diameter of the truss being 12 inches. When the Sikkim Rhododendrons were first introduced, as I believe, by Messrs. E. G. Henderson of St. John's Wood about thirty years ago, I purchased several of the varieties, and I still have some of the original plants, although I regret to say that they are becoming too large for my accommodation. *R. Dalhousiæ*, *R. Wightii*, and *R. Aucklandii* are flowering well, and should any of your readers be in my neighbourhood it will afford me much pleasure to be able to show them a beautiful sight."

— AN INTERNATIONAL HORTICULTURAL EXHIBITION IS TO BE HELD AT LILLE, FRANCE, from September 1st to 9th of the present year, and will be the tenth organised by the Cercle Horticole du Nord. The schedule enumerates 185 classes, in which gold, silver-gilt, and silver medals are offered as prizes for a great variety of plants, flowers, fruits, and miscellaneous objects of horticultural interest. In addition, prizes of 100 francs are offered to French and foreign exhibitors who contribute most largely to the beauty of the Show.

— MESSRS. W. PAUL & SON, Waltham Cross, thus describe THE NEW AFGHAN YELLOW ROSE, *ROSA ECÆ*:—"This interesting novelty has been recently introduced from Afghanistan by Dr. Aitchison, and is described as being in many respects not unlike *Rosa pimpinellifolia*, but the prickles are all of one kind, instead of large ones interspersed with smaller bristly ones, and the flowers are yellow. This Rose, Dr. Aitchison says, is one of the commonest shrubs in some parts of the country. The flowers are not large, being about an inch in diameter, but they are

exceedingly numerous, and are borne on short lateral shoots all along the branches."

— AN unpretentious but pretty hardy plant is *SAXIFRAGA CYMBALARIA*, a native of the Caucasus, which is now familiar to many as an occupant of rockeries and similar positions; but it is rarely seen so usefully employed as is the case in the conservatory at Leigham Court, Streatham, the residence of Mrs. Treadwell. Mr. E. Butts, the gardener there, employs it for decorative purposes during the winter, and his method of treatment is worth noting. A few seeds are sown in pans or boxes in autumn, and the young plants so obtained are pricked out into 60-size pots of light soil. In these the plants grow strongly, forming dense conical bushes 6 to 8 inches high, their small but numerous bright yellow flowers showing well in contrast with the rich green leaves, which closely resemble the widely known *Linaria Cymbalaria*, the common Toad Flax. These little specimens are freely employed as a marginal row along the shelves, and have a most pleasing appearance.

— REFERRING to Mr. Grant Allen's letters on the FORMS OF LEAVES, which have recently appeared in *Nature*, Sir John Lubbock writes as follows to the same periodical:—"Mr. Grant Allen's letters open up a number of interesting questions, but for the moment I will only refer to his suggestion with reference to the reason why water plants so often have their leaves cut up into fine filaments. He tells us that this is because the proportion of carbonic acid held in solution by water is very small, and that, therefore, for this amount there is a great competition among the various aquatic plants. The question has already been asked on what grounds Mr. Allen makes his statement with reference to the proportionate amount of carbonic acid. Without entering on this point, I would, however, venture to suggest that the reason for this tendency in the leaves of water plants is mechanical rather than chemical. It is, of course, important for all leaves to present a large surface for the purposes of absorption with as little expenditure of material for purposes of support as possible. Now delicate filaments, such as those of water plants, present a very large area of surface in proportion to their mass. On the other hand, they are unsuited to terrestrial plants, because they are deficient in strength and unable to support themselves in air. Take, for instance, a handful of the submerged leaves of an aquatic *Ranunculus* out of the water, and, as everyone knows, the filaments collapse. This seems to me the real reason why this form of leaves is an advantage to water plants. It is, perhaps, for the same reason that low-growing herbs, which are thus protected from the wind, so often have much-divided leaves."

— THE Pennsylvania Horticultural Society having invited the AMERICAN POMOLOGICAL SOCIETY to hold its next meeting at Philadelphia, the nineteenth session of this Association will be held in that city, commencing Wednesday, September 12th, 1883, at 10 o'clock A.M., and continuing for three days. The session will take place at the time of the fifty-fourth annual Exhibition of the Pennsylvania Horticultural Society. All horticultural, pomological, agricultural, and other kindred associations in the United States and British provinces are invited to send delegations, and all persons interested in the cultivation of fruits are invited to be present. The following gentlemen will prepare papers for the above meeting:—Hon. P. J. Berckmans, President of the Georgia Horticultural Society; Prof. T. J. Burrill, Illinois Industrial University, on Diseases of Plants; Prof. J. L. Budd, Iowa Agricultural College, on Experimental Horticulture west of the Lakes; Col. N. J. Colman, Editor of the *Rural World*, Missouri, on Utilising our Fruits; Prof. J. Henry Comstock, Cornell University, on Insects of the Orchard; Dr. W. G. Farlow, Prof. of Cryptogamic Botany, Harvard University, on Uredineæ (Rusts and Mildews); Chas. A. Green, Editor of the *Fruit-Grower*,

on Certainties and Uncertainties; Samuel Hape, Esq., Atlanta, Georgia, on the Effect of the Evening Sun on Fruit Trees; Byron D. Halsted, D.Sc., Editor of the *American Agriculturist*, on Fungi; Josiah Hoopes, Esq., Ex-President of Fruit-Growers' Society of Pennsylvania, on Peach Culture in Pennsylvania; Prof. W. R. Lazenby, Ohio State University, on Dichogamy in Cultivated Plants—*i.e.*, noting examples where the stamens of a flower mature before the stigmas, or the stigmas before the stamens; Hon. T. T. Lyon, President Michigan State Horticultural Society, on How can we best maintain a high standard of quality in fruits, as against the tendencies of commercial pomology; J. C. Plumb, Esq., Milton, Wisconsin; Prof. C. V. Riley, U.S. Entomologist, on Recent Advances in Horticultural Entomology; Dr. E. Lewis Sturtevant, Director of the New York Experiment Station, on Some Things the Station can do for Horticulture; Prof. S. M. Tracy, Missouri University, Secretary of the Mississippi Valley Horticultural Society.

STANDARD ACACIA LOPHANTHA.

SEEDLING plants of this Acacia, so easily raised annually, have long been highly valued for decorative purposes both indoor and out. As a seedling it is singularly elegant, the straight erect stem bearing large green pinnate foliage, handsome as the fronds of a Maidenhair Fern, curving gracefully and gently downwards, not at all crowded, but far enough apart to impart lightness with fulness and to show the full beauty of each leaf. Seen under this guise they are very attractive as a miniature forest springing out of a carpet of rich colour in a summer flower bed, placed singly in vases for sitting-rooms or the dinner table, or mingled with other plants in groups or window boxes.

Some plants raised last year kept fresh and useful in 5-inch pots throughout summer, autumn, and winter, but they continued growing, and by the approach of spring had become somewhat ungainly in height; but instead of discarding all of them a few of the best were shifted into 7-inch pots, and they were pruned to a uniform height of 4 feet in view of converting them into handsome standards with round compact heads. Lateral growth followed so quickly that our object will soon be attained. In point of fact lateral growth comes naturally with the second year's growth, and I am not at all sure that some plants left unpruned will not eventually prove the most handsome in the graceful freedom of the less formal unchecked growth.—EDWARD LUCKHURST.

EPIDENDRUMS

In the admirable review of the family Orchidaceæ by Mr. G. Bentham, published in the Transactions of the Linnæan Society, 1881, it is stated that nearly 400 species of Epidendrum are known; but scarcely a fourth of these are in cultivation, except in botanic gardens. Twenty years previously Reichenbach enumerated 385 species in Walpers' "Annales," but these included many that are usually referred to other genera—many plants described by Lindley under *Cattleya* and others. Previous to the present century very few Epidendrams were known; for instance, in the second edition of Aiton's "Hortus Kewensis," published in 1813, nine species only are mentioned—namely, *E. cochleatum*, *E. fragrans*, *E. secundum*, *E. fuscatum*, *E. elongatum*, *E. umbellatum*, *E. nutans*, *E. conopseum*, and *E. ciliare*. All these were introduced in the last fifteen years of the eighteenth century, the earliest being *E. conopseum*, which was found in Florida by Mr. William Bartram, and introduced to England by Dr. John Fothergill in 1775. In contrast with this it may be mentioned that the Kew collection now comprises fifty-nine well-marked species, probably the largest number now grown in one garden, at least in England.

Though so numerous, however, the genus *Epidendrum* includes comparatively few really useful and handsome garden species, and in this respect it is unlike the *Denrobriums*, *Odontoglossums*, *Oncidiums*, and other large genera. The majority of forms have greenish, yellow, or brownish flowers, small or insignificant in appearance, but to counterbalance they possess a great variety of powerful and agreeable odours. A glance at the specific names will sufficiently indicate this. For instance, there is *E. fragrans*, *E. cinnamomeum*, *E. inosmum* (Violet-scented), *E. piperimum* (Pepper-like), *E. primulinum* (Primrose-scented), and *E. meliosmum* (honey-scented). Many besides also have very distinct odours, but they have obtained their names from characters of

form, colour, or other qualities. This generally diffused fragrance has rendered some of the least beautiful forms favourites with Orchid-growers, but in addition there are at least a dozen species of remarkable cultural value, and it is only necessary to mention one as an example—*viz.*, *E. vitellinum*, which has become almost indispensable wherever Orchids are grown for decorative purposes.

Epidendrams have a wide range over the northern hemisphere, the East and West Indies, Tropical South America, Mexico, and the Southern States of North America having their characteristic species. Nearly all are epiphytal in habit, as the generic title indicates, but a few are terrestrial; and though some appear to evince a partiality for blocks or baskets in cultivation, they can mostly be satisfactorily grown in pots or pans. If a house is specially devoted to Mexican Orchids the temperature provided for them will suit the majority of *Epidendrams*; but in any house where a night temperature of 60° and a day temperature ranging between 65° and 75° can be secured good results can be insured with comparatively little trouble, except in the case of a few rather fastidious species. When grown in pots drainage must be carefully attended to, a compost of good fibrous peat and sphagnum moss being provided; and the same is suitable for either pans or baskets, while those grown on blocks can be secured with wire and a little fresh moss.

It would be unnecessary to enumerate even half the species of this genus, but some of the most interesting, useful, or beautiful may briefly be noted.

E. conopseum, referred to above, though not of remarkable beauty, is interesting from the fact that it is reputedly the most northern epiphyte known. In Walpers' "Annales" it is said to be "wild in the southern States of North America, having been found on evergreen trees on the seacoasts of Carolina and Georgia, and has been found as far north as Edings Island. It is more common in the south, and is found on species of Oak and other trees." Sir Joseph Hooker has stated that "When Drummond gathered it in Apalachicola ice formed so thickly in one night's time as to bear the weight of a man." The plant is a few inches high, with yellowish or green flowers, and can therefore only be considered as a curiosity.

E. bicornutum.—This is more generally known as an *Epidendrum*, though this has been separated with the species *bidentatum*, *bilamellatum*, and *bigibberosum* under the name *Diacrium*, distinguished by the horn-like projections on the lip. Whatever it be termed it is undoubtedly a charming Orchid; and it is regrettable that growers have found such difficulty with its culture that it has obtained a rather bad reputation. This, however, is undeserved, for in the Royal Gardens, Kew, for several years past plants have been most successfully grown and freely flowered. At the present time several good specimens are flowering in the Orchid house there, proving that the treatment required is well understood. Mr. George Walters, who for some time had charge of the above collection, was particularly successful with the plant, and he so well described its requirements that it may be reprinted here with advantage.

"The best way to grow it is in baskets suspended from the roof or on pieces of Tree Fern stem. I have grown and flowered it under both systems, and if grown in baskets a compost of very fibry peat, moss, and charcoal should be employed. The plant roots freely in its natural habitat, but is rather shy-rooting under cultivation. Having a friend living in Trinidad, I wrote him for particulars with regard to where it was found and under what conditions, and in reply he writes, 'With regard to your questions respecting *E. bicornutum*, if I tell you how I collected it no doubt that will suffice. I went out one day last week, hired a boat to carry me to the Five Islands, a group of irregular size, standing at no great height out of the water, in one bend or basin of our harbour, which may be called rocks left after the severance of that part from the mainland by the encroaching influence of the sea. Round these islands one can sail and soon load his boat by pulling the tufts off the ledges of the rocks or any cavity. It is subject to drenchings of water by the action of the waves, is generally fully exposed to the sun, and as it is surrounded by water the plant must be subject to heavy dews owing to the great variation in temperature of the land at night. I soon collected a load, though I am afraid they are too much advanced in growth for travelling.' By these remarks it is easily perceived that the three most essential requirements of *E. bicornutum* are heat, exposure to sun, moisture, and a moderately low night temperature, and if these be carefully attended to it should make satisfactory progress."

The plant is a native of Trinidad and some other West Indian islands, and was first introduced by Messrs. Shepherd of Liverpool about fifty years ago. The flowers are of moderate size, 1½ to

2 inches in diameter. The sepals and petals are ovate, pure white, of wax-like substance, the lip also being white, with numerous small violet dots; and the two projections at the base of the lip, which gives the name to the species, are yellowish. The racemes are 6 to 9 inches long and bear several flowers near their apex, their fragrance being most delicate and pleasing. The old pseudobulbs are often hollow and are a favourite resort for ants, which are very troublesome. Cockroaches, too, are rather partial to the flowers, and must be carefully watched for.

E. nemorale.—Quite distinct from the foregoing is this handsome Orchid, which is sometimes seen under the name of *E. verrucosum*, and with which it is figured in the "Botanical

Register" and "Botanical Magazine." It is a native of Mexico, where it has been found growing on trees in groves near Sultepec. The sepals and petals are narrow, of a pale rose or mauve hue, the top being much darker, often a rich rose colour, with deep streaks. The flowers are borne in racemes or panicles, which are frequently 2 or even 3 feet long, and a plant in its best condition with these long drooping or arching racemes has a most beautiful appearance, scarcely surpassed by any other member of the genus. The woodcut represents a plant that flowered very freely in Messrs. J. Veitch & Sons' nursery, Chelsea. The figure faithfully depicts the chief characters of the Orchid, both in its habit and the form of the flowers. A variety with much larger and deeper



FIG. 86.—EPIDENDRUM NEMORALE.

coloured flowers, named majus, is also grown. Probably the finest specimen of this in cultivation is one I have seen in the Burford Lodge collection, which is about 4 feet in diameter, and has borne eighteen racemes of flowers at one time.—L. CASTLE.

(To be continued.)

AMERICAN ALOES AT OXFORD.

ON a lawn near to the succulent house in the Oxford Botanic Garden under the care of the Curator, Mr. W. H. Baxter, there are at the present time two noble specimens of American Aloes

that will during the approaching summer be in bloom. Until recently they have occupied a prominent position in their winter quarters, but the rapidity with which they have developed their flower-spikes has necessitated their prompt removal to the situation indicated, where they are effectually sheltered from unpropitious weather by a temporary structure about 25 feet in height. The largest specimen is a remarkably handsome plant with variegated leaves, some of them measuring more than 6 feet in length, from which rises a healthy flower-spike, already exceeding 10 feet in height, and which exhibits every indication of developing into an exceedingly fine one. The companion plant is of the green-leaved kind, but little inferior in size, and has produced a flower-

spike but little less gigantic than that of the former one. The coincidence of these splendid plants flowering at the same time imparts to them an interest that will doubtless render them objects of considerable attraction to those who are enabled to visit the Oxford Botanic Garden during the period in which they will be in bloom.—SPES.

CALCEOLARIAS.

CALCEOLARIAS are sometimes disappointing plants, often dying in a mysterious manner, giving no warning. In flower gardens where the massing system is carried out we can ill afford to dispense with them, and it is difficult to find a substitute, as, though some recommend the Tagetes, it is not nearly so good. So the best thing we can do is to try and mitigate the evil. It is unseasonable to write about the propagation; but supposing the cuttings were taken from healthy plants in the autumn, inserted in a cold frame, and afterwards placed in a frame of turfy soil, with about a fourth of well-decayed manure, the plants will be in fine condition by the planting time. The beds should have been deeply dug in the early winter, and a few days before they are planted to be well dug again and well manured with some good decayed manure. I always choose a damp day for planting Calceolarias, which should be well watered the previous night, and take them up with a good ball of roots. If any streaks of black are seen in the leaves of any of the plants, or with black stems, they should be rejected, as they will be sure to go off. Keep the surface of the beds well stirred for a few weeks, which will benefit them. If the weather is likely to be dry give the beds a thorough soaking of soft water, and mulch with short manure. Golden Gem I have found to be the best variety.—A. YOUNG.

NATIONAL AURICULA SOCIETY'S NORTHERN SHOW.

THIS was held at Manchester on Tuesday in the present week, when the following awards were made by the Judges:—

Class A.—Six dissimilar Auriculas.—First, Mr. Bolton, 84, Welshpool Road, Warrington, with George Lightbody, seedling (green), Frank Simonite, Alexander Meiklejohn, Sapphire, and Prince of Greens; second, Mr. W. Brockbank, Didsbury, with Lancashire Hero, Richard Headly, Mrs. Douglas, seedling (self), George Lightbody, and Smiling Beauty; third, Mr. E. Pohlman, Halifax, with Col. Taylor, Lancashire Hero, Regular, Brunette, Acme, and George Lightbody; fourth, Mr. H. Wilson; fifth, Mr. Ben Simonite, Sheffield; sixth, Mr. R. K. Penson, Ludlow.

Class B.—Four dissimilar Auriculas.—First, Mr. E. Pohlman, Halifax, with Acme, George Lightbody, New Green, and Mrs. Douglas; second, Mr. Brockbank, with C. J. Percy, John Simonite, Richard Headley, and Lovely Ann; third, Mr. Penson, with Frank Simonite, Topsy, George Lightbody, and Col. Taylor; fourth, Mr. William Bolton; fifth, Mr. Ben Simonite; sixth, Mr. H. Wilson; seventh, Mr. R. Gorton, Eccles.

Class C (Pairs).—First, Mr. E. Shaw, Bury, with C. J. Perry and Alex. Meiklejohn; second, Mr. Penson with Col. Taylor and Geo. Lightbody; third, Mr. H. Wilson with Alex. Meiklejohn and Prince of Greens; fourth, Mr. Barlow; fifth, Mr. E. Pohlman; sixth, Mr. G. Geggie; seventh, Mr. Bealey. Class D (Pairs for Maiden growers).—First, Mr. R. Hey Norden with Conqueror of Europe and Acme.

Class E.—Four dissimilar shaded Alpines.—First, Mr. E. Pohlman with four seedlings; second, Mr. Gorton with Mrs. Meiklejohn, Lord Elcho, Diadem, and Beatrice; third, Mr. Prescott with Neatness, Lord Elcho, Brilliant, and Miss Annie; fourth, Mr. J. Beswick; fifth, Mr. R. Heys; sixth, Mr. S. Barlow; seventh, Mr. W. Brockbank.

Class F.—Single plant, green edge.—First, Mr. Wm. Bolton with Col. Taylor; second, Mr. Pohlman with the same variety; third, Mr. E. Shaw with Lovely Ann; fourth, Mr. W. Brockbank with a seedling; fifth, Mr. Pohlman with Lancashire Hero; sixth, Mr. Heys with Imperator; seventh, Mr. H. Wilson with Prince of Greens; eighth, Mr. W. Bolton with Trail's Anna; ninth, Mr. E. Shaw with Ringleader.

Class G.—Single plants, green edge.—Mr. Pohlman was first and third with George Lightbody and second with Lancashire Hero; Mr. Brockbank fourth with Alex. Meiklejohn, seventh with Ringleader, and ninth with a seedling; Mr. Gorton fifth with Richard Headly; Mr. Wilson sixth with John Waterston; and Mr. Shaw eighth with Beauty.

Class H (single plants, white edge).—Mr. Pohlman first and second with Acme, and fourth with Sophia Dumaresque; Mr. Penson third with True Briton and fifth with Smiling Beauty; Mr. W. Brockbank sixth with John Simonite; Ben Simonite seventh and eighth with Frank Simonite and Ne Plus Ultra; Mr. Taylor ninth with Ann Smith.

Class I (single selfs).—Mr. Gorton first and second with Blackbird; W. Bolton third, fifth, and seventh with Sapphire, Ringdove, and Ellen Lancaster respectively; Mr. Bealey fourth with C. J. Perry; Mr. Barlow sixth and eighth with seedlings; and Mr. R. K. Penson ninth with Duke of Argyll.

Class K (shaded Alpines, single plants).—Mr. Brockbank first with Diadem and fifth with Prima Donna; Mr. Pohlman second, third, and fourth with seedlings; and Mr. Barlow sixth with John Ball.

Class L.—Shaded Alpines, white centres, single plants.—First, Mr. Prescott, with Beatrice; second, Mr. Pohlman, with a seedling; third, Mr. Brockbank, with Spangle; fourth, Mr. Shaw, with Goliath; fifth, Mr. R. Gorton, with George Lightbody; sixth, Mr. Barlow, with an unnamed variety.

Polyanthuses, black ground.—Class M, three dissimilar.—First, Mr. J. Beswick, Middleton, with John o'Gaunt, Beauty of England, and Exile; second, Mr. Brockbank, with Exile, Lord Lincoln, and seedling; third, Mr. Barlow, with Beauty of England, Exile, and John Bright; fourth, Mr. Taylor, Middleton.

Red-ground Polyanthus.—Class N, three dissimilar.—First, Mr. Beswick, with Lancer, Sidney Smith, and George IV.; second, Mr. Barlow, with Prince Regent, George IV., and a seedling; third, Mr. Brockbank, with Lancer, Prince Regent, and a seedling; fourth, Mr. Heys.

Class O.—Single plants, red grounds.—First, Mr. Beswick with Lancer; second (no name), George IV.; third, Mr. Barlow, with Sunrise; fourth, Mr. Prescott with Prince Regent; fifth and sixth, Mr. Brockbank with a seedling and President; seventh, Mr. Heys with Prince of Orange.

Class P.—Single plants, black grounds.—Mr. Beswick secured the first, second, third, fourth, sixth, and seventh prizes with Exile, Cheshire Favourite, Lord Lincoln, and three seedlings; Mr. Partridge, Middleton, fifth with Lancashire Hero; and Mr. Brockbank eighth with a seedling.

Special Alpines unshaded.—Class Q.—Four plants dissimilar.—First, Mr. W. Prescott with Percival, Sidney, Spangle, and Mercury; second, Mr. Brockbank with Spangle, Prince, Florence, and John Ball.

Class R.—Twelve dissimilar Fancy Auriculas.—First, Mr. W. Bolton. Class S.—Twelve dissimilar Fancy Polyanthuses.—First, Mr. Brockbank, who was also first in the class for twelve distinct Primroses.

TABLE PLANTS AT WIMBLEDON.

AMONGST other plants of interest to be seen at Fieldhiem, Wimbledon, is a superb collection of table plants, filling a neat little span-roofed house admirably adapted for the purpose. The Crotons are finely coloured. Mr. Bennett has made a good selection of these—*C. irregulare*, *C. interruptus*, *C. Johannis*, *C. majesticus*, *C. pictus*, *C. picturatus*, *C. angustifolius*, *C. undulatus*, *C. Wiesmannii*, and others. Of *Dracæna nigra rubra* seems to be one of the best, while *D. gracilis*, *D. Cooperi*, *D. terminalis*, *D. superba*, *D. Guilfoylei*, and *D. elegantissima* are all in fine condition. *Pandanus Veitchii*, *Aralias*, *Cocos Weddelliana*, and *Geonoma gracilis* constitute a bright and chaste collection.

In an adjoining department young plants are being obtained from older ones by partly severing the stems and tying damp moss round them. This is a much quicker and better method of keeping up a succession than by striking cuttings, which will take twelve months to make satisfactory plants, whereas with *Dracænas* and *Crotons* three months will suffice to have specimens a foot high from the pot. It is noticeable that the plants are grown in very small pots, which adds still more to their usefulness and beauty; no pots larger than 54 or small 48-sized pots are employed. Mr. Bennett has already taken numerous prizes at some of the leading metropolitan exhibitions, and judging from what I saw on my visit he may expect to add more to the number.—J. P.

CHRYSANTHEMUMS FOR DECORATIVE PURPOSES.

IN growing Chrysanthemums for the decoration of small structures, plants that have never been pinched are unsuitable on account of the great height they attain. They cannot, in my opinion, be compared with neat dwarf examples from 2 to 3 feet high, carrying from six to nine good flowers with foliage down to the rim of the pot. They can be conveniently moved about, and are quite high enough to see the full beauty of the flower without the aid of step-ladders, which will certainly be required if they are grown much taller.

I give the names of a few varieties that I have found best adapted to this style of growing, which no doubt will be acceptable to those who prefer dwarf bushes. All retain their foliage well. Two plants are placed in a 10-inch pot, one plant in an 8-inch pot. They are pinched once or twice to form six shoots for single plants, nine for double. Staking is done soon after the final potting, the shoots being secured as they progress. Standen's manure is given once about the end of July; then frequently, after the buds form, in small supplies. The crown bud is the one selected. *M. Crousse* and *La Nymphe* do well on the terminal bud, but the flowers will be smaller.

The following varieties are grown, two plants in a 10-inch pot:—Queen of England, Empress of India, Mr. G. Glenny, Mrs. G. Rundle, Mrs. Dixon, Jardin des Plantes, Bronze Jardin, Golden Beverley, Hero of Stoke Newington, Reticulatum; Barbara, Mrs. Haliburton, Princess Teck, good late white; Alfred Salter, Prince Alfred, Lady Slade, Fleur de Marie, and Elaine.

Single plants in 8-inch pots.—Golden Eagle, Hero of Magdala, Barbara, M. Crousse, La Nympe, and one that I received from Mr. Etherington of Kent two years ago under the name of Norah, similar to Père Delaux. Some of the three latter are grown two plants in larger pots, and make grand bushes.

There are others that make good pinched plants—for instance, James Salter, Bouquet Fait, and Pink Perfection; but I find they are better taken on the terminal bud, for if taken on the crown they would be leafless long before the flowers expanded.—C. W.

POTATOES FOR TABLE AND MARKET.

(Continued from page 348.)

In the following notes the figures 1, 2, and 3 indicate first early, second early, and late varieties; the months the time of planting; and the asterisks those varieties that are considered the best for market purposes by the respective cultivators.

IRELAND.

LIMERICK.—1. About 8th of February. Myatt's Prolific Kidney and *Flounder's Round. Soil.—Light. 2. 20th of February. Schoolmaster. 3. 20th of February. Magnum Bonum, *Silverskin, and *Scotch Champion. Soil.—Heavy. Manures and Application.—Manure composed of leaves and grass applied on the tops of sets in drills. General Culture.—Schoolmaster Potato is not good after three years' trial. It is soft and watery. Magnum Bonum is not fit to eat for two or three seasons after being imported. The climate here does not suit any imported varieties. The Flounder is the best early Potato for market purposes and the best Potato for general consumption, but is often diseased.—GEORGE BUTTERY, *The Gardens, Adare Manor.*

LONDONDERRY.—1. Middle of March. *Myatt's Prolific, *Lee's Hammersmith, *Veitch's Improved, and Rivers' Royal Ashleaf. Soil.—Medium. 2. End of March. For field culture *Flounder, York Regent. 3. Beginning of April. For field culture White Rocks, *Champion, *Magnum Bonum, and Skerry Blues. These are cultivated by all the farmers for market. Manures and Application.—We find we obtain the best crops here by applying farmyard manure during February if weather permits. We ridge most of our ground. We place a spit in the bottom of the trench, upon that a moderate layer of manure, then take another small spit to form the ridge. The ground remains in this state until the time for planting, which usually is about the middle of March. This is as early as we can plant them with safety in the north of Ireland. They are prepared for that time in a moderate heat, and have buds from 1 to 2 inches long. General Culture.—As soon as the ground is in proper order, either a little earlier or a little later according to circumstances, the ridges are forked down and drills drawn with the draw-hoe 28 inches apart, 4 to 5 inches deep. The sets are put in 15 inches apart. The drills are again filled, and between them the soil is lifted up again with the fork to keep it open, so that rain can pass quickly through.—WILLIAM HUBBARD, *Bellarena.*

LONGFORD.—1. From the 15th of February to 1st of March. Royal Ashleaf Kidney, *Carter's First-crop Kidney. Soil.—Heavy clay, resting on a hard retentive pan of yellow clay. We cannot work it until the time of planting approaches; if worked earlier will contain double the amount of water during the winter. 2. From the 1st of March to the 15th. Porter's Excelsior, Grampian, *Flounders. Soil.—Depth of garden and field soil about 24 inches, by trenching and carting soil on to the garden it has been raised to 30 inches. 3. From 25th of March to 20th of April. *Champion, Down, Skerry Blues. Soil.—I find from thirty years' experience that the only chance of a good yield of a crop of Potatoes is the lea sod turned into ridges or lazy beds, alleys dug and shovelled, good decayed stable manure placed on at the time of setting. On almost all soils I have scarcely seen a failure for the first and second crops, but the second must not be manured unless a little Potato manure (artificial) at the second moulding. Manures and Application.—For garden crops of Potatoes we use no manure. We generally set them on ground occupied by Carrots or Parsnips the previous year, in drills 24 inches apart by 12 in the lines. We always get a good crop with the varieties named. I consider it a great waste of money and labour to grow so many varieties as are now in cultivation.—JOHN RAFFERTY, *The Gardens, Castle Forbes.*

LOUTH.—1. The end of February or early in March. *Flounders, Ash-leaved Kidney, *American Early Rose, and Snowflake. Soil.—Light warm soil. 2. Beginning of March. Scotch Kemp. Soil.—Heavy clay soil. 3. From the middle to the end of March. *Scotch Champion, *Magnum Bonum, Paterson's Victoria, and Brown Rocks. Manures and Application.—For early Potatoes I

generally use stable manure, and for the later kinds sea sand. I seldom employ any stable manure for late kinds, the ground being rich and the soil heavy. They are not so liable to disease on the sea sand as on manure. General Culture.—I generally plant Potatoes in drills 28 inches apart, and 10 to 12 inches between the sets. When the Potatoes begin to appear the soil is dug between them with the spade, and when they are fit they are earthed with the spade as high as possible.—EDWARD DONNAN, *The Castle Gardens, Castle Bellingham.*

MEATH.—1. Beginning of February if possible. Dwarf Ashleaf, named Temple's Incomparable, Lapstone Kidney, and Myatt's Prolific. 2. March. Schoolmaster and Prince Arthur. 3. End of March. Scotch Champion. Soil.—Medium; subsoil, yellow clay. Manures and Application.—If I use any manure in planting Potatoes it is ordinary stable manure, which is spread and dug in. I think most garden soil is rich enough for Potatoes. I prefer a dressing of lime. Champion Potatoes keep well grown here; they do not turn black as soon as in some places. General Culture.—Kidney varieties are carefully stored in one layer on shelves in autumn. Every set has one good bud when planted, which are mostly planted in drills made with a hoe about 5 inches deep. Temple's Incomparable is ten days earlier than any I have tried, including the two named, also Veitch's Ashleaf, and Rivers' Royal Ashleaf.—SAMUEL TAYLOR, *Loughcrew Gardens, Oldcastle.*

SLIGO.—1. February 20th. Old Ashleaf, *Rivers' Royal Ashleaf, and Flounder. Soil.—Medium. 2. In or about March 1st. Taylor's Fortyfold, *Magnum Bonum, and Reading Abbey. 3. March 20th. *Scotch Champion, White Rock or Scotch Downs, Red Rock, and *Schoolmaster. Soil.—Strong loam. Manures and Application.—Farmyard manure and a little guano are employed, farmyard manure being put in the drill rows at the time of planting. General Culture.—We generally plough the land before Christmas and leave it in a rough state until March. If the weather permits we harrow it and open drills, placing in the manure and Potatoes at the same time.—JOHN BARBER, *Hazlewood.*

TIPPERARY.—1. First week in March or last in February, depending on soil. Myatt's Ashleaf, Beauty of Hebron, Early Rose, and Snowflake. Soil.—For first earlies the soil should be light, friable, and loamy, with a southern aspect, and, if possible, with a wall or other protection behind. I am, however, in hope that Beauty of Hebron may yet become a field Potato. Early Rose is of comparative inferior quality, but a heavy cropper. Ashleaf is the best for frame culture. 2. Second or third week of March, dependent on weather. White Elephant, Fortyfold, Holborn Favourite, and Bresce's Perless. 3. End of March to end of April. Scotch Champion, Magnum Bonum, Skerry Blue, and White Rock. Manures and Application.—For first earlies I prefer stable manure not much decayed, for the second the same more decayed and mixed with cow or pig manure. For the general crop and, in the absence of the above, for any crop, I take well-mixed and decomposed farmyard manure. With 66 inches of rainfall I do not believe manuring in autumn would be beneficial. For quality, productiveness, and adaptability under the greatest variety of soil and circumstances, in Ireland Champion unquestionably stands first; but be it observed only until the end of March, after that it is practically unfit for table use. In this respect it must give place to Magnum Bonum. My practice has been to grow those two for general purposes, consuming the former first. Change of seed, early planting, plenty of room to grow, good warm soil, well drained, and well manured, are the specifics of certain success.—WILLIAM J. MURPHY, *Western Road, Clonmel.*

TYRONE.—1. March. Ashleaf. Soil.—Light; gravel subsoil. 2. Beginning of April. Dalmahoy. 3. End of April. Champion. Manures and Application.—Stable and cowshed manure applied at time of planting.—A. DICKSON, *Baronscourt.*

WATERFORD.—1. January to end of February. Rivers' Royal Ashleaf, *Myatt's Ashleaf, Veitch's Improved, and *Early Bird. Soil.—Heavy clay soil. 2. March or April. *Covent Garden Perfection, Woodstock, *Early Vermont, and Prince Arthur. 3. April to end of May. Grampian, Schoolmaster, *Paterson's Victoria, and *Scotch Champion. Manures and Application.—Farmyard manure, drills opened, manure put in the bottom, Potato sets put on the top, afterwards earthed-up in the usual way. General Culture.—I have found out of some fifty varieties those I have named are the best. I may add, for latest of all the Magnum Bonum is fit for use when all the other old Potatoes are almost useless.—JOSEPH THOS. MULLIS, *Lismore Castle.*

WICKLOW.—1. Last week in February to first week in March. Rivers' Royal Ashleaf, *Gloucester Kidney, Myatt's Kidney, and Early Rose. Soil.—Sandy loam on a gravelly subsoil. 2. Middle to end of March. *Flounder, Snowflake, Dalmahoy, and Redbog. 3. First week in April. *Champion, Magnum Bonum, and Paterson's Victoria. Manures and Application.—Farmyard manure, applied the year previous. General Culture.—I choose for Potatoes ground that

has borne a crop of Peas, Cauliflowers, and Cabbages. It is deeply dug and left rough during the winter. Before planting it is forked over, no manure of any kind applied; I then with an ordinary garden drawhoe make rows about 3 inches deep, and from 20 to 30 inches between the rows, according to varieties and strength of tops. The sets are planted from 8 inches to a foot apart; with the drawhoe the soil is drawn from each side to form a ridge, covering to the depth of 6 inches. Before they come through the ground about 2 inches are raked off the top of the ridge. The after-treatment is forking between the rows and finally earthing-up. By this treatment I get good crops of first-rate quality, with comparatively little disease. As proof of this, Champions are preferred for table to any variety, grown on fresh soil in the farm, being free of the black streaks characteristic of that variety.—G. H. McCULLOCH, *Powerscourt Gardens*.

CHANNEL ISLANDS.

JERSEY.—1. February or the end of January. *Myatt's Prolific, *Rivers' Royal Ashleaf, Gloucester Kidney, and *Early Snowflake. Soil.—Light, good stable manure being employed. 2. Last week in February. Bresee's Climax, American Kidney, Ashtop Fluke, and Improved Schoolmaster. 3. First week in March. Paterson's Victoria, Improved Magnum Bonum, The Queen, and Late Fluke. General Culture.—I have cultivated those mentioned, and I find them all that can be desired.—JOHN WILLIAMS, 53, *Trinity Road, St. Helier's, Jersey*.

EARTH TEMPERATURES.

CONTINUING this subject from page 291, the object at present is not to teach what degree of earth heat this or that plant is benefited by, but rather to direct attention to the principles that ought to guide the cultivator in the application of bottom heat. Were the object merely to teach the degree of heat required by Melons, Pines, Cucumbers, and other plants to which artificial bottom heat is applied, the space at our disposal would be wholly filled up with facts and figures to be found in every book treating on such subjects as we have named, and in every calendar of gardening operations. Our purpose is different, and is rather to show to what an extent bottom heat might be utilised, and the principles that ought to guide us in our application of it.

Apart from such plants as those named, which are natives of tropical climes where the earth heat ranges high, and which we are all agreed are benefited by high, artificially raised, earth temperatures, there are many others grown at unnatural seasons—in other words forced—that also need bottom heat in order to do them justice.

Not very long ago some gardeners denied the utility of bottom heat for plants treated at midwinter to midsummer heat. Vines were said not to require it. This need hardly be discussed. Failures have often occurred by men trying to force tops and allowing bottoms to remain dormant; and were gardening failures recorded as faithfully as gardening successes, the black list would be so appalling as to effectually frighten young practitioners from doing things upside down—from reversing natural operations.

Our most successful gardeners maintain the necessity of raising the soil heat as the air is raised. This is only natural, and Nature is generally a safe guide to follow. Nature and successful men are thus far agreed.

The best manner of applying this heat is not, seemingly, agreed upon. Many consider that when the roots of early Vines are confined to inside borders no further trouble is needed to secure a high-enough earth temperature. When the roots are near the surface, as they should be, those who hold such views are doubtless right, especially when soakings of warm water are applied and a dry surface maintained, for, it should be remembered, a wet surface means evaporation, and evaporation cold. Others, again, build hotbeds inside, which assist to start the Vines by warming the air, and also to keep up a steady moisture; but the heat thus imparted to the border is much less than is generally thought to be the case. Those who have tested the matter in the only satisfactory way—by inserting a thermometer, know this to be so. Applied to outside borders, otherwise drenched with melted snows and ice-cold rains, hotbeds will do much to impart bottom heat to the outside roots; but they exclude air and turn the soil to a puddle inert mass, which is not favourable to the production of roots of the best character. Dry sun heat secures a circulation of air in the soil, and this air produces change of a beneficent nature. Hotbeds have an effect quite the opposite, and are, therefore, an evil, if the least of two, as they undoubtedly are when the choice lies between borders windswept and soddened down to a minimum British winter temperature, while the tops are treated to a French or even Italian summer heat and hotbeds. Still hotbeds are by no means faultless. We leave outside of the question the amount of labour their management involves, and their untidiness, and only

discuss their fitness for securing the conditions for which they are employed.

Bottom heat for fruit borders is frequently secured by another method. By coverings of non-conducting material the heat stored during the previous summer and autumn is preserved. Although recommended by the best of gardeners, including one we all look up to—Mr. Thomson, Drumlanrig—it may be questioned whether the plan is so good as seems at first sight. The experiment already quoted proves the possibility of preserving the heat; but, as the proof of the pudding is in the eating, nothing but long successful experience could make us certain that bottom heat during the resting period is not harmful. Vine roots under natural conditions, and others as well, remain dormant till the leaves are matured enough to carry on the functions of leaves; then the leaves begin to act, and then new roots are formed. All growth before this is at the expense of the material stored in the stems the previous autumn. Out of this the newly formed leaves and shoots are formed, but by giving bottom heat enough the roots may be made to move first—nay, they may be made grow considerably before the buds move, as anyone possessing a pot Vine may prove. This is unnatural, and, we are convinced, mischievous. The shoots of Vines so treated have a smaller store to fall back upon than have those which get their fill before, metaphorically, the roots help themselves. Now, roots in soil, the heat of which has never been allowed to decline, are kept abnormally active. They are deprived of their winter's rest, at least to some extent.

Bottom heat is supplied to Vines by pipes. These are generally covered by flagstones, on which rests the drainage. That, when properly managed, heat thus applied has proved of real benefit is beyond question, but it is not uncommon to see such arrangements taken to pieces after a few years' trial. Heat thus applied has a tendency to cause an excessive dryness exactly where the best roots are, for these travel towards the heat. Even floodings often fail to wet soil once thoroughly parched, and this parching is liable to occur even in good hands. The consequences are shanking, stunted Vines, poor crops. Given the requisite skill and attention, there is no reason why heat applied from below to Vines should not succeed as well as when applied to Melons. Theoretically that is how the case stands. Practically gardeners find it cheaper and more satisfactory to have inside borders only for the very earliest house, and these, when a pit exists for forcing pot Vines, are from one to two months later than was the case only a dozen years ago.

But for the expense, there can be little doubt that the best way to warm outside borders in winter would be to cover them with glazed sashes and to maintain a summer temperature over the border by hot-water pipes. Most persons who have forked over an inside border must have remarked how the roots cluster near the surface in the vicinity of the hot-water pipes. Such a fact proves that heat by heated air from above is not only most natural but most efficacious. Nor need the heat of such a frame be wholly devoted to warming the border. Such a place would prove of more than usual value for forcing many things, especially salads, during winter.

Before the invention of heating by hot water, flues were occasionally employed for producing bottom heat. But flues are now nearly obsolete, and would not have been named here but for the fact that there is an idea abroad among unpractical men that economy is observed by carrying the flue used for conveying the smoke from the boiler fire underneath earth beds for growing Melons, Cucumbers, and other crops, in order to get bottom heat for nothing, as is believed. The first objection to such a practice is, that it necessitates deeper stokeholes than would otherwise be necessary. The second is that one end of a flue is hot and the other cold, when of any considerable length. But, worst of all, it is impossible to regulate the bottom heat by such means. When the flues are newly cleaned the heat is too high, when foul too low. On bright days there is no bottom heat, for the fire is allowed to go out. The sun which warms the air indirectly cools the soil. We only know of one such modern erection, and our faith in the wide dissemination of common sense leads us to believe that not many such arrangements exist, but that one is such a failure, and such a waste of labour and capital, as leads us to warn others against adopting the seemingly good theory in their practice.

Bottom heat is of great service in the propagation of plants. This in modern well-appointed pits is supplied by hot water; but well-appointed propagating pits are the luxury of the comparatively few. To the mass many makeshifts have to be resorted to. One we may mention. A sheet of iron placed over hot-water pipes in any early vinery or elsewhere, on which is placed a handlight and a few inches of wet sand, will prove a capital little

propagating frame. Inside a common greenhouse or larger frame, or even no frame at all, the little lamp-warmed frames are of much help to the grower with few wants and inadequate appliances. But a good dung frame is still one of the best propagating appliances. On the management of such room cannot be spared here. But it may serve some good purpose to say here that a mixture of leaves and frequently turned stable litter, so universally recommended and so un-come-at-able by thousands, is not at all necessary for the making of a thoroughly satisfactory hotbed. Tan, which is a waste product, is quite as good as leaves, and a bed made of half stable litter, half tan, will last good for months. Failing tan, half-decayed manure will answer very well. Stableyard litter alone in a fresh state is quite unsuitable—it heats too violently.

A half-spent hotbed affords an amount of bottom heat that is better for the propagation of many things than a new one. On such many hardwooded plants may be rooted that would be excited too much in a warm bed. On an old hotbed under a close frame Rose cuttings of firm wood strike readily in July and August.

The "Pob," already mentioned, when thoroughly moistened gives out a very gentle heat, which lasts for months during winter. Cuttings of a large number of coniferous plants, inserted in pots and plunged in this under a frame from which frost is excluded, will callus and root when they will refuse to do so either without bottom heat or when treated to what is generally considered bottom heat, but is too exciting. It is said that soap waste makes a good and lasting hotbed.

Bottom heat stimulates by the warmth it supplies. It does more. Much of the ordinary manurial matter applied to plants is not available for plant-food till changed. Warmth hastens this. Nothing stimulates rapid growth like nitrates. These form in all soils whenever alkaline bases exist alongside of nitrogenous matter. But when the soil is cold the process proceeds very slowly, when frozen not at all. But the change proceeds very rapidly where there is a bottom heat of from 75° to 90°. It is doubtful if ammonia, or even urea, can be directly utilised by plants. But these substances in a moist fertile soil begin to change as soon as they are fixed; so that what to-day may be regarded as a mineral substance and not fitted for plant food, may, when the soil is warm, be converted by an invisible bacterium into plant food, and by the plant into plant-tissue or starch or sugar by this time to-morrow. Wonderful are the operations of Nature and well worth finding out.

Space has prevented us doing more than merely skimming the surface of a subject that we advise our readers, and especially the younger of them, to dip into deeply. We have touched on all the salient points that have occurred to us, and although much more might be written on it—perhaps with profit—the object we had in view will be served if it directs the attention of our readers to a phase of gardening practice too much neglected. By shelter we may protect our plants from the bellowing blast; we may raise the temperature by raising walls that warm the air by taking in the heat from the sun and giving it to the air; and all this we have endeavoured to do, and then made the most of it. It is doubtful if, to an equal extent, we have utilised earth heat.—SINGLE-HANDED.



FRUIT-FORCING.

Vines.—The inside borders in early houses where the Grapes are taking their last swelling must be given sufficient water to keep the soil in a healthy growing state until after the fruit is cut, applying the water early in the day, and adding a little fresh mulching to keep the surface of the borders moist. Keep up a circulation of warm air, but avoid currents of cold air, allowing the temperature to rise to 85° with sun heat and proportionate ventilation, gradually reducing it in the afternoon; and if the Vines are carrying a full crop and there is any doubt about perfection in colour and finish, let the night temperature range low or fall to 60°, so as to rest the Vines. If red spider appear coat the hot-water pipes thinly with sulphur and skim milk; but be careful not to overdo this, as all the white thin-skinned varieties, such as White Frontignan, Sweetwater, and Muscat of Alexandria, are sometimes injured, the skin being turned of a blue hue, which turns to brown, and the berries not unfrequently crack. If mulch-

ing, or, rather, fermenting materials on outside borders has become cold, a portion of the heaviest should be removed, leaving some of the longest as a protection for the surface roots and to prevent the borders becoming dry.

In succession houses due attention must be given to stopping, tying, and regulating the growth, the removal of superfluous shoots and bunches. Muscats in flower should have a high range of temperature by day; 80° to 85° or 90° is not too much when external conditions are favourable, allow it to fall to 70°, or even lower, at night with a little air. Dust the bunches with a large camel's-hair brush when the air is dry, as it will be with the sun shining and air circulating, and keep the points of the bunches turned up to the light. When crops of fruit are swelling give air early in the day with fire heat, allowing an advance to 80° or 85°, closing at 3 P.M. or earlier, according to the weather, with plenty of atmospheric moisture obtained by damping available surfaces thoroughly with water or weak liquid manure. Allow the laterals to extend, but guard against overcrowding, it being important that the foliage have full exposure to light. Examine inside borders, and water freely with tepid liquid manure. If the borders are well drained they cannot receive too much water when the Vines are in active growth. Take advantage of every gleam of sun in the management of late houses, ventilating early with fire heat, rising to 80° or 85°, and close early, or about 3 P.M. with plenty of moisture, when the fire heat may be shut off until the temperature falls to 65°, when it should again be turned on, but only to prevent the night temperature from falling below 60°, or on cold nights to 55°.

Newly planted Vines should be kept close and moist until they are growing freely, when they should be induced to make short-jointed wood by judicious ventilation and full exposure to light, encouraging growth by early closing, keeping the surface of the borders regularly moist.

Cucumbers.—Old plants which have been in bearing since November will now begin to bear an untidy appearance, and the chances are they will not be free from red spider. In this case, and the house being divided into compartments, this part or section should be cleared of its occupants, all soil removed, the glass, woodwork, and walls thoroughly cleaned, and fresh hillocks or ridges formed for the reception of vigorous young plants, which will come into bearing quickly and give more satisfactory results. The soil should be somewhat heavier and firmer than is advisable for winter fruiters, and secure bottom heat from fermenting materials in preference to hot-water pipes. If old plants must be retained crop them lightly, supply tepid liquid manure, top-dressing with good loam, and syringe copiously. Remove exhausted growths and bad foliage, laying in fresh so as to keep up a succession of bearing wood. Shade no more than is necessary to prevent scorching. Plants in pits and frames will now be in bearing, and will need to be stopped and have the growth regulated, keeping the foliage thin and clear of the glass. Ventilate freely early in the day, and close about 3 P.M., with plenty of moisture. In renovating the linings rank steam is apt to be troublesome; injury, therefore, should be guarded against by leaving a little air on at night. Glasses should be used to keep the fruit clean and straight.

HARDY FRUIT GARDEN.

Very little harm has happened so far to the blossom in the south, notwithstanding the frequent prevalence of cold east wind and the heavy fall of snow on the 23rd and 24th ult. Pears and Cherries fully exposed have suffered slightly, but it is surprising how few blackened pistils there are, most of the abundant flowers having all the organs unscathed, except some battered petals on the most forward. Only a few Plums have open flowers yet, and no Apples are in bloom, so that we may still hope for the full crop of fruit of which the swelling buds give such fair promise. Every means of protection must now be turned to account to ward off any sudden frost or bitter wind. Have such means at hand, but do not cover the trees without real necessity arises; rather expose the blossom fully to every breeze that blows except strong north-eastern gales. That the north wind is seldom hurtful is proved by the full crop of fruit generally produced by trees on walls and fences facing due north, it is the bitter nor'-easter which does the mischief.

Peaches and Nectarines.—Do no disbudding till the fruit is set and fast swelling. Every breast shoot is a protection to the fruit and side shoots, and the recent cold wind has already blistered many of them; far better is it to retain every shoot till it is 6 or 8 inches long than to remove one of them while cold unsettled weather prevails. There need be no fear of exhaustion or weakening the system of robust healthy trees, and a sickly or delicate tree ought not to be suffered to bear fruit. Most of the trees appear to be setting a good crop of fruit; watch them closely, for

many a useful lesson may now be learnt. Blossom of Peaches and Nectarines that will not set fruit often shrivels and disappears so quickly and entirely that a careless observer may fancy there has been none when there has been plenty. Lord Napier Nectarine is so losing almost every flower this year, while Balgowan and Violette Hâtive close to it in the same aspect are setting a full crop of fruit.

Trees which have been grafted must have all shoots removed as they appear below the scion, and where clay has been used it should be moistened if cracks appear, and the cracks promptly closed. Watch the progress of the scion growth, and remove the binding material as soon as you have clear evidence that stock and scion are united, and fasten the scion to some suitable support to prevent its being blown out by wind.

We are about to plant a bed of Alpine Strawberries for autumn fruiting upon a border of rich soil that has been recently dug. Strong plants will be used a foot apart, and careful attention will be given to watering should dry weather follow the planting; and after they are established a slight mulching of rough leaf soil will be put among them to keep out drought in the hottest summer months.

THE FLOWER GARDEN AND PLEASURE GROUND.

Sowing Annuals in the Open Borders.—Ground that was roughly dug during the winter will now, thanks to the most acceptable rain, be in excellent condition for seed-sowing. Much depends upon the state of the ground. Many of the seeds being small—the seedlings forming very delicate roots—require to be sown on well-broken-up soil, and to be lightly covered with more of the fine soil. It is not advisable to bring to the surface any bad working soil; forks, therefore, should be used to thoroughly reduce the spits of soil to a suitable condition for sowing. Ground that has not been for some time exposed to the pulverising influences of frosts, winds, and rain should be broken up as finely as possible; and in many cases it will be found advisable to surface it with sifted soil from the compost yard, and to cover the seeds with more of the same kind. Where the plants are or can be grown in lines the seeds should be sown in drills, as this admits of hoeings late on. As the majority of annuals are grown on mixed borders, the seeds in this case should be sown in patches about 10 inches across, hollows being formed with the hand, the seed to be lightly covered with soil and marked with a peg. A few plants in every instance will prove more satisfactory than the crowded patches too often to be seen. Therefore sow thinly; and before they become crowded, and when too large to be preyed upon by slugs, freely thin out the seedlings, transplanting some of these to where blanks occur.

Mignonette, Love-lies-bleeding, Candytuft, Godetias, Eschscholtzias, Chrysanthemums, Scabious, Enotheras, Senecio, Marigolds, Clarkias, Calliopsis, Helichrysums, Poppies, Saponarias, and other hardy and half-hardy annuals all branch freely, and if grown thinly will continue to produce superior blooms much longer than where crowded. In addition to the above, Sweet Peas, Collinsias, Hibiscuses, Larkspurs, Limnanthes, Clintonia, Malope, Nemophilas, Salpiglossis, Virginian Stocks, Tropæolums, Convolvulus, Scarlet Runner Beans, and other popular kinds should now be sown. Slugs being so very destructive among the delicate seedlings, traps should be set for them at once. They will congregate under hollowed-out Potatoes, in little heaps of bran, under slates and tiles or Cabbage leaves, and should be collected and destroyed every morning. We do not venture to sow extra choice varieties of any of the above annuals in the open ground, preferring to sow thinly in boxes of fine soil, and these being stood in a warm open position, covered with glass or otherwise protected and darkened, germinate readily. They are planted out in most cases when about 2 or 3 inches high. African and French Marigolds, Tagetes, Asters, Stocks, Zinnias, Everlastings, choice Poppies, and ornamental Grasses may yet be sown under glass, either in boxes or on beds of fine soil, and will quickly grow to a good size for planting out. The same remarks apply to Ricinuses and Japanese Maize, using 5-inch pots for the former and a smaller size for the latter. Both will be found highly ornamental, and if disposed among smaller kinds of bedding plants will tend to cke out the latter where scarce.

Propagating and Treatment of Bedding Plants.—Alternanthera cuttings are now very plentiful, and we contrive to strike the requisite number of plants at one time. A shallow hotbed for several frames is formed, over this being disposed about 3 inches of fine sandy soil. The cuttings are dibbled in about 2 inches apart each way, are watered in, and the frames kept close and shaded when necessary till the cuttings are rooted, which they quickly are. The plants are encouraged to grow rapidly, and early in June they meet all round, and are hardened and planted out before the end of the month. Where smaller quantities are

required they may be struck thickly in boxes, placed in a brisk heat, and transplanted in other boxes when many of the hardier kinds are shifted into cooler quarters. Shallow boxes are best for Alternantheras. Where the stock is still too small Verbenas, Ageratums, Heliotropes, Iresines, Coleuses, Mesembryanthemums, Koniga, and Pelargoniums may yet be struck, and Lobelias divided. Calceolarias, Lobelias, Ageratums, Verbenas, Gazanias, Pyrethrums, Marguerites, if bedded out rather thickly in rough protected frames, and in good soil resting on a hard bottom, will form strong plants, which may easily be transplanted with a good ball of soil attached to the roots at bedding-out time. Pelargoniums do not move so well, but we find spring-struck cuttings do well under this treatment. The boxes thus liberated are available for Iresines and Coleuses, and these do not require a great depth of soil. Mesembryanthemums are best potted singly in 2-inch pots.

THE BEE-KEEPER.

THE ART OF BEE-KEEPING.—No. 10.

(Continued from page 286.)

THE ART OF SUPERING.

DOING the right thing at the right time is the key to success in bee-keeping as in other pursuits. This is specially true when we come to require the use of supers. Several conditions must be conjointly favourable before any success can be depended on. In the first place the hive must have a crowded population, and in the second place there must be abundance of honey in the flowers and suitable weather in which to gather it. The former condition may frequently be reached weeks before the latter can be expected. For example, in a district where Clover blooming about the 15th June is known to be the main source of honey, hives may be ready for swarming before the end of May. In such cases it will generally be found the wiser course to divide by artificial swarming, and by the liberal use of comb foundation have both the old and young stocks still fit for supering before the Clover harvest opens; otherwise, there will be some difficulty in preventing swarming at a later date, and supers put on prematurely will be often found to be spoiled by brood.

Should the favourable condition as to population not be reached till nearer the time of the honey flow, a super may be placed on the hive after an inspection of the brood combs. Should royal cells be found on the latter they should all be removed. The addition of the super will at once relieve the sense of overcrowding, and give the bees useful employment in drawing out the guides of foundation with which the super is supposed to be furnished. To rouse the bees to activity, and almost compel them at once to enter the super, every inch of sealed honey in the brood combs should also be uncapped. This will further afford the queen additional space for egg-laying in the body of the hive.

Should the flow of honey arrive before the stock is strong enough for supering great care must be exercised. The addition of a super in such a case may go far to hinder the desired condition, and prove the adage "the more hurry the worse speed;" for it will tend to cool the brood nest, contract the cluster, and compel more bees to stay at home for nursing purposes. The tendency would then be towards filling up the brood combs with honey to the subsequent curtailment of brood-rearing. Such a stock might thus be thrown so far back as not to enter the supers till the short honey season was almost gone. In such circumstances the advantages of the bar-frame system come to our help. We should at once proceed to strengthen the stock in question by giving it frames of hatching brood from other stocks able to spare them, or even from stocks weaker than itself, though of course we should leave the latter as mere nuclei not to be supered. Or, if we have no other stock from which to draw supplies of brood, we should contract the brood nest of the stock in question sufficiently to crowd the bees into a small super—say of a single row of sections. In a few days more room may gradually be given both in the brood nest and supers. Indeed, where increase of stocks is no object we should rather join all our hives two and two than lose the chance of getting supers during the short honey season.

The happy sight of enormous populations now at last eagerly storing their gatherings in tiers of supers may now be reasonably supposed to gladden the bee-keeper's heart. But a new source of trouble arises. The very excess of population he lately longed for threatens to mar his hopes by developing the instinct for swarming. To prevent this, at least for a time, is now his great concern. To

this end he takes care to prevent any sense of overcrowding by affording ample doorway, even to the whole length of the front of the hive, and watches carefully through the glass of the first super for the first sign of overcrowding there. When this is observed a second tier is at once placed on the top of the first. In some seasons so rapidly do the supers become overcrowded, that as many as four or five tiers may have to be added before the first is fit to be removed.

A question much discussed arises here. Should we place the second and successive tiers under or over the first? After a fair trial of both methods for several years we have reached this result. By placing the empty tier below that partly filled, we, as it were, compel the bees suddenly to occupy more room, and thus lessen the risk of immediate swarming; but we at the same time hinder the completion of the first tier. And if perchance the queen has already deposited eggs in the first tier, we almost insure that the whole series below will be more or less spoiled from the same cause. By placing the latest addition on the top of the others we, especially in a season of moderate yield, insure a greater proportion of sections properly finished, owing to the well-known instinct the bees have for storing in gradually expanding circles from the brood nest as a centre. We likewise diminish the tendency to brood-rearing in the supers, as the queen will seldom travel over sealed combs in search of empty cells.

On the other hand, with each successive tier, we increase the difficulty of removing the first as soon as it is finished; and removed it must be if we are to preserve the purity of its colour and the thinness of its sealing. All things considered, we nevertheless prefer this latter plan, especially as we are often compelled at any rate to remove the whole pile of supers from time to time for the purpose of cutting out royal cells, or to satisfy ourselves that the queen has plenty of room for egg-laying.

Weak hives, especially in poor seasons, may never be fit to occupy even a second tier of supers. In such cases we give more room only by substituting empty sections for such as we may find completed. In performing this operation we invariably close up those partly finished towards the centre, and insert the new ones on the outsides.

By drawing on records of former experience, as supposed to be noted in our local calendar, we become warned of the near approach of the close of the honey harvest of the locality, be it fruit bloom, Clover, Lime, or Heather. And now our concern is to have as few sections as possible left unfinished. We therefore cease to give more storage room. As in the later harvests there is generally a diminishing population and but little risk of swarming, we rather contract space all we can by the removal of all finished sections, and by gathering those nearest completion as close to the brood nest as possible, covering all warmly.

Glass supers should be kept warmly covered all the time they are on the hives. Sectional supers should have no more covering in hot weather than a single thickness of carpet laid on the top to confine the bees. This, with the numerous joints between the sections, will give all the ventilation necessary. But in cool weather, especially at the beginning and end of the honey season, an additional covering of some soft material should be wrapped round the whole pile, which should also be kept dark and well shaded from the sun.

To Get Bees out of Supers.—There is but little difficulty in clearing the bees out of sectional supers. A good volume of smoke blown down between the sections before removing them from the hive will drive most of the bees below. The whole case is then lifted to a side, and the remaining bees dislodged by taking each section in the hand, giving it a smart shake in front of the hive, and immediately whisking off any straggler with a feather. Should robbers threaten trouble, as they will only do when honey is scarce, the whole case may be treated as we would a single box or glass super, the best arrangement for which we find to be as follows:—Get a box with close-fitting lid large enough to hold the largest super easily. Lay a couple of small slats in the bottom on which to rest the edges of the supers, and cut a hole about 3 inches square in one side. Tack three fillets of wood $\frac{3}{8}$ -inch square round the outside of this hole so as to form a ground for a piece of fine wire cloth. Let the side fillets and the wire cloth be long enough to reach several inches above the opening. This will form a trap allowing the bees inside to escape by running up the wire cloth, while the robbers from without will expend their energies only in endeavouring to get through the wire cloth in front of the hole. An occasional puff of smoke into the box will hasten the exodus.

At the close of the honey season unfinished sections may either be broken up, emptied by the extractor, or simply uncapped and left on the hive till the bees carry down the contents, after which all should be stored away in a dry clean place for use next season.—
WILLIAM RAITT, *Blairgowrie*.

TRADE CATALOGUES RECEIVED.

William Montgomery, Cardross, Dumbartonshire.—*Catalogue of Roses, Pansies, and Florists' Flowers.*

W. Clibran & Son, Altrincham, Cheshire.—*Catalogue of New and Choice Plants.*



* * All correspondence should be directed either to "The Editor" or to "The Publisher." Letters addressed to Dr. Hogg or members of the staff often remain unopened unavoidably. We request that no one will write privately to any of our correspondents, as doing so subjects them to unjustifiable trouble and expense.

Correspondents should not mix up on the same sheet questions relating to Gardening and those on Poultry and Bee subjects, and should never send more than two or three questions at once. All articles intended for insertion should be written on one side of the paper only. We cannot reply to questions through the post, and we do not undertake to return rejected communications.

Dahlias (*J. Mason*).—As you do not indicate the number you require you cannot err by choosing from the list in another column, where you will find some of the best varieties grouped under their prevailing colours.

Leakage in Hot-water Pipes (*A Constant Reader*).—Red and white lead mixed with linseed oil is good material for stopping leakages in joints. An iron cement can also be obtained at ironmongers suitable for the same purpose. A composition of 4 lbs. iron borings, 2 lbs. pipeclay, 1 lb. powdered potsherds made into a paste with strong brine is also an excellent cement.

Orchid Flower (*G. C.*).—The flower you sent is *Miltonia flavescens*, a rather uncommon species, but one of comparatively little beauty. The insect which attacks your plants is *Otiorynchus sulcatus*, and the only means of destroying it is by carefully watching for the insects. Pots filled loosely with moss and laid on their sides will often prove a harbour for them, and they can then be readily destroyed.

Primula scotica (*A. M.*).—Although judging by the fragmentary leaves and flowers you sent, we thought your plant was *P. scotica*, and referred to it as such, our engraving was not prepared from the specimen you submitted, but represents a garden form of *P. scotica* very vigorously grown. Now you have sent better examples we have no doubt that your plant is a richly coloured form of *P. villosa*. The Oxlip sent is the Bardfield, *Primula elatior*.

Young v. Old Coleuses (*J. P.*).—As a rule young plants are far more satisfactory than old ones, as they produce finer foliage, and can be grown to a large size during the season. If very large specimens are coveted then old plants can be grown a second year, but the majority of them occupy more space than they are worth, as it is very seldom indeed that they produce large handsome leaves. Your gardener has adopted the usual practice, and in all probability the best for your purpose. The injury to the Pear blossoms is the result of frost. See our reply to "F. S." on page 351 last week.

Rhododendron (*E. Sendall*).—We have received the truss of flowers you sent. It is a very beautiful variety, resembling *R. Dalhousiae*, and will be referred to again. Are you sure there has been no mistake in the parentage? Had you any other species flowering than the two named? It is strange that a variety so totally distinct from both alleged parents should be produced. We shall be glad to have further particulars on the subject at your early convenience.

Arranging a Conservatory (*Amateur, Hull*).—It is impossible for anyone to answer your letter with any degree of satisfaction in the absence of the requisite data for enabling the character of the house to be understood. You do not even mention the width of the structure. If you send us a plan of the house drawn to scale, showing the exact position of the doors, hot-water pipes, &c., we may perhaps be able to suggest a mode of arranging the stages. Without some particulars of the nature indicated your question is unanswerable.

Tomatoes Diseased (*W. H., Surrey*).—We have carefully examined the fruit, and think the injury is the result of excessive applications of liquid manure, while at the same time the fertilisation of many of the flowers was certainly defective. In consequence of this the fruit would not swell freely, and the liquid stimulants has found expression in luxuriant foliage and diseased fruit. Your present crop cannot be relied on, and as you have other strong plants we should at once destroy those affected and occupy the space with healthy stock.

Salvias for Winter (*Luard*).—There are many *Salvias* of great value for winter and spring decoration, such as *S. splendens* and its variety *Bruanti*, *S. Betheli*, the pretty blue *S. Pitcheri*, and the strong-growing and effective *S. gesneriflora*. All are readily raised from cuttings inserted at the present time in sandy soil in a close warm frame. After being potted singly the plants require to be kept close for a time until established, then they cannot have too much light and air. If large luxuriant plants are desired, the strong-growing kinds may be planted out in a sheltered position towards the end of June, and be taken up and potted in September. They require generous soil and an abundance of water during the summer months.

Auricula Douglas's Conservative (*E. E., Dalston*).—You "wonder why this variety was not certificated last week." The reason is, we assume, because it was certificated at the National Auricula Society's Southern Show three years ago. It is undoubtedly a very fine flower, and an acquisition to the section to which it belongs. You ask "what fault" it has. To this we must reply that in our view its weakest point, and this only a slight weakness, appeared to us to be a slight lack of density in the mealiness of the edge. This,

no doubt, will be variable, according to seasons and culture, and we do not hesitate saying it is one of the very finest white-edged flowers in cultivation.

Vine Culture (H. S.).—We are glad our advice has proved so serviceable to you, and we are not surprised that you have found the works of Mr. Barron and Mr. Taylor useful. No one seeking information on Vine culture could fail to profit by the sound teaching in those volumes. We scarcely understand your question relative to estimating the weights of bunches of Grapes. Do you mean the sizes of the bunches when ripe, or, say, immediately after they are thinned? On this matter very much depends on the way in which the bunches are thinned. We have known bunches of Black Hamburgs 6 or 7 inches long and 4 to 5 inches across the shoulders weigh a pound when the fruit was ripe, and we have known others half as large again no heavier, the difference being that in one case the interior of the bunch was crowded with berries, and in the other there were no berries that were not plainly visible, few being left in the centre of the clusters. Those persons who wish to make a great display without overtopping the vines adopt the latter practice, and the crop to a casual observer appears much heavier than it is. Try both practices and weigh the fruit; you will then better comprehend the matter than it is possible for you to do at present. As to your other question, you cannot do better than write to Mr. Pettigrew, Bowdon, Cheshire.

Chrysanthemums (Excelstor).—The time for placing plants outdoors can only be satisfactorily determined by their condition and the state of the weather. They should never be stood in the open air until they have been fully exposed for a time night and day by the removal of the lights from the frame; at the same time they must not be allowed to become unduly crowded. When first taken from the frame it is a safe practice to place them near a wall where some protection, such as a blind or mats stretched over them, can be given against cutting winds and frosty nights. In your district we should scarcely feel it safe to expose the plants to the full inclemencies of the weather before the 20th of this month; but you must be entirely guided by the circumstances indicated. The varieties you mention are fairly representative, and nearly all of them will make good specimens. You have, however, no Anemone Pompons, of which such varieties as Antonius and Marie Stuart among others are attractive as specimens, the large-flowered Anemone sorts not being so well adapted to this purpose. You have only one Pompon, and you might well add in this class Mille Marthe and Bob, both of which make handsome specimens. To the reflexed varieties, of which you only name one, you might well add King of the Crimson, Chevalier Domage, and Mrs. Forsyth; and of Japanese one of the best for specimens is La Nympe; and good additions to the incurved varieties would be Lady Hardinge, Mr. G. Glenny, Prince of Wales, Venus, and White Venus. Then there is what are termed the Hybrid Pompons, and for decorative purposes there are no Chrysanthemums in cultivation more effective and useful than the Crimson Julie Lagravère and the blush-tinted Sœur Melanie. Those named or any of them would greatly improve your collection. If you wish to have a large-flowered Anemone variety try Fleur de Marie.

Protecting Tree Stems (D. Edwards).—The method to which you allude of encasing the stems of late-planted trees with hay or straw bands is an excellent one. We have proved its value repeatedly in the case of standard Peach trees against hot south walls, and last year with a standard Maréchal Niel Rose. This having been planted late in a hot position it was on the point of death, and as a last attempt to save it the stem and lower portion of the Rose were encased in haybands, which were saturated occasionally—indeed, the stem was kept moist. The result more than exceeded our anticipations, for in a short time healthy young shoots were produced, and before the summer was over we had a vigorous tree. A correspondent has recorded in this Journal that he well remembered seeing two clumps of Sycamores planted on two mounds during March; a dozen trees were planted in each clump, but whatever happened to prevent, there was one clump only with the stems covered with haybands as above described; and, strange to say, eleven out of the twelve grew, while only two out of the corresponding clump made a growth. Some planters fix a sort of collar round the stem at the top of the haybands, which, if close-fitting, serves to convey the water down between the stem and its covering, as represented in the figure.

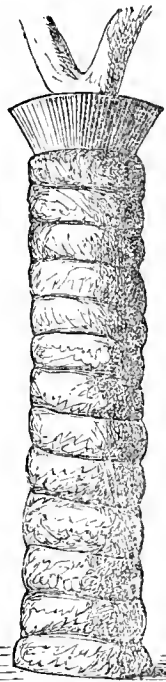

Fig. 87.

Meetings of the Royal Horticultural Society (A Constant Reader).—The next meeting will be held on Tuesday, May 8th, and if you desire to exhibit some flowers the best course would be to write Mr. Barron, Superintendent Royal Horticultural Society's Gardens, Turham Green, stating what you intend showing, and he will no doubt send you an exhibitor's ticket. There are no fees, but the flowers must be

addressed to Mr. Barron at the South Kensington Gardens, where the meetings are held.

Disbudding Peach Trees (E. D. O.).—There are no better instructions on this subject than those that have been given from time to time in our "Work for the Week" columns, and if you examine a few back numbers you will find more information than we can possibly give you on this page. We can only say briefly that under ordinary circumstances five-sixths of the shoots need removal, but this must be done gradually over a period of as many days, commencing as soon as the growths have fairly started by removing those on the under sides of the branches, with any that are ill placed and likely to come in contact with the trellis. One growth should always be retained at the base of each fruit-bearing portion of young wood, this portion being cut out after the crop is gathered, and the other trained for bearing next year. A shoot should also be secured beyond the fruit to be stopped or trained according as there is space on the trellis. Only a sufficient number of shoots should be retained to fairly cover the trellis without any overlapping of foliage, overcrowding being a great and too common error in training Peach trees under glass. The trees may be kept clean by daily syringings and occasional light fumigations—not to destroy insects, but to prevent their appearance. When we see Peach trees

infested with aphides we know there has been some neglect. It may have been unavoidable by a press of other duties, but it is certain the trees have not had the attention they ought. If insects become established soft soap and tobacco water, nicotine soap, or Gishurst compound are all effective remedies when properly applied according to the recommendations that have been many times given, and which are printed on the tins or boxes in which the articles are sold. The petroleum remedy, as described by Mr. Taylor on page 149 is also safe and good, and so is dredging the shoots with tobacco powder after syringing the trees. The cheapest work detailing the process of disbudding fruit trees is our "Fruit Gardening for the Many," which you can have post free from this office for 4s. 6d. The best book on fruit culture under glass is Mr. D. Thomson's work, published by Blackwood & Sons, the price of which is 7s. 6d.

Soil for Ferns (Idem).—A good compost for the majority of Ferns is half turfy loam, the remaining half composed of equal parts of peat and leaf soil, with sand and broken charcoal to render the whole porous. Some persons use a greater proportion of peat with good results, but everything depends on its quality. Others use no peat at all; and for free-growing Ferns, especially that are in good health, peat is not requisite, loam, vegetable soil, and gritty matter affording them better support.

Names of Plants (F. C. W.).—1, Sedum aizoides variegatum; 2, Leucosium vernum; 3, Muscari botryoides; 4, Epimedium alpinum. (W. X.).—1, Rhododendron Gibsoni; 2, R. formosum; 3, R. Veitchianum; 4, R. Nuttallii. (S. T.).—Fritillaria Meleagris; 2, Scilla siberica.

COVENT GARDEN MARKET.—MAY 2ND.

THE supplies of produce continue good, prices being generally maintained, and business active.

FRUIT.

	s.	d.	s.	d.		s.	d.	s.	d.		
Apples.....	½ sieve	2	0	7	0	Grapes	lb.	5	0	to 12	0
"	per barrel	20	0	40	0	Lemons.....	case	10	0	20	0
Apricots.....	doz.	0	0	0	0	New Grapes ...	lb.	8	0	12	0
Cherries.....	½ sieve	0	0	0	0	Nectarines..	dozen	0	0	0	0
Chestnuts.....	bushel	10	0	12	0	Oranges	100	6	0	10	0
Currants, Black..	½ sieve	0	0	0	0	Peaches	dozen	0	0	0	0
" Red.....	½ sieve	0	0	0	0	Pears, kitchen ..	dozen	1	0	2	0
Figs.....	dozen	0	0	0	0	dessert	dozen	1	0	2	0
Filberts.....	lb.	0	0	0	0	Pine Apples, English	lb.	1	6	2	0
Cobs.....	100 lb.	0	0	0	0	Raspberries	lb.	0	0	0	0
Gooseberries	½ sieve	0	0	0	0	Strawberries	oz.	0	6	0	9

VEGETABLES.

	s.	d.	s.	d.		s.	d.	s.	d.		
Artichokes.....	dozen	2	0	4	0	Lettuces	dozen	1	3	to 2	0
Asparagus, English	bundle	12	0	0	0	Mushrooms	punnet	1	0	1	6
Asparagus, French	bundle	25	0	30	0	Mustard & Cress ..	punnet	0	2	0	3
Beans, Kidney	100	2	0	0	0	Onions.....	bushel	2	6	3	6
Beet, Red.....	dozen	1	0	2	0	Parsley..... doz.	bunches	6	0	8	0
Broccoli.....	bundle	0	9	1	6	Parsnips	dozen	1	0	2	0
Brussels Sprouts..	½ sieve	1	6	2	0	Peas	quart	0	0	0	0
Cabbage.....	dozen	0	6	1	0	Potatoes.....	ewt.	6	0	10	0
Capsieums.....	100	1	6	2	0	Kidney.....	ewt.	6	0	10	0
Carrots	bunch	0	4	0	0	Radishes.... doz.	bunches	1	0	0	0
Cauliflowers.....	dozen	2	0	3	0	Rhubarb.....	bundle	0	4	0	0
Celery.....	bundle	1	6	2	0	Salsafy.....	bnrdle	1	0	0	0
Coleworts....doz.	bunches	2	0	4	0	Scorzoneria	bundle	1	6	0	0
Cucumbers.....	each	0	4	0	8	Seakale	basket	1	0	2	0
Endive.....	dozen	1	0	2	0	Shallots	lb.	0	3	0	0
Fennel.....	bunch	0	3	0	0	Spinach.....	bushel	5	0	6	0
Herbs.....	bunch	0	2	0	0	Tomatoes.....	lb.	1	6	2	0
Leeks.....	bunch	0	3	0	4	Turnips.....	bnch	0	2	3	0



POULTRY AND PIGEON CHRONICLE.

PLOUGHING-IN OR FEEDING GREEN CROPS.

(Continued from page 353.)

HAVING given considerable space and attention to the value of green and root crops ploughed in as representing their value for that purpose by the practical agriculturists, we shall now endeavour to show how far the ideas and experience of professional chemists and analysts support the results obtained by practical farmers. For this purpose we introduce very important tables containing the analysis of various crops, showing to a certain extent how far green crops in their death and decay will be enabled to furnish manure for the growth of cereals and other crops usually grown for sale by the home farmer. These are taken from the *Agricultural Gazette* of the 2nd June, 1879, and contributed by Mr. R. Warrington and other analysts, to which we ask particular attention, as the tables are supported and confirmed by Dr. Voelcker to a great extent.

WEIGHT AND AVERAGE CHEMICAL COMPOSITION OF ORDINARY CROPS IN POUNDS PER ACRE.

	Nitrogen.	Sulphur.	Potash.	Soda.	Lime.	Magnesia.	Phosphoric Acid.	Chlorine.	Silica.
	lbs.	lbs.	lbs.	lbs.	lbs.	lbs.	lbs.	lbs.	lbs.
Wheat, 30 bush.	33	2.7	9.7	0.9	1.0	3.7	14.3	0.2	0.5
„ straw ..	12	5.1	18.2	2.5	9.2	4.0	8.4	1.7	110.6
Total....	45	7.8	27.9	3.4	10.2	7.7	22.7	1.9	111.1
Barley, 40 bush.	35	2.9	9.3	1.0	1.3	4.0	16.2	0.4	12.0
„ straw ..	12	3.2	21.6	4.2	8.5	2.5	4.4	3.2	51.5
Total....	47	6.1	31.4	5.2	9.8	6.5	20.6	3.6	63.5
Oats, 45 bush. ...	38	3.2	8.5	1.4	2.0	3.9	11.8	—	24.8
„ straw	14	4.8	29.6	5.9	9.8	5.3	7.1	5.5	69.3
Total....	52	8.0	38.1	7.3	11.8	9.2	18.9	5.5	94.1
Turnips, 17 tons	71	15.2	108.6	17.0	25.5	5.7	22.4	10.9	2.6
„ leaf ..	49	5.7	42.2	7.5	48.5	3.8	10.7	11.2	5.1
Total....	120	20.9	148.8	24.5	74.0	9.5	33.1	22.1	7.7
Swedes, 14 tons	74	14.6	63.3	22.8	19.7	6.8	16.9	6.8	3.1
„ leaf ..	28	3.2	16.4	9.2	22.7	2.4	4.8	8.3	3.6
Total....	102	17.8	79.7	32.0	42.4	9.2	21.7	15.1	6.7
Mangels, 22 tons	96	4.9	191.1	75.4	24.2	19.7	34.0	40.6	16.4
„ leaf ..	51	9.1	71.4	65.2	29.1	27.2	15.1	49.8	9.2
Total....	147	14.0	262.5	140.6	53.3	46.9	49.1	90.4	25.6

Crops.	Contains in pounds per acre.		
	Potash.	Phosphoric Acid.	Authority.
Wheat—5 qr. grain	9½	15½	Voelcker.
„ straw	29	11	
Total.. .. .	38½	26½	
Barley—5 qr. grain	11	15	Do.
„ straw	19½	5	
Total.. .. .	30½	20	
Oats—6 qr. grain	9	13	Boussingault.
„ straw.. ..	24	4	
Total.. .. .	33	17	
Turnips—20 tons bulbs ..	126	31	Playfair.
„ tops.. ..	76	28	
Total.. .. .	202	59	
Potatoes—8 tons tubers ..	68	18½	Ville.
„ haulms ..	9	3	
Total.. .. .	77	21½	
Hay (Clover)—2 tons	52	20	Playfair.
Beans—25 bush. corn	23	24	Do.
„ straw.. ..	89	19	
Total.. .. .	112	36	

These tables on the chemistry of plants require the special study and attention of the home farmer, and ought to give him courage in experimenting upon the value of certain crops recommended to him for use, as manure when ploughed in, more particularly as the practical farmers by their experiments and the professors in agricultural chemistry agree in a most remarkable manner as to the capacity of green crops to furnish food for the cereals. It will be noticed that 17 tons of root crops contain of the three principal elements of manure more than double the quantity contained in the produce of an average crop of cereals, whether of Wheat, Barley, or Oats. These three elements are nitrogen, potash, and phosphoric acid, and are also manures for the most part of a lasting character.

The benefit to be derived from ploughing-in green and vegetable crops consists chiefly of manuring at very little cost for either

seed or tillage, and at the same time all the afterwork required can be done at any period when the green crops and roots are at full growth without treading the land or delaying the seed time of succeeding crops, which often happens when the green and root crops are consumed on the land by sheep. Again, whenever we have seen this system adopted we have never known it fail in producing better crops than where the roots had been fed off by sheep, even when they had eaten cake and hay in addition. The home farmer, of course, will farm the land as he pleases so long as he keeps the land clean, not being compelled to follow any particular rotation or system of stocking and cropping. An impression, however, prevails in the minds of many agriculturists, whether home farmers or tenant farmers, that the land under their management cannot be stocked and manured so advantageously as with a full complement of sheep, kept either as a grazing or breeding flock. This impression, however, lies at the root of the evil, and it will therefore be our endeavour to induce all those who have land in hand to reconsider their position, whether home farmers or otherwise interested in its occupation.

There never has been a time within our recollection when land could be taken under more favourable conditions as to option in cropping and stocking than at present. Landed proprietors will understand that no tenant can injure the land if he keep it clean, and so leaves it on quitting. This leads us to a point which has been raised lately, that no occupier could keep the land clean during such seasons as have prevailed during the past seven years. This may be true in the case of certain soils farmed under a four or five-course rotation, including provision for sheep stock; but it is not true if a proper system of cultivation has been pursued under a close succession of sale crops with no long fallow, and where couch, &c., has been forked out by hand labour instead of culture by costly horse labour. In proof of which, upon our farm, managed on the four-course system of—first, Wheat; second, green crops; third, Lent corn; fourth, Clover, from the years 1831 to 1841, and connected with a system of feeding sheep on the land, it became as foul with couch as possible, and the more highly it was manured the more the couch increased. For under this system, although it is still so general, there are twenty-eight months during the rotation when no couch can be removed except by a sacrifice of the Wheat crop wholly or partially; and if the year of fallow or fallow crops proves unpropitious the land cannot be cleaned until the next four years have expired, and not even then in unfavourable seasons. We afterwards adopted a close system of cropping and extended the acreage of sale crops, but without any long fallow, for more than twenty years, and yet the farm continued to be as clean and free from couch as any farm in the kingdom, although it was a mixed and irregular soil, often varying in the same field from strong clay to light sandy loam. It must also be noticed that this twenty years included various unfavourable seasons, but especially the years 1853 and 1860, both of which were as unsuitable as 1879. We therefore contend that the fouling of land with couch and weeds is attributable only to bad farming under a bad system of stocking and cropping.

We have been induced to notice these facts in order that no unfair advantage may be taken of some important observations and recommendations we intend to introduce to the notice of farmers under the heading of our subject, and which to some may not only appear novel, but likewise impossible or inadvisable. In the Journal of the Royal Agricultural Society of England we note that Mr. R. Russell in his essay on the "Influence of Climate on Cultivation," says:—"Vegetable manuring produces the most marked effect on light sandy soils and in dry climates. The decaying vegetable matter seems to improve the physical texture of the soil by its attraction for moisture; it also, to some extent, regulates the supply of ammonia to the plants by only slowly yielding it up—a matter of much economy in the feeding of plants. The influences combined have the effect of sustaining vegetation in a comparatively healthy state during periods of drought."

Irrespective of the above important considerations, we know from our own daily practice the benefit derived from applying any manuring substances which act mechanically—such as long fresh stable dung upon strong soils—and we can therefore estimate the value attributed to green and root crops ploughed in on heavy clays; for they not only act mechanically by making the land more porous, but also chemically by storing up a quantity of ammonia in a partially insoluble state, which is taken up slowly by the roots according to the requirements of plants, and also by the residue of decayed substances furnishing an amount of humus exceedingly advantageous to future crops.

We are now arrived at a point of our subject when we must illustrate our opinions by a practical explanation of our plans for farming the land to attain the objects we have in view—viz., the securing of increased profits by reducing the outlay and invest-

ment in farming transactions. But to do this we must banish from our minds many traditional matters hitherto customary in this country (except for comparison), so that we may be enabled to restore confidence to many men in their calling, and encouragement to young men, thousands of whom for seven years past have been deterred from entering on the business of farming because of the large amount of capital required in sheep farming, and the uncertainty of profit connected therewith; and especially when connected with a style and system of cropping where only a limited acreage of sale crops can be grown, in some cases in consequence of prevailing customs, in others by restrictions of leases. Anything which operates in this way is a serious matter for the consideration of landowners as well as intending tenants, hence the difficulty of letting farms, and the fact that large numbers of young men are taking their capital to the American continent. Our principal object in taking up this subject is to show how confidence between landlord and tenant, as well as the home farmer and his employer, may be restored by leading them into a course of farming not only more profitable, but at the same time requiring at least one-third less investment of capital than has previously been considered necessary in connection with sheep farming. In order to do this we shall lay before our readers illustrations of detailed systems of management adapted for different soils and farms of various sizes and situations, both as to climate and facility for the sale of produce.

(To be continued.)

WORK ON THE HOME FARM.

Horse Labour.—Although the weather has lately proved very cold, still the snow showers and rain have softened the land where rough and cloddy, and enabled the completion of the Lent corn seeding, which we finished in promising condition on the 26th of April. We are now turning our attention to the seeding for the Mangold and Carrot crops; in fact, some Mangold seed has been drilled in good tilth on the 21st of April, and this is not too soon, especially for the Golden Tankard variety, which grows more slowly than most other sorts; and it is worthy of recollection by the home farmer that this sort is the most valuable of any for feeding purposes, as they contain a larger amount of saccharine than other varieties. It should also be borne in mind that it is quite impossible to manure too highly for them if ammoniacal and mineral manures are both used, for the simple reason that as this crop is usually drawn off the land, the more manure there has been applied the more valuable will be the residue in the land, and also the greater the crop will be available for feeding purposes. The land now may be prepared for Carrots, and the less of manure applied at seedtime the better, except it consists of such as superphosphate and ashes with the seed. The preparation of the seed, too, is a matter of paramount importance, for the old plan of mixing the seed in its ordinary state with the manure is now ignored, and it is best to prepare the seed by hand-rubbing with leather harvesting gloves so as to free it from the burr or husk, for when this has been carefully done the seed will pass easily and with as much regularity as Turnip seed through the drill. This is important, for when the seed with the burr attached is mixed with the ashes or manure for drilling it is extremely rare to obtain a regular plant. Unlike some other of our root crops it is not best to sow Carrots very early; in fact, until the weather and the earth become warm the Carrot seed does not vegetate. The weeds vegetate immediately, and frequently overwhelm the young plants if sown too early; at any rate, sowing the second week in May saves one hand-hoeing as compared with seeding in the month of March, which is often advocated as the best time for sowing.

The work in preparing for Swedish Turnips must be pushed forward, for an early preparation of the land and being kept perfectly fine between the scarifyings will hatch out the Turnip flies, and if no vegetation is found they perish before the seeding time arrives; at least this is our practice, which has answered our purpose for many years. The top-dressing of Wheat, which could not be effected by yard or town manure in the autumn seedtime, may now be done with great advantage. We have applied $2\frac{1}{2}$ cwt. of concentrated corn manure to some of our Wheat, which seemed to require something to revive the plants after the paralysing effect of the almost unparalleled succession of rains, continuing from the first week in October up to the 20th of February. Two times with the harrows simultaneously with sowing the manure, whether of concentrated manures or nitrate of soda only, opens the land, gives more effect to the manures, and greatly assists the growth of the young plants, for they are generally very thin on the land this season. Wherever horse-hoeing accompanied by hand-hoeing of the Wheat has been possible, it is advisable even now for another week or two that it should be done, for the Wheat is generally very backward, especially on the coldest clay and flat-lying soils.

Hand Labour.—This has been a capital time for setting out the draining of land, as all the damp spots and position of the water acting under the surface has been plainly indicated on the first occurrence of the drying east winds of March and April; and if the work has been marked out at the proper time it may now proceed, as this

is the best period of the year for cutting the drains and also for laying in the pipes, for after filling in now the land will lay well in the future. Women are now forking out bunches of couch and twitch, which can be easily seen in almost any of the crops; and let the home farmer bear in mind that this plan has been practised with great advantage for many years, and it has been found that hand labour by the expenditure of a few shillings per acre has saved an outlay of many pounds' worth of horse labour, besides the advantage of preventing delay in the succeeding seedtime.

Live Stock.—The late cold and depressing weather for vegetation has not only kept back the growth of grass and Rye, but thrown the flocks and herds back up the root stores, such as Mangold and Swedes. The number of sheep, however, in the country has been so much diminished by disease during the past three years that the flocks are more easily provided for than usual. Dairy cows which have been housed at night time should not lie out at night until the second week in May, and then it should, if possible, be upon a dry and sheltered pasture. The cattle in the boxes which are not yet fit for market, if well fed now, will be ready in good time, for light weights, if in the best condition, will sell well from the 1st of July up to the 20th of August, which is the period just previous to the cattle off the best grazing districts being brought to market. There has been much ado about the sale of lambs since Her Majesty the Queen made the announcement not to consume lamb in the royal household. The time, however, is past to do much injury to the farmers as to the sale of lamb, except for the forward lambs from the best horned Somerset and Dorset ewes, but they are now nearly all sold. Therefore the Down lambs, although fat, if they cannot be sold well at light weights, may be held on with advantage until Michaelmas where a provision in food can be obtained for them until that time.

OUR LETTER BOX.

Lucerne (S. A.).—You can grow a crop of Lucerne to remain as many years as you wish. If you sow it between your winter Beans it will take 20 lbs. of seed per acre broadcast, if it is drilled at 15 inches apart 16 lbs. will be enough. It depends upon the distance between the lines of the Beans as to whether you can drill the seed with regularity between them, but if sown broadcast and hoed-in the last time of hoeing the Beans it will probably answer. If you drill it the hand drill used in gardens will do the work well at any distance. Drilling is best, because the land can be kept clean, and the crops of Lucerne will be encouraged much in their growth by hoeing between the lines.

Rape Cake (Inquirer).—Rape cake, although formerly used generally for the purposes of manure, is now extensively used as a feeding stuff. It does not differ very widely in general composition from the linseed cake. The composition is as follows:—Oil, $11\frac{1}{2}$ per cent.; albumen, $30\frac{1}{2}$; starch, &c., 23; and 8 of mineral substances. Thus it contains a higher per-centage of albuminous or flesh-forming matters than linseed cake. It has, however, a certain bitter taste, which somewhat lowers its value for feeding purposes. The chief objection to rape cake is its liability to contain oil of mustard, the presence of which can be easily detected by mixing a little with water, and subjecting it to heat, when the smell of the mustard is very easily recognised. Foreign rape cake is the best, inasmuch as it is made from seed grown in the north of Germany and France, and is purer than the East Indian seed, from which English cake is principally manufactured.

METEOROLOGICAL OBSERVATIONS.

CAMDEN SQUARE, LONDON.

Lat. $51^{\circ} 32' 40''$ N.; Long. $0^{\circ} 8' 0''$ W.; Altitude, 111 feet.

DATE.	9 A.M.					IN THE DAY.				Rain
	Barometer at 32 ^s and Sea Level	Hygrometer.		Direction of Wind.	Temp. of Soil at 1 foot.	Shade Temperature.		Radiation Temperature.		
		Dry.	Wet.			Max.	Min.	In sun.	On grass.	
1883.										
April.										
Sun. 22	30.226	46.8	41.2	N.E.	46.9	53.3	31.6	97.8	31.8	0.019
Mon. 23	29.875	41.7	36.3	N.E.	46.0	48.2	35.0	97.6	32.5	0.197
Tues. 24	29.585	42.1	39.7	N.E.	44.5	52.4	31.3	87.1	31.0	0.016
Wed. 25	29.639	45.1	41.2	N.W.	44.6	54.5	39.8	95.8	37.3	—
Thurs. 26	29.732	52.4	47.9	S.E.	44.7	60.7	33.5	104.6	26.6	—
Friday 27	29.448	51.7	48.6	E.	46.3	59.8	46.9	74.5	43.3	0.318
Satur. 28	29.426	50.9	51.1	N.W.	47.5	60.8	49.3	103.0	48.3	0.300
	29.709	47.2	43.7		45.7	55.1	39.1	94.3	35.8	0.844

REMARKS.

- 22nd.—Dull and cold; sharp shower in forenoon, fine afternoon and evening; bright moonlight night.
 23rd.—Gusty and cold; bright sunshine in forenoon, heavy shower of hail 2.30 P.M., snow and hail at intervals during afternoon and evening.
 24th.—Cold and showery.
 25th.—Very fine and bright, with cold wind.
 26th.—Fine and bright; solar halo 5.30 P.M.; high wind in evening.
 27th.—Morning dull and showery; fair afternoon and evening.
 28th.—Dull morning, with rain; fine afternoon, rain again in evening.

Temperature on the whole near the average, but the 23rd was very wintery, with a considerable fall of snow quite an inch in depth. Sharp frost on 26th.—
 G. J. SYMONS.



10th	TH	Royal Society at 4.30 P.M.
11th	F	Manchester Spring Exhibition (five days).
12th	S	Royal Botanic Society at 3.45 P.M. International Fisheries Ex-
13th	SUN	hibition, South Kensington.
14th	M	WHIT-SUNDAY.
15th	TU	Bank Holiday.
16th	W	Royal Botanic Society's Summer Show.

AUSTRALIAN APPLES FOR THE BRITISH MARKET.

ON behalf of the Horticultural Society of Victoria I have the pleasure to send you several samples of Apples grown in their grounds at Melbourne, and shipped per mail steamer "Siam" the last week in February. The collection is an interesting one, inasmuch as it comprises several varieties, and was intended to be a shipment to ascertain, not only how far it was safe to forward fruit to this market, but also what sorts were the most suitable for long sea voyages. Our Agent General, Mr. Murray Smith, had a similar collection from the same Society, and I am glad to learn they have also arrived in sound condition.

The fruit was packed in the ordinary hardwood cases of the colony. Each Apple was simply wrapped up in thin paper. The cases were placed on board the steamer at Melbourne on March 1st, and never touched till they were landed in London on April 20th. This plan was adopted at the suggestion of Mr. C. Neilson, the Curator of the Horticultural Gardens, Melbourne, and faithfully carried out so that it should not be said exceptional pains were taken with the fruit during its transit. I leave the specimens sent you to speak for themselves.

I presume it is well known in England that pomology in all its branches has of late years received much attention in our fine colony. The Society above mentioned has, I think, about 130 varieties of Apples alone within its bounds, and these are yearly added to. Scions for grafting are sent out every season to country districts and to the neighbouring colonies, and at this present time the great question with private growers is where to find fresh outlets for the bounties of Providence. Just before I left Melbourne a meeting of gardeners had taken place to discuss this matter; and as the production will increase more rapidly than the demand in our limited community, I trust this country will not refuse to accept the abundance of its colonial productions.

I remember the time when all our fruits were imported from Tasmania, but now we not only supply ourselves, but export largely to New South Wales, South Australia, Queensland, and even New Zealand. It may be interesting to know that several localities have been found specially suited for English fruits, including Macedon, Healesville, Fernshaw, and the Gippsland districts, and I know of private enterprise having planted over 300 acres with fruit trees in one season. Raspberries and Strawberries are grown by

the ton in such localities; and in a few years we may see another district opened up between the railway to Gippsland and the sea comprising over one million acres of the finest land in the world, and with a climate every way adapted for bringing English fruits to perfection. I shall be glad if you will, through the columns of your widely circulated journal, help forward this enterprise of our colony; and may I hope that some of the depressed and overpeopled districts of Great Britain will send out some good honest hard-working families to take up our broad acres and make comfortable homesteads for themselves?—W. L. HUTCHINSON.

[We are obliged to Mr. Hutchinson for his interesting communication and for the samples of Apples to which it refers. This is the first consignment of Apples from the antipodes that we have seen, and we do not hesitate saying that we were surprised by the beautiful appearance and admirable condition of the fruit when it was placed before us. The soil and climate of Australia are evidently peculiarly adapted for the production of Apples of high-class quality; those before us, and which were exhibited at the evening meeting of the Royal Horticultural Society at Burlington House on Tuesday last, being such as will bear comparison with the finest examples grown in this country, and they are far above the average of the produce, whether European or American, that is sold in the markets at the present time. These Australian Apples are not only of large size according to the varieties—which, however, are not named, though some of them are recognisable—but in shape and contour leave nothing to be desired, while in the transparency of their skin and liveliness of colour they are remarkable. In the latter respect they remind us of the best samples of fruit grown in orchard houses. Some of them are extremely solid and heavy, and nearly all of them are without spot or blemish—in fact they are just in the condition that fruiterers like to see prominently in their windows. One or two of them are a little shrivelled, such as the fine specimens of Adams' Pearmain, through having been gathered too soon—February, and they evidently ought to have been left on the trees till the middle of March.

This suggestion to gather Apples in March may, for a moment, sound somewhat strange to English ears; but the fact of the fruit maturing at that time in Australia is not without significance when the commercial aspect of the subject is considered. The supply of Apples in this country, including American importations, is, broadly speaking, from August to April, more or less of both months included, and from April to August there is no great bulk of fruit in the market. Now if Apples are so plentiful in Australia, they then can, like meat, be purchased at prices sufficiently low to enable them to be shipped to this country and sold at, or about, the prices that usually obtain here in April; the four now appleless months will be bridged over, and an all-the-year-round supply will be maintained. This, too, it is worthy of note, will be effected without prejudice to either British or American orchardists, for it is not until the supply of Apples from the northern hemisphere is exhausted that the antipodean crops can reach this country; and if these are gathered in February and March, the late varieties, as with us, may be expected to keep sound and fresh for at least four or five months. It is true the ripening

process may be in some degree accelerated during the passage through the tropics; but in these days of fast steamers this is not a serious contingency. The most important question is that of freight. That Australian Apples can arrive here perfectly fresh and sound and in first-rate marketable condition, is demonstrated by what may be termed this small pioneer consignment; and they arrive, too, at the period most advantageous to consumers here and producers on the other side of the globe.

But before the importation of Australian Apples can become successful, it will be necessary to ascertain what varieties will prove the most satisfactory. It is quite clear from the samples we have received that both English and American Apples succeed admirably in Australia; and if cargoes of such popular sorts as Cox's Orange Pippin and Newtown Pippin can reach us in April, May, and June, in the same attractive state as the Northern Spy, Lemon Pippin, and some others have reached us now, there is little, if any, doubt that they would find ready purchasers if they could be disposed of at fairly moderate prices—say to consumers at 1*d.* each, many of both the two varieties named having realised 2*d.* each during the present season.

We suggest, both in the interest of Australian cultivators and British consumers of their produce, that in the next consignment the names of the varieties be securely attached to the fruit, we shall then be able to express an opinion as to the varieties that are likely to be the most suitable for the markets of this country.]

THINNING HARDY FRUIT.

Too much importance cannot be attached to the practice of thinning hardy fruit. If we expect fine fruit and of good flavour we must (if there is an over-abundance) thin to gain those ends. Of course we do not expect to thin the fruit on orchard standards, as that would be next to an impossibility; but trees on walls, espaliers or pyramids, to do them justice must have superfluous fruit removed. Many gardeners, and especially young men, when the trees are loaded with fruit rejoice to see it, little thinking what harm is being done to the trees, but in after years they find it out, too often to their cost.

There is in all fruit trees a certain amount of fruit-producing power according to the health of the tree, and it is by far the best plan to direct it to maturing a certain number of good fruit than to distribute it amongst numberless small ones. Gardeners are expected to maintain a good dessert, and it is the ambition of most of them to produce it. They have if they thin no trouble to pick fine fruit; but, on the other hand, if not thinned in a productive season quite one-half are not fit to go to the table, and the others are unsatisfactory. I am sure those who thin fruit once will not allow the crops to go unthinned afterwards. The best time to thin is when cultivators are sure of a crop. In the case of Pears thin according to the size of the variety. Most varieties do well with fruits 1 foot apart, and Apples, Plums, &c., according to the size of the variety. Never leave two together. We thin Grapes, Peaches, and Apricots to gain size; why not Pears, Apples, and Plums?

Such varieties of excellent Pears as Winter Nelis, Josephine de Malines, Bergamot Esperen, Passe Crassane, and others of that type are almost worthless if allowed to carry heavy crops. Dessert Apples, which are very much appreciated during the winter months, are not very presentable if the trees are allowed to carry too many. I daresay many gardeners will say, "We have no time to thin Apples and Pears." Well, I can only say we should have had no time to thin if we had waited until all other work was done; but I had one of the finest collections of hardy fruit in the country to manage, and to satisfy my employer we were obliged to thin, so we found time.—
A. YOUNG.

P.S.—If Dr. Mackenzie were to remove all the flower buds

from the extremity of every branch it would be beneficial to the trees; and if the trees are required to have extension, a wood bud is the best to remove the blossom to. I suspect the branches referred to are of last year's growth.

MARIE LOUISE VIOLET.

As some time since you expressed a wish to know our system of Violet culture, I send a few remarks on growing this, the finest of all the double kinds, as practised here. We grow them similar to the way we prepare Strawberries for forcing—namely, from runners every year. During the summer the plants are grown in the open; a north or west border suits them well. They are kept clear of weeds, and in our case nothing more is done to them until the end of September or early in October. They are then carefully lifted with good balls, and planted in cold frames having a south aspect, keeping them near to the glass. If the soil is heavy a third part of leaf mould is added, and as the planting progresses two or three runners on each plant are pressed into the soil, no pegs being used. These are to form the plants for next season, and by spring are well rooted, strong, and bushy. They are then carefully cut off and planted, the old plants not being used the second time. Plants so treated are often a foot in diameter by the following autumn. By this system we consider that we procure much stronger plants, and consequently larger flowers. The Neapolitan we treat in the same manner, but this produces a greater number of runners, which no doubt would be better taken off during the summer. We do not remove runners from Marie Louise until planting in frames in the autumn, and we always have plenty of Violets. The two evils to guard against is red spider at all times and damp in winter. Against the former we ply the syringe freely on bright mornings, and against the latter we sprinkle powdered charcoal between the plants. Ventilation must be well attended to at all times when not actually freezing, propping up the sashes sideways, so that a current of air can pass freely among the plants. From plants so treated we have not missed a day since early in September last up to the present time without gathering such blooms as I sent you a few weeks ago.—
G. SUMMERS, *Sandbeck Park.*

[Finer Violets we never saw than those referred to.]

VINE MILDEW (OIDIUM TUCKERI).

THIS is the worst disease, phylloxera excepted, to which Vines are susceptible, as those who have ever had to contend with it in a severe form know only too well, and if allowed to have its own course too long, and is permitted to get a firm hold of the Vines before remedial measures are applied, the disastrous consequences resulting therefrom may not only render the current year's crop worthless, but will endanger in a very great degree the succeeding one, and, as a matter of course, will cause no end of vexation and disappointment to those on whose shoulders the safety and well-being of the crop depends. One fruitful source of the disease is low temperature accompanied by a moist stagnant atmosphere and insufficient ventilation. It may also be stated that Vines growing near the seacoast are much subject to mildew, and let their treatment be ever so skilful, if preventive measures are not taken they are almost certain to be attacked by it. Being a fungoid disease like the Peronospora, which affects our Potato crops, it spreads with great rapidity. Unlike the latter, however, it is curable; were it not so, Grape-growing in this country would not be so profitable an undertaking as it proves to many. Although it was first discovered in this country about the year 1845 by a Mr. Tucker, it is not unknown in other parts of Europe; indeed, it has been known to almost totally destroy the crops in bad seasons in some parts of France and Italy. Failures, however, from this disease are not of so frequent occurrence now, I believe, as formerly, owing in a great measure to its cause and cure being better understood.

For the benefit of those who are unacquainted with it, it may be stated that in its early stages it is first discernible to the naked eye in the shape of minute specks smaller than a

pin's head, and may be found on both leaves and berries, but is best seen on the latter, the most likely period for its appearance being from a week or two after the berries are set to the time of their having stoned. It is always well to keep a sharp look-out for it even in vineries where it has not been known to previously exist, and if taken in hand early, and is not allowed any longer time for further development, it may be got rid of for the season with comparatively little trouble. Once, however, let it get firmly established, and all hopes of any presentable Grapes for the season may be abandoned.

For its prevention and cure flowers of sulphur is used in various ways by many practitioners with success, its application invariably being in the form of dusting over the affected parts of both leaves and bunches, and also by painting the pipes or flues when quite hot, skimmed milk or water being used to the sulphur of the consistency of paint, with a little hot lime added thereto. The latter plan, it ought to be mentioned, may in the hands of unskilful persons prove far worse than the evil; it ought, therefore, not to be adopted by either amateurs or novices. In the writer's opinion dusting the leaves and bunches is very objectionable, owing to the disfigurement caused to the latter themselves, and rendering them very unsightly. By most seedsmen "mildew compositions" are now sold, and may be used for the disease with far greater safety and better results than sulphur in its raw state. We have found, after many years' experience of the same, "Ewing's Mildew Composition" to answer its purpose admirably, a wine-glassful being mixed with a gallon of water at a temperature of about 80° Fahrenheit. Syringe the Vines when the young shoots are about 3 inches long, and also after the berries are set and thinned the first time. The only objection to its application in this form is in its turning quite brown whatever wood it comes in contact with (*i.e.*, if painted white). It may—so directions for use say, though we have not tried it—be used in another way—*viz.*, by mixing with lime and painting over the pipes when quite hot. I would further add that if the bunches are badly attacked a solution of the above in a 10-inch flower pot, in which to immerse the bunches, is a capital plan to adopt, the hole in the bottom of the pot being corked up. Wherever and whenever the disease appears it ought not to be given any quarter whatever.—ET CÆTERA.

NEW, CHOICE, AND RARE ORCHIDS.

So many new and beautiful members of the great Orchid family are now annually introduced, that those who have not the opportunity of visiting the chief London nurseries and amateurs' establishments, or of attending the Royal Horticultural Society's meetings and the Royal Botanic Society's shows, can have little idea of the rapid advance that is being made. Many races or families of plants have at times become popular in a more than ordinary degree, but Orchids seem to be destined to obtain a much more lasting and extensive share of public favour than has hitherto been accorded to any others if the undisputed queen, the Rose, be excepted. Collections of Orchids can now be counted by the score where a few years ago they could not be numbered by dozens; and though some old collections are disposed of at times, many others make their appearance, of smaller extent individually, but collectively much greater. There is an indefinable charm about an Orchid—a kind of mystery which, together with the brilliance and beauty of their flowers, has given them a secure hold upon popular fancy, which rapidly increases to enthusiasm as experience is gained. The supposed difficulties attending Orchid-growing have, too, been almost entirely removed; and it is now understood that a large proportion of the most useful and handsome Orchids can be grown with no more expense or trouble than thousands of other plants, and considerably less than is necessary to insure success with some hardwooded plants and Heaths. In the neighbourhood of large towns the increase in the number of Orchid growers is most noticeable, and particularly in the suburbs of London, where there are dozens of first-rate collections, not all so extensive as that at Burford Lodge, but yet including representatives of the best genera and the choicest and rarest species in the most improved varieties. The wonderful collections of Messrs. Veitch, Williams, and Bull also seem to increase, notwithstanding the numerous demands they have to supply, and altogether Orchids may now be considered to be in the zenith of their popularity, a position which they are likely to occupy for many years.

Having opportunities of seeing all the best of the novelties and

the most noteworthy of the rare or curious species, I intend to occasionally submit a few notes of observations upon them, with a view to directing amateurs' attention to the plants most likely to give them satisfaction. Readers of this Journal, too, who have or observe any Orchids of remarkable interest will perhaps also aid in the record.

ODONTOGLOSSUM CORDATUM, VAR.

Flowers of a handsome variety of this Orchid were recently sent from a Lancashire correspondent, and one of these is shown in the woodcut, fig. 88. It is somewhat like a variety known as *superbum*, which was first shown at Manchester about sixteen years since by A. Turner, Esq. of Leicester, and it appears to resemble that also in its vigour and floriferousness, the spike from which the specimen engraved was taken having borne twenty-seven flowers. The species was, I believe, first introduced by Mr. G. Barker of Birmingham

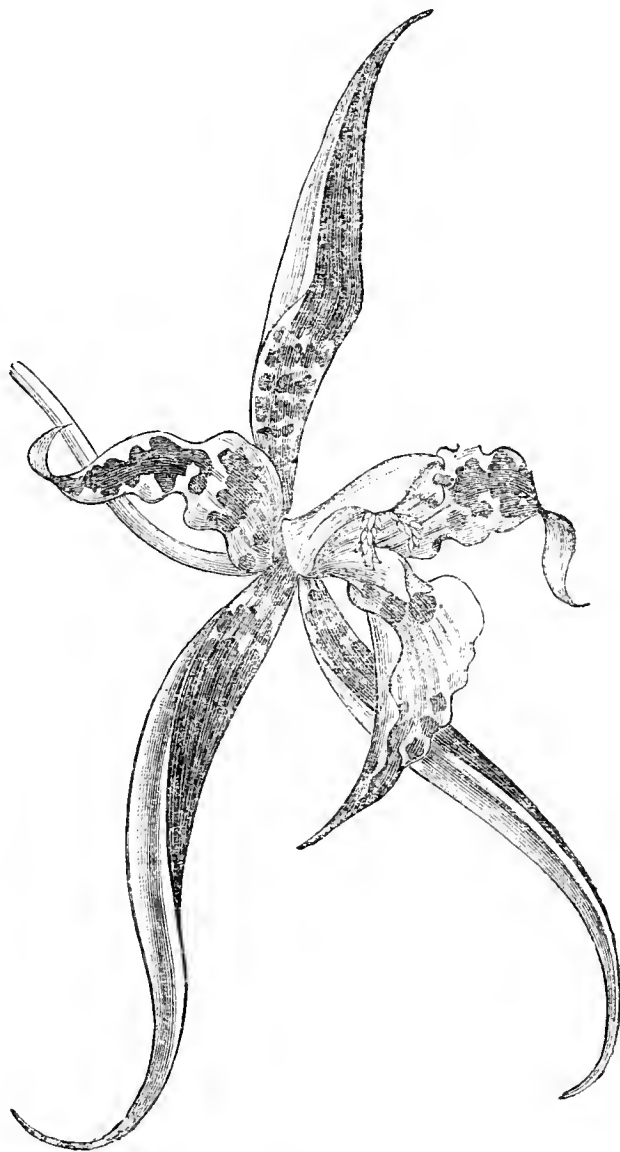

Fig. 88.—*Odontoglossum cordatum*, var.

about 1838, and in 1847 a figure of a good variety was given in "Paxton's Magazine of Botany." This represents a form with broad yellowish petals and lip, having a few transverse rich brown bars, the sepals narrow, greenish, also with brown bars. The variety shown here has longer sepals, and the colour is much darker, the lip being finely marked.

LYCASTE HARRISONÆ ALBA.

In the handsome group of choice and well-grown Orchids staged by Mr. B. S. Williams of Upper Holloway at the South Kensington meeting on April 24th, especially noteworthy was the above-named; an extremely distinct and beautiful variety of a well-known Orchid, which also bears the generic names of *Maxillaria* and *Bifrenaria*. As the varietal name implies, it is distinguished from the specific type by the sepals and petals being pure white. The lip also is much lighter, with fewer streaks than are usually present. It possesses a powerful fragrance, but a little less strong than the species. The first-class certificate awarded for it signified the Floral Committee's appreciation of its beauty, and I understand that the plant has now been added to Sir Trevor Lawrence's Burford Lodge collection. No doubt that, like its darker relative, it will succeed equally well in a cool house and prove as lasting.

The sepals and petals of *L. Harrisonæ* are usually more or less tinged with dull yellow, which becomes much darker as the flowers grow older. The lip also is of a purplish colour, sometimes very deep, and in a variety I recently saw it was quite a warm crimson.

MASDEVALLIA SCHLIMIL.

When Sir Trevor Lawrence exhibited a plant in flower of this *Masdevallia* with several other rare Orchids about a fortnight since at Kensington, it attracted much attention, especially from the orchidists present, as, though plants had been in several growers' hands for some time, flowers had not been previously produced in England. There had been some strange expectations concerning it, and had it possessed the "blue" flowers, which some had fondly hoped, it would have indeed created a sensation in the Orchid world. Though, however, it is not blue, the colour is very striking; and the flowers are so freely produced that it will take a prominent place amongst the greatest favourites of the genus. The plant shown had two spikes, with four and five flowers each respectively; the ground colour yellowish, thickly dotted with purplish brown—a very peculiar shade. The tails of the sepals are 2 to 3 inches long, and yellow, slightly recurving. The lip is very small, and also of a yellow tint. The leaves are of great substance, thick, about 5 inches long and 1½ broad, of a fine rich dark green hue. The specimen was only of moderate size, but its vigour was well shown by the two fine spikes it bore; and another good quality said to be possessed by this species is the length of time it continues flowering—four or five months. It was first found by Mr. Louis Schlim, but was introduced to this country by Mr. F. Sander.

DENDROBIUM NOBILE VAR. NOBILIUS.

Many varieties of the Noble Dendrobe have been imported, varying greatly in the size and colouring of the flowers, one of the richest being *D. nobile* var. *cærulescens*, but that has rather small blooms. The "more noble" variety which is now specially referred to here, is, however, incomparably superior to any which have hitherto been in cultivation. I have seen plants in flower on several occasions, but the one shown at Kensington, March 13th of the present year by Mr. Salter, gardener to J. Southgate, Esq., Selborne, Streatham, was finer than any I had previously seen, and was greatly admired, the Floral Committee unhesitatingly granting a first-class certificate for it. The flowers were large; the sepals and petals of a rich violet purple hue, very deep, the lip also being coloured with a similar tint. Such flowers as these would be most valuable for arranging with lighter-coloured ones in bouquets, but unfortunately it is still scarce, and probably some time will elapse before it becomes so common as is desirable.

Mr. H. James of the Castle Nursery, Lower Norwood, has had much to do with this plant, and he has obligingly furnished me with the following brief outline of its history. "The original plant of *D. nobile nobilius* was bought at Stevens' sale rooms in 1876, and was one of a bundle of twelve, which, strange to say, contained the fine *D. Brymerianum*, which is also now in the collection of J. Southgate, Esq., Selborne, Streatham, the twelve costing 12s. *D. nobilius* flowered early in 1877 on the imported pseudo-bulb, and was exhibited at Kensington, but was not then thought worth a certificate. It was shortly afterwards (February 13th, 1877) sold to Messrs. Rollisson for five guineas. It was exceedingly well grown by Mr. Miteham, and finely flowered in the spring of 1879, just in time to be sent to the Ghent Show in bitter cold weather, which nearly killed it, with many other fine plants that were sent with it. In the following autumn at the sale I bought the apparently dead plant for 75s., and succeeded in raising six small plants from the tops of the pseudo-bulbs that had not quite perished. The fine plant exhibited at Kensington on March 13th is one of the plants thus raised, and was sold to J. Southgate, Esq., August 13th, 1880. It was then a small plant not more than 2 inches high. It has progressed well under Mr. Salter's care; in fact, it has proved from the first to be possessed of remarkable vigour, and grows very much faster than any other form of *D. nobile* I have seen. Nine other plants have been distributed from the same source."

ODONTOGLOSSUM VEXILLARIUM SPLENDENS.

A grand variety of this *Odontoglossum* is included in the Upper Holloway collections, and very rarely is such rich colour seen in combination with good size and form. The deeper-tinted forms of this, as with some other Orchids, usually have comparatively small flowers, but these were rather above the ordinary size of lighter varieties and unsurpassed in colour—a rich warm crimson. The beauty of the best varieties of this species of Orchid are extremely valuable for decorative purposes, and when well grown they are attractive both in and out of flower. Where a small

house can be specially devoted to them the best success appears to be obtained, and I once saw a magnificent lot of plants in the collection of C. Winn, Esq., Birmingham, where the plants grow literally as freely as weeds in a slightly higher temperature than is accorded to most *Odontoglossums*.

ODONTOGLOSSUM POLYXANTHUM GRANDIFLORUM.

This also was exhibited on the same occasion as the above at Kensington and certificated, an honour which it particularly well merited. It was from the fine collection of W. Lee, Esq., Downside, Leatherhead, where so many other choice Orchids are grown, and of which occasional instalments are sent to Kensington to awaken the admiration of all who see them. The superb variety shown under the above name received more than ordinary attention, for both in size and richness of colouring it is far superior to the species; indeed it was so very distinct that at first glance its relationship to *O. polyxanthum* would not have been guessed. The sepals and petals are both very broad and of great substance, the former heavily blotched with rich brown; the latter also being yellow, with fewer small spots near the base. The lip is roundish, the outermost margin being prolonged into a tapering point, rich brown with a shining lustrous surface, and margined with white.—L. CASTLE.

TOMATO CULTURE.

THAT the Tomato grows in favour and is more extensively cultivated every year is, I believe, undoubtedly true. It is a popular favourite, taking higher rank than an ordinary vegetable, as it certainly ought, for it is indispensable with many. For using uncooked, sliced in salads, it is a general favourite; when either boiled or baked as a vegetable and served quite plain without any of the mysterious combinations of Monsieur le Chef, in whose menù the highest triumphs of his art are frequently made perfect *aux Tomates*, and as a sauce is perhaps more useful than in any other way. I may usefully add here that the sauce is both easy and inexpensive to make, keeping well for a year or more provided the boiling is thorough and the bottling sound so that air is quite excluded; and it is worthy of all pains, for it is certainly one of the most delicious condiments of the table. Recipes for making it are almost as plentiful and varied as individual tastes, some liking the flavour of Onions added, others of Shallots, or cayenne pepper is preferred to *Capsicum* pods. My wife makes capital sauce with a few simple additions to impart a palatable flavour, and she also uses it as the basis of an excellent kind of chutney, which we infinitely prefer to some which a friend brought us from Canton.

The culture of the Tomato is very much a question of ways and means, for its nature is so pliant and accommodating that it readily adapts itself to any position where enough light and heat can be had. The finest Tomatoes I have ever grown were from plants in a new vinery in the pots out of which the Grape Vines had been turned to plant it, the space and light of the interior of the vinery being thus turned to account the first summer to secure a supply of Tomatoes. It was one of those makeshifts to which one is so often put in a new garden, and it was a successful one. The important points in pot culture are thorough drainage, rich soil made firm in the pot, keeping the growth within bounds by pinching at the fruit joint or the next one beyond it, and, above all, abundant watering—not waiting till the soil is dry, but rather anticipating its wants, especially when the roots become crowded, for then it is hardly possible to give too much water, and insufficient inevitably leads to failure. Artificial manure may always be used with advantage in the water to assist the swelling fruit, and house sewage answers equally well. Be it understood that I do not recommend pot culture only as an excellent makeshift to which owners of small gardens may gladly and confidently turn for their supply, and it is surprising how many dozens of excellent fruit may be had from three or four well-managed plants in pots placed in a greenhouse or pit.

After growing them in various ways both indoors and out I have definitely settled down to an easy and simple method, whereby I obtain an abundant supply from June till Christmas. To do this I require thirteen plants, and it was the sight of this season's batch almost ready for planting out in the stations that prompted the writing of this article. Nothing is easier—few plants so easy to raise from seed in the heat of an ordinary hot-bed. They are potted singly as soon as they are a couple of inches high, and placed on the back shelf of a Melon pit within a few inches of the glass, where they become fine, stout, sturdy plants fit for planting in about a month. Thirteen stations are made for them at intervals inside the front of an unheated lean-to Peach house by nailing four pieces of stout rough board together, each

measuring 2 feet long by 1 foot wide for the sides of each station, and these little square frames without a bottom or top are laid upon the soil of a Peach border and filled with compost from the large heap made here every year, consisting of garden refuse, coal ashes, lime, and stable manure thoroughly mixed. In this the plants are placed as early in March or April as is safe, one plant to each station. They have the tops nipped off at about a foot high; and subsequently in summer, when they become large plants in full bearing, much pruning of lateral growth and thinning of foliage becomes requisite, for they invariably become rampant and spread beyond the bounds assigned them if not kept well in hand. The growth is supported on a rough trellis of stakes, which is soon hid from sight by the sturdy growth and dense green foliage. Six feet in height and the same in width is the size to which they are allowed to grow, and to which they are of necessity, or rather by preference, kept; for when they become laden with heavy clusters of fruit they are an extraordinary and pleasant sight, the superabundant crop often affording us the pleasure of assisting a neighbour or friend, as well as keeping all home requirements thoroughly supplied. At first two plants were put in each station, but that was discontinued when it was found how superior in size and abundance the crop of a single plant was. A thorough soaking of water containing artificial manure is given daily when the plants are in full bearing to perfect the fruit and to promote lateral growth for successional fruit.

Tomato culture in the open air I have long discontinued, for although it is occasionally successful, yet it is so speculative a matter as to be always avoided if possible. How this may be done by resorting to pot plants has been shown, and, failing any convenience for them, excellent crops may be had in an ordinary garden frame, only taking care to avoid the too common fault of crowding. One good plant well developed, with a full play of light and air among its branches, is infinitely preferable to half a dozen crowded together and spoiling each other.—EDWARD LUCKHURST.

AURICULAS AT SOUTH KENSINGTON.

I HAVE perused with much interest the remarks of your correspondent "D., Deal" (page 359), on this subject, and there is one point which he mentions with which I do most thoroughly agree. I allude to the classes for four and two plants, dissimilar, where we find growers with, perhaps, a thousand Auriculas entering the lists against young enthusiasts whose whole stock may not exceed fifty plants. I trust the remarks in question will have a salutary effect; for if rising fanciers, and there are many such, know that these are the competitors with whom they will have to cross swords at future exhibitions they will ponder long before entering a contest where their chance of success is reduced to a minimum. But I go further. I observe in your report of the Exhibition (page 340) that one exhibitor took the whole batch of prizes—twelve in all—in the two classes for single specimen Alpines with gold centres and with white or cream centres. I suppose the Society's rules are elastic enough to permit this, but at the same time I cannot help expressing a very strong opinion that there is room for an alteration in this respect. If the aim of the Society is to encourage the love of the Auricula among amateurs and persons other than trade growers, I do urge that it is simply a *reductio ad absurdum* to have a rule which will allow of one exhibitor sweeping the entire board; but, on the contrary, if only those are invited who have collections of thousands of plants the sooner this position is clearly defined the better for all concerned. I may add that I am not yet an exhibitor, and write in no vindictive spirit. My only desire in this, as in other matters relating to horticulture, is to see every exhibitor to get what he has a right to expect, viz.—FAIR PLAY, *Wimbledon*.

CANKER IN FRUIT TREES.

I STATED in my letter of the 19th inst. "that some kinds of Plums, Apples, and Pears do not canker almost anywhere, but unfortunately I know of very few varieties of which this can be said." At your request I name the few varieties that I have found to resist canker even after such seasons as 1879-80, 1880-81, 1881-82, and upon such samples of the London clay where Wellington Apple, Jargonelle Pear, and Victoria Plum were very much crippled.

Apples Free from Canker—Dutch Mignonne, Tower of Glamis, and Keswick Codlin.

Pears—Pitmaston Duchess, Williams' Bon Chrétien, and Durondeau.

Plums—Kirke's, Rivers' Early Prolific, and Belgian Purple.

I may add, I did not find that Plums suffered nearly so much

from the three hard winters with wet summers as they did from the salt-laden gale of the 27th of April, 1882. They have not yet quite got over that where they were exposed to it in the open ground. On a wall with a north-east aspect, and thus sheltered from the gale, the trees are full of blossom, but in the open there is little or no blossom, but many dead branches.—CANKER.

LEAF SOIL.

REFERRING to Mr. Wright's article on "Leaf Soil," permit me to say I have been employing it without admixture with any other material for the past few seasons for growing various plants. This year it is being employed very extensively. Most of our bedding plants are being grown in it whether in pots or planted out. Seedlings of Asters, Stocks, and other flowers, Vegetable Marrows, &c., are raised in it. Our Celery is pricked out on a top layer of leaf soil, with a base one of horse droppings. The best Seakale we have ever had was forced this season in a mixture of horse droppings and leaf soil. Many hundreds are forced. Arums in simple leaf soil have done as well as those in soil and manure. Some of the best Leeks (show) I have seen were grown in pure leaf soil. We are trying a few Auriculas, and intend to make experiments with other plants.—B.

READERS of the *Journal of Horticulture* are much indebted to Mr. Wright for his excellent paper on leaf soil. The correctness of his conclusions I can substantiate, having seen very satisfactory results follow the use of such soil as is recommended. It is some eight years since, when on a visit to "Single-handed," I noticed the extra vigour of many different kinds of stove and greenhouse plants growing in apparently common leaf soil. As this substance does not usually produce the best results I made some remark to that effect. I was then told that the soil was not ordinary leaf mould, but had been procured from a wood, and that it was open, sweet, and spongy. Because of this the roots of plants took readily to it, multiplied exceedingly, and evidently found food enough to produce such growth as is not often seen. The individual referred to specially recommended it for Ferns, and for such it is undoubtedly well suited. Should this catch the eye of "Single-handed," perhaps he may be induced to tell us something about the compost he used, and what plants it suited best.

In conclusion, will you allow me to mention that as a reader of nearly all the gardening papers, I enjoy the *Journal of Horticulture* the best of all? As a gardener's paper it is undoubtedly of acknowledged value and usefulness. The science that appears in its pages is of a kind that ordinary gardeners can understand and turn to account, and not as much above their comprehension as the trifles some deal in are below their notice. Round this district the articles which appear in the *Journal* from the pens of writers whose signatures are "familiar in our mouths as household words" are much appreciated. Their papers are almost certain to be out of the ordinary beaten track. Far too many tell us over and over again what we are familiar with, and in consequence of this, instead of looking to the titles of papers and reading those which are most attractive first, the signatures are looked for, and the articles of the most original writers are "devoured with the greed of a wolf," as a friend of mine in Wales expressed it recently in a letter to me.—A FIFESHIRE GARDENER.

ROSES ON THEIR OWN ROOTS.

WHILE not claiming to be an exhibitor of the Rose, or a great rosarian, I should like to give my experience for what it is worth. For the past few years I have, on a small scale, struck and grown Roses on their own roots with good results. I cannot agree with "A. F. M." (page 338) that Roses raised from cuttings make little or no growth the first year, for the finest blooms I had last season were from cuttings struck the previous autumn. Some of the plants were planted out, while others were potted in 32-size pots and plunged. Those that were planted out have now been lifted and replanted where they are to remain, and look everything that can be desired. They made growths varying in height up to 4 feet, according to the variety; those that were in pots were cut back and are nearly in bloom. One plant of Dr. Andry has eleven buds now expanding, and the blooms promise to be very fine. They occupy the same pots they were plunged in. I have not tried the particular varieties mentioned by "A. F. M." All that I have tried have done well. My experience being limited with Roses worked on stocks other than the common Briar as standards or half-standards, I will not attempt to argue on the question of stocks, but I think standard Roses should be found

in suitable places on all lawns. The method of striking Roses from cuttings has been fully described by Mr. Wm. Taylor in the pages of this Journal, and his practice, if followed carefully, will result in success. I will, if space is available, willingly give my experience on the propagation of Roses from cuttings, though I would rather an abler pen than mine undertake the task.—
A. J. SANDERS.

[Please do so, we are always ready to find space for records of successful practice.]

WHILE I do not claim the title of "rosarian," nor proclaim myself an "authority" on Roses, I am not without experience both as regards raising the plants and estimating the merits of blooms at exhibitions. Although not a great competitor, I have had something to do with Rose shows, having assisted in awarding prizes to such giants in the Rose world as Messrs. Cranston and Canon Hole. I have also budded thousands of Briar and Manetti stocks, and raised hundreds of Roses from cuttings. I have travelled somewhat widely too, and observed the work of others. Therefore I venture to attempt a reply to the letter of "A. F. M.," who on page 338 has made out the strongest case in favour of Roses budded on other stocks as against plants raised from cuttings that, so far as I know, has yet been published.

Before proceeding further I may, perhaps, say that I cannot agree fully with either "A. F. M." nor Mr. Simons; but I think the last-named gentleman is in the main right. There are some Roses that succeed better on stocks than otherwise, and amongst them I find Marie Cointet and Xavier Olibo as named by "A. F. M.;" but the majority of Hybrid Perpetuals succeed as well one way as the other, while those raised from cuttings are the safer.

I have seen Tea Roses on their own roots produce blooms equal to the best that have been staged at the National Rose Society's Shows, these blooms having been sent to me by Mr. Taylor of Longleat. I have seen Hybrid Perpetual plants at Longleat two years from the cutting larger than any I have seen of the same age in any nursery or private garden, counting from the date at which cuttings of the Briar or Manetti stocks were inserted. This is a perfectly fair mode of computing time, indeed the only fair one in estimating the relative earliness or maturity of the two kinds of plants. I could name another garden that at the present moment contains a large number of Roses raised from cuttings that in three years have produced more "timber" than any budded plants that I know in the same period, and of these I have inspected at the least a million.

Why should not such marvellously strong own-root Roses produce blooms equal in size and quality to those afforded by plants worked on any stock? In my experience they produce them in every way as good, and I confess I should be very much surprised if they did not. Roses have their caprices I know, and vegetation its vagaries, and opposite results to those just mentioned may have been obtained by others, but if so they must be considered very strange and unusual nevertheless.

New Roses and scarce varieties must, of course, be increased by budding; on this point the argument of "A. F. M." is impregnable, as by no other process can a stock of plants be raised so quickly; and, well grown, they will be as good as the most fastidious could require. But when, as is undoubtedly the case, cartloads of Rose "prunings" are burned annually, there could be no waste of material in making the prunings into cuttings and striking them. By the one practice we have plants, by the other wood ashes, and in such a case the "economy" of the matter is, in my view, on the side of inserting the cuttings.

As to the greater certainty of success in budding than in striking cuttings your able correspondent is, generally speaking, probably right; but at the same time he will perhaps admit that there is no more difficulty in striking cuttings of John Hopper, La France, Alfred Colomb, and Gloire de Dijon than there is rooting portions of Briar and Manetti growths, and this after all is the real question for the purpose of comparing the two methods of increase.

The success in covering the front of the house with the charming Roses enumerated by "A. F. M." is highly gratifying. I have in the case of two of the Roses named—Maréchal Niel and Belle Lyonnaise—covered a space of 25 feet in three years from inserting the cuttings; but not in "poor" soil, and in the rectory case in question there was Rose food in the ground before the plants could have appropriated it and expressed their appreciation in such a convincing manner.

The remarks on the page quoted on the method of increasing Peaches, Plums, and Apples are not applicable to this discussion, as those fruits cannot be raised from cuttings, while Roses can be without any difficulty; in fact, when I insert a Rose cutting in

the soil it is with the same certainty that it will grow as if I were inserting a bud in a stock.

As criticism, even contradiction, was invited by "A. F. M." at the close of his pleasant contribution, I have endeavoured to reply not so much as an exhibitor of Roses as a cultivator and—
A JUDGE.

IVY ON HOUSES.

VARIOUS opinions are expressed as the desirability of having houses covered with Ivy. Many persons entertain the idea that it causes a dampness in the walls, while others are of a contrary opinion. Anyone in doubt on the subject may soon satisfy himself. Let him examine a wall closely covered while a moderately heavy rain is driving against it, and he will find the wet running off one leaf on to another till it reaches the bottom; and if he examine the wall after a wet day it will generally be found to be comparatively dry, as will also the soil at the bottom of the wall. For houses built of soft sandstone or porous bricks I think it is a decided advantage to cover them with Ivy.

My present object in writing, however, is not so much to advocate its use as to warn those who have to keep it against letting it run wild in its early or any subsequent stage of its growth. Many matters of importance have to be considered in keeping it within bounds. Sometimes the young shoots are blown away from the wall and afterwards take a fresh hold, while the part not having hold forms a loop through which an arm may be passed, and which, at some subsequent pruning, is cut, and the branch dies in consequence.

Care has to be taken not to allow the shoots to get between the wall and the down pipes from the roof, also from getting under the slates, or too close round the windows. Any of these, if neglected while the Ivy is covering the walls, prove a serious inconvenience in after years. Another great mistake is often made in allowing it to grow year after year without cutting till it forms long spurs. In such a state it becomes a nuisance. The old leaves keep dropping the whole summer, and making a litter where everything has to be kept tidy; and this is made worse by its giving extra shelter and encouragement for sparrows, and even rats sometimes make this the means of their getting into a house by the roof when they cannot find a more convenient entrance.

For this last three years we have been gradually reducing Ivy on a house which had been neglected till it was quite 3 feet deep on the walls. Our employer, though he wished to have it reduced, would by no means allow it to be cut clear back at once as some would have done; neither do I think it would have been advisable to do so, as the whole of the subsequent growth would have to spring from dormant buds. The first year we thinned out the longest of the shoots, cutting them with the knife as far back as we could reach. In the course of the season these broke and formed nice tufts of short shoots. The next spring the long spurs were pruned back some 6 inches shorter than those cut the previous year, and the third year those cut back first were again shortened to within a few inches of the wall. Thus we accomplished our object without incurring the unpleasantness of a bare wall for a couple of months, and the trying ordeal of producing a crop of shoots from dormant buds.

I think the best way to keep Ivy is to cut the whole of the old leaves off every spring as soon as it begins to grow. Some object to this on account of its looking bare for a time, but it soon assumes a beautiful fresh green colour, the growth being short and stout, and there is no more trouble as to litter. This annual pruning also gives the opportunity of removing or nailing all shoots that do not take a proper hold of the wall, and of otherwise regulating the leading shoots so as to form a close covering.—R. INGLIS.

VENTILATING.

THIS is a subject of importance, and one in which all practical men are interested; nevertheless, it is difficult to lay down hard-and-fast lines when and how ventilating should be done. Locality and varying circumstances that the majority of horticulturists have to contend with alter cases very much. Your able correspondent "J. J." on this subject (page 318) sets plant-growing entirely on one side, and confines his remarks to the cultivation of Cucumbers with or without air. That these can be grown to perfection without the admission of air from the time the seed is sown—whether summer or winter—until the time they have done fruiting and are cleared out, no one acquainted with the system will deny. But how can we draw any comparison between the system practised by growers for market and that followed by the majority of private growers? The objects of the two are so different—one requires quantity with the least possible labour and

expenditure, the other simply sufficient to supply the requirements of the family he serves. The space even for this has to be as limited as possible, as perhaps Melons, Tomatoes, French Beans, Strawberries, and a host of plants for various decorative purposes have to be raised in the same house; and I ask, How would the non-ventilating system answer with this medley? I daresay Mr. Iggulden is situated similarly to many others, and has to supply a variety of produce from the same house, and naturally drew his conclusions from practical experience. If I had a small house I could devote entirely to Cucumbers I should most decidedly adopt the non-ventilating system, as I know no other could produce more satisfactory results; but taking into consideration that the above have to be grown in the same house with Cucumbers, I can say from experience that this system would not do.

"J. J." refers to a grower who commences cutting at Christmas, and he says, "The same plants continue to produce heavy crops of fine fruit until the following autumn." Now this embodies a point I have asked information upon in an article upon growing Cucumbers without air. Will the plants last and continue producing these heavy crops without air as long as they would under a judicious system of ventilating and cropping? From what "J. J." says they evidently do, and perhaps he will tell us more on this point. I am so interested in this part of the subject that I would make a pilgrimage any reasonable distance to see plants that commence fruiting at the time named by "J. J.," and will continue bearing heavy crops until autumn. To give me a chance of satisfying myself on the heavy cropping and lasting properties of Cucumbers grown without air, perhaps "J. J." will kindly communicate with me either directly or through the Editor—if the latter is preferable—the address of the grower who achieves such success.—WM. BARDNEY.

ERYTHRONIUM GRANDIFLORUM.

THE common "Dog's-tooth Violet," *Erythronium Dens-canis*, is a favourite with all lovers of hardy plants, and the "large-flowered" species has nearly an equal popularity, but deserves to be still more widely known. At Mr. T. S. Ware's nursery, Tottenham, we recently noticed a large bed of this *Erythronium*, and the beautiful effect, especially in contrast with several other beds of the older species in variety, was sufficient to recommend the plant most strongly. It is well known that most members of this genus produce their flowers singly, but in *E. grandiflorum* we have a spike or raceme bearing three, four, or more creamy white flowers of good size. There has been some confusion between this and *E. giganteum*, but they are quite distinct and very easily recognised. On April 26th, 1881, G. F. Wilson, Esq., of Weybridge, exhibited flowers of both species at South Kensington, and was awarded a certificate for *E. giganteum*. In a note appended to them he observed that they were quite distinct, the latter named "having only one flower to the stem, the flower being also of different shape, colour, and marking." It is, indeed, much larger, pure white, with a ring of red in the centre. A coloured figure of the plant, described by Pursh as *E. grandiflorum*, was given in the "Botanical Register" in 1836, but the flowers are smaller, bright yellow with red anthers—very different from Mr. Ware's plant. Under the same plate reference is made to another also, found by Mr. Douglas, and described as having "an irregularly branched scape." This is named *E. giganteum*, whereas the one now grown under that name has only "one flower on a stem," as Mr. Wilson has stated.

E. grandiflorum is a thoroughly useful plant, free, and easily grown in any moist shady border if the soil is not too heavy. A variety named *albiflorum*, rather dwarfer and later in flowering, also grown in Mr. Ware's collection, is a pretty companion for the above. The woodcut (fig. 89) shows a spike and leaf of nearly their natural size.

PANSIES AND INSECTICIDES.—"Can you or any of the readers of the *Journal of Horticulture* tell me if there is any way of eradicating green fly and red fly from Pansies? Quassia chips and soft soap or Gishurst compound some persons say will answer. To that let me reply that if plants are syringed with the former they will not recover the effects of it the whole season. The latter, too, I applied to a Pansy in a pot about a month ago—and not a strong solution either—moreover, the plant was dipped in clean water afterwards, with the result that every bud, large and small, is injured more or less. The plants are very strong and healthy, and others to which I have applied no wash are flowering very freely and bearing large flowers, some of Monarch quite 3 inches in diameter; so I have no reason to think that the insects are encouraged by poor growth.—A READER." [We print this letter in order that Pansy growers may possibly be able to give the information desired. We have syringed Pansies with quassia water without any injury resulting. Perhaps a solution of

hellebore (see reply to a correspondent, "W. T. W.," on page 393 might be safe and effectual.]

SOUVENIR D'UN AMI ROSE.

I AM sending you herewith a few blooms of that (to my mind) exquisite and little grown Tea-scented Rose *Souvenir d'un Ami*. The blooms were gathered from a large plant, which is planted



Fig. 89.—*Erythronium grandiflorum*.

out and growing vigorously against a back wall in one of the late vinerias here. We employ no fire heat in winter except to prevent frost from injuring bedding and other plants which stern necessity compels us to store therein, yet this Rose has yielded an almost constant supply of its charming buds for months past. I have to-day cut several dozen blooms similar to those I am sending you, and still the plant is full of buds in various stages of development.

Judging from this it would appear that this variety would prove an excellent one for planting out in cool houses for affording a supply of buds during the early spring months. Here it is a favourite with everyone, and succeeds far better than *Maréchal Niel* and *Gloire de Dijon*. We have large plants of the two latter varieties, but these are planted out and trained up the roof of a large winter garden. These, although very large plants, do not seem to thrive so well, or rather bloom so satisfactorily, as I would wish. As, however, I only took charge of these early in the present year, I have not been able to examine the roots, where I suspect the mischief lies. We intend removing the *Gloire de Dijon* and planting another *Souvenir d'un Ami*. I should be glad to know your opinion on the merits of the blooms sent.—T. W. SANDERS.

[They are very fine examples of a beautiful Rose that might with advantage be more extensively grown in the manner suggested.]



At a General Meeting of the ROYAL HORTICULTURAL SOCIETY, held last Tuesday, Col. R. Trevor Clarke in the chair, the following candidates were elected Fellows—viz., A. C. Adam, Mrs. Barton (senior), Alfred Edward Bingemann, W. Campbell, Major-General J. Cockburn Hood, Frank Crisp, LL.B., F.L.S.; Gaston Chandon de Briailles, Miss de Leon, Miss A. de Leon, The Rev. C. Wolley Dod, Edward Hilliard, Edward Morell Holmes, F.L.S.; W. H. Johnson, Mrs. G. W. Maxwell, Miss E. Newcome, William Sherwin, Robert Ward.

— RELATIVE to the generous offer of 50,000 trees to aid in the project of RE-AFFORESTING IN IRELAND, as recorded last week, our correspondent Mr. Brace, Salbris, desires us to say that his partner, Mr. Daniel Cannon, joins him in presenting the trees in question. We should have mentioned this in our article, but were quite unable to decipher this gentleman's name.

— A SURREY correspondent suggests that notes from various districts on the effects of the late changeable weather on vegetation, and especially information on the PROSPECTS OF THE FRUIT CROPS, would be welcome to him, and doubtless to other readers. We will readily publish such notes as those indicated, and we are not without hope that owing to the lateness of the fruit blossom this year that the Apple crop, especially, will be better than the crops of the past few years; at the same time we have more than once known the most promising of fruit crops ruined after the middle of May. The Apple blossom at Chiswick is now expanding, and the trees being laden, as were the Pears, the garden has a most attractive appearance.

— A CORRESPONDENT describes five pans of NARCISSUS BULBOCODIUM, as exhibited at Rochdale last week by Mr. Barlow, as being simply magnificent; and he further observes, "You refer in the Journal to Mr. Douglas's plants at the Royal Botanic Society's Show with their thirty or forty flowers each, creating quite a little furore. To this I may reply that if these five pans with their hundreds of flowers had been exhibited at the same place they would have caused quite a lively sensation."

— THE ROYAL BOTANIC SOCIETY'S EVENING FÊTE will be held on June 27th, when also an exhibition of FLORAL DECORATIONS will take place. In the latter the prizes will comprise three—£10, £7, and £3 for floral decorations for a room, a tent being set apart for each exhibition. Other prizes value £5 to 10s. will be offered for table decorations, groups of plants, baskets of flowers, bouquets, &c.

— BEFORE us is a box of CALCEOLARIA BLOOMS from Mrs. Babington, Glendermott Rectory, Londonderry, who appears quite proud of her achievement of raising a hundred fine plants from a packet of seed procured from Messrs. Carter, High Holborn. The blooms are very diversified and beautiful, and the plants have evidently been admirably grown, rendering her greenhouse "like a flower show."

— A CORRESPONDENT asks if we do not think Mr. J. Taylor (see page 323) made a mistake when he said he was gathering fruit of *Vicomtesse Hericart de Thury* Strawberry 1½ oz. in weight. We can only say we made no mistake in publishing the note referred to, and if Mr. Taylor has not in writing it the fruit was extremely fine. We do not remember having seen fruits of the variety in question weighing 1½ oz. in the middle of April, but we are not prepared to assert that no such fruit has been produced.

— WE have received a box of SEEDLING PANSIES from Mr. William Hawley of Ash, Surrey, all of which are beautiful, and many of them of excellent quality. The plants grow and flower so freely that our correspondent is able to gather a peck basketful at a time and send them to the hospitals. Most of them are of the fancy varieties, and the seed, supplied by Messrs. Veitch, Chelsea, and Suttons, Reading, was sown last June. It is thus very easy to render a garden gay and hospitals cheerful with these effective flowers.

— THE CARDIFF ROSE SOCIETY will hold their third annual Exhibition in the Drill Hall, Cardiff, on Wednesday, June 27th. In addition to liberal prizes in twenty-two classes provided by the Society, special prizes are offered by the following—The Marquis of Bute, Cranston's Nursery and Seed Company, the Mayor of Cardiff, Colonel Page, James Ware, Esq., Mr. Stephen Treseder, Mr. Crossling, Mr. Thomas, and F. Case, Esq.

— MR. B. S. WILLIAMS, Upper Holloway, sends us blooms of POLYANTHUSES, very dark, with a neat gold lacing round the petals and a rich orange centre. They represent a very good and carefully selected strain of these favourite flowers.

— WE omitted to notice in our report of the AURICULA SOCIETY'S NORTHERN SHOW that the premier Auricula, a splendid example of Headly's George Lightbody, containing nine pips, was shown by Mr. R. Kyrke Penson, and was grown, if we mistake not, by the daughter of that gentleman.

— A NEW and enlarged series of the "Journal of Forestry" has now been commenced under the title of "Forestry," and the issue for the present month contains a good variety of interesting and useful matter. In addition to copious editorial notes there are articles on Lord Somerville, the Contents of Ten Acres, the Beauties of British Trees, Forest Rambles, Bark and Bark-stripping, An Old English Park, Reviews of Books, Provincial Notes, &c. It continues under the able editorship of Mr. Francis George Heath.

— THE WEATHER has been severe again at intervals, the wind veering from north to east, and on several mornings during the past week several degrees of frost have been registered to the west of London. On Friday and Saturday last the temperature fell to 29° and 28° respectively. On Friday also a hailstorm of short duration was experienced in several districts. Towards the close of April the weather was very severe in Scotland, snow having fallen heavily in the north, the high mountain ranges being covered with fresh snow from summit to base. Vegetation has been greatly checked there. In the south the Pear trees do not appear to have suffered much as far as can be seen at present. Another change has now occurred, the temperature is much higher, with frequent rains.

— THE KINGSTON AND SURBITON HORTICULTURAL SOCIETY will hold their nineteenth annual Show at The Woodbines, Kingston, on Thursday and Friday, July 5th and 6th, when prizes will be offered in ninety-nine classes for plants, flowers, fruits, and vegetables. The classes are in five sections—open, local, single-handed gardeners, amateurs, and cottagers.

— OUR attention has been called to the following remarkable statement concerning the price of POTATOES AT THE ANTIPODES. The West Australian *Inquirer* of March 14th says:—"This week Potatoes have been sold wholesale at the extraordinary price of £21 10s. per ton, and yet our small farmers declare they cannot obtain a decent living. How is this?" In Tasmania in 1867 it is said the Potatoes were so plentiful that farmers in some cases carted their produce into the sea, the market being glutted.

— MR. MALLENDER, The Gardens, Hodsock Priory, Work-sop, Notts, sends us the following record of THE WEATHER IN APRIL:—"Sunshine during the month, 131.7 hours, or 32 per cent. of possible duration—rather less than in the Aprils of the last two years. We had eleven bright and three sunless days. No rain fell during the first fortnight, but nearly 2 inches were registered during the last few days. Showers of hail, snow, and sleet fell on the 23rd. Total rainfall, 2.65 inches; maximum fall in twenty-four hours (on 28th) 0.88; rain fell on eleven days. The temperature was above the average during the first fortnight, but low the later part of the month. The maximum on the 4th was 66.5, which is higher than has been recorded here in April since 1876. Mean temperature of month, 46.0°; mean temperature of air at 9 A.M., 47.3°; mean temperature of soil 1 foot deep, 45.5°. Frosts have been frequent. The mercury of the thermometers on grass fell below 32° on fourteen nights, and in the shade on six nights. The season is very backward, and crops are growing very slowly."

— THE CATERHAM HORTICULTURAL AND COTTAGE GARDENERS' SOCIETY'S fifth annual Show will be held on Wednesday, July 25th, but the place has not yet been settled. Numerous prizes are offered in seventy-four classes.

— THE *Rochdale Observer*, after describing the success as an exhibitor of Auriculas of Mr. Richard Heys of Norden, at Manchester and Rochdale, and exhibiting for the first time at the last-named show his seedling Auricula Norden Hero, remarks:—"Looking at the specimens from the wall was the likeness of the late Jane Clough of Bagslate (aunt to Mr. Heys), clutching tightly a flower pot containing a favourite plant; bearing out the remark oft repeated in the room that she was a 'terrible Auricula grower for sure.'"

— THE *Ceylon Observer* gives the following graphic description of the SCENERY NEAR COLOMBO in the Polgahawela-Kurunegala district:—"The view from the highest points of Udapolla is very beautiful. Standing on a knoll, and looking down as the sunset spreading a rich glow over the landscape around, at our feet lay the sheet of dark-green Coffee covered with crop and blossom, from which a delightful perfume arose, while wider apart the rows of Cocoa were beautifully contrasting their pale green and delicate pink leaves with those of the Coffee; farther away lay the paddy of the native villagers partly cut; the cattle grazing lazily on the rich store of succulent grass, hitherto forbidden, but to-day laid open by the sickle of the shearer; and partly covered with a bountiful crop of ripe golden grain, which shall in a few days be all cut and stored; here and there the smoke from the houses of the villagers curled slowly upwards in the still evening air, the houses themselves hidden in tops of graceful Palm trees, while the clearly defined outline of the Kurunegala hills in the background, reflecting the last glances

of the setting sun, completed a picture of singular variety and beauty."

— AT a recent meeting of the Royal Society Sir Joseph Hooker exhibited some ANCIENT EGYPTIAN GARLANDS he had received from Dr. Schweinfurth. They were from the tombs of Rameses II. and other kings, whose mummies were recently found at Thebes. These garlands are chiefly formed of leaves of *Mimusops Schimperii*, and petals of *Nymphaea coerulea* and *Lotus* sewn together with fibres of Date leaf; others of the leaves of *Salix Safrax*, with pods and flowers of *Acacia nilotica*, *Sesbania ægyptiaca*, and *Carthamus tinctorius*, and petals of *Alcea ficifolia*.

— THE florists' shops in Covent Garden Market usually contain some most tasteful BOUQUETS, but occasionally they display some with very remote pretensions to beauty. An example of the latter kind we observed a few days since, which deserves notice only that it may be avoided. A number of handsome Camellias, white Roses, white Azaleas, Gardenias, Stephanotis, and Lilies of the Valley were arranged in a bouquet with a few yellow Polyanthus Narcissus, and would have been all that could be desired alone. Unfortunately, however, the whole effect was completely spoiled by a ring of *Erica Cavendishiana* blooms, which at the best are by no means suitable for delicate bouquets; but when dull-coloured, as these were, and possessing quite a greenish tinge, they had a most obnoxious dingy appearance. In striking contrast to this was a wreath of choice white flowers, with a few blooms of a large dark violet Pansy, which had a most pleasing effect. A bouquet in the æsthetic style was also notable. It was composed of *Maréchal Niel* Roses, *Etoile d'Or* Chrysanthemums, *Bulbocodiums*, *Dendrobium densiflorum*, and other yellow flowers, with a number of small bronzy Ivy leaves and a few Fern fronds.

— IN one of the fruiterers' shops in Covent Garden we recently noticed some fruits of the MURUCUJA, also known as the Laurel-leaved Granadilla, *Pomme de Liane*, Honeysuckle and Water Lemon. These are the produce of *Passiflora lauriflora*, which is found in the West Indies and South America. The plant is much cultivated for the sake of its fruit, which is about the size of a hen's egg, but rather more elongated, and tapering equally at both ends; when ripe, it is yellow and dotted over with white spots. It contains a whitish watery pulp, which, in the West Indies, is usually sucked through a small hole made in the rind, which is tough, soft, and thin; the juice has a peculiar aromatic flavour and delicately acid. It is very agreeable to the taste, and is much relished by Europeans as well as by the natives. It quenches thirst, allays heat, induces an appetite, and elevates the spirits.

— THE BRAINTREE AND BOCKING HORTICULTURAL SOCIETY will hold an Exhibition of plants, flowers, and fruits in the grounds of Bocking Place, Braintree, the seat of Sydney Courtauld, Esq., on July 12th. In addition to prizes in sixty-one classes, special prizes comprising two silver cups, value each three guineas, will be given for collections of stove and greenhouse plants.

— IN addition to the exhibitors in the HORTICULTURAL SECTION of the FURNITURE TRADES EXHIBITION in the Agricultural Hall, recorded last week, are Messrs. J. G. Rollins & Son, Old Swan Wharf, London Bridge, lawn mowers; W. S. Deards, patent boiler works, Harlow, Essex; Reynolds & Co., wirework manufacturers, 57, New Compton Street, London; the "Simplex" (Patent Leaf-lifter) Company, Goudhurst, Kent; Dodds & Robb, horticultural builders, 124, City Road, London; Deane & Co. 46, King William Street, London Bridge, garden furniture; H. G. Smythe, horticultural sundriesman, 17a, Coal Yard, Drury

Lane, London; Grover & Co., Buttermen Works, City Road, London, simplex glazing; Hooper & Co., Covent Garden; the East London Rubber Company, 3, Great Eastern Street, London, E.C., garden hose; and the executors of the late Henry Inman, Stretford, Manchester, rustic garden-house builders. The exhibition remains open over the Whitsuntide holidays, and is well worth inspection by visitors to the metropolis.

ROYAL HORTICULTURAL SOCIETY.

MAY 8TH.

A MOST interesting meeting was held on Tuesday last, the exhibits being numerous and of great merit. The Berkhamstead Roses, the Slough Pelargoniums, and the Orchids were all features of considerable importance.

FRUIT COMMITTEE.—Harry J. Veitch, Esq., in the chair. There were also present Messrs. John Lee, Lewis A. Killick, H. Howcroft, G. Bunyard, G. Rutland, James Smith, Phillip Crowley, T. Francis Rivers, and Dr. Hogg. Messrs. Rivers & Son, Sawbridgeworth, obtained a first-class certificate for *Peach Alexandra*, the fruits shown being of good size and colour for this time of the year. This is an American variety, and the finest early Peach in cultivation. Mr. Allan, gardener to Lord Suffield, Gunton Park, Norwich, had four fine fruits of Hero of Lockinge Melon well ripened. Messrs. Carter and Co., High Holborn, sent samples of Carter's Golden Queen of Como Onions, which were shown on November 14th, 1882, and shown again on this occasion to prove their keeping qualities. They were fresh and firm. Mr. Todman, gardener to J. Connell, Esq., Bushy Downs, Tooting Common, sent specimens of a French Bean, the Tooting Early Prolific, with long narrow pods. It was referred to Chiswick for trial. A first-class certificate was awarded for *Spinach Monstruosa Viroflay* from the Society's gardens, a variety with enormous leaves a foot long by 6 to 8 inches broad. Messrs. Sutton and Sons, Reading, sent specimens of a new seedling Cucumber, a cross between Blue Gown and Kirklees Hall Defiance. The fruits were long, even, with a few white spines; very good, but not distinct enough for a special award. A collection of varieties of *Rhubarb* was sent from Chiswick, comprising Stott's Monarch, Linnaeus, Palmatum, Victoria, Hawke's Champagne, Dancer's Early Red, Baldrey's Scarlet Defiance, Carter's Crimson Perfection, Buck's Early Red, and Johnston's St. Martin's. A cultural commendation was awarded to Mr. Stevens, Trentham Gardens, for two dishes of Cherries, well-ripened examples, white and black, but unnamed.

FLORAL COMMITTEE.—G. F. Wilson, Esq., in the chair. There were also present Messrs. T. Moore, J. Laing, W. Bealby, Shirley Hibberd, John Wills, James McIntosh, H. Bennett, J. James, George Duffield, H. Turner, H. Ballantine, J. Dominy, H. Ebbage, H. Cannell, James Hudson, and W. B. Kellock.

Mr. B. S. Williams, Upper Holloway, contributed a beautiful group, chiefly comprising Orchids, some specimens of considerable size. A plant of *Dendrobium calceolare* had nearly twenty spikes of its large, rich, buff-yellow flowers with rounded petals; *Cypripedium villosum* with two dozen large flowers was also very notable; the long-tailed Lady's Slipper, *Cypripedium caudatum*, with eight large flowers, the petals 2 feet or more in length. The lovely yellow and powerfully fragrant *Anguloa Clowesi* was represented by several good specimens bearing three and four flowers each. The large-flowered *Oncidium Marshalli*, with its broad bright yellow lip, added to the beauty of the group. Other striking plants were *Odontoglossum vexillarium splendens*, having about fifty richly coloured flowers; *Cypripedium barbatum superbum*, with its large purplish blooms; *Masdevallia Harryana grandiflora*, with finely formed rich crimson blooms; and the white *Calanthe veratrifolia*. Amongst new plants shown, *Azalca Phœbus*, with very large double crimson-scarlet flowers, the petals wavy; *Pellionia pulchra*, a neat plant with small leaves marbled with dark and light green; and *Adiantum bipinnatifolium*, with trapeziform pinnules, were very good. A silver-gilt Banksian medal was awarded.

A silver-gilt Banksian medal was awarded to Mr. Charles Turner, Slough, for a fine collection of show and fancy Pelargoniums, very healthy and profusely flowered. Indeed for such a comparatively early period these were uncommonly good. A fine collection of new Azaleas was also staged, several being certificated, and with the Alpine and Show Auriculas constituted a beautiful group, one of the great attractions of the Show. A vote of thanks was accorded to Messrs. S. Dixon & Co., Hackney, for a group of their new Golden Fern *Gymnogramma Laucheana grandiceps*, which has neat tufted fronds thickly sprinkled with golden powder. Messrs. H. Cannell and Sons, Swanley, had a pretty group of plants, specimens of *Heliotrope Swanley Giant*, the double white *Mignonette*, and *Petunia* blooms being very attractive. Mr. J. Aldous, South Kensington, exhibited a graceful and bright group of Azaleas, Pelargoniums, Marguerites, Hydrangeas, Palms, Ferns, and Variegated Maples. Three handsome stands of flowers were also shown, and a bronze Banksian medal was awarded. A silver Banksian medal was awarded to Messrs. Barr and Son, Covent Garden, for an extensive and beautiful collection of

Narcissus flowers, representing a large number of species and varieties, a few Muscari flowers forming a pleasing contrast with them. A bronze Banksian medal was awarded to Mr. R. Dean, Ealing, for a collection of hardy plants, comprising several for which certificates were awarded.

A cultural commendation was awarded to Messrs. Veitch & Sons, Chelsea, for a large specimen of the bright *Impatiens Sultani*, over 2 feet in diameter. Several plants of *Lælia majalis* on blocks were shown by Mr. Clinksberry, gardener to A. J. Hollingsworth, Esq., Forty Hill, Enfield, and well deserved the cultural commendation awarded for them. The flowers were large, the petals and sepals rosy purple, the lip white spotted and margined with crimson purple. A cultural commendation was also awarded to Mr. Bones, gardener to Mrs. McIntosh, Havering Park, Romford, for a large well-grown plant of *Lælia purpurata*, bearing two dozen richly coloured flowers. A vote of thanks was accorded to Mr. Tippins, gardener to J. H. Hope, Esq., 6, Addison Road, W., for large spathes of *Anthurium Schertzerianum*. A similar award was also granted to Messrs. Lucomb, Pince & Co., Exeter, for a plant of *Rhododendron Devonensis*, with abundant white and pink-tinted flowers. A vote of thanks was also granted to G. F. Wilson, Esq., Weybridge, for flowers of *Lilium Thompsonianum* and a spike of *Odontoglossum Andersonianum*, with pale yellow sepals, and petals with rich spots. Mr. George, Putney Heath, sent a truss of the hybrid Ivy-leaved Pelargonium *Future Fame*, which has large flowers like the zonal type.

Messrs. H. Lane & Son, Great Berkhamstead, exhibited a group of handsome Roses in pots—dwarf, compact, vigorous, and well flowered. *Princess Mary of Cambridge*, *Madame Gabriel Luizet*, *Magna Charta*, and *Glory of Waltham* were very fine. The firm also had a group of *Rhododendrons* with a margin of dwarf Azaleas admirably flowered. A silver-gilt Banksian medal was awarded. Mr. J. Graham, Cranford, Middlesex, sent plants of a large-flowered Wallflower, named *Cranford Beauty*; it is of a fine clear yellow colour and very free. Mr. H. James, Castle Nursery, Norwood, sent several Orchids, including *Cattleya Mendelli* and the variety *rosea*, and *Aerides Fieldingi grandis*, a beautiful variety with richly coloured flowers. A vote of thanks was accorded to Mr. Gilbert, gardener to Sir E. G. Moore, Bart., Fetcham Rectory, Leatherhead, for six large and well-coloured *Gloxinia* flowers. Mr. J. Jacques, gardener to J. D. Perrins, Esq., Davenham Bank, Malvern, sent a fine panicle of *Odontoglossum Alexandræ* with white flowers tinted with rose, and a large variety of *Masdevallia Harryana*. A vote of thanks was accorded to Mr. Robert Warner, Broomfield, Chelmsford, for *Masdevallia "distinguo-flora"* with very large Harryana-like flowers. Mr. Arthur Smith, Sheeperton, had a basket of a new *Viola Black Prince*, very dark purple. Mr. Parr, Givons Grove, Leatherhead, showed a plant of *Carnation Annie*, a free variety with streaked rosy flowers. Mr. H. Eckford, Boreatton Park, Baschurch, Salop, sent a collection of seedling *Pansy* flowers, some very large and deeply coloured.

First-class certificates were awarded for the following plants:—

Wormia Burbidgei (Veitch).—A distinct plant with elliptical or obovate leaves, 18 inches long, 9 to 10 inches broad, with short petioles. Two or three large pale yellow flowers 4 inches in diameter are produced on a short inflorescence arising from the stem opposite to the leaves.

Azalea Souvenir de Prince Napoleon (Veitch).—Somewhat suggestive of the well-known *Souvenir de Prince Albert*, but not so distinctly streaked, the colours being chiefly confined to the centre of the petals with an irregular white edge.

Nephrodium Rodigasianum (Williams).—A young plant of this handsome Fern was shown, but did not display the characters of the plant so well as larger specimens do. The fronds are pinnate, 18 inches long; the pinnules narrow, 3 to 4 inches long, with roundish teeth.

Columnnea Kalbreyeri (Veitch).—An extremely distinct plant, the leaves 3 inches broad, tapering, 9 to 14 inches long, curved downwards, deep green on the upper surface and red beneath; the flowers tubular, rich yellow, in close axillary clusters.

Azalea Baron Nathaniel de Rothschild (Veitch).—A double-flowered form of great size, rich purplish crimson, quite a distinct shade in Azaleas, like some *Rhododendrons*. Very free and attractive.

Rhododendron Scarlet Crown (Veitch).—A single-flowered greenhouse hybrid, with extremely large orange-scarlet flowers, the lobes of the corolla broad and rounded. The truss contained nine flowers.

Cymbidium Devonianum (Mr. James, Castle Nursery, Norwood).—A pretty species, with flowers about 2 inches in diameter, the sepals and petals narrow, of a greenish colour spotted with purple, the spots very much darker on the petals. The lip has the point recurved, pale purple, with two lateral blotches of rich dark purple. The spike was about a foot long, with sixteen flowers.

Phalænopsis Sanderiana (Mr. Woolford, gardener to W. Lee, Esq., Leatherhead).—Suggestive of *P. amabilis* in form, but the petals have a slight tinge of crimson, the lip being white with a few red dots at the base.

Masdevallia xanthocorys (Sir Trevor Lawrence).—In the shape of the flowers and its freedom this resembles *M. Shuttleworthii*. A small plant in a 60-size pot had eight flowers. The petals are whitish, the lower ones with pale purple dots, and the upper with darker streaks.

Odontoglossum vexillarium albicans (Sir Trevor Lawrence).—A variety

with nearly pure white flowers, a central dash of crimson relieving the lip, and a shade of crimson at the base of the petals.

Masdevallia rosea (Sir Trevor Lawrence).—An extremely floriferous species, a small plant in a 60-size pot having sixteen flowers. The sepals are very narrow, the upper one being quite filiform. The leaves, too, are rosy purple, the tube being reddish.

Colax jugosus punctata (Woolford).—Sepals and petals white, a few

purple dots on the upper sepals and many on the petals. The lip is streaked with rich violet.

Odontoglossum elegans (Mr. E. Wilson, gardener to H. M. Pollett, Esq., Fernside, Bickley).—A fine Orchid, with branching spikes. The flower somewhat like a large *O. cirrhosum*; the sepals and petals narrow, wavy, nearly white ground, heavily blotched with chocolate.

Auricula Homer (this and the following were shown by Mr. C.

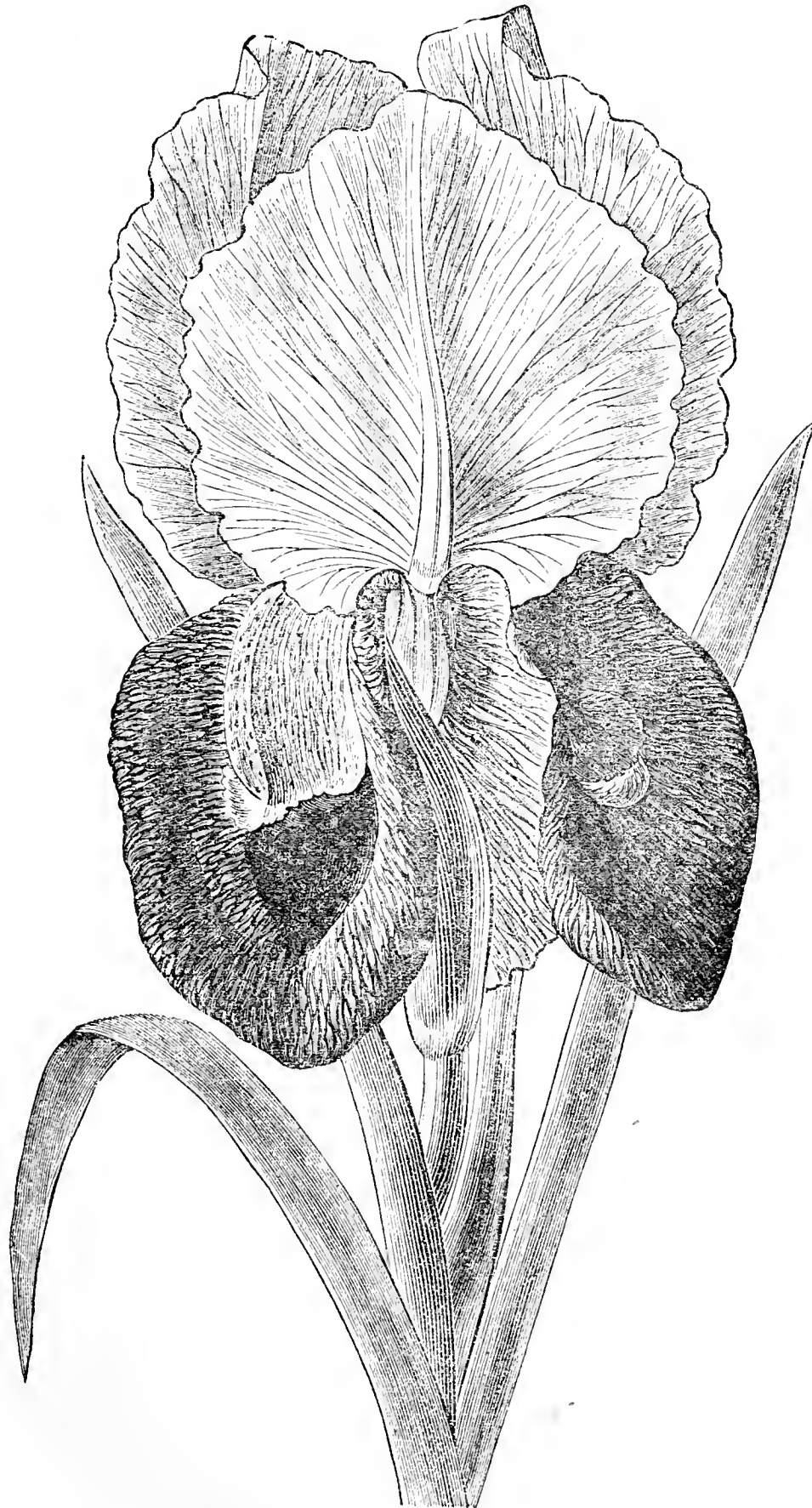

Fig. 90.—IRIS IBERICA (See page 386).

Turner, Slough).—A shaded Alpine, bright crimson, gold centre, fine pip and truss. *Dr. Denny*.—Alpine, black body colour, gold centre, very handsome. *A. Lloyd*.—A shaded Alpine, deep crimson, broad gold centre, very large pip. *Rob Roy*.—A handsome shaded Alpine, dark crimson, pale gold centre. *Roysterer*.—A shaded Alpine, claret crimson, light margin, good gold centre. *Resplendens*.—A beautiful shaded Alpine, warm purplish-crimson, light centre, bold large flower.

Azalea Baron N. de Rothschild (Turner).—The same as Messrs. Veitch's plant.

Azalea Princess Louise (Turner).—A double form, with large salmon-pink flowers; very free.

Azalea Comte de Chambord (Turner).—Similar to the preceding in form, size, and colour, but single.

Heliotrope Swanley Giant (Cannell).—A strong variety, the corymbs of purple flowers nearly a foot in diameter and very fragrant.

Auricula Delicata (Dean).—A peculiar form of the common *Auricula* with large double yellowish flowers.

Mimulus moschatus grandiflorus (Dean).—A dwarf form, with large yellow flowers and compact in habit.

Mimulus Hose-in-Hose (Dean).—Flowers very large, of an orange bronzy colour.

Mimulus moschatus rubra (Dean).—Very dwarf, the flowers of a bronzy brown colour, small, and abundant.

SCIENTIFIC COMMITTEE.—Sir J. D. Hooker, K.C.S.I., in the chair.

Pinus Nordmanniana Discased.—Mr. MacLachlan gave his report on the specimen sent last meeting by Mr. Noble, and considered the insect to be *Chremes corticalis* in a young state, but he required to see the winged form before speaking positively. He recommended the means used in America for destroying the "Orange scale," &c. The most effective appears to be an emulsion, of which the recipe is as follows:—Two parts of refined kerosine and one part of sour cow's milk. Apply as spray by means of a force pump. It must be used at once while the oil and milk are intimately mixed. Or a solution of 1 lb. of whale-oil soap with one gallon of water. Apply as spray while hot, because it solidifies on cooling. Mr. Noble sent a bough which had been treated as above. It certainly had done no damage to the tree, but Mr. MacLachlan could not say for certain whether the eggs had been killed, and recommended a second application as soon as a new brood appeared.

Orange Coccus.—Sir J. D. Hooker showed specimens with a letter from Mr. G. S. Jenman of the Botanic Gardens, George Town, British Guiana, asking for information as to the best method of destroying the pest. It was referred to Mr. MacLachlan for report.

Primulas.—Dr. Hogg observed that he had raised the English Oxlip from seed, and it had come perfectly true. He also raised a seedling of the Bardfield Oxlip. This, however, developed into a Polyanthus of a dull red colour, with all the characteristic form of the English Oxlip. Mr. G. F. Wilson exhibited a yellow Polyanthus of a novel tint, having a greenish centre.

Lilirions.—Mr. Elwes exhibited sprays of three species—*montanum*, *Ledebourianum*, and *tartaricum*, which under cultivation appear to be very nearly identical.

Tulipa undulatifolia.—He exhibited a cultivated specimen to show how it had changed from the wild state as it occurs in Asia Minor. The wild form has the edge of the leaf closely crimped. The leaf is linear, and the flowers one-third the size of the cultivated plant, whereas the leaf shown was broad and had a wavy margin only.

Fritillaries.—He also exhibited flowers from the supposed species *pyrenaica*, *lycica*, *oranensis*, and *lusitanica*, with a small dark-coloured as well as a yellowish-green-flowered seedling. All these Mr. Elwes is inclined to think identical, though *F. bithynica* with green flowers and four large bracts seem very distinct. The question was raised whether the above could not be the result of hybridisation. Mr. Elwes remarked that Lilies were very difficult to hybridise, and he thence inferred that Fritillaries would be similar. Hybrid Lilies always died out very soon.

Iris Hybrid.—Professor M. Foster exhibited a hybrid between *I. Balchana* and *I. Cengialti*, with probably some of *I. pallida* in it. The former has purple and veined flowers, *pallida* being sky blue. This hybrid had the foliage, scape, and spathe of *Balchana*, but the stamens of *pallida*; while the flower was much larger than is *Balchana*. He remarked upon the great difficulty of Irises setting seed unless artificially crossed. Bees appear to be very ineffectual agents. Mr. Elwes remarked that lowness of temperature had often much to do with the setting of seed, especially in the case with Tulips, and observed that they did so with greater freedom in the Mediterranean regions than with us. This was corroborated by Sir J. D. Hooker, who remarked that a relatively small number of plants at Kew seeded well as compared with the great number grown. Dr. Hogg remarked that florists grow a great many whole-coloured Tulips as "breeders," and wait, it may be ten years, before they "break;" and that conversely, if variegated Tulips are not taken up, as was the case in the Botanic Garden at Hull, they revert to self or whole colours. Mr. Henslow remarked that the facility of raising seed from whole-coloured flowers was co-related with the fact that such (as Darwin had shown with *Mimulus* and Carnations) are much better able to fertilise themselves. With reference to variation of colour, Dr. Masters observed that a plant of the common Wood Anemone transplanted to a garden has now turned blue. Mr. Elwes observed that at Bangor four colours occur in the same wood.

Lilium Thompsonianum.—Mr. G. F. Wilson brought a cut spray. The plant has ten spikes, the main one having thirty-five flowers upon it. This is very difficult to blossom unless the bulbils are removed from it.

The Rev. G. Henslow delivered a lecture on Narcissuses, but notes on this we are compelled to reserve until next issue.

EVENING MEETING.

THE first meeting of Fellows of the Society and their friends, held in the rooms of the Linnæan Society at Burlington House, was in all respects a great and gratifying success. One of the rooms contained many small but extremely beautiful collections of plants and cut flowers, the former comprising several rarities from the nursery of Messrs. Veitch & Sons at Chelsea, and a most interesting variety from the Cambridge Botanic Gardens by Mr. Lynch; the flowers including rich boxes of Orchids from Mr. Lee, Downside, Leatherhead,

and splendid assortments of Rhododendrons from Mr. J. H. Mangles, Valewood, Haslemere, Mr. C. M. Major, Cromwell House, Croydon, and the Hon. and Rev. J. T. Boscawen. Mr. Mangles contributed many of his striking hybrids; and Mr. Major had, amongst others, a magnificent truss of the grand *R. Nuttallii* with seven large and handsome flowers. Mr. Barr exhibited his collection of Narcissus in the familiar blacking-bottles, the latter attracting quite as much notice as the former. Mr. E. G. Loder, Floore, Weedon, Northampton, exhibited a most interesting collection of flowers of rare hardy plants, comprising several dozen species and varieties. Mr. W. Thompson, Ipswich, sent flowers of *Heterostoma lobelioides* and *Narcissus bicolor primulinus*; and a tasteful group of plants was shown from the Royal Horticultural Society's Gardens at Chiswick. This small exhibition, however, was but a prelude to the meeting in the lecture hall, which was a crowded and enthusiastic one, the address of the President of the Royal Horticultural Society, Lord Aberdare, and the papers of Professor Foster and Mr. Loder, the observations of Dr. Hogg, Sir Joseph Hooker, Mr. Elwes, Mr. Baker, and others being listened to with great attention and much applauded. Lord Aberdare, after thanking the Linnæan Society for their generosity in granting the use of the rooms, referred to the palmy days of the Royal Horticultural Society, its difficulties, position, and prospects. While he was fully conscious the Commissioners of the Exhibition of 1851 (the trustees of the gardens at South Kensington) would grant the Society all possible facilities for holding their meetings and shows, it was impossible to say to what purposes the gardens would be devoted after the close of the Fisheries Exhibition now being arranged in them, hence it was deemed a prudent course to gain a footing elsewhere, and especially did he urge the importance of renewed efforts being made towards restoring the scientific character of the Society. Towards this end his lordship thought the meetings now being inaugurated will contribute greatly, and he trusted that so satisfactory a commencement would lead to a successful continuance. He then called upon Dr. Michael Foster, Shelford, Cambridge, to read his paper on *Iris susiana*.

Dr. Foster commenced with a brief history of the species as mentioned by Clusius, Parkinson, and others, referred to its geographical distribution, and commented on the singular and striking beauty of the flowers. He regretted that flowers of the true species could not be obtained for exhibition so early, but he showed flowers of *I. iberica* with several varieties, which is closely allied to *I. susiana*, and served to illustrate the distinguishing characters of this group. Before proceeding to that, however, he described at length the structure of an Iris flower, and clearly depicted the difference between the hairs on the falls of the bearded Irises and those in the falls of the group in which *I. susiana* is included. The former, he showed, were aggregated in the centre of the falls, and when examined under the microscope they are seen to be plain and unbranched, while on the falls of the latter the hairs are scattered and furnished with minute projections. What purpose these served he could not state, but that they have an object there is little doubt, and probably connected in some way with the exclusion of insects, such as ants, that would not assist in the fertilisation of the flower, and perhaps prove injurious. Several rare allied species from Turkestan, the borders of Persia, and other districts of Asia, were described and illustrated by coloured drawings executed by Mrs. Foster. The species so noticed included *I. Saari*, *I. paradoxa*, *I. acutiloba*, *I. Heylandiana*, and *I. Korokowi*, which is considered by Dr. Regel one of the most attractive of the group. In conclusion Dr. Foster briefly detailed the culture needed by these Irises, an essential point being the thorough maturation of the plants during summer, which could only be effected by covering them with frames at that season, exposing them fully to the sun, and withholding water for two or three months, removing the frames in September to submit the plants to the rigour of the winter. This would be an approximation to the climatic conditions which prevailed in the districts where they are found, and it is only by attention to these matters that success can be expected. At the conclusion of the lecture Sir Joseph Hooker remarked that he never heard a more lucid and interesting scientific discourse before any Society in Europe, and he complimented Dr. Foster highly upon the manner in which he had treated the subject. In reply to an inquiry by Mr. Baker of Kew as to whether any of the rare species named above are in cultivation in this country, Mr. Elwes observed that he had grown most of them, but they had all died, and he had experienced much difficulty in the cultivation of the group generally. [We reproduce on page 385 a figure admirably representing *Iris iberica*, as exhibited by the lecturer, from a series of articles on the genus published two or three years ago in this Journal.]

Mr. E. G. Loder then read his paper upon hardy Cacti, briefly commenting upon the characters of the order Cactaceæ in comparison with the Crassulaceæ and allied families which may be considered as their representatives in Europe. The variation in form, as shown by the columnar *Cereus*, the globular *Echinocactus* and *Melocactus*, and the flat *Opuntias*, were illustrated by coloured plates of typical species. Attention was then given to the forms which came under the denomination "hardy Cacti," many of which are found in North America, Mexico, and on the Andes of South America, sometimes in districts where the temperature falls to 12° or even 20° below zero, so that they might be reasonably expected to prove hardy here, though they receive less sun heat in the summer. The latter point

was the chief difficulty in their culture, and most of them are benefited by being placed in a frame to make their growth, though such well-known but beautiful species as *Opuntia Rafinesquina* succeeded well in borders on rockeries without any special attention. Walking sticks made from *Opuntia arborescens* were exhibited and attracted much attention, the woody fibre being very hard and curiously interlaced.

Dr. Foster read a communication from Herr Max Leibltn of Baden-Baden upon some rare hardy plants growing in his garden there. One of these mentioned as possessing especial interest was a red *Aubrietia*, which had been obtained from seed of the common blue forms.

Dr. Robert Hogg exhibited a number of Apples received from Australia, and drew attention to the importance of obtaining a supply from that country, if possible, as that would prolong the Apple season until the home produce was in the market, thus furnishing a continuous supply throughout the year. A letter was read from Mr. Neilson, Curator of the Horticultural Gardens, Melbourne, which is printed on page 375. The Apples were very fine, solid, and of good flavour, and were much admired by those present.

In adjourning the meeting until the 12th of June, on which occasion Mr. Goldring's paper on *Cypripediums* will be read, Lord Aberdare observed that he was fully satisfied with the success of the meeting, with which the majority of his hearers fully concurred. A vote of thanks to the Chairman was proposed by Sir Joseph Hooker, who commented upon the importance of attention to scientific matters when steadily and perseveringly pursued, and he could only regard the meeting as a step in the right direction. The motion was seconded by Dr. Hogg, and carried unanimously.

ALPINE SPOILS.

It is the fashion for the many who can afford it to leave the town for a season in order to enjoy a change at the seaside, in the country, or perchance climb the Scottish Bens or the Swiss Alps. That much physical benefit is the outcome we do not hesitate to believe, but that utter weariness is all that large numbers ever experience we know. Often have I seen Londoners and Glasgowians making the tour of the Western Highlands (in one or other of the magnificent steamers that plough their way among the lonely islands of the Hebrides and past the gorgeous scenery of the mainland), lying on their backs in the bright sunlight, enjoying the sweet pure air and—a yellow-backed novel. And as often have we seen them on land trifling instead of enjoying to the full the glorious scenery—instead of eagerly climbing the steep crags and gathering limb power, lung power, and head power; gathering geological or botanical specimens to take back for winter study, the enrichment and adornment of cabinets and herbariums at home, and as reminders of the enchanting tours, exhilarating climbing, and the intoxicating pleasure that came too quickly to a close if they did bring ruddy cheeks and a huge stock of health along with them.

These thoughts were suggested by the sight of a little "Flora Alpina," kindly sent me by a lady to relieve the tedium of a long sickness. Books I love, but even my favourite authors had lost some of their charm. Not so the flowers; these were as fresh and pleasurable as ever, and the little glass by the bedside never grew charmless. But when the dried Alpines were given us with beautiful tiny specimens, the names of which I had long been acquainted with but had never seen, how we did wish that those who spend autumn in the country would only study botany just in a little way, helped by cheery popular books! It is eminently a lady's pursuit, but gentlemen, too, may take to it with advantage. Indeed, among the Alps, or up among the Welsh or Scottish hills, the ladies must often suffer regret at being obliged to return without a coveted beauty, simply because no bold cavalier was by to climb the steep and secure the prize.

And then the chatting and story-telling at night when the specimens are being placed between the sheets of bibulous paper that is used for desiccating them into mummies, the searching for the correct names, and finally the mounting, naming, and arranging of them—perhaps on some stormy day—affords a delight known only to those who have experienced it. Then when the long nights of winter come round, and botanically-inclined friends are our visitors, no treasure we possess will afford half the pleasure as will the turning over leaf after leaf of our summer spoils to while away the hours. Depend upon it, employment alone secures happiness, and of all the employments calculated to make happy, to elevate, to expand the mind, and to benefit the physical man, botany stands first.

But let us peep into this little "Flora Alpina" and see what its contents are, and find the joy of being introduced to plants of which fame has spoken so loudly. The first that comes to hand is the half-golden half sulphur-coloured *Anemone sulphurea*, so beautifully preserved as to prove that the lady whose gentle hand plucked it from its mountain side was no novice at drying

specimens. The next is *Anemone vernalis*, not particularly beautiful in any way, but easily recognised by its woolly hirsute flowers and leaves not at all unlike our own Wood Anemone, which is not the least lovely among its compeers.

After the Anemones are two or three Buttercups with beautiful golden cups and exquisitely cut leaves, not prettier than their near relations, the Buttercups of our own meadows. The first is *Ranunculus glacialis*, evidently a water plant, and possibly replacing in glacier brooks and pools the Marsh Marigold

"Which shines like fire
In the swamps and hollows grey

here at home; only it is a tiny beauty compared with its bigger brother. Not greatly different, but smaller, is the *R. alpestris*; and here is a specimen, still retaining much of its natural hues, of the heavenly blue *Aquilegia alpina*—beautiful even in death.

To name all the beauties in the box might prove wearisome, but we cannot pass by those deep blue gems of the alpine flora, *Gentiana bavarica*, *G. verna*, and the common *G. acaulis*. And we must at least name, if we cannot stop to describe, those neat little plants of the great Pea order, *Trifolium alpinum*, the near relation of our Bog Bean, *Oxytropis campestris*, with its little yellow Lotus-like head; *O. montana*, similar but blue; *Hedysarum obscurum*, Tare-like but small, and *Phaca astragalina*, much in the same way, with flowers yellow tipped with blue, and very small indeed; also *Viola calcarata*, so like our own wild Hearts-ease, but, like the rest of the contents of the box, smaller than its British representative.

Eloydea serotina is worth naming for its Grass-like elegance and its neat yellow blooms, and *Thlaspi rotundifolia* for its lilac-purple heads of bloom, not greatly differing from the Cuckoo Flowers that so greatly delight our own country lads and lasses in May. Sweetest, and perhaps most interesting of all, is a wee plant with the golden flowers of *Primula Auricula*, for here we have the parent of those loveliest of garden flowers that have for generations—nay, centuries—gladdened the hearts of florists all over England and Scotland, and are now more lovely than ever.

Like many of the plants from the Alps, *Achillea nana* boasts beautifully cut silvery leaves, and is altogether an elegant little thing. *Pedicularis versicolor* has just the flowers of a Dead Nettle, and leaves which in their dried state might well be mistaken for fronds of some small *Asplenium*. The little—everything is on a small scale—*Rhododendron ferrugineum* has the unmistakable *Rhododendron* head of flowers. Judging from its leaves we should have pronounced it an Azalea. Evidently it is near the borderland that divides *Rhododendron* from Azalea, if there is indeed a borderland at all.

Geum montanum is just our own *Geum* of the roadside without in this case, which is strange, the silvery foliage which gives one-half its charm. *Gnaphalium dioicum* is a sweet silvery plant 4 inches high, with a head of flowers of a rosy pink colour. Last is its near relation *G. leontopodium*, the far-famed Edelweiss, and a neat little unique beauty it is.

In looking over these, and indeed all collections of plants, the wonderful relations of species to species, of genus to genus, and order to order, strikes us so forcibly that, though we may push our studies indefinitely, a point comes at which we are forced to stand still. It is impossible to separate order from order, and even species from species, and when our researches have reached this point we are like the astronomer. We find that our speculations lead us where we cannot follow, that our minds are finite and the object we are studying infinite, and there still remain secrets behind the veil.—SINGLE-HANDED.

NEWCASTLE SPRING SHOW.

THE above Show was held in the Town Hall and Corn Exchange, Newcastle-on-Tyne, on the 2nd and 3rd inst. The date was a month later than usual, owing to the Society not being able to procure the Town Hall earlier in the season, and consequently the entries were not so numerous as at previous exhibitions, but the quality of the exhibits was in every respect good. The flowering plants and Auriculas were better than in past years. The Hyacinths were both numerous and good, but it was evident that they had been retarded very much by shading. Appended we give the list of the prize-winners according to schedule, commencing with the division "open to all."

STOVE AND GREENHOUSE PLANTS.

In the class for four dissimilar plants four prizes were offered and five collections staged. Mr. Neil Black, gardener to Mrs. Pease, South End, Darlington, was deservedly first with a superior quartette, consisting of a finely coloured *Bougainvillea glabra*, *Anthurium Schertzerianum*, *Clerodendron Balfourianum*, and *Vanda suavis*; the latter was a magnificent specimen, containing sixteen spikes averaging thirteen

flowers each—undoubtedly the premier plant in the Exhibition. Mr. Noble, gardener to Theodore Fry, Esq., Woodside, Darlington, was second with a good *Tetratea hirsuta*, *Erica Victoria*, *Genetyllis tulipifera*, and a *Clerodendron Balfourianum*. Mr. Methven, gardener to E. Large, Esq., Heathfield House, Low Fell, Gateshead, was third, staging good specimens of *Chorozema cordata* and *Erica affinis*. Mr. Watson, Tanfield, was the remaining prizetaker.

Azaleas.—Mr. Methven was first in the class for four plants with fresh-flowered specimens, trained as even pyramids, Mr. Neil Black securing the second prize. *Deutzia* were very good, Mr. Armstrong, nurseryman, Elswick Road, Newcastle, being first, and Mr. Methven second. *Genistas* and *Spiraeas* were also remarkably well shown, as was *Lily of the Valley*, Mr. Watson, followed by Mr. Armstrong, securing the prizes. *Cyclamens* were excellent, Mr. Armstrong was placed first with plants averaging thirty-four flowers each. *Primulas*, as might be expected, had lost their freshness; Mr. Noble secured the first prize; Mr. W. L. Thompson, gardener to M. Bell, Esq., Wolsington, being first for hardy *Primulas*. The table decorative plants were graceful, and suitable for their purpose, Mr. Whiting, gardener to E. Walker, Esq., Shot Tower, Newcastle, being first with elegant plants *Aralia gracillima*, *Pandanus Veitchii*, and *Croton pictus* being amongst the best. Mr. Noble followed in this class.

AURICULAS.

These were a decided feature of the Show. Mr. Pohlman, Parkinson's Lane, was the principal winner in all classes. For twelve Auriculas, not less than nine varieties, Alpines excluded, this exhibitor was first. Amongst his flowers were Simonite's Mrs. Douglas, with seven fine pips; Kayce's Alexander Meiklejohn, six pips; George Lightbody, six pips; and Read's Acme, seven pips. These were much admired by the northern growers, especially Mrs. Douglas, which was so fine a colour. Mr. Thomas E. Hay, Shillingworth Colliery, was second with C. J. Perry, nine pips; Ann Smith, Beauty, and Lancashire Hero. Mr. Adams, Swalwell, third with Stapleford Hero and Charles Perry, being very good. For six dissimilar Mr. Pohlman was first with Garibaldi, eight pips; Regular, Ashworth, and George Lightbody, six pips; and Col. Talbot, eight pips. This, too, was quite a superior stand. Mr. Thomas Hay and Mr. Adams were in the same position as in the preceding case. For four dissimilar Mr. Thomas Hay was first and Mr. Pohlman second. For two dissimilar, one green-edged, one grey-edged, one white-edged, Mr. Pohlman again took premier place in each class. For one self Mr. Thomas Hay was first, as well as for twelve Alpines, Mr. Adams being second. For six Polyanthus, gold-laced, not less than four varieties, Mr. M. Stubbs, Front Street, Winton, was first with Queen of the Tyne. For one gold-laced flower Mr. M. Stubbs was also first with George the Fourth. For six Polyanthus other than gold-laced Mr. Robert Atkinson was first.

BULBOUS PLANTS IN BLOOM.

For twenty-four Hyacinths Mr. W. J. Watson, nurseryman, Newcastle, was first, Blondin, La Grandesse, King of the Blues, and Von Schiller having the best spikes. These were very fine, even, and not drawn. Mr. Dewar, nurseryman, Newcastle, and Mr. Stephen Nairn, Newcastle, were second and third, *Ida*, *Fabiola*, *Gertrude*, and *Emeline* being very fine; the spikes and the foliage of Mr. Dewar's plants being admirably balanced. There were five competitors. For twelve Hyacinths Mr. Watson was again in the premier position the fine plants, we are informed, being grown in Taylor's moss litter manure; also for twelve Tulips, which were excellent. For six double Tulips Mr. Chas. Hockey was first with *Tournesol*, *Rex Rubrorum*, *La Candeur*, *Imperator Rubrorum*, *Duke of York*. The Tulips in all classes were good.

For six Polyanthus *Narcissuses* Mr. Watson was first with good examples of *Grand Monarque*, *Newton*, and *Gloria Superba*.

CUT FLOWERS AND TABLE DECORATIONS.

For twelve bunches of *Azalca* blooms Mr. John Short, gardener to Arthur Pease, Esq., M.P., Hummersknott, Darlington, was first with fine blooms of *Louise de Kerchore*, *Comtesse de Flandres*, *Phœbus*, *Comtesse de Beaufort*, *Daphne*, and *Reine de Portugal*; Mr. McIntyre, gardener to G. Pease, Esq., Woodside, being second with fine blooms. For twelve *Rose* blooms Mr. John McSwinn, gardener to G. W. Rendell, Esq., Condercum House, was first with twelve fine *Maréchal Niels*. Mr. Thomas Pattison, Rose Bank, West Hartlepool, was also awarded first with fine blooms of *President*, *Souvenir d'un Ami*, *Anna Ollivier*, and others. For twelve show Pansies Mr. Robert Atkinson was first, and for twelve Fancy Pansies Mr. Thomas Battensby, Hagg Hill.

Bouquets and Epergnes.—These were arranged in the Town Hall above the Corn Exchange on a large table in the centre of the room. In the middle of the table there were fourteen epergnes, flanked on each side with sixteen bouquets, which gave the room a most charming appearance. For one drawing-room epergne there were four entries. Mr. M. D. Thompson, gardener, Southill, was decidedly first with a graceful arrangement, consisting in the top tier of *Dendrobium nobile*, *Cactuses*, and *Euphorbia jacquiniæflora*; the second tier consisted of *Clematises* light and blue, *Clerodendron Balfourianum* and *Tacsonia Van Volxemi*, the base was margined with *Davallia Mooreana*. There were also some fine spikes of *Oncidiums* used judiciously, but the great charm consisted in a graceful draping of

Lygodium scandens. Mr. Webster, The Grange, Monkwearmouth, Sunderland, was second, also with a very fine epergne, in which *Adiantum gracillimum* was used with much effect. Messrs. Armstrong and Rutherford followed in the remaining places. For one bridal bouquet there were several entries. Mr. W. R. Armstrong was first with an unique combination of *Lily of the Valley*, *Eucharis*, *Roses*, and *Lilies*, all gracefully margined with *Adiantum gracillimum*. Mr. Robert Pattinson, St. Ann's Hill Nursery, Carlisle, was second; and the same exhibitor was first for a hand bouquet, which comprised *Gardenias*, *Dendrobiums*, *Deutzias*, and *Lily of the Valley* tastefully arranged; Mr. Rutherford followed. Buttonhole bouquets were largely represented.

CLASSES OPEN TO ALL EXCEPT NURSERYMEN.

For two Azaleas Mr. M. D. Thompson, South Hill, was first with fine specimens of *Duc de Nassau* and *Leopold I.*, Mr. Methven followed with *Princess Alfred* and *Gladstoni*, both good. *Acacias*, *Dielytra spectabilis*, *Deutzias*, *Genistas*, and *Cinerarias* were also well shown. Mr. Methven was the principal prizetaker. Mr. Noble exhibited some fine specimens of *Mignonette* plants profusely flowered. Mr. Larke, gardener to Rev. R. S. Wheeler, Whitby Vicarage, also contributed well in this section. For twelve Hyacinths Mr. Brown, gardener to Thomas Barnes, Esq., Whitburn, was first with good examples. Tulips, single and double, and Polyanthus were also well represented. Mr. Rutherford took first for an epergne, in which Azaleas, Hyacinths, Gloxiuias, and other spring flowers were used with much effect. The same exhibitor was also first for a hand bouquet.

Not for competition were stands of plants, consisting of greenhouse-flowering, alpine, and hardy *Coniferæ* from Messrs. W. R. Armstrong, nurseryman, Newcastle; W. J. Watson, nurseryman, Fenham; and W. Fell & Co., nurseryman, Hexham, which enhanced the appearance of the Show very much.

The Committee, Secretary, and patrons are to be congratulated on the success of the Society's exhibitions, which are improving the horticulture of the district and commanding more attention year by year.

NOTES ON AURICULAS.

THE severe frosts in March nipped the more forward of the trusses on our plants; but an advantage resulted even from that, as later trusses have been produced and the season of flowering extended in consequence. I think as a rule the quality of the bloom has been better this season. Some varieties, in fact, it would be impossible to improve; such, for example, are *Lovely Ann*, *Dr. Horner*, *Headly's George Lightbody*, *Taylor's Glory*, *Smith's Ne Plus Ultra*, *Robert Trail*, *Sykes' Complete*, *Lancashire Hero*, and *True Briton*. Mrs. Campbell is for the first time, after four years growing, very good with me. Colonel Champneys is not so refined as last year, though on several trusses over twenty pips developed. *Meteor Flag*, *Lord of Lorne*, *Garibaldi*, *Vulcan*, and *Charles J. Perry* also threw up enormous trusses. *Formosa* has been fine, and though small is very pretty. *Trail's Beauty* has been very good, though with me it never develops a white edge.

We have several dozens of plants in 2½-inch pots, offsets of last summer. These are strong, and the pots are full of roots. We shall take an early opportunity of shifting them into 4-inch pots without in any way interfering with the ball in the process. From these plants we are well assured of obtaining good trusses next season. Some of the strongest plants in larger pots will also be shifted into others 5 inches in diameter. None of these has long tap roots, and consequently there is no danger of harm accruing, though they stand another season without examination. Some healthy plants in 5-inch pots will not be touched for another season. There is no fear of their suffering, and we may expect a healthier crop of offsets than if they were shaken out and repotted. From a few plants of which we wish to increase stock rapidly, the growing point has been taken out with a sharp knife. All of these have buds just showing, so that we have a good hope of an increase another season.

The plants which are to be repotted will be attended to in a few weeks. Even at the expense of sacrificing what are apparently healthy roots we cut the tap root well back. It is found much better to employ a smaller pot and get it filled with young and vigorous feeders. Low potting is very necessary with these.

As to the question of soils it has been found best to divide the plants into two sections, the one comprising vigorous-growing sorts, and the other those that are weakly. Most of the selfs, with the grey-edged varieties, go into the first section, with such strong-growing white-edged varieties as *Wright's Emma* and *Lee's Venus*, and in green edges *Litton's Imperator* and *Atlas*; while in the other section we group the great majority of the green and white-edged sorts, with a few of the other classes which do not make much growth. For the vigorous-growing

kinds the compost employed is the same as we use for Roses, Lily of the Valley, and Chrysanthemums. It is composed of loam three parts, and cow manure, dry but fresh, one part. For the weakly growers horse droppings are substituted for the cow manure, and for the very weakly kinds a little coarse sea sand is added. We pot rather firmly. The plants are placed during the summer months at the corner of two tall Holly hedges, the one shading from the sun in the earlier part of the day and the other during the afternoon. As to watering, they get water just when they require it, as we give water to any other plants. Excessive dryness will kill the roots, and excessive wet will render the soil sour, and the plant will succumb.

Those offsets that were taken off the plants in February are now placed into 3-inch pots, and the stronger plants may receive another shift in August into pots a size larger. Such a course is, however, advisable only when the plants are growing very fast, and it is pretty certain that the last shift will be made the most of before winter sets in. The offsets taken from the parent plants just now are most easily managed pricked out into boxes, from which they may be potted in August, or left till spring if room is limited. I see a few good collections in the course of the year, and I notice many growers are possessed of strange fears about their pets. In one I saw the other day the plants were beset with offsets, their owners (not long commenced cultivating Auriculas) being frightened to remove any lest the plants might suffer in consequence. Another I met with where the plants were allowed to become dust-dry before water was given. Yet another had the compost thickly sprinkled with charcoal, and the base of the plant standing on the apex of the convex surface of the soil—this lest the plants might damp off should water touch them. One grower has his plants exhibited in 8-inch pots!—R. P. B.

ROCHDALE AURICULA SOCIETY.

ON Wednesday, the 2nd inst., the first Exhibition of this reorganised Society was held in the Public Hall. There was an excellent assemblage of choice Auriculas and Polyanthus, and, through the kindness of several ladies and gentlemen, a fine display of stove and greenhouse plants. Mr. Samuel Barlow of Stakehill had a grand collection of Azaleas and Rhododendrons on the table immediately in front of the platform. The Azaleas were the best varieties of the mollis type, and the Rhododendrons the sweet-scented forms raised by Mr. Davis of Ormskirk, and beautifully flowered. Amongst his plants were two examples of the double-flowering Raspberry, *Rubus rosæfolius* var. *coronarius*, and five pans of the Hoop-petticoat Narcissus, which were splendid. Mr. Schofield of Buckley Hall, Mrs. King, Sandfield, and Mr. J. H. Lancashire sent good collections of stove and greenhouse plants. Mr. James Horsfall of Healey Nurseries had a collection of Conifers, and in addition a number of fossils; and Messrs. Dickson, Brown & Tait exhibited a stand of cut Hyacinths, for all of which certificates of merit were awarded. The schedule was a long one, and the classes were well filled. The prizes were awarded as follows:—

In the class for six varieties the prizes were won by Messrs. W. Bolton, Warrington, and H. Wilson, Halifax; for four by Messrs. Wilson, Bolton, and Simonite, Sheffield; for pairs by Messrs. J. Fletcher, Bagslate, and R. Heys, Norden; for maiden pairs by Messrs. Fletcher and Heys; for four Alpines by Messrs. J. Beswick, Middleton; Heys, and S. Barlow, Stakehill, in the order named.

Mr. Bolton had the premier green-edged variety—Lancashire Hero, the other prizetakers being Mr. Simonite first with the same variety, Mr. Bolton second and third; Messrs. Barlow, Wilson, and C. M. Royds, Greenhill, taking the remaining prizes. Mr. Wilson showed the premier grey-edged variety—George Lightbody; Mr. Wilson being first and second with Lancashire Hero and Ajax. Mr. Bolton was third and sixth, and Mr. Barlow fourth and fifth. Mr. Wilson also had the premier white-edge—Smiling Beauty; he was first with John Waterston, and second with Acme. Messrs. Bolton, Barlow, and Heys secured the other prizes. Ringdove was the premier self shown by Mr. Bolton, who was also first with Ellen Lancaster, and second with Mrs. Douglas; Messrs. Simonite, Barlow, Bolton, and Royds followed in that order.

In Alpines Mr. Beswick showed the premier—Diadem, Messrs. Heys and Beswick taking the other prizes. Polyanthus and Fancy Auriculas were chiefly shown by Messrs. Beswick, Fletcher, Barlow, Heys, Bolton, and Royds.

Mr. Royds, Greenhill, was awarded a certificate for a beautiful assortment of Primroses, Polyanthus, and Myosotis. A certificate of merit was awarded to a fine seedling self Auricula from Mr. Barlow, and similar awards were made to Mr. James Hill, Reform Street, for a good example of *Aralia elegantissima*, and to Mr. G. W. Schofield for a beautiful specimen of *Oncidium tigrinum*.

COLESHILL HOUSE, HIGHWORTH.

OCCUPYING an elevated position in an extensive, undulating, and finely timbered park, through which flows the winding Cole,

is Coleshill House, the Berkshire residence of the Earl of Radnor. It is a commodious and picturesque building in the Elizabethan style, built by Inigo Jones in 1650. The summit of the roof being flat and enclosed by an ornamental balustrade is large enough to accommodate a regiment of the Royal Berks Volunteers with standing room, the huge stone chimneys and cupola rising from the centre, giving to the whole a bold yet graceful finish. From this roof extensive and delightful views of North Wilts, Gloucestershire, Oxfordshire, and Berkshire are obtained.

From the west-front terrace of the mansion the grounds slope, first with a sharp declivity, then gradually, to the river Cole (from which, in connection with the eminence on which it stands, Coleshill derives its name), whence the ground rises in the direction of Highworth and Sevenampton, which, together with the castle-like homestead of Strathenborough Farm on the Coleshill estate and Squire Hanbury's mansion, make a pretty background to the western side of our picture.

There are five entrance lodges to the park, built of stone and of the same style of architecture as the numerous excellent cottages constituting the village of Coleshill, and provided for the accommodation of those employed on the estate, the principal ones being from Faringdon, Shrivenham, and Highworth, and immediately inside the latter entrance an avenue of fine Limes and Chestnuts leads to the east (carriage) front of the house. A detour to the left conducts us between two massive and elaborately carved stone piers to the "top flower garden"—as calm and tranquil a spot as could be desired, and in which are some fine trees and Rhododendrons, among the former being a few fine English Yews and a remarkably fine specimen of *Taxodium sempervirens* about 60 feet high, having a stem at 3 feet from the ground 11 feet in circumference, while that of the branches, which sweep the velvety turf, is 46 yards—a truly grand tree of the kind. Proceeding southward through the extensive grounds, which are bounded on the east by the Faringdon road, and afford many pleasant peeps of distant scenery, we pass on the way thither a couple of fine piers (similar to those referred to above), and the position of which suggests that another approach to this fine baronial residence is contemplated. From the southern extremity of the grounds, which are divided from the park by a "ha-ha," the summit of which is adorned at short intervals by Laburnums, &c., which in May and June, together with flowering Thorns in the park close by, render a good account of themselves, the eye traverses a large tract of undulating country, including Badbury and White Horse Hill, the sight of which, although now it would involve considerable time and labour to restore the famous steed to his former shape and colour, reminds one forcibly of the descriptive lines—

"Carv'd rudely on the pendent soil is seen
The snow-white courser stretching o'er the green.
The antique figure scan with curious eye,
The glorious monument of victory!
Then England rear'd her long-dejected head,
Then Alfred triumph'd and invasion fled."

The kitchen garden, which is a long strip of ground, and in which the numerous glass houses and sheds, together with the head gardener's convenient cottage, are also located, is not only one of the finest, but also one of the best managed gardens of the kind in the country, being well and judiciously cropped and in capital condition. It is situated a short distance from the house, having as a boundary Faringdon road on the one side, and the private drive to the celebrated Model Farm on the other. It is in five divisions and covers an area of 5 acres. The soil a dark loam, nearly 3 feet deep, resting on a bed of clay, and sloping somewhat sharply to the south and west, being everything that could be desired for the production of first-rate vegetables such as those staged annually by Mr. Haines, the able gardener-in-chief at Coleshill, at South Kensington and other horticultural exhibitions, and on which occasions his name is to be found well to the front. Mr. Haines, like all good kitchen gardeners, has a portion of the garden deeply trenched and liberally manured every year, and to this fact not a little of his success in vegetable-growing may be ascribed. Where everything is so well done it is difficult to particularise, but I may state that Leeks, Celery, and Onions are especially deserving of notice, many individual bulbs of the latter, Reading Improved, turning the scale at 18 ozs., and as hard as a board. Before concluding these brief remarks of the kitchen garden, the walls of which are furnished with an assortment of choice fruit trees, I may state that a central walk from the wicket in the wall adjoining the Faringdon road entrance runs through a series of arches and flights of steps the entire length of the five divisions, and on each side of which are good examples of pyramidally trained Pear trees, and between them, among other herbaceous plants, good clumps of *Campanula pyramidalis*. There was also a good batch of this plant in pots in

the frame ground for grouping with Fuchsias, &c., and for which purpose this *Campanula* is admirably adapted. Apples and bush fruit are also grown in the kitchen garden.

GLASS DEPARTMENT.

All the glass houses, pits, frames, fruit, and store-rooms, together with Mr. Haines' cottage (the porch and walls of which are covered by *Jasminum officinale*, *Wistaria sinensis*, and *Jargonelle Pear*, the stem of the latter being 3 feet round), are, excepting one small range, situate in No. 2 kitchen garden. They consist of three or four vineries, Melon and Cucumber houses, stove and greenhouse, small Orchid house, and Pine pits, and the best and greatest number of cold pits and frames that I have ever before seen in one gardening establishment.

Grapes.—By way of describing the good crops and perfect finish of the Grapes in these fine gardens we would only say that with examples of them Mr. Haines (soon after my visit) carried off first honours at several of the local shows—shows at which exhibitors whose names are associated with the production of first-class Grapes competed. The varieties which Mr. Haines grows are Black Hamburg, Foster's Seedling, Buckland Sweetwater, Madresfield Court, Lady Downe's, Mrs. Pince, Gros Colman, and Muscat of Alexandria, one rod of the latter being especially deserving of notice as illustrating—if illustration be necessary—the manageableness of the Vine, and also as showing how the space occupied by the one under notice could be profitably utilised in many other vineries if necessary. It is planted against the back wall in the centre of a lean-to house 80 feet long and in two divisions. A single rod having been (years since) taken up to the top transversal wire immediately under the ventilators, and trained to it right and left the entire length of both houses, was finishing one hundred compact average-sized bunches to perfection; and although the division in which the Vine is planted had been started several weeks in advance of the one containing its left arm, the only perceptible difference in the quality of the crop, as might be expected, was in colour, the bunches on the "right arm" being, as regards the coveted "amber," slightly in advance of the others.

Melons and Cucumbers.—These are grown mostly in pits and frames, and were in various stages of development, bore ample evidence of skilful management, as also did, among others, well-flowered plants of *Eucharis amazonica*, *Stanhopea tigrina*, *Saccolabium Blumei*, *Imantophyllum miniatum*, Balsams, Begonias, Fuchsias, *Lilium auratum*, &c., and these, being tastefully arranged with Ferns, &c., had a very pleasing effect, which would be supplemented later on by the flowers of Primulas, Cinerarias, Cyclamens, &c., which, in some of the pits in front of the houses, gave promise of a good floral display during the winter and spring months.

The shedding accommodation contiguous to and communicating with the back premises of Mr. Haines' cottage is of such a description as is unfortunately seldom met with in gardening establishments, being substantially built, provided with good doors and windows, and internally fitted up in accordance with the special use of the respective compartments (which communicate with each other) into which this long range is divided so as to afford a proper place for everything; and, judging from the internal condition of the individual sheds, everything would appear to be kept in its proper place.

Waste Water.—In the second division of the kitchen garden, and within easy reach of the numerous forcing houses and pits, is a large ornamental oval-shaped basin of stone and cement, into which all the waste water from tanks occupying higher positions than the former, as also from the roofs of the extensive stables, garden sheds, &c., is conducted through underground pipes. The importance of being provided with a reservoir of this kind in these burning-of-ancestral-mansion days must be apparent to the proprietor of every country mansion. Moreover, the presence of such a reservoir in the garden as the one under notice is not only an ornamental, but also an almost priceless feature in the summer, when during the presence of a spell of dry weather the demand for water often more than exceeds the supply.

Flower Garden.—In addition to the flower beds in the beautiful lawn opposite the west front of the mansion there is ensconced between the second and third divisions of the kitchen garden and thick well-kept hedges of Box and Hornbeam the most cosy flower garden that we have seen for many a day, and whither a private walk through the grounds and a shady bower leads from the house. It consists of fifty beds, geometrically laid out in Box and gravel, and which, together with two raised side borders, were ablaze with a variety of colour, the arrangement of which bore evidence of good taste.

Before concluding these brief notes of the gardens at Coleshill—a place which for a long period has been familiar to your agricultural readers by reason of the cattle and pigs from there being

annually awarded high honours at the Smithfield and Royal Counties Meetings—I would remark that its noble proprietor, who is not only a most popular Master of Foxhounds, but also the best of landlords and masters, takes a great interest in his gardens (the management of which reflects great credit on Mr. Haines), and is a capital judge of their produce.—W. W.



KITCHEN GARDEN.

HITHERTO the work in this department has been chiefly digging, sowing, and planting; but as growth is now advancing, other matters must have timely and proper attention. Work in the flower gardens and pleasure grounds is always pressing at this time, and in attending to this the kitchen garden is very apt to be neglected, much to the disadvantage of the crops. When it rains, or the soil is too wet, all hands are put to cut grass and edge walks, and on a fine dry day hoeing receives chief attention.

Many Peas are requiring stakes now, and they should have timely attention, as nothing is more against the ultimate success of the crop than allowing the young growths to be injured at an early stage of their development. All tall-growing crops, such as Broad Beans, Cabbages, Cauliflowers, Potatoes, &c., should be earthed up. The drag hoe is often used for this work, but a fork is very much better, as it loosens the soil so well and leaves the surface free and open. Turnips, Carrots, Parsnips, and all young plants which have formed five or six rough leaves, should be thinned to 6 inches apart in the rows. Thin sowing of good seed saves much of this work, and it has other advantages. Our practice is only to thin to half the distance at first, and the whole further on. With Turnips, for instance, we would thin now to 6 inches apart, and in ten days again every alternate one would be removed, and as by this time failure from any cause would not be likely to occur, we could rely on having a regular crop. As soon as any thinning has been done the Dutch hoe should be immediately employed to destroy young weeds.

Plant out early Celery in trenches which have been thoroughly manured, and early Brussels Sprouts and Savoys which may be required for special purposes should be planted when the atmosphere is humid and the soil moist. Winter Spinach is now throwing up the flower spikes, and it should be cleared off, the ground well manured and deeply dug, and then planted with Veitch's Autumn Giant Cauliflower. Another sowing of Kidney Beans may be made; indeed, all our Kidney Bean seed will soon be sown, as we find May a most suitable month to sow runners to bear up until frost or cold kills them. Spinach runs fast to flower in hot weather, therefore sow small quantities often now. Between our Gooseberry and Currant bushes is a favourite place for our summer Spinach, as the ground there is generally cool, shady, and suitable.

Asparagus is now coming up satisfactorily, and the best way to secure a full crop and long succession of heads is to cut every one of them as they attain a height of 6 inches or so. When some of the shoots are allowed to run up from the first it is very seldom that all the dormant eyes or buds are induced to grow, and the supply is stopped before it should be, but by cutting all of them every bud is obliged to push forth. Indoor Cucumbers are now bearing most freely, and they are growing so fast that every plant has to be stopped and trained twice weekly to keep them in bounds. The short-spur system is the best for Cucumbers; in fact, no other will do at this season. The same remark applies to Tomatoes, as they must be frequently restricted now, and where they are bearing a full crop liquid manure must be applied unstintingly. A dryness at the root causes the fruits to ripen prematurely, and it also curtails flavour. Mushroom beds formed in cool sheds two months ago are now bearing freely, and others may still be formed. We attach much importance to having the manure in such a condition that it will retain a heat of 70° for at least three months after being made into a bed.

FRUIT FORCING.

Figs.—Early-forced Figs in pots are now ripening, and will be greatly improved by liberal ventilation with a free circulation of warm air and full exposure to the sun, it being impracticable to have highly coloured well-flavoured Figs when the fruit is shaded. Heavy watering at the roots must be avoided, yet suffi-

cient given to keep the roots in a healthy state; and although the use of the syringe over the trees is to be discontinued, damping available surfaces occasionally in bright weather will be very beneficial: even after the ripe fruit has been gathered a moderate syringing will act beneficially and check red spider. All side shoots should be closely pinched to the fourth or fifth leaf, training forward all leading shoots where space admits of extension. Succession crops are making good progress. Former instructions as regards heat, moisture, and stimulants must be adhered to. Syringe well twice a day, and water with tepid liquid manure or warm water, which, passing through a heavy mulching of decayed dung, will act well for the trees. Do not allow the mid-season crops to be too great a strain on the trees, as it is thought they will carry much more fruit than those early forced, which not unfrequently jeopardises the crop.

Cherry House.—Ripe Cherries at this season of the year are an acquisition to the dessert, it being remarkable that when fresh fruit is so limited the cultivation of the Cherry for an early supply is so much neglected, which cannot be because of the cost, neither can it be from any difficulty in the way of cultivation, as under judicious treatment success is certain. Black and white Cherries are unsurpassed in quality by any fruit at this period, and with ordinary attention can be kept in good condition for at least six weeks after being ripe. It will be necessary to ventilate liberally at all suitable times to keep the fruit from moisture, and from the effects of powerful sun by shading. To prevent, however, too dry a condition of the atmosphere the floors and other surfaces should be sprinkled occasionally. If aphides appear they must be promptly removed by hand, or in case of their being on the terminal shoots these can readily be dipped in tobacco water.

Peaches and Nectarines.—The fruit in the early house will, as regards the very early kinds, have been ripe and ripening some time, and such kinds as Royal George, Grosse Mignonne, &c., will be swelling and colouring fast. If not already done get the young wood tied down to the trellis, stop the points of those in front or beyond the fruit to increase its size, and turn the leaves aside or shorten them where they shade it from the colouring influences of the sun. Provided former instructions have been followed the inside borders will be in a sufficiently moist condition to keep the trees in a healthy state until the fruit is ripe, but under no circumstances must the soil be allowed to become so dry as to injuriously affect the trees. The recent rains will have made all right as regards the outside borders. Until the fruit shows signs of ripening let the trees be well syringed, using clear soft water free from matter that will disfigure the fruit, but the foliage must become dry before night. Close early with plenty of sun heat, but admit a little air by 7 P.M., as the deposition of moisture on the ripening fruit may cause it to crack slightly. Tying and thinning in succession houses must be continued, watering inside borders copiously, and by an unsparing use of the syringe keep down red spider. As trees in late houses have set a great crop of fruit it requires much thinning, and this must be followed up promptly, as trees in good health at this season seldom cast much fruit if judiciously thinned before they receive a check. Promptly attend to disbudding and tying. Close in good time with sun heat, and syringe early in the afternoon.

Strawberries in Pots.—Plants that have been forced should be given some little protection, with a view to harden them off before being turned out of doors. Plants stood on ashes in a sheltered position and duly attended to with water will have all they require until they are planted out at the end of the month. The forced plants may be depended on to give a full crop next season. If any are wanted for autumn fruiting in pots a clean healthy batch should be reserved, and have the protection of a cold frame or pit for a few days after being turned out of warm houses, and be allowed to rest for a time by placing them on ashes in a position shaded from the sun. For this purpose no variety equals Vicomtesse Hericart de Thury; Sir Harry also is good for autumn fruiting after being forced. In order to have fine fruit from late-forced plants they should occupy shelves in an orchard house or late Peach house, or wherever there is a constant circulation of air, but not cutting cold draughts, and little or no fire heat. The pots should be set thinly on shelves, and have at least 6 inches space between the flowers and the glass, so that the air may circulate about them when warm and genial. In a period of dull weather shake the flower stems with the hand, or dust the flowers with a brush, in order to secure well-set handsome fruit. Thin the flowers early and examine the condition at the roots at frequent intervals, giving liquid manure at every alternate watering. As late varieties, British Queen, Dr. Hogg, Mr. Radclyffe, Cockcomb, Sir Charles Napier, and James Veitch are admirable, of which a batch for successional late forcing should be arranged in a cold pit or frame, to be shut early on the afternoon of fine days.

Make sure there is no aphides before the flowers open, or if there be fumigate so as to eradicate the pest. Retard crops advancing too rapidly, and otherwise seek to maintain the successional supply unbroken.

PLANT HOUSES.

Stove.—Attention must now be paid to the propagation of *Euphorbia jacquiniæflora*, Poinsettias, Begonias of sorts, *Justicias*, *Thysacanthus rutilans*, *Plumbagos*, *Eranthemums*, *Linum trigynum*, *Sericographis Ghiesbreghtiana*, *Centropogon Lucyanus*, *Tydeas* of the Madame Heine type, and of many other plants suitable for producing a display of bloom during the autumn and winter months. The first mentioned is much more difficult to root with success than any of the others named. The stool plants must not stand in too much heat, or the cuttings will be soft, and failure in obtaining a successful strike will result. If the cuttings are moderately firm and sturdy with a small portion of old wood attached, and a number are inserted in sand in 7-inch pots, and then well watered and covered with a bellglass before they have time to flag, the majority will strike. The pots containing them should then be plunged in slight bottom heat if possible, but any heated structure will do where they can be well shaded.

The majority of the others mentioned should be inserted singly in small pots, placing a little sand for the base of the cuttings to rest upon. They strike readily, except, perhaps, *Centropogon Lucyanus*, which should be treated in every way similar to the *Euphorbias*. Cuttings of this plant will be rather scarce, but as soon as they can be obtained they should be rooted. This is one of the most beautiful plants that can be grown, and yet has no place in the majority of gardens. When in flower it is at home either in the stove or conservatory, and will commence expanding in November and continue until the month of April. For the adornment of the stove in spring it has few equals. After the young stock has been raised the old stools should be retained, partially reducing their roots and repotting them in the same size or larger pots, as the shoots produced from the base of these will be both longer and stronger than those from cuttings. The whole of these plants will do well in a compost of fibry loam, a seventh of manure, a little charcoal and sand, *Begonias* excepted, which should have a little lighter compost. Take care that *Linum trigynum* never suffers through the want of water after they are rooted, as this plant is very liable to the attacks of red spider.

Roses.—*Maréchal Niel*, *Lamarque*, *Gloire de Dijon*, and others of this style of growth that are employed as climbers in conservatories and greenhouses, and have finished flowering, should now be pruned. It is a mistake to attempt pruning *Roses* of this nature before they flower, as quantities are needlessly cut away in carrying out the operation. After flowering the knife can be freely used and the old flowering shoots liberally thinned out—in fact cut well back, except where they are wanted to extend and cover a greater space of roof. By cutting well back strong growths are produced from the base, and if the plants are healthy and luxuriant they will already have started freely, and the growths should be encouraged, as from these the flowers will be produced next season. It is decidedly preferable to thin them liberally, and allow the plants to produce a number of strong shoots than to be crowded with poor, weak, puny growths. Shoots of *Maréchal Niel* will travel 25 feet or more in a season, and these if exposed to light and well ripened will produce beautiful large flowers from every joint along the shoots. While these plants are making their growth supply stimulants frequently, as few plants are benefited by liquid manure more than *Roses*. If confined at the roots remove as much of the old soil from the surface as possible, and top-dress with equal parts of loam and manure.

Calanthes.—The general stock of these plants must now be potted without delay. A few pseudo-bulbs of *C. Turneri* and *C. lutea* may be retarded for a few weeks longer, as they can be had in bloom after the other varieties are past their best. If these have remained in their old pots shake from them the whole of the old soil and cut away their dead roots, leaving only sufficient to secure them in their fresh pots, a small stake being used for this purpose in the case of *C. Veitchii*, and the pseudo-bulbs made secure to it by means of matting. For decorative purposes pots from 5 to 7 inches in diameter are preferable, placing two pseudo-bulbs of the varieties of *C. vestita* in the first-named size, one bulb of *C. Veitchii* in that size being sufficient, and if strong can be placed in 7-inch pots after the former is fairly well filled with roots. The pots should be well and liberally drained, and the compost must consist of fibry loam and peat in equal parts, a little cow manure, a few small bones and charcoal broken moderately small, and a dash of coarse silver sand. In potting fill the pots moderately full of the compost, and allow the new growth starting from the base just to rest upon the surface, under which

has been placed a little sand. Do not cover the growth starting from the base with the compost, or they are liable to damp. After potting place them in brisk heat, and damp amongst the pots several times daily, but do not give them water until the new roots are observed starting from the base of the new growth. Water must be applied with much care and caution until the roots are growing freely in the new soil. These do not require much water in their early stages, but when they have formed plenty of roots they need frequent and liberal supplies.

THE BEE-KEEPER.

AUTUMN-FEEDING BEES VERSUS UNITING HIVES IN AUTUMN.

THOUGH these questions have often been discussed in the pages of this Journal, a correspondent whose signature is "Novice" has intelligently reviewed a letter or two on the subject that lately appeared. In doing so he has stated a case by contrasting two hives managed on different systems—one, a June swarm, was made up for winter by stimulative autumn feeding; the other was created by a union of swarms in a bar-frame hive in September and fed into a stock. Both hives, it appears, received stimulative feeding in autumn, but one only additional bees, and was so full of them in October that it was with difficulty contracted to eight frames. Now, we are informed that in this hive there is not a third of the bees that are in the other, which has six standard frames densely covered. Your correspondent asks if I can "explain away the above results." I have no desire to explain away any fact or result in bee-keeping or bee history. The facts mentioned by our friend are not at all uncommon, for it often happens that weak hives overtake and out-run stronger ones. A few days ago I visited an apiary containing ten hives, when the owner pointed to one of his hives and said, "That is the strongest hive I have, and in the autumn it was the weakest; indeed, it was then so weak that I feared it would not survive the winter, but I covered and fed it well, and now you see its flight-board is covered with condensed perspiration." Some five years ago I visited Chesterfield, and made a stay for a few days at the end of April. In passing the workhouse I noticed some hives of bees, and found them unusually strong and in advance of all I had seen that spring. The master of the union said he found that they were in a weakly condition, and began to feed them in the dead months of winter, and continued to feed them until the time I saw them. By stimulative feeding in winter and spring the hives were made unusually strong. But a dozen of such instances of success would not tempt us to depart from our general practice; and in our opinion the instances mentioned by "Novice" do not prove much, for seasons and circumstances differ, and if he were to try the same experiments again the results might be quite different. The deaths so numerous in the sugar-fed hives were probably owing to disease or age of the bees. In our apiary the hives created in October by syrup-feeding (eight or nine in number) are our best stocks, and strongest in bees and brood. Yesterday (April 26th) I noticed hatched drones for the first time this season.

In reference to autumnal unions *versus* spring feeding for strengthening stocks I am not opposed to either. Both are good under certain circumstances, and I greatly prefer autumnal unions to the slower process of stimulative feeding not always successful. In ordinary seasons hives in autumn have food enough, and more food might be a hindrance and not a help. Some hives are so overburdened with honey or syrup that they have not room enough for brood. Of course the latest hatches of brood in autumn live longest—that is to say, further into the spring months of the following season, and this is an advantage, and a great one, in such cold springs as the present one, which has been a trying one to our bees, and to bees generally in this part of the country. Last autumn bees ceased to breed at an early period, but the winter was open, and hives were in good condition in February and contained sealed brood. March was unusually cold—so cold that enlightened bee-keepers were afraid that the brood would be chilled to death. The populations of stocks during the cold month of March were rapidly thinned by death and loss of bees. Hives, generally speaking, were much weaker in bees at the end of March than they were at the commencement of the month. They had fewer bees, and were without brood. On examination of my hives as soon as the severe frost had gone I was pleased to find the combs empty of brood. The brood of all the hives was hatched out, and the combs left empty. The brood hatched out took the places of the old bees then

fast dying; but the deaths were then more numerous than the births, and hence hives became weaker. At the end of the month breeding recommenced, and as soon as the second set of brood came to maturity hives began to gain strength and set at rest all the anxiety of bee-masters about stock hives dying off, for when young bees are born faster than the old ones die stocks gain strength, and after March when weather becomes warmer they gain strength rapidly from larger hatches of brood. The crisis of weak stocks, the question of life or death, happens at the time when the latest autumn-hatched bees die of old age. When hives are made strong with bees or brood in autumn no crisis need be feared in spring in ordinary seasons.

Your intelligent correspondent "Novice" thoughtfully notices the question of pollen in connection with that of sugar-fed stocks. He says that "Mr. Pettigrew has not showed that bees breed without pollen or a substitute." No, for they cannot breed without it: pollen is bee bread, a necessary ingredient in the food of unhatched brood. The discovery that peameal and wheaten flour are acceptable to bees as a substitute for pollen is valuable to large bee-keepers. Bees readily gather flour from shavings if placed in a barrel or box protected from rain, and they will accept and use it if given to them in their hives on a piece of empty comb. One point more should be mooted in this letter—viz., what heat or cold brood can bear without suffering. We have more than once tried to turn the attention of bee-keepers to this question. From the experience bee-keepers have had this spring they have learned that brood can be reared and hatched in a low temperature, and that with hives warmly covered there is not much danger of having brood chilled in the spring months.—A. PETTIGREW, *Bowdon*.

STRAW STEWARTON HIVES.

ABOUT these or the sale of them a word of explanation is necessary. The description of them given in the *Journal of Horticulture* has created a desire in many quarters to have them, and many orders for them are sent to me. In order to prevent misunderstanding and disappointment let me state that all through life I have declined to sell empty hives, though I get my own from the makers or in the wholesale market. The straw Stewartons are a recent invention, and not yet in the market. Believing that they will come into general use, and that their chief features will meet with universal approval, I asked a Bowdon bee-keeper younger than myself to bring out the Stewarton hive for sale. Meanwhile I ordered thirty-two to be made for my own swarms; and I have advised a straw-hive merchant in Manchester to have a large number made, so that he will be prepared to meet an expected large demand, and I shall order thirty-six more.—A. PETTIGREW.

BEES, BEER, AND RUM.—Years ago I kept bees, and in winter fed those that required it with the following mixture:—1 lb. brown raw sugar boiled with a pinch of salt in a pint of ale, stirring and skimming till clear. After taking off the fire, and before bottling, add about a teaspoonful of rum. The bees liked this syrup, and did well on it.—AMATEUR.

TRADE CATALOGUES RECEIVED.

Francis and Arthur Dickson & Sons, 106, Eastgate Street, Chester.—

List of Select Bedding Plants.

J. Veitch & Sons, King's Road, Chelsea.—*Catalogue of New Plants for 1853 (Illustrated), and List of Softwooded and Bedding Plants.*

Stephen Brown, Weston-super-Mare.—*Catalogue of Bedding Plants.*

William Potten, Sissinghurst, Kent.—*List of Pelargoniums and Bedding Plants.*



** All correspondence should be directed either to "The Editor" or to "The Publisher." Letters addressed to Dr. Hogg or members of the staff often remain unopened unavoidably. We request that no one will write privately to any of our correspondents, as doing so subjects them to unjustifiable trouble and expense.

Correspondents should not mix up on the same sheet questions relating to Gardening and those on Poultry and Bee subjects, and should never send more than two or three questions at once. All articles intended for insertion should be written on one side of the paper only. We cannot reply to questions through the post, and we do not undertake to return rejected communications.

Books (A. B. C.).—Brande's "Dictionary of Science" is published by Messrs. Longmans & Co., Paternoster Row, price 63s.

Manure for Mushrooms (J. W. F. C.).—You had better not use the manure. This is all we can say this week; answers to some other letters are also unavoidably postponed.

Flat Bouquets (E. B.).—We regret that by an oversight the reply to the other portion of your letter was not printed, but the particulars required are as follows:—A special framework is not usually employed for the purpose named, but the flowers are all wired, the length of the wires being regulated according to requirements, and the bouquets are arranged to taste. A piece of damp cotton wool is secured to the base of each flower stalk, and serves to keep it fresh and the flower in its proper position at the same time.

Dendrobium noble (R. H. R.).—There is nothing remarkable in Dendrobiums flowering on the current year's growths if it is early and well matured, but it is not a circumstance that can be insured at will. Your plant is undoubtedly vigorous, and the treatment you are affording it must be suiting it extremely well, which partially accounts for its readiness to flower. Growths that are weakly or imperfectly matured seldom flower the first year.

Vines in Pots (Ilem).—We are glad to hear of your success with Vines. Sound judgment in watering is requisite when fruiting Vines are repotted in the spring. We presume you shifted the Duke, and in all probability you would have done better to have let it alone. The symptoms you describe undoubtedly indicate torpidity at the roots, and it is questionable if the Vine will ever be satisfactory, at least in the pot; planted out it might possibly improve and eventually produce fruit.

Crocuses in Borders (J. B.).—It is certainly wrong to cut off the foliage in the manner you describe soon after the plants have flowered. A safe indication of removal is its change of colour and parting from the corms readily without breaking or needing a violent pull. This usually occurs about the middle of May, sooner or later according to soil, season, and position.

Begonia weltoniensis (Amateur).—This is classed as a stove plant because it requires more than a cool greenhouse temperature in the winter to keep it healthy. It will succeed, however, very well in an intermediate house or a warm greenhouse. Many stove plants succeed in windows, and even in the open air in summer—for example, Coleuses and Alternantheras, but they require a warm house during the winter to preserve them in a satisfactory state.

Firm Vine Borders (An Antwerp Subscriber).—The border in the great vinery at Longleat made and managed by Mr. Taylor is as hard as the borders in the vineries at Clovenfords, and no finer crops of Grapes are produced anywhere than in the houses in question. Mr. Taylor states on page 75 of "Vines at Longleat" that the manure he uses is spread on in March, and the "crust of the border is broken to the depth of 1 or 1½ inch in April." No doubt a similar practice is adopted at Clovenfords, when top-dressings are given and the borders watered. The surface is soon made hard again by the workmen in attending to the Vines. Mr. Thomson's Vine manure is sold by the Horticultural Company, Garston, Liverpool.

Manure not Heating (Jos. S.).—If the material heated freely in the heap it will again heat in the pit unless you have trodden it in too firmly; but two days is not sufficient for the recommencement of fermentation. You did quite right in preparing it as you have described, but even then some time must elapse before the pit will be safe for the plants. If it is ready in from a week to ten days after filling the pit you may be quite satisfied. We fail to see how you will get sufficient top heat for Melons unless you have some means of affording it that you have not indicated in your letter. We shall shortly publish notes on the cultivation of Melons in pits and frames. If a good thickness of red and white lead is very tightly pressed round the pipe with the "jointed cover" you have had made it will in all probability stop the leakage; so also might an india-rubber ring similarly forced round under great pressure. Much depends on the way in which the work is done in a matter of this kind, and a good mechanic ought not to be content with failure. See also a reply to a correspondent on page 371 last week.

Mushrooms in Vinery (Dr. Mackenzie).—There is no objection whatever to your making a Mushroom ridge along the centre of your vinery provided the material is quite ready for use immediately the wood of the Vines is ripe and ready for pruning, as then the temperature of the vinery when the Mushrooms are produced in January, February, and March would be suitable for them; but if the beds were made later they would come into bearing at a time when the heat of the house would be too great for the Mushrooms. If you were to make a bed in the vinery in September you might expect Mushrooms from November onwards, and the temperature of the house would be suitable for the crop. Mr. Wright's treatise on Mushrooms will perhaps be ready by the time you read these lines; if so you will find it announced in some other part of the Journal. It is in the press, and copies are expected daily.

Grafting Willows—Budding Plums (J. T. S.).—Your success in grafting one variety and not the other shows that you have adopted the right method, and you may conclude that your failure is the result of an unsuitable stock for the Kilmarnock Willow. *Salix caprea* is the stock to use, the Kilmarnock being a variety of this species. If you obtain the right stock we think you will have no farther difficulty. Budding is preferable to grafting in the propagation of Plums, and we are quite at a loss to account from your failure in budding them. We have seldom experienced any difficulty in the matter, though in some years have had greater success than in others. It is impossible to state the exact time for budding, as everything depends on the condition of the buds and stocks, and these are influenced by locality and circumstances. A few experiments made from the end of July to September would enable you to determine by results the right conditions for doing the work.

Buck's Scarlet Rhubarb (J. W. Hall).—The above is the name of the Rhubarb you have sent. We know it quite well and have grown it for many years. We have also seen considerable breadths of it in the county from which you write. We consider it the best in quality and colour of any we have cultivated, being a deep crimson throughout, and, as you observe, requires less sugar than most other varieties. We have no doubt you are correct in saying it is the "best for preserving." This Rhubarb was exhibited at a meeting of the London Horticultural Society by Mr. Buck in 1824, and it was stated at the

time that it was better both in quality and colour if the stalks were not peeled before cooking. It is early, of small to medium size, and forces well. There is another "scarlet" Rhubarb, larger than this and more generally cultivated, but inferior by comparison both in appearance when cooked and in quality.

Blotches on Cucumber Leaves (H.).—We do not think the blotches have been caused by insects. At some time or other we suspect the plants have been dry, which has caused a shrinking of the epidermis, and it has ultimately dried up. We have seen the same results in a house where the atmosphere has been kept very dry and air not admitted early enough in the morning, then opening the lights too wide, causing sudden and extreme evaporation from the foliage. It is certain your plants are not healthy, the leaf you have sent being extremely thin, indicating that the plants lack vigour. Remove all the worst leaves, add top-dressings of rough rich soil, give weak liquid manure in a tepid state, maintain a moist genial atmosphere, ventilate carefully, and you will encourage fresh growths of a different character to the example before us. Syringe the plants well every afternoon, and close the house with a sun temperature of 85°, and you will not have many insects.

Weevil Eating Plants (S. F.).—The weevil sent appears to be a specimen of *Otiorhynchus sulcatus* out rather earlier than usual, for its usual date of emergence is June or even later. Also known as the vine, black, or grooved weevil, and very destructive to plants in pots, attacking them at the base of the stem where the grub burrows. The beetles also gnaw the stems and young leaves, or enter the earth just under the surface. It is recommended to water the plants, a decoction of quassia or a weak solution of paraffin or hellebore, as suggested in a reply to another correspondent. A number may be caught by searching for them at night when they leave their hiding places, or they may be shaken from the foliage into a net.

Scallop Budding (X., Loughgall).—It is accomplished by taking a thin tongue-shaped section of bark from the side of the stock, and a similar section from the shoot containing the buds, but in neither case removing the wood. The portion containing the bud is then laid on the corresponding scallop in the stock, its upper edge exactly fitted as in ordinary shield budding, and at least one of the edges as in whip grafting. After this it is secured in the usual way. Although this method of budding is not much practised in this country it can be done, as you will perceive, when the bark does not "run" freely. In America budding is extensively practised without removing the wood, but the portion containing the bud is inserted under the bark, and the method may, perhaps, be suitable in hot climates.

Vines Unhealthy (M. A. G., Isle of Wight).—You enclose a Vine leaf and ask if there is "really anything amiss with the Vines." Our reply must be in the affirmative; but we do not attribute their unsatisfactory condition to insects, least of all the phylloxera, of the presence of which there are absolutely no traces. In all probability the growths are much too crowded and the foliage has not space for development. This was also probably the case last year, and consequently this season's growths are weak and unsatisfactory. It is certain, too, there has been some neglect in ventilation. The house has probably been kept closed too long in the morning, and then too much air has been admitted at once. This invariably results in injured foliage. You afford us no data whatever to enable us to point out with any precision exactly where you err. If you had briefly described your practice—such as the night temperature you maintain and your method of ventilation—we should have been better able to give you a more useful reply. If you write again you might also state the probable age of the Vines, the distance the rods are apart and from the glass, also whether the roots are inside or outside the house. With the information suggested we could probably aid you, and we are very willing to do so. The leaf was so much crushed that we could not find the insect you state you enclosed in it, but we feel confident there is no phylloxera.

Seedling Auriculas (J. E. Walling).—The Auriculas you have sent are border varieties, such as are usually raised from purchased seed. They are far below the standard of the named varieties that are grown in pots and exhibited. You cannot obtain high-class Auriculas from seed of the leading varieties, for the simple reason that their seed is not purchasable. Seedsmen procure the best they can, but it is not the practice of persons who have valuable collections of choice Auriculas to save any great quantity of seed from the best of them, nor do we think you would do so if you were in the same position as they are. Seed-ripening is an exhausting process, therefore, as a rule, only a few pods are saved from the rarer sorts for the use of the owner and, perhaps, a few of his intimate friends. There is only one way of becoming possessed of a collection of Auriculas of high-class quality—namely, by the purchase of plants. This, too, is the most inexpensive method, notwithstanding the cost of the plants, for if you were to spend £10 in seed we venture to say that after all your labour and waiting you would not raise as many plants that would rank as meritorious exhibition varieties. There is no difficulty in purchasing seed of *Cinerarias*, *Calceolarias*, *Primulas*, *Cyclamens*, *Begonias*, and plants of that kind that will both germinate freely and afford satisfactory results; but you can no more procure Auricula seed that will yield exhibition varieties than you can purchase Rose seed that will give varieties equal to the best named sorts. We would readily publish your letter if it would be of use doing so, but we know it would not. It would simply provoke replies and bring us shoals of testimonials quite different in character from your estimate of the quality of the seed sold by respectable firms. Had you stated from whom you obtained the Begonia seed that you characterise as worthless we should have been better able to form an opinion as to its germinating power, as we have seen the most satisfactory results as to the growth of plants and quality of their flowers from seed obtained from most of the leading firms. You appear to have been unfortunate, and we do not assert you have no cause for complaint, but this is no justification for the publication of the letter in the form in which it is written, and which we are positive could have no such results as you anticipate.

Grubs in Garden (W. T. W., Bath).—The larvæ received as being destructive to various crops are undoubtedly the larvæ or grub of a Crane fly or Tipula, either *T. paludosa* or *gigantea*, the larger species. Numerous have been the suggestions as to the mode of extirpating this insect pest and its kindred, but we fear when a young crop is decidedly attacked there is little hope of saving it. After it has been removed the surface soil may be burnt or dressed with some very powerful preparation after forking. Recently it has been again stated that much benefit is done by rolling the ground at night, where that is possible, as the grubs come above then frequently. We have, it is to be feared, made the larvæ of this genus more troublesome of late by our discouragement of many birds, especially starlings, that make them their special prey. You have certainly been most diligent in endeavouring to extirpate the pest, having, you inform us, caught 40,000 on an eighth of an acre of land. We should like you to try the effect of petroleum and water, commencing with half an ounce of the oil to a gallon of water, noting the effects on the grubs and plants. You

might also try an ounce or more of the petroleum to the gallon. Violent and continual agitation are requisite for incorporating the petroleum with water. We shall be glad if you will try the experiment suggested and let us know the result; also we should like you to try hellebore tea at the strength of 2 ozs. of white hellebore powder to a gallon of water. First mix the powder with hot water to the consistency of cream, then add cold water of the quantity required. Mr. Witherspoon has recorded that "In soil saturated with hellebore (made as above directed) no insect can live, and yet plants are not injured." If you find this mixture will kill the grubs you have sent to us and not injure the crops, you will do a public service by communicating your experience; even if the remedies suggested fail, we shall be glad to hear from you.

Names of Plants (*T. K., Eltham*).—1, *Asperula odorata*; 2, *Omphalodes verna*; 3, *Muscari botryoides*. (*J. B., Barnet*).—*Ribes aureum*.

Stewarton Hives (*Hampshire Inquirer*).—You will see by a letter in another column that the hives referred to by Mr. Pettigrew are not yet in the market. Mr. Pettigrew got a carpenter to put bars into his hives and supers. No doubt the hives will in due time be advertised, and until they are we must conclude there is none for sale. Other inquirers will please also accept this reply. Mr. Pettigrew says "there is the prospect of an immense demand for Stewartons if any fair dealer will come to the front with them and advertise."

Straw Lids (*H. A.*).—The straw lids are flat, rest on the bars and edge of the hives, and form part of it. Mr. Pettigrew had his rims and supers made to order at Altrineham, and the rims were sent to his straw-hive maker, Mr. Robert McMillan, Kilmarnock, who sewed the straw to the rims. We are unable to answer your question about bees; perhaps Messrs. Neighbour & Sons, 149, Regent Street, London, W., might give you some information.

COVENT GARDEN MARKET.—MAY 9TH.

A GOOD business doing during the past week, with supplies better and prices generally easier.

FRUIT.

	s. d.	s. d.		s. d.	s. d.
Apples.....	½ sieve	2 0 to 7 0	Grapes	lb.	4 0 to 8 0
"	per barrel	20 0 40 0	Lemons.....	case	10 0 20 0
Apricots.....	doz.	0 0 0 0	Nectarines....	dozen	0 0 0 0
Cherries.....	½ sieve	0 0 0 0	Oranges	100	6 0 10 0
Chestnuts.....	bushel	10 0 12 0	Peaches	dozen	18 0 21 0
Currants, Black..	½ sieve	0 0 0 0	Pears, kitchen ..	dozen	1 0 2 0
" Red.....	½ sieve	0 0 0 0	dessert	dozen	1 0 2 0
Figs.....	dozen	0 0 0 0	Pine Apples, English	lt.	1 6 2 0
Filberts.....	lb.	0 0 0 0	Raspberries.....	lb.	0 0 0 0
Cobs.....	100 lb.	0 0 0 0	Strawberries ...	lb.	3 0 8 0
Gooseberries ...	½ sieve	0 0 0 0			

VEGETABLES.

	s. d.	s. d.		s. d.	s. d.
Artichokes.....	dozen	2 0 to 4 0	Mushrooms	punnet	1 0 to 1 6
Asparagus, English	bundle	3 0 6 0	Mustard & Cress ..	punnet	0 2 0 3
Asparagus, French	bundle	2 0 10 0	Onions.....	bushel	2 6 3 6
Beans, Kidney	100	2 0 0 0	Parsley.....	doz. bunches	3 0 4 0
Beet, Red.....	dozen	1 0 2 0	Parsnips	dozen	1 0 2 0
Broccoli	bundle	0 9 1 6	Peas	quart	3 6 6 0
Cabbage	dozen	0 6 1 0	Potatoes, New	lb.	0 4 0 10
Capstems.....	100	1 6 2 0	Potatoes	cwt.	6 0 10 0
Carrots	bunch	0 4 0 0	Kidney	cwt.	6 0 10 0
Cauliflowers.....	dozen	2 0 3 0	Radishes....	doz. bunches	1 0 0 0
Celery	bundle	1 6 2 0	Rhubarb.....	bundle	0 4 0 0
Coleworts....doz. bunches	2 0 4 0	Salsafy.....	bundle	1 0 0 0	
Cucumbers.....	each	0 4 0 8	Scorzoneria	bundle	1 6 0 0
Endive.....	dozen	1 0 2 0	Seakale	basket	1 0 2 0
Fennel.....	bunch	0 3 0 0	Shallots.....	lb.	0 3 0 0
Herbs	bunch	0 2 0 0	Spinach	bushel	5 0 6 0
Leeks.....	bunch	0 3 0 4	Tomatoes.....	lb.	1 6 2 0
Lettuces	dozen	1 3 2 0	Turnips	bunch	0 2 0 3



POULTRY AND PIGEON CHRONICLE.

PLOUGHING-IN OR FEEDING GREEN CROPS.

(Continued from page 374.)

It is now our intention to illustrate this subject, not only by its application in rotations of cropping the various soils, but also to make comparisons with the systems of stocking with sheep, which find favour with the majority of farmers, especially in the hill districts of various counties upon the chalk and limestone formations. These hill farms are essentially the home of the breeding flocks of various kinds of sheep, and particularly of Down breeds and their crosses. We will therefore select farms of considerable

size situated on the chalk or limestone, which we think will fairly represent the soils and proportions of soils which are various on the surface. These include a large portion of certain counties, including Wiltshire, Hampshire, Dorsetshire, and Gloucestershire, although other hill districts resemble those we have named and reach across the kingdom from Devonshire to Norfolk.

As a representative farm we will select one which fairly illustrates the breeding stock farms of many counties, and we take the statements for our use and authority of two agriculturists of high repute and great experience, whose essays on the hill farming are especially adapted for quotation—Mr. E. P. Squarey on the hill farming of Hampshire and Wiltshire, and Mr. J. Darby on farming of the chalk soils of Dorset. Both these essays appeared in the Journal of the Bath and West of England Society for the Encouragement of Agriculture in the year 1861. We should, however, have preferred more recently written essays, but throughout the whole of our agricultural literature we find nothing so suitable. In the essay of Mr. Squarey we find the following observations as a preface to his statement of a Wiltshire farm under a stock system:—"In no department of the farm management of Wiltshire and Hants is there greater need of inquiry than in that which relates to the cost of producing the portion of sheep stock which comes in annually for sale, so that the profit, if any, after deducting all costs, may be debited to the corn crops. The question is beset with difficulties, but I will endeavour to deal with it as generally as possible." We cannot do more than give the totals of his calculations and the result of the management of a farm of 800 acres, whereon a breeding flock of about 750 ewes would probably be kept with the lambs until August or September, and about 280 tegs. "Taking a farm of 800 acres we will suppose it to contain of arable land 550 acres; down or strong land arable, 200 acres; water meadow, 30 acres; pasture, 20 acres. Total, 800 acres. To get rid of the question of cows, horses, &c., and thus relieve the account, it is proposed to set them against the produce of 20 acres of pasture and 10 acres of water meadow which they may be supposed to consume; it is further assumed that the Vetches or Trifolium consumed by the horses are grown specially for them."

We now come to the total results of sheep stock, their returns and costs of food, which are set forth in a thoroughly practical form, embodying, no doubt, Mr. Squarey's long experience as a land agent and hill farmer at Odstock, near Salisbury, and for the detail of which we refer the home farmer to the Journal, as above stated, for 1861—"The produce of 750 ewes, under the statistics given, amount to the sum of £1125 15s. The charges against the sheep, including rent, rates, taxes, and cost of cultivation for green and root crops, hay, Sainfoin, and pasturage, amount to the sum of £1236 15s. To balance loss £111. No charge is made for hurdles and cost of superintendence, &c." It appears from Mr. Squarey's statement, in which he says "That the cultivation of root crops, the growth of hay, and the consumption of the portion of water meadows indicated involves a cost of £1236 15s., whereas the value of the produce amounts to £1125 15s. only. This is another expression of the often discussed difficulty of profitably consuming root and other green crops by cattle, sheep, or pigs. The broad experience of the agricultural world confirms the general results which are here arrived at—viz., that only under exceptional circumstances can the green and restorative crops, which prepare the way for the profitable growth of corn, be consumed without loss on the particular transaction. In the foregoing calculation the value of the manure resulting from the consumption of the crops has been altogether omitted, Practically this item more than compensates for the deficiency of £111, were it otherwise the system would come to an end."

Mr. Squarey further gives the system of cropping usually

adopted on such a farm of 800 acres. He says—"The lower portions of the farm usually form irrigated meadows or pastures, and the land immediately lying next to them, consisting of 100 acres, comprise arable lands of a very superior character, producing at frequent intervals Wheat, Barley, and Turnips of good quality. The next division includes what is called the field arable land, which is weaker in staple, but is especially adapted for Wheat, Barley, and stock, and answers promptly and gratefully to a liberal application of manure. The next and last portion, that called down arable, is of a still lighter description, except that in some instances this is, together with the remaining portion of down pasture, the strongest land on the farm, particularly in the counties of Hants and Dorset; and the proportion which it ought to bear to the arable is one of the vexed questions of Wiltshire agriculture."

Although written in 1861 the statement by Mr. Squarey gives only the result of feeding the flock entirely upon the green and root crops and hay as applies to Wiltshire for the most part, yet we find Mr. Darby in his essay referring to Dorset county states—"The expense of feeding stuffs and artificial manures alone upon the best-farmed districts amounts to from 25s. to 30s. per acre per annum, and the labour bill also is large." He further states, Mr. Cains of Chiselborne gives it as his experience that but for the extensive use of oilcake he could not make a profit. "I must make four rents out of my farm in order to make it pay," states Mr. K—, and moreover, he declares, "the wear and tear of iron on it alone costs me £100 per annum." If, then, the farmers' revenue has been greatly augmented by realising from larger flocks and more productive corn crops, it should not be forgotten that his outlay has increased in the same proportion. If his prospects are bettered his risks also are heightened. If he labours for grand results the work requires the exercise of skill and enterprise of no mean kind, but his profits must of necessity be slow and liable to great fluctuations.

These statements go far to show that if four rents are to be made before it can answer, that the amount of one rent is invested, and frequently more, previous to its accomplishment. When it is further considered that the whole of the sheep stock on the farm and the purchased food, also the dead stock and implements required, together with the heavy labour bills consequent upon what is called attendance on the flock, is a serious investment connected with the sheep-breeding and feeding system. In some cases it amounts to 40 or 45 per cent., and never less than 30 to 35 per cent., on the capital employed for and in conducting the farming business in these districts. The interest to be charged upon so large an investment is one of the causes which has induced us to take up the present subject, and endeavour to ascertain if some mode of farming these hill districts cannot be found, yielding as much or more profit than the best systems of sheep farming. In attempting to show this, which we hope to do in our next week's paper, we hope at any rate to have the satisfaction of inducing the home farmer to think over the subject carefully, and also induce the landowners to think that while such large amounts of capital are required to farm their land in times of depression, that much land must of necessity remain untenanted.

(To be continued.)

WORK ON THE HOME FARM.

Horse Labour.—Horses have been nearly constantly employed, for although we have been benefited by some fine rains, yet the pastures laid up for hay have been rolled when the tillage land was too damp for free working. The time for planting Potatoes is now over, still if any remain to be set they would if planted now come up quickly as the land is moist and also of high temperature, so that their growth and progress would be insured, and therefore the latest sorts may produce a good crop if the land is well manured. The seed time for Mangolds still continues favourable, for the land is everywhere moist enough to vegetate the seed at once as soon as planted or drilled; it is favourable, too, this year for planting in the stetch, the dung being buried in the centre. If artificial manures have been ridged-in, the hand-dibbling of the seed answers as well or better than the drill. We have, however, found the work answer a good purpose where the hand drill used for garden purposes has been used, and run along on the top of the stetches; the same with Carrots, for when the land is stetched at 18 inches apart between the lines and artificial manures are applied the horse-hoeing can be done at a much earlier date than when drilled on the flat.

Where roots are required for cattle before the Mangolds are ready, it is a common practice to sow some Imperial Swede seed with them, for when the Swedes are sown at this early period they will ripen early and be ready a month earlier for cattle-feeding. In the same way Kohl Rabi or Cabbage may be obtained; in fact, it is always best to have some beds of Cabbage plants of the Champion Drumhead variety ready for planting amongst the Mangold or other root crops,

our plan being to plant with the spade, introduced at an angle of 45°, and on being lifted up partly the plants are introduced at the back of the spade before the spade is removed. In this way they are not only much more likely to start well, but they always make larger heads, and plants of a much larger and stronger size. This work is done best by men to use the spade and women to introduce the plants. The Clover seeds should have been sown at the time of seeding the Lent corn, if it has not been done; the weather has lately been favourable for seeding either in the Wheat after Potatoes or Lent corn after roots fed off. The late rains have been favourable to the early growth of the young Clovers, and the Italian Rye Grass is now fit to cut in some cases. The dairy cows should now have some in their racks when they come in to be milked. The odd horse or mule will now be employed in carting grass, &c., for the cattle and horses, for the forwardest Trifolium will soon be fit.

Live Stock.—The young cattle in the boxes may have Italian Rye Grass at once with their usual allowance of cake and bean meal. 2 or 3 lbs. of cake and 1 lb. of bean meal per day in the meal state, mixed with a small quantity of Mangolds cut with Gardner's cutter, will prevent waste between the intervals of grass-feeding. The young heifers, too, intended for the dairy in the future may have grass cut up round the borders and hedges, and will do remarkably well upon it; and in the sandy loam soils in the enclosed districts the grass is not only valuable for feeding cattle, but breeding sows in the yards also, as any young stems of wood if not eaten will tread into manure; and the borders may be cut the second time in the first week of July, and answer an excellent purpose, because it not only furnishes food to pay for cutting, but it effectually keeps down the weeds. Where the hedges are trimmed the borders are kept in a cleanly state, and the hedges and ditches also.

We know a farmer who keeps a milk-selling dairy of twenty cows, which during the summer have little other grass than that afforded by the banks and borders, but the cows have 4 lbs. of cotton cake per day each; but the wood growth is cut close, and therefore cut each time with the grass, Cow Parsley, Hogweed, &c., and no complaint is made of the quality of the milk. Large stores of Mangolds in many cases still remain for feeding the fattening bullocks in the boxes; but when they draw near to the close a few should be retained for mixing with the cake where the cattle go upon Trifolium or Clover and other grasses. It is a good plan, too, to insure a fair succession of Clover to cut a portion of the crop early, so that the second cutting may be early also, and fit in between the other grasses for horse and cattle-feeding; but it should be also remembered that when the early, the second early, and the latest varieties of Trifolium are cultivated the supply will extend into the month of July, and be the means of saving the Clover crop all round for hay. This is important where much stock is kept for the winter, or where the hay is cut and made for sale. In the case of buying breeding swine we recommend the purchase of Berkshire sows of the purest type, and for mating with them boars of the largest white Yorkshire type and of the purest breed. This cross will give all the benefits to be derived from swine-breeding.

SOIL EXHAUSTION—SPECIAL WANTS OF SPECIAL CROPS.

(Continued from page 354.)

OVER the largest part of the kingdom hay generally follows corn. In some places Clover alone is grown; in others, a mixture of Clover and grasses; in others, grass alone. Perhaps those who grow Clover only have good reasons for so doing; but when the special wants of plants are attended to it will be found that a mixture of grasses and Clover produces more hay. Indeed, the grass may be looked upon almost as an addition to the crop, for each requires such different soil-conditions so far as their food is concerned that the one hardly interferes with the other. When hardly enough of the food each wants is present less than a full crop will be reaped, but by growing both together instead of separately this may be accomplished.

A heavy grain crop leaves the soil deficient in nitrogen and generally in phosphoric acid, unless phosphates have been liberally applied to the grain. Grasses, however—all grains are grasses—require these very things, and poor crops will follow unless they can find these substances in sufficient quantities. Hence the reason of so many farmers growing Clover hay unmixed with grass. Clover, though notably rich in nitrogen itself, either does not want that element from the soil as Ville maintains, or uses such compounds containing it that grasses will not touch. Then, though it needs phosphoric acid, it seems to have a particular power of attacking those compounds of it in the soil which refuse to give up their phosphorus to grain crops. Give it available potash, and the soil is poor that will not produce one crop of Clover or other leguminous plant—Lucern, Sainfoin, Beans, Peas, and Vetches.

When Clover alone is grown potash salts—the chloride or kainit are generally used—alone will supply on ordinary soils all that is

needed. But these cost money, and it is always best to be sure that the spending of money is absolutely necessary before parting with it. In this case we do not think it is. Wherever animals are kept there is urine. Often this is allowed to run to waste. It generally is in the district where we reside at present. But the urine on an ordinary farm contains enough potash for the hay crop, and to this it may be applied more economically than any other. Five tons of urine supply from 400 to 600 lbs. of potash, and this is an ample application to an acre; indeed, more than one crop of either Beans or Clover needs. If soil is "not suited" for growing leguminous plants let farmers try what effect such an application has. On light soils we have known it treble the mixed hay crop, producing a rich growth of fine Clover in place of a poor, yellow, half worthless one.

But urine contains something besides potash salts. One ton of pure mixed farmyard urine contains about 50 lbs. of urea, which may be reckoned equivalent to an equal amount of ammonia. Five tons of this will consequently afford 250 lbs. of nitrogen equal to ammonia, or half a ton of sulphate of ammonia. This is far too much for an acre of either hay or corn, and is, indeed, when applied pure, which it seldom is, destructive in its richness. Applied mixed with not less than six times its bulk of pure water, five tons of pure urine is harmless even in dry weather, and is quite sufficient for four acres of hay or pasture land. In this case the potash applied is less than the Clover crop needs; but this is of little consequence on ordinary soil, for generally enough is present, and that applied may be regarded as extra. But in order that the nitrogen may be fully utilised Rye Grass should be sown mixed with the Clover. The grass will utilise the nitrogen, the Clover will take up the potash, and a heavier crop will result than could have been had from either separately.

The great reason for applying the liquid manure of the farm to hay and pasture land is because when applied to land not under crops a portion is apt to pass away in the drains. When grass is growing the roots intercept the manure and use it. Moreover, the drainage from grass land is less than from that which is bare, because more is evaporated. When the crop grows strong the drainage is nil unless in very wet seasons.

Then urine is most plentiful in winter just when bare land is so soft that carting on it is impossible. But there is not the same trouble on hay or pasture land. There is not enough for both corn and grass lands, so it is better to give it to the grass, and apply the artificial manure otherwise.

When strong-growing Potatoes are grown, and only partly manured with farmyard manure on many farms, there will be a surplus over after manuring the green crops. This may be very profitably employed on hay or pasture land. This was so forcibly illustrated in the Journal lately, that nothing more may be said on it here, except that pasture land properly manured will keep double the number of animals that the same pasture treated in the ordinary way would. A 50-acre farm may thus be made to produce as much as many a one twice the size, while the rent, taxes, labour even, remains only the half.

When artificial manures are partly used for green crops and for corn ordinary manure is generally plentiful enough to allow of its use in the way indicated, especially in the case of the liquid. When hay is plentifully produced there is generally plenty of manure, for there is plenty of cattle; and rich pastures when broken up produce the heaviest of crops without artificial aid.

When manure of the ordinary sort is for any reason scarce, and yet the advantage of full hay crops and rich pastures desired, artificial may take the place of ordinary manure with certain prospect of success following their application. Some lands require no potash to be applied—they contain an inexhaustible supply of it. On such Clover will flourish as well, though not a particle be given, as well as if liberally dressed. Buying potash for such is "dropping money over a bridge." By dressing part of each field and leaving part undressed the farmer will speedily find from the state of the Clover or Bean crop whether it is wanted or not.

On land wholly deficient in potash, as in the case of some sandy soils and more especially boggy lands, and even in some cases on chalk and clay, potash is so deficient as to be not worth taking into account. In such cases an application of the chloride at the rate of 2 cwt. per acre will be amply sufficient for a Clover crop. When it is evident that the soil can of itself afford some then 1 cwt. may prove sufficient, and in any case if one half of the crop is Clover and the other half grass; but in this case it will be well to give from 2 to 3 cwt. of superphosphate and about 2 cwt. of sulphate of ammonia, or more of nitrate of soda. These quantities, we must again repeat, are for very poor soils, from which it is desired to take as good crops as possible. The same remarks apply to pasture, but in the case of very old or permanent pastures bone dust will be found one of the best for application. In such, especially on light

sandy, chalky, or peaty soils, a good-enough turf will form in time, but it will be composed of grasses that thrive even in the absence of phosphoric acid. All such grasses, without exception, are very poor as forage plants. Innutritious, indigestible, even the hardiest of cattle fail to convert them into meat or milk, simply because they do not contain the materials in quantities sufficient to form a surplus after providing for the animal's own wants. But when phosphates are naturally present or artificially applied grasses of quite another character grow, and when nitrogen is added grow luxuriantly. It is nearly time that farmers learnt that it is not the seeds we sow, but the nature of the plant food present, naturally or otherwise matters not, that determines the character of pastures, and that milk and meat depend on the manure applied more than everything else, for the botany of pasture fields depends on the nature of the plant food. In another paper we hope to deal with some other farm crops and their wants in the matter of food.—A. H.

(To be continued.)

COMMITTEE OF AGRICULTURE.—The *Gazette* recently contained the following announcement:—"It is ordered by Her Majesty in Council that the following named members of Her Majesty's Most Honourable Privy Council be, and they are hereby appointed, a Committee of Council for the consideration of all matters relating to Agriculture—namely, The Lord President, Earl of Rosebery, Earl Spencer, Earl of Kimberley, Lord Carlington, the Chancellor of the Duchy of Lancaster, and Mr. Shaw-Lefevre. And it is further ordered, that all matters relating to Agriculture be, and they are hereby referred to the said Committee to consider the same and report thereon to Her Majesty in Council in like manner as if each subject had been referred to the said Committee by a special order of Her Majesty in Council. It is further ordered, that during Her Majesty's pleasure the Chancellor of the Duchy of Lancaster shall preside over the said Committee in the absence of the Lord President."

INTERNATIONAL FORESTRY EXHIBITION.—The Highland and Agricultural Society of Scotland has voted £100 towards an international forestry exhibition to be held in Edinburgh next year. Referring to the notice that the subject of British forestry is to be brought before Parliament, the Society has passed a resolution to the effect that it would hail with pleasure the organisation of a system of forest education in Great Britain as a matter of the greatest importance for the instruction of forest officers, as they deem it a question of vast importance to this country as well as her various colonies.

OUR LETTER BOX.

The Trumpeter (*F. Jones*).—We can only give a very brief description. A full account will shortly appear in the pages of "POULTRY." The chief points are—1, The peculiar voice, an oft-repeated eoo, from which the Pigeon takes its name; 2, the "rosc," a large circular topknot of feathers spreading out from the centre of the head; 3, the "crest," a ridge of feathers extending round the back of the head, not lying close as in the case of the Jacobin, but standing upright; and 4, the foot feathers, which should be as heavy as possible. The colours are black, white, black-mottled, and splashed.

METEOROLOGICAL OBSERVATIONS.

CAMDEN SQUARE, LONDON.

Lat. 51° 32' 40" N.; Long. 0° 8' 0" W.; Altitude, 111 feet.

DATE.	9 A.M.					IN THE DAY.				Rain
	Barometer at 32s and Sea Level	Hygrometer.		Direction of Wind.	Temp. of Soil at 1 foot.	Shade Temperature.		Radiation Temperature.		
		Dry.	Wet.			Max.	Min.	In sun.	On grass.	
1883.	Inches.	deg.	deg.		deg.	deg.	deg.	deg.	In.	
April and May.										
Sun. 29	29.176	52.0	49.5	N.W.	48.2	61.2	47.6	97.2	47.2	0.032
Mon. 30	29.707	52.4	46.5	W.	48.8	64.3	41.4	111.6	35.7	—
Tues. 1	29.753	50.4	47.7	N.E.	49.6	63.7	44.0	109.8	42.0	—
Wed. 2	29.913	41.4	40.0	N.	49.6	60.0	41.8	94.4	40.3	—
Thurs. 3	29.843	47.2	42.3	N.	49.2	54.3	38.1	102.4	37.3	0.048
Friday 4	29.832	42.7	39.5	N.	47.2	52.4	31.0	98.8	30.8	0.077
Satnr. 5	29.855	42.2	39.0	N.E.	48.3	58.6	31.3	104.1	26.3	—
	29.773	47.3	43.5		48.3	59.2	39.3	102.6	37.2	0.157

REMARKS.

29th.—Rain at first; fine greater part of the day; heavy clouds between 4 and 5 P.M., shower 6.30 P.M.
 30th.—Very fine, with bright sunshine.
 May 1st.—Fine and bright; cold N.E. wind.
 2nd.—Dull and cold.
 3rd.—Cold, fine during morning; afterwards cloudy and showery.
 4th.—Fine bright morning; sharp shower of hail at 3.37 P.M.; cold day.
 5th.—Fine, bright, and cold.
 The early part of the week warm, the latter part very cold, with frost on two mornings.—G. J. SYMONS.



17th	TH	Reading Show.
18th	F	
19th	S	Crystal Palace Show.
20th	SUN	TRINITY SUNDAY.
21st	M	[11 A.M. Summer Show (two days).
22nd	TU	Royal Horticultural Society, Fruit and Floral Committees at
23rd	W	Society of Arts at 8 P.M.

APRICOT BRANCHES DYING.

WHOLE limbs or branches in some varieties of Apricots suddenly perish during the season of growth. This has been attributed to various causes, but judging by the very many examples of dilapidated Apricot trees to be met with throughout the country, no satisfactory means have at present been adopted to prevent the disaster. No apology is needed for directing attention to this perplexing subject, and it is introduced now in the hope that some light from one or other may be shed on the cultivation of this useful fruit that will keep it from waning still more than it has done in late years. Unless something be done, and promptly, it is not difficult to foresee that its culture in this country so far as profit is concerned will be given up altogether. In fact, so disastrous have been the effects of the last seven years' weather on the trees and crop alike that some have supplanted the injured trees with Plums, and it has even been advised to abandon the cultivation of Apricots altogether by more than one experienced cultivator.

Starting from the point that Apricots have been grown in this country equal or even superior to these from any other (for judging by recent importations "they do not do these things better in France," and that many cottage homes have derived as much money from the sale of the fruit as met the demand for rent) I shall endeavour to demonstrate that most of the evils attending Apricot cultivation is a consequence of over-stimulation under adverse climatic conditions. The growth of the trees is remarkable for luxuriance, but the elaboration of the sap is defective, resulting in gum or canker. Both are, according to modern ideas, attributed to the effects of cold, and there is much to warrant this conclusion; but the matter needs further elucidation, and in attempting it I must ask permission to go back to the time when flued garden walls having the best aspect were considered a necessity for the cultivation of the fruit under notice. This will take us to a period anterior to the introduction of cheap glass, of orchard houses, and of glazed copings for walls, these being the outcome of the disasters attending the attempts at growing Apricots under glass.

I shall not endeavour to show that our climate of late years has been marked by less sun or a diminution of temperature such as to preclude the profitable cultivation of the Apricot; but I must intrude upon modern notions by recording the fact that the advent of cheap glass, and its advocates for employment in the cultivation of exotic fruits, have taken such effect on

the minds of men as to completely revolutionise modern opinion in respect of the best means of growing fruit trees of the more tender description. This I shall not decry, as nothing has contributed so much to the advancement of gardening as an art and its diffusion among the masses as the availability of glass for the purpose of horticulture; yet the panacea seen in the employment of glass for the evils attending the cultivation of exotic fruits, or those that may not be classed as hardy in our climate, has unquestionably led to the neglect of trees cultivated on the old system, and the bestowal of more pains on those on the new. The present condition of Apricots demonstrates the degeneracy of the trees, and this must be placed to the account either of neglected culture or change of climate. If Apricots are grown as successfully under glass as they were not very remotely grown against walls their degeneracy is not proven, and climatic changes are surely not so sudden as to render the cultivation of an Apricot impracticable in the short space of a quarter of a century. If the earth keeps on cooling down, or the sun loses power at this ratio, we shall soon be told that Gooseberries must be grown under glass, or that it is better to give up the culture of everything our climate by skilful labour has produced in such high condition, throwing consumers on the supply of foreigners. Pine Apple culture has gone out of fashion, not because they could not be fruited profitably in this country, or that imported fruits were equal to them, but from the desire to have something different in their place. There is a reaction. Things that were once considered common, if not vulgar, are now being again grown with zest. It may be that the fashion of attempting to grow Apricots under glass is waning, and that there is some good to be had from their outdoor culture against walls. What little I have seen attempted with this fruit under glass has not left a very favourable impression. In brief, Apricot culture under glass compares very unfavourably with that on walls, and in this old way they will continue to be grown despite adverse climatic condition.

There have been always croakers—we have been going to the dogs in everything appertaining to gardening for nobody knows how long, and yet horticulture is as healthy, if not healthier, than ever, and so are many Apricot trees, despite gnarled and cankerous examples to the contrary.

I propose to ask attention to the causes of Apricot failures under the heads of Variety, Stock, Soil, and Climate, taking the last two together.

Variety is something, yet not everything, in Apricots. Breda is generally considered the hardiest, and next to this Blenheim or Shipley, closely followed by Royal and Orange. These are vigorous growers and require a high wall or building, for when the growth is restricted, and the roots are not proportionately limited to space, gumming is quite as prevalent in these as in any others; and where the soil is rich and deep the trees grow so luxuriantly as not to ripen the wood, which is seriously damaged by severe weather, dying back at once or directly after the appearance of the foliage in spring. This is particularly the case after a wet autumn, when the wood has not been properly ripened. These varieties are, notwithstanding, the hardiest, but the fruit is only fit for preserving. Brussels I ought to have placed next to Breda, if not

before it, in hardiness, and, like it, is only fit for the pot. Excepting for preserving purposes, all the above are not worth growing, although there are degrees of inferiority, Breda and Brussels being the poorest in quality, and neither Shipley nor Royal can compare with Moorpark.

Large Early, Oullins Early Peach, Hemskerk, St. Ambroise, and Kaisha have all good constitutions and not generally liable to gum, unless the soil be rich so as to induce strong growth in the early stages of the trees, and then nothing will save them from canker, as has been indicated in the hardier smaller-fruited varieties. Alsace is a very slight, if any, remove from Moorpark, as also are Hemskerk and Oullins Early Peach.

Moorpark and Peach are very much alike, if not identical; but the Peach is not so subject to decay of the branches as the Moorpark, which may be due to its being budded on the Brussels stock, whilst the Moorpark is worked on the common Plum or Mussel. Admitting that they are different, which is beyond my ken, both are notorious gummers, and the failure of Apricots from variety is to be attributed to the fact that everyone planting Apricot trees plants Moorpark. This is, to say the least, courting failure, as is done with Ribston Pippin Apple, the proclivities of which for canker are established, and yet it is planted again and again, in hope that it will cast off its constitutional diseases without departing from previous procedure. Moorpark being the most subject to gum or dying of the branches, why continue to plant it? It is the best of sorts! This is undeniable; but then there are others nearly as good if not quite equal to it in quality, as, for instance, Hemskerk, a hardier and earlier opening variety of Moorpark, which has not given any indications of gum under precisely the same conditions that Moorpark has died more or less under. Knight's idea that continuation by budding and grafting of a variety is likely to result in debility or death after the removal of the original by natural decay, receives some confirmation from the fact that varieties originated from it, of course by seed, are marked by healthier constitutions, if not robuster growth; for although Moorpark grows very vigorously and apparently healthy for a few years, it soon gives indications of enfeeblement and decay. Alsace is also a variety of Moorpark, being vigorous and hardy, and does not die off in pieces large or small like its prototype. Varieties, too, of the Peach Apricot—for instance, Oullins Early Peach and Large Red—have much better constitutions than the Peach Apricot; hence we may conclude that varieties of which the type is existent are more healthy than those continued indefinitely by budding of non-existent kinds as regards the originals on young or seedling stocks, as it is a well-known fact that stocks from suckers and layers are weak (debilitated through the age of the parent) and apt to cause gumming.

What I have to suggest as regards variety is to discard those kinds that give irretrievable indications of continued gumming and supplant them with those that are not so affected. I may mention Large Early, Hemskerk, Oullins Early Peach, Alsace, and St. Ambroise, with Shipley's for preserving, as not being prone to gum. The aim of the cultivator should be directed to raising seedling Apricots of hardier constitution, seedlings, as a rule, not being given to die

off in the limbs as do varieties worked on Plum stocks.—G. ABBEY.

(To be continued.)

PLANTING OUT GARDENIAS.

THAT there is a decided preference generally for Gardenias in pots is undoubtedly as true as that good reasons can be shown for such preference, the most important being the facility with which an early and successional supply of its fragrant flowers can be had, and the additional utility of such plants for "furnishing." But for an abundant supply of cut flowers in spring and early summer commend me to plants turned out of pots and thoroughly established in the soil of a convenient bed or border in a stove. "Have you seen the Gardenias at Maresfield?" said a friend to me the last week in March. "Yes," I replied, "I saw them soon after they were planted out last September, and thought them a promising batch of young plants." "Go and see them again now, they are quite worth seeing again," said he. I did so, and was certainly well rewarded, for the plants were a pleasant and instructive sight. There are fifteen of them planted in just such a narrow raised border on one side of a pit with a passage running along the middle, as one is accustomed to plant Melons or Cucumbers in for training on a trellis; but the Gardenias have had no training, and are mere bushes, handsome as could possibly be wished, notwithstanding each of them about 30 inches in diameter, a dense mass of deep green foliage, so thickly interspersed with flower buds that at a rough computation there must have been two hundred on each plant. The whole of them are *G. florida*; the flowers are very double, pure white, petals of great substance, very fragrant, and the few that were fully expanded measured nearly 4 inches in diameter. The soil in which they are planted consists of equal parts of peat and loam, fairly enriched with decayed horse manure. The plants were crowding each other, and the roots must have penetrated every part of the soil long before flower buds were visible. Mr. Thomas attributes much of his success with these plants to a low temperature in winter, 50° being the minimum night heat, especial care being taken that it should never exceed a maximum of 55°.

The system of culture which has thus been so successfully practised by Mr. Thomas will commend itself to many of your readers having small houses and limited means at their disposal, and will probably be more generally adopted than the equally valuable method of covering walls with it at Ashton Court as described by Mr. Iggulden on page 325, because of the greater amount of space required to do full justice to wall plants. Each plan is a praiseworthy step out of the beaten track in the culture of a deservedly popular plant, and both have been proved worthy of attention by the impress of success stamped upon them by the able gardeners under whose care and skill they have answered so well.—EDWARD LUCKHURST.

CATERPILLARS VERSUS CABBAGES.

IT is seldom Mr. Taylor requires correcting, but even in his case—sound as his practice and advice are generally and rightly considered—there appears an occasional paragraph which admits of lawful criticism. On page 357 in his sensible remarks on "Cabbage-growing and Cabbage-cutting," he writes:—"Mr. Iggulden grew a variety the year before last (and he might have added last year) which he considered more desirable than Ellam's, because, while the latter was riddled by caterpillars, his favourite variety escaped; but I confess I should be rather doubtful of a Cabbage which was not good enough for caterpillars."

Now among Mr. Taylor's various attainments not the least is the fact of his being a good entomologist. Consequently it is surprising to note that he credits caterpillars with a discrimination which the voracious pests do not in the least merit. At any rate, according to my experience, the discrimination, if there is any discrimination in the matter, is shown by the butterfly, the latter selecting a suitable feeding ground for the caterpillars which may be hatched from the eggs they deposit. Whether the butterfly shunned our smooth-leaved Cabbage, or the caterpillars when small tumbled off and broke their necks, in the same manner as thrips when treated to Mr. Taylor's paraffin mixture, I cannot

determine. One thing is certain, they did not eat the smooth Cabbage, but immediately adjoining these a breadth of Ellam's Early was completely riddled. Perhaps the caterpillars' instinct guided them to a superior feeding ground, at any rate this appears to be Mr. Taylor's impression. Ellam's is undoubtedly a first-rate variety, but I failed to see any marked difference in the quality of this and Reading All-Heart—the smooth variety in question. If smoothness of leaf, and consequent exemption from attack by caterpillars, be a sure indication of inferior quality, Mr. Taylor will not grow Gilbert's Chou de Burghley more than one season, and as a consequence that famous "mongrel" will not long retain its quality of "pleasing everybody."—W. IGGULDEN.

AGAPETES BUXIFOLIA.

A CHARMING relative of the *Vacciniums* and *Ericas* is this plant, and it is surprising that one so showy should continue comparatively unknown. Its culture is not difficult, though it

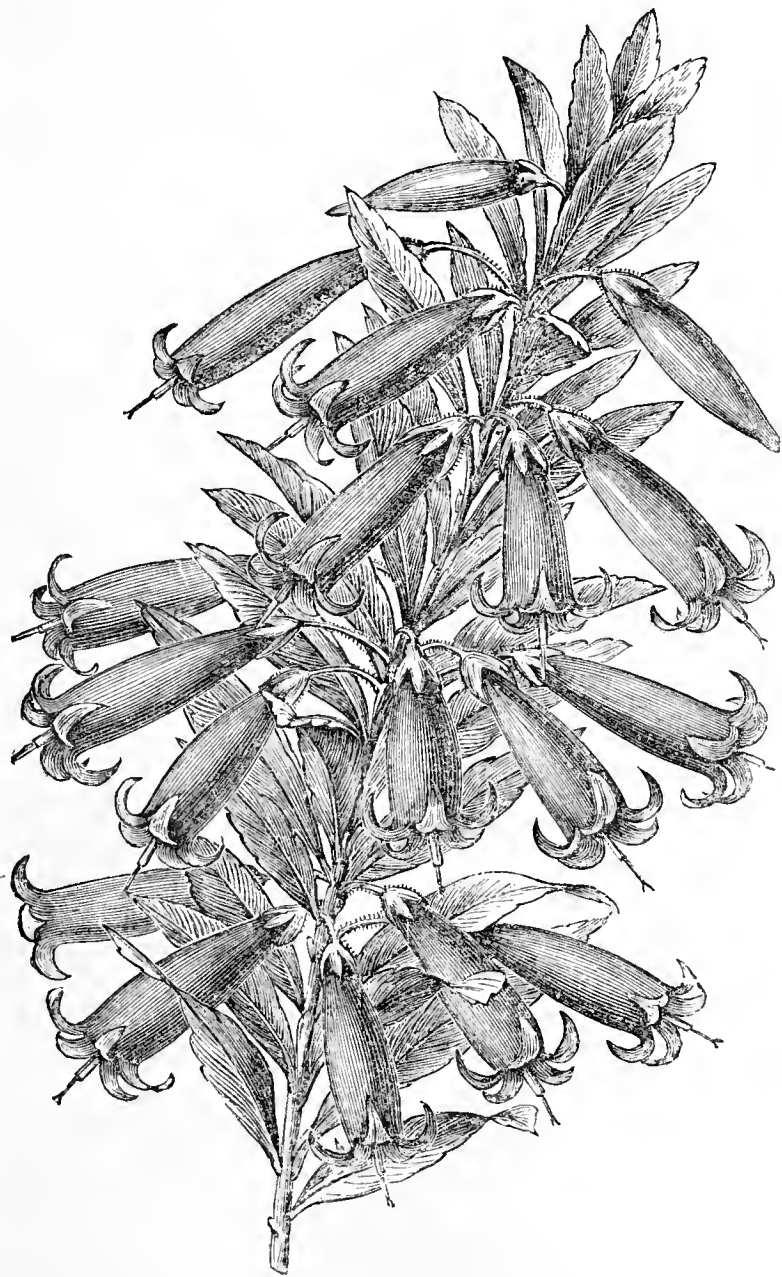

Fig. 91.—*Agapetes buxifolia*.

requires some careful attention; and that it well deserves, for when in first-rate condition and loaded with its rich scarlet tubular flowers few of its beautiful allies, the Heaths, can excel its attractions. A compost of good peat, a little turfy loam, and sand suit it if the pots be thoroughly drained; and the only other special care needed is to supply water regularly but in moderate quantities, never allowing the soil to become excessively saturated or on the other hand too dry, either being fatal to the plant. A little pruning will be required to keep the plant in shape, or it is likely to grow rather straggling.

THE NURSERY SICK FUND.—Mr. Illman (page 360) does not, to the best of my knowledge, make any acknowledgment to the

Managers of the "Nursery Sick Fund" of those nurseries who furnished him at his own request with the plan and conditions of the fund. As the Association has been self-organised and is self-supported and is working successfully, I think the Managers are entitled to thanks from those whom they have loyally assisted.—T. FRANCIS RIVERS, *The Nurseries, Sawbridgeworth*.

LARGE VERSUS SMALL BUNCHES OF GRAPES.

AS a rule Grape-growers, and especially young growers, always strive to secure their bunches of Grapes as large as possible, which is thought to indicate high cultivation, and no doubt it does; but I am strongly of opinion that unless there is a special demand for the large bunches, the most satisfactory crops are those composed of medium-sized bunches. If the Vines are in fairly good health bunches of medium size never fail to become of high quality, and this is not always the case with the very large ones; and another of the strongest points in favour of medium bunches is the long time a houseful will last compared with the extremely large clusters. From two houses here I cut Grapes weekly for seven months. They contain about 200 bunches, each giving an average of twelve bunches per week, and cutting them daily they are always fresh, but if they were large bunches our supply would be altered altogether, and that for the worse. The bunches now are each about 2 lbs. in weight, but if they were averaging 5 lbs. or 6 lbs. we could not have half the number, and they would not be so serviceable in the house as the large bunches, although looking well when placed on the table at first, soon lose their bloom and flavour. Very often a large bunch is sent to the table so many times that a great portion of it is never used in the dining room in the end. Bunches of Grapes of any kind, weighing about 2 lbs. large in berry, deep in colour and bloom, are in my opinion the perfection of Grapes.

On some of our Gros Colmans just newly thinned we could have had many bunches 3 lbs. in weight by allowing the bunches to remain entire and not cutting away any of the side shoulders, but then there might not have been more than fifteen bunches to a rod, but by reducing them in size we have thirty useful bunches on some rods.

I have said that large bunches indicate high culture, but I think there are exceptions to this too, as I can remember having seen innumerable very large clusters at shows and elsewhere by no means indicating high culture, the various-sized berries and unfinished colour making them much less valuable than the small highly perfected bunches. Some growers who can barely manage to secure a respectable crop of Grapes of any description cannot understand others reducing the size of their bunches from choice, but in my opinion those who do so act wisely.—A KITCHEN GARDENER.

DAHLIA IMPERIALIS.

CAN any of your readers tell me if they have succeeded in blooming *Dahlia imperialis*? I admired it very much when I saw it for the first time at Cannes, and last year I obtained two tubers. One of them I planted in a cool greenhouse after it had made 2 or 3 feet growth, but it was eaten quite through by a large slug; the other I tried out of doors in a warm place, but I did not succeed in getting a bloom. This year I have one of the tubers growing in a large pot in a warmer house, and it has already made about 4 feet of growth, and the stem more than three-quarters of an inch in diameter, but there is no sign of any inclination to bloom, and I want to know whether anyone has been successful with it, and if so what is the best treatment?

Arundo Donax variegata, another plant I admired at Cannes, makes a beautiful centre plant for a bed, and is nearly hardy enough to stand the winter, and it is a fine decorative plant for the greenhouse.

We are very backward here with spring flowers, and I find not only that Pear tree blossoms suffered from the severe weather in March, owing to their having been so forward, but even some of the forwarded Apple blossoms are injured.—C. P. P.

[*Dahlia imperialis* is a very strong grower, as you are doubtlessly aware, attaining the height of 10 or 12 feet, or even more, and as it flowers late, blooms must not be expected to show for a considerable time yet. No doubt you will succeed in flowering it in the warmer house, as it will not thrive out of doors, and the temperature of an ordinary plant stove is not too great for it later in the season. It requires very rich soil, and when grown in pots we have found it much benefited by a top-dressing of manure. Water must be liberally supplied, but after flowering the plant must be thoroughly dried off and the tubers ripened, when they can be placed in any cool place safe from frost.

Arundo Donax is hardy in the south of England; it needs abundant supplies of water in the summer.]

BATH FLORAL FÊTE.

MAY 9TH.

The Bath Spring Show was held, as usual, in the Sydney Gardens, and although scarcely so good as that produced last season, the Exhibition was highly creditable to all concerned. The weather was fine though cold, and numerous appreciative visitors thronged the gardens.

AZALEAS.

Liberal prizes were offered for Azaleas, and of these several fine groups were in competition. The best twelve were staged by Mr. W. Long, gardener to C. Gardiner, Esq., and consisted of grandly trained and flowered pyramids, ranging from 5 feet to 9 feet in height—in fact a much better group it would be difficult to find. Stella, Charmer, Roi d'Holland, Souvenir du Prince Albert, Model, Iveryana Improved, The Bride, Flag of Truce, and Advancer were particularly good. The second prize was awarded to Mr. C. H. Keel, gardener to Col. Landon, his group including several well-flowered specimens. The best nine were staged by Mr. F. Bigg, gardener to J. C. Hurle, Esq., among these being well-flowered pyramids of Model, Duc de Nassau, Sir C. Napier, and Criterion. Mr. W. C. Drummond had a fair group, and was awarded the second prize. With six Azaleas Mr. G. Hallett, gardener to Mrs. West, took the lead, his informal pyramids being very creditable. Mr. W. J. Mould, gardener to E. E. Bryant, Esq., was a good second. The best twelve "newest and best" Azaleas were shown by Mr. W. Long, these including neat little plants of J. Gould Veitch, Jean Nuytens Verschaffelt, Neptune, Sigismund Rucker, Madame Louise Van Houtte, and M. Joseph Lefebvre. In Mr. W. C. Drummond's second-prize twelve the most promising were Flambeau, Comtesse de Kerchove, Rosea picta, and Louise Lubbens. The best single specimen Azalea, a finely flowered pyramid of Stella, was staged by Mr. W. Long, Mr. Drummond following with a capital pyramid of Madame Millez.

STOVE AND GREENHOUSE PLANTS.

We missed the fine group of stove and greenhouse flowering plants usually exhibited by Mr. Cypher, but the position he filled last season was worthily occupied by a local exhibitor, Mr. W. Long, who rather easily beat the formidable Mr. Tudgey. Mr. Long's group of twelve plants consisted of capitally flowered specimens of Erica Cavendishiana, E. Vernoni superba, Genetyllis tulipifera, Ixora Williamsii, Anthurium Schertzerianum, Rhododendron Gibsonii, Pimelea mirabilis, Medinilla magnifica, Ixora Prince of Orange, Boronia elatior, and Genetyllis Hookeri. In Mr. Tudgey's group were good examples of Anthurium Schertzerianum, Hedaroma tulipifera, Apelexis macrantha purpurea, Erica Cavendishiana, and several very poor Azaleas. The third prize in this class was awarded to Mr. C. H. Keel, many of his specimens being creditably flowered. In the class for nine stove or greenhouse flowering plants Mr. W. F. Bigg took the lead with fair-sized and well-flowered specimens of, among others, Ixora amabilis, Acrophyllum venosum, Genetyllis Hookeri, and Clerodendron Balfourianum. Mr. J. F. Mould occupied the second position with a rather uneven lot, the best of which were a fine plant of Bougainvillea glabra, a good Boronia pinnata, and Azalea Magnificent. The third prize went to Mr. W. C. Drummond. Mr. G. Tucker, gardener to Major W. P. Clarke, had the best six specimens, among these being Anthurium Williamsii and Erica Cavendishiana in good condition. Mr. J. Mould was a good second, and was closely followed by Mr. H. Jones, gardener to General Doherty.

FINE-FOLIAGE PLANTS.

Ornamental-foliaged plants were shown in small quantities, and were not remarkable for quality. Mr. Tudgey staged the best fifteen specimens, these including Areca Verschaffeltii, Croton Mortii, Pritchardia pacifica, Geonoma gracilis, and Cocos Weddelliana. Mr. W. C. Drummond followed with a group including Yucca aloifolia, Ananassa sativa variegata, and Cycas revoluta; while Mr. J. F. Mould took the third prize with a decidedly superior group. Among the latter were highly coloured examples of Croton Sunset, C. Queen Victoria, Dracæna Baptistii, Cycas revoluta, and a fine specimen of Gleichenia rupestris. The best nine fine-foliaged plants were staged by Mr. A. Shadwell, gardener to S. Chandler, Esq., among these being a good Croton majesticum, Dracæna Hendersonii, and D. australis. Mr. G. Hallett took the second prize. A good plant of Cocos Weddelliana gained Mr. Tudgey the first prize for a single specimen fine-foliaged plant, Mr. J. F. Mould following with Cocos Weddelliana in good condition. With an exceedingly well-grown and flowered Genetyllis tulipifera Mr. F. Bigg took the lead in the class for a greenhouse plant, Mr. W. Long following with the same variety.

ERICAS.

Two groups of six Ericas were staged, Mr. Tudgey taking the lead with somewhat overtrained specimens, including E. mutabilis, E. mirabilis, E. ventricosa magnifica, and Hartnelli virgata. Mr. J. F. Mould had Erica Lindleyana, E. affinis, and E. ventricosa grandiflora in good condition, and took the second prize. The best single speci-

men Erica, a good plant of E. Cavendishiana, was staged by Mr. W. Long, Mr. J. Mould following with E. Victoria, and the third prize went to Mr. Biggs.

ROSES.

Roses in pots were well shown, and found hosts of admirers. The best twelve, staged by Mr. J. F. Mould, Pewsey, included well-flowered specimens of Hybrid Perpetuals Paul Verdier, Dupuy Jamain, Madame Lacharme, Marquise de Castellane, Marquise Adèle de Murinais, and Noisette Célie Forestier. The second-prize group, staged by Mr. M. Cole, gardener to R. B. Cater, Esq., included good specimens of Rubens and Souvenir d'un Ami, Etienne Lévê, Madame Gabriel Luizet, and Souvenir de la Malmaison. With six Roses in pots Mr. W. Smith took the first prize with untrained freely bloomed plants of Teas Devoniensis, Niphetos, Jean Ducher, Safrano, Souvenir d'Elise, and Maréchal Niel. The second prize was awarded to Mr. A. W. Southard, gardener to T. J. Walker, Esq.; the remaining prize going to Mr. A. Hawkins, gardener to T. Jolly, Esq., both exhibiting creditably.

PELARGONIUMS.

Several groups of the different kinds of Pelargoniums were staged, the majority being very well flowered. With nine large-flowered varieties Mr. J. Mould took the lead, the most noteworthy among these being Kingston Beauty, Rose Celestial, Harlequin, and Triomphe de St. Amand. Mr. H. Jones was worthily awarded the second prize. Mr. John Mattock and Mr. F. Biggs were respectively first and second for six varieties, the former staging freely bloomed untrained specimens. Mr. F. Biggs had the best six Fancy varieties; of these the specimens of Ellen Beck, Anne Page, Madame Sontag, and Delicatum were the most noteworthy. The same exhibitor staged the only six spotted varieties, and of these Aladin, Chameleon, and Conspicua were very good.

Cinerarias were well shown by Messrs. J. Southard, gardener to General Hope; Burrige, gardener to S. Butler, Esq.; and M. Cole; and Calceolarias proved especially attractive, and excellent groups were shown by Messrs. W. Burrige; W. Marchant, gardener to J. Murch, Esq.; and J. Mould, who took the prizes in the order named in each instance.

Ferns and Mosses were not shown so well as usual, the majority of the specimens being small. The best group of fifteen varieties, arranged by Mr. G. Tucker, included some creditable examples. Mr. J. Coke, gardener to A. P. Stancomb, Esq., secured the second prize with a healthy even group; the third prize going to Mr. W. C. Drummond. In the corresponding class for nine specimens Mr. C. H. Keel took the lead. The remaining prizes were awarded to Mr. H. Jones and Mr. J. Mould.

CUT FLOWERS.

The classes for cut flowers were well filled, and so many admirers did the Roses, Pansies, Tulips, and bouquets attract that a great difficulty was experienced, as on previous occasions, in taking notes. Roses were particularly good, notably the first-prize stand of eighteen blooms exhibited by Mr. Cole. Of these the best were Mons. E. Y. Teas, Rubens, Maréchal Niel, Sir G. Wolseley, Jean Pernet, and Madame Marie Verdier. Mr. H. Fisher took the second prize, his stand containing a very fine bloom of Rubens. Tulips were shown creditably by Messrs. H. Hooper, M. Cole, and W. Meddick, who received the awards in the order named. Mr. Hooper staged the best twenty-four Pansies, and was followed by Mr. Meddick. The latter exhibitor staged a remarkably fine stand of twelve Pansies, and was followed by Mr. A. T. Hall. The competition in the class for twenty-four bunches of cut flowers was very close and good. Mr. J. Mould took the first prize, his collection including several choice Orchids; and Messrs. G. Howe, gardener to L. Fry, Esq.; Mr. O'Brien, gardener to Mrs. King; and Mr. H. K. Ward, gardener to W. H. Budgett, Esq., were the other successful exhibitors, all staging choice collections.

Bouquets occupied a considerable space, but the majority of them were too closely packed. Mrs. L. Shackell easily secured the first prize, and was followed by Mr. M. Hookings and E. S. Cole, gardener to W. Pethick, Esq. Vases and epergnes again were highly creditable, notably those shown by Messrs. H. S. James, gardener to A. Laverton, Esq., M. Hookings, and E. S. Cole, who secured the awards as named. Miss Watson Taylor sent a splendid box of Tea Roses, and these were worthily adjudged a certificate of merit. Mr. Henry Hooper staged several boxes of superior Pansy blooms, as well as Aniculas and Primula cortusoides in variety, all not for competition. Mr. Parker had a basket of Rhododendron J. Nelson, and Mr. Tomkins Pelargonium blooms and plants.

FRUIT.

Fruit, with the exception of Strawberries, was not extensively shown. Mr. A. Miller, gardener to W. H. Long, Esq., was the only exhibitor of a Pine Apple, and received the first prize for a good Queen. Messrs. J. Carpenter and T. King, gardener to R. V. Leach, Esq., were the only exhibitors of Grapes, and were respectively awarded the first and second prizes for small and fairly well-coloured bunches of Black Hamburgh. Mr. W. Burrige had Uvedale's St. Germain Peas in fine condition, the second prize going to Mr. E. Thomas for the same variety. A good dish of Pearson's Plate secured Mr. A. Southard, gardener to F. J. Walker, Esq., the first prize for Apples, Mr. E. Jones following with Spring Ribston.

The Strawberries were particularly fine, Mr. J. Burridge taking the lead with Oscar, Mr. H. Jones following with Dr. Hogg, and Mr. Howe was third with Sir J. Paxton. Mr. Burridge also secured the first prize for Strawberries in pots, the variety again being Oscar. Mr. A. Shadwell followed with President, only slightly inferior, Mr. M. Cole taking third place with Sir C. Napier, and Mr. J. Weston had a fourth prize, all staging most creditably.

VEGETABLES.

Vegetables were, considering the season, very well shown. Mr. M. Barnfield took the lead with nine varieties, his collection including good Asparagus, Mona's Pride Potatoes, Peas, and Tomatoes. The second prize was awarded to Mr. J. Weston for a good lot, of which the best were Early Munich Turnips, Minimum Peas, and Late Queen Broccoli. The third prize was awarded to Mr. H. Scott, and the fourth to Mr. E. Fisher. Mr. J. G. Kitching had the best six varieties, these consisting of fine Asparagus, Telegraph Cucumbers, Webb's Royal Ashleaf Potatoes, Late White Broccoli, Canadian Wonder Beans, and Trophy Tomatoes. Mr. Arthur Beavis was a good second, and the third prize went to Mr. F. Mead, gardener to J. G. Holme, Esq. The best dish of Potatoes, fine examples of Mona's Pride, was staged by Mr. W. Burridge, Messrs. J. G. Kitching and John Shellard taking the remaining prizes. Quantities of good Cucumbers were shown; of these the best, a good brace of Carter's Model, were shown by Mr. G. Pymm, gardener to J. Gouldsmith, Esq., Mr. H. Beavis and Mr. A. Beavis taking the remaining prizes in the order named. Mushrooms were well shown by Messrs. G. Wiltshire and G. Pymm; Beans by J. G. Kitching, H. Jones, and W. Haskell, who took the prizes as named in each instance. Mr. W. Burridge showed William I. Peas in excellent condition, and was awarded the first prize. Mr. J. H. P. Westcott, Star Cross, Devon, took the first prize for Asparagus with extra fine examples, and he also staged fine bundles not for competition.

THE BARDFIELD OXLIP.

I OBSERVE on page 386 a mention of this by Dr. Hogg. I have grown it for several years in two or three spots near a north wall in my garden in Cheshire, giving it several square yards to itself. I dig up most of the older plants after flowering every year, so as to give the seedlings which come up in thousands in June room to develop. These flower when a year old, but produce the finest flowers when two years old. The mass of flowers produced by the plants in April forms one of the prettiest objects in my garden. Most of the seedlings come perfectly true, but some assimilate themselves more or less to the different forms of English Oxlip. I noticed one which had the light colour of the Bardfield and the one-sided habit, but round open flowers as large as a full-sized Primrose. These I gather to keep the Bardfields as far as I can true to variety.

Some years ago I wrote some notes in the *Journal of Horticulture*, observing that the garden Polyanthus, if allowed to grow from self-sown seed, degenerates in two or three generations into a common Cowslip. I am still of the same opinion, and every year see additional reason for thinking that Linnæus was right in classing Primrose, Cowslip, and Oxlip together as one species. A few days ago I gathered on the Little Orme's Head a bunch of Oxlips and Cowslips, from which I picked a series from the largest Oxlip to the smallest Cowslip, in which no line of separation could be drawn in size or colour. We are often told in books on English flowers that there are two distinct forms of English Oxlip, one the colour of the Cowslip, the other of the Primrose, but it is easy enough to find every intermediate shade. Polyanthus-formed Primroses and one-flowered stalks of Cowslip, though abnormal, are sufficiently common to justify their being used as an argument for identity of species.—C. WOLLEY DOD, *Llandudno*.

NORTHWARDS—CLOVENFORDS.

THE CORRECTOR-GENERAL OF GARDENERS.

AS I was pretty certain that someone would endeavour to make a little literary capital out of my remarks (page 313) on the Grapes in the establishment under notice, I waited for the anticipated impeachment. It has, I perceive, duly appeared in another medium, and in a manner to which I have not the slightest objection. It is very gentle criticism, and the writer is so generous as to state that my "accuracy is usually unimpeachable," but a "valner" would be less "misleading." This latter is a favourite word with the corrector-general, and I am bound to say, as used by him, does not appear to carry its normal weight; in fact, I suspect it is not intended to imply anything serious, but comes in conveniently for making a line or finishing a sentence. My critic suggests that awkward angular clusters with great shoulders jutting out—monstrosities, can be packed to travel as well as handsome,

compact, well-shaped bunches; but he knows better. Again, he would imply that such a crop of Grapes of the first size and quality as I imperfectly described is a very moderate and commonplace yield, but he knows better; if he had grown it, it would have been grand. And yet once again, if I am not inaccurate, I have seen Grapes both on Vines in charge of the writer to whom I am alluding, and off them in London; in fact I may almost venture to say I have been present at their unpacking, and there were no such awkward clusters and great jutting shoulders as are too often seen now a-days, and which no one can pack to arrive at their destination in the best condition. We thus arrive at a point—a curious point rather—that a very ready writer and experienced gardener grows such Grapes as I endeavoured to commend, and to which he refers slightly, and does not produce such as he to an ordinary reader would appear to extol, and which I denounced mildly. Thus we get in a maze—the usual result where criticism for the sake of criticism is indulged in, and the critic has placed himself, in this case, in the singular position (for the first time in his life probably) of disparaging his own Grapes; in fact, he cannot honestly and consistently, on the lines he has himself laid down, condemn Mr. Thomson's produce without condemning his own more effectually. I am sorry this is so—that there has been any attempt to detract—as the examples I have seen of both growers deserved a better fate. The truth is there is no real difference between us in our estimate of Grapes that we see (and I think we have judged them together); but in the question of the magnificent crops at Clovenfords, it so happened that I examined them carefully and my critic did not see them at all, and therefore readers of gardening literature can conclude if they like that he must know their character and condition better than I do, and I leave the matter with them.

To the best of my knowledge I understated the weights and character of the crops previously referred to, and I will not over-estimate those that have yet to be noticed; but I must speak the truth, even at the risk of being accused of exaggeration. I repeat that never in all my travels have I seen such crops of Gros Colman and Lady Downe's Seedling as those at Clovenfords in September, and I have not one word to withdraw nor one sentence to modify of what I have written respecting them; and now I have to speak of that grandest of all white Grapes—

THE DUKE OF BUCCLEUCH.

Like others I had read descriptions of this Grape "at home," and they all agreed that the wonderful crops were produced under the same conditions as Black Hamburgs. I found this precisely so as regards soil and temperature, for both these varieties are grown in the same house and border; but there is a most important difference that has not been made sufficiently clear, and this is in the method of pruning. The Black Hamburg is pruned on the ordinary close-spur system, but the Duke is not. Most of the crop had been cut on my visit, very few Black Hamburgs being left, and only a patch of the Duke quite in the centre of the roof; but it was a wonderful residue, for it indicated that, at Clovenfords at least, instead of this variety being shy, it is as free as any Grape in cultivation. When I state that it was impossible to place a closed hand between the bunches without touching some of the berries, I state a fact which cannot be explained away by any curious examples of arithmetic, such as showing that 25 lbs. of Grapes in a space of 6 feet by 3 feet, gives "something under 1 lb. to every 2 square feet of space." Passing from school exercise I have ascertained that, according to the evidence of the weighing machine, the entire crop of Gros Colman was of nearly twice the weight of that arrived at by the "enchanted" arrangement of figures. So far from exaggerating, I now find I both under-estimated the weight of the crop and over-estimated the length of the rafters. I dare not say the weight of the Duke in a similar space to that above noted, 6 feet by 3 feet, was much, if any, less than Gros Colman. The bunches ranged from 1 to 3 or 4 lbs., being furnished in the most regular manner with berries such as no other white Grape can produce—clear, perfectly ripe, and of the finest quality. In flesh and flavour this is distinct from all other Grapes; "like a sweetmeat" has become the popular, as it is an accurate description, with a volume of sparkling champagne-like juice.

METHODS OF VINE-PRUNING.

The Vines that were bearing so heavily were practically managed on the long-rod system. This is different from the "extension," and both of them are older than I am. The latter means Vines that are spur-pruned, but which are allowed to extend, or produce many rods from the same stem until one Vine fills a house, or as much of it as is required; but all the rods closely spur-pruned nevertheless. The former—the long-rod—

means that young canes are trained to the roof their full length, or as the cultivator wills, and the crop is produced from the buds on this young, or last year's growth, and not from spurs of older wood, the rods that have borne the crop being cut away. Or to put it in another and simpler way, the Vines are pruned the same as Raspberry canes, the older being cut away and the young retained. This is information for the young gardener and inexperienced amateur, and given because it has been sought for. The Duke at Clovenfords is not worked on this plan in its integrity, but it partakes more closely of it than any other, as the skilled cultivator exercises his judgment, deviating more or less from strict rule, and the crop testifies to the soundness of the practice. Instead of thick closely-spurred rods several years old trained at intervals of 3 feet, the roof was covered with young canes, like so many stout young Vines, at intervals of a foot or more, and finer wood of any variety of Grape it would be difficult to find. These canes are pruned at different lengths according to the character of the buds, and in this way Mr. Thomson has no difficulty in covering a roof as thickly as he pleases with fine bunches of this splendid Grape.

Because many persons have failed in growing the Duke it has been denounced as worthless. That is an unjust verdict. Nor is it fair to brand any man with incapacity who has failed to succeed with it. I have known some gardeners fail utterly who have grown other Grapes admirably, and then after a lapse of years they have "had another try" with the Duke and succeeded. At Chiswick, for instance, it has failed to flourish; but I recently saw some Vines planted this season growing there in the most satisfactory manner. Why this change?

THE ENERVATION AND RESTORATION OF VINES.

I remember a new Grape being certificated, and the following year observed the propagation of the variety in a nursery. There was a demand for Vines, and that demand had to be met. Not only was every eye that could be obtained inserted, however weak and unripe the wood, but immediately a Vine had grown 3 or 4 inches the top was taken off and struck as a cutting, this young plant again being topped in turn and struck, and so on as fast and as often as cuttings could be had. So small were some of these that a dozen of them were dibbed in sand in a 5-inch pot and struck in a hot propagating case, and hundreds of the Vines when potted off were no thicker than knitting-needles. What Vine could endure that without having its constitution impaired, if not ruined? I would not plant Vines thus raised if they were given to me, and ten certificates had been awarded for the Grapes borne by the parent Vine. Has the Duke of Buccleuch Grape ever been subjected to this high pressure and unnatural system of propagation? I do not mean by its raiser, but by those who have purchased canes when they were at a necessarily high price, and endeavoured to "make the most of them." If so, the marvel to my mind would be that persons should succeed in its culture, not that they should fail.

Some years ago the press sounded the praises of that really valuable Grape, Mrs. Pince's Black Muscat, and extolled the wonderful productiveness of the Vine, the fine fruit and its superior quality. The demand for Mrs. Pince was enormous and propagation excessive. What has been the result? This—not one Vine out of a hundred that was so raised and planted has in any sense equalled those originally raised from matured wood. I was fortunate in procuring one of these, which was planted with others in a mixed house with Lady Downe's, Muscat of Alexandria, Alicante, and Black Hamburg, and Mrs. Pince took the lead of them all in growth, and produced more fine bunches than it could carry. Other persons saw this Vine, ordered others, planted them, gave them the best possible treatment, but they refused to thrive, and after long waiting they were eventually removed. Not one of these later-purchased Vines, so far as I know, exists now. Mr. Taylor of Longleat, the grower of Mr. Meredith's Grapes, which my gentle critic praises so highly, had, I believe, this Grape in prime condition at Garston. What more natural than that he should plant it at Longleat? It did not satisfy him for a long time, but with the knowledge of the intrinsic excellence of the Grape, and his patience and perseverance, to which he owes so much, he has at last, he thinks, after years of watching and tending, restored the pristine vigour of the Vine, and the fruit last year has probably never been excelled. There are also now plenty of other good examples in the country, and there is reason to hope that the restoration period has succeeded the epoch of enervation with this Vine. Let us hope it is the same with the Duke of Buccleuch. One fact I can vouch for, that Vines of Mrs. Pince, and others of the Duke raised from the matured wood of strong fruiting Vines, are now growing as well as anyone could desire.

It is not wise hastily to condemn either a Vine or those cultivators who are not successful in growing it. The variety may in

itself be good and the cultivators not at fault at all, but simply the victims of circumstances over which they have had no control. This has presumably been so in the case of the varieties referred to, and I hope to live to see many such gratifying examples of the Duke as at Clovenfords and Drumlanrig, and of Mrs. Pince's Muscat as it is produced at Longleat.

EXPRESS GRAPE-GROWING.

Muscats are grown at Clovenfords in two lean-to ranges 1000 feet long each. These were originally devoted to market plants, and there is only convenience for very shallow borders. Considering this the crops were wonderfully fine, but less striking to a stranger than Gros Colman, Lady Downe's, and the Duke. As an instance of good culture and quick returns in Grape-growing it is highly worthy of record that when the work was commenced here eyes were inserted in 1870, and Grapes to the value of £500 were sold in 1871 from supernumeraries. I should like to say something about the borders, but can only say now that they are *not* composed of rich turfy loam. No, the roots are bristling through the surface in a thin layer of material rich in Vine food; below the soil is "clung," fibreless, exhausted, and is being renewed by degrees.

HEATING.

It has been stated that five miles of piping are employed for heating the structures in the Tweed Vineyard. In the large vineries there are twelve rows of 4-inch pipes. Formerly there were only eight rows; but the proprietor, finding that the crops were not only the heaviest at the warm ends of the houses but the Grapes were so much better as to realise decidedly better prices, he felt warranted in incurring the expense of adding other four rows, or a length of at least 800 feet in each house. The results have proved the wisdom of the step. Apart from the question of temperatures as indicated by degrees, it may be observed that a liberal provision of piping effects a direct saving of fuel, and that the temperature of a house produced from a moderately heated surface is more conducive to the health of Vines or any other plants than that from a highly heated surface, as the fewer the pipes the hotter they must be made and the fiercer must be the fire to maintain the requisite amount of heat in a house. I am not able to say what precise temperatures are maintained at Clovenfords during the setting and swelling periods; but being a commercial establishment the idea cannot be for a moment entertained that fuel is burned needlessly. The conflicting views on high *versus* low night temperatures for Grapes are a little perplexing to many; but the differences are reconcilable, and when I have the requisite data I will undertake to solve the problem, unless someone else saves me the trouble of doing so.

PACKING GRAPES.

The Grapes are packed in wickerwork baskets, like ladies' work-baskets, these being both light and cheap. Each basket holds about 8 lbs., and eight baskets are placed in a box and sent on their 400 miles journey, arriving, as I have seen, fit for the exhibition table. The material employed in packing is paper shavings specially prepared, at a cost of about one-twentieth of a farthing per pound. This is found to be the best material.

ORCHIDS.

Orchids, now grown in what were once Pine pits, demand more than a passing glance. The collection is most extensive, and the vigour of the plants remarkable. Of Cattleyas—Trianae, Mendelli, and others—there are hundreds, also of Cypripediums, C. Boxalli and other strong growers being treated with Vine manure, having leaves like *Imantophyllums*. *Masdevallias* are similarly healthy, also *Odontoglossums*, *O. Alexandrae* having spikes with eight branches, *O. Andersonianum* also branched, with many others, and a fine stock of *Vandas*. Cut flowers from this collection have recently been honoured at South Kensington, and those who saw them will not question the accuracy of these remarks, any more than competent gardeners who saw the Grapes will suggest that my notes relative to them are not fully warranted.

The Tweed Vineyard is an establishment of which not only the owner has reason to be proud, but the country. I know of no place more worthy of a visit in September than this, nor of one where a horticulturist will meet with a more pleasant reception. To Mr. Thomson and his family my thanks are due, and are hereby most earnestly if insufficiently recorded.—J. WRIGHT.

VICOMTESSE HERICART DE THURY STRAWBERRY.—Relative to my statement as to the weight of the fruit of this Strawberry (1½ oz.), I did not infer that that was the average weight of the berries; but

if fruits (true) had not turned the scale at that weight I should not have published the fact, and did so only to show that the Vicomtesse was doing so differently with me to what it was with a previous correspondent.—S. TAYLOR.

RHODODENDRON DALHOUSIÆ.

A FEW weeks ago a correspondent sent us a truss of a beautiful seedling Rhododendron, as the "result of a cross between R. Edgeworthii and R. Gibsoni." This was so different from what we should expect from such a cross, and to our mind so much like R. Dalhousiæ, that we sent the seedling to an acknowledged authority on Sikkim Rhododendrons, Mr. J. H. Mangles, who returned the following interesting reply:—

"The flower and leaf sent to me are those of Rhododendron Dalhousæ, a beautiful species discovered by Sir Joseph Hooker in Sikkim, and also described by Griffith earlier as occurring in Bhotan. There would appear to be at least two varieties of the species, one with yellowish flowers (as in the present case) and another with pure white flowers, this latter being the rarer of the two. Mr. Anderson-Henry has raised a beautiful hybrid between R. Dalhousæ and R. formosum, which resembles very much the white variety.

"Sir Joseph Hooker describes this plant as an epiphyte on the trees lining his path as he ascended to Darjeeling. The magnificent lemon-scented blossoms were falling in profusion as he passed, and I never see the flower without remembering that this was the prelude to the grand Rhododendron discoveries then about to be made in Sikkim and Nepal, which have enriched our gardens and houses with treasures of the rarest beauty.—J. H. MANGLES, *Valerwood, Haslemere.*"

The raiser of the seedling alluded to has since, in answer to an inquiry, informed us that he now finds that the pollen with which R. Edgeworthii was fertilised was obtained from R. Dalhousiæ and not from R. Gibsoni, hence the pollen-bearing parent has been essentially reproduced, and the seedling cannot be regarded as a distinct variety.



WE may remind our readers that the ROYAL HORTICULTURAL SOCIETY'S SUMMER SHOW will take place next Tuesday and Wednesday, May 22nd and 23rd, when, in addition to the numerous prizes offered by the Society, several special prizes are contributed by Sir Trevor Lawrence, Bart., for a collection of twelve Orchids, made-up specimens not admitted. The Veitch Memorial prize for a specimen stove and greenhouse plant, Orchid, and three bunches of Grapes. Messrs. Sutton & Sons, Reading, offer several prizes for Calceolarias, Cucumbers, Tuberos Begonias, Gloxinias, Peas, and Endive; and Messrs. Carter & Co., High Holborn, give five prizes for fruits of Blenheim Orange and Emerald Melons. Entries in all the principal classes are numerous, and a satisfactory exhibition is confidently expected. It will be held as usual in the large marquee at the lower part of the gardens.

— WE have received an intimation that the sale of the late M. J. DECAISNE'S LIBRARY will take place in Paris at 28, Rue des Bons-Enfants, from Monday the 4th to Saturday 23rd of June next. Catalogues are now ready, and consist of 3264 lots of works in almost every European language on botany, horticulture, floriculture, agriculture, natural and physical sciences, and miscellaneous works. M. J. Decaisne, it will be remembered, was a member of the Institute and Professor at the Museum. Copies of the catalogue can be obtained of M. Labitte, 4, Rue de Lille, Paris.

— THE BATH AND WEST OF ENGLAND SOCIETY will hold their annual Exhibition at Bridgewater on May 28th to June 1st, and we learn that the horticultural portion is likely to be more

than ordinarily successful this season. The Hon. and Rev. J. T. Boscawen has been making strenuous efforts to add to the attractions, and offers two prizes for Orchids, £10 for the best group and £5 for the best specimen, which will be given in cups or money. Lord Fortescue's handsome Tree Ferns, Palms, and Orchids from his estate at Castle Hill, South Molton, will also form a great feature in the display, and no doubt many persons will avail themselves of the opportunity to see this collection, which is shortly to be dispersed. Much credit is due to Mr. Boscawen for his continued exertions on behalf of this Show, which may be confidently expected to prove highly satisfactory to all who have the good fortune to witness it.

— MR. WRIGHT'S treatise, "MUSHROOMS FOR THE MILLION," is at last ready, and is offered at a price, 6d. (7d. post free), that brings it within the reach of all. It can be had bound in cloth 1s., post free, 1s. 1½d. In addition to the articles that have appeared in this Journal, twelve modes of growing Mushrooms are described, and letters are embodied from Mr. Barter, Mr. Burbidge, and others; instructions are given for establishing Mushrooms in pastures, and evidence is adduced showing the remarkable effects of salt in promoting their growth. We understand the issue of the manual has been postponed till now in order that beginners in Mushroom culture in the open ground may have time to study it, and become acquainted with the routine for commencing operations at the best period of the year for insuring success. We leave to others the task of criticising the work, contenting ourselves with the expression of our opinion that this is the cheapest and most practical work on the subject of Mushroom culture we have seen; and we doubt not that those who read it will bring it to the notice of their friends and neighbours who might with advantage grow the much-esteemed and profitable crop to which it refers. We have already received the testimony of several gardeners of repute who have read the treatise, but we cannot find space for their letters this week.

— SCARCELY an event of importance can now occur in which plants and flowers have no part. At the opening of the FISHERIES EXHIBITION last Saturday the royal daïs and parts contiguous were tastefully embellished under the superintendence of Mr. Barron. Besides plants from Chiswick, groups were contributed by Messrs. B. S. Williams, Lane, Wills, Waterer, Aldous, and others. Near the Royal Pavilion a terrace garden was formed and planted with ornamental shrubs and Coniferae, supplied by Mr. Maurice Young. As the Prince and Princess of Wales passed through the Belgian Court Belgian women scattered Rose leaves upon the scarlet pathway. One of their number also presented a magnificent bouquet of Lilies of the Valley to the Princess of Wales. This was sent expressly from the Town Council of Ghent, and had been dispatched by the mail on Friday night. The gift was generously accepted and the givers thanked by the Princess. The Exhibition is of wonderful extent and diversity, nearly covering the gardens of the Royal Horticultural Society, but space is left for holding the Society's Great Summer Show next week, and this will afford a suitable opportunity for gardeners to inspect the remarkable Exhibition above noticed. The services of Mr. J. D. Dick are of great value to the Fisheries Committee, and by the consent, unanimously granted, of the Council of the Royal Horticultural Society, which he has served for twenty-seven years, he is enabled to assist in the Exhibition just opened in the gardens.

— GARDENING APPOINTMENT.—Mr. D. Calderhead, gardener to R. G. E. Wemyss, Esq., of Wemyss Castle, Dysart, N.B., who has been appointed by Mr. Thomson as superintendent at the Tweed Vineyards, Clovenfords, Galashiels, was entertained by a large number of friends last Thursday night at a supper, when he was presented with a massive gold chain and charm, and a gold brooch

for Mrs. Calderhead, as a mark of the high esteem and respect in which he has been held. Mr. Brown, President of the Wemyss Horticultural Society, made the presentation, and Mr. Calderhead feelingly replied.

— "OBSERVER" writes:—"Many visitors to the Royal Horticultural Society's Promenade Show last week were astonished at the large number of certificates granted, some being for plants of little interest and less use. The Floral Committee appears to vary strangely in its moods, if I may be permitted to so express it. Sometimes they are rigid, and regard with a cold eye plants of considerable beauty that have to be submitted to their attention repeatedly before their value is appreciated; at other times certificates are strewn about literally broadcast. Is this influenced by the weather, or what? for I have failed to discover the cause, and at the last meeting several members of the Committee itself admitted that some of the certificates awarded were undeserved, a fact about which there is little doubt, though it would be invidious to name them. One gentleman, himself a recipient of many certificates, suggested that there should be botanical and horticultural certificates, and something of the kind is certainly needed to mark the difference in the value of the plants so honoured."

— THE fine COLLECTION OF ORCHIDS formed by the late Lord Egerton of Tatton was sold by Mr. J. C. Stevens, 38, King Street, Covent Garden, on the 9th and 10th inst., when the total amount realised by the sale was £650. Some of the principal prices obtained were as follows:—*Cattleya labiata*, autumn-flowering variety, 15 guineas; *Lælia anceps Dawsoni*, 25 and 13½ guineas; *Vanda Lowii*, 50 guineas; *Cattleya domingensis*, 10½ guineas; *Odontoglossum nævium majus*, 15 guineas; and *Masdevallia Harryana*, 15 guineas.

— THE conservatory in the Royal Botanic Society's Gardens, Regent's Park, has during the past month been quite gay with RHODODENDRONS AND AZALEAS in flower. The former include fine specimens of *R. Nuttali*, which had handsome trusses of its enormous trumpet-shaped creamy-white or yellowish flowers, while the smaller but pretty *R. Gibsoni* and *R. formosum* have been loaded with their pure white blooms. A specimen of considerable size of *R. Countess of Haddington*, too, has been magnificent, its beautiful rose-tinted flowers being produced in great abundance. A valuable quality of this variety is the freedom with which small plants flower, and it is consequently one of the most useful for conservatories in pots, especially as it lasts in flower a good time. *R. Henryanum* is another of the species with trumpet-shaped flowers, creamy or tinted with yellow, but of rather bad habit. *R. Veitchianum* has well maintained its character as a free-blooming handsome species, its fine white flowers with wavy petals quite hiding the foliage on one specimen.

— IN the tropical house of the same gardens two very notable plants have been flowering—namely, *PETRÆA VOLUBILIS* and *MANGIFERA INDICA*. The former is a climbing or trailing plant that produces quite a cloud of flowers, the expanded mauve calyx and violet corollas of which have a most distinct and pleasing effect. The other is promising a crop of the far-famed Mango, which is so much esteemed in the tropics, and is considered "superior to the finest fruits of India, with the exception of the Mangosteen and some of the finest Pine Apples." Unfortunately the fruits produced in England, or even those which are occasionally imported, rarely possess any attractions for the fruit lover who is accustomed to our own delicious Pears and Grapes.

— OUR correspondent, "R. T.," who has not been able to reply sooner to Mr. Sanders' question on POTTING LILY OF THE

VALLEY, desires us to state that he repots his plants after they have flowered. We think, perhaps, the information wanted had reference to preparing the crowns before they were potted, and "R. T." will probably oblige by sending a note on this subject.

— THE WEATHER in some parts of England has been very severe during the past week. On Thursday a daily contemporary states that at Newbury "from an early hour in the morning snow fell heavily in Berkshire and North Hants, the temperature being particularly low for the time of year for some days. Information from Durham also stated that a snowstorm raged on Wednesday (9th inst.) at the head of Weardale, the snow lying 6 feet on the North-Eastern Company's branch line at Stanhope, and having to be removed by platelayers, whilst the snow-plough had to be employed on the roads. Much rain fell at Durham, and the rivers were very much swollen, whilst out-of-door work was practically at a standstill. It is now resumed.

— A SOMERSETSHIRE correspondent writing on the 10th inst. states:—"This morning it snowed heavily for upwards of three hours; the hills this evening are still covered. If it clears up it will be all over with early Potatoes, Peas, and Apples. The Apples are blooming splendidly everywhere."

— AT the last meeting of the HORTICULTURAL CLUB Sir Trevor Lawrence, Bart., M.P., Burford Lodge, Dorking; Capt. Patton, Alpha House, Regent's Park; W. Lee, Esq., Downside, Leatherhead; and J. T. Peacock, Esq., Sudbury House, Hammer-smith, were elected members. The members afterwards dined together, and most of them afterwards attended the meeting of the Royal Horticultural Society at Burlington House. This notification arrived too late for insertion last week.

— THE samples of VARIETIES OF RHUBARB shown at Kensington last week from the Royal Horticultural Society's Gardens at Chiswick were very interesting, and much attention was paid to them by the visitors. There was every gradation in size, from the small Buck's Early Red, which has stems not more than an inch in diameter, to the gigantic Stott's Monarch, which was fully 3 or 4 inches in diameter. In colour, too, there was also great variation, the first-named being very dark, and the colouring extending right through the stems. Johnston's St. Martin's was another finely coloured variety, the stems of good size, though not coarse; this is also an excellent variety for cooking, the flavour good, and the acidity not too powerful. Linnæus was also notable for its colour and moderate size, and is also much esteemed for cultural purposes, particularly in market gardens. The Monarch was the greenest of all, except the diminutive *palmatum*, which is simply a curiosity.

— THE schedules of the NATIONAL ROSE SOCIETY'S EXHIBITIONS have been issued, and from them we learn that the first will be at Southampton, Thursday, June 28th, in the grounds of the Royal Southampton Horticultural Society, Westwood Park. The Exhibition at South Kensington will follow on Tuesday, July 3rd; the Sheffield Show taking place on Thursday, July 3rd, in the Botanic Gardens of that town.

— AMONGST NOTEWORTHY ORCHIDS at Kew the following are the most remarkable. *Oncidium insculptum*, which has panicles of purplish-brown flowers 12 to 13 feet long; *Masdevallia Benedictæ*, a small-flowered species, with white or yellowish sepals, dotted purple; *M. xanthina*, also a small species, with diminutive yellowish flowers, the two lower sepals having each a large blotch of deep purple near their base; *M. Wagneriana* is quite a diminutive plant, with tiny yellow flowers and a few dots. *Leptotes bicolor* is extremely handsome, a plant in a small shallow pot 4 inches in diameter having sixteen of its beautiful

white and violet blooms. The graceful, white, small-flowered *Angræcum articulatum* is also flowering freely in a basket in the East Indian house.

— THE COLLECTION OF PLANTS FROM THE CAMBRIDGE BOTANIC GARDEN shown by Mr. R. T. Lynch at the Linnæan Society's rooms on the 8th inst., comprised a large number of beautiful varieties, and formed, indeed, one of the most interesting features of the meeting. Very notable were sprays of *Pyrus spectabilis*, the buds of which are rich deep rose, and the expanded flowers of a soft pinkish-white hue. A fine specimen of this tree is now flowering grandly in the Royal Gardens, Kew. *Aloe plicatilis*, with panicles of large, bright, orange-scarlet, tubular flowers, were very attractive; and the beautiful crimson *Boronia elatior*, with its conical flowers, was similarly striking. *Nicotiana affinis*, with abundance of large, fragrant, white flowers; *Berberis stenophylla*, a hybrid between *B. Darwinii* and *B. empetrifolia*, but quite distinct from either, somewhat resembling the last in habit and the former in the flowers; *Schizanthus pinnatus*, with a cloud of mauve flowers, and *Calceolaria erenatifolium*, a pretty species, with large pale yellow flowers, all possessed considerable interest. In addition to those above mentioned were sprays of *Siphocampylus bicolor*, *S. nitidus*, *Othonna cheirifolia*, *Salvia interrupta*, *Primula poeciliformis*, *Arisæma Sieboldi*, *A. præcox*, *Columnea Schiediana*, *Viola eucullata variegata*, *Spiræa lævigata*, *Vesicaria utriculata*, *Arctotis aureola*, *Cheiranthus mutabilis*, and *Hierochloa borealis*.

— IN the same collection were specimens of the peculiar *VITIS GONGYLODES*, a strange and very rare species of Vine. This has fleshy angular stems, from the angles of which project a foliaceous growth that has a curious appearance. Aërial roots are also freely produced along the stem, and when trained to the roof of a house these roots attain the length of 6 feet or more, a kind of enormous development of the similar air-roots produced on the stems of the ordinary Vine. Brownish egg-shaped tubers are also borne on the stems and, falling to the ground, serve to perpetuate the plant, as they soon produce stems when in a suitable soil and moisture.

— MESSRS. STEVENS & WILLIAMS, Brierley Hill Glass Works, have sent to us a COMBINATION FERN POT AND FLOWER STAND, which, when furnished tastefully, is highly effective as a low ornament for table decoration. The stand is of glass, which in the example before us is of a glowing ruby colour. The form is that of a saucer about a foot in diameter supported by three white glass legs nearly 2 inches high. This saucer, or the outer margin of it rather, is for flowers, the centre rising to the height of 3 inches, and forming a receptacle for a miniature Fern; the cavity, which is 4 inches deep and 3½ inches in diameter, containing a white Minton porous pot for that purpose. A bottomless flower pot inverted in a saucer gives a rough idea of this very elegant and highly finished contrivance, which, even without any flowers, is an elegant ornament for the table or sideboard. The stands are made in different colours and sizes; suitably furnished they are very rich, and at the same time convenient for either the dining or drawing-room table. These stands, if exhibited at the leading flower shows, would be likely to meet with a large share of public favour, as they are quite new in design and beautiful examples of the glass ware for which the manufacturers are famed.

MELON CULTURE IN FRAMES.

DURING this month many frames and pits will be emptied of their contents—bedding plants, Potatoes, &c.; and if not required for other purposes, one or several in numerous gardens may well be devoted to Melon culture. Stout, clean, healthy plants are requisite, and I have proved such green-fleshed varieties as Golden Queen, Beechwood, Colston Bassett, and Eastnor Castle, and

such scarlet-fleshed varieties as Reid's Hybrid and Turner's Scarlet Gem, to be well adapted for frame culture. Such newer sorts as William Tillery, Earl of Beaconsfield, Hero of Lockinge, and Blenheim Orange would also, no doubt, prove satisfactory if tried. I do not advise anyone to grow the whole of them, but mention the varieties in order to include one or two that may be easily procured by all.

A Cucumber frame or another hotbed is the best place for rearing the plants, as, being near the glass, they grow sturdily. They should be stopped at the first joint beyond the seed leaves, and when breaking afresh should at once be planted or shifted into larger pots. The latter detail, simple as it may appear, is really highly important, as so much depends upon a good commencement. Semi-starved plants entail a loss of valuable time and heat.

While the plants are being prepared, the hotbeds on which the frames may have been standing should, unless comparatively fresh—in which case a partial or complete lining with fresh material will suffice—be reformed, a liberal quantity of newer material being added. If hotbeds have to be made entirely with fresh material, such as stable or cow-yard manure, this ought to be well prepared prior to use. Much depends upon circumstances; but, as a rule, the manure ought to be thrown into a heap to encourage fermentation, and be turned at least three times at intervals of about a week, being freely watered each time if at all dry. By this practice the mass will be sweetened without spoiling the manure by overheating. The mistake is often made of forming beds entirely with too fresh manure, and, this overheating, becomes dry and mouldy—useless either for heating or manurial purposes.

The bottom heat for Melons ought to be maintained as near 75° as possible, and if 10° higher so much the better. To insure this temperature at the top as well as bottom, the beds earlier in the season ought to be formed from 4 to 5 feet high at the back, with a foot fall to the front. At the present time they need not be so high. A layer of faggots at the bottom serves to keep the bed dryer, and is a partial preventive of overheating. The manure should be well shaken out as the bed is formed, and be made firm with the fork in preference to trampling, this securing a regular heat and even settlement of the bed. It may be made slightly wider than the frame, and later on, when the heat is declining, it should have one or more sides cut away and a living given. These linings, which probably many hotbeds at the present time require, may be about 2 feet wide at the bottom and gradually tapered in to about 18 inches in width at the top, this being slightly above the level of the bed.

It is seldom advisable to place in the soil directly the bed is formed. The best plan is to keep the frames closed till the heat has risen, and when the trial stake, which ought always to be kept deeply plunged in the bed, denotes when held in the hand that the highest heat has been reached, a decline may soon be anticipated, and the soil can safely be put in. A certain amount of rank steam is invariably given off by newly formed beds, and the lights should be slightly propped up at the back at all times while this lasts. If a few turves are obtainable these should be disposed grass downwards in the centres of each light, and a mound consisting of about two bushels of good strong loam be formed on them, while to keep down excessive steam the remainder of the bed should be surfaced with about 6 inches of good garden soil. The turves tend to prevent burning of the roots, and if these are not to be had, two or more small draining pipes may be taken under each heap so as to form good outlets for the dangerous steam. As I have previously observed, no particular compost is absolutely necessary for Melons, but if I could not have thick turf from pasture land I should bargain to have a shallow spit from immediately under the turf, replacing the latter after ordinary garden soil had been substituted for the loam extracted. I advise that no manure whatever be employed with the loam, though with strong clayey loam, especially, I find a sprinkling of slaked lime very beneficial.

When the heaps are thoroughly warmed and the trial stake can be borne comfortably in the hand is the time to plant. Three plants to go to each mound, and planted rather deeply, though not burying the collars, and disposed in a sloping position so as to admit of the running growths being pegged down without snapping off. The soil should be pressed firmly about the roots of the plants, and the latter being in a moist state, only sufficient warm water should be given through a fine-rose watering pot to fix the soil about the roots. At the commencement the frame should be kept rather close, and lightly shaded during the prevalence of bright sunshine only. When well established shading should only be resorted to in case of severe flagging. A temperature ranging from 75° to 90° with air by day, and not less than 70° by night, should be maintained where possible. By closing early, say at the present time about 3 p.m., and well sprinkling the plants as

well as the bed and side of the frame with tepid water, a high temperature and a suitable humid atmosphere will be created, this lasting for several hours. In the evening mats or other protecting material may be thrown over the glass, taking care not to cover the slight openings left in the back for the escape of excessive steam. The mats must be taken off early, and a little more air admitted to dry the plants before the sun is powerful, or the foliage may be injured by scalding.

In about a week from planting the new Melon roots will perhaps push through the surface of the mounds, and in anticipation of this more soil should be placed in each light to warm, so as to have it in readiness for covering these over whenever necessary. In this manner the roots are encouraged to spread near the surface, and the bulk of soil is increased at the same time, so as to eventually be at least 10 inches thick all over the bed. Each plant should push out three growths, and these require regulating and to be kept pegged down till near the sides of the frame, when they should be stopped. The laterals that follow, or are strengthened by this stopping, seldom fail to produce abundance of fertile blossoms, of which a number should be impregnated in one or two days to form a good crop, say four to six fruits on each plant. While the fertile blossoms are being set by applying to them pollen from the others which have not a rudimentary fruit at their base the frames should be kept rather dry. Water of the same temperature as the frame should be freely given whenever the soil approaches dryness. Liquid manures such as are obtained from farmyards, or are made from sheep and horse droppings, are apt to encrust the surface of the bed and impede root-action. At the same time some kind of manure is necessary to assist in the maturation of a heavy crop, and for this purpose I find an occasional light surface-dressing of a good artificial manure highly beneficial. If carefully watered in through a fine-rose pot the effect is lasting, and instead, as in the case of the liquid manures, of checking surface-rooting, this is promoted.

To avoid injuriously crowding the foliage and a dangerous employment of the knife, in many cases it is advisable to rub out some of the laterals, and those retained should have their points pinched at one joint beyond the fruits, under which should be placed pieces of slates. The fruits when young should not be exposed to the bright sunshine, but when fully grown may be elevated on inverted flower pots, and this will encourage both "netting" and ripening. A second crop may easily be secured, provided the plants are vigorous and healthy. Thin out the growth, cutting away any that is worn out, renew the linings, and in the course of a few days give the beds a soaking with tepid water. In this manner strong fruiting growths will soon result and a second crop be secured. Pits, though without hot-water pipes, are warmer than frames, and the bottom heat lasts longer, but in most cases cannot be renewed, consequently greater judgment will be required with regard to watering. In other respects the treatment should be similar to the foregoing.

I have not been very successful with Melons in cold frames, but have on one or two occasions had Monroe's Little Heath fairly good with little or no heat. This variety, however, I consider inferior to the old Cantaloupe, which for many years was grown at the Royal Gardens, Claremont.—W. IGGULDEN.

LECTURE ON THE NARCISSUS.

THE Rev. George Henslow, in his lecture on the Narcissus at South Kensington last week, which was illustrated by many specimens from Mr. Barr's beautiful collection, gave the following particulars:—With reference to the origin of the name, he explained how in Greek mythology the son of Cepheissus and Liriope, slighting the nymph Echo, fell so desperately in love with his own shadow in the stream instead, that death alone could release him from the anguish of unrequited love. The Naiads mourned for him, and on searching for his body discovered nothing but a beautiful flower instead, which henceforth bore his name. Coming to more prosaic matters, the genus, though abounding in "forms," yet, according to Mr. Baker, is a limited one. That botanist groups them under three heads—viz., those with long crowns or coronas, as the Daffodil; those with crowns of medium length, as in the Imperialis group; and those with a mere rim, as the Poet's Narcissus.

Describing the structure of the flower he pointed out the difference between the family Amaryllideæ, to which it belongs, and that of Lilies, the Narcissus being known by the perianth having adhered to the ovary, which thus appears below it. The corona he explained as a mere outgrowth from the perianth, and appears to correspond to the rim in the corollas of the Primrose and Forget-me-not, and is not characteristic of the majority of genera

in the family. Double flowers are frequent, and are of different kinds—(1), the corona may be filled with a mass of petals; (2), the perianth and corona are broken up and many times repeated, so as to form an irregular mass of petals; or (3), the petals are piled up in front of one another, as in a Rose. This occurs in the var. *eystellensis*. With reference to physiological properties, the Narcissus is more or less poisonous, the Daffodil and the Poet's being especially so, and have been used in medicine as emetics. Other members of the family are poisonous, as *Brunsvigia toxicaria*, which is used by the natives of South Africa to poison fish. It was this which accidentally poisoned Dr. Pattison, though he fortunately recovered. The Narcissus has been long cultivated in England. Gerard in his "Herball" (A.D. 1597), described seventeen kinds; and Parkinson in his "Paradisus" (1629), figures many and describes ninety-two kinds.

Selecting a few sorts for illustration, Mr. Henslow first alluded to the Hoop Petticoat (*Narcissus Bulbocodium*) from the West Mediterranean regions, remarkable for the shape of the corona and its declinate stamens. It is recorded that a bulb of this species, having been in an herbarium for twenty years, was afterwards planted and flowered! The Daffodil, or *N. pseudo-Narcissus*, is probably the only native of Great Britain, and is very variable, especially under cultivation, the size of the flowers quite justifying the terms *maximus*, *major*, *minor*, *minimus*; while the colour may be all yellow, or the perianth white with the corona yellow (*e.g.*, *bicolor*), or all white (*e.g.*, *cernuus*), such as are the Spanish forms. Double forms of the larger sorts are common, though that of the true wild one is uncommon.

Of the second group with shorter crowns the most important is *incomparabilis* and its many varieties. This is now considered to be a hybrid between the Poet's Narcissus and the Daffodil, although it occurs wild in France and Spain, for Dean Herbert and others have raised it from such a cross; indeed, he thought that by using the pollen of *N. poeticus* successively for two or three generations that the Daffodil could be converted into that species. It is remarkable that the purple of the cup of *poeticus*, with the golden-yellow of the Daffodil, give rise to an orange tint in the cross, just as purple and chrome yellow mixed on a palette produce a similar orange.

Another important species is *N. odoratus*, the Campenelle, a pure yellow and very scented. This is intermediate between the Jonquil and *incomparabilis*. It has been supposed to be Lily of the Valley in the Song of Solomon. Its native home is South France, Italy, to Dalmatia.

Of the third or short-crowned form *N. tazetta* is perhaps the most variable (the Dutch in 1800 cultivated as many as 300 forms), and has apparently the greatest range, for if not wild it is cultivated largely in China. It is the common Polyanthus Narcissus, as it bears several blossoms on one stalk. The typical form has a white perianth and yellow cup, but varies in colour like the Daffodil, and may be double as well. The true Narcissus of the ancient poets appears to be *N. poeticus* or *biflorus*, especially the former, as it is described by Virgil as "*purpureus*," in allusion to the purple rim of the crown, which colour is wanting in *N. biflorus*. Its double form, like a Gardenia, is much cultivated for decorative purposes.

HOYA CAMPANULATA.

THIS is undoubtedly the most handsome of the Hoyas, and when well grown it is an exceedingly valuable roof plant for a stove, and being, moreover, as easily grown as most of its relatives, it has everything to recommend it. The large open bell-shaped yellowish flowers readily distinguish *H. campanulata* from all the other species, and the blooms being produced in unusually large dense globular umbel-like clusters that are pendulous from the branches, a large plant well flowered has a fine effect.

By different authors this has been termed both *Physostelma* and *Cystidanthus*, but it is now generally known as a Hoya. It is a native of Java, where it was found by Blume growing in mountainous districts, but it was introduced to England nearly forty years ago by Messrs. Veitch & Sons of Exeter through Mr. Thomas Lobb. In its native country it is said to flower all the year round, and even in cultivation the flowers last a considerable time, fresh umbels being continually produced when the plant is thriving.

Whether grown in a pot or planted out a compost of light loam and peat is the best for it, providing good drainage and keeping the plant clean.

Two other species from the same district, and introduced about the same time by Mr. T. Lobb, are *Hoya coriacea* and *H. purpureo-fusca*. The former has a fine compact truss of yellowish flowers, the staminal crown in the centre white with a few crimson

lines. *H. purpureo-fusca* is a peculiar species with dull purplish corollas and brownish crimson crowns. This with the preceding would grow well under similar treatment to *H. campanulata*, but they are comparatively rare in cultivation now, and neither can be considered as at all approaching that in beauty.

FRUIT PROSPECTS.

IN Scotland March came in like a lamb, but soon changed to a leonine character. So keen were the north winds that advancing

vegetation, more than ordinarily tender owing to the mildness of the winter, had a rough check; and in the more exposed localities Broecolis disappeared, while even in the favoured spots they were much injured. But "there is no great loss without some compensating profit;" the winds and frosts that damaged vegetables and was hard on the forward spring flowers, came in time to check the too forward blossom buds. The consequence is that Pears and Plums are only blooming now over four-fifths of the country, while the Apple blossom will not be out for some time. This leads us to hope for a better crop than has been had for some



Fig. 92.—HOYA CAMPANULATA.

years, for, despite the wet summer and late autumn, blossoms are particularly abundant even on standard trees. Possibly the mild

winter did good in enabling the buds to become metamorphosed, as a correspondent some time ago supposed was the case with

orchard-house trees. Small fruits promise an abundant crop. To-day (May 12th) the wind has changed to the balmy south-west, and the hope that springs eternal in the human breast leads us to think that at last fruit-growers will have cause to be thankful for bountiful crops.—SINGLE-HANDED.

THE weather having been so very cold, and all vegetation, including fruit trees, being so late, that if we escape frosts now we may reasonably hope for a good crop of fruits. Apples, Pears, and Cherries have an abundant display of blossom, and we only require favourable weather to bring a good crop of fruit to maturity.—D. THOMSON, *Drumlanrig*.

ON the 7th and two following days we had thoroughly winter-like weather in almost every part of Ireland. Even still, a week after, the hills in the south, not to mention the north, of the island are covered with snow. For several days the beginning of the past week the wind kept N. or N.E., and fortunately for fruit blossoms, tender vegetables, but especially Potatoes, the sky at night kept clouded; otherwise the destruction from frost would have been wholesale. All the early varieties of Potatoes, with me and generally, are over the ground, and in that state they are most tender and susceptible of injury, even from harsh winds. The wind has chopped round to S.W., and immediate injury seems past, but the temperature is much under the average. I visited the fruit garden at "Bijou," in the suburbs, containing fifty varieties of Apples and Pears; and though there have been several showers recently of hail and snow here, with harsh winds, the prospect seems very promising.—W. J. M., *Clonmel*.

APRICOTS when in full blossom were much injured by the frost then prevailing, and the crop is almost nil. The trees, too, are much injured, as is evidenced by the branches dying off in a lamentable manner. Peaches and Nectarines, being later in bloom than Apricots, have fared somewhat better; still, the cold ungenial weather at the time of flowering has had a prejudicial effect upon the blossom, which, though apparently setting well, is now falling, doubtless from imperfect impregnation. The crop will only be a moderate one. The trees so far are healthy, not being affected by aphides or "blister." Plums have not blossomed very fully, and cannot be more than a moderate crop. Cherries promise grandly. Pears are, as regards standard trees, "sheets of white," and are setting well. The trees against walls have set freely, the prospects of the crop being fuller than it has been for many years. Apple trees are "pictures of beauty." Nothing can vie for loveliness with the pink of Apple blossom. The crop of this most useful hardy fruit must be all that could be wished if no militating influence arise. Bush fruits promise splendidly, and Strawberries are showing vigorous trusses profusely.—G. ABBEY, *Paxton Park, St. Neots, Hunts*.

FRUIT prospects in this part of Wales are brighter than they have been for three years. Heavy crops of Pears are formed on many of the trees. Peaches on the open walls are more abundant than we ever expected to see them. The Apple trees are now in full bloom, and many of them are completely covered. They are some weeks later in opening than usual, but this is all in their favour, as severe frosts are hardly likely to occur seriously now. Plums are the least plentiful, but we hardly expected an excessive quantity of them this year, as the crop was so heavy last year. Gooseberries have escaped well, and are now abundant and large enough to gather for tarts. Strawberries are a mass of flowers, and the same may be said of Currants. Generally speaking our season is late, but the prospects of scuring good fruit and vegetable crops are very satisfactory.—J. MUIR, *Margam*.

ROYAL BOTANICAL AND HORTICULTURAL SOCIETY, MANCHESTER.—MAY 11TH TO 18TH.

IT was feared that the earliness of Whitsuntide this year, combined with the remarkably cold weather experienced up to the present time, would have a very detrimental effect upon the success of the Exhibition. It was, however, quite equal to the shows of past years, and in some features superior. Orchids were more numerous than ever, but smaller, and did not display so much of the "make up" system that we have been in the habit of seeing, yet "made-up" specimens were not totally absent this year. Small miscellaneous decorative plants were very much more numerous than we have before seen at any previous exhibition. Hardy herbaceous and alpine plants were remarkably well represented, and proved a very attractive and interesting feature of the Show. The Roses shown by Messrs. Paul and Sons, Cheshunt, are worthy of special note for the freshness of the plants and the fine quality of their flowers, many being equal in

size, substance, and colour to what we should expect in the height of the Rose season.

STOVE AND GREENHOUSE PLANTS.

IN the class for ten stove and greenhouse plants in flower Mr. J. Cypher, Cheltenham, was the only exhibitor, and his plants were well worthy of the first prize awarded them. The best specimens were *Erica Cavendishii*, well bloomed and about 3 feet through; *E. ventricosa major*, about the same size, fresh and good; *Azalea Stella*, well bloomed; *Pimelea diosmæfolia*, grand, 5 feet through; *Hedaroma tulipifera*, 4 feet, and well grown; *Clerodendron Balfourianum*, fair; *Bougainvillea glabra*, a mass of flower, and about 5 feet through; and *Aphelexis macrantha purpurea*. In the corresponding amateurs' class for eight plants S. Schloss, Esq., Bowden (gardener, Mr. C. Paul), took the lead with some even well-flowered plants of *Azalea Napoleon III.*, *Erica ventricosa*, very good; *Aphelexis macrantha purpurea* in good condition; *Bougainvillea glabra*, remarkably fine; *Erica Victoria*, and the best plant of *Anthurium Schertzerianum* in the Exhibition. Messrs. G. Smith, gardener to John Rylands, Esq., and G. Hodgkinson, Bowden, were the remaining prizetakers, both showing very creditable plants, but smaller than the first-prize collection.

Azaleas.—These generally were in better condition and more numerous than they have been during the past two or three years at this Society's exhibitions. In the nurserymen's class for eight plants Mr. Cypher was first with large profusely flowered specimens. Mr. James followed, also having good specimens. Mr. S. Schloss was the principal prizetaker in the class for six plants, and staged several grand plants.

Ericas.—These were healthy and profusely bloomed. Mr. Cypher and The Horticultural Company were the prizetakers in the nurserymen's class for six plants. Mr. Cypher staged superb plants of *E. depressa* and *E. Cavendishiana*, and others. The second collection contained good plants of *E. Spenceriana*, 4 feet through and one mass of bloom.

Pelargoniums.—These were remarkably good considering the earliness of the season for these plants. Mr. C. Rylance, Ormskirk, was first with splendid plants of *Spelling Beauty*, *Royal Bride*, *Duchess of Edinburgh*, *Mrs. Bradshaw*, *Venus*, *Digby Grand*, *Triomphe de St. Mandé*, and *Duchess of Bedford*. Mr. Cypher was a good second, having splendid examples of *Kingston Beauty*, *Duchesse de Morney*, and *Madame Thibaut*. For eight Fancy varieties Mr. C. Rylance was again first with well-grown plants, and also took the lead in the class for eight Zonals. In the amateurs' class for six plants Mr. Silkenstadt was the principal exhibitor. Messrs. C. Rylance and Irvine, gardener to Lord Howard, were the chief prizewinners in the two classes devoted to tricolor varieties, the specimens in both collections being well grown.

Amaryllises.—The schedule provides two classes for these plants—one for nurserymen and the other for amateurs, but only one collection was staged, and that by Mr. B. S. Williams, which proved an interesting feature and attracted much attention. The collection included some very fine varieties.

Clematises were poorly represented, only one collection being staged.

Gloxinias.—These were not numerous, but the plants in the first and second-prize collections were very creditable, the flowers being of fair size. The successful exhibitors were Mr. T. Eden, gardener to Mrs. Sergeant, Temple Villa, Sale; Mr. W. P. Plant, gardener to R. P. Gill, Esq., Ashton-on-Mersey; and Mr. J. G. Silkenstadt.

Roses in Pots.—The Roses were all that could be desired, and they formed one of the most imposing features of the Exhibition. For a group of thirty plants in any size pots Messrs. Paul & Sons, The Old Nurseries, Cheshunt, were easily first. The plants of *Madame Victor Verdier*, *Victor Verdier*, and *Dupuy Jamain* were large and well flowered. Conspicuous amongst the half-specimen plants were *Rosy Morn*, *Madame Julie Dymonier*, *Countess of Rosebery*, *Madame Montet*, *Rosieriste Jacobs*, *Princess Beatrice*, *Duck of Teck*, and *White Baroness*. Amongst Tea varieties *Alba Rosea*, *Jean Ducher*, *Souvenir d'un Ami*, *President*, *Madame Margottin*, and *Madame Willermoz* were all superb. Mr. Hooley was second, his plants being much taller and the blooms considerably smaller. For twenty plants in pots not exceeding 9 inches in diameter the above exhibitors were awarded the prizes in the same order as in the preceding class. In the amateurs' class for six plants the principal prizetaker was Mr. Elphinstone.

Table Plants.—These were shown of a very suitable size, and the prizes offered were well contested. In the open class for twelve Mr. B. S. Williams took the lead, followed very closely by Messrs. R. P. Ker & Sons; Mr. Wilson the remaining prize with rather heavier plants than the preceding collections. The first-prize lot contained *Grevillea filicifolia*, *Croton tortilis*, *Asparagus virgatus*, *Aralia Veitchii*, *A. leptophylla*, *Dracæna gracilis* and *D. Sidneyii*; the most striking amongst Messrs. Ker's being *Geonoma gracilis*, *Croton interruptus aureus*, *Dracæna Bellula*, and *Pbajus humilis*. In the class for six plants Mr. A. Williams, gardener to J. Broome, Esq., first with neat plants, but larger than those shown in the open class; Mr. Holmes was second, and Mr. S. Schloss third.

GROUPS.

These were very satisfactory, being arranged on each side of centre walk in the large exhibition tent. In the nurserymen's class for a

space not exceeding 30 feet by 15 feet, Messrs. R. P. Ker & Sons were the only exhibitors, and had a very effective group of choice flowering and fine-foliage plants, for which the first prize was awarded. In the amateurs' class Mr. G. Smith was well first with the most beautifully arranged group in the tent. The centre was a large Palm rising out of an elevated bank of *Adiantum cuneatum*, which also formed the groundwork for Azaleas, Yuccas, Palms, Orchids, and others rising at different heights from the groundwork. Messrs. S. Schloss and Hodgkinson obtained the remaining two prizes in the order named.

ORCHIDS.

In the nurserymen's class for sixteen plants Mr. James, Castle Nursery, Lower Norwood, was deservedly awarded the premier prize. His plants were not large, but fresh, healthy, and in good condition. His principal plants were *Cypripedium Lawrenceianum* bearing four flowers, a pair of *C. niveum* with thirteen flowers, a good variety of *Odontoglossum* with two spikes, *O. Hallii leucoglossum* was also good with one spike; *O. vexillarium*, a healthy plant with thirteen spikes, *Oncidium macranthum*, two spikes, *O. pymatochilum*, one spike, and *O. concolor*, fine. Amongst *Dendrobiums* the *D. nobile* was good, and *D. Jamesianum* had about thirty flowers. *Cattleyas Mendelli* and *C. Schillerianum*, the former having six fine flowers and the latter two. *Aerides Fieldingi* had one fine spike, while *Masdevallia Lindenii* had about thirty flowers. *Dendrobium crassinode* was also good. Mr. J. Cypher was the only other exhibitor, and was placed second for an excellent collection. In the amateurs' class for fifteen plants there were also two exhibitors. O. Schneider, Esq., Fallowfield (gardener, Mr. W. Holmes) and Mr. W. Swan, gardener to W. Luek, Esq., Fallowfield, were the competitors, who took the awards in the order named, both showing remarkably well. The former staged good examples of *Odontoglossum citrosinum roseum* with three fine spikes, *O. pescatorea*, with thirteen spikes, and a good variety of *O. vexillarium* with fourteen spikes; *Aerides Fieldingi*, three spikes, and *Vanda tricolor*, two spikes; *Dendrobium clavatum*, ten spikes, good examples of *D. Dalhousianum* and *D. Devonianum*; *Vanda suavis*, two spikes; *Laelia purpurata*, ten very large flowers; *Cattleya Mendellii* with sixteen flowers, and *C. Mossiæ* with about thirty flowers; *Oncidium serratum*, two spikes, and a very fine specimen of *Oncidium sphacelatum majus* with ten large spikes of its showy flowers. Mr. Swan staged good well-bloomed plants of *Dendrobium thysiflorum* with about thirty spikes, *Dendrobium Falconeri* with nearly 200 flowers—this, without doubt, was the most striking plant in the Exhibition—*Dendrobium transparens* was also good, *Odontoglossum luteo-purpureum*, one spike, *O. Alexandræ* with eight spikes of fine flowers, *Cypripedium Stonei* with three spikes, and *Laelia purpurata* with twelve flowers, *Cypripedium caudatum* had six spikes of its curious flowers. *Aerides crassifolium* and *Vanda suavis* were also worthy of note. In the nurserymen's class for nine plants Mr. James was again first, followed by Mr. Cypher. In the corresponding class for nine plants Dr. Ainsworth (gardener, Mr. Mitchell), was the only competitor, and was accorded the first prize. This collection contained some very fine plants, notably *Vanda suavis* with eleven spikes, the plant being 4 feet high and fully 3 feet through; *Oncidium sphacelatum*, good with six spikes, *Cattleya Mendelli* with six open flowers and several to open, *Phalænopsis amabilis* with fifteen spikes, and *P. grandiflora* with nine or ten spikes. For six plants Mr. Goodall, gardener to Mrs. Leech, Gorse Hall, Stalybridge, was first with *Vanda tricolor*, *Odontoglossum Hallii* with one fine spike, *Cattleya Mossiæ* with twelve flowers, and *Oncidium sphacelatum*, a grand plant with eleven spikes. Mr. Mitchell, gardener to Dr. Ainsworth, was a close second with capital plants.

In the class for ten *bona fide* specimens not "made up" there were two competitors—Mr. O. Schneider and Dr. Hodgkinson, Broughton, who were placed first and second in the order named. The former staged *Cypripedium barbatum nigrum* with seventeen flowers; *Cattleya Mossiæ superba* with six flowers; *C. Mossiæ*, ten flowers; *Cypripedium Dominii*, *Stanhopea maculata*, and a very fair plant of *Odontoglossum vexillarium*. The second collection contained a good *Cattleya Mossiæ* and *Vanda suavis*, the remaining plants being small.

FINE-FOLIAGED PLANTS.

These were remarkably good, especially the Palms and Cycads, many of them being of enormous size. In the nurserymen's class for eight plants the competition was good. Mr. Cypher secured the first place with very large well-grown examples of *Latania borbonica*, *Thrinax elegans*, *Kentia Fosteriana*, *Cycas revoluta*, *Cycas circinalis*, *Cordyline indivisa*, and a good *Croton majesticus*. Mr. J. H. James, Lower Norwood, was a good second. The Liverpool Horticultural Company (John Cowan), Garston, were awarded the remaining prize for excellent collections. The competition was also good in the amateurs' class for ten plants. Mr. C. Paul being well ahead with some remarkable specimens of *Gleichenia Speluncæ*, 8 feet through and healthy; *Anthurium crystallinum*, good; and a grand example of *A. Waroquanum*, *Latania borbonica*, *Cocos Weddelliana*, *Croton Disraeli*, a noble plant of *Eurya latifolia variegata*, and *Croton angustifolius*. Mr. G. Smith, gardener to J. Rylands, Esq., was second, and Mr. E. Elkin, gardener to T. H. Birley, Esq., third, both staging highly creditable specimens.

Crotons.—These were not so good on the whole as we have seen on previous occasions at this Society's exhibitions. The first-prize

collection in the nurserymen's class for ten plants were staged by Messrs. R. P. Ker & Sons, Aigburth Nursery, Liverpool. This was the finest collection of new *Crotons* we have seen. The plants were large, with large, bold, well-coloured foliage, and the majority of them of recent introduction. The pyramidal plant of *interruptus aureus* was superb, lighter and much more beautiful than the old *angustifolius*. *Evansianus* was another grand plant, about 5 feet through, the colour being all that could be desired. The same remarks apply to *Hanburyanus*, *Hawkeri*, *Queen Victoria*, and *Warreni*. *Princess of Wales* was also conspicuous, and *Kingianus* was very striking, with its large bold foliage; and *Baroness Rothschild* was little less so, being about 6 feet through. Mr. J. H. James was second, but his plants were far behind those of the first collection. In the corresponding class for six plants there were three competitors. Mr. C. Paul took the lead with creditable plants, about 5 feet through, but were not extra well coloured. Mr. Goodall, gardener to Mrs. Leech, was second. The third prize was given to a collection of very poor plants, which we need not particularise.

Dracenas, only two collections being staged for the six prizes offered. In the nurserymen's class for twelve plants Messrs. R. P. Ker & Sons were well to the front with well-grown examples of *Hendersoni*, *Gladstonei*, *recurva*, *pieta*, *Lindenii*, *grand*; *Bausei*, very fine; *Goldieana*, *Mooreanus*, *venusta*, *alba marginatus*, *Regina*, and *Imperator*. Mr. H. James was awarded the second prize for neat examples.

FERNS AND PALMS.

Ferns were exceedingly well shown, the plants being remarkable for their large size and healthy appearance. The first-prize collection contributed by S. Schloss, Esq., Bowden, in the class for eight stove and greenhouse varieties are worthy of special note. The four *Gleichenias* staged were wonderfully good, *G. Mendellii* being fully 8 feet through, while *G. flabellata*, *G. rupestris*, *G. rupestris glauca*, were about 7 feet through each; *Davallia Mooreana* was also a noble specimen about 6 feet through; *Dicksonia antarctica*, *Cibotium Schiedei*, were very fine, but the plant of *Goniophlebium subauriculatum* was the finest we have yet seen exhibited. Mr. Hesketh, gardener to A. Birley, Esq., Pendlebury, was second with excellent specimens.

For six *Adiantums* Mr. D. Bowman, gardener to G. Hodgkinson, Esq., Bowden, took the premier award with admirably grown examples about 3 feet through. Mr. J. Silkinstadt, Rose Bank, Didsbury, being second, also with good plants. Other successful exhibitors were Messrs. R. P. Ker & Sons, Ward, Birkenhead, James, Goodall, Baillie, Irvine, and Hesketh. In the open class for eight filmy ferns Mr. B. S. Williams, Upper Holloway, London, was successful, and staged fine specimens of *Trichomanes radicans*, *T. maximum*, *T. trichodeum*, *T. auriculatum*, *Hymenophyllum demissum*, and *H. demissum nitidum*.

Palms.—Large healthy specimens were staged in the classes devoted to these plants. In the nurserymen's class for two, the Liverpool Horticultural Company (John Cowan) secured the first prize with large examples of *Latania borbonica*; Mr. B. S. Williams followed with the same species, and Mr. Cypher the third prize with a fine pair of *Seafortia elegans*. In the amateurs' class for four plants there were three competitors. Mr. Baillie, Heaton Park, was well first with well-grown large plants of *Latania borbonica*, *Kentia Fosteriana* good, *Kentia Blanfordiana*, and *Cocos Weddelliana*; P. Spencer, Esq., second, having good plants of *Areca robusta* and *Latania borbonica*, and Mr. T. H. Birley third.

NEPENTHES AND SARRACENIAS.

These were well shown in the two classes devoted to them. In the nurserymen's class Mr. B. S. Williams was well ahead with small, healthy, well-pitched specimens of *N. Hookeriana*, *N. intermedia*, *N. Dormaniana*, *N. Courtii*, *N. Henryana*, *N. atro-sanguinea*, *N. Williamsii*, *Sarracenia Chelsoni*, and others. Mr. H. James was placed second, and Mr. A. G. A. Bruce, Edge Lane, Chorlton-cum-Hardy. In the amateurs' class for ten plants Mr. A. Williams, gardener to Joseph Broome, Esq., Wood Lawn, Didsbury, was first, his best plants being *N. hybrida*, *N. Hookeriana*, *N. Henryana* and *N. Rafflesiana*, *Sarracenia flava ornata*, *S. flava picta*, *S. Drummondii*, and *S. purpurea*, the last four being in pans, which were large and good: Mr. S. Schloss second, having good large pans full of *S. purpurea* and *S. Drummondii*. Mr. Paul, gardener to J. Fieldes, Esq., Chorlton, was awarded the remaining prize.

NEW AND RARE PLANTS.

There were three competitors in the open class for twelve plants, and the competition was very close between the first and second-prize collections staged by Mr. B. S. Williams and Messrs. R. P. Ker and Sons, but the premier position was accorded the first-named. The first collection comprised *Selaginella grandis*, *Croton excelsior*, *Asparagus plumosus*, *Dracæna Lindenii*, *Delebechia rupestris*, *Aralia spectabilis*, *A. Chabrieri*, *A. Kerchoviana*, *Anthurium Veitchii*, *Nepenthes Mastersiana*, and *Davallia fœniculacea*. Messrs. Ker's, good plants of *Anthurium splendidum*, *Alocasia Thibautiana*, *Dracæna Lindenii*, *Juncus zebrinus*, *Asparagus plumosus nanus*, *Selaginella grandis*; *Croton Newmanni*, a seedling raised at the Aigburth Nursery, much after the style of *Queen Victoria*, but broader foliage and with more

crimson in the foliage than that variety. It is distinct, and the specimen staged was superbly coloured. *Aralia amboynensis*, *Ficus elastica alba variegata*, *Leucostegia chærophylla*, *Pritchardia grandis*, and *Alsophila Rebecca*. Mr. James was awarded the remaining prize, having good specimens of *Selaginella involvens variegata*, a pretty dwarf-growing variety; *Anthurium Andreanum*; *Odontoglossum Chestertonianum*, a good spotted variety of *O. Alexandræ*; *Cymbidium Devonianum* with one spike, and *Odontoglossum Wilckeanum* with one good spike. Mr. S. Schloss was the only exhibitor in the amateurs' class for six plants, and the examples staged were a credit to him.

HERBACEOUS AND ALPINE PLANTS.

These were numerous, and proved a great feature in the Exhibition. In the nurserymen's class for sixty herbaceous and bulbous plants Messrs. J. Dickson & Sons, Newton Nurseries, Chester, gained the premier position with a grand collection, some of the most striking being *Lilium Thunbergianum atro-rubrum*, *Pyrethrum Mont Blanc*, *Dianthus Napoleon III.*, *D. hybridus Miss Patterson*, *Scilla campanulata*, *S. nutans alba*, *Lychnis dioica rubra fl.-pl.*, *Tulipa retroflexa*, *Trillium grandiflorum*, *Pœonia officinalis rubra fl.-pl.*, *Lilium auratum*, *Gladiolus The Bride*, *Cardamine pratensis plena*, and many others equally beautiful and interesting. Mr. H. Brownhill, Maryfield Nursery, Sale, was second with a very good collection. In the amateurs' class for thirty plants Mr. Entwistle, gardener to Joseph Broome, Esq., Didsbury, was most deservedly placed first for an assortment of very choice specimens, *Orchis maculata* being superb amongst many others. Mr. J. Kay of Prestwich was placed second. In the nurserymen's class for forty Alpines Messrs. J. Dickson & Sons were again first with a capital collection of well-grown specimens, and Mr. J. Brownhill second. In the amateurs' class for thirty Alpines Mr. Entwistle was again well ahead, and amongst his fine specimens was a grand pan of *Sempervivum arachnoideum*.

DINNER-TABLE DECORATIONS.

In the class for a dinner table completely laid out for twelve persons Mr. Cypher was the only exhibitor, and was awarded a first prize. The centre was formed with a small Palm slightly elevated and rising out of a small groundwork of *Selaginella*, in which were inserted a few fronds of *Adiantum cuneatum*, and sufficient round the edge to hang upon the cloth. Dotted amongst these were a few *Eucharis* flowers, and rising up lightly from the moss a few flowers of *Masdevallia* and other light sprays of Orchids. At each end was a vase of flowers arranged lightly, with Fern fronds freely intermixed with such flowers as *Spiræa japonica*, *Ixora*, *Eucharis*, *Roses*, *Statice profusa*, *Stephanotis*, and Orchids, four small specimen glasses being filled, and two stood near either end. The fruit consisted of a Pine, black and white Grapes, Strawberries, Apples, and Oranges.

BOUQUETS.

These were fairly represented. Those awarded the premier position and staged by Mr. Cypher were very creditable to him; but those staged by Mr. Mason of Manchester and awarded an equal first contained undoubtedly the best bouquet in the Show, but of quite a different style from those shown by Mr. Cypher. Mr. Mason's were composed of Rose buds and *Lilium candidum* principally, and the best was composed of yellow and dark red Rose buds. Mr. G. Foster, Longford Road, Stretford, was placed second, and Mr. C. Wilson, Kendal, third. In the amateurs' class for two Mr. Elphinstone, gardener to John Heywood, Esq., Stretford, was deservedly placed first; Messrs. Plant and B. Johnson, Ascot, second and third respectively.

MISCELLANEOUS EXHIBITS.

These were most numerous, and the majority of the exhibits contributed by various nurserymen contained novelties worthy of notice. Mr. B. S. Williams staged a very large collection of Orchids, Ferns, Palms, Crotons, Dracænas, Azaleas, and many other choice comparatively new plants. Messrs. R. P. Ker & Sons and Messrs. F. & A. Dickson & Sons, The Upton Nurseries, Chester, also contributed equally interesting groups of choice plants. The Liverpool Horticultural Company and Messrs. W. Cutbush & Sons, Highgate, also contributed large quantities of choice plants; Mr. C. Ryland, hardy Ferns; Messrs. G. & W. Yates, Manchester, staged Azaleas and Palms; Messrs. W. Clibran & Sons show *Pelargoniums* in small pots; Mr. J. Hooley had a similar exhibit; Messrs. Roger McClelland and Co. had a very interesting group of hardy herbaceous and alpine plants; Mr. Upjohn, *Vanda suavis*, fine variety and a large healthy plant, for which a cultural certificate was awarded; Mr. John Waterer, Bagshot, Surrey, a very large collection of choice *Rhododendrons*, *Conifers*, and *Hollies*, which were tastefully arranged at the lower end of the large tent.

FIRST-CLASS CERTIFICATES.—Mr. B. S. Williams, Upper Holloway, London, was awarded certificates for the following plants:—*Amaryllis Dr. Masters*, Mrs. B. S. Williams, *Azalea Baron Rothschild*, semi-double violet-shaded purple; *Nephradium Rodigasianum*, *Nepenthes Hibbardi*, *Gloneria jasminiflora*, *Nepenthes Mastersiana*, *Aralia Kerchoviana*, *Davallia fœniculacea*, and *Selaginella grandis*. To Messrs. R. P. Ker & Sons for the undermentioned plants:—*Anthurium splendidum*, *Selaginella grandis*, *Croton Newmannii*, *Aralia amboynensis*, *Pritchardia grandis*, *Ghent Azalea alba plena odorata*, double white; *Alsophila Rebecca*, *Azalea Phœbus*, dark

double red; *Begonia Abel Carrière*, cross between *Rex* and *discolor*; *Begonia Bijou*; *Azalea Antigone*, semi-double, white ground, spotted and marked with violet; and *Croton Sinitzianus*. To Mr. J. H. James for *Odontoglossum Chestertoniana*, *O. Wilckeanum*, *Selaginella involvens variegata*, *Cymbidium Devonianum*, and *Anthurium splendidum*. To Messrs. Paul & Sons, Cheshunt, for *Rose White Baroness*, which has been described.

FRUIT.

The schedule provides six classes for fruit, and the examples staged for the prizes offered was much better than was anticipated so early in the season. There was a marked improvement in the quality of the fruit over that staged last year. Good Strawberries that are generally staged in pots at this Society's exhibitions was this year absent. In the class for a collection of fruit, eight distinct kinds, there was only one exhibitor. Mr. McIndoe, gardener to Sir J. Peace, Hutton Hall, Guisborough, was awarded the first prize for his collection, which does him great credit. He staged a dish of well-coloured Black Hamburg Grapes and one of White Frontignan, Royal George, Bellegarde, and Barrington Peaches, Lord Napier Nectarine good, McIndoe's Scarlet Premier Melon, and a grand dish of President Strawberries. For two bunches of black Grapes there were three exhibitors. Mr. McIndoe took the chief prize with small but well-finished bunches of Black Hamburg. Mr. Ackers, Moreton Hall, Congleton, was second with the same variety; and Mr. J. Morton, gardener to J. Fielde, Esq., third, the two last exhibits being rather short of colour, but very creditable for the earliness of the season. For two white bunches the same exhibitor was again first with White Frontignan, Mr. Morton being second. For two Pines, Mr. Baillie, Heaton Park, was first with two fair-sized fruits; Messrs. C. Breese and McIndoe second and third. For one fruit, Mr. Goodacre, gardener to the Earl of Harrington, Elvaston Castle, Derby, first; Mr. Baillie second, and Mr. C. Breese third.

The limited space at our disposal this week prevents us enumerating the whole of the prizewinners in the various classes devoted to *Cinerarias*, *Calceolarias*, *Pansies*, *Violas*, &c. Suffice it to say that Messrs. J. H. Hetherington, T. Entwistle, W. Smith, Irvine, Blower, D. McCure, and Eden were amongst the successful competitors. The whole of exhibits in the classes to which we have not referred in detail were all staged in excellent condition.

We congratulate Mr. Bruce Findlay upon the excellent arrangements of the Exhibition.

EPIDENDRUMS.

(Continued from page 365.)

ONE character that occurs in a few Orchids and is observable in some *Epidendrums* deserves a little attention from those who are interested in the structure of these peculiar flowers. It is well known that in a typical Orchid flower there are three outer sepals and two petals generally more or less resembling those in form and colouring; then there is a third petal which has been strangely modified, enlarged, variously formed, and often diversely coloured, which is termed the labellum or lip. It is similarly well known that this, usually the most conspicuous portion of the flower, is lowermost, and seems to serve as a convenient landing place for insects who are in search of nectar, and who thus unconsciously assist in perpetuating and increasing the diversity of the forms by conveying the pollinia from one flower to another. It is found in examining the unexpanded bud of Orchid flowers that the normal and early position of these organs is the reverse of that described; for instance, the lip should be at the uppermost part of the flower, and the middle sepal is the lowest. How, therefore, may be asked, does reversion take place, and why? By carefully observing the ovary or pedicel of a flower with one of these lowermost lips, it will be seen that there is a slight twist, which effectually turns the flower upside down and presents the lip at the lower part. This is the immediate cause, but why the ovary should twist in this manner we cannot determine. It is apparently for the benefit of the plant, as the lip which is in a manner the sign board or advertisement poster that invites the wandering insect to partake of the treasures within, and in the position thus assumed it is perhaps better enabled to perform that function. In some *Epidendrums*, however, as in the *Disas*, the lip is in its normal position, and those who know *Epidendrum cochleatum* or *Disa grandiflora* will at once understand the difference. These give rise to some curious questions: Are they forms that have not yet advanced to the twisting period of their development? or have they taken an independent course and found other means of securing the attendance of their ministers? Who can say?

EPIDENDRUM VITELLINUM.

Resuming the consideration of the most noteworthy species, the "Yolk of Egg" *Epidendrum* deserves prominent attention, for it has in recent years taken a foremost place amongst useful showy Orchids, but also in the ranks of decorative plants generally. Though long reputed a difficult plant to grow, experience has

produced a great alteration, and plants can be readily had in flower for two months or even longer during the summer; and as they also produce flowers at other periods of the year, it is seldom where a good stock is grown that some of its rich blooms are not

obtainable. This is a fine companion for the cool *Odontoglossums*, as it succeeds well in a cool temperature with abundance of moisture at all times, and if grown in shallow pots or pans well drained and filled with good fibrous peat the best result can be ensured

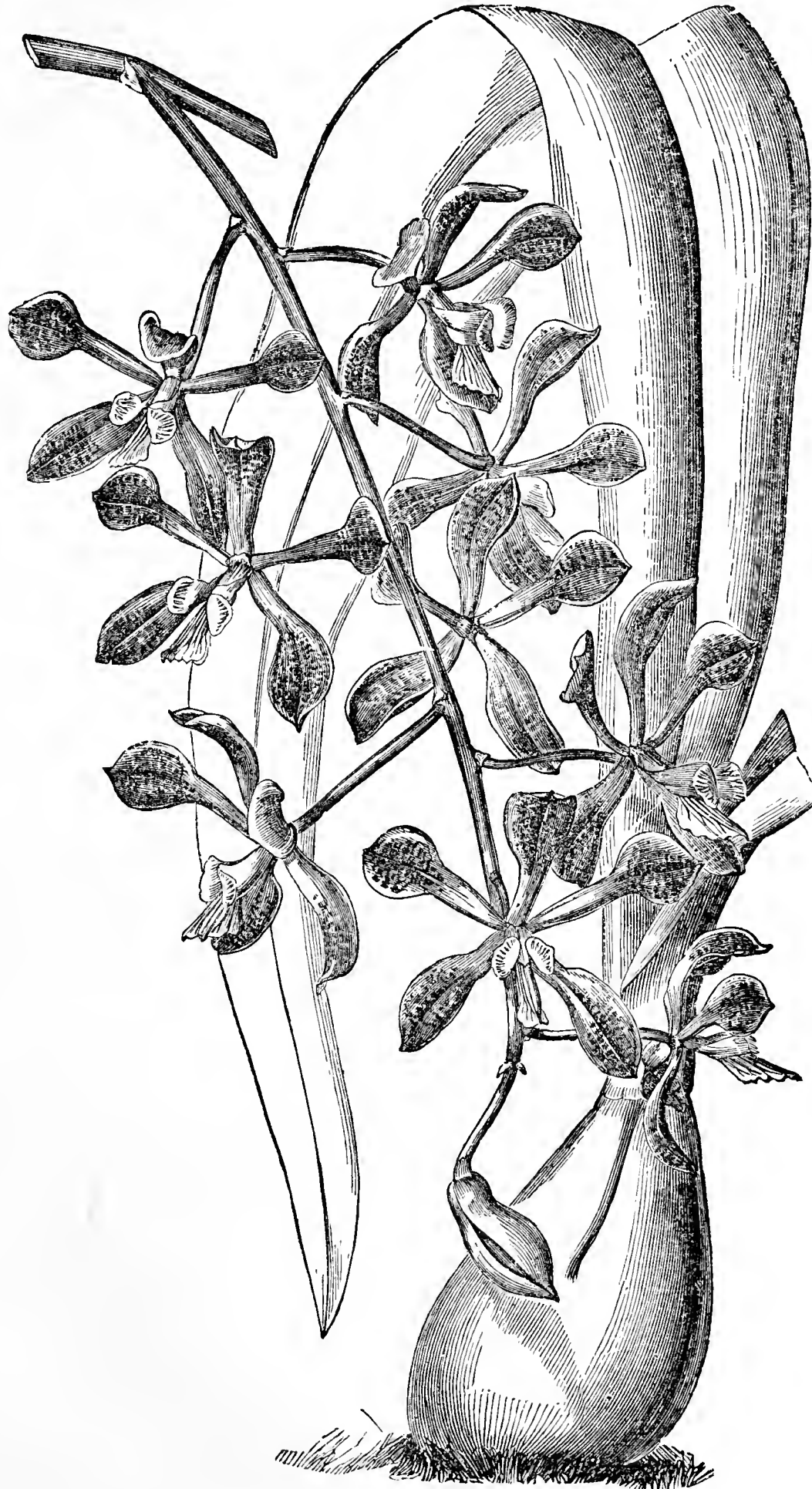

FIG. 93.—EPIDENDRUM COCHLEATUM.

with the most ordinary care. Small plants are especially useful for associating with the white or light-coloured *Odontoglossums*, particularly where an Orchid show house is provided, which, by the way, is a most useful adjunct wherever these plants are largely grown.

The originally introduced form of *E. vitellinum*, such as that, for instance, which is figured in the "Botanical Register" for 1840, had orange-yellow flowers comparatively small, though then much appreciated as presenting so distinct a shade of colour in Orchids. Now we have far better varieties of a rich orange-

scarlet colour, *E. vitellinum majus* being unquestionably the most handsome, especially when as well grown as the plant so admirably represented in the first number of Mr. B. S. Williams' "Orchid Album," which has three spikes, one with fourteen flowers. The species was first made known to botanists by a specimen in Mr. Lambert's herbarium, but the reputedly first living specimen which produced flowers in this country was one in Mr. G. Barker's collection at Birmingham in 1839. Hartweg found it in Mexico on the Cumbre of Tetontepeque at an elevation of 9000 feet, which will account for the low temperature it needs under cultivation. It is also found in Oxaca, growing on Oaks at 6000 feet elevation, and in Guatemala "on cloud-capped mountains in continual mists in the region of Lichens and Jungermannias."

Several species are much alike in habit, producing stems 3 or 4 or even 6 or 8 feet high, clothed with tapering leaves, and bearing large dense terminal panicles or racemes of flowers. These include the following, all of which are best grown in the Mexican house, and which constitute a handsome group in the genus.

E. evectum.—This has been long grown at Kew, and a large plant at one end of the cooler Orchid house is a familiar occupant, flowering frequently, though it is so high above the path that its flowers cannot be seen to the best advantage. It is thought to have been introduced by Purdie from New Grenadan mountains, but there is no actual record of this. The sepals and petals are ovate, rich purplish crimson, with a deeply fringed lip, and the flowers are borne in a dense terminal raceme.

E. syringothyrsus.—Another of the above type, a Bolivian species found at Sorata 7 to 8000 feet above the level of the sea, and introduced by Messrs. Veitch & Sons through Mr. Pearce. It is a very handsome plant, with individually small rich purple flowers, which are, however, produced in a very dense spike, the purple being relieved by the white lip and yellow prominences in the centre.

E. enemidophorum.—Also of similar habit to the preceding, and very attractive though less beautiful than some of them. It has drooping panicles from the apex of the stem, the flowers being pale yellow on the under surface, darker yellow above, mottled with reddish brown and having a warm rosy lip—a curious combination of tints. Mr. Bateman has stated that Mr. Skinner endeavoured repeatedly to introduce this plant without success, and until in 1844 a good batch was obtained, some being sold at Stevens's rooms, and the remainder distributed amongst Mr. Skinner's friends. One of these was sent to Sir Phillip Egerton, and this progressed so well, that when shown at Kensington in 1867 it was awarded a first-class certificate. It is a native of Guatemala at 7000 feet elevation, and is said to be cultivated in the convent gardens there.

E. rhizophorum.—This deserves a word of praise, for though not usually seen in the best condition it can be satisfactorily grown, and is then one of the finest. The flowers are small, but are produced in close spikes, the colour very strikingly resembling that of *E. vitellinum*—viz., a bright orange scarlet.

E. Cooperianum.—Is a peculiar species with a drooping terminal spike of flowers, the sepals and petals narrow and greenish yellow; the lip bright rose-coloured and three-lobed. It is a Brazilian plant, and was first shown at Kensington by Mr. Cooper, Alpha House, Old Kent Road, in 1866.

Quite distinct from the preceding is *E. eburneum*, which has narrow greenish yellow sepals and petals, with an ivory white heart-shaped lip $1\frac{1}{2}$ inch broad. This has its flowers in a terminal spike, but looser and smaller, though the flowers are much larger than the others. It is a native of Panama, where it has been found in swampy districts, and was obtained by T. R. Tuffnell, Esq., Spring Grove, Isleworth.

In the figure (page 411), a species is represented that is now comparatively little known, though not one of the least handsome. It will serve to illustrate the pseudo-bulbous type of Epidendrums, which are very distinct from those that have just been described. The pseudo-bulbs are a few inches high, irregularly egg-shaped, with long narrow tapering leaves proceeding from the apex, and between these arises the spike of ten or twelve brownish yellow flowers, the petals being blotched with chocolate, the lip white veined with purple. This, like many others of the section, requires rather higher temperature than the stem-producing forms. As a curiosity the Iris-like species *E. equitans* deserves notice, and this is also of some value, for even when not in flower its bright green tufted foliage, which so much resembles a miniature German Iris, has a very pleasing appearance in the Orchid house. Another notable species, *E. cochleatum*, which has a perpendicular lip, like one side of a bivalve shell with the broad end uppermost, is

said to be the first member of the genus which flowered in Great Britain. It is not common, but flowers frequently at Kew.

In connection with the propagation of Epidendrums it may be mentioned that several species, like some other Orchids, produce young plants upon their flower stalks. This is especially the case with the *E. evectum* group, in which the panicle is a direct prolongation of the stem, and at the nodes of which between the uppermost leaves and the flowers young shoots occasionally appear similar to the side shoots on some Dendrobes, and furnished with rootlets. When these have somewhat advanced they can be removed and potted, and will soon become established with ordinary care.—L. CASTLE.

PRIMULA SCOTICA AND ERYTHRONIUM GRANDIFLORUM.

THE illustrations of these plants in flower, which have recently appeared in the *Journal of Horticulture*, deserve remark. I have never before known *P. scotica* allow itself to be coaxed by cultivation beyond the normal size—about 3 inches high, with flowers not more than a quarter of an inch in diameter. I have frequently raised the plant from seed, and have twice received consignments from one of the native habitats in the Orkneys, but have never obtained better results than I have mentioned above. Still, I know that some Primroses, notably *P. rosea*, may by selection of seed from the largest flowers and careful attention to circumstances of cultivation be raised to three or four times the normal size, and it would be interesting to know the conditions under which *P. scotica* has been in such a way magnified quite out of itself.

The other plant, *E. grandiflorum*, I feel sure is the same as I bought at Mr. Ware's three years ago as *E. purpureum*. It has flowered every year in a peat bed, but this year for the first time has produced two pairs of leaves and two flower stalks, one of which is 9 inches high and bears six fine flowers. The leaves are more beautiful than the flowers, being glossy black veined with bright green, imitating on a large scale the handsomest forms of *Orchis mascula*. I have tried importing this bulb from America, but I find it to be formed of so brittle a shell—as brittle, in fact, as the shell of a wren's egg, that they always come broken and never grow. The greatest care, therefore, is necessary in planting the bulb when it can be obtained sound.—C. WOLLEY DOD, *Llandudno*.

[Our artist rendered the scape somewhat too long in the figure of *P. scotica*, otherwise it is a truthful representative of a strong plant grown in the south of England. *Erythronium purpureum* is quite distinct from *E. grandiflorum*, the former having a distinct tinge of purple which the latter does not possess. Our plant was the true *E. grandiflorum*, which has creamy white flowers.]

ROYAL BOTANIC SOCIETY.

MAY 16TH.

THE first summer Show of the year was as usual very beautiful, and though the competition in some of the classes was not so keen as on some previous occasions, the large marquee appeared quite full, and the banks of Azaleas, Clematises, Roses, and stove and greenhouse plants had a magnificent effect. Large numbers of new plants were shown and certificated, but these must be described on another occasion. The weather proved exceptionally fine, and a large number of visitors assembled during the afternoon.

ORCHIDS.—A handsome bank of Orchids was one of the features of the Show, the plants being mostly large and profusely flowered. The best amateurs' twelve was staged by Mr. Salter, gardener to J. Southgate, Esq., Selborne, Streatham, and included *Dendrobium thyrsiflorum*, six spikes, *D. Wardianum* with twelve growths well flowered, *D. Jamesianum*, *Oncidium concolor*, seven spikes, *Odontoglossum citrosimum*, *Vanda suavis*, *Dendrobium nobile*, 4 feet through, a mass of flowers, *Cattleya Warneri*, *Masdevallia Lindeni*, and *Ceologyne elata*. There was no other entry in the amateurs' class. Mr. H. James, Castle Nursery, Lower Norwood, took the lead in the nurserymen's class with a good collection, *Cypripedium Stonei* having five spikes, *Burlingtonia fragrans*, *Lælia purpurata*, *Dendrobium Jamesianum*, and *D. fimbriatum oculatum* being the best. Messrs. Jackson and Son, Kingston, followed, their plants including a specimen of *Schomburgkia tibicinis* in flower; *Oncidium ampliatum majus*, *Masdevallia Lindeni*, *Odontoglossum cirrhosum*, and *Saccolabium guttatum* were the other best plants. It is regrettable that the competition was so limited in these classes, as usually they are well filled.

STOVE AND GREENHOUSE PLANTS.—Several beautiful collections of these were staged, the quality being all that could be desired in the leading exhibits. Messrs. Jackson & Son were first with twelve *Erica Webbia*, *E. Cavendishiana*, *Hedaroma fuchsoides*, *Aphelaxis marcantha rosea*, *Hedaroma tulipifera*, and *Erica Lindleyana* being most

excellently trained and well flowered. This firm was also first with six specimens of similar quality. Mr. E. Tudgey, Waltham Cross, was second with twelve specimens, large, fresh, and profusely flowered. In the amateurs' class for twelve Mr. Chapman, gardener to J. Spode, Esq., Hawkesyard Park, Rugeley, took the lead with admirable specimens. *Tremandra ericæfolia*, *Erica depressa major*, *Statice profusa*, *Erica affinis*, *Acrophyllum venosum*, and *Dracophyllum gracile* were especially notable. Mr. Chapman was also first with six plants. Mr. J. Child, gardener to J. Bell, Esq., Garbrand Hall, Ewell, followed with twelve smaller specimens, but healthy; other prizetakers being Messrs. B. Peed & Son, Streatham, and Mr. G. Wheeler, gardener to Lady Goldsmid, St. John's Lodge, Regent's Park, in the nurserymen's and amateurs' classes respectively.

AZALEAS.—In the open class Mr. C. Turner, Slough, took the first honours for twelve with specimens of moderate size, even, and richly coloured. Mr. A. Ratty was second, and Messrs. B. Peed & Son third. Mr. Child was first with six Azaleas—pyramidal specimens loaded with flowers, *Iveryana* and *Criterion* being wonderfully fine. For six Azaleas in 12-inch pots Mr. Child was also first with handsomely flowered specimens of *Iveryana*, *Duc de Nassau*, *Eclatante*, *Dr. Livingstone*, *Mrs. Turner*, and *Duchesse de Nassau*. The remaining prizes were secured by Messrs. Jackson & Son, B. Peed & Son, G. Wheeler, and A. Ratty, gardener to R. Thornton, Esq., The Hoo, Sydenham.

FINE-FOLIAGE PLANTS.—Mr. Rann, gardener to J. Warren, Esq., Handcross Park, Crawley, was first with six enormous specimens in the amateurs' class, Cycads, Palms, and Ferns being in grand condition. Mr. G. Wheeler was second, his collection including five Palms. Other prizetakers were Mr. F. Mould, Pewsey, Wilts; Mr. R. Butler, gardener to H. Gibbs, Esq., St. Dunstan's, Regent's Park.

PELARGONIUMS.—These were not largely shown, but in very good condition. For six Show varieties Mr. C. Turner won first honours in the nurserymen's class; *Viscount*, *Modesty*, *Venus*, *Illuminator*, and *Digby Grand* were remarkable for the size of their flowers. Mr. J. Odell, Shepherd's Bush, was third with much smaller plants. Mr. J. Wiggins, gardener to H. Little, Esq., Uxbridge, was first in the amateurs' class, *Miss Bradshaw* being wonderfully fine. In the open class for six Fancy Pelargoniums Mr. C. Turner was first with neat little specimens, closely followed by Mr. Wiggins, both collections being remarkable for their freshness.

ERICAS.—Messrs. Jackson & Sons had the best six Heaths in the open class, exceedingly healthy and well-flowered specimens; *ventricosa coccinea minor*, *depressa*, and *Cavendishiana* were very fine. Mr. Tudgey was second, also with fairly good plants. Messrs. B. Peed & Son and Mr. Mould were third.

CLEMATISES.—Only one group of Clematises was staged, for which Messrs. George Jackman & Sons, Woking, Surrey, were deservedly awarded the first prize. The specimens were about 5 feet high and 4 in diameter, of globular form, and bearing large flowers. *Gloire de St. Julien*, *Madame Van Houtte*, *Mrs. Hope*, *Lawsoniana*, *Henryi*, *purpurea elegans*, and *Fairy Queen* were the chief varieties. These formed a grand bank near the entrance to the tent, and were a fine contrast to the brightly coloured Azaleas.

ROSES.—Messrs. Paul & Son, Cheshunt, were the chief contributors in the class for nine Roses in pots, and secured the chief prize for their usual grand specimens, the gigantic *Celine Forestier*, *Charles Lawson*, and *Madame de St. Joseph* being in magnificent condition. The smaller examples of *Camille Bernardin*, *Marquise de Castellane*, *Anna Alexieff*, and *Madame Victor Verdier* were similarly fresh and vigorous. Mr. F. Mould was awarded the third prize. For twenty Roses in 8-inch pots Mr. C. Turner won the principal honours with dwarf plants bearing large and richly coloured flowers, and representing a number of fine varieties.

FERNS.—Mr. G. Wheeler was first with six Ferns; *Alsophila australis*, *Davallia Mooreana*, and *Alsophila excelsa* were the best of his plants. Mr. R. Butler was second with small but healthy specimens.

Messrs. J. Carter & Co. were awarded the first prize for a collection of hardy plants; and Mr. H. Eason, gardener to B. Noakes, Esq., North Hill, Highgate, was first for *Gloxinias*.

MISCELLANEOUS.—A large number of beautiful groups were staged, and were equally as attractive as the competitive classes. The following awards were made:—A large silver medal to Mr. B. S. Williams, Upper Holloway, for a large central group of Orchids and choice stove and greenhouse plants, including many novelties; a large silver medal to Messrs. Laing & Co., Forest Hill, for a handsome central group of Caladiums, Begonias, and miscellaneous fine-foliage and flowering plants; a silver medal to Messrs. Cutbush & Son, Highgate, for a pretty group of Ericas, Azaleas, Boronias, and greenhouse plants in flower; a silver medal was also accorded to Messrs. H. Lane & Son, Berkhamstead, for a large group of Azaleas and Rhododendrons; a small silver medal to Messrs. James Carter & Co., High Holborn, for a large group of seedling *Dracaenas*, including many fine varieties, and a large bronze medal was awarded to the same firm for a group of well-grown *Calceolarias*; a silver medal to Mr. Young, gardener to Captain Patton, Alpha House, Regent's Park, for a tasteful group of flowering plants arranged on a groundwork of *Adiantum cuneatum*, Caladiums, and *Gloxinias*; a large silver medal to Messrs. W. Paul & Son for eighteen boxes of Rose blooms, very fresh and brightly coloured; a large bronze medal to Mr. Turner for

five boxes of Alpine Auriculas, and similar awards to Messrs. H. Cannell & Sons, Swanley, and Messrs. J. Dobson & Son, Isleworth, for groups of *Calceolarias*.

First-class botanical certificates were awarded for the following plants:—To Messrs. J. Veitch & Sons for *Davallia brachycarpa*, *Impatiens Sultani*, *Wormia Burbidgei*, *Begonia gogoensis*, *Acanthophippium Curtisii*, *Cattleya iricolor*, *Dendrobium leucolophyllum*, *Cypripedium recurvipetalum*. To Mr. B. S. Williams for *Ochna multiflora*, *Maxillaria luteo-alba*, and *Epidendrum Frederici Gulielmi*. To Messrs. Laing & Co. for *Caladium Luddemannianum*, *C. ornatum*, *C. cardinale*, *C. Verdii*, and *Prunus Pichardi*. Floricultural certificates were awarded to Messrs. J. Veitch & Sons for *Amaryllis Star of India*, *Azalea Souvenir* and *Azalca Baron N. de Rothschild*. To Mr. Turner for *Azalea Madame Van Houtte*, *Auriculas William Coomber*, *Richard Gorton*, *Rob Roy*, *Ouida*, and *Resplendens*. To Messrs. Laing & Co. for *Begonias Little Gem*, *Canary Gem*, *Prince of Wales*, *Queen of Doubles*, *Sir Garnet*, *Clarinda*, and *Colens Canary Bird*. To Mr. Sladden, Forest Hill, for *Rhododendron Greavesii*; and to Messrs. W. Paul & Son and C. Turner for *Rose Merveille de Lyon*.

IRISES.

AS one of the large audience which so attentively listened to the remarkable lecture on *Iris susiana* given by Dr. Michael Foster at the Linnæan Society's rooms last week, I have ventured, through the pages of this Journal, to ask him for a little information upon another beautiful group of Irises with which he is doubtlessly as familiar as those he described. For many years I have grown Irises, and though my collection now is a moderate one, I have at times tried a large number of species. The bulbous group, Mr. Baker's *Xiphions*, are especial favourites with me, but unfortunately some of them do not yield the most satisfactory results. It is true that *X. reticulatum* and its variety *Krelagei* grow and flower well out of doors in a rather dry border. *X. persicum*, I find, is best in a pot, and not very good out of doors, but the beautiful *X. Histrio* is not a success. What are its special requirements? *X. junceum*, too, has troubled me a little on several occasions, though when it does flower I am abundantly rewarded. Can Dr. Foster also inform me if *X. tingitanum*, *X. diversifolium*, and *X. Fontanesii* are now in cultivation, or whether he has grown them?

These lovely plants cannot be too widely known, and I can fully understand Dr. Foster's enthusiasm in describing the attractions of the genus, for even the apparently insignificant forms that would be passed by the casual observer as undeserving of attention possess charms which a closer examination would soon reveal. The diversity of colours, the strangeness of the markings, and the peculiarity of structure have an interest which is equalled only in my opinion by the Orchids.—A LOVER OF IRISES.



HARDY FRUIT GARDEN.

Peaches and Nectarines.—When the fruit is set and is swelling freely, then, and not till then, begin disbudding. Let there be no hesitation about doing this freely, for it is a very general fault to retain a lot of shoots now which will have to be destroyed in the winter pruning. Do not, however, remove all superfluous growth at once, but take half or two-thirds according to its condition, the lesser quantity from backward or weakly trees, and the greater from those which are vigorous and bristling with sturdy shoots. To disbud a tree thoroughly at once is apt to leave it very bare and to induce premature fruit-shedding. Taking it as a safe general rule that the last year's growth, which is the fruiting wood of this year, is kept at the winter training 3 inches apart, we have little or no difficulty in deciding how many of the new shoots will be required for next year's fruit crops; only remember that on a fan-trained tree of the usual semicircular form an extra number of new branchlets are required for the greater space near the tops of the branches; even there from a dozen to eighteen shoots often have to be removed from a branch only 2 feet in length. We are fully aware that fruiting wood is frequently trained much closer than we recommend, but the practice is unsound, inevitably inducing weakly growth and small fruit.

Pear trees against walls are now growing fast, and pinching the lateral growth must be done as soon as it is 3 or 4 inches

long. Pinch it at the third leaf from the base, by which about an inch of new growth is added to the spurs each time the lateral growth is so shortened. Leading shoots on trees that have not yet filled the space allotted to them should not be stopped till they are 16 inches long, but then it may be done advantageously by taking off a couple of inches to induce lateral growth and an additional leading growth. Do all that is possible to protect blossom and clusters of incipient fruit from harm, but do no thinning till the fruit is swelling freely, for then, and not sooner, can you proceed with any degree of certainty.

Currants trained to walls require attention now in stopping the lateral growth and making fast the leading growth, which is quite long enough to be broken by high wind, as it so often is when this trifling but important timely care is not given it.

Strawberries are now growing freely, and are sufficiently forward to derive much good from sewage, which should be given freely now, and again when the fruit begins swelling.

FRUIT-FORCING.

Vines.—Cold northerly winds have retarded the crops considerably, and a wished-for change from dull weather to warm and bright sunshine it is hoped will soon set in, under which a great improvement may be expected in the occupants of forcing houses, and in Vines especially. In this case, where early closing has been practised, fire heat may be considerably reduced. After so much sharp firing as the cold weather has necessitated, red spider may be expected, especially if the inside borders have not been properly watered. Early ripe Grapes will only need sufficient artificial heat to keep up a circulation of rather dry warm air, and to prevent the temperature falling much below 60° at night. Although the moisture is to be reduced the floors and walls should be damped on fine days, as moderate moisture will not injure ripe Grapes at this season, and is essential for the maintenance of healthy foliage. Syringe the foliage freely as soon as the crop is removed to keep it clean and healthy as long as possible, as the loss of the principal leaves injures the Vines and affects the next season's crop of fruit. Warm rains passing through heavy mulchings on outside borders are beneficial for thoroughly established Vines in full growth, and where these are not afforded artificial should be resorted to, if the borders are dry affording the water or liquid in a tepid state. Muscats, Alicantes, Lady Downe's, and other shy-setting kinds set as fully and require as much thinning as Hamburgs in a day temperature of 85° to 95°, and 70° at night, it being good practice to remove all the surplus bunches before the Vines flower, as with assistance in this way and careful fertilisation duly performed the most shy-setting kinds will set every berry. Late Vines now in rapid growth must be tied out and stopped as soon as sufficient wood is made to furnish the trellis with uncrowded foliage. If fermenting material on outside borders has not been removed a portion ought now to be taken off, avoiding a sudden check by leaving sufficient for a good mulching. Do not allow thinning in succession houses to fall into arrear, as Grapes at this season swell very rapidly. Cut-back Vines intended for next season's fruiting should be potted without delay, giving generous treatment, and stop when they have made a growth of about 8 feet, or sufficient for the position they are to occupy.

Pines.—The vigorous state of growth at this season will tend to render the plants susceptible of injury from inattention to ventilating, watering, and shading if necessary, as it often is in the early summer months when the panes of glass are large. As the solar heat increases employ fire heat simply as an auxiliary when the other fails or is insufficient for the purpose. Young growing plants should have the heat maintained at 70° at night, keeping that of the fruiting department at 75°. In close damp pits or houses where the plants are at a considerable distance from the glass great care will be necessary to prevent an attenuated growth, which happens more particularly with young plants insufficiently ventilated. Where fruiting plants are so located watchfulness will likewise be necessary and ventilation, or the crowns of the fruits will be increased beyond reasonable proportions, which is not only unsightly but deteriorates the value of the fruit. The remedy in both instances is to take timely precautions in the way of a freer circulation of air during the prevalence of bright sun. Fruit approaching ripeness and in close proximity to the glass will be much benefited by being slightly shaded for a couple of hours at midday, and providing the heat is well maintained, liberal ventilation at this stage of development will be a material aid to perfection both as regards colour and quality. As soon as a fruit ripens it should be cut and removed to a more temperate place, if it is to be kept, pot cultivation affording a great advantage, as the fruit and plant can be removed together, and the fruit thereby preserved fresher and better.

Melons.—Fruit ripening should have a little ventilation at night, or flavour will be wanting, close confined air not being favourable to high quality. Plants in pits or frames recently planted, and having been stopped at the second or third rough leaf, will have thrown three or more leading shoots, which should be evenly trained over the allotted space and all others closely rubbed off. The leading shoots may be stopped when they have grown to a length of 18 inches, when they will send out laterals showing fruit freely. The fruit-bearing flowers should be stopped one joint beyond the fruit when the flowers are impregnated. Put on air early in the day to prevent scorching. Close about 3.30 P.M. on bright days. Attend to the earthing-up of hillocks as they require it.

THE FLOWER GARDEN AND PLEASURE GROUND.

Preparing for Bedding-out.—Owing to the backwardness of the season and the cold state of the soil planting the summer bedding plants will necessarily in some, and advisably in other cases, be late. Wallflowers, Myosotis, Pansies, Daisies, Alyssum, Saponaria, Silenes, and other hardy bedding plants are now at their best, and probably will be gay till near the middle of June. These hinder bedding-out, and will also leave the ground in a dry impoverished condition, consequently strong-growing plants should be had in readiness, and a quantity of decayed manure or leaf soil be dug in prior to planting. Strong plants of Zonal Pelargoniums are not much injured by being kept in small pots, as these, providing the balls are loosened when planted, soon become established. Ageratums, Lobelias, Violas, Verbenas, Calceolarias, Gazanias, Heliotropes, Dahlias, Solanums, Ricinuses, Maize, Salvias, Fuchsias, Wigandias, Grevilleas, Cannas, Tobacco, Polymnia, and Erythrinus ought not to long remain in small pots, or they will receive a check from which they will not quickly recover. The first seven mentioned are best boxed off or else bedded-out temporarily in rough frames as previously advised. The remainder should receive a shift into larger pots. Any good loamy soil suits them, and they will well repay the extra trouble.

All the hardiest of the bedding plants, such as autumn-struck Pelargoniums, Lobelias, Koniga, Cineraria maritima, Centaureas, Verbenas, Golden Pyrethrum, and Polemonium ought now to be stood out on ashes, giving the preference to sheltered sunny spots. Some provision should be made for protecting from late frosts as well as from heavy rains. The frames will thus be liberated for the hardening-off or the pricking-out, as the case may be, of such tenderer kinds as Heliotropes, Ageratums, Perilla, Tagetes, Salvias, Dahlias, Marigolds, Asters, Stocks, Nasturtiums, Zinnias, Godetias; while in the houses Iresines, Alternantheras may be boxed off, and *Amaranthus melancholicus ruber* and *Coleus Verschaffeltii* potted off singly. Care must be taken not to overwater the four last named, especially when first placed in cooler quarters or in the open. The *Amaranthus* is a good substitute for Iresine *Herbstii*, and may yet be sown. It is best sown late, grown quickly, and planted out when all danger from late frosts may reasonably be considered past. Dell's Crimson Beet may yet be sown in small pots and placed in heat—that is, supposing plants are required either to make up a given number or as substitutes for Iresine *Lindenii*. It is a good though seldom-adopted practice to preserve all the smallest of the Beet grown in the kitchen garden and to plant these where required. They are certain to push up flower stems, and if these are frequently pinched back stocky highly coloured plants result, and the leaves, being narrow, much resemble Iresine *Lindenii*.

Any plants of herbaceous Pyrethrums, Pentstemons, Antirrhinums, Delphiniums, Campanulas, Hollyhocks that for safety have been wintered in frames, or strong early seedlings, ought at once to be planted. All pay for liberal culture. Manure freely, dig deeply, and if the soil is rough add a good quantity of light mould from the compost yard, and plant firmly and deeply, without, however, unduly burying the collars. Slugs are very destructive among Pyrethrums, Carnations, Pinks, and later on Dahlias, consequently they should be closely trapped and destroyed. Thin out herbaceous Phloxes, old stools of Pentstemons and Antirrhinums, and Asters, a few strong flowering growths being preferable to many weak ones. Thin out and stake Sweet Peas, and sow more for a late supply of bloom. The flower borders should be frequently stirred with a Dutch hoe, this destroying weeds, partially exterminating slugs, and otherwise proving beneficial.

Briars budded last season should have their stems kept clear of shoots and the suckers pulled, not cut off. Look sharp after and destroy the grubs which have a partiality for young Rose shoots. Briars being prepared for budding should have their shoots reduced to two or three in number, according to their strength, these being disposed nearly at one height, and so as to form a well-balanced head.

THE BEE-KEEPER.

SWARMING.

1, *Natural Swarming* depends on the state of the hive. The state of the hive depends on the weather, the fertility of the queen, the number of young bees which went into winter quarters, and, among other minor causes, upon the size of the hive. With properly constructed hives the bee-master can generally regulate this natural tendency of bees to swarm. He can postpone the event, or sometimes prevent it altogether. But let us see what really takes place in a hive which is about to swarm. Governed by the various causes we have just named, swarming takes place from the end of April to the beginning of June—that is, for prime or first swarms. Later swarms or casts are sometimes sent off in July.

The crowded state of the hive, bees clustering about the entrance or under the alighting boards, are outward visible signs that swarming is at hand. The signs inside the hive will be—first, the restless state of the bees, their disinclination for work, and above all the presence of queen cells. These cells are commenced sometimes seven or eight days before swarming takes place. This is a wise arrangement, since after the mother has departed with the swarm there will be a period of something like a fortnight before any more eggs will be laid in the hive. By anticipating the departure of the swarm the period is lessened during which the hive is not only making no progress but going back. A succession of wet days will retard swarming, and a continuance of chilly wet weather will altogether prevent it for the season. Swarming may sometimes be prevented by cutting out all the newly-made queen cells. These are to be found generally down the ends or bottoms of the combs, but very often in the middle of combs, especially where pieces of the comb have been cut out for any purpose.

We will suppose that the swarm comes forth. Mother queens nearly always leave with their swarms during the middle of the day—i.e., from ten to two o'clock. The bees sometimes alight on a small bush or other place from which they can be easily shaken off. But at other times they choose places which sorely try the courage and ingenuity of the young bee-keeper; covering with a thick coat of insect life a gatepost or a stone wall, or clinging in an expanded mass on a chimney, or settling under the thatch of a cottage or haystack, or far up on the topmost branch of a forest tree. All these positions have at times been chosen by our own bees. And then one reads of the swarm of bees who hung to a door-knocker, or another which took possession of a Hansom cab. But the comfort is on such trying occasions, that of all times bees are less inclined to use their stings during swarming. A bunch of grass, or a brush of Asparagus tops is a good brush to have with which to sweep bees off flat surfaces. The queen may often be easily picked out when in such a position, and can this be done the affair is much simplified. She should be seized by the wings, placed in the crown of a skep. As many bees as can be conveniently swept off should be dropped into the skep with her, the hive then inverted on the grass or earth close to the spot resting on two sticks laid flat on the ground. The bees which fall, as well as those left clinging, will soon discover her majesty and all cluster in a short time in the crown of the skep. If they are to remain in the straw hive it should be placed in its permanent position as soon as the majority of the bees have entered. The few stragglers will either find it out or return to the parent hive. Much time is saved by bee-keepers who get their swarms on their stands as quickly as possible. It will be seen by watching that bees are sent off foraging very soon after the cluster is formed in the hive. Old-fashioned bee-keepers used to leave the swarms under the bush or hedge or other place where hived until evening. The bees thus left took their bearings for this spot, and the next day many bees were found hovering around, vainly looking for the hive which was there the day before, and which they left without taking notice of its removal in the morning.

If the bees are to be placed in a bar-frame hive there is nothing better than a zinc pail for the purpose of either pouring them out in front of the hive lifted up slightly on two wedges, or for pouring them into the body of the hive, the dummy having been drawn back, or a few frames having been lifted out previously. It will be found that bees run out like water from the pail to which they have no power to cling. We have always recommended feeding swarms for a few days after hiving. Nothing is lost, but rather there is a great gain got by the bee-keeper who feeds until his hive is well supplied with comb. It is difficult to give much foundation to bees in a skep, but in a bar-frame hive full sheets of foundation can be given, which will be filled out by the bees in a much shorter time

than they would otherwise take, and with very little expenditure of honey for making the comb. We have watched bees filling out the foundation in glass hives, and it is surprising what an amount of work a strong colony does in twenty-four hours. It is our intention this season to experiment with two hives peopled the same day with swarms as nearly as possible under equal conditions as to age of queens and weight of swarms, only one shall be supplied with full sheets of foundation and one left to build their own combs entirely themselves. The result shall be duly placed before the readers of this Journal, all being well.—P. H. P.

TRADE CATALOGUES RECEIVED.

James Dickson & Sons, Newton Nurseries, Chester.—*Stove and Greenhouse Plants.*

F. W. & H. Stansfield, Sale, near Manchester.—*List of British Hardy, Exotic, and Greenhouse Ferns.*

J. Cheal & Sons, Lowfield Nursery, Crawley, Sussex.—*List of Florists' Flowers and Bedding Plants.*



* * All correspondence should be directed either to "The Editor" or to "The Publisher." Letters addressed to Dr. Hogg or members of the staff often remain unopened unavoidably. We request that no one will write privately to any of our correspondents, as doing so subjects them to unjustifiable trouble and expense.

Correspondents should not mix up on the same sheet questions relating to Gardening and those on Poultry and Bee subjects, and should never send more than two or three questions at once. All articles intended for insertion should be written on one side of the paper only. We cannot reply to questions through the post, and we do not undertake to return rejected communications.

Grubs in Garden (*S. C., Cheshire*).—The grubs you have sent are larvæ of the Daddy-longlegs, *Tipula oleracea*. They are highly destructive in gardens and difficult to extirpate. We have nothing to add to the reply we gave to "W. T. W.," on page 393 last week.

Hollyhocks Unhealthy (*S. S., Darlington*).—The discoloration of the leaves is, we think, the result of the late inclement weather, and they are not, so far as we could perceive in their crushed and dried state, attacked by the disease which is often so destructive later in the season. The specimens, however, did not arrive in a condition to be satisfactorily examined. If you send others at any time please pack them in a small box of some kind.

Piptanthus nepalensis (*Flora*).—Your plant is a native of India, but at an elevation enabling it to endure the English winters in most parts of the island, and it will undoubtedly be safe against a wall in Devonshire. In our issue for June 22nd, 1882, page 507, we figured a spray of this shrub from a specimen at Sheffield, where it succeeds well. It is popularly known as the Evergreen Laburnum.

A Double-spathed Calla (*J. W.*).—We have seen many specimens similar to that you sent; indeed, some have the two spathes nearly of equal size, but they are certainly less beautiful than the ordinary forms, and only worth preservation as a curiosity. Such occurrences cannot be accounted for according to any definite rule, but any kind of check to vigorous plants will frequently result in the production of abnormal growth or malformed organs.

Culture of Ophrys aranifera (*Somerset*).—If you intend growing it out of doors prepare a shady and moist, but not too wet, position for it, placing some peat, sand, and leaf soil together to form a suitable compost. This also will do if the plant is grown in a pot, but then care must be exercised to insure that it does not become too dry.

Manure for Mushroom Beds (*J. W., Chester*).—Your friend is quite right; manure is not good for Mushrooms that is obtained from stables in which the horses have been fed largely on Carrots. You will find this more fully stated in Mr. Wright's treatise, also the right kind of manure, and best mode of preparing it for the beds. No crops are more easy to grow than Mushrooms, provided suitable manure, good spawn, and the other requisites of success are provided. Read the treatise mentioned, which you can have post free from this office in return from 7d. in stamps.

Early-flowering Hardy Perennials (*E. T. H.*).—There are numerous plants that would be suitable for the purpose you name, and of all the following seeds can be purchased, but several, such as *Adonis vernalis*, are preferably obtained as roots:—*Alyssum saxatile*, *Anemones*, *Aubrietia deltoidea* and *A. græca*, double Daisies, *Erysimum pulchellum*, *Helleborus niger*, both the Iberises you name, *Myosotis dissitiflora*, *M. sylvatica* and *M. alpestris*, *Viola Tory* (blue), and *Yellow Perfection*. Of course, if you wish to include biennials as well you should grow Wallflowers, Sweet Williams, and Canterbury Bells, while Primroses, Polyanthus, and Alpine Auriculas would form valuable additions.

Crystallising Strawberries (*Fragaria*).—Strawberries are very delicate fruits for the purpose you name, and it is very difficult to crystallise them satisfactorily. The usual method is to place them in a slowly boiling mixture of sugar and water, allowing them to simmer slightly for a short time until the fruit is tender. They are then removed and dipped into a syrup composed of

1 lb. loaf sugar boiled with a cup of water, and exposed near a fire or in an oven to dry, but the heat must not be too great or it will discolour them.

Various (C. B. B., Kilkenny).—The chief difference between *Dipladenia amabilis* and *D. Brearleyana* is the larger size and deeper rosy crimson colour of the latter's flowers; the former also has the blooms more frequently in dense clusters. The flower of *D. Brearleyana* cannot be termed scarlet, although it is very rich and bright. We cannot tell which your plant is without specimens of the flowers, as you give no description further than the colour. Your gardener has done quite right, and a temperature of 60° from now onwards will be suitable. The price of Mr. Barron's work on "Vines and Vine Culture," is 10s., post free 10s. 6d., from this office. It is a very complete and excellent work.

Peach Trees Unhealthy (W. N., Exeter).—Your Peach tree is in a weak and exhausted state, and if means are not taken to restore it, it will die. The peculiar appearance is not caused by insects, but is the result of defective root-action. The old soil should be removed from the roots and fresh added. This may be done early in the autumn, and in the meantime you had better apply tepid liquid manure to the roots copiously. We saw a number of Peach trees similarly affected to yours, but not exactly, in charge of Mr. Egghalden, but by the practice of the soil in the manner he described on page 167, the issue of August 24th, 1882, he speedily restored the trees, and they are now in a healthy free-bearing state. You cannot do better than follow his example, and if you do not happen to have the number indicated, it can be had from this office in return for 3½d. in stamps.

Vines Unsatisfactory (R. H. R.).—You have not planted the Vines as we should have planted them, but provided the balls of soil that were turned out of the pots are not dry in the interior, the method of planting would not account for the present condition of the Vines. See what Mr. Taylor says on page 28 in his "Vines at Lougheat" on the danger of the old soil getting too dry. You had better search frequently and carefully at night for weevils, as the symptoms you describe are indicative of the presence of these destructive pests. Maintain a moist genial atmosphere, and syringe freely. A weak solution of quassia water applied to the growths might render them distasteful to insects. The weevil to which we refer is like a small beetle, and eats the unfolding leaves of Vines.

Vines not Bearing (J. H.).—When Vines only bear at the top, no fruit being produced from the lower half of the rods, it is an almost certain sign of weakness and exhaustion. The laterals are no doubt weak, the foliage small, and perhaps overcrowded, also the border is probably exhausted or the root-action defective. If you state the age of the Vines, the distance the rods are apart, and also the distances of the laterals from each other, we shall be better able to suggest a mode of treatment than we are now in the absence of the requisite information for understanding their condition. If you write again you must be good enough to restate the whole case, as we are not able to remember the details of previous letters.

Roses under Glass (A. A. B.).—We know a very fine house, the roof of which is entirely covered with Roses, with Camellias planted in a bed beneath them, and both Roses and Camellias thrive admirably and bloom freely. The Roses are planted in an outside border like Vines, and trained up the roof. Great care is taken to prevent the attacks of insects on the Roses, or the Camellias would not be so clean and healthy as they are. Observe, we use the word "prevent," for there is a very important difference between not allowing insects to appear on plants, and waiting for their presence and destroying them afterwards. If a roof is covered with Roses other Roses would not grow and flower well under them. Side lights would not be absolutely necessary for a house the roof of which is to be covered with Roses, but front ventilators should be provided. The size of the house is immaterial, and it may be determined by the demand for flowers. We could probably have given you a more useful reply if you had stated the object you have in view. More blooms are obtainable from Roses planted out than from the same number of plants in pots, and with much less than half the labour and attention that would be necessitated by pot culture.

Leaf Soil (J. S.).—You ask us what we think of the sample of leaf soil you have sent. We are not at all favourably impressed with it, and should hesitate to use it to any plants of value. If it is not sour by having been left to decay in a heap for a long time it is certainly not sweet, and it is too old and fibrous to be considered at all good. You say you are trying experiments with it. This, after all, is the practical way of testing soil. It may do for mixing with heavy soil for free-growing plants, such as Chrysanthemums and Pelargoniums; but we should not like to use it with the soil for Camellias or Azaleas—in fact, we should not use it at all if we could get any better. It is very different from the leaf soil referred to on page 333, as used with such success by Belgian cultivators.

Vines Unhealthy (J. R.).—It is no use sending the leaf of a Vine or any other plant within the folds of a letter if it is required to be satisfactorily examined for the detection of insects. The leaf you sent was crushed and dried, and not an insect was to be found. There are a number of small brown specks, where there has been exudation of sap, which have dried and assumed a wart-like appearance. The leaf has also been scorched in places, and is generally in an unsatisfactory condition, indicating that the Vines lack vigour. If you wish us to see a fresh specimen you must send it in a small box, so as to arrive fresh and sound.

Marechal Niel Rose in Vinery (Arthur).—Provided the Rose is not shaded by the Vines we should cut it down, but not necessarily so low as you indicate. It should be shortened to where there are good healthy buds and foliage, and two, three, or perhaps more we should expect to start and produce good growths during the summer and an abundance of blooms next year. The plant will need syringing and a genial atmosphere to induce a quick start and good growth; but growth made under the shade of Vines would be weak, and instead of this we should prefer to rely on the shoot already made. We do not quite understand the position and condition of your Rose, but we think you will comprehend what we mean. There is plenty of time for a healthy Marechal Niel cut down now to make growths for producing flowers next year, provided the conditions are suitable. We do not know of a cheaper and more suitable book on wild flowers than "The Handbook of British Plants," published at this office, price 3s. 6d.; post free, 3s. 8d.

Footstalks of Bunches of Duke of Buccleuch Grape Decaying (H. T. H.).—Had you stated the conditions under which the Vine is grown, and the treatment to which it has been subjected, you would in all probability have suggested the cause of the injury. As we never saw anything of the kind before, and the growth of the Vine was evidently very free and healthy, we sent the sample to the raiser of the Duke, Mr. William Thomson, who has favoured us with the following reply:—"My impression is that the stalk of the bunch has received mechanical injury. I never saw a bunch go so from any other cause; a slight bruise would develop into the state it is in. Excess of moisture

and too low a temperature might produce something like it, but a bruise by careless handling is the most likely cause. We have a thousand bunches of the Duke just setting, and not one so affected. It is nothing peculiar to the Grape in question." We are quite of opinion that Mr. Thomson has indicated the cause of the injury. It is either the result of rough handling or a low damp atmosphere, and you can probably determine, which we cannot in the absence of data to enable us to express a more definite opinion on the matter. If all the bunches are so affected we can only express our sympathy with you on the unfortunate occurrence. Note.—Your explanatory note arrived after the above reply was in print.

Dead Cells in Vine Leaves (W. A., Northumberland).—Only a powerful microscope could reveal the cause of the seriously infected foliage; hence, after examining it ourselves, and being satisfied that there was little fungus, we sent the specimens to Mr. W. G. Smith, who has obliged us with the following reply:—"With the exception of a few transparent fungus threads over the leaf, I can see no fungus; the threads no doubt belong to the oidium. I can see no trace of fungi in any of the brown spots; the spots are companies of dead brown cells—eroded cells—by what caused I do not know, but I should say certainly not by any fungus. Fungus spots are generally very opaque when held up to the light, but these are transparent. Insect injuries cause transparent spots, which may be whitish or brown. The fungus *Septoria Badhamia* causes spots like these, but I cannot see anything of that fungus." If the leaves sent fairly represent the state of the Vines they are weak and debilitated, and this may have caused the death of the cells. We do not approve of the plan of digging manure a foot deep in a Vine border. A heavy dressing of lime lightly pointed in would doubtless do good; but we suspect the roots must be placed in fresh soil before the Vines are invigorated. The present border is in all probability sour, and is destitute of surface roots, which alone produce Vines in the highest state of health.

Cutting Down Camellias (C. H. T.).—Our correspondent, "Little Market Gardener" is quite right in his views on cutting down Camellias. We have cut down the plants quite as severely as he has done, and with equal success. But this does not follow that all plants that are not in good health should be thus treated. The practice would result in a loss of all blooms, at least for a season. Nor are we prepared to say that plants much enfeebled and almost destitute of root-action would in every case answer by being severely pruned below all the foliage; in fact, we have seen plants that did not succeed well after being cut down. If we had a collection of unhealthy Camellias, and at the same time a stove or hothouse that we could keep very warm and moist, we should certainly cut down some of the plants, and by syringing them a few times a day and maintaining a very high temperature we should expect at least some of them to break; but they would be far less likely to do so in the dry atmosphere of a cool greenhouse. No one can possibly say how your plants should be treated without knowing more about them. Either the root-action is defective or the soil exhausted. If the pots are crowded with roots the latter is the case, and top-dressings of soot or bone meal, with abundance of water, will invigorate the plants. If the roots are few and unhealthy the soil is unsuitable, and the greater part of it should be removed, repotting in a compost of half turfy loam, the remaining half to consist of turfy peat and leaf soil in equal parts, with crushed charcoal and sand to keep the mass porous. The pots should be as small as possible, clean and well drained, and the plants should be assigned the warmest position in the house, and the base whereon they stand be always kept moist. Those that are not cut down entirely prune to healthy wood buds, keep the foliage perfectly free from dust and insects, syringing the plants two or three times a day in bright weather, and shading them from the direct rays of the sun. Very great care is requisite in watering, and the best of soil may be rendered useless by mistakes in this respect, as if it is kept too wet it turns sour and the roots decay, whereas if it is too dry they shrivel. Had you stated the size of the plants and pots, with the nature of the soil in which they are growing or dying, the information would have been useful to us in giving you a reply. If you like to send further particulars your letter shall have our best attention.

Verbenas (J. M. E.).—They can be grown very well in deeply worked and fertile soil provided the plants are clean and healthy when planted. We dip ours in a solution of soap-suds and tobacco water before planting them in the beds. No beds in the garden at Hampton Court last year were more effective than scarlet Verbenas with *Veronica Andersoni variegata* dotted thinly amongst them.

Names of Plants (G. R.).—The yellow flower is *Doronicum austriacum*. We cannot determine the other plant, a single leaf is insufficient for identification. (*Rev. A. K. C.*)—*Dendrobium Pierardi*. (*X. G. Y.*)—*Amelanchier Botryapium*. (*H. V. E.*)—1, *Magnolia yulan*; 2, *Sedum aizoidem variegatum*; 3, *Mesembryanthemum deltoideum*; 4, *A Mesembryanthemum*, but it cannot be identified without flowers. (*A. B.*)—1, *Acalypha musaica*; 2, *Rubus spectabilis*; 3, *Pernettya mucronata*; 4, *Saxifraga granulata*; 5, insufficient; 6, *Saxifraga Cymbalaria*. (*Stifford*)—1, *Eranthemum (Justicia) bicolor*; 2, *Pavonia Wioti*.

* * Replies to some other letters in hand will be published next week.

COVENT GARDEN MARKET.—MAY 16TH.

THE holidays have quite unsettled trade, and with the last few days' fine weather large supplies of house fruit have reached the market, meeting with few buyers.

VEGETABLES.

		s. d.	s. d.			s. d.	s. d.			
Artichokes.....	dozen	2	0 to 4	0	Mushrooms.....	punnet	1	0 to 1	6	
Asparagus, English	bundle	3	0	6	0	Mustard & Cress..	punnet	0	2	0
Asparagus, French	bundle	2	0	10	0	Onions.....	bushel	2	6	3
Beans, Kidney....	100	2	0	0	0	Parsley.....	doz. bunches	3	0	4
Beet, Red.....	dozen	1	0	2	0	Parsnips.....	dozen	1	0	2
Broccoli.....	bundle	0	9	1	6	Peas.....	quart	3	6	0
Cabbage.....	dozen	0	6	1	0	Potatoes, New....	lb.	0	4	0
Capiscum.....	100	1	6	2	0	Potatoes.....	cwt.	6	0	10
Carrots.....	bunch	0	4	0	0	Kidney.....	cwt.	6	0	10
Cauliflowers.....	dozen	2	0	3	0	Radishes....	doz. bunches	1	0	0
Celery.....	bundle	1	6	2	0	Rhubarb.....	bundle	0	4	0
Coleworts.....	doz. bunches	2	0	4	0	Salsafy.....	bundle	1	0	0
Cucumbers.....	each	0	4	0	8	Scorzoneria.....	bundle	1	6	0
Endive.....	dozen	1	0	2	0	Seakale.....	basket	1	0	2
Fennel.....	bunch	0	3	0	0	Shallots.....	lb.	0	3	0
Herbs.....	bunch	0	2	0	0	Spinach.....	bushel	5	0	6
Leeks.....	bunch	0	3	0	4	Tomatoes.....	lb.	1	6	2
Lettuces.....	dozen	1	3	2	0	Turnips.....	bunch	0	2	0

FRUIT.

	s. d.	s. d.		s. d.	s. d.
Apples.....	1/2 sieve	2 0 to 7 0	Grapes	lb. 4 0 to 8 0	
".....	per barrel	20 0 40 0	Lemons.....	case 10 0 20 0	
Apricots.....	doz.	0 0 0 0	Nectarines..	dozen 0 0 0 0	
Cherries.....	1/2 sieve	0 0 0 0	Oranges	100 6 0 10 0	
Chestnuts.....	bushel	10 0 12 0	Peaches	dozen 18 0 21 0	
Currants, Black..	1/2 sieve	0 0 0 0	Pears, kitchen ..	dozen 0 0 0 0	
" Red.....	1/2 sieve	0 0 0 0	dessert.....	dozen 0 0 0 0	
Figs.....	dozen	0 0 0 0	Pine Apples, English	lb. 1 6 2 0	
Filberts.....	lb.	0 0 0 0	Raspberries.....	lb. 0 0 0 0	
Cobs.....	100 lb.	0 0 0 0	Strawberries ...	lb. 4 0 6 0	
Gooseberries	1/2 sieve	0 0 0 0			



POULTRY AND PIGEON CHRONICLE.

PLOUGHING-IN OR FEEDING GREEN CROPS.

(Continued from page 395.)

AS we have given so much space to a description not only of the results of the system of ploughing-in green crops, as well as the system of consuming them on the land by sheep, and the results, we shall now lay before our readers a statement showing the mode of carrying out plans of close cropping upon soils in general, but particularly upon those hill farms which we have previously alluded to. This is based upon our own knowledge and observation as to their capabilities under varying circumstances, although the breeding flocks or sheep of any kind may be dispensed with, and rotations laid out for the purposes of fertilising the land almost wholly by the ploughing-in of green crops, as distinguished from the old custom of feeding them on the land by sheep. By acting upon the principle of growing all you can and selling all you grow, except those green and root crops which may be ploughed-in, and also excepting such portions of the crops which may be required for feeding farm horses, and when other animals are kept, also dairy cows, fattening bullocks, and swine, the exceptions being made in consequence of any water meadows or pastures which may be attached to the holdings, remembering at the same time that many farms among the hills have little or no pasture lands except poor downs.

To illustrate our ideas we will introduce a farm of 800 acres, similar to the one chosen to illustrate a sheep-breeding farm by Mr. E. P. Squarey before mentioned. These, especially in Wiltshire, are usually long and narrow; the house and chief buildings lying in the vale, the arable lands running in a long parallelogram over the hills, where they meet other farms, which extend to the next valley. This arrangement insures a fair distribution of the various qualities of soil. The lowest portions of the farm usually form irrigated meadows or pastures, and those fields lying immediately next to them comprise arable land of a superior character. The next division is lighter land, but good for Wheat, Barley, Sainfoin, and Clover. On the hills, however, we frequently find a thin soil, having been formerly down; but sometimes the hill land is the strongest on the farm, especially in the counties of Hants and Dorset. We will suppose the farm we intend to set out for cropping and details of management to contain—of home land, 100 acres; field arable, 450 acres; hill arable, either very light or rather strong land as the case may be, 200 acres; water meadows, 30 acres; dry pasture in the vale, 20 acres—total, 800 acres.

We will deal first with the home land, and set it out in a three-course rotation of (1) Wheat, (2) Lent Corn, (3) Pulse, or part root crops. This land, although the cropping may

be called severe, yet is in the vale and near the homestead, from whence yard dung can be laid out with little expense of cartage; therefore the pulse crops may be taken for sale or for consumption with the roots by horses, cattle, or pigs, near to where they are grown, and the land manured chiefly from the homestead for Wheat. In preparing the Wheat stubbles for Lent corn of the following year, as fast as the Wheat is cut and set up the land should be ploughed between the shocks or stooks, and sown daily broadcast with mixed Turnip and Cole seed (not dwarf Rape), and manured with 3 cwt. of bone superphosphate per acre only, because this will prove a beneficial manure as distinguished from the nitrogen, potash, and phosphoric acid supplied by the green and root crops ploughed in, or as soon as the Wheat crop is carted a portion may be scarified and drilled with the Giant or St. John's Day Rye, also manured with superphosphate, which, by the time for sowing Lent corn in March or April, will generally yield a satisfactory bulk for ploughing in; whilst the portion sown with Turnip and Cole seed will continue to grow in open weather until the seed time arrives for the Lent corn, and after the greens and seed stems are run up, a large bulk of green manure will in most seasons be ready for ploughing in. The best corn to be sown may be either Oats or Barley, whichever in practice may be found most suitable to the soil. In the third or last course, this division being fine productive land, one-third may be seeded with winter Beans and winter Vetches mixed, another third may be seeded with Trifolium, and followed by roots or Mustard for ploughing in, and the remainder may be autumn-tilled for early seeding with Mangold, to be carted off and stored for the cattle, &c., at the homestead, and the land all sown with Wheat and manured from the farmyard either before or after the sowing and harvesting of the pulse or root crops as may be most convenient.

The next division, called field arable, extends over 450 acres. We will take 100 acres of the highest land and lay into Sainfoin to be mown and sold for hay, and which will remain for many years in a productive state if drilled at 14 inches apart and kept clean by horse-hoeing, &c., because there will be no sheep to eat out the crowns of the plants, and thus oblige the ploughing-up and cropping the land as usual at the end of four years. In the present case the crop will be mowed annually for hay, with a dressing of nitrate of soda applied, if necessary, every spring. The remaining 350 acres will be farmed on a three-course rotation, the land not being intended to be manured with farmyard dung, or only partially so. The rotation to be—first, Wheat; second, Lent corn; third, Clovers, &c., after the Wheat, which will be prepared for in the third course, as hereafter mentioned. As soon as the Wheat crop is cleared off the stubbles should as soon as possible be steam-cultivated or scarified only, and the land seeded, one half with common Turnips and Cole seed mixed, the other half with Giant Rye, the whole to be manured with 3 cwt. of superphosphate per acre, as it is intended to produce crops for ploughing in as manure for the Lent corn, either of Oats or Barley as may be best suited to the soil. The last course will consist of Clovers, &c., to have been seeded for in the Lent corn, one half to consist of red Clover and Giant Sainfoin mixed, the other half to be the long-haulmed Dutch and Alsike Clovers mixed, which will be alternated at the end of three years, both crops to be mown for hay to be sold off the farm, the second crop of red Clover, &c., to be ploughed in and pressed at the time of coming into bloom as manure for Wheat. The second growth after the hay crop of Dutch Clover, &c., to remain and be ploughed in also if the growth is promising; if not, the land to be ploughed and seeded for Turnips or Mustard to be ploughed in for Wheat likewise.

We have now to deal with 200 acres called "Hill Arable," probably of mixed soil, and for the most part strong, with subsoil of chalk. This division will be cropped on a four-course rotation—Wheat, green crops, Lent corn, and Clover. The preparation for Lent corn will be commenced by seeding the Wheat stubbles with Trifolium immediately after harvest, or otherwise Mustard, to be sown in the spring, both of which will be ploughed in, with 3 cwt. of superphosphate applied, and the land seeded for common Turnips or Mustard, both to be ploughed in and the land sown early with Lent corn, Oats or drege preferred. The third course will be Clover, seeded for in the Lent corn, one-half of the lain to be Red Clover and Giant Sainfoin mixed, the other half to be Long-haulm Dutch and Alsike, all to be cut as hay for sale, the aftergrowth of both crops to be ploughed in for manure. In case of failure, however, of either portion it should be cropped with Mustard or common Turnips broken down and ploughed in early and pressed, thus giving the land time to settle and become stale and mellow, for on the hills it should be sown the first on the farm, and of the red hardy sorts, like Golden Drop or the Red

Lammas, and if sown or drilled after the presser so much the better, as the plant is liable on the hills to be lifted by frost in the spring if drilled or sown rather shallow as usual.

It will be noticed that we have arranged the cropping so that the 100 acres "home land," together with the produce of the 50 acres of water meadow and pasture, there will be enough grown thereon to keep the horses, some dairy cows, swine, &c., leaving the Wheat crop for sale. In fact, on other parts of the farm when the weight of roots exceed 17 tons per acre all above that weight may be removed for feeding extra dairy cows or fattening bullocks. After fully considering all the points of our subject we hold the opinion that more profit will be derived from the large acreage of corn, pulse, hay, and straw grown for sale without diminishing the fertility of the land in the future if the same style and rotation of cropping is continued, and that more money will be saved in labour and diminished investments for the purchase of live stock than can be secured by any known system of cropping and stocking or sheep farming hitherto attempted on the hill farms of any district. The land will be found cleaner in consequence of so many opportunities being afforded for the forking out of couch grass and weeds by hand labour, instead of attempting to destroy them by tillage and costly horse labour, which can only be done effectually in fine weather. In conclusion we may state that the rotations of cropping set forth, some or other of them are well adapted for nearly all the best as well as the poorest land under tillage to be found in England. We therefore ask the home farmers and others engaged in the management of landed property to carefully think over all the points of our subject, and by experiments to satisfy themselves of their monetary value.

WORK ON THE HOME FARM.

Horse Labour.—Lent corn has been seeded in fine condition almost everywhere as regards the cultivation of the land, except in those cases where the sheep in the winter had trodden the soil into mud. This difficulty has, however, been overcome after expending extra tillage on the land, and in some cases has delayed the seedtime, because where the land worked unkindly it was necessary to wait for the dry frosts and rains which followed to ameliorate the surface; but in most districts and counties the seedtime has been delayed by the large amount of Swedes in hand for feeding sheep. This has, however, enabled large flock-masters to tide over the period of scarcity for grass, although it has somewhat delayed the seedtime. This is now a good time to sow Mangold seed; for although it is better when the seed can be put in during the month of April, still it is only necessary to leave the plants rather closer in the lines at hoeing time, and give a liberal dressing of nitrate of soda at the first horse-hoeing. Carrot seed, too, may now be sown with benefit, for when the seed is properly freed from the burr and drilled with 2 or 3 cwt. of bone superphosphate with ashes at any time up to May 20th. If the land is moist enough to vegetate the seed at once they will answer well, because the young plants will start fair with the weeds, and less hoeing will be required than when sown as usual in the month of March. It is, however, a good plan to drill the seed on the stretch at the interval of 18 inches, because the horse-hoeing will save much expense in hand-hoeing as compared with drilling on the flat. In the early districts of the north and north midland, as well as in Scotland, Swedes should now be seeded, for the yard or box manure having been buried in the stretch for it saves much hand-hoeing, and superphosphate applied by the drill will force on a crop of good quality, but in the event of ammoniacal manures such as guano or nitrate of soda being applied we have seen fine crops decay in consequence in the autumn, but yard manure and superphosphate will produce a full crop of sound and valuable roots for fattening cattle. It is just the same with early hybrid or common Turnips, except when sown after the middle of July or as stubble Turnips, ammoniacal manures will then force the growth without injuring the feeding value of the crop. Hay will soon be an object worth our attention, and we think the late rains have been favourable for the growth of Clovers, grasses, and Sainfoin, &c., and in order to be prepared for securing our grasses as winter fodder we should be prepared according to our requirements for the production of ensilage; but hay for sale, must be treated as hay. The farmers should avail themselves of all the advantages of securing hay by Messrs. Neilson & Knowles' system of hay-cooling with the use of the exhausting-of-heat fan, and build the ricks accordingly.

Hand Labour.—The season for Oak felling and stripping has not been very favourable, for the cold nights made the bark separate from the trees with difficulty, and also just as the bark was getting dry enough for storing the weather has changed to showery. The cutting of grass on the field borders and banks is being done daily, and it affords a good lot of coarse grass, Cow Parsley, Hogweeds, and other succulent produce, such as the young shoots of hedgewood, which when used as fast as cut daily is good for the feeding of young stock and milch cows in a milk-selling dairy, but not for butter-making.

Live Stock.—Mares with foals at first require careful attention. We do not like the foal to follow the mare in her work in the field, which she may be expected to take her part in when the foal is about

a fortnight old, for irrespective of accidents it is important both for the mare and foal that they should not be separated from each other for more than five hours at one time, and if there is more than one foal they do best in company in the boxes while the mare is away at work. We fear that horse-breeding for some years past has not benefited the farmer as it might have been expected to do under more favourable circumstances, as a good colt well descended of any breed, either for farm work, hunting, or harness work, will fetch double the price of animals bred anyhow, and the latter is too much the fashion, owing to the difficulty of obtaining in various districts entire horses of a good stamp and breed from sound parents; this, together with the careless way in which the mares for breeding purposes are selected, has brought the business of horse-breeding and rearing into disrepute. There is, however, great complaint made of large numbers both of mares and stallions, especially of the best bred harness and hunting horses, being sold to go abroad. In most cases where bullocks are being fed in their stalls or boxes a good store of Mangolds is left for them, and all the young and growing animals of two years old and under will pay better for feeding than cattle of any other age. There is, however, one leading point to be considered as the groundwork or basis of profit in feeding young stock for the butcher, that they should be fat as calves when weaned, and never be allowed through neglect to lower their flesh, and this point must be kept steadily in view. Another point is, that they should never be off the straw or exposed to the changes of weather, for when reared entirely under cover until they go away for slaughter, the food consumed will have yielded its full value if selected of the best quality, quantity, and regularity of feeding. Dairy cows may from this time be allowed to lie out at night on dry sheltered pasture at first, but we recommend that during the whole milking period of summer and autumn, although they may have good pasture, yet at milking time, night and morning, they should have a bait of green food, such as Trifolium, Clover, and Vetches, or otherwise cotton cake, several pounds each per day; for this system of rack-feeding, however partial, will not only increase the flow of milk all summer, but also extend the milking period until calving time again arrives, at least this should be the object.

BATH AND WEST OF ENGLAND SOCIETY AND SOUTHERN COUNTIES ASSOCIATION.—The visit of the Bath and West of England Society and Southern Counties Association to Bridgwater will be the first that the Society has paid to that town, although situated in the very heart of the county of Somerset, where the Society originated, but wherein no exhibition has taken place since the Centenary Celebration at Bath in 1877. The Show, for which extensive preparations have been for some time in progress, will open on Monday, May 28th, and close on the following Friday. In the live stock department the entries amount to 744, a number very rarely reached by the Society. In the poultry classes there are nearly 500 entries.

OUR LETTER BOX.

Cows (R. W.).—The custom to which you refer is a local one, and custom often becomes as powerful as law. The practice is common in some districts, but in others, and perhaps the majority, is not known.

METEOROLOGICAL OBSERVATIONS.

CAMDEN SQUARE, LONDON.

Lat. 51° 32' 40" N.; Long. 0° 8' 0" W.; Altitude, 111 feet.

DATE.	9 A.M.				IN THE DAY.				Rain	
	Barometer at 32a and Sea Level	Hygrometer.		Direction of Wind.	Temp. of Soil at 1 foot.	Shade Temperature.		Radiation Temperature.		
		Dry.	Wet.			Max.	Min.	In sun.		On grass.
1883.										
May.										
	Inches.	deg.	deg.		deg.	deg.	deg.	deg.	deg.	In.
Sun. 6	29.869	50.4	45.2	N.	47.3	70.7	42.9	112.4	38.3	—
Mon. 7	29.706	49.0	47.4	N.E.	49.3	58.3	42.3	91.7	39.6	0.140
Tues. 8	29.601	48.4	46.0	N.E.	48.5	57.2	41.9	70.5	33.3	0.350
Wed. 9	29.532	46.1	45.3	N.	47.9	48.7	43.3	58.0	42.5	0.255
Thurs. 10	29.612	48.7	38.0	N.N.W.	46.8	48.4	37.2	73.8	38.4	0.020
Friday 11	29.902	47.4	42.9	W.	41.1	53.3	35.2	100.0	31.3	0.604
Satnr. 12	29.833	51.7	50.7	S.W.	45.9	57.3	38.6	62.3	32.3	0.072
	29.722	47.4	45.1		47.4	56.3	40.2	81.3	35.5	1.441

REMARKS.

6th.—Fine, bright, and warm.
 7th.—Rain in morning, fine afternoon and evening.
 8th.—Dull, cold, and rainy.
 9th.—Dull and cold, slight showers.
 10th.—Dull and cold, rain in forenoon.
 11th.—Bright early, afterwards dull and showery; soft hail at 5.30 P.M., some of it measuring between five and six-tenths of an inch in diameter; thunder at 5.33 and 5.37 P.M.
 12th.—Heavy rain in morning; dull overcast day; high wind in evening.
 Weather very variable; the maximum temperature on Sunday 6th exceeded 70° for the first time in this year, but on Wednesday and Thursday the temperature did not reach 50°, and fell nearly to freezing point; in fact, there was frost on the grass on the morning of the 11th.—G. J. SYMONS.



24th	TH	Royal Society at 4.30 P.M.
25th	F	Quekett Club at 8 P.M.
26th	S	Royal Botanic Society at 3.45 P.M.
27th	SUN	1ST SUNDAY AFTER TRINITY.
28th	M	
29th	TU	Brighton Aquarium Spring Show (two days).
30th	W	Society of Arts at 8 P.M.

SCIENCE IN CULTIVATION.

AMONG the numerous remedial measures to which the "seven lean years" have given rise, as partial or entire specifics for the evils of hard times, none commends itself more forcibly to us than that which enforces a thorough knowledge of the nature and treatment of the soil, the composition of the plants we cultivate, the sources whence the ingredients of such composition are derived, the deficiency of our own particular soil for the requirements of any crop, and the remedy.

Quite recently Professor Jamieson expressed his conviction at a public meeting that three-fourths of cultivators were ignorant of these things, and it is the aim of the Sussex Association for the Improvement of Agriculture by science to enlighten; and it has proved to demonstration that as soil differs greatly even upon the same formation, so must its treatment differ according to its requirements in order to cultivate it profitably. It has done much more than this, for it has shown that land declared to be so poor that a decided loss attended its culture under the old hit-or-miss system, could by careful scientific treatment not only be made to pay all expenses but to yield a fair profit, or, to put it more forcibly, that profitable cultivation is possible on the poorest and foulest land, and that unprofitable cultivation is the fault of the cultivator and not of the land. In selecting land for trial poor land was taken in preference to rich, in order that the work might be thorough and its result really useful. Careful and full diaries have been kept of the work done at each station in different parts of the county, and they are printed fully in the annual report, together with clear statements of every detail of the crops, soil, and manure.

Nitrogen and phosphorus are found to be two great wants in Sussex soils. In supplying these wants artificially the effect of phosphates proved to be more lasting than was supposed, beneficial effects being clearly visible the second year. Important as this fact is generally, it is doubtless so to members of the Association, who, under the advice of Professor Jamieson, and by the light of his teaching, have applied to the land 3 cwt. of finely ground coprolites and 3 cwt. of steamed bone flour per acre. This dressing is a heavy one, recommended for a poor soil at the outset, and will be reduced subsequently to about 2 cwt. of each sort of manure. The action of coprolites alone, even when reduced to dust, is not sufficiently quick; mixed with the bone flour it answers admirably.

Steamed bone flour contains 55 to 70 per cent. of phosphate, and is therefore superior to natural bone, which contains only 50 to 55 per cent. of phosphate, and cannot be ground so finely as the steamed bone. This is worth remembering.

It may be fairly asked, Of what use are the Sussex experiments to cultivators in other parts of the country? And as fairly and usefully it may be answered that the results obtained are in many instances so clear and unmistakeable, and of such great practical value, that not only are they of general importance as an incentive to the formation of other county associations, but also to persons individually, as showing them that such knowledge well applied is profitable. It also shows them how to help themselves in a comparatively inexpensive manner by ascertaining the deficiencies of their soil and supplying them, and it is hoped the lesson indicated will not be lost or overlooked by cultivators generally.

Having learnt that the essential elements of plants are potash, nitrogen, lime, magnesia, sulphur, iron, and phosphorus, every cultivator in the garden and on the farm can follow the advice given by Professor Jamieson—namely, "Procure a small quantity of each kind of manure and apply it thus: To one patch of land no manure whatever; to another patch of land all the essential elements; and to six others all the essential elements excepting one, and that excepted one being a different element in each case." Properly there ought to be seven such partially manured plots, but of the seven essential elements iron is required only in traces, and soils always contain more than enough. This is what he calls making the soil analyse itself. It clearly does so sufficiently well for all practical purposes, and two or three years' careful trials, or even those of a single favourable season, give a certainty of aim and purpose to our work such as nothing else can do.

Although great prominence has been given to the relative value of manures, yet no essential detail of culture has been overlooked. The trial land was well drained first of all, and then thoroughly worked to get a good seed bed. This primary drainage is of at least equal importance with the correct application of manure, for without it our efforts will prove comparatively futile. Last summer I saw a large field of Wheat stunted in growth and of that sickly yellow hue which shows unmistakeably that "something is wrong below." What was it? no manure? No, that could not be the cause, for an exceptionally heavy dressing of forty-five cartloads of farmyard manure per acre had been given it. How were the drains acting? The land, a close tenacious soil, was undrained! Cold, sodden, inert, how could the Wheat grow in it? It did grow, but how slow and feeble was that growth in comparison to what it might have been had the land been drained. Let not the teaching of this experience be overlooked. It is of importance to gardeners as well as farmers. Land must be drained or it cannot be fertile. Far better to incur the loss of a little nitrogen by overdrainage, even though it were double the quantity shown by the Rothamsted experiments, than to have none at all. The land referred to forms part of a large estate, and is in the hands of a cultivator who is perfectly alive to the importance of drains, but he cannot get them. It is, however, reasonable to suppose, that as the primary importance of drainage becomes fully

recognised it will receive due and just attention as a necessary prelude to the economical application of manures in gardens, orchards, fields, and parks.—
EDWARD LUCKHURST.

IVY ON HOUSES.

THE advice given on the above subject by your esteemed correspondent Mr. R. Inglis is without doubt sound. The Ivy is a favourite plant here, and we have many varieties occupying various positions. We are sometimes asked this question, "Does Ivy on house walls cause them to be damp or not?" The answer is, All depends upon the management of it. If Ivy be allowed to have its own way on the wall of a house it will in course of time find its way into the guttering, choking it, and sending the water from the roof down the wall behind the Ivy, the foliage of which excluding sun and air, the wall can hardly be otherwise than damp. But the blame is not due to the Ivy. If properly looked after as advised by Mr. Inglis, and kept strictly below the guttering, coping, or eaves (the guttering being in good order), it will not only not make walls damp, but will act oppositely by drawing out any moisture there may be in, and materially preventing the rain from reaching the walls.

Mr. Inglis's remarks on cutting the Ivy reminded me of a circumstance which may perhaps be worth mentioning. About three years ago some workmen in making an addition to our cottage, the wall of which is covered with Ivy, completely severed two of the Ivy stems, each about the size of a man's finger. Instead of the growths above the cuts dying as I expected, they remained green and growing, being sustained only apparently by the rootlets adhering to the wall. This recalled to my mind a similar instance of an old plant, one of several covering an old barn in Oxfordshire more than twenty years ago, having its stems as thick as my wrist chopped through at about a foot from the ground, yet the plant grew pretty much as before. Putting together these two facts I began to imagine that an Ivy when well established on a wall could do as well without its ground roots as with them. How easy it is to be mistaken. Later on, during some repairs to a water pipe, another Ivy stem was cut through, and the growth above, though just as firmly attached to the wall as the others, soon withered and died. This led me to make a closer examination of the two stems first mentioned, and I soon found out all about it. The two cut stems were crossed above the cuts by two others, to which previous to the cutting they had become united—in fact had grown to them as though grafted by inarching; so when the original supplies were cut off, they evidently at once commenced to draw from the source opened to them by their "new connection." And doubtless if I had the opportunity of examining now the old plants on the barn I should find a similar state of affairs.

The Ivy is such an excellent plant in every respect, hardy, ornamental, easy to manage, not particular as to soil or situation, that it may truly be called everybody's plant; and though its varieties are now so numerous, from the Giant variety of *Hedera algeriensis* with leaves nearly a foot wide to *H. glomerata*, the little crumpled leaves of which measure less than 1 inch, there is not one can be called bad.

Large and small-leaved varieties should not be planted very near together. A much better effect is produced by keeping them separate.—GEORGE DUFFIELD, *Winchmore Hill*.

[That this is sound advice the diagrams of leaves sent testify conclusively, for one was 11 inches in diameter, and the other only seven-eighths of an inch.]

DUKE OF BUCCLEUCH GRAPE—FOOTSTALKS DECAYING.

YOUR correspondent's experience with this grand Grape is not alone, as last year several of my bunches decayed at the stalk, as is indicated on page 416. With such experience perhaps it may be considered that I was somewhat inconsistent in recommending the Duke under certain conditions during the winter recess as the only white Grape that I would grow;

and, now upon seeing that it is desirable to allude to it, I shall dwell a little more on my troubles and triumphs.

It will be six years this summer since, with a few others for inarching, I obtained a Vine of the Duke, but as it was not in a free state of growth I let it stand till the following season in the pot, though it made little progress. The next season whilst planting a second house I gave this Vine a good position, but it still refused to grow satisfactorily, until the thought struck me that it might be of advantage to plant by its side a free grower, and then to inarch the two. Having by me some Waltham Cross I planted one each by the side of the Duke and by the side of a Buckland Sweetwater, and getting them united I was glad to see that success followed—the Duke breaking into vigorous growth shortly afterwards. The next season, by an accident, the union was broken in the case of the Duke, but its vigour continued, whilst the Buckland still has the two sets of roots and is doing equally well. With both I had fruit; but two years ago my Dukes were so spotless and so very fine that the Grape became a great favourite with me, and such results, were they even much more difficult to achieve, are ample recompense for the care bestowed in culture.

Last year the Vine was still more vigorous, and the bunches were of a size sufficient to attract the attention of a near neighbour, quite an equal lover of Mr. Thomson's Grape; but as my pleasures were checked troubles began. The bunches one after the other were dying, and the cause undoubtedly was the same as is again noticed. The stalks were gangrened, they commencing at one side to turn soft and pulpy; speedily the whole stalk decayed, and the bunches fell off. Having some Amies' manure standing near I thought it possible that it might contain some chemical compound that might be beneficial in this dilemma, so I rubbed it well into the affected parts of the bunches that were left. Whether it was that the disease was already exhausted I know not; but certain it was that the decay went no further, and I have not seen it since, nor do I expect to see it now, as I think the Vine is past the stage it was last year when attacked. But with the disease stayed my troubles were far from being ended, as the bunches left were too light a crop for the Vine. They also contained many stoncess berries, and which still subjected the perfect berries there was in each bunch the more to crack.

Some of your readers will possibly remember that I attribute more of the failures connected with Grape-growing to unripe wood than is generally attributed. This decaying of the berry stalks of the Duke I attribute to the wood being immatured the previous season; and I am the more convinced of it now, the disease being unknown to Mr. Thomson, immatured wood, as we have further confirmed by his "miles of piping," having no part in this gentleman's highly intelligent practice.

My contention is, in proportion to vigour of growth we must have heat to ripen such growth, or failing in this the luxuriance we so much admire will end as too frequently does the healthy strong person who lives an indolent misspent life. My Duke of Buccleuch, by treating in the same plain, and, I trust, common-sense way in which I now treat all my Vines, had got into a state of growth quite out of proportion to my ripening appliances, and the Vine, like children of sickly parentage, was subject to a disease not previously recorded. To my having had "nothing to unlearn" probably is the more due my differing from several in their practice with the Vine, and I have hopes that the more gardeners practise thinking the more the future will bear me out that much that hitherto has been taught are fallacies and not sound practice. Many gardeners err in going "the whole hog" with their hobbies, never deigning to think that too much is poison, and, if not death, certainly disease to their Vines.

My bunches of the Duke, with berries the size of common white peas, I see are 10 inches in length from the shoulder, which undoubtedly is quite the average; and though I have more a dread of large foliage than a love for it, I enclose you a leaf of this year's Gros Colman, one of a number of Vines that have carried crops that scores of gardeners have predicted time after time they would never finish. But still again they "come to time" with the aid of my "little feeds and often." They justify the labour of the "forty watering

pans," and of water applied in limited quantities, yet sufficient; and, what is quite as important, preventing manure being washed into the drains.—JOSEPH WITHERSPOON, *Red Rose Vineries, Chester-le-Street.*

[The leaf is very fine, and quite large enough, 13 by 13 inches, its merits consisting in its stout leathery texture and rich dark green colour. We are obliged by this timely communication relative to the Duke. If Mr. Thomson did not have the wood of his Vines matured he would not obtain such wonderful crops.]

STRIKING ROSE CUTTINGS.

In giving my experience on propagating Roses and growing the plants afterwards I will endeavour to make the process as plain as possible, though it must not be supposed that good Roses can be grown without good attention any more than any other plants can; and, in my opinion, one well-grown plant, no matter what it may be, is better and gives more pleasure than miserable-looking objects that remind one of starvation.

In the first place I have sufficient labels ready and painted, and my knife whetted to a keen edge; then I make a solid bottom of coal ashes on the north side of a wall on which to place the soil. This consists of two parts loam to one of leaf soil, with a good sprinkling of sharp river or silver sand sufficient to make it porous, or where good loam is scarce the soil from old spent Cucumber or Melon frames will answer the purpose, with the addition of sands. The soil, neither too wet or too dry, is placed about 6 inches thick on the prepared site and made somewhat firm, and on this I stand as many bottoms of handlights as are required, or boxes without any bottoms, not less than 9 inches or 1 foot in height. These may be any length or width provided glass is available of the right size to cover them. I next spread 2 or 3 inches more soil inside the handlights or boxes, make it firm, surface with half an inch of sand, damp it through the rose of a water pot, and all is ready for the insertion of the cuttings.

From the middle of September to the end of October is suitable for inserting Rose cuttings provided the wood is firm. Moderately strong short-jointed shoots are selected, and each variety secured with a label in a bundle, not taking too many at one time, as it is important that this be quite fresh and placed in the soil as soon as possible. I cut them just below a bud and pick out the two bottom buds, leaving three or four on each cutting, two of which should be above the surface when the cuttings are inserted. Where a scarcity of cuttings exists shorter portions may be used. It used to be considered necessary that each cutting should be taken with a heel, but practice has taught that they strike just as well without. I have sometimes, when the foliage is very large, taken off the top portion the same as is done in budding; this allows the cuttings to be inserted more closely, but 3 inches apart each way is not too much if space can be spared. They are dibbled in and the soil is made firm around them. As soon as one handlight is finished dry sand is freely sprinkled among the cuttings, sufficient water given to settle the sand and soil, and the top of the handlight placed on. This should fit close and well, or if boxes are used place the glass on, on a bed of putty, and paste strips of paper over the joints if the glass is not cut quite true. I have found the less air they have the better they strike. I ought to say I learnt a valuable lesson from the pen of Mr. Wm. Taylor on this point. When all is finished they may be left to take care of themselves till growth has commenced, when most of the old foliage will turn yellow and fall off. This should be removed, the soil pointed up, then admit a little air by degrees till growth is sufficiently advanced to allow of full exposure on fine days.

I like to have the plants well rooted before lifting, otherwise when they are potted a weak growth is made and several go off. Were I growing a large quantity and could spare the frame I would make up a gentle hotbed, and plunge pots of cuttings when the heat had subsided to 65° or 70°. Few, indeed, would then fail to emit roots, after which more air would be given, and the pots finally removed to a cooler structure.

In my present position they are placed in small 60-size pots and stood in Potato pits or where room can be spared till established, then shifted into 48's, gradually hardened off, and potted again when necessary. The end of February or beginning of March is a good time to pot them, or when space can be spared for them, and they are sufficiently rooted. There should be no check from the time the cuttings are lifted till the first season's growth is completed. In this lies the secret of success. I have now some plants of Safrano from cuttings last September with plump flower buds; these I shall remove. I do not like inserting the cuttings too early, so as to start into growth at once, but am quite content for them to remain fresh

and plump up their buds; they then start strongly and go on without a check.

Those plants intended for pot culture I keep in pots, those for planting are thoroughly hardened off before being planted out. The end of May is soon enough for this, and I like to plant them out of 48-size pots. The young growths should be secured to sticks to prevent their being broken by the wind, and water must be given as necessary in dry weather. Subjoined is a list of those sorts I have tried and found to do well from cuttings:—Capitaine Christy, Docteur Andry, Général Jacqueminot, John Hopper, La France, Mademoiselle Annie Wood, Royal Standard, Sénateur Vaisse, Thomas Mills, Duke of Edinburgh, Paul Neyron, Triomphe de Rennes, Bouquet d'Or, Celine Forestier, Devoniensis, Gloire de Dijon, Maréchal Niel, and Safrano. Some other varieties I have on trial this year.

When garden boy I recollect the gardener inserted a quantity of Rose cuttings in an open border, and to assist them to root split each cutting and placed an oat corn in the slit at the base of the cutting. Well do I remember it was said, when the oat grows the cutting would do likewise, but it was a failure. I took my first lesson on striking them in handlights from seeing it carried out successfully in the Sion Nursery near Croydon. Very short cuttings were used, and the tops of handlights only. When I became head gardener I carried out the practice, and if others profit from my experience I am content.

I think it a great boon for gardeners to raise some Roses from cuttings annually, for it is not all employers who will purchase a few though they like to see them. If we raise a number we can remove the old when they become unsightly and plant young, and so maintain a vigorous stock.—A. J. SANDERS, *Bookham Lodge, Cobham.*

READING SHOW.

MAY 17TH.

THE first Show of the present year held by the above Society proved far more fortunate than the last in the preceding year, and the remarkably beautiful weather which prevailed on Thursday last tempted so many visitors to attend the Show, that doubtless the receipts would assist materially in restoring the Society to its usual prosperous condition. In extent the Show has been excelled by several in other years, but the general good quality amply compensated for the little deficiency in point of numbers. The arrangement, too, was so well conducted that, viewed generally, there was no appearance of thinness, and it is a matter of opinion if a show tent is not more pleasing moderately well filled, so that all the exhibits are seen to the best advantage, than when it is crowded so densely that the individual beauty of many fine plants is lost. The bank at the end of the marquee, where the large Fuchsias are usually staged, was this time occupied with groups of plants which, containing abundance of bright colours agreeably softened with graceful Palms and Ferns, formed a most satisfactory background.

The Exhibition was held in the Abbey Ruins; and the adjoining Forbury Garden, which is again under the charge of Mr. Phippen, was in its most attractive guise, spring flowers constituting an additional charm, the beds of Myosotis edged with double Daisies being especially pleasing.

STOVE AND GREENHOUSE PLANTS.—The principal class for these was for nine specimens, and in that three good collections were entered. The premier position was assigned to Mr. Tudgey, Waltham Cross, who thus commenced to retrieve the honour he lost at Bath and Regent's Park. His plants included good examples of Clerodendron Balfourianum, Hedera tulipera, Anthurium Schertzerianum, Erica ventricosa coccinea minor, and Aphelexis macrantha purpurea. Mr. Bennett, gardener to M. Lonergan, Esq., Cressingham, obtained the second position with very fresh, healthy, well-grown plants, comprising a most creditable example of the beautiful Acrophyllum venosum 4 feet in diameter, Aphelexis macrantha atropurpurea, Azalea Stella, 8 feet high, well flowered, Erica Cavendishiana, and E. Paxtonii, also good. Mr. Mould, Pewsey, followed with smaller plants, the most notable being Pimelea Niepperiana, profusely flowered. For six specimens, Mr. Mortimer, gardener to Major Storer, Purley Park, gained the chief prize with neat samples of Plumbago capensis, Rhynchospermum, Bougainvillea glabra, Clerodendron Balfourianum, and Medinilla magnifica. Mr. Tudgey had the best single specimen, an Anthurium Schertzerianum majus, with twenty-four large richly coloured spathes. Messrs. Tudgey and Mould were the prizetakers with six Ericas, both staging well-grown plants.

Azaleas were not very numerous, but Mr. Bennett's premier collection of six included some admirable specimens—Charmer, 8 feet high and 5 feet in diameter, being profusely flowered; Flag of Truce, Etoile de Gand, and Stella were also notable. Mr. Tudgey followed, but several of his plants were decidedly weak.

Pelargoniums were fairly represented, most of the leading collections containing very satisfactory plants. The Show varieties were in two classes—for nine, in which Messrs. Ashby, gardener to W. Fanning, Esq.; Burgess, gardener to Colonel Clayton, Maidenhead;

and Mayne gardener to Miss Moon, were the prizetakers with good plants, the flowers mostly large and richly coloured. The other was for four plants, and in this Mr. Sumner, gardener to Mr. Millard, Reading, took the lead with healthy well-flowered specimens. Mr. Burgess had the best collection of Fancy varieties, and a better half dozen neat profusely flowered plants are rarely seen. The chief varieties were Princess Teck, Madame Sainton-Dolby, Sylph, Fanny Gair, and Nelly Fordham. The principal prizetakers for Fuchsias were Messrs. Sumner, Mortimer, and Mayne, but the exhibits were not generally so good as we have seen them at previous shows in Reading.

Gloxinias were good, but one collection, that from Mr. Farey, gardener to C. Stephens, Esq., Woodley Hill, was more than good—it was superb, and six better plants we have never seen staged. They were two years old, in 24-size pots, and some had from four to five dozen flowers each, richly and delicately coloured, of Messrs. Sutton & Sons' strain. Gloxinias are beautiful plants when well grown, but it is seldom that they are seen at exhibitions in their best condition. Mr. Baskett, gardener to W. J. Palmer, Esq., Reading, and Mr. Mortimer followed also with good plants, though they suffered by comparison with the first lot. Messrs. Baskett, Bennett, Mortimer, and Farey were also the prizetakers for Calceolarias, all contributing good plants.

ORCHIDS.—These do not constitute a great feature at Reading, but several creditable collections of three specimens were entered. Mr. Mortimer gained first honours with *Vanda teres*, having two spikes of its large richly coloured flowers; *Dendrobium densiflorum*, with ten spikes; and *D. thyrsoflorum* with eight spikes. Mr. Pound, gardener to G. May, Esq., Caversham, was second with *Cattleya Regneriana*, *Dendrobium thyrsoflorum*, four spikes, and *Dendrobium Bensonæ*, having three growths covered with flowers—a most attractive little specimen. Mr. Baskett took the third position with *Cypripedium barbatum*, *Dendrobium Devonianum*, and *Oncidium sphacelatum*. Mr. Pound had the best single specimen, *Vanda suavis*, in good condition; and an extra prize was awarded to Mr. Farey for a well-flowered plant of *Dendrobium nobile*.

FINE-FOLIAGE PLANTS.—For six specimens Mr. Mortimer secured the first honours, defeating the renowned champion, Mr. Tudgey, who was placed second. The first comprised good examples of *Alocasia metallica*, *Encephalartos villosus*, *Pandanus Veitchii*, *Alocasia macrorhiza variegata*, and *Croton majesticus*, all in the freshest possible health. Mr. Tudgey's plants were larger, but included too many Palms. Mr. Mould was third. The best four plants were from Mr. Baskett, *Phyllanthus roseo-pictus* and *Croton undulatus* being his chief specimens, Mr. Burgess following with *Dracæna Youngi* and *Hibiscus Cooperi*, fairly good.

Ferns are generally represented by several handsome collections, and this occasion was no exception to the rule. Mr. Mortimer won first honours with six most satisfactory, fresh, bright, and vigorous plants of *Phlebodium sporodocarpum*, *Adiantum concinnum latum*, *Dicksonia antarctica*, *Davallia bullata*, and *Adiantum cardiochæna*. The second prize was withheld, Mr. Phippen, Reading, gaining the third for fairly good plants, *Platynerium alaicorne* and *Adiantum farleyense* being the best. In the class for four Mr. Bennett took the lead, having *Davallia bullata*, *Adiantum cuneatum*, and *A. formosum* in fine condition. Mr. Baskett followed closely with the very distinct *Lomaria magellanica*, *Adiantum gracillimum* good, and *A. farleyense*.

GROUPS.—In the class for a group arranged for effect in a space 12 feet by 10 feet Mr. Bennett gained the chief prize with a very bright and tasteful group containing abundance of such flowering plants as Azaleas, Calceolarias, Cinerarias, Ericas, and Gloxinias, with Palms, Ferns, Dracænas, and Crotons. Mr. Pond was second with a choice group, *Dendrobium nobile* being freely employed; and Mr. Phippen was third, his group being rather dull owing to the preponderance of foliage plants. The smaller groups 6 feet by 4 feet were also pretty, especially that with which Mr. Millard won the leading position. It was not only tastefully arranged, but contained some well-grown plants of Begonias, Gardenias, Calceolarias, Pelargoniums, and others. Messrs. Burgess and Balchin, gardener to B. Simonds, Esq., Reading, were second and third respectively, each contributing well.

Cut flowers were of good quality, the chief prizetakers being Messrs. Ross, gardener to C. Eyre, Esq., Welford Park; Bennett, Phippen, and Lawrence, gardener to Mrs. Owen Knox, Caversham. For vases, bouquets, and buttonholes Mr. Phippen was the most successful competitor.

Fruit was not extensively shown. Mr. Ashby had the best white and black Grapes; the former Foster's Seedling, good bunches but green, the latter Black Hamburg well coloured. Mr. Moore, gardener to J. Hay, Esq., Bray Court, followed in the white class; and Mr. Howe, gardener to Sir R. Sutton, Benham Park, in the black class, both showing good bunches. Mr. Mortimer had a dish of handsome President Strawberries, even and richly coloured, being followed by Mr. Howe with Sir Joseph Paxton, also good. Mr. Ashby had the only dish of six Peaches, Early Ascot of good colour.

Vegetables were also only moderately represented, though the quality was good. For a collection Messrs. Read and Balchin won the first and second prizes, each showing clean fresh samples. The Beans, Peas, Potatoes, Asparagus, Mushrooms, Cauliflowers, and Rhubarb classes all found several competitors. For Messrs. Suttons & Sons' prizes for a brace of Cucumbers there were thirteen

entries, Mr. Mortimer taking the first prize with a seedling from Model, very neat in shape, of moderate length, and taking a good bloom. The Judges awarded a first-class certificate for it, and named it *Purley Park Hero*. Mr. Mortimer was also third with Model, Mr. Elliott being second with the same variety; Mr. Armitage, gardener to W. Clark, Esq., Reading, being fourth with Telegraph, and Mr. Farey fifth with Suttons' Improved Telegraph.

Mr. C. Turner of Slough contributed a beautiful group of Azaleas, Roses, and Alpine Auriculas, not for competition, which formed a handsome bank at one end of the marquee, facing the groups. The following plants were certificated, and have been previously described: Azalea Phœbus, Alpine Auriculas Roysterer, A. Lloyd, W. Coomber, Resplendens, Reginald Turner, R. Gorton, Mrs. Coomber, Vivacity, Portia, and Mrs. Craven. A certificate was also awarded to Mr. B. Porter for a white bedding *Viola, Queen of Whites*, very free, compact, and pure in colour.

TOMATOES.

WHILE quite agreeing with Mr. Luckhurst about Tomatoes at page 378 that the culture of this now very popular vegetable is very much reduced to one of ways and means on account of its yielding fruit under almost any condition, I at the same time am convinced that it pays to devote a structure to its culture alone. The amount netted from a small pit last year in a Fifeshire garden, according to the account I have heard, could have been secured by no other crop. One reason for this was that the fruit was far superior to all others in the market. I had the opportunity of seeing them on a few occasions, and certainly never saw such a crop of fine Tomatoes before. One result in our case is that an endeavour has been made to grow them in a structure by themselves, and we have now a pitful setting their earliest fruit. At the same time the makeshift principle has not been entirely done away with, as will be seen when it is stated that our earliest spring-planted crop is ripening from plants growing against the back wall of a propagating pit. These were raised from cuttings taken off winter-fruiters in January. Another batch is coming on at the back of an early vinery. Last year I had a splendid crop from plants grown on the border of a new Peach house. These were grown with single stems and staked. I thought the system of cultivation was somewhat singular until a nurseryman said to me one day, "That's the way Mr. Ladds of Bexley Heath grows his Tomatoes under his Grape Vines." I find it the best system to plant in pure loam and enrich it afterwards with surface-dressings. Rich soil only induces an overluxuriant growth and a consequent tendency in the flowers to fail in setting. Provided they receive plenty of moisture, a high temperature such as that of a propagating pit does them no injury, in fact they seem to enjoy it.—B.

WALLFLOWER CRANFORD BEAUTY.

PERMIT me to forward for your acceptance sample blooms of my new single yellow Wallflower, which I raised from Graham's Perfection in 1881, and exhibited at the Royal Horticultural Society this spring. It is very early, hardy, and comes remarkably true to strain. It is a grand and wonderful sight to see as growing here. Hundreds of persons have been to see it, and it is the attraction and admiration of the neighbourhood. I have an acre of it, and am truly pleased to show anyone over and give a few blooms to take away. It has been in full flower out of doors since February, and we cut a number of blooms before Christmas last. The bloom is not quite so fine as it has been, but it will last another month at least.—JOHN GRAHAM, *Cranford, Hounslow*.

[The flowers before us are quite distinct from and decidedly superior to any other single yellow Wallflowers we have yet seen. The great breadth of petal of Cranford Beauty, combined with clearness and brightness of colour, cannot fail to render it a general favourite when it becomes more widely known.]

HYBERNATION.—What are its causes? I turned out during the summer of 1881 and 1882 some toads and frogs into a hothouse having a mean average temperature on ground between August and August 71.1° and 62.0°. I also turned out some green tree frogs. The toads and frogs—i.e., the English ones—hibernated each year from the end of October to the end of April. The green tree frogs did not. There was plenty of food and no lack of temperature. Blackbeetles and crickets are in abundance in winter; in fact, on the increase when their enemies were out of the way, but they are less in number now, and always on the look-out, as when I take a candle in the evening I only catch sight of a few, and in the winter I could kill many and see more. Like rabbits, rats, and other vermin, they know when the enemy is on the look-out. I have other curious statements that I

could make on the subject, but perhaps your readers would not care to read them.—CUTHBERT JOHNSON, *Daventry*.

AN EXHIBITION OF ORCHIDS.

MR. W. BULL has now provided at his nursery in the King's Road, Chelsea, an exhibition of Orchids that he has never previously equalled either in magnitude or beauty, and which, during the present and approaching month, will undoubtedly prove a great attraction to Orchid lovers. A span-roofed house, 20 feet wide and 100 feet long, with a central and two side stages, has been converted into a paradise of Orchids, in which the visitor stands amazed at the wealth of bloom, the profusion of rich, bright, and delicate colours, the singularity and diversity of forms which are seen springing from banks of graceful Ferns and Palms. There is nothing harsh to the eye, no obtrusive pots, no rigid formality of arrangement, but a freedom and lightness which accord well with the character of these plants. A vista of

100 feet is still further extended by mirrors placed at each end of the house, so that the view appears to be interminable—a most agreeable illusion.

The visitor is first greeted on entering the house by a magnificent bank of *Odontoglossum vexillarium*, scores of spikes displaying their large and variously tinted flowers, from pure white to the richest rose. Numbers of these plants dispersed throughout the house contribute greatly to the beauty of the display; indeed the spikes may be counted by hundreds, and the flowers by thousands. *Odontoglossum Alexandrae*, another popular Orchid, is in strong force, 200 spikes of expanded flowers being now amongst the numerous attractions in the house; they include some grand varieties, great substance of flower, breadth of petal, pure white, or delicate tinted. *Odontoglossum Pescatorei* is also largely represented by many of the varieties in cultivation, and the plants arranged on a bank at the extreme end of the house have a beautiful appearance. Then turning to the novelties or rarities in the same genus, there is the magnificent *O. polyxan-*



Fig. 94.—*ODONTOGLOSSUM RUCKERIANUM*.

thum grandiflorum, recently certificated at Kensington and described in these columns; *O. facetum*, a form with extremely neat flowers, yellow spotted rich brown; *O. Roezli nigrum*, a variety with a very dark lip; and innumerable others. But two others that have only been just provisionally christened deserve especial notice—namely, *O. chelseae*, which has beautifully formed flowers, white blotched with brown, and *O. perinsigne* with flowers of moderate size, rich yellow, spotted and blotched with chocolate, the lip having neatly cut margins. In our woodcut, fig. 94, is represented a fine variety of a beautiful *Odontoglossum* which has been flowering well in Mr. Bull's nursery; this is *O. Ruckerianum*, a species from New Grenada that has now been known several years, but is becoming a great favourite. The sepals and petals are creamy white spotted and blotched with chocolate, a few spots appearing also on the lip, and a tinge of purple on the other portions of the flowers.

Of other genera the forms included are so numerous that comparatively few can be mentioned in this short notice. *Cattleyas* are fine, especially a new variety of *C. Trianae*, which has been named *Victoriae* in honour of Her Majesty. This is distinguished by the symmetrical form of the flowers, broad rounded bluish sepals and petals, with an intensely rich crimson fringed lip. *C. Skinneri superba* is a truly "superb" variety of a handsome species, *C. Warneri*, and others in this genus all merit attention.

Of *Dendrobiums* the light and graceful *D. Devonianum* is particularly abundant, the charming *D. thyrsoflorum* and its variety *Walkerianum*, with spikes of gold and white flowers a foot or more in length, and *D. Pierardi* are in greatest force. *Masdevallias* are numerous, handsome varieties of *M. Harryana* and *M. Lindeni*, with the pretty *M. Shuttleworthi*, the diminutive *M. xanthina*, and the curious *M. trochilus* imparting their respective attractions to the show. Two beautiful forms are *M. Massangeana*, one of the ignea type, with large orange scarlet flowers; and *M. regalis*, a new rich crimson form even surpassing the superb *Bull's Blood* variety in intensity of colour, is also distinguished by the points of the two lower sepals strangely incurving.

Few others of these handsome Orchids can now be noticed, but *Cymbidium Lowianum*, with its dark variety *atropurpureum*, is very prominent, the summer-flowering variety of *Angraecum sesquipedale*, *Oncidium leucochilum*, *Aerides Fieldingi*, *Laelia purpurata*, and *Vanda suavis* are all flowering freely.

Such is a brief outline of a most remarkable exhibition, which is worth the attention of all admirers of Orchids.

THE DYING OF APRICOT BRANCHES.—In reference to this circumstance I would remark that in October, 1879, some badly injured twigs were sent to me, and on examination it was found that they were

bored by the caterpillars of a small moth, frequent upon the Apple and Pear, called the Apple Clearwing, *Sesia myopæforme*. This was presumably the first instance recorded of its occurrence upon the Apricot, but there would be nothing remarkable in the insect's attacking that species and its allies. I do not for a moment suppose that the common dying-off of branches recently described is thus to be explained, yet it is likely the insect attacks the Apricot more than has been hitherto observed. There is no external sign of the damage going on within until the moths come forth, leaving small holes in the bark. I believe there is no means of preventing their visits except by catching them, and they are not easy to secure. The eggs are deposited (very small) during June and July.—ENTOMOLOGIST.

FRUIT PROSPECTS.

PERHAPS it would be scarcely correct in commencing my notes to say we have no "fruit prospects;" nevertheless, what little prospect we have in this direction is very gloomy indeed. True, the Apple blossom, with the exception of Irish Peach, which blooms nearly as early as the *bonâ fide* Peaches, is still folded up, and we may hope some of it is secure; but the trees are dying with canker, not by inches, but by yards.

Pears in the open are only just opening their flowers, although many of them were showing colour in February; they, too, are cankered badly, and the prospect of fruit from them cannot be a brilliant one. Nothing in the vegetable world can stand still through three spring months and then have a good prospect before it. Pears on one south wall are a good crop and swelling well; on another south wall, not so much protected, they are only middling; on an east wall Jargonelle and Glou Morceau are in full flower and promise well. None of the Pear trees on walls ever canker.

Apricots are nil, and the trees half dead. Of Peaches there is less than a quarter of a crop, and this from the late flowers; the early ones which expanded in February and early March did not survive.

Plums on east and west walls are out of flower and stationary; whether they will ever make another start time alone will prove. Cherries on a south wall are half a crop and good. Morellos on a north wall are in full flower, also good on west wall, just set, very promising.

Gooseberries are swelling nicely, but we have not so heavy a crop as usual. Currants of all sorts are in flower. Some of the flowers are killed, but I am in hopes of seeing a crop. Strawberries are just beginning to flower, and look promising. Raspberries are not so forward.

We had four and a half hours of a heavy snowstorm on the 10th, lasting from 5.15 to 9.45 A.M., not microscopic flakes, but good-sized ones, many of which would cover a pennypiece. Currant bushes were laid flat, but the snow has not done so much harm as the continued cold which has prevailed for the past two months.—W. TAYLOR, *Longleat, Wilts.*

THOUGH the cutting winds and frosts which prevailed throughout the month of March and the early part of April had the effect of reducing the prospect of a crop of stone fruit, excepting Cherries and Golden Drop Plum, to a minimum; they have, however, in retarding the opening of the blossom thereby rendered the prospect of a good Apple and Pear crop a promising one, the trees of the former in our large orchard and kitchen garden being at the present time, with few exceptions, resplendent in the profusion of their lovely pink and white blossoms. The following, among other varieties of Pears, promise to yield good crops in various aspects and under different modes of training—viz., Marie Louise, Glou Morceau, Beurrié Raneé, Easter Beurrié, Beurrié de Capiaumont, Beurrié d'Amanlis, Josephine de Malines, Passé Colmar, Thompson's, Winter Nelis, Duchesse d'Angoulême, and Ne plus Meuris. While Apricots and Peaches are very thin on the trees, the following varieties of the latter are fairly well cropped—namely, Bellegarde, Violette Hâtive, and Early Louise, the latter a very free-bearing variety. The Fig crop promises to be a good one, and the same may be said of Raspberries, Currants, and Strawberries; but Gooseberries, though some trees are heavily cropped, cannot be pronounced plentiful.—H. W. WARD, *Longford Castle.*

IT is rather early to write with any degree of accuracy on the prospects of the fruit crops in this locality. The trees generally are crowded with bloom, in fact considerably more so than they have been for some seasons past. Early Pears and Damsons have set an abundant crop, but I fear many of them will fall through the effects of the frosts, hailstorms, and piercingly cold east winds experienced of late; in fact the latter have commenced

falling. Midseason and late varieties of Pears, as well as Cherries, are now in full bloom, some of the earliest expanded flowers being quite black; but fortunately sufficient remain unexpanded to insure a crop, as the trees are now fairly well covered with foliage. Apples generally have scarcely yet opened their blossoms, with the exception of a few early-flowering varieties, and the prospect of an abundant supply of this fruit is good. All small fruits at the present time promise well, with the exception of Gooseberries, which are rather a thin crop. Many have fallen, and there remain many upon the trees that are yellow and will eventually drop. A full crop of outdoor fruit in this locality is a great uncertainty, as we suffer very much from slight frosts very late in the season, and our hopes on many occasions have been blighted. At present the weather is mild, but hitherto we have had a great absence of sunshine.—WM. BARDNEY, *Norris Green, West Derby.*

THAT a backward spring is favourable to the fruit crop will be, I think, fully exemplified this year, for the blossom is fully three weeks later than it was last year, and therefore is in much less risk of harm from ungenial weather. But we do not consider it safe yet; for was not the blossom of last spring almost totally destroyed by a south-western gale, and not by extreme cold? The prospect of a crop of full and great abundance is, however, extremely good. Apples almost without exception are full of blossom buds, but very little of it is expanded. Pears and Cherries on walls and in the open are all wonderfully full of bloom, and some of the earlier kinds are setting fruit. Some Plums promise well, but others have suffered so much from the ravages of birds that very few blossom buds remain. Peaches and Nectarines on open walls have almost all set enough fruit. Of Figs on walls having plenty of young fruit, White Marseilles, Grizzly Bourjassotte, White Ischia, Brunswick, and Brown Turkey are worthy of especial mention. Nuts and Filberts will probably prove a total failure, for the male flowers were almost all destroyed by the wet winter. Strawberries are making growth strongly and well; bush fruits, too, give promise of great abundance.—EDWARD LUCKHURST, *Oldlands, Sussex.*

THE magnificent weather which, after some good preparatory rains set in just before Whitsuntide, must, if continued, go far to make amends for bygone cold and adverse influences. While on the one hand all vegetation has been, even taking the backwardness of several past seasons into consideration, unusually late, on the other hand one is disposed to think that there has been less check from frost or east winds as yet, and that therefore, in this district at least, the vast bulk of fruit trees blooming are still safe, and their promise at this moment is undoubtedly superb. I am speaking mostly of Pears, Apples, and Cherries. Apricots, Peaches, and Plums, however young and apparently vigorous the trees have been, seem unable to regain the vitality which for several seasons has been so severely tried by intense cold as well as by sudden changes of temperature.—A. M. N., *Mid-Lincoln.*

IT is, of course, early to predict the crop for the coming season, but as far as appearances go Apples are blooming far better than for many years, and the flowering time has been favourable hitherto. The orchards are perfectly lovely; some trees are so full of bloom as to appear like garlands or rods of blossom, the large-flowering varieties making a grand show. It is to be hoped that this important crop may be a good one.

Pears are very uneven and much of the blossom is weakly, but a larger crop than last season may be expected.

Plums and Damsons have never perhaps borne less blossom, and it is only here and there that a tree full can be seen. This is owing to the gale of April 29th, 1882, which, being followed by a severe aphid blight, has so weakened the trees that it was as much as Nature could do to lay up a store of foliage. In many places it is probable that the trees must perish, and the want of a yield of these important jam fruits will be a loss to the Kent growers, who send very large quantities of Damsons to London. They may, however, find some compensation in the fact that their soft fruit (Currants and Gooseberries) will in all probability return a better price.

Cherries have blossomed grandly, but the severe frosts and cold easterly winds may have been injurious to their tender organs. A few weeks will now determine the possible crop.

The genial, if cold, rains have done wonders for the Raspberries and Strawberries, and they both promise well, though the latter felt the only severe frost of the winter very much, and some recently planted beds were thinned.

Gooseberries are fast swelling and promise well; but the birds

have been far too attentive to the bushes, and I do not expect the crop will be a heavy one, though the berries may grow out and fill the measure. Those plantations which last year were "struck" with the saw fly are naturally deficient, and growers should wait on the bushes with hellebore powder as soon as the "grubs" again appear.

Black Currants are unusually full of blossom, so that port wine will be plentiful in a few years. Red Currants are blooming freely, but not copiously. The severe attack of the Currant aphid is making itself felt now in the plantations, and many bushes are quite dead.

The Peaches and Nectarines I have seen in gardens are well set with healthy thriving fruit, and, taken all round, matters look very promising. Trees are very clean in foliage at present, and we must at least look with hope and faith for these "fruits of the earth in due season."—GEORGE BUNYARD, *Maidstone*.

CRYSTAL PALACE SHOW.

MAY 19TH.

ON Saturday last a most satisfactory exhibition was held in the Sydenham Palace, the competition in many of the principal classes being more keen than usual, which was partly due to the fact that more prizes were offered. The arrangement was as effective as the position admits, the formal stages which bear the majority of the plants being unsuited to a tasteful display. The central portion near the orchestra and theatre was, however, very bright and attractive, large specimen Azaleas occupying the corners, with Messrs. Jackson's handsome Clematises immediately in front of the theatre; and facing that in front of the orchestra was the diversified and bright collection of plants from Messrs. Laing & Co., while a group of well-grown Calceolarias from Messrs. J. Carter & Co. had a central and commanding position. The weather throughout the day was very fine, and a large company of visitors assembled during the afternoon.

ORCHIDS.—The entries in these classes were very satisfactory, and had all of them been arranged together a magnificent group would have been produced. Especially beautiful were the two collections staged in the class for a group of not less than forty plants, which occupied a large table and proved one of the greatest attractions. Premier honours were awarded to Mr. C. J. Salter, gardener to J. Southgate, Esq., Selborne, Streatham, for one of the most tasteful and pleasing groups of Orchids that we have seen at a public exhibition. It was about 20 feet long by 8 feet wide, and comprised a large number of choice species and varieties, all in excellent health and flowering profusely. These were associated with Adiantums and small Palms, sufficient being employed to conceal the pots or blocks and impart a gracefulness to the group. Of the numerous Orchids included *Odontoglossums* were particularly fine, *O. Pescatorei*, *O. citrosum*, and *O. Alexandræ* being represented by superb varieties. *Dendrobiums* were similarly abundant, *D. thyrsoiflorum*, *D. Wardianum*, *D. Devonianum*, and the charming *D. Ainsworthii* being the most notable. *Cattleya Skinneri*, *C. Mendelli*, *C. Schilleriana*, *Colax jugosus*, *Masdevallia Shuttleworthii*, *M. Veitchiana*, *Oncidium concolor*, and *Lælia cinnabarina* were only a few of the many good plants shown in this excellent collection. Mr. H. James, Castle Nursery, Lower Norwood, followed closely with a group similarly arranged, and including many choice plants flowering well.

There were also four good collections in the amateurs' class for nine Orchids, the chief award being obtained by Mr. Catt, gardener to W. Cobb, Esq., Silverdale Lodge, Sydenham, for fine specimens comprising *Cymbidium Lowianum* with two long spikes, *Vanda curvifolia* with ten spikes of its deep orange-red flowers, *Dendrobium thyrsoiflorum* with eighteen spikes very handsome, *Vanda Denisoniana* with two spikes, together with *Masdevallia Harryana* magnifica, *Oncidium phymatochilum*, *Odontoglossum vexillarium*, *Vanda suavis Veitchii*, and *Cattleya Mossiae*. Mr. Child, gardener to W. J. Bell, Esq., Garbrand Hall, Ewell, was placed second, a decision which was unfavourably criticised by some visitors; but notwithstanding the high quality of Mr. Child's plants, they were surpassed by the preceding in a few points. The Ewell collection, however, comprised several particularly fine specimens; *Dendrobium Wardianum*, *D. nobile*, *D. Farmeri* with eight large spikes, *Lælia cinnabarina*, and *L. purpurata pallida* being very good, and all the plants were in admirable health. Mr. Salter was third with smaller plants, including several good *Cattleyas* and *Dendrobiums*, of which, indeed, the collection was almost entirely composed. In the nurserymen's class for nine Orchids Mr. James, Lower Norwood, and Messrs. Jackson & Son, Kingston, obtained the prizes in that order with similar collections to those staged at Regent's Park a few days previously, and described in our last issue.

In the classes for stove and greenhouse plants and Azaleas the principal prizes were awarded for collections that appeared at the Regent's Park Exhibition and need not be particularised. In the nurserymen's classes the prizes were secured by Messrs. Jackson and Son; Tudgey, Waltham Cross; and Peed & Son, Lower Streatham, for stove and greenhouse plants; by Messrs. C. Turner, Slough, Jackson & Sons, and Peed & Sons for Azaleas. In the amateurs' corresponding classes Mr. Chapman, gardener to J. Spode, Esq., Hawkesyard Park, Rugeley, and B. Peed, gardener to Mrs. Treadwell,

St. John's Lodge, Lower Norwood, were first and second in the first-named class; Messrs. J. Child, Ratty, gardener to R. Thornton, Esq., The Hoo, Sydenham, and B. Peed being the winners with Azaleas. Heaths were chiefly shown by Messrs. Jackson, Peed & Son, and Tudgey, and Pelargoniums by Messrs. Turner, W. Griffin, Gothic Cottage, Church Street, Sydenham, the Slough plants being in very good condition.

FINE-FOLIAGE PLANTS.—These were represented by several creditable collections, that from Mr. Penfold, gardener to Canon Bridges, Beddington House, Beddington, which was placed first in the open class for nine specimens, being of unusual merit. All the plants were exceedingly vigorous, but two were remarkably so—namely, *Davidsonia pruriens*, 6 feet or more high, with fine healthy foliage, and *Asparagus plumosus* (tennisimus), of similar height, and 4 or 5 feet in diameter, one of the largest specimens in cultivation. *Alocasia macrorhiza* and *Dracæna Lindenii* were also of great merit. Mr. James followed with smaller examples. For nine *Dracænas* Mr. Bird, gardener to J. A. Causton, Esq., Lodgemore, Alleyn Park, Dulwich, secured the principal award, staging highly coloured healthy plants of *Bausci*, *Goldicana*, *Thomsoni*, *Tellingi*, *Gladstonei*, *porphyrophylla*, and *salmonea*. Mr. James and Mr. J. Wakeham, gardener to H. Barrett, Esq., Merivale, North Dulwich, were second and third respectively. In the class for nine *Crotons* Mr. Bird was again the most successful, several of his specimens being 6 to 8 feet high, healthy, and well coloured. The second prize was withheld, Mr. James being placed third with small but useful plants. Ferns were not very abundant. Mr. Penfold had the best nine good examples of *Adiantum gracillimum*, *A. Sanctæ-Catherinæ*, *Davallia fijiensis*, *D. polyanthum*, and *Cyathea Smithii* being included. Mr. B. Peed was second, his best plant being *Adiantum farleyense*.

Messrs. G. Jackman & Sons, Woking, were awarded the first prize for twelve Clematises, the only collection staged, and which have been already referred to as forming a beautiful bank in front of the theatre. The plants were in admirable condition, and attracted quite as much attention as they did at the Royal Botanic Society's Show.

Mr. C. Turner was the only exhibitor of eighteen Roses in pots, and was deservedly awarded first honours. The plants shown were of moderate size, very fresh, healthy, and well flowered, the blooms large and finely coloured. Star of Waltham, Edward Morren, Marie Baumann, and Sir Garnet Wolseley were especially good.

Tuberous Begonias were shown by two exhibitors, Mr. Child and Mr. Penfold, the former taking the lead with strong plants fairly well flowered, *Reine Blanche*, *Paul Masurel*, and several seedlings being notable. Mr. Penfold's plants were healthy but had few blooms—in fact, were not up to exhibition standard.

Calceolarias were represented by three good collections in the class for twelve plants, Messrs. Carter & Co. being first with vigorous specimens bearing large and richly coloured flowers. Mr. Salter was placed second with a very even collection, and Messrs. Dobson of Isleworth third, also with even plants.

Messrs. J. Laing & Co., Forest Hill, were awarded the premier prize for a handsome group of flowering and fine-foliage plants, which were arranged in the form of a semicircle in front of the orchestra. *Ericas*, *Begonias*, *Ferns*, *Dracænas*, *Dieffenbachias*, *Palms*, *Crotons*, and a number of new and beautiful *Caladiums* constituted the bulk of the group.

First-class Certificates were awarded to Messrs. J. Laing & Co., Forest Hill, for Tuberous Begonias *Black Douglas*, *Mrs. Morgan*, *Canary Bird*, *Prince of Wales*, and *Queen of Scots*, and *Caladiums cardinale*, *ornatum*, and *Verdii*. To Mr. C. Turner for Azalea *Madame Van Houtte*, *Rose Merveille de Lyon*, and *Pelargonium Dresden China*. To Messrs. T. Jackson & Sons, Kingston-on-Thames, for *Impatiens Sultani*.

MISCELLANEOUS.—A number of collections of plants were staged not for competition, and contributed greatly to the interest of the Exhibition. Extra prizes were awarded to Messrs. Carter & Co., High Holborn, for handsome groups of seedling *Dracænas* and *Calceolarias*. To Mr. C. J. Salter for a group of *Calceolarias*. To Mr. J. R. Bird for extremely well-grown specimens of *Mignonette*, pyramidal and standard plants 2 to 4 feet high. To Messrs. Dobson and Son for a group of *Calceolarias*. To Mr. H. Hooper, Bath, for a collection of *Pansies* and *Tulips*; and to Mr. J. Churchfield, Sydenham, for *Anthurium Schertzerianum gloriosum*, a fine variety of this well-known Aroid.

PANSIES FROM SEED.

IN the Journal of the 10th inst. you inserted a short notice of some seedling Pansies which I left at your office. I have thought that as at the present time I have some 250 plants in bloom, many of which are carrying between thirty and forty flowers, a short account of the very simple plan of their cultivation might be interesting to your readers.

The seed, which was procured from Messrs. Sutton and Veitch, was sown under handlights in a vacant space in the kitchen garden about the beginning of June, and shading was given to keep off the heat of the sun. As soon as the seedlings appeared plenty of air was admitted, the lights being removed during the

nights and on dull days. This attention was only necessary for ten days, after that the lights were entirely dispensed with.

By the middle of July the seedlings were large enough to be pricked out. This was done on another piece of ground in the kitchen garden, and they were afterwards well mulched with partially decayed manure. The only attention after this was occasional waterings and keeping all buds picked off until the first week in September, when they commenced flowering most freely.

In October they were taken up with a good ball of earth and placed in the beds, from which bedding plants had been removed. Here they continued giving a few flowers all winter, and on the 23rd of December I picked a good bunch, which was on our table for Christmas-day. They are now a mass of bloom, as I have said, many plants carrying over thirty flowers. This has reduced the size of the flowers, but I enclose a few as a sample. I may add, we keep gathering the flowers every day in order to prevent the formation of seed pods. My grief is that the next few days will see their destruction to make room for bedding plants.—W. HAWLEY, *Ash, Surrey.*

[We can understand the reluctance to destroy them, as we have never seen a finer assortment of seedling Pansies.]



MR. BROTHERSTON writes:—"You are always glad to recommend something good to your large constituency of supporters. I, therefore, wish to say that those who are fond of Roses, and have means of growing them under glass, should grow the ROSE REINE MARIE HENRIETTE. It was planted with others in a late Peach house here two years ago, and has this year yielded a most abundant crop. The colour of the flowers I would call a rosy crimson; their shape in the bud state, when not too much opened, is simply perfect. In addition to these good qualities it is a strong grower and opens its blooms slightly earlier than Gloire de Dijon."

— MR. WARE informs us that so far from there being any decline in the public taste for SINGLE DAHLIAS the demand for plants is this year greater than ever; and this, we believe, is also the experience of others who prepare these plants largely. A method of culture will probably become more general this year—namely, pegging down the plants instead of securing them to stakes. Thus treated in large beds and borders dazzling masses of flowers are produced. In well-worked and fertile soil the plants for pegging may be 3 feet apart. It is satisfactory to find that double Dahlias are also increasing in favour, the National Dahlia Show having presumably given an impetus to the culture of these noble flowers. Both double and single varieties may well be grown by all who desire a grand display of flowers in late summer, and the present is the time for planting them.

— "E. M. P." writes:—"I have long been wishing to obtain some CREOSOTE to soak the bottom of my labels, espalier stakes, and garden wood with generally, as the rapid decay of the labels is a great inconvenience, and the rest of the woodwork a great expense; but I cannot buy it, nor can I find out any address where I can obtain it in quantities of 1 quart to 1 gallon, as the makers do not supply such small quantities. My chemist could procure me some at 3s. per pound, but this is of course of purer quality than I require. If any of the correspondents of your valuable Journal can give me the desired information I shall be very much obliged."

— AT the time the Reading Show is usually held—

namely, the second or third week in May, MESSRS. SUTTON AND SONS invariably have a grand display of CALCEOLARIAS, and the present season is not an exception to the rule. The plants have passed through a most trying ordeal during the past two months, but they have regained their customary vigour, and the flowers are even more richly coloured and abundant than usual. In the house specially devoted to those plants a surprising diversity of tints is observable, and this, too, in combination with a symmetry of form that in the majority of cases would satisfy the most critical florist. Rich crimson, maroon, chocolate, rosy and yellow selfs are abundant; then in striking contrast to these are the delicately laced forms which are the most highly bred varieties, and the most difficult to maintain in a mixed strain. Some of these are exquisitely beautiful, most delicately pencilled or reticulated with the self colours on a lighter ground, often creamy or pure white. All the plants are marked by a sturdy compact habit, the flowers being borne in fine trusses well above the foliage, but without any approach to thinness. In fact, all the characters of this strain of Calceolarias are precisely what are desired, and so great an advance has been made with them in recent years that there is little further room for improvement. In other houses are large stocks of Gloxinias fast advancing and promising well for a grand display later in the season. Tuberos Begonias also occupy several houses, and large numbers of seedlings have been raised, amongst which many novelties are expected as the result of a series of careful crossings between the best of the varieties previously obtained.

— AT a meeting of the Maidstone Farmers' Club on the 17th inst. Mr. Charles Whitehead read a most exhaustive and interesting paper on MOULD OR MILDEW ON HOP PLANTS. The lecturer discussed at length the history, characters, causes, remedies, and preventives of the disease. The sulphur remedy was fully considered, and it was specially advised that it be applied only in the daytime, 40 to 50 lbs. per acre of the lightest flowers of sulphur being sufficient, or 60 to 90 lbs. of heavy sulphur per acre. The lecture is printed *in extenso* as a supplement to the *South-Eastern Gazette*, May 19th.

— MR. T. ENTWISTLE, gardener to J. Broome, Esq., Didsbury, Manchester, who won the premier prizes in the classes for alpine and herbaceous plants at the Manchester Whitsuntide Show recently, sends the following list of the plants exhibited, which may be useful to intending competitors in such classes. The ALPINE PLANTS included the following:—*Ramondia pyrenaica*, *Centaurea stricta*, *Saxifraga pyramidalis*, *Alyssum alpestre*, *Armeria setacea*, *A. alpina*, *Hutchinsia alpina*, *Saxifraga carinthiaca*, *Sempervivum arachnoideum*, *Saxifraga cochleata*, *Ranunculus amplexicaulis*, *Anemone sulphurea*, *A. alpina*, *Globularia bellidifolia*, *Saxifraga tombiana*, *S. caesia*, *S. valdensis*, *Agave utahensis*, *Primula rosea*, *Androsace Vitaliani*, *Saxifraga muscoides purpurascens* (*S. atropurpurea*, *Steinb.*), *Erysimum rhaticum*, *E. pumilum*, *Lychnis pyrenaica*, *Cochlearia alpina*, *Phyteuma comosum*, *Gentiana vera*, *Iberis granatensis*, *Androsace carnea*, and *Potentilla nitida*. Most of these were in flower.

— THE HERBACEOUS PLANTS were as follows:—*Saxifraga cordifolia*, *Narcissus odoratus*, *Ranunculus aconitifolius* fl.-pl., *Xerophyllum setifolium*, a graceful plant, exceedingly rare; *Lychnis viscaria splendens*, *Trollius europæus*, *T. asiaticus*, *Funkia ovata variegata*, *F. Sieboldiana*, *Geum aurantiacum*, *Geranium phæum*, *Hemerocallis fulva variegata*, *Orchis maculata*, the good pan shown last year; *Cypripedium parviflorum*, *Helonias bullata*, *Trillium grandiflorum*, *Arisæma triphylla*, *Thalictrum purpurascens*, *Polygonatum giganteum*, *Delphinium tricornis*, *D. nudicaule*, *Lilium Browni*, *Spiræa palmata*, *S. Ulmaria* fl.-pl., *Anthericum Liliastrum*, two spikes; *Orobanchium multiflorum*,

Lychnis coronaria atrosanguinea, *L. Haageana*, and *Cardamine pratensis* fl.-pl. The majority of these were also in flower.

— OUR reporter at the Manchester Show inadvertently omitted mention of a remarkable collection of CUT FLOWERS OF ORCHIDS numbering fifty species, exhibited by Messrs. Ireland and Thomson, Edinburgh, and which he says attracted, as they deserved, much attention.

— AMONG the ORCHIDS IN FLOWER at the Glasnevin Botanic Garden, Dublin, are some of the most beautiful of the family. Of Dendrobes there are, besides varieties of the old and favourite *D. nobile*, the lovely *D. Devoniensis*, *D. Jamesianum*, and *D. Farmeri*. Of Odontoglots we noticed, besides several forms of *O. Alexandræ*, a very beautiful white variety of *O. Pescatorei*, a good plant of that noble species *O. triumphans*, two or three specimens of the exquisitely beautiful *O. vexillarium*, as also of the prettily marked and crisp-flowered *O. cirrhosum*, *O. Cervantesii*, and *O. nebulosum* var. *pardinum*. This last we do not remember seeing before; the flowers have a very distinct aspect by reason of the sparse but the large very distinctly defined chocolate dots or blotches on their clear white ground. Of the stately *Vandas*, *V. tricolor* and the remarkably fine form of it known as the Glasnevin variety, *V. insignis*, *V. suavis*, and several *Phalænopsids*. *Oncids* are well represented by the very remarkable *Oncidium serra*, with its wavy flower stem some 14 or 15 feet long or more, wreathed at intervals with clusters of its large, crisp, chocolate-coloured flowers, and *O. concolor* with flowers of the clearest yellow, one of the most telling of its colour.

— AMONG the ORCHID CURIOSITIES in the same garden may be noted *Uropedium Lindenii*, with its singular floral appendages 2 feet or more in length, and its ally, *Cypripedium caudatum*, and its fine variety *C. c. roseum* with singular drooping appendages, even longer still perhaps, the very dark-lipped variety of *C. barbatum*, and several others of this curious genus. Coming now to the cool Orchid section we found it represented by quite a host of *Masdevallias*, including such fine showy forms as *M. ignea*, *M. Harryana*, and its fine varieties *cærulea* and *violacea*. The singular *M. Shuttleworthii*, one of the prettiest of the genus; *M. triangularis*, also very pretty and rare; *M. Sanderiana*, &c.; and though last, not least, that microscopic little beauty, *Restrepia elegans*. The Orchids have led us on so far, that as regards other plants we have merely space to name among stove plants the glorious *Brownea ariza*, and that lovely shrubby stove climber, *Petrea volubilis*, the pretty little *Impatiens Sultani*, a curious *Gesnerad*, *Sciadocalyx digitaliflora*, and several pretty and curious *Bromeliads*. Of greenhouse plants, the gem of those in flower first is, we think, *Boronia elatior*. It is a plant no greenhouse collection should be without, and it is just the one plant exhibitors at the spring shows should take up as being worthy of their best efforts.—(*Irish Farmers' Gazette*.)

— MR. SMITH, Clubmoor, West Derby, Liverpool, sends the following experience as a BEGINNER IN MUSHROOM CULTURE after reading the articles in the Journal last year:—"It may be interesting to you to know that I have been very successful so far in growing Mushrooms. I cut 800 lbs. during the winter months chiefly from beds inside a Cucumber house and vinery. I have now, however, 170 yards of beds outside, made on the system described in the Journal; about 20 yards was made and spawned the last week in January, and the remainder in 25 or 30 yards every fortnight or so as I could get the manure. I was very doubtful whether the beds were going to be a failure, but I am glad to say the spawn is beginning to show through, and in some places clusters of Mushrooms. Mr. Barter tells me that it has been one of the most difficult springs for Mushroom-growing he ever experienced—such a cold March. He also states he has had beds do well after being dormant five

months, and I am now waiting for genial weather and good crops."

— WE observe in a daily paper there is to be another CRYSTAL PALACE, not in England, however, but in the park of St. Cloud, near Paris. This park is celebrated for its picturesque beauty, and for its fine cascades and fountains. The proposal is to pull down what remains of the historical château, and with the materials thus obtained to erect a building similar to the Crystal Palace at Sydenham. The Palace will be erected on the highest part of the site; it will occupy about 18 acres, will be of a rectangular shape, and divided into five naves. The front will be to the east—that is, towards Paris. The length of this building is to be 1650 feet, by 450 feet in breadth. It is to have a vaulted roof and a lofty dome.

— WE regret to record the death of Mr. WILLIAM COX, the late well-known and highly respected gardener at Madresfield Court, where he was successfully engaged for forty-two years, and was head gardener there for thirty-eight years. He has left behind him a monument in the form of the Madresfield Court Grape, which, notwithstanding its tendency to crack, is a splendid variety, and will be cultivated for years to come. The esteem in which Mr. Cox was held in the district in which he was best known was testified in a remarkable manner at the Birmingham Autumn Show last year, where he received quite an ovation. He died on the 8th inst. at the age of sixty-one years.

— AT the meeting of the Linnæan Society on Thursday, the 3rd inst., a valuable and interesting paper was read by Mr. J. Elliot Howard, F.L.S., the well-known quinologist, upon *CINCHONA CALISAYA*, VAR. *LEDGERIANA*, *How.*, and *C. Ledgeriana*, *Moens*, and in illustration of his remarks there was a magnificent display of Cinchona plants, bark, seeds, dried specimens, &c., brought together by Mr. J. Elliot Howard and by Mr. Thomas Christy, F.L.S., and the keenest interest was taken in these by the members of the Society present. On the conclusion of the paper, Mr. T. Christy said "That specimens of Cinchona had been sent to him from Bolivia by a botanist who had been in his employ here for some time. Mr. Christy impressed upon him, before he went out, the extreme importance of gathering the flowers, leaves, and the seed pods of all the varieties of Cinchonas cultivated on the plantations, and that gave the best results, and he had very fairly followed out these wishes. Mr. Christy then drew attention to the dried specimens of the various varieties which were placed before the meeting, and acknowledged the great assistance he had received from Mr. Howard in classifying these plants; and he said the result was, that after a great many letters passing, and a great amount of information being thus diffused, that planters in Bolivia had found that it was to their advantage to grow the *Calisaya verde*, a very large tree, and which they found answered their purpose the best of any. It did not yield quite as much quinine as the *C. morada*, but the growth was much more rapid and the yield of the bark was very much greater. Taking into account the twenty days' mule journey which this extra quantity bark had to support, it still paid better to cultivate than the richer variety of *Calisaya morada*, on account of the larger yield."—(*Planters' Gazette*.)

WALLFLOWERS FROM CUTTINGS.

LAST year, in June, we inserted a quantity of Wallflower cuttings in a turf pit covered with sashes. The plants are now nearly all in bloom, and present a very marked superiority over the few seedlings that survived the month of March. Ninety per cent. of the seedling plants were killed, 90 per cent. of the cuttings saved, and constitute our present small stock of plants. They are much more floriferous than seedlings; they can be lifted better from the absence of tap roots; they are more uniform in size of plants, and better and more reliable for masses of colour, where that is a consideration; in fact they are better every way than

seedlings, and do not cost any more. They might be struck easily enough upon any shady border, but in our parching east winds we find it better to cover them and keep them continually moist by sprinkling twice a day. If we have sufficient cuttings of our favourite sorts we shall insert 20,000 this year; last year we only put in 5000 as an experiment.—PETER FERGUSON, *Monk Wearmouth*.

CANKER IN FRUIT TREES.

I HEREUNDER send you the list of fruit trees which do not canker with me in extreme North Wilts, and not far from Bath; soil loam on sandy clay. *Apples Entirely Free from Canker*.—Dumelow's Seedling, Duchess of Oldenburgh, Irish Peach, Emperor Alexander, Cox's Orange Pippin, Loddington Seedling, Annie Elizabeth, Winter Hawthornden, Keswick Codlin, Ecklinville Seedling, Stirling Castle, Peasgood's Nonsuch, Tower of Glamis, and Yorkshire Beauty. *Apples which Canker to a very Small Extent*.—Gravenstein, Worcester Pearmain, Lord Suffield where the soil is well drained, Summer Golden Pippin, Sturmer Pippin, Warner's King, Margaret, Betty Geeson, Juneating, and Margil. *Apples which Canker very Badly*.—Cellini, Striped Beefin, Red Astrachan, Old Hawthornden, Old Golden Pippin, Beauty of Kent, Cox's Pomona, Lord Suffield on undrained soil, Bedfordshire Foundling, and Alfriston. *Pears Entirely Free from Canker*.—Williams' Bon Chretien, Soldat Esperen, Beurre Hardy, Beurre d'Amanlis, Josephine de Malines, Summer Doyenne, Madame Treyve, and Catillac. *Pears which Canker to a Small Extent*.—Winter Nelis, Bergamotte Esperen, Napoleon, and Jargonelle. *Pears which Canker very Badly*.—Beurre Diel, Seckle, and Louise Bonne of Jersey. *Plums Free from Canker*.—Kirke's, Rivers' Early, Green Gage, and Victoria. *Plums which Canker and Gum*.—Orleans, Coe's Golden Drop, and others, names unknown. I have other fruit trees which I have not classed, inasmuch as they are too young to be judged of properly.

In regard to what "Canker" says of the salt-laden gale of April, 1882, it was felt severely here from the Bristol Channel, the deposit on the windows being distinctly saline to the tongue. Hence, I imagine, is the failure this year in the blossom of every Plum out in the open, even to Bullaces and Damsons, and on walls unless something intervened. Thus I have a Kirke's and a Coe's Golden Drop, both partly protected by a thick Privet hedge 5½ feet high. Below the hedge there is a good blossom, above it none at all.—WILTSHIRE RECTOR.

CRINUM KIRKII.

THIS plant (fig. 95) has been seen several times at exhibitions within the past two years, but when shown by Mr. B. S. Williams of Upper Holloway recently at the Royal Botanic Society's Spring Show it received special attention, and the award of a first-class certificate for it signified the judges' opinion of its merits. It is one of the West African species, having been found at Zanzibar and introduced thence in 1879. The flowers are of moderate size, but are borne in good heads, and their chief beauty consists in the broad distinctly marked rosy crimson stripe in the centre of each petal, which shows up well on the white ground. It is as easily grown as other species of this genus, succeeding best in a stove temperature, and requiring plenty of water when growing and flowering.

NOTES FROM MY GARDEN IN 1882.—No. 4.

AN AMATEUR'S GREENHOUSE.

A RECORD of what I have been enabled to do with my small span-roofed house of 20 feet by 10 may be useful to others. It is supplemented by a small lean-to adjoining, containing a couple of Black Hamburg Vines, and is most useful as enabling me to place Camellias, Azaleas, &c., in when they had done flowering, also for placing Hyacinths in before they come fully into bloom. A correspondent recently gave a useful hint of training his Vines, where he says that he had, instead of spurring them all back, only done so with alternate shoots, shortened them, and allowed the crop to be produced from these shoots. It is, however, even here true that there is nothing new under the sun. I remember a few years ago, when paying a visit to the remarkable garden of a remarkable man—my friend the late Dr. Samuel Newington of Ticehurst—noticing that this method was very largely and successfully used by him, and had been for many years. I described this in the Journal at the time, and now often wonder why I had not tried it myself. I have to thank your correspondent for reminding me of it, and I am adopting it this year, and shall report on it if all be well at some future time.

I am not a little proud of the management of my greenhouse, and I think there are few similar structures out of which so much has been obtained. I do not attempt, as I do in Auriculas, Gladiolus, and Roscs, to grow a collection of anything. My object is to never have it without something in flower, and something, moreover, from which I can cut for the house, and it is very seldom that I cannot do so. It is true, people with large houses might say that my plants were not what they ought to be, that the stages were too crowded. Well, to a certain extent I am willing to admit this. I know, for instance, that some half dozen of Mr. C. Turner's Pelargoniums would fill the house, but I am contented with smaller efforts so that I can secure the object which I have in view; and yet when my Azaleas or Camellias become too large for my house I have no difficulty in disposing of them, so that they cannot be so very bad after all. Let me, then, detail the changes through which it has passed during the year.

I do not grow any Primulas, for as I cannot grow everything, and as Primulas are not good for cutting, I leave them out and go in for Cyclamens. These are invaluable; they make a house gay, and the giganteum strain especially gives a good supply of long-stalked flowers for cutting. These with Camellias, of which I have about a dozen and a half, commence my year. There are always some of the Zonal Pelargoniums which flower all through the winter, and their bright flowers always tend to lighten up the house. During this time the Show Pelargoniums are placed on a shelf which is suspended over the path and runs down about two-thirds of the house. They are consequently close to the light and do not get drawn. As the Camellias are going out of bloom they are taken into the lower house and placed under the Vines, while Hyacinths which have been plunged out of doors are then brought in for flowering. I need not say while these are in the house it looks very bright and gay. The Hyacinths do not last very long, and when they are out of bloom they are removed and more space is given to the plants that remain. I should add that all through this time several pots of the very pretty Schizanthus papilionaceus are placed at the back, and not only supply a mass of very light and pretty-looking flowers, but that they do admirably for cutting and placing in the top portion of a dinner-table stand. After the removal of the Hyacinths the contents of my house are these: On one side I have some well-formed plants of Azaleas about 18 inches to 2 feet high, and of the better sorts, such as Mrs. Turner, a most lovely bright pink and one mass of bloom; Flambeau, deep crimson, the deepest yet raised; Empress of India, salmon, semi-double; Madame L. de Kerchove; Marie Van Houtte, salmon; Apollon, very large white, &c. There are two or three fine plants of Libonia floribunda in full flower and not without foliage, although it was stated lately in a contemporary that in a cool house the flowers and foliage were not produced together. Here also are two or three pots of the old white Calla. I prefer to calling it thus than to giving it its grand scientific name. On the other side of the house the back row is occupied by the plants of Schizanthus, and some lovely plants of Tropæolum tricolor trained on trellises one mass of bloom, the rest of the stage being occupied by Show and Zonal Pelargoniums, with a few odd plants interspersed, such as the curious Boronia megastigma and the exquisite and deliciously fragrant Friesia refracta alba and Leichtlinii, also Lachenalias, useful for cutting, and Primula Sieboldii. Each side of the stage is edged by the Cyclamens, the greater number of them raised from seed, with large and well-shaped flowers; while close to the door I have a pan of the lovely Gentiana verna in full bloom, a gem which, alas! I cannot manage out of doors, clearly proving that it is our wet and changeable climate that hinders its well-doing, for in a cool frame it grows à merveille. When the Azaleas have done flowering they are transferred to the lower house, and then the Pelargoniums have still more room to stretch themselves. The Tropæolums have done flowering and are laid on their sides under the staging. The Arums are removed out of doors, and some Fuchsias which have been kept dry during the winter are started into growth. Tuberous-rooted Begonias, which have now started in a cucumber frame, are brought in, and the house looks very gay and bright. When the Pelargoniums are over it might be thought that its glories were at an end; but no, I still have a reserve force—my Lilies. These have been plunged under a light in cocoa-nut fibre, and are brought in as they show signs of bloom. Auratum, Batemannii, Hansoni, Kreutzrei, Brownii, Kramerii, &c. These with the Fuchsias, the ever-blooming Zonals, Begonias, and Salvias keep the house gay until the declining year bids us look to the Chrysanthemums for aid; and this through the dreary months of November and December keeps my lower house gay with bloom and offers a large supply of cut flowers. Such is the routine of the last twelve months, and I think I may safely feel a little proud thereof.

There are a few things of which, however, I am especially proud. One is *Disa grandiflora*, which again has done splendidly with me. I divided my plants last year, and potted them in two of Mr. Dominy's Orchid pans. One of them has done especially well. Some moss grew on the surface. This I have not removed. The *Disa* is pushing its way in all directions. There are four flowering stems, and shoots have pushed their points out through three of the holes in the sides of the pot; while from two others Ferns, which I suppose were in the peat used, have pushed them out also. During the winter months I have placed these pans,

which are kept constantly moist, up in the warm end of the house; but as soon as any danger of frost is over they are brought close to the door and syringed two or three times a day. As some persons profess to have a difficulty in growing this lovely Orchid, I would encourage them by saying that a more easily grown plant there is not, if its proper wants are attended to; and I am confident that the most extensive Orchid collection can produce nothing to excel this brilliant beauty of Table Mountain, the only spot in the world which is known as its habitat; and of the splendid sight that it presents there when in bloom Mr.

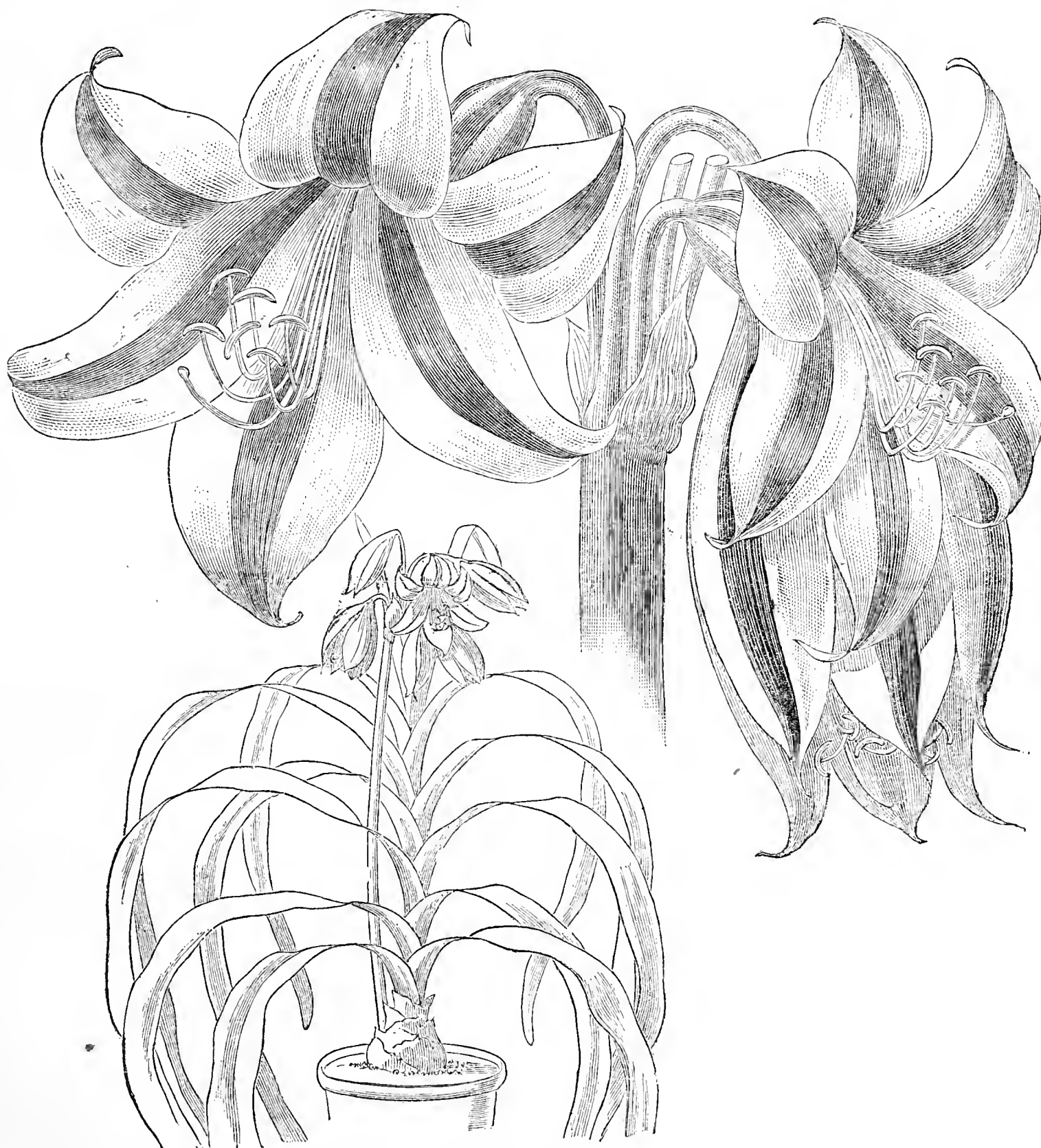

Fig. 95.—CRINUM KIRKII.

Shortt, the intelligent foreman at Messrs. Jas. Dickson & Co. of Chester, gave me a most glowing account, and I can well conceive that it must indeed be a grand sight. I had long wished to try the *Lapagerias*, and last year mentioned that they had grown and flowered well with me. Again they have done well. I have placed them in two of the largest pots I could get, and they are breaking out into strong shoots in all directions. If they grow on at this rate I shall have some difficulty with them. My object

is now to keep them as much as possible over the central path, so as not to interfere with the other plants in the house. They are planted in a mixture of very rough pieces of loam and peat and some lumps of charcoal, and they evidently like it.

The *Friesias* are very charming. Someone lately asked as to their freedom of blooming. I know of no small bulb that does more in this way, but I am inclined to think that there is some difficulty in getting them to start—at least, I had them for a

couple of years, and did nothing with them; now they are doing well. The sorts I have are *refracta alba* and one sent out by Messrs. Sutton & Sons of Reading called *Leichtlini major*, somewhat larger and with more yellow in it than *refracta alba*. I know of no perfume amongst flowers more refined, as a lady said to me the other day, than this. It is unlike anything I know, and reminds one rather of some of the delicate perfumes of French confectionery!—not a very romantic idea, but those who know aught of the skill of our neighbours in such matters will understand it. The *Calochorti* have utterly failed with me in pots, and I have no opportunities of growing them as recommended in frames planted out. I am sorry for it, as they are very lovely and curious; but I am afraid, like the *Ixias*, they will only do well from imported bulbs. I have tried them for years in all sorts of ways, and have never been able to get them to flower the second year, and I know others who are equally unsuccessful. It is but right that this should be known, for when we find grand collections of them shown at the London exhibitions, many, struck with their quaint beauty, are anxious to essay their culture, not knowing that these spikes of bloom come from the Channel Islands, the climate of which seems more favourable to them than ours. I do not know how they are grown there, and it would be a boon if any of your correspondents who live in those favoured spots would kindly tell us how it is done.

I do not feel that in the limited space at my disposal I am competent to give a decided opinion as to the merits of the various strains of Zonal Pelargoniums for house culture, but as far as my judgment goes Mr. Pearson of Chilwell is far ahead of all competitors, and I am the more convinced of this when I see that at the Pelargonium Exhibition his varieties figure more frequently in the prize list than those of any other grower.

Let me say that on the question of shading I have dispensed with tiffany, or any shading of that sort, and wash the glass with a mixture of sour milk and whiting. This resists the rain for a sufficiently long period, and at the end of the season what remains is easily washed off.

Such has been my greenhouse during 1882, and I may safely say, as I did last year, that I think few get more out of a structure of the kind and enjoy it more than I do.—D., *Deal*.

EPIDENDRUM REPLICATUM.

IN my notes on *Epidendrum*s last week the woodcut was by a printer's error named *E. cochleatum*, which it does not resemble in the slightest degree, as all who are acquainted with the two plants would at once perceive. *E. replicatum*, as stated in the matter, where its name, however, was omitted, is not one of the most handsome of the genus, but it is a good representative of the pseudo-bulbous section. *E. cochleatum* has a comparatively large lip, heart-shaped in outline, and resembling some bivalve shells.—L. C.

TOO-MUCH-ALIKE ROSES.

I AM a believer in head quarters and obeying edicts. I hold that cricket should be governed by the laws of the Marylebone Club, and that rifle-shooting should obey Wimbledon. In exhibiting Roses, then, I think we should all obey the National Rose Society, even though we may not absolutely agree with all its ideas.

The catalogue of the National Rose Society was issued in 1882. It is not perfect, but it has many advantages as a catalogue of reference, and it should be in every Rose exhibitor's hands. It is, indeed, almost a necessity for all those intending to exhibit at meetings of societies affiliated with it, or at the meetings of the parent Society. From its pages I quote—"The Committee recommend that after this season (1882) those Roses bracketed as synonymous should not be exhibited in the same stand, and that their being so should be considered a disqualification at meetings as above."

I have no wish to question the propriety of this step or otherwise; but this I do feel, that this recommendation, which I presume and hope, now it has been printed, will be acted on, cannot therefore be too widely known; and it seems to me that it ought for this year to be printed on all the schedules where the rule will be enforced. I think, too, it would be wisdom to name the Roses. For the sake of making this still more generally known I name the "too-much-alike" Roses here. They are, 1, Charles Lefebvre, Marguerite Brassac, and Paul Jamain; 2, Duchesse de Caylus and Penelope Mayo; 3, Eugénie Verdier and Marie Finger; 4, Maréchal Vaillant and Avocat Duvivier; 5, Marie Rady and Comtesse de Choiseul; 6, Maurice Bernardin, Exposition de Brie, Ferdinand de Lesseps, and Sir Garnet Wolseley (does this Rose change its name with the victorious soldier?); 7, Mons. Boncenne

and Baron Bonstetten; and lastly, 8, Prince Camille de Rohan and La Rosière.

Thus far for the Hybrid Perpetuals. Among the Teas we have 1, Adam and President; 2, Chromatella and Cloth of Gold; 3, Devonensis and Climbing Devonensis; and lastly, 4, Madame Bravy, Alba Rosea, Josephine Malton, and Madame de Sertot. All these Roses coming under the ban of "too much alike," only one of the varieties with the brackets can be exhibited in a stand, whether the stand be for six or seventy-two varieties.

But there is another point on which the catalogue is not very clear, and through your columns I suggest the difficulty to the good friend to whom in Roses we are all so much indebted—the valued Hon. Sec. of the National Rose Society, the Rev. H. H. D'Ombraïn. These Roses being considered "too much alike" to be distinct varieties, it seems to me that the converse holds good, and that they are sufficiently alike in, for instance, stands of trebles to be exhibited in the same treble, or in the same stand of Roses, say six or twelve blooms of one variety. Now I should like to ask our good friend to settle this point before Rose-exhibiting commences. It may save a heartache or two.

There is just one other point. I would remind all intending exhibitors that all the Hybrid Teas are excluded from the Tea and Noisette classes by the same catalogue.—Y. B. A. Z.

REVIEW OF BOOK.

Mushrooms for the Million. By J. WRIGHT. London: "Journal of Horticulture" Office.

IN our note last week announcing the publication of this treatise we intimated the criticism might appropriately be left to others. The manual has been read by many, and we are inundated with letters. We can only print the shorter and give extracts from some of the remainder.

THE treatise on Mushroom growing, from the pen of Mr. Wright, will be read by all with advantage. It is concise, truthful, and to the point—in fact, may be described as a *fac-simile* of the best way of growing Mushrooms.—R. GILBERT, *Burghley Gardens, Stamford*.

I CONGRATULATE the author on the appearance of "Mushrooms for the Million." It is just the kind of book that was wanted. Its perusal will teach many how very simple and easy it is to cultivate Mushrooms after all—that no sort of "mystery" attends their production. Let them but follow the simple and practical instructions so clearly given in this excellent treatise, and Mushrooms for the million will be a certainty.—A. F. BARRON, *Royal Horticultural Society's Gardens, Chiswick*.

I CONSIDER this treatise on the profitable culture of the Mushroom in the open ground to be by far the most exhaustive and practical work on Mushroom culture that has yet appeared. What Mr. Barron has done for the Vine Mr. Wright has done for the Mushroom, and it is scarcely conceivable that anyone who follows the stated details should fail to cultivate Mushrooms well. The treatise has the additional recommendation of showing not only how Mushrooms can be produced in great quantities, but also shows clearly the cost and profits of producing them.—D. THOMSON, *Drumlanrig*.

A MODEL treatise full of instruction, and which is given in such a simple, practical form, that with its aid the inexperienced in Mushroom culture ought to have little or no difficulty in growing highly profitable crops. Heated houses are generally thought requisite for Mushroom culture, yet much better crops of superior Mushrooms, as shown by this book, are to be had in the open air. Some of the facts given concerning the profits of Mushroom culture on a large scale are startling, but Mr. Wright had his information from a reliable source, and he never exaggerates.—W. IGGULDEN, *Marston Gardens, Frome*.

IN this treatise much of the uncertainty attached to the production of Mushrooms is made clear, both as to what is to be avoided and what is really necessary to be done to secure a crop full and good outdoors and indoors, and I can vouch for the soundness of the work by many years' practice of most of the details. The essay contains much that is new—indeed, everything that is worth knowing as regards growing Mushrooms, being far the best treatise on the subject extant.—G. ABBEY, *Paxton Park, St. Neots*.

THIS treatise on Mushroom culture is excellent, inasmuch as it embodies the experience of the most successful cultivators, and the *modus operandi* is given so plainly and concisely that any intelligent reader having the necessary material and space can scarcely fail in having an abundance of Mushrooms. After the treatise gets into the hands of the million, as it is sure to do, the result will justify its name.—H. WARD, *Longford Castle, Salisbury*.

THOROUGHLY practical from beginning to end, calm, earnest, forcible, and so clear that a beginner in Mushroom culture can hardly

go wrong under its guidance, this little book is calculated to effect a complete revolution in the ordinary methods of Mushroom culture both for home consumption and for market, for its statements are reasonable, and are so strongly supported by facts as to carry conviction to the mind. Nothing is coloured or strained to enforce its teaching, nor is there anything sensational, except it be the marvellous results already achieved by the simple method of open-air culture, which its author so clearly sets before us. Every detail is minutely explained, and so many hints given as to the causes of failures, that young and old practitioners may read it with equal profit. Not lightly do I speak of it in such terms of unqualified commendation, but from a strong conviction of its great utility and the benefit to be derived from it by everybody, for who is not fond of Mushrooms?—EDWARD LUCKHURST, *Oldlands, Uckfield.*

THIS treatise on profitable Mushroom culture in the open air is the cheapest sixpenny garden book ever issued from the press. This well-founded impression has been formed in considering the extent and excellency of the printing, the faithful execution of the illustrations, and above all the value of the thoroughly practical and lucid instructions which fill it from beginning to end, superfluous matter having no place in its ninety-three pages. All important operations come under different headings, such as "Mistakes in Practice," "Unsuitable Manure," "Preparing the Manure," "Making the Beds," "Temperature for Spawning," "Casing the Beds," and scores of other topics of equal interest. In pointing out who may grow Mushrooms there are included "farmers, market gardeners, florists and small nurserymen, cottagers, gardeners, clergymen, &c." and I would add, "everybody who will buy Mr. Wright's book and be guided by it." I know there are many who do not believe that Mushrooms can be grown successfully in the open air, but with the aid of this treatise the practice should, and no doubt will, become common. Details are given for indoor culture as well. In short it is an exhaustive volume, and in my opinion it may safely be consulted with advantage by all who wish to excel in Mushroom culture.—J. MUIR, *Margam Park.*

THIS is just the book that was wanted. An important feature of it is the attention given to the small and necessary details, which are too often ignored by the majority of writers. The remarks on unsuitable manure are genuine, as I have proved from experience. At one time here it was impossible to obtain Mushrooms, as the horses had medicine and Carrots freely. A fresh coachman has removed this state of things, and we can now obtain satisfactory crops from the manure produced. The author repudiates many practices that have become established. To test the soundness of the information imparted when passing through the Journal, I left three times more straw with the droppings than I have ever done or seen practised before, and the result has been better and more lasting beds. To further show the soundness of the teachings, now embodied in this treatise, my friend Mr. Smith started the cultivation of Mushrooms through the articles that appeared in the Journal, and without any previous knowledge. His success has been gigantic; in fact, he says "they pay much better than growing Cucumbers." An old gardener, who has been growing Mushrooms for years, says of the system detailed—"It is a new departure in Mushroom culture, and I intend adopting it." I would recommend all gardeners, whether young or old, as well as the public generally, to obtain this book, read it, and become thoroughly acquainted with the mode of cultivation described. It is cheap, being only 6d. in paper covers, but I think the bound copy is still better worth 1s., plus 2d. postage.—W. BARDNEY, *Norris Green.*

THIS is a marvellous sixpennyworth, and ought to command a ready sale. The subject in all its bearings is very exhaustively treated; the matter (of which there is much which is new to me) is arranged in good readable form. It is well printed on excellent paper, and is altogether a model of what a manual should be. The author first treats on the nutritive value of Mushrooms, and on this part of the subject I believe everybody at the present day is agreed. That we should have to import this and many other easily grown crops is a great misfortune, and now that the mysteries of Mushroom growing are unravelled in such a manner that nobody can fail to understand them, it is to be hoped that many artisans and labourers in the neighbourhood of large towns will take up the subject and add to their exchequer as well as to their pleasure.

That a well-managed Mushroom farm may be made to pay is amply proved, but the thing to be desired is to enlist the many rather than that a few should make their fortune.

Of the five essentials to success named, the first in my experience is the most commonly wanting in country districts—namely, the manure is very often not of good quality, owing to the large amount of green food which is consumed by the horses. There is considerable consolation in the fact mentioned by the author that manure from horses which have had much medicine is fatal to Mushrooms, for most of us have had unaccountable failures now and then when we have tried to do our best. The chapters on "Correct Practices" and the "Condition of the Materials" are particularly good, and should be learned by heart. Those on making spawn, &c., are interesting, and the instruction afforded cannot fail to be useful, as showing the nature of the spawn and the manner of its growth, but unless one is growing the noble esculent on a very extensive

scale it is best to buy spawn. I have used the so-called "French spawn" of my own make, but I prefer the bricks as sold by nurserymen.

The plan of growing Mushrooms in Cucumber and Melon frames is simple, and should be more generally practised. There is much more in this valuable treatise than I have noticed; it is brimful of sound information, and ought to be in the hands of everyone interested. There is much added which has not appeared in this Journal, but even without this addition it is better to have the series of articles in a collected form. I congratulate both the author and the publisher on their production.—WM. TAYLOR, *Longleat.*

ANGER is not a passion that should be indulged, but it is not easy to read through the volume before us without feeling both angry and humiliated. That eggs, fowls, fruit, and vegetables are imported in such vast quantities and at such enormous outlay on the part of the nation is very sad when the present state of agriculture is reflected on; but that we should go on importing Mushrooms as we do, and yet be still in want while we ought to have abundance and also export, is due to one thing only, and that is ignorance. A very large proportion of British farmers, almost all persons who keep horses, and all who live where horses are kept, could benefit their country and themselves by growing Mushrooms. Then why do they not do it? Knowledge alone is wanted, and that is supplied in this neat octavo volume of ninety-three pages. But there are those who have read everything in print on Mushroom culture without having yet gained the knowledge that insures against failure. The best and most conceited among us have failed altogether sometimes, and have been altogether at sea in regard to the reason why. In this neat little volume reasons for failure are given that some of us have ignored or did not even know of. Even those who never failed will own that seldom indeed have such results been gained under older methods, and the most experienced will own that here for once is a book on a subject on which several have appeared, and yet original. While it is certain the oldest will derive benefit from a perusal of Mr. Wright's book we should say that young gardeners cannot afford to do without it. The times in which we live are excessively competitive, and the weak go to the wall. Only those gardeners who are familiar with the best methods of doing things need hope for abiding success. Those who desire success should secure this work. Lately I advocated special volumes on special subjects. Here is a book that in the "struggle for existence" and "survival of the fittest" will hold its own for many a day. Indeed, so far as the culture of Mushrooms in the open ground is concerned all others that have come under our notice may be considered superseded.

We have only one fault to find with it. Not with its price, that is ridiculous in its lowness. Not with paper, printing, or illustrations; these are very good, clear, and substantial. But (possibly with a view to placing it within the reach of everyone, even the lowest-paid apprentice) its value has been underrated. It really ought to have been bound up in something substantial and charged for accordingly, as most young men will be likely to consult it so often as to wear out the cover. It is to be hoped that more editions will be called for; if so, let us hope to see one "destined to live."—SINGLE-HANDED.

The work can now be had bound as suggested, price 1s., post free, 1s. 2d., not 1s. 1½d., as inadvertently stated last week. We might publish much more, and more laudatory matter, as the writers of it know, relative to the work under notice; and we feel our apologies are due to them for our inability to do so. Mr. Wright desires us to say that while he is gratified by the favourable reception that has been accorded to this treatise, he will be still further obliged by any of its faults being pointed out, and to receive the particulars of any other methods of Mushroom culture that have proved advantageous to cultivators.

SELAGINELLA GRANDIS.

MANY handsome Selaginellas are now in cultivation, but we have no hesitation in assigning *S. grandis* a position amongst the best forms of the genus, and it will probably become one of the greatest favourites for general culture. It is a native of Borneo, whence Messrs. J. Veitch & Sons, Chelsea, obtained it through Mr. Curtis, and plants were first exhibited last year at Kensington and Regent's Park, when first-class certificates were awarded for it. As shown in the woodcut (fig. 96) the fronds are broad, the leaflets being also broad and closely set in the stem; they also have an arched appearance, which renders them quite plume-like, the fertile fronds being furnished with long tassel-like extremities. The colour is a rich bright green, and the plant being of good habit, vigorous, easily grown, and readily increased, it possesses every attraction to recommend it to the attention of plant-growers. It requires the temperature of a stove or tropical fernery.

SPRING CABBAGES.—Our largest piece of spring Cabbage measures 70 feet by 50 feet, and here we have many sorts growing, amongst which we may name Early Oxheart, Pearson's Conqueror, Redbraes, Enfield Market, Vanack, Webb's Emperor, and others. The best of



all these at the present time is Webb's Emperor, and then comes the Vanack. They are both very dwarf and compact in growth, and we have been cutting many fine-formed and pleasantly flavoured heads from them since the beginning of May. Pearson's Conqueror is our third best, and in a week or two's time, when the Redbraes is ready for cutting, it will be a most valuable sort. Enfield Market has not headed well; the Oxheart is very tall and has no centre; Baclan, which I had on trial, has too many large side leaves to be classed as a good spring Cabbage.—J. MUIR.

ROYAL HORTICULTURAL SOCIETY.

SUMMER SHOW, MAY 22ND AND 23RD.

THOUGH larger exhibitions have been held at South Kensington than the one which terminated yesterday, the unanimous verdict of the visitors was that in the freshness and general merit of the plants it could be favourably compared with any previous years. The great marquee was as usual devoted to the large plants in the principal classes, and groups either in competition or otherwise, and there was no appreciable difference in the number of exhibits. The approach tent was, however, much restricted in length, and contained the fruit, vegetables, cut flowers, and miscellaneous plants which had been submitted to the Floral Committee.

In the marquee the arrangement was very effective, the Slough and Cheshunt Roses forming beautiful banks at each end, the stove and greenhouse plants occupying the central banks, and the groups the side slopes. The brightly coloured Azaleas were sufficiently numerous to impart a most pleasing lightness and warmth to the display, fine-foliage plants and Ferns also being in due proportion to prevent a preponderance of colour.

The weather on both days proved most favourable, and considerable numbers of visitors attended who had the double attraction of a beautiful flower show and the interesting Fisheries Exhibition.

STOVE AND GREENHOUSE PLANTS.

There was a good display of these in the two classes devoted to them, the specimens being mostly large, fresh, and well-flowered. In the open class for twelve specimens Messrs. Jackson & Sons,

Kingston, took the lead with well-trained specimens of *Azalea Souvenir du Prince Albert*, profusely flowered; *Erica affinis*, even and good; *Aphelexis macrantha rosea*, in fine condition. *Dracophyllum gracile*, *Erica Lindleyana*, *E. Webbiana*, and *E. Cavendishiana* were similarly good; *Hedera tulipifera*, *Aphelexis purpurea*, and *Clerodendron Balfourianum* being also well flowered. Mr. Tudgey, Waltham Cross, was a close second, *Erica ventricosa* being very handsome. *Anthurium Schertzerianum*, *Erica Cavendishiana*, and *E. ventricosa coccinea minor* were very fresh and good. Messrs. Peed & Son, Norbury Nursery, Lower Streatham, were third with even, neat, and healthy plants.

In the amateurs' class for eight specimens Mr. Chapman, gardener to J. Spode, Esq., Hawkesyard Park, Rugeley, gained the premier position with very creditable examples of *Erica Cavendishiana*, *E. depressa major*, *Acrophyllum venosum*, *Dracophyllum gracile*, and *Anthurium Schertzerianum*, all the plants being well flowered, and some of them were 5 or 6 feet in diameter. Mr. Child, gardener to J. Bell, Esq., Garbrand Hall, Ewell, followed with rather smaller plants; but the Azaleas were of good size and grandly flowered, especially *Criterion*, *concinnum*, and *Model*, which were masses of bloom.

AZALEAS.

The exhibits in these classes contributed greatly to the brightness of the Show, as they do invariably, and the general quality was satisfactory, for except in a few cases the flowers were extremely abundant. In the amateurs' class for eight plants Mr. Child was a good first, his examples of *Duchesse de Nassau*, *Flag of True*, *Magnet*, *Reine de Pays*

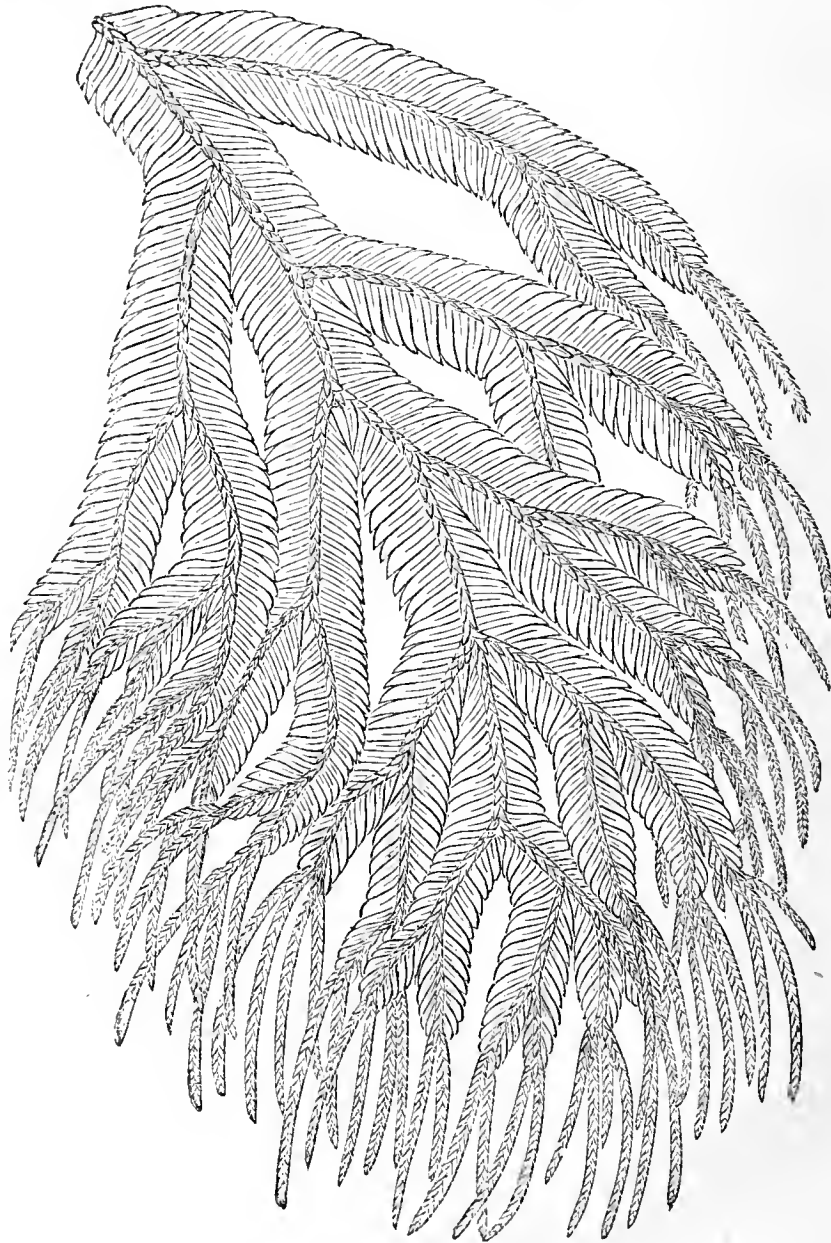

Fig. 96.—*Selaginella grandis*. (See page 431.)

Bas, and *Duc de Nassau* were admirably grown and flowered. Mr. C. Turner, Slough, was first in the nurserymen's class for the

same number, his plants being exceedingly well flowered, and the varieties good. Duchesse de Nassau, Cedo Nulli, A. Borsig, and Etendard de Flandres were the best. Messrs. Jackson & Son were second with globular specimens evenly trained, healthy and bright. Messrs. Peed & Son were third.

ROSES.

As usual these occupied the banks at each end of the marquee, Messrs. Paul & Son, Cheshunt, staging their gigantic specimens near the entrance, and secured the premier position for nine. The plants were mostly in fine condition, but a few, such as Charles Lawson for instance, had a number of unexpanded buds, giving promise of a later display. Juno, Centifolia rosea, Cheshunt Hybrid, and Dr. Andry were the most forward, a corner group of the small white Rose Parqueritte, and a marginal line of smaller specimens, with which Messrs. Paul & Son secured the first prize for twenty Roses, all served to constitute a group of great beauty. Mr. C. Turner secured the second position in the class for twenty with small plants, but for healthy vigour, size and abundance of blooms, all that could be desired. They were in 10-inch pots, well clothed with rich green foliage and the blooms finely coloured. Souvenir d'un Ami, Marie Baumann, Edouard Morren, Royal Standard, Paul Neyron, and Beauty of Waltham were amongst the most notable.

PELARGONIUMS.

The "combination" class for six Show and six Fancy varieties brought only two competitors, Mr. C. Turner winning first honours with profusely flowered specimens of Kingston Beauty, Viscount, Prince Leopold, Claribel, Maid of Honour amongst the Show varieties, and of Princess Teck, Fanny Gair, and East Lynn amongst the Fancies. Mr. Wiggins, gardener to H. Little, Esq., Hillingdon Place, Uxbridge, was a good second, both Show and Fancy varieties being well flowered, though less even than the first collection. Lucy, Princess Teck, and Roi des Fantaisies amongst the Fancies were very good, as was also Miss Bradshaw in the Show section.

ORCHIDS.

Two collections were staged in the amateurs' class for ten Orchids, and all included good specimens, not large, but well flowered, fresh, and healthy. Mr. Salter, gardener to J. Southgate, Esq., Selborne, Streatham, gained the premier award with finely flowered examples of Dendrobium Wardianum, Cattleya Mossiae Southgatei, Odontoglossum citrosimum, Dendrobium nobile, and Cattleya Warneri amongst others. The second position was obtained by Mr. Child with a praiseworthy collection—Masdevallia ignea aurantiaca with thirty flowers, Vanda suavis with six spikes, Dendrobium nobile, D. Wardianum with nine growths well flowered, Lælia cinnabarina, and Cypripedium barbatum with two dozen flowers or more. These two collections were extremely close in order of merit.

In the nurserymen's class for a group not exceeding fifty plants Mr. H. James, Castle Nursery, Lower Norwood, took the lead with a fine collection arranged with Ferns. A central plant of Cypripedium Stonei with a dozen flowers was very notable; Dendrobiums, Oncidiums, Masdevallias, Odontoglossums, and others constituting the bulk of the group. Messrs. Jackson & Sons were second with a pretty collection, but not so effectively arranged.

The competition for Sir Trevor Lawrence's prize of £10 for twelve plants, made-up specimens excluded, was confined to two exhibitors, Mr. Child deservedly gaining the award with beautiful specimens. Vanda suavis with ten spikes, Dendrobium Farmeri with eight fine spikes, Saccolabium Rollissoni with four spikes, Cypripedium barbatum superbum with thirty flowers, and others equally good. Mr. James was second with smaller plants.

CLEMATISES.

Only one collection of nine specimens was staged in the open class—namely, from Messrs. George Jackman & Sons, Woking, who gained the first prize. These handsome plants were in the same fine condition as they have been at recent metropolitan shows, the flowers large, abundant, and evenly disposed over the globularly trained specimens. Excelsior, picturata, Duke of Norfolk, and William Kennett were the best of the single blue varieties. Fairy Queen, lanuginosa candida, Impératrice Eugénie, and alba magna were the best of the single whites; and Duchess of Edinburgh, double white.

FINE-FOLIAGE PLANTS.

The grand specimens from Mr. Rann, gardener to J. Warren, Esq., Handcross Park, Crawley, Sussex, occupied the bank at the end of the tent facing the large Roses, and formed a most effective group, gaining the first prize in the class for eight. The enormous plants of Latania borbonica, Cycas revoluta, and Areca sapida were in fine condition; Croton albicans, C. Queen Victoria, Pandanus Veitchii, Croton Challenger, were also well coloured. Mr. King, gardener to P. Crowley, Esq., Waddon House, Croydon, was a close second with smaller specimens, but vigorous, fresh, healthy, and attractive; Davallia Mooreana, Croton Weismanni, Microlepia hirta cristata, Croton Youngi, and Thrinax elegans being admirable examples. Mr. H. James, Castle Nursery, Lower Norwood, was third, his plants comprising fine specimens of Pandanus Veitchii 8 feet high, Thecophrasta imperialis 9 feet high, Cycas revoluta, and Stevensonsonia grandifolia.

FERNS.

Though not very numerous the specimens of these were very creditable, and were deservedly admired. Mr. Rann obtained the

leading prize for six plants with very vigorous examples of Gleichenia rupestris gigantea, Dicksonia antarctica 12 feet or more in height, Cyathea Burkei, Davallia Mooreana 7 feet in diameter, very strong and fresh, and Gleichenias rupestris and Mendeli. The second prize was awarded to Mr. Child for a beautiful collection, including grand specimens of Phlebodium aureum 5 feet in diameter, healthy and fresh; Davallia Mooreana 7 feet in diameter, in similar fine condition; Microlepia hirta cristata, wonderfully vigorous, 6 feet high and 8 feet or more in diameter—one of the finest specimens ever shown.

GROUPS.

A material addition to the attractions of the Show was formed by the groups of plants for effect. The first prize was obtained by Messrs. W. Fromow & Sons, Turnham Green, for a beautiful group of Aralias, Ferns, variegated Maples, Ferns and Lilies, with a groundwork of Stocks, Ferns, Caladiums, and Orchids. The second prize was obtained by Messrs. Hooper & Co. for a fine collection of Palms, Ferns, Crotons, and miscellaneous flowering plants, freely but effectively arranged. Messrs. W. Cutbush & Son, Highgate, were placed third with a highly effective group, a number of tall Cordylines, surrounded by Palms, and with hollows of Spiræas and mounds of Ericas. The second prize was awarded to Messrs. Hooper & Co. in the class for a group of hardy plants for good specimens of well-selected species of Trillium grandiflorum, Saxifraga Wallacei, Geum coccineum, Ranunculus aconitifolius fl.-pl., Aquilegias, and Funkias.

Hardy Flowers.—The first prize was awarded to Messrs. Hooper & Co., Covent Garden, for a pretty collection of hardy flowers, comprising Trillium grandiflorum, Trollius europæus, Allium album, Saxifraga granulata fl.-pl., several Irises, Veronicas, and Primulas. A fine box of Ixia craterioides, a bright rose-coloured form, was also shown and greatly admired.

Pansies.—For sixty blooms of fancy Pansies Messrs. R. B. Laird and Sons, Edinburgh, were first with handsome blooms of carefully selected and richly coloured varieties. Mr. H. Hooper, Bath, followed closely with a collection of similar merit, and Mr. W. Meddick, Bathwick, was third with richly coloured blooms.

Messrs. J. Laing & Co. were the only exhibitors of Tuberous Begonias in the class devoted to those plants, and were awarded the first prize for very strong healthy plants bearing a profusion of large flowers, and diversely coloured scarlet, rose, yellow, and white. The most notable varieties were Lothair, Hon. Mrs. Brassey, Golden Gem, yellow; Snowflake, and Delight, white; and Mrs. J. Freeman, pink.

VEITCH MEMORIAL PRIZES.

The special prizes of a medal and £5 offered by the Veitch Memorial Trustees for the best Orchid in the Exhibition was won by Mr. Child, the plant selected for the honour being the handsome Vanda suavis in the collection for which he was awarded the second prize. It had two fine leads 5 or 6 feet high, each with three large spikes of richly coloured flowers, and well merited the award. The prize for the best stove or greenhouse plant in the Show was given to Mr. Chapman for the beautiful Anthurium Schertzerianum in his first-prize collection of twelve. It was about 4 feet in diameter, and had about seventy spathes, large and richly coloured, though the plant appeared to be a little past its best.

MISCELLANEOUS.

Groups and collections of plants were very numerous, each possessing considerable interest. We cannot, however, particularise all their attractions, and a general outline will suffice to indicate the features of the display. Very prominent in the large marquee was a grand bank of Orchids and new plants from Mr. B. S. Williams, Upper Holloway, for which a silver-gilt Banksian medal was awarded. Both the plants and the style of arrangement were very satisfactory; the Orchids were flowering freely, and imparted a richness of colouring to the group, which was most pleasingly toned by the graceful Palms and Ferns associated with them.

Messrs. J. Laing & Co. contributed an extensive and beautiful group of stove and greenhouse flowering and fine-foliage plants. Ericas, Tuberous Begonias of many fine varieties, Crotons, Ferns, and a number of handsome new Caladiums constituted the chief portion of the collection, which was honoured with a silver Banksian medal. Mr. Anthony Waterer, Knap Hill, was awarded a silver Banksian medal for two large collections of hardy Azaleas, forming effective groups each side of the marquee near Mr. Turner's Roses.

Mr. C. Noble, Bagshot, was adjudged a silver Banksian medal for some well-grown specimen Clematises, not of gigantic proportions, but bearing numerous fine flowers, the varieties being very select.

Messrs. J. Carter & Co., High Holborn, exhibited two large groups of seedling Dracenas and Calceolarias, the former containing a number of handsome varieties, and the latter distinguished by the vigour of their foliage and the size of their flowers. For these silver and bronze Banksian medals were awarded. Messrs. Barr & Son, Covent Garden, were awarded a silver Banksian medal for two extensive collections of hardy flowers, including a fine selection of rare and choice species and varieties. A bronze Banksian medal was adjudged to Messrs. W. Fromow & Sons for a group of Rhododendrons. Silver medals were also awarded to Mr. C. Turner for a beautiful collection of Azaleas; to Mr. Bird, gardener to J. A. Causton, Esq., Lodgemere, Dulwich, for a group of well-grown and highly coloured Crotons; and to Messrs. W. Paul & Son, Waltham Cross, for ten boxes of exceedingly fine Rose blooms.

One of the most remarkable of the non-competing groups was that from J. T. Peacock, Esq., Sudbury House, Hammersmith, which consisted chiefly of Orchids, comprising Cattleyas, Dendrobiums, Odontoglossums, and Oncidiums in great variety and splendidly flowered, associated with Adiantums. Many choice varieties were included in this collection, and merit a fuller notice than can now be afforded them. A silver-gilt Banksian medal was awarded for it. Messrs. Jackson & Son showed a fine specimen of *Impatiens Sultani* about 4 feet high and as much in diameter, profusely flowered. A silver Banksian medal was awarded for the plant, and a similar honour was secured by Mr. McPherson, gardener to Lord Londesborough, for two enormous specimen *Marguerites* (*Chrysanthemum frutescens*) 6 feet in diameter. Other notable collections were stands of double and single *Pyrethrums*, including some very richly coloured varieties, also some very delicate in hue, and others pure white. Messrs. Collins Bros. & Gabriel, Waterloo Bridge Road, had some fine *Ranunculus* and *Anemone* blooms. Mr. Aldous, Gloucester Road, sent some stands of flowers for table decoration; and Mr. Sidney Williams, 23, Farringdon Road, a number of teak wood baskets for Orchids and similar plants.

FRUIT.

The competition was not remarkably keen, but in the principal classes the exhibits were of good quality and close in merit.

Black Grapes.—For three bunches of black Grapes Mr. W. Mowbray, gardener to the Earl of Leven and Melville, Fulmer, Slough, was a good first with Black Prince, well-coloured fine bunches. Mr. P. Edwards, gardener to Mrs. Tristram, Fowley, Liphook, Hants, was a close second also with Black Prince, finely coloured; Mr. Johnstone being third with Alwick Seedling, the bunches of moderate size but the colour good. There were three entries.

White Grapes.—Eight collections of three bunches of white Grapes were staged. Mr. Austen, Ashton Court, was first with Foster's Seedling, well-ripened bunches of good size. Mr. Miles was second with Foster's Seedling, even bunches, but rather green. Mr. Johnstone, gardener to the Marchioness of Camden, Bayham Abbey, Lamberhurst, was third with Buckland Sweetwater, good bunches and well coloured. Most of the others were green.

For three bunches of Black Hamburgh Grapes Mr. Loudon, gardener to T. Barnes, Esq., The Quinta, Chirk, was awarded the chief prize, also the Veitch Memorial prize, for the best three bunches of Grapes in the Show. They were large, well filled, the berries large, and the colour all that could be desired at this season. Mr. Austen was second with much smaller bunches but of good colour. Mr. Fyfe, gardener to W. F. Dick, Esq., Thames Ditton House, Thames Ditton, was third. Seven collections were staged.

Melons.—There were twelve entries in the open class for one fruit. Mr. C. Herrin, gardener to J. N. Hibbert, Esq., Chalfont Park, Bucks, was first with Hero of Lockinge, beautifully ripened and well netted. Mr. Johnstone was second with Suttons' Masterpiece, also fully ripened; Mr. Austen being third with Carters' Blenheim Orange, well netted.

Strawberries.—Mr. Goldsmith, The Gardens, Hollenden, Tonbridge, was first with President, large and grandly ripened; Mr. Mortimer was second with Sir Joseph Paxton, also even, large, and ripe; Mr. Hickie, gardener to W. Cunard, Esq., Lebanon House, Twickenham, being third with Sir Charles Napier, of good quality.

In the class for a dish of Cherries Mr. Miles was first with Black Circassian, and Mr. Hare, gardener to R. H. C. Nevile, Esq., Willingdon Hall, Grantham, second with Elton, both well ripened.

Peaches and Nectarines.—Eight dishes of Peaches were entered, Mr. Austen securing chief honours with Hale's Early, of fine colour. Mr. McIndoe, gardener to Sir J. Pease, Bart., Hutton Hall, Yorkshire, was second with Bellegarde, also fine; and Mr. Nash, gardener to Dr. Fuller, New Shoreham, Sussex, third with Early Rivers, large but very light-coloured.

Pine Apples.—In the open class for one fruit there were eight competitors. Mr. Coomber, gardener to J. A. Rolls, Esq., The Hendre, Monmouthshire, was first with Smooth Cayenne; Mr. Harris, gardener to Mrs. J. H. Vivian, Singleton, Swansea, second; and Mr. Goodacre, gardener to the Earl of Harrington, Elvaston Castle, Derby, third.

VEGETABLES.

Several good collections of these were staged, especially in the open class for ten kinds, four competitors entering. Mr. J. Austen, gardener to Sir G. Smythe, Bart., Ashton Court, Bristol, won chief honours with a beautiful collection, well set up, comprising fine Asparagus, Moore's Vegetable Cream Marrows, Hathaway's Excelsior Tomatoes, Victory of Manchester Cucumbers, Early Nantes Carrots, Leamington Broccoli, William I. Peas, Veitch's Ashleaf Potatoes, White Naples Onions, and Ne Plus Ultra Beans. Mr. Miles, gardener to Lord Carrington, Wycombe Abbey, High Wycombe, was a close second, his Stamfordian Tomatoes, Queen Onions, Asparagus, and Veitch's Favourite Cucumbers being first-rate. Mr. H. W. Ward, gardener to the Earl of Radnor, Longford Castle, Salisbury, was a good third.

Tomatoes.—Five dishes were staged in this class, Mr. Miles leading with Stamfordian, finely coloured and of good size, but not very even. Mr. Meads was second with Carter's Dedham Favourite, smaller, but even and of good colour. Mr. Austen was third with Hathaway's Excelsior, small but even.

Messrs. Sutton & Sons' Prizes.—There were nine entries in the class for a brace of Cucumbers, very even samples being shown. Mr. Mortimer was first with Purley Park Hero; Mr. Meads, gardener to Viscount Barrington, second with Suttons' Improved Telegraph; and Mr. Ward third with Tender and True.

Messrs. J. Carter & Co.'s Prizes.—The prizes offered for fruits of two varieties of Melons, Emerald and Blenheim Orange, were secured by Messrs. Ward; John Davis, gardener to Mrs. Wollaton, Elstree, Redhill, Surrey; J. Austen; and J. May, gardener to Capt. Le Blanc, Northam House, Barnet, all showing very good fruits well ripened.

Messrs. Hoper & Co.'s Prizes.—For two varieties of Peas three collections were staged, Mr. Ward being first with American Wonder and Earliest of All; Mr. Steggles, gardener to A. W. Green, Esq., Hadlow, Tonbridge, Kent, was second; and Mr. W. Fowle, Dogmersfield, Winchfield, was third.

IMPLEMENTS.

The whole of the available space outside the Exhibition marquee was devoted to the implements and garden structures, and this portion of the Exhibition proved as attractive to many visitors as that under canvas for a great variety of useful and ingenious appliances for facilitating garden labour. The brief time at our disposal will not admit of a full report of all the exhibits, and when we left the Show the whole of the awards had not been announced; some of the chief features can, however, be summarised in a few words.

Messrs. C. P. Kinnell & Co., 31, Bankside, Southwark, have a number of slow-combustion coil boilers, which are in various sizes, suitable for heating small conservatories; an open coil grate termed the Princess Louise Patent, which can be heated from an ordinary fire, being selected by the Judges in the class for the best mode of heating a small conservatory, and awarded a silver medal.

Mr. B. W. Warhurst, Highgate Road, N.W., has a large exhibit of boilers, twenty different forms being represented, including Ben's, the Monarch, the Imperial, Climax, Cruciform, Allerton Priory, and Gold Medal, all well-known boilers of proved merit. A new small saddle termed the London, suitable for building in the ends of greenhouses, was awarded the bronze medal in the class above mentioned. The chief advantage claimed for it is that it is economical, and the part does not get overheated. Garden seats, houses, frames, and a variety of useful articles were also included in this stand, and were adjudged a bronze medal in the class devoted to them. The seats are particularly strong and elegant in design.

The Thames Bank Iron Company, Upper Ground Street, London, E.C., exhibit a number of tubular and saddle boilers, and were awarded the silver medal in the class for boilers to heat 500 feet of 4-inch piping with or without brickwork. A 30-inch cast-iron boiler with side flues was the favourite; and the powerful horizontal boiler, which is capable of heating 3000 feet of 4-inch piping, was especially noteworthy. A special certificate of merit was awarded for a patent H-valve, with one valve for two pipes, which avoids the multiplication of valves that often prove a great annoyance. A gold medal was awarded to this firm for the general excellence of their collection.

Messrs. W. Richardson & Co., Darlington, contribute an extensive assortment of valves, piping, light frames, houses, &c. A silver Banksian medal was awarded for an improved throttle valve, which can be easily taken to pieces and cleaned, a cap being secured by screws. It is quite water-tight, and moreover cheap. A bronze Banksian medal was awarded for a light frame, in which the lights are swung on pivots about 2 inches from the top, so that in elevating the light the upper portion does not descend low in the frame or disturb the plants beneath. A bronze Banksian medal was also awarded for a well-built house with an ingenious system of lever ventilation, which takes the form of narrow sashes extending from the base to the apex of the roof. Samples of the Parisian blinds are noteworthy, their great merit being durability and lightness.

Messrs. Foster & Pearson, Beeston, Notts, have an interesting exhibit, including examples of various systems of ventilation, greenhouses, frames, and valves. Two silver Banksian medals were secured by this firm, one for strong but light frames with cap ventilation by means of a lever, and the other for a greenhouse in which the top ventilation being regulated by a screw, and the side ventilators by a lever—both extremely easy and efficient. A bronze medal was awarded for a useful valve, very similar in construction to that which secured the silver medal.

Messrs. W. & S. Deards, Harlow, show several houses and miscellaneous appliances, the former displaying various systems of glazing. A bronze Banksian medal was awarded for the Dry Victoria system, in which the glass is placed in zinc or copper grooves, a metal cap being screwed over the bars thoroughly securing the glass and preventing the admission of rain or the escape of heat; it is also easily removed in the event of the glass being broken.

Mr. J. Matthews, Weston-super-Mare, has a fine collection of ornamental pottery, garden statuary, edging tiles, &c., securing the silver medal in that class. Messrs. F. Rosher & Co., King's Road, Chelsea, also have an extensive assortment of tasteful edging tiles, for which the bronze medal was awarded, together with a silver medal for decorations for conservatories, ornamental flooring and flower stands.

Messrs. J. J. Thomas & Co., 362, Edgware Road, exhibit a fine collection of Rose temples, arbours, plant stands, arches, &c., in wirework, many being extremely beautiful, and well meriting the silver medal awarded for them. A novel galvanised iron scraper,

flat, with cross pieces of triangular stout bars, is worth notice, and is, no doubt, useful.

Messrs. J. Warner & Sons, Cripplegate, have an imposing collection of garden engines, pumps, syringes, fountains, water barrows, and other articles, all well executed, and meriting the silver medal awarded for them in that class. Mr. G. Knowles, Finsbury Pavement, E.C., were adjudged the bronze medal in the same class for a smaller but meritorious collection.

Mr. J. Deverill, High Street, Slough, has samples of his patent irrigators, a very ingenious and useful contrivance for watering lawns. It consists of pipes of various lengths, elevated on a wheel carriage, and furnished with jet and spray roses. It can be readily moved about, and would greatly facilitate watering. A special certificate was awarded for it.

Messrs. Lloyd, Lawrence, & Co., 34, Worship Street, E.C., show their Pennsylvania lawn mowers and boxes, and were awarded the silver medal in the class for hand mowers. The machines are constructed of various sizes, to cut from 10 to 18 inches in width, and can be fitted with box or not as desired.

Other exhibitors are Messrs. Follows & Bates, Dutton Street, Manchester, who have samples of several good lawn mowers, the Manchester, Anglo-American, and Climax being prominently noticeable. Messrs. Edgcombe Rendle, Victoria Street, have several houses and frames, showing their system of glazing without putty. Mr. B. Edgington, 2, Duke Street, London Bridge, has a large number of tents, marquees, shading materials, &c., obtaining the silver medal, the bronze medal in the same class being secured by Messrs. Unite, 291 & 293, Edgware Road, W., who have a large collection of table-blinds, netting, cordage, &c., and excellent examples of lawn tennis apparatus, for which a silver medal was adjudged. Messrs. T. Green and Son, Surrey Works, Blackfriars Road, have a number of their useful lawn edgers, garden rollers, lawn tennis markers, &c. Mr. W. Wells, Redhill, shows some of his spray-diffusers. The Pall Mall Lawn Edger Company, 15, Pall Mall, exhibit specimens of their patent lawn edgers, very useful and easily worked machines. Mr. A. T. Jenkins, Kimberworth, Rotherham, has a variety of articles, comprising boilers and pipes. Messrs. Deane & Co., 46, King William Street, E.C., show garden seats and tables of various designs. Mr. H. Lovegrove, Slough, has a number of ornamental rustic summer houses and garden seats; and Mr. G. Knowles, 72, Finsbury Pavement, E.C., has a stand of garden engines and syringes.

We may remind our readers that the Implement Show will be continued until June 21st, so that visitors will have ample opportunity of inspecting the exhibits.

COMMITTEES.

The work of the Committees was not very onerous, and was of short duration.

FRUIT COMMITTEE.—Harry J. Veitch, Esq., in the chair. The following were present:—Messrs. W. Paul, J. Willard, Thomas Laxton, G. Goldsmith, S. Lyon, A. Howcroft, Charles Silverlock, John Lee, George Bunyard, Phillip Crowley, Henry Webb, R. D. Blackmore, J. Burnett, and J. Woodbridge.

Votes of thanks were accorded to Mr. Ward, Longford Castle Gardens, Salisbury, for fine samples of Victoria Rhubarb; and for a dish of fruits of *Citrus medica* from the same garden a cultural commendation was awarded. This is a large-fruited Citron, pale yellow, somewhat like a large Lemon, fully 6 inches in diameter. A Melon was sent called Longford Castle Hybrid, but was passed, as was also one from Mr. Coysh, Newbold Revel, Rugby. Mr. Mortimer, gardener to Major Storer, Purley Park, Reading, was awarded a cultural commendation for fruits of Purley Park Hero Cucumber, which the Committee considered to be a good stock of Telegraph.

FLORAL COMMITTEE.—G. F. Wilson, Esq., in the chair. The following were present:—Messrs. G. Duffield, J. James, John Dominy, H. Ballantine, John Wills, Harry Turner, James McIntosh, James Cutbush, W. Bealby, H. Bennett, Rev. G. Henslow, W. B. Kellock, John Fraser, John Laing, H. Ridley, and H. Ebbage. A number of new plants were exhibited before the Floral Committee, and first-class certificates were awarded for several of the most distinct. Mr. B. S. Williams, Upper Holloway, had some very interesting plants, which were referred to the Scientific Committee, and others were certificated. The purple Epidendrum Frederici-Guilielmi, the rosy variety *Maxillaria Harrisonæ rosea*, and the small *Bulbophyllum psittaglossum*, with peculiar brownish yellow flowers, were especially notable. A vote of thanks was accorded to Messrs. Heath and Son of Cheltenham for plants of *Cattleya speciosissima*, with mauve sepals and petals, and a rich crimson lip; and a rose-tinted variety of *Odontoglossum Alexandræ*. A vote of thanks was accorded to G. F. Wilson, Esq., for a grand plant of *Utricularia montana* with about twenty spikes of flowers, and for flowers of *Odontoglossum Alexandræ* and other Orchids.

A cultural commendation was awarded to Mr. Wilson, gardener to H. M. Pollett, Esq., Fernside, Bickley, for a handsome plant of *Odontoglossum Halli magnificum*, the flowers being large and richly coloured. A cultural commendation was awarded to Messrs. Backhouse & Son, York, for a well-grown specimen of *Azalea rosæflora*, 2½ feet in diameter and beautifully flowered. A vote of thanks was accorded to H. J. Elwes, Esq., Preston, Cirencester, for a collection of *Polygonatum*s, comprising nine forms—*P. officinale*, *P. latifolium*,

P. giganteum, *P. bracteatum*, *P. punctatum*, *P. verticillatum*, *P. japonicum*, and *P. multiflorum*. A vote of thanks was accorded to Messrs. Carter & Co. for boxes of *Mimulus* Queen's Prize and Ruby, both beautiful varieties, with large heavily blotched flowers. Messrs. F. A. Sander & Co., St. Albans, sent a box of *Odontoglossum* blooms, chiefly forms of *O. crispum*, *O. Ruckerianum*, and *O. Andersonianum*. Messrs. Jackson & Son sent plants of a decorative *Pelargonium*, well flowered, Alfred Snell, a bright salmon scarlet variety. Messrs. J. Laing & Co. had some new Tuberos Begonias and a box of fine *Niphetos* Roscs.

First-class certificates were awarded for the following plants:—

Azalea Dr Hermann Wiegel (Turner).—A beautiful variety, with large double rich flowers, rosy scarlet in colour, and very freely produced.

Carnation Field Marshal (Turner).—One of the tree section, with full dark scarlet flowers of good form.

Philadelphus mexicanus (Walker).—A charming specimen of Mock Orange, with large rounded flowers, white, and exceedingly fragrant.

Begonia Prince of Wales (Laing).—A double form of Tuberos Begonia, the flowers very full, and intensely dark scarlet.

Begonia Dr. Duke (Laing).—Also double like the preceding, but of a lighter brighter scarlet hue. Very effective.

Cattleya nobilior (Linden).—A handsome variety, the flowers of great size; sepals, petals, and lip bright rosy crimson.

Iberis gibraltaria hybrida (Dean).—One of the finest of the Candy-tufts, the heads of white and purple-tinted flowers large. Habit dwarf.

Dendrobium Dearei (Sir Trevor Lawrence).—A very distinct and beautiful Dendrobe, the flowers pure white, in racemes of six to eight. The plant shown had three racemes near the apex of the growths.

SCIENTIFIC COMMITTEE.—Sir J. D. Hooker in the chair.

Tulips.—Mr. Loder exhibited a number of fine flowers of doubtful nomenclature. They were referred to Mr. Baker for identification. He also exhibited the following plants:—*Polemonium Richardsoni*—the true species is small, tufted, and a native of Arctic climes, but the present form has rather different foliage, is much larger, and with finer blossoms; *Ranunculus glacialis* from the Engadine, and cultivated by him; *Astragalus adsurgens*; and a Violet from America, perhaps *V. pedata*, the great majority of the seedlings of which are pure white.

Ixiolirion.—Mr. Elwes observed with reference to the *Ixiolirions* described at the last meeting, that Boissier maintained that *I. montanum* was not the same as *tartaricum*; that the true *Ledebourianum* has reddish flowers, was not a good botanical species, but horticulturally was very distinct. He thought that there were, however, three distinct species.

P. Nordmanniana Attacked by Coccus.—Mr. Maclachlan alluded to the specimen sent to the last meeting by Mr. Noble, and commented on the supposed winged form received from Mr. Noble. This, however, was a dipterous insect, unconnected with the injurious one.

Coccus on Orange.—He had transmitted the specimens to M. Signori of Paris, received from the Bahamas, who pronounced the *Coccus* to be a species of *Diaspis*, possibly new to science. The branches, covered with white scale, were attacked by the male, while the female made a blackish cocoon. Paraffin and milk as an emulsion was suggested as a remedy.

Polygonatum sp.—Mr. Elwes exhibited *P. multiflorum* var. *bracteatum*, *Kunth*, which he thought resembled an American form; *P. officinale*, which he considered like *P. japonicum*, the stem of which is remarkable for its angularity; and a pubescent form, possibly *P. latifolium*, as well as a Himalayan species, possibly *P. punctatum*, which he thought resembled *oppositifolium*; but he observed that *P. oppositifolium* is epiphytal in the Himalayas, though possibly in the western and drier parts it may be terrestrial and change its character. He also showed a specimen of *Streptopus roscus*, wrongly called *Disparum sinense* and *Uvularia sinense*.

Xiphion Fontanesii (?).—Mr. Elwes showed a blossom of this species, which was distinct from *X. tingitanum*. It is a very shy-flowering species unless the offshoots are removed and the bulb well nourished. Lastly, he exhibited a spike of *Ornithogalum lacetum*, as he thought it to be, a hardy plant with broad leaves and a flower stem 4 feet high. The above were referred to Kew.

Hybrid between Black Currant and Gooseberry.—Dr. Masters showed sprays of this hybrid, the female parent being the Black Currant, but the male is the Gooseberry. The anthers were perfect, but the pollen abortive. It was received from Mr. Culverwell of Thorpe Perrow.

Peach Leaves Diseased.—He showed Peach leaves with the well-known milky appearance, due to the separation of the epidermis from the underlying tissue. Many Plum orchards are being destroyed in Kent in the same manner. It is probably due to innutrition of the roots. Portugal Laurels suffer much in the same way on gravelly soil about Ealing and Isleworth.

Abies.—He brought sprays to show the different way in which the buds develop. In some years the terminal bud shoots first, in others it is the lateral which put out their leaves before the others. No law apparently exists which regulates the order. Sir J. Hooker said he had often observed a similar thing in *Terminalias* in the Himalayas.

Araucaria Seed.—Mr. Maclachlan asked if English seed proved fertile. It was generally thought that seedlings from cones produced in this country were not so hardy as native ones.

Jonesias?—Mr. Gumbleton exhibited two beautiful sprays of a Leguminous plant, one orange, the other red, of some hybrids between plants supposed to be allied to *Jonesia*. The parent plants were not sent, hence further information as to their origin was desirable.



KITCHEN GARDEN.

LATE Peas should be sown during the last days of May or early in June. As a rule the latest crops are not sown early enough to pod well before the cold nights of October set in, and this is the reason why there are so many failures with late Peas. In July, August, and throughout the hottest of the summer the pods form and fill quickly, and are soon over or too old for use; but this is not the case further on when the weather becomes colder, and late in September and during October we have had the pods hang in good condition for a fortnight or more. The ground for late Peas should be deeply dug, well manured, and be open and exposed to the sun. The rows of *Ne Plus Ultra*, which is one of the best, should not be closer than 12 feet apart. It is bad practice to crowd rows of Peas together at any season, but it is especially ruinous to the late crops.

Sow more Turnips, Spinach, Radish, Lettuce, and a small patch of Endive where this is valued in autumn. Chicory or Witloef should also be sown to supply roots for forcing in winter. Either of them may be grown well in any soil which will suit Carrots or Beetroot. There are no more useful salad plants in winter, and a small patch of the roots should be grown by all.

Many crops require earthing up now; we always prefer the fork to the hoe for this work. Early Potatoes should be earthed when the stems are about 6 inches high. Green tubers can only be avoided through this process. Peas are growing rapidly, and soon after they are through the ground they require earthing and then staking. Where stakes are scarce use the twigs of old brooms or anything to support them until the early Peas have been cleared from the ground, when the stakes now being used for them will come in for the later rows.

Spring-sown Spinach is one of the first crops to come off the soil, and as soon as this is over clear the ground, hoe and rake the surface, and plant it with Lettuce. Many spring-sown plants, such as Cabbages, Cauliflowers, and Brussels Sprouts, are now a large size in the seed beds, and the largest of them should be put out into their bearing quarters at once. We plant some between rows of early Potatoes, and find this both good and profitable practice. As spring Cabbages are cut do not take too many of the leaves with them, but allow as much of the stem to remain as possible for producing small heads in early autumn.

Attention must be given to thinning Beet, Parsnips, and other crops which are crowded. The thinnings of many may be transplanted elsewhere if needed in showery weather, but when this does not occur plant and water once afterwards. Do not thin Early Horn Carrots to any great extent until they are large enough for use, then they should be thinned out as they are wanted.

Potato frames are fast being cleared, and they are as quickly occupied with Vegetable Marrows and ridge Cucumbers, both of which are benefited by the shelter of a frame. Tomatoes under glass require going over almost every other day to stop and thin the shoots. Those which have been grown in pots for planting in the open air may be put out now. Against a south sunny wall is the only position where they will really succeed. Ordinary garden soil is not often good enough for them, and a small mound of loam and manure should be provided for each plant. They should be turned out of the pots without breaking the roots, and the shoots tacked to the wall from the first. There is no plant more easily propagated from cuttings than the Tomato, and where stock is deficient plants may be had much quicker from cuttings than seed. The same may be said of Cucumbers, as both root freely with the assistance of a little bottom heat. Three weeks ago we resolved to throw away our early spring plants of Cardiff Castle Cucumber, as they had been bearing a long time and were not so fruitful as younger plants, but, the variety being good and true, we shall keep it in hand from cuttings. These we took off and inserted at the time we name have now plenty of roots, and there are some small fruits formed on them too, although the plants are only in 3-inch pots, which proves this to be a much

better way of securing early-fruiting plants than by raising from seed.

FRUIT FORCING.

Figs.—In order to give the fruit every assistance growths that require any regulation should be attended to just before the fruit commences colouring, stopping all growths which require it, except the terminal shoots, which should run to the limit of the space allotted to them. The laterals, which will now need attention in this way, will be confined to subsequent growths proceeding from laterals which have previously been pinched, and many of which have fruit now in an advanced state of growth. These should be nipped off at the second or third leaf from the last break, continuing this procedure as it becomes necessary throughout the season. No fruit grown under glass is so much improved in quality by a proper course of treatment during the ripening process as the Fig. The borders having been properly watered as indicated in former calendars will contain sufficient moisture to dispense with further applications of water until the first crop of fruit has ripened, yet the mulching material must not be suffered to become dry, but be kept moist by damping when necessary in the early part of the day. To insure a circulation of warm dry air in the house by keeping the top ventilators open a little constantly, the heating medium will require to be kept regularly warm. The minimum temperature should be maintained at 65°, and 85° or 90° as a maximum from sun heat, with ventilation top and bottom. Sprinkling and syringing should be discontinued until the crop of fruit is gathered, then resume syringing for assisting the second crop. In later houses syringe the trees twice a day copiously to keep the atmosphere moist and red spider down.

Peaches and Nectarines.—When the fruit is cleared of the very early varieties in the earliest forced house all the wood that has borne fruit this season, and not being needed for the extension of the trees, should be cut out or to the shoot trained in from its base to form the bearing wood for another season. Syringe twice a day, but sufficiently early in the afternoon to allow of the trees becoming dry before nightfall. If the trees are crowded with wood thin it well out. It is no use expecting fine fruit when the shoots are crowded in the season preceding fruiting, as they will not ripen or plump the buds so as to insure a good set and proper development of the fruit. The shoots should not be closer together than a foot, better 15 to 18 inches apart, and they should be disposed that distance upon the main branches. Excepting the space be occupied, the shoots need not be stopped, as forced trees will ripen the wood and perfect the buds to the extremity of growth of several feet length. The inside borders must be well supplied with water, and weakly trees with liquid manure, so as to enable them to develop the buds for next year's crop. A temperature of 60° to 65° should be maintained by artificial means, and full air admitted over 75°. The trees in the house started early in the year are taking their last swelling, and should have copious waterings at the roots and a moist genial atmosphere to insure the fruit swelling to a good size. Maintain a temperature of 70° to 75° artificially by day, and 80° to 85° from sun heat. Shorten or remove any leaves overhanging the fruit, and any fruit not favourably disposed for receiving light should be raised to the light by laths across the wires of the trellis, so that the apex of the fruit may face the light. Discontinue syringing when the fruit commences ripening, but maintain a good moisture in the house by damping available surfaces two or three times a day, increasing the ventilation as the fruit approaches ripening. Tie and regulate the growths, and if there be any red spider promptly wash the trees with an insecticide, washing a few times afterwards with clear soft water to clean the fruit of any sediment. Regulate the growths in succession houses, and be careful not to allow more shoots to remain than is necessary for furnishing the trees. Overcrowding the growth and overcropping is the greatest evil in fruit culture. Thin the fruit, leaving on healthy trees a fruit to every square foot of surface covered by the trees. Mulch internal borders with short manure, watering copiously. Regulate and tie-in the shoots as they advance, stopping shoots retained to attract the sap to the fruit at a few joints of growth in the first instance, and afterwards to one as made.

PLANT HOUSES.

Azaleas.—Repotting these plants, as well as Heaths and Epacris, should now be brought to a close as rapidly as possible, in fact all the late batches should be attended to as they cease flowering. The former, after they are potted, must have every encouragement as regards warmth, shade, and moisture until their growth is completed. No better place can be afforded them than fruit houses, but failing this the house in which they

are grown should be kept closed for a time, and closed early in the afternoon while the sun is upon it, which will reduce fire heat to a minimum. Early-flowering Heaths, such as *E. hycmalis*, *E. melanthera*, and others, should now be growing freely, and more air must be given them from this time. The roots of *E. Wilmoreana* will now be active, and repotting where necessary must not be delayed. The same remark applies to *Epacris* that flowered late; in fact all that have fairly commenced growth should be repotted if they require it. Those that are growing freely must have sufficient air to prevent them growing weakly. Directions given about the potting and treatment afterwards is applicable at the present time. Do not overshadow these plants, and the material used must be as light as possible, or satisfactory results will not follow.

Zonal Pelargoniums.—Encourage all plants that have been flowering in the conservatory for some time, in fact all that have their pots full of roots, whether wanted for decoration or the supply of cut flowers. During the hottest part of the day light shade will be found beneficial; the single forms will not only last longer, but retain a brighter colour. Do not overshadow, or the plants will draw up weakly and not bloom satisfactorily. Successional batches that were potted some time ago can now be allowed to come into bloom to replace any that have become tall and unsightly. Grow all successional plants in full sunshine, and when favourable ventilate freely to keep them sturdy. Pinch the shoots of any plants not wanted to flower, and allow others to bloom as occasion may require. Those rooted some time ago for autumn and winter flowering should now be placed in 4-inch pots and have the points of the young plants taken out to make them branch freely. Keep these growing, and ventilate freely to render them sturdy after they have commenced rooting in the new compost.

The earliest of the Show and Fancy varieties will now be in flower and will require feeding liberally. The shoots of later plants must now be allowed to extend and come into flower as wanted. Plants that were rooted some time ago must now have 4 or 5-inch pots, and if not already stopped must be without delay. These will make acceptable plants, but must not be stopped too late or they will not flower well.

THE BEE-KEEPER.

MOVING BEES—SUBSTITUTE FOR POLLEN.

I HAVE been remodelling my apiary of late, and have added something to my limited stock of experience. The grounds occupied by my apiary becoming crowded and unsatisfactory, I selected a new site, and proceeded to erect suitable buildings on it. My bees were moved to their new location on the first few days in March. The distance of the move was about 240 feet, and the hives were closed at the entrances, and borne gently between two men. The days being cool, many of the colonies did not seem to arouse sufficiently to realise that they were being moved from their old home.

I now proceeded to carry out a long-cherished plan of mine—viz., get under my control, if possible, all the native and mixed bees within dangerous proximity to my "breeding field." I called on every person who owned a single colony within a reasonable distance of my location, and by accepting their terms, if I could not get my own, I succeeded in getting possession of every one of them but two, and they will be Italianised. There were twenty-five in all, and I now have them sitting as a sort of "suburb" to "Sweet City." A few of them are in Langstroth and American hives, and the rest of them—well, it would be a difficult matter to describe the utter squalidity of their villainous-looking habitations. For the present I have dubbed this part of the apiary with the title of "Old Africa." Their fighting qualities are good, and would "convert" a field full of advocates of black and degenerate hybrid bees. They will undergo a great change, however, as soon as the season will admit of it. Having moved my fifty colonies so short a distance, and gathered up all the bees near me, of course I felt some anxiety as to the results when the first warm day should come. The 9th of March brought with it nice warm weather, and the bees were on the wing all day. Every precaution was taken to induce the bees to "mark" their new location, and with good effect; for, although a great many returned to their old location, and gathered in knots on the fence and about the trees near where the hives had formerly been, they were all able to return to the newly-marked location, and there was no per-

ceptible loss of bees. The bees which were gathered from the country, even those colonies that were moved not more than a quarter or half mile, adhered to the new location without exception, so far as I could see or learn.

A modern apiary, with its buildings properly equipped with all the appliances necessary to a first-class apiary, and with a well-ordered queen-rearing department attached to it, is a wonderful curiosity to our farmers and business men, and with the many amusing questions with which I am plying, I sometimes wonder if these people do not entertain some suspicions that I am getting "cranky" on the bee question. I, in turn, reap some amusement from their benighted curiosity. Mr. James Bohannon, an old bee man, who is my assistant in the apiary this summer, and myself, have no little merriment over the ludicrous questions which we manage to answer pleasantly every day.

I have noticed this spring that our bees have sought with more than usual diligence for a substitute for pollen, and I have found, to me at least, a new and very superior substitute for that essential article to brood-rearing. Our stock breeders feed to their cattle, especially to milch cows at calving time, "oilcake meal." While feeding some of this glutinous meal to my milch cow, I noticed that the bees had passed the several boxes of unbolted wheat and rye flour, and were swarming in the trough where this oilcake meal had been fed. I at once took the hint, and mixed some of this meal with the unbolted flour in one of the several boxes which were being visited by the bees, and in a short time this box swarmed with a scrambling mass of workers, who loaded up and bore away their loads with the greatest eagerness. After trying it, I believe it to be the greatest stimulant, next to natural pollen, to early breeding yet discovered. And I further believe, from the medicinal qualities of the oilcake meal, it can be given to bees which have suffered from long confinement and dysenteric troubles, with the best of results. Of course I mean after they begin to fly in the spring of the year. I have long been of the opinion that the trouble called "spring dwindling" is caused by long confinement and consequent exhaustion of vital powers. Of course to restore such bees to health would lengthen their days.—G. W. DEMAREE (in *The American Bee Journal*).

TRADE CATALOGUES RECEIVED.

Corry, Soper, Fowler & Co., 18, Finsbury Street, London, E.C.
Illustrated List of Rustic Garden Furniture.



* * All correspondence should be directed either to "The Editor" or to "The Publisher." Letters addressed to Dr. Hogg or members of the staff often remain unopened unavoidably. We request that no one will write privately to any of our correspondents, as doing so subjects them to unjustifiable trouble and expense.

Correspondents should not mix up on the same sheet questions relating to Gardening and those on Poultry and Bee subjects, and should never send more than two or three questions at once. All articles intended for insertion should be written on one side of the paper only. We cannot reply to questions through the post, and we do not undertake to return rejected communications.

Budding Roses (*An Ayrshire Amateur*).—We are obliged by your letter, and glad to learn you have found our pages useful. We will endeavour to supply all the information you ask, and, in time to be of service, will publish an article that we hope will make the subject as clear as you desire.

Double Polyanthus (*A. H.*).—We are obliged by the plant. The variety is better than the other you sent, and is of decorative value; still we fear there is but little "money in it." It shall be added to our collection, and if it succeeds we shall be able to better determine its merits next year.

Vine Leaves Scorched (*S. C., Dorset*).—You have indicated one cause of the injury to the leaves, but the Vines are in a weak state. What are their age, and where are the roots? Not thickly penetrating a good feeding ground near the surface, we think. If you send full particulars we will endeavour to advise you.

Melon Roots Diseased (*W. J.*).—You will find the disease which is attacking your plants fully described and illustrated in our issue of November 3rd, 1881, and to that description we have nothing to add. We fear the disease is incurable. Certainly try "salus," and you might also try the remedies suggested to a correspondent in the last paragraph on page 393, our issue of three weeks ago. We shall be glad if you will inform us of the results of your experiments in endeavouring to save your plants.

Fuchsia Flowers Malformed (M).—The transformation of the sepals into leaf-like organs occasionally occurs not only in Fuchsias, but many other plants, and is regarded as simply a reversion to an original form. The sepals, petals, stamens, and even the pistil itself are regarded as metamorphosed leaves greatly altered to serve special purposes. In double flowers you see the reversion of stamens to petals, then the petals often assume a calyx-like aspect when this is green, and a still further alteration is observed in the specimen you sent, in which the sepals are becoming foliaceous. In some plants, as in Water Lilies, a gradual transition from one organ to another can often be seen.

Anisanthus splendens (M. D.).—This is a greenhouse Iridaceous plant from the Cape of Good Hope, and is usually increased by offsets. Sow the seeds in pots, pans, or boxes of soil composed of sand, loam, and peat in equal parts, to be watered well before sowing, and the seed covered its own thickness with fine soil, and then with squares of glass. A shaded position in a frame would be suitable, as the soil would not dry so rapidly as in a dry sunny house, and it must be kept constantly moist. When the seedlings appear remove the glass and assign them a position where they can have sun and air. When large enough they can be transplanted in other boxes, and eventually be placed singly in pots. A frame is a suitable place for growing them in summer, and they can be wintered in a greenhouse.

Value of Manures (H. W.).—Instead of £60 ammonia is valued now at £100 a ton more or less, but more rather than less lately. Soluble phosphate slightly under the sun you name, £24. Precipitated phosphate is valued at from £15 to £17 10s. per ton, and insoluble, when from mineral sources, not infrequently as low as £5; but chemists differ considerably, sometimes as much as £10, or even £12 10s., being allowed as its value. When in a very fine state it is better value even at the latter figure than is soluble, or rather "bone earth" made soluble, at £24 per ton.

Cucumbers Diseased (C. H. M., Hawkhurst).—We very much fear your Cucumbers are attacked with a disease that is almost incurable. If not, the exuding moisture is the result of gumming. This is usually caused by too rich soil, and the leaves cannot elaborate the abundant sap with which they are supplied. The remedy in this case firmer and poorer soil. If the plants are affected with the disease above mentioned you will have the greatest possible difficulty in eradicating it. We only know of one recorded instance of success in this, and that is by Mr. William Taylor, Loughleat, on page 423 of our last volume, the issue of November 9th, 1882, and you will do well to peruse that article. Mr. Harding, Orton Longueville Gardens, has found that the disease spreads the more rapidly under a low temperature, and that a distinct improvement followed on the temperature being raised 10°. We know of no book that gives "tables of analyses of the different fruits and flowers," nor are we at all sanguine that a knowledge of the chemical composition of the Cucumber would be of any real service to you. The only tabulated analysis at our command is by Dr. John, who found the fruit composed of the following ingredients:—

Water	97.13
Substance similar to fungin	0.53
Soluble vegetable albumen	0.13
Resin	0.04
Extractive with sugar	1.66
Mucus	
Phosphate of lime	
Phosphate of potash	
Phosphoric acid	
Ammoniacal salt	0.5
A malate	
Sulphate of potash	
Muriate of potash	
Phosphate of iron	
	100.0

Examine the roots of the plants and let us know if you find any tubercles on them. If you do not, and the disease of the fruit spreads, we shall be glad if you succeed in banishing it to hear of the method you have adopted, which we will publish for the benefit of others.

Thinning Fruit (F. J.).—All communications should be read intelligently. A moment's reflection will show you that a tree of Pitmaston Duchess or Baurré Die Pears cannot perfect half so many fruits as small varieties like Citron des Carmes; and again, a tree of any variety only moderately strong cannot support such a large crop as a vigorous tree can. If you have regard to the variety and the condition of the trees you will not err; but let the thinning be gradual, not completing until the fruits are swelling freely, and you are sure those finally retained will prosper. Mr. Young details sound practice, and has secured leading prizes at the best hardy fruit shows in the kingdom. Syringe the house as you suggest, provided the water does not contain much lime to leave a sediment on the foliage.

Begonia Davisii flore-pleno (G. T., Oporto).—The parcel which was packed on the 15th inst. reached us on the 21st, and the flower and leaf arrived in a very withered state; the former had, in fact, shaken in pieces, which were curled up like tea leaves, but of a different colour. The leaf was sufficiently fresh to enable us to perceive it is diseased, and it is in consequence of this and the corresponding check to the growth of the plant that the flowers have come malformed. It is not improbable that the tuber is unsound, but still there may be sufficient healthy roots to enable the plant under good management to produce healthy growth and properly developed flowers. We hope it may be so, as a well-grown example of this variety is very beautiful. Your plant will need to be watered with great care, and must not be kept in a house having a very hot and dry atmosphere.

Insects on Primroses, &c. (A. M. B.).—The specimen sent is not a beetle, but a species of woodlice (*Oniscus asellus*). It and others allied thereto are sometimes very troublesome about flower beds, also they are fond of infesting frames. Usually they feed at night, concealing themselves by day. When potatoes are tried as a trap, the best plan is to put some pieces of boiled potato into little pots and cover them with moss. Into these the woodlice eagerly creep, and they may be shaken out every morning. Or they have been trapped into this way: A slate is placed against a wall and another slate over it, slanted so as to leave a space between the two. Then the ground beneath is well watered (moisture being very attractive to these insects), and numbers will hide under the shelter of the outer slate. They have been kept out of frames by smearing the edges with some substance of powerful odour.

Rose-showing and Boxes (Practice).—We cannot give you a better reply than we have previously given to a correspondent as follows:—The blooms should be exhibited in boxes, the stems of the blooms being placed in tubes filled with water, the tubes being embedded in moss, the smoothest and freshest of which should form an emerald surface to display the blooms to the greatest advantage. Each bloom should be cut with as much foliage attached to the

stem as possible, but no leaves must be added. If the blooms are cut on the morning of the show they should be secured early and before the dew has evaporated from their petals. The moss in the box must be moist, and the blooms should be arranged so as to stand a few inches above it. Many new beginners spoil their boxes by pressing the blooms close down on the moss. The boxes should have lids which, especially on sunny mornings, must be kept over the blooms until the last possible moment before the judges enter the show. We have known many prizes lost and Roses spoiled by the blooms being exposed too early and too long. The boxes should be 18 inches wide, 6 inches high at the back, and 4 inches in the front. The length of the boxes should be, for twenty-four Roses, 4 feet; eighteen Roses, 3 feet; twelve Roses, 2 feet 2 inches; and six Roses, 1 foot 6 inches; the covers being 7½ inches in depth at the back, and 5 inches in front, 4 feet 1 inch in length, 1 foot 7 inches in breadth, and having a narrow heading within the four sides, half an inch from the bottom of the lid, overlap the boxes, leaving ample room for the Roses, and are secured for travelling by stout leather straps.

Exhibiting Auriculas (Idem).—Seedling Auriculas equal in merit to named varieties would not be prejudiced in competition because they were seedlings; but you would be extraordinarily fortunate if you could stage seedlings of equal merit with the best named varieties. For a schedule of the National Auricula Society's Show, southern section, write to Mr. Douglas, The Gardens, Great Gearies, Ilford.

Span-roof Pit (Trike).—The cheapest house for your purpose is a sunken pit having a passage along the centre, a flat stage on one side with hot-water pipes beneath it, and a shallow trench on the other side for the Cucumbers. Let the building run north and south, and remember that the lower in reason you sink your passage the cheaper will be your building. With the floor of the passage 3 feet below the surface, side walls a foot high, with the ridge 3 feet 6 inches above the level of the eaves, or 7 feet 6 inches above the passage floor, would answer very well, and the roof angle would be suitable for summer Cucumbers. Head-room has, however, to be considered, and as the trellis for the Cucumbers must be a foot from the glass, that will be your guide as to the height of the roof and depth of the passage. Both the retaining walls of the passage and the outer walls need only be of 4½-inch brickwork. The passage need not be more than 2 feet wide, and the side spaces for the plants each 3 feet, or a total internal width of 8 feet. The glass should be 21-oz. seconds, and the panes 20 inches by 12, which is a useful trade size to which we give preference. No side lights are necessary. Ventilate by means of a flap a foot wide along the west side of the ridge. Make the flap to lift by means of simple levers, perforated with holes to slip on an iron pin attached to the roof close to the bottom of the opening. The kind of boiler you mention will answer very well, only take care that its size is in proportion to the piping, of which there should be three rows of 4 inch, with a valve to shut off heat from the cool end, the boiler being of course at the warm end of the pit.

Mushrooms without Manure (Dr. Mackenzie).—As you will perceive in another column, Mr. Smith, a new cultivator near Liverpool, grew 800 lbs. of Mushrooms in a vinery and another structure. Without doubt a valuable crop might be produced in your large house if the instructions in the treatise you have obtained are followed and the beds made to commence bearing about December, not in May or June. You refer to "comparative failures" of some beds in June in Mr. Barter's grounds. The season is practically over in June, and as some tons of Mushrooms had been produced by the beds before you saw them, the "failures" were not very serious. You think you can improve on the system of culture indicated. By all means make the experiment, and if you succeed you will benefit yourself and others. You ask why you may not have such a bed as you describe—a hollow ridge heated from below with gas. You may have it, but we doubt if you will have any Mushrooms, and certainly not if the heat is dry, as it must be by your plan. By all means try it, and surprise the world by your success. It would not be quite fair to detract from your merits as an inventor to suggest a means of carrying out your project, as then, in case of a grand result, the honour would not be wholly your own, but divided.

Forcing Lilacs (H. S.).—The Lilac referred to in your note is a variety known as Charles X., which is the best we know for forcing purposes, whether required white or of its natural colour. When forced quickly in brisk heat it is of a very light colour, and this natural tendency renders it very suitable for forcing in the dark. It can be produced nearly white if placed in strong heat in a pit and mats spread over the lights; but to have it pure white as you have seen in the markets it must be forced into bloom in total darkness. The white variety of the Lilac is much more delicate than the one above mentioned, and when forced it has a tendency to be of a greenish yellow hue, and in addition the flowers are apt to damp, and when they keep fresh are inclined to have a dirty appearance. These small bushy plants are produced by means of budding and grafting. Any strong-growing variety will answer for the stock, which can be readily produced either from cuttings or suckers. If cuttings are employed and these disbudded, the roots, as soon as they attain any strength or size, will produce suckers in abundance, by which means stocks can also be raised. Budding can be performed low on the stocks similar to that practised in the cultivation of Apples or Pears. They can also be grafted like them, but earlier in the season, as the Lilac commences growth very early. They can also be worked by employing for the scion green wood, which quickly and readily unites to young wood of the same age and strength; but to accomplish this a close well-shaded house or frame is essential. Budding when the stocks and buds are ready, and grafting when the sap has commenced to rise, are decidedly the best methods of raising these bushes. They are not produced so as to flower freely in one season, as the stocks have to be raised and grown until they are strong enough for working. After the stocks have been budded the bushes are not ready for forcing for two years. If grafted in spring they might with the more genial weather of the continent than we have here be ready for forcing the same autumn. Those sent over from the continent annually and sold by nurserymen are not produced in one year, for many of them show signs of having been severely pruned. But this cutting-back is essential, as the Lilac flowers from the wood made and buds matured during the previous summer. These little bushes have generally been established in pots and purposely prepared for forcing before they are sent to this country. Undoubtedly the best plan is to purchase a stock of plants ready worked, especially for those initiated with the system of producing them, and then by pruning them hard back annually, potting when necessary, and liberal feeding, very satisfactory results may be obtained from year to year. It is wise to have twice as many plants as are required to produce the annual supply, and force them every alternate year. Those required for next winter's forcing should be plunged amongst ashes or other material, their growths having been cut back early, watering and feeding to be attended to when necessary. If planted out in your district these young vigorous plants would probably grow too strongly, and not ripen their wood and mature their buds sufficiently to flower well; hence the advisability of keeping them in pots, which compels them to make short

sturdy growth, which has every chance of thoroughly ripening. In a sunnier climate they succeed planted out.

Grapes Shanking (H. T. H.).—We have read your letter attentively, but we could not answer it last week, the pressure during a few days immediately preceding publication being very great. It is not at all unusual for Grapes to shank just before they ought to ripen, this being usually caused by overcropping, defective root-action, or insufficient or unsuitable nourishment, but is very uncommon for the stems to decay so early as your bunches have done. You do not state the temperature you have maintained, and we can only suggest it has been too low and the house too damp, while it is not improbable the wood was not well ripened last year. The white specks on the leaves are not mildew, nor have they been caused by insects. They are the result of drip from the roof—a circumstance which suggests that your house has been kept too cold and damp, hence the condensation of moisture. If your Vine border is rich a surface dressing of lime, making the soil quite white, and very lightly pointed in or covered with other soil would probably be beneficial, and would certainly do no harm. Read what Mr. Witherspoon says on page 420; he is a most successful cultivator.

Names of Plants (J. H.).—1, *Stellaria nemorum*, Great Wood Stitchwort; 2, *Stellaria Holostea*, Hedge Stitchwort; 3, *Chrysosplenium oppositifolium*, Opposite-leaved Golden Saxifrage; 4, *Grum rivale*, Water Avens; 5, *Mercurialis perennis*, Dog Mercury (male plant); 6, *Adoxa moschatellina*, Tuberos-rooted Moschatel; 7, *Myrrhis odorata*, Sweet Cicely. Mosses: 1, *Mnium punctatum*, Dotted-leaved Thread Moss; 2 and 3, *Plagiothecium elegans*, Elegant Feather Moss. (E.).—The yellow flower is *Forsythia viridissima*, the scarlet *Fuchsia splendens*, and the white one *Atragene ochotensis*. (F. H. E.).—1, *Begonia parviflora*; 2, *Begonia weltoniensis*; 3, *Adiantum Capillus-Veneris*; 4, *Begonia seuperflorens*; 5, *Coleus Duchesi* of Edinburgh; 6, *Davallia bullata*. (Subscriber).—The Orchid is *Saccolabium giganteum*, and the red flower *Ixia crateroides*. (T. R.)—*Ixia viridiflora*, a native of the Cape of Good Hope, and introduced in 1780.

* * * Replies to some other letters in hand will be answered next week.

Feeding Bees (B. B.).—Your bees ought not to require feeding at all now fruit blossom is so plentiful and the weather fine. They will store the syrup you give them readily enough, but the honey from it will be very inferior to that gathered from the flowers. When the bees swarm place the hive on a new stand and let the old hive remain where it is.

COVENT GARDEN MARKET.—MAY 23RD.

A GREAT improvement in the business of the past week has hardened prices generally. Grapes alone have fallen.

FRUIT.

	s. d.	s. d.		s. d.	s. d.
Apples.....	½ sieve	2 0 to 7 0	Grapes	lb. 3 0 to 6 0	
".....	per barrel	20 0 40 0	Lemons.....	case	10 0 20 0
Apricots.....	doz.	0 0 0 0	Nectarines.....	dozen	0 0 0 0
Cherries.....	½ sieve	0 0 0 0	Oranges	100	6 0 10 0
Chestnuts.....	bushel	10 0 12 0	Peaches	dozen	18 0 21 0
Currants, Black..	½ sieve	0 0 0 0	Pears, kitchen ..	dozen	0 0 0 0
" Red.....	½ sieve	0 0 0 0	dessert	dozen	0 0 0 0
Figs.....	dozen	0 0 0 0	Pine Apples, English	lb.	2 0 3 6
Filberts.....	lb.	0 0 0 0	Raspberries	lb.	0 0 0 0
Cobs.....	100 lb.	0 0 0 0	Strawberries	lb.	4 0 6 0
Gooseberries	½ sieve	0 0 0 0			

VEGETABLES.

	s. d.	s. d.		s. d.	s. d.
Artichokes.....	dozen	2 0 to 4 0	Mushrooms	punnet	1 0 to 1 6
Asparagus, English	bundle	3 0 6 0	Mustard & Cress ..	punnet	0 2 0 3
Asparagus, French	bundle	2 0 10 0	Onions.....	bushel	2 6 3 6
Beans, Kidney	100	2 0 0 0	Parsley.....	doz. bunches	3 0 4 0
Beet, Red.....	dozen	1 0 2 0	Parsnips	dozen	1 0 2 0
Broccoli	bundle	0 9 1 6	Peas	quart	3 6 0 0
Cabbage	dozen	0 6 1 0	Potatoes, New	lb.	0 4 0 10
Capsicums.....	100	1 6 2 0	Potatoes	cwt.	6 0 10 0
Carrots	bunch	0 4 0 0	Kidney.....	cwt.	6 0 10 0
Cauliflowers.....	dozen	2 0 3 0	Radishes.....	doz. bunches	1 0 0 0
Celery	bundle	1 6 2 0	Rhubarb.....	bundle	0 4 0 0
Coleworts.....	doz. bunches	2 0 4 0	Salsafy.....	bundle	1 0 0 0
Cucumbers.....	each	0 4 0 0	Scorzonera	bundle	1 6 0 0
Endive.....	dozen	1 0 2 0	Seakale	basket	1 0 2 0
Fennel.....	bunch	0 3 0 0	Shallots.....	lb.	0 3 0 0
Herbs	bunch	0 2 0 0	Spinach	bushel	5 0 6 0
Leeks.....	bunch	0 3 0 4	Tomatoes	lb.	1 6 2 0
Lettuces	dozen	1 3 2 0	Turnips	bunch	0 2 0 3



POULTRY AND PIGEON CHRONICLE.

HAY-SAVING BY MACHINERY.

THE saving of hay by the best known means under the influence of the atmosphere alone was treated of by us in this Journal in the month of June, 1878, under the heading of "Hay-making" (Field Hay), and in the following July

again under the heading of "Making Pasture and Meadow Hay." There has, however, since that period been various means advocated for the making of hay without entirely depending upon the weather for that purpose. We notice first that Mr. Neilson has advocated the securing of hay by the means of exhaustion of heat from the ricks after being made and built of a certain size and under particular conditions. Mr. Wm. Gibbs has also advised the use of steam power for drying the hay artificially, or rather by the heat produced by steam. Another machine made by J. H. Ladd & Co., driven by steam, is called the "Perpetual" Press for baling hay by compressing and binding in bales. There are one or two other ideas started connected with the hay-saving process which are comparatively unimportant. It is incumbent on us, after the subject of ensilage has been treated of in this Journal so recently, to take up the subject of saving and securing hay to be made fit for use as dry fodder; for whatever advantages we may admit to belong to ensilage, we still feel the necessity that the home farmer requires dry fodder, not only as being more portable and better adapted for use in gentlemen's stables, but also because it is specially suitable for sale and carriage into the towns and distances by railway as compared with ensilage.

We will consider first the plan or system of hay-drying or cooling by the use of the exhausting-of-heat fan, the first public exhibition of which took place under the auspices of the Bath and West of England Agricultural Society at their meeting at Cardiff on the 22nd of May, 1882. The material selected for the trial of the experiment by the use of Mr. Phillip's exhausting fan was taken from a field of Clover and Ryegrass, the grass being stacked on the 22nd and 23rd of May, but the weather continued to be most adverse, through rain occurring more or less nearly every day up to the 28th of May, which was the opening day of the Show; and as many persons had come especially to see the apparatus in action, the Clover and Ryegrass, although it was certainly not fit to put together in accordance with Mr. Neilson's experience and former notoriety upon the subject. It was, however, decided to form a stack about 20 feet square, which was made under a shed in the show-yard. The shed was of sufficient length to contain several stacks. A line of 9-inch glazed earthenware pipes was laid beneath the surface of the ground along the central line of the shed, with dampers to regulate the draught from the centre of each stack. In the centre of the stack and over a damper a vertical air-chamber was formed about 2 feet in diameter by raising a stuffed sack as the work advanced. This was carried up to about the height of 13 feet, when it was closed by topping the rick. Iron tubes were placed in the sides of the stack towards the air-chamber for the insertion of thermometers. The temperature began to rise whilst the stack was being finished, and the hand-power exhaust fan was set to work for a short time, which checked the increase. On the 30th of May the steam-driven fan in three hours reduced by 52° the rapidly rising temperature of the stack, the steam and hand fan each being used occasionally, but daily, until June 14th. No record of temperature, however, was kept after that date. On the 15th of September the stack was cut, when it was seen that the central air chamber was reduced from 13 feet to 5 feet in height. The effects of overheating were very apparent; a zone of moist discoloured material, unfit for use, extended round the lower portion of the stack, but white streaks of mould were apparent at intervals to a height of 8 feet from the ground, above which the hay was fairly good. The hay has since been sold for £40, being about 47s. per ton. Besides the fact that the Clover and Rye Grass were unripe, sappy, and saturated with rain water, it was also unfortunate, that owing to the desirability of beginning to stack not later than the first morning of the Show, the material

at the lower portion of the stack was in the worst condition, and settled so rapidly into a compact and almost solid mass, which prevented any appreciable current of air passing through it.

This rick as to condition of the hay when stacked was exactly the reverse of that which Mr. Neilson has always stated as required by his system, for we find that a letter of his was written to the *Field*, dated March 4th, 1882, as he says, "In order to prevent disappointment that would follow too hasty an adoption of the system, without that care and attention which anything worth having ought to receive," Mr. Neilson, it is further stated, very differently from some of his so-called disciples, used all his great experience to get his grass as nearly as possible made into hay before taking it to the stack. He specially urges on those who wish to be successful in using his system the necessity of caution, and of not attempting too much, for he would himself only put his hay together damp when there was probability of its being damaged by further exposure in the field, and that he had always before stacking employed in the field horse labour to convert the grass as far as possible into hay. We make no doubt that his using of the word damp by no means can be considered as being wet with rain, but simply from being affected by the atmosphere when gloomy and threatening rain. All the causes which Mr. Neilson believes to have contributed to the failure were present in the stack at Cardiff, and in addition to these the crop was not ripe when cut. It was not, therefore, to be expected that a favourable result could be obtained; but the Society was pledged to show in the best manner it could the operation of the fans, which persons had come to witness at the Show, and so the stack was prematurely made. The experiment, however, disproves the statement that hay may be made and harvested in continuous rainy weather, but it should nevertheless encourage farmers to avail themselves of an economical means of securing hay in dangerous weather by the safe stacking of hay a day or two before it would be otherwise ready, thus saving the cost of labour in the field and the risk of serious damage by longer exposure.

(To be continued.)

WORK ON THE HOME FARM.

Horse Labour.—Mangold seeding is now nearly concluded. Some of the earliest sown will require to be horse-hoed between the stiches. The sooner the better, for the hand-hoeing and singling the plants may be deferred. Even if the young plants are very thick they will grow the faster whilst in the early stages of growth, and particularly in those cases where the seed has been hand-dibbled. In either case the singling being deferred for a short time shows the strongest or master plants, for it is these that it is so desirable to retain, as these by a rule are sure to make the best growth afterwards, and grow out of the way of enemies like grub and wireworm. These are the only dangerous enemies to the plants just after singling. Miss E. A. Ormerod, the consulting entomologist to the Royal Agricultural Society, in the last Journal of the Society has furnished much information relating to both the brown grub and wireworm. Our experience in the former case of grub is that they cannot be destroyed with economy; but to prevent them from eating our young roots is one of the best and most economical methods of avoiding damage by them, and we can do this by not singling the plants too early; and if the plants are left double in the numbers required, they may be set out at correct distances at the second hoeing. This, in our opinion, is scarcely ever done soon enough after the first hoeing for other reasons besides the attacks of the grub, because the weeds are more easily destroyed which may have escaped during the first hand-hoeing, and are also more easily seen before they are hidden by the luxuriant growth of the leaves. Hand-picking the grubs by women and boys has been resorted to, but it is a costly affair and takes time, for we have seen a whole field of Carrots totally destroyed and eaten off at the root before the grubs could be picked up; therefore we find the only security against injury by grubs is to allow the plants to remain longer before the first singling, and then leave them double in numbers in order to give the grubs more than they can eat, and thus save enough of either Carrots, Mangolds, or Swedes for a crop. Referring to the wireworms we do not believe in destroying them in the field without hand-picking and carrying them away, which is slow work and costly. The way, however, we got rid of wireworms perhaps stands alone in its practical results, for on our farm whilst cultivated on the four-course system whenever a dry time occurred our crops were seriously injured either of Wheat, Lent corn, or Peas; but after we adopted Potato cultivation in 1840 we never suffered from them, for they are very fond of burying or eating their way into the Potato tubers, and in this way they were almost entirely removed from the farm. We always arranged to have the Potatoes bagged as fast as they were dug up, by which means none were left, at any rate for a period of nearly thirty-six years after, for we never had any crop injured, nor did the workpeople notice any at the time of hoeing the crops, or in the act of cultivation after the Potatoes had been cultivated in every field which was done in due course.

Hand Labour has received but little hindrance; for although some rainy days have occurred, the men, and women too, have been employed at the homestead—some in the manure house breaking down the guano, sifting, screening, and mixing manures of all sorts and ashes in readiness for drilling with root seeds, and bagged up ready for use when wanted.

PRESENTATION TO THE SECRETARY OF THE BATH AND WEST OF ENGLAND SOCIETY AND SOUTHERN COUNTIES ASSOCIATION.—At the anniversary dinner of the Oxfordshire Agricultural Society, held in the Show Yard at Bicester, on the 14th inst., opportunity was taken to present the late Secretary, Mr. Thos. F. Plowman, who is now Secretary of the Bath and West of England Society and Southern Counties Association, with an illuminated address and a purse of 120 guineas. The address, which was beautifully illuminated, stated that the testimonial was presented "in recognition of the great zeal and ability displayed by him during his fifteen years' tenure of the office of Secretary." In order to make the testimonial as representative as possible the individual subscriptions were limited in amount, and among the names appended to the address were those of the Duke of Marlborough, K.G., the Earls of Jersey, Macclesfield, Ducie, and Effingham, Lord Camoys, Lord R. Churchill, M.P., Viscount Valentia, the Right Hon. J. W. Henley, Mr. A. Brassey, President; Colonel North, M.P., Mr. W. C. Cartwright, M.P., Mr. E. W. Harcourt, M.P., Mr. B. Samuelson, M.P., Mr. J. Walter, M.P., Col. Sir R. Loyd-Lindsay, V.C., M.P., Sir H. W. Dashwood, Bart., Sir W. Throckmorton, Bart., Mr. G. H. Morrell, Mr. J. Druce, Mr. A. Milton-Druce, Mr. M. Savidge, and most of the leading landowners and farmers of the district. The presentation was made in graceful terms by the Earl of Jersey, and Mr. Plowman, who was enthusiastically received, suitably responded. The staff of the *Oxford Journal*, of which Mr. Plowman, until his appointment at Bath, was the Editor, had previously presented him with an address in which they regretted the severance of his connection with the paper, and thanked him for his kindness and courtesy. Accompanying this was an oak inkstand handsomely mounted in silver.—(*Bath Journal*.)

OUR LETTER BOX.

Soot for Potatoes (A. G.).—A dressing of soot, especially in rather strong and unfertile soil, is an excellent manure for Potatoes. The ground may be made quite black with it, and it is best applied in damp weather.

Barren Pasture (H. G. Mansfield).—Your pasture land, it appears, does not respond to an application of lime or manure of any kind. It must be a compact conglomeration of clay and gravel, which will probably prove completely sterile, like a rock, unless it is broken up. This might enable the grass to take root more deeply in the soil, and by that means become productive through the action of lime and manures. You do not say what is the extent of the barren part, but at any rate it should be dug 12 or 15 inches in depth, or broken by ploughing and subsoiling. In doing this, chalk, lime, or limestone grit should, together with sand or loamy soil, be mixed well together in the act of tillage. If the land is pared and burned as a first operation so much the better. After being broken, if cultivated and set with Potatoes for one year before being laid down again, the land would be greatly benefited by exposure to the atmosphere, and this, together with manure applied, would eventually give soil enough to produce full crops of grass if properly seeded.

METEOROLOGICAL OBSERVATIONS.

CAMDEN SQUARE, LONDON.

Lat. 51° 32' 40" N.; Long. 0° 8' 0" W.; Altitude, 111 feet.

DATE.	9 A.M.					IN THE DAY.				Rain
	Barometer at sea level	Hygrometer.		Direction of Wind.	Temp. of Soil at 1 foot.	Shade Temperature.		Radiation Temperature.		
		Dry.	Wet.			Max.	Min.	In sun.	On grass.	
1883.	Inches.	deg.	deg.	deg.	deg.	deg.	deg.	deg.	deg.	In.
May.										
Sun. 13	29.992	57.2	52.5	S.W.	47.6	70.4	50.6	111.3	49.7	—
Mon. 14	29.927	58.1	51.6	W.	50.4	64.5	52.0	81.0	49.0	0.086
Tues. 15	30.095	61.1	56.2	N.	51.0	68.5	51.4	105.8	49.6	—
Wed. 16	30.392	63.6	58.0	N.	52.0	75.5	49.5	118.8	44.4	—
Thurs. 17	30.404	59.0	52.1	N.E.	54.0	69.3	45.7	105.4	42.4	—
Friday 18	30.277	56.9	48.1	N.	54.4	64.2	48.4	105.6	45.0	—
Satur. 19	30.012	53.6	49.0	N.W.	54.8	63.1	49.2	105.8	44.7	—
	30.148	58.5	52.9		52.0	67.9	49.5	104.8	46.4	0.086

REMARKS.

13th.—Fine, bright, and warm.

14th.—Overcast, slight rain at intervals; heavy rain for short time in evening.

15th.—Fine and calm, overcast at times.

16th.—Very fine, bright warm day; moonlight night.

17th.—Fine; overcast at times.

18th.—Fine, with cool wind, and occasionally cloudy.

19th.—Fine, overcast at times.

A very fine and rather warm week, Sunday and Wednesday being especially agreeable and fine.—G. J. SYMONS.



31st	TH	Royal Society at 4.30 P.M.
1st	F	
2nd	S	National Tulip Show at Manchester.
3rd	SUN	2ND SUNDAY AFTER TRINITY.
4th	M	
5th	TU	
6th	W	

BOUGAINVILLEA SPECTABILIS.

TO see this plant in flower is rather the exception than the rule, whereas with *B. glabra* the contrary may be said to be the case, and owing to this fact the latter species is more frequently met with, although in some points it is greatly inferior to the former—notably in depth of colour of the bracts and brilliancy of the flowers. Many good gardeners will frankly admit having found their master in *B. spectabilis*, and that, do what they will, they have hitherto been unable to induce it to flower; and the consequent result has been they have thrown to the rubbish heap whatever plants they may have had of it, at the same time feeling sure that it either requires some peculiar treatment or that it very rarely flowers out of its native country. To entertain such ideas as these is to labour under a delusion which may be easily dispelled if in the future they will give the right treatment. From the success I have had in flowering it annually in pots, the undermentioned details respecting our *modus operandi* may not be unacceptable, and if carried out strictly to the letter success will be the ultimate result. At the present time it is in flower with us, and for nearly three weeks has been quite a picture; indeed, from the time the bracts begin to assume their crimson tinge until the flowers are open it is an object of great interest and beauty.

After flowering, or say from the middle to the end of May, cut out all weak and spindly growth, and prune back all the strongest shoots to within an inch of their base. Reduce the roots of the plants by shaking out a portion of the old soil and cutting back a few of the strongest roots. Repot in a compost consisting of as near as follows: two parts fibry peat, one of loam, and one part sharp silver sand, adding thereto a dash of bonemeal, together with broken potsherds and small pieces of charcoal, which will keep the soil porous and allow the water to pass through freely. Use plenty of drainage material; at the same time place over it a layer of moss or of turf from which all the loose soil has been previously shaken out. As the work of potting proceeds ram down the soil moderately firm, and let the compost near the top of the pot slope down from an inch below the rim of the pot to the base or collar of the plant, the latter being, when grown in large pots, about 2 inches below the rim, and proportionately less in smaller ones. By adopting this plan, instead of allowing the collar of the plant to be somewhat higher than the surrounding soil, there is one great advantage gained—viz., the water percolates

through the old ball and does not, as is oftentimes the case, turn the fresh compost sour before the new roots pass into it.

After potting place the plant in a moist temperature of about 60°, syringe several times daily, and when the young shoots are an inch long disbud rather freely, leaving only the very strongest, the number of course being regulated according to the size of each individual plant. On no account must the remaining shoots during the growing season be pinched back; this would almost be fatal to their flowering the following spring, but allow them to grow out their entire length and expose to the full glare of the sun. As the pots become full of roots copious supplies of water must be given, and on all favourable occasions ventilate with no unsparing hand, for in strong well-ripened wood lies the whole secret of success, so to speak. In the autumn, or as soon as it is seen the plants have completed their season's growth, gradually withhold water, and for about two months in midwinter keep them in a cool place where the temperature does not exceed 45° or 50°, during which time little or no water will be required. In February the plants may be encouraged to make a fresh start by placing them in a higher temperature. Cut back the points of all shoots about 6 inches, and stake and tie down to the required form. Give the plants a good soaking by immersing them in a tank of water for an hour or two, afterwards top-dress with decayed manure. The only further attention which is necessary till the plants come into flower is to syringe two or three times daily and give water when requisite, employing weak liquid manure when the bracts appear. In conclusion, let me impress upon the minds of those who would wish to succeed in flowering this grand plant that there are three points which they must keep in view, otherwise failure will be the result. The points alluded to are strong growths, well-ripened wood, and complete rest during the winter months.—
ET CÆTERA.

SULPHATE OF AMMONIA FOR VEGETABLES.

A DRESSING of sulphate of ammonia given during the summer months to vegetables in free growth has a wonderful effect in advancing most crops. The present is a good time to dress such crops as Onions, both spring-planted and spring-sown. Cauliflowers may also be assisted in the same way. Any young seedlings of the Cabbage tribe which may be in a backward condition are forwarded rapidly by a dressing, which in dry weather should be preceded and followed by a watering, which need only be slight, as the roots of these are best kept near the surface. The first watering at once causes the sulphate to dissolve and prepares the roots for the after watering, while the after supply of water carries the already partly dissolved salt down to the roots without waste, and with rapid effect. The manure is strewn broadcast over thickset crops like Onions, about 1½ to 2 cwt. per acre being a good dressing, or from half an ounce to an ounce per square yard. We have found it advantageous to mix the manure with an equal part of sharp sand, crushing all lumps in the process. For planted-out crops of Cabbages and Cauliflowers the pure manure is applied, as much as lies between the first and second finger and the thumb being a sufficient dressing. Later, we have found a dressing applied to Seakale in the same way

that the Onions are treated of great benefit in securing strong forcing crowns. To this crop it should be applied not later than the middle of June, in order that excitement of the plants may not be unduly prolonged in autumn. A dressing at the rate of 2 cwt. per acre is of great advantage to Celery. We have found the best way to secure crisp and sound Celery not liable to produce flower stems, is to grow the crop as quickly as possible. Late sowing may safely be indulged in when means are taken to make the growth rapid in June, July, August, September, and October, according to the time the crop is wanted, and nothing secures this result so well as a dressing of this sulphate. If dry, water before and after dressing as advised for seed beds. It is better not to apply to late crops—those for use during February to May.

Dressings of this manure are of no use to such crops as Peas, Lettuces, Turnips, Artichokes, Potatoes, and fruit crops generally. Young Rhubarb may be prolonged indefinitely by two or three dressings throughout the season. Fine-foliage plants in the flower garden are benefited provided the beds are kept in good heart.—B.

MUSHROOM-GROWING IN SPHAGNUM OR PEAT MOSS.

IN compliance with the Editor's foot-note to the article by "J. H." in the Journal for May 3rd on Mushroom culture, I have pleasure in supplementing the notice therein alluded to which appeared some time ago, by detailing my experience in growing Mushrooms in sphagnum or peat moss. In order that there shall be no misunderstanding about the material used, I would first state that it is what is usually imported from Holland and Germany, and sold as peat moss for bedding purposes in lieu of straw. Last autumn, on account of the scarcity of straw, the above-mentioned material was purchased for stable use here, where in consequence of its absorbent qualities it becomes thoroughly saturated with the liquid portion of the manure made by the horses, and retains much of the ammonia and other valuable qualities that cannot be taken up so well by the usual straw litter.

On receipt of a few bales of the moss I examined it with a view of judging of its utility after it had been used and turned out of the stables, and came to the conclusion that it would be very valuable not only as ordinary manure, but as a medium for the artificial propagation of Mushrooms. As soon as there was a sufficient quantity ready I prepared it by turning and drying in the usual way, and made up a bed in a cold shed which I spawned on the 23rd September. The bed fully confirmed my opinion of its merits, for the young Mushrooms quickly began to appear all over the bed, and I commenced gathering them on the 26th October, a little over one month from the day of inserting the spawn, and they continued to be produced in abundance until the end of January last. At that period the temperature of the shed fell very low, as I could not use fermenting materials to keep up the heat in consequence of the carriage house being immediately above it. From that date the crop rapidly declined, although the bed was by no means exhausted. Had I been able to apply a little heat to it I have no doubt but that it would have yielded a supply of Mushrooms for a much longer period.

On breaking up the bed I found it full of healthy spawn, and used the materials for planting Potatoes in, hoping to have a good harvest of Mushrooms in the Potato patch. In April I examined the ground and found it full of spawn, but fear that the recent heavy rains and very low temperature will have destroyed it. About the middle of October I made up a second bed in a warm cellar, where the temperature is kept up to about 55°. Like the first one this bed soon showed an abundance of young Mushrooms, which were ready for gathering a month after the bed had been spawned, and it also produced freely for more than five months a crop of Mushrooms of first-rate quality.

I think my experiments fully justify me in recommending the use of this moss for Mushroom beds. It comes into bearing quickly, yields a good crop (the flavour of which is equal to, if not better, than those grown in the beds made up of ordinary stable litter), and is very durable, the latter quality being, I believe, due to the quantity of ammonia that it contains after passing through the stable.

The box mentioned by "W. K. W." in the Journal of December 28th made up of the moss that had not been used in the stables did not prove so durable as the beds made up of it after the material had been used. I made the latter trial merely as an experiment, in order to test what could be done with the moss; but even had the result been as good as my other trials I should not recommend it, because it would be wasting good material to take the moss before it had been fully utilised, when it is as good or better after having answered a useful and economical purpose.—J. WALKER.

GARDENIAS FOR THE MILLION.

I READ with pleasure Mr. Luckhurst's description on page 398 of Gardenias planted out at Maresfield, and so well grown by Mr. Thomas. I, too, have something to record about Gardenias. Those who would like to see 200 blooms on a plant may imagine themselves with me one dull hazy morning, the wind cast, entering a house 100 feet long by 30 feet wide. We start with astonishment, and exclaim, "What! snow got through this bad glazing! Glazing without putty will not do for Sussex and East Grinstead." Snow? No; they are Gardenias for the million and Tubercoses, to travel north, east, south, and west by the thousand. Such is the case at Messrs. Roberts Brothers & Arnold, East Grinstead. The house is in two divisions, 50 feet long by 30 wide. There are twenty-eight plants in the first division, which measure upwards of 6 feet through, or 19 feet circumference, and are 5 feet high. These were planted in October, 1881. In the second house twenty-five plants were placed four months later—that would be February, 1882, or fifteen months since, and they measure 4 feet 6 inches through or 14 feet in circumference, and are 4 feet high. To give some idea of the snow-like appearance, I take a few figures from Messrs. Roberts' accounts of blooms sent away during seven weeks. Commencing with the week ending March 24th, 202 dozen; March 31st, 67 dozen; April 7th, 190 dozen; April 14th, 285 dozen; April 21st, 202 dozen; April 28th, 204 dozen; and May 3rd, 209 dozen blooms, or a total of 1357 dozens, or 16,284 blooms in seven days!

I saw the plants a few days after they were bought, in, I believe, 7 or 8-inch pots, by the able manager, Mr. Badman, who said, "We are going to grow these, and are building a house for them, in which they are to be planted out." A square heap of peat was cut in turfs, made very similar to an Orchid basket, 3 feet square and 2 feet deep, in equal distances, on the ground floor of the house, two rows on each side. Some fine peat, cow dung, and a handful of Clay's Fertiliser were added and well incorporated, and the plants were placed in. In a few weeks the roots were visible, soon forming a compact mass. The growth advanced rapidly like Laurel bushes, which they very much resemble, with foliage 6 inches long by 2 $\frac{3}{4}$ inches wide. Hundreds of the flowers were 3 inches in diameter. They are kept in health by liberal support. Mr. Badman states that he always keeps "something strong" in the house, though he wears the "bit of blue." Thus are grown "Gardenias for the million."—SAMUEL JENKS, *Brambletye*.

APRICOT BRANCHES DYING.

(Continued from page 398.)

THE stock (notwithstanding the generally received axiom—viz., "the scion overruleth the stock quite") exercises considerable influence on the health and longevity of the tree. The stock is raised from roots or layers, which are grown until they have a stem double or more in diameter than that of the shoot from which the Apricot bud is taken, and the growth of half a dozen years perhaps is concentrated by the heading-down of the stock upon a

single bud. What is the result? As much growth is made from the single eye as the stock had it been left alone would have produced. There is, however, a vast difference between growth formed in three to six years and that made in one. In the longer period the growth is solidified as made through the reciprocal action of the part above and below ground, and the growth is moderately vigorous throughout; but in the shorter period the growth, though moderate at the commencement and for the extent of a few joints, yet when the roots are called into activity by the increasing foliage the growth becomes robust—nay, gross and long-jointed, producing laterals as an outcome of the excessive food supply so readily attracted through the large sap channels of the scion, and the consequence is the wood is strong, soft, and remarkable for pith. What follows? The scion is cut back to the firm short-jointed wood at the base, and four or more shoots issue to form the foundation of the tree. Thus far, however, no evil is done. The buds start and make shoots, if vigorous, with plenty of laterals. Now we must discriminate between trees that have short-jointed wood and are not so strong as to form laterals, and those that have made gross sappy growth, or between the big tree and the small. The short-jointed wood will probably be ripe to the points of the shoots and be all that the planter could desire; but the other will have the wood unripe and be of no value, at least until it has been cut back to the ripe wood. But the vigour of the tree may be checked by lifting, and if this be not resorted to the two-years-trained tree will also be too gross; and it is no use planting trees with unripe wood and trusting to coming sun to ripen it, for it can never solidify, whatever it may do in contracting the sap vessels and narrowing the pith.

Another matter in connection with rearing the trees is often overlooked—viz., the fact that the Apricot is an exotic not hardy really in this country; yet in rearing trees they are grown in the open just as if they were as hardy as Apples, Pears, Plums, and Cherries. Some of our principal nurserymen have walls or other means of affording shelter and warmth to their young trees of Apricots, Peaches, and Nectarines, and it must be obvious the young wood of such trees is better ripened; in fact trees of one year's training are not infrequently furnished with flower buds. I shall forestall any comment by anticipating the remark likely to be made in respect of walls not being necessary until of late years. Stocks were budded and the trees grown in the open until transferred to walls. This everybody knows, and the trees, no matter how old, had the growth of the past season cut back to firm ripe wood; but of late years a new method of treating recently planted young trees has obtained—viz., they are recommended not to be cut back at all. This is very well if the wood be ripe, but what if it is not? Upon this matter our advisers are silent. They do not practise it themselves, for their trees in the open are so damaged by the first severe weather as to render necessary a practice they condemn. The planter will be acting wisely not to have anything to do with trees that have soft unripe wood. It does not answer to plant such trees without cutting back the strong immature shoots. Strong growths are sometimes encouraged in a young tree to cover the wall quickly and sooner derive profit; but the shoots, though they may form spurs and fruit splendidly, simply collapse in a few years, the branches die, and from the ripe wood—ripe in its first formation—strong shoots arise. When old branches die they are invariably those which at some time have been marked by vigour and unripened wood.

The influence of the stock being so great as to induce in the scion an excess of vigour in the first few years of growth, it is obviously essential to the health of the tree to adopt means of counteracting that influence. The tendency to early luxuriance is common to all varieties, but the Moor Park is the most prone to gum of any; and the method of checking the luxuriance which is not conducive to the early production of fruit is to root-prune the trees about the end of July or early in August, taking out a trench about one-third from the stem the tree has spread of growth and cutting off all roots there, and after filling up again give a thorough watering, and if necessary shade from bright sun for a few days until fresh roots are emitted. This will check the too abundant supply of sap, regulate the development of the growth, prevent its excessive production, and consequently tend to the ripening of the wood, which is less liable to injury from cold, and is fruitful in character. It is undue vigour in tender fruit trees which is the cause in most cases of canker and gumming. Counteract the tendency to over-luxuriance, and the wood will ripen and escape the ravages of frost. There is little gumming of trees under glass, but over-luxuriant trees do sometimes gum; they set their fruit badly and stone very indifferently, the remedy for which is lifting, which the most successful practitioners resort to periodically.

Not only is it necessary to resort to root-pruning in the case of

trees which in their early years of growth exhibit over-luxuriance, but it is absolutely essential whenever the trees from want of crop, adverse seasons, too rich soil, or other cause exhibit too vigorous growth which is not likely to ripen well. It is the only means of aiding trees of tender growth to perfect their growth short of artificial heat or the retention of natural heat, which will be considered at a later stage.

Formerly, it may be stated, Apricots were not so tender as they are now. I do not entertain the idea, for the gardeners of the last generation never encouraged strong growth simply to be cut hard back in winter. They kept their trees close to the wall, had no useless spray, and the wood ripened well. Trees against farm houses and cottages had very little attention, only a trimming in summer and a pruning in winter by some jobbing gardener of the district, unless the gardener or his assistant at the hall could be prevailed on to trim the trees; and it must be said the results were often more satisfactory on other people's trees than those directing under their care. Why? In front of the farm house or cottage the Apricots had no rich border as in the hall garden. The trees grew less, ripened the wood, and fruited splendidly, producing large if not yet good marketable fruit; and better than all, to one limb lost of these trees ten went off in the richer border, and otherwise pampered trees of the gardener.—G. ABBEY.

(To be continued.)

TOO-MUCH-ALIKE ROSES.

THE Committee of the National Rose Society would, I am sure, be very much obliged to your correspondent "Y. B. A. Z." for his timely remarks on page 430, and for the suggestions he has made on the subject; and I can only express personally, what I am sure would be their wish had they an opportunity of expressing it, my thanks to him for it. He will, I am sure, however, be glad to hear that those suggestions have been already acted upon. The Committee felt that they had no power to enforce their rules on this subject; but they placed the matter before the affiliated societies and urged on them the adoption of the rule, and also, as far as possible, the desirability of placing the names on their schedules, so that their exhibitors could have no doubt upon the subject; as, although their own members would know perfectly well the rule they had adopted, and would by reference to their catalogues be able to see the names of the bracketed Roses, yet there were in each society a number of exhibitors who were not members of the National would be ignorant of it. I am happy to say that the societies have behaved very loyally in the matter; nearly all of them have expressed their willingness to abide by the decision of the parent society, and have placed the names of the bracketed Roses on their schedules, so that very generally it will be carried out this year. I have with this enclosed for him a copy of the Darlington schedule, which not only for this, but for the wonderful manner in which my friend Mr. Whitwell has enlisted the aid of his neighbours, is well worthy of perusal, and, I may add, of imitation, by all who are interested in the getting-up of provincial shows. There are a few societies which have printed these names, but with an intimation that the rule will not be carried out until the season of 1884, so that I think, on the whole, as much has been done as one might reasonably expect.

With regard to the question put by your correspondent as to trebles, and the showing of, we will say, Ferdinand de Lesseps, Maurice Bernardin, and Exposition de Brie in the same treble, I cannot see that there can be any objection to this, provided that only one name is used; for as the Committee have decided that they are one and the same thing, it matters little by what name they are called; and if growers keep the different varieties in their gardens they can of course show them as they wish, so that the rule is adhered to. There are still some growers who say that they can distinguish these Roses, and this might give an opportunity, without infringing the rules, of seeing whether it were so or not.

The Committee felt that, notwithstanding all the pains bestowed upon their catalogue, it was sure to have some imperfections in it, and they have been recently engaged in revising it for 1884, and are about to add to it a catalogue of garden Roses, comprising many of those old favourites which ought never to be lost sight of. Into this catalogue several of those which have had a place in the list of exhibition Roses will be relegated.

Your correspondent has struck one of the notes which portend the approach of the campaign, and I hope next week to be able to say something on our prospects. I have lately been in several Rose gardens (amateurs'), and so may be able to give a general view of what is to be looked for. This, however, I may say, that notwithstanding all the jeremiads which some have

given expression to, there is every prospect of the season being a good and not a late one.—D., *Deal*.

CANKERING OF APPLE TREES.

THOSE who have lived in districts wide apart will have a varied experience regarding the disease known as canker. I have found it attack, more or less, almost every kind of Apple with which I am acquainted. In the south and west of England the worst; in northern districts the stronger-growing kinds always appeared to be the readiest to suffer, but in every case I have found trees liable to attack which have had their roots far from the surface, inert soil causing the mischief as well as tenacious clay when wet and beyond the influence of sun and air. When trees are to be kept dwarf or cramped in any form, as is the case in most private places, they are often severely mutilated by the knife to answer the purpose for which they are intended. This practice, while the roots are at full liberty and doing duty vigorous enough to supply the wants of trees of gigantic size, will give plenty of canker; but when roots are kept from unwholesome subsoil and well established in the upper stratum, drainage and other requirements being equal, there will not likely be much cause for canker in the branches.

I have frequently cleared the roots of trees which have been badly affected from stagnant or inert subsoil, ramming a quantity of lime and brick rubbish under them, thus arresting the progress of downward growth, and the cure of canker has been complete. With large orchard trees, which have little attention with pruning, and growth of roots and branches are left to grow naturally, do not generally suffer much till they are rooted below the surface into a subsoil in which they cannot have a healthy existence, then the disease is almost certain to appear. I have often observed that where the subsoil is rocky or marly canker has been almost entirely absent.

During the past season I have been dealing with a number of trees which have been showing canker and dying back of the young branches. The cause is obvious. A river flows a few hundred feet from the orchard and garden, and drainage below a certain level is impossible. In this the roots of the trees have permeated, and are suffering. The smaller size of trees in the garden I have lifted and replanted, and those which cannot be safely removed I have cleared off all their under roots which are decaying, and have filled up the space with lime and brick rubbish, finishing with a good coating of farmyard manure over the surface of roots. In the orchard, which is about 7 acres in extent, draining as deep as practicable has been done, the roots being so deep and trees of a great age, we do not think it advisable to tamper with them by lifting or mutilating in any form further than the removal of dead or dying branches. Singular that in this orchard there were not half a dozen bushels of Apples or Pears gathered during the past season, while in the garden, divided by a wall only, every tree was loaded. But the kinds are limited—Stirling Castle, a certain bearer; Lord Suffield and the Codlin class in general, and one called Heiton House, an immense bearer every season, and has given abundant supplies till lately—since last October. We cannot find the name in any catalogue, but as a kitchen fruit it is of great value.—M. TEMPLE.

PILEA SERPYLLIFOLIA.

VERY dwarf plants are indispensable in arrangements for table. The little tufts of this plant (not more in small plants than a couple of inches high) are very effectively disposed in their pots on a flat surface of Selaginellas, which last in my eye always have a very tame appearance. This little plant is a sort of pop-gun to its larger relative, the "Artillery Plant," and it is not only very much less but very much more dense in growth, and far more beautiful. It grows in very dense forms in small thumb pots, a half ball or not very peaked mound, and grows down the pot, nearly hiding it. Its leaves are less than those of *Pilea muscosa*, and of a paler and more beautiful green—lively olive. It grows freely, is readily increased, and needs a stove, but does well enough in an intermediate house or even in a greenhouse in summer, and is considered available for bedding.—G. A.

BULLFINCHES AND FRUIT BLOSSOM.—About three years ago the servants here took to rearing cage birds, and the Bullfinch was very much sought after owing to the unusual richness of its plumage for exhibition purposes. This was a means of very much reducing our stock, and the result is an order that no more Bullfinches are to be destroyed or taken while young. On the strength of this it would appear that Bullfinches have made themselves very notorious. Not

content with the opening buds of early spring they have made a second attack; this is on the opening and expanded blossom of Apple trees. I was astonished to see the blossoms lay so thickly under the trees. I could not have believed it had I not noticed the mischief done, and the men have also called my attention to the same thing. There may be no real harm in singling the blossoms so much where they are thick; but where they are only few and far between, what then? To say the least of it, it is rather sharp practice if we are to be subjected to this sort of thinning twice in one season, and I do not think the change is for the better.—A. O. W., *Biggleswade*.

SHOWING AURICULAS.

THOUGH I do not exhibit Auriculas, I nevertheless take an interest in the Auricula shows, and consequently in the letters which have been published as to the unfairness of large growers competing against those who have only a few plants to select from. The reasonableness of this proposition is apparent in the case of plants which take up much space to cultivate in quantity, and of which on that account it is impossible to have a large collection in small gardens; but the Auricula has this great advantage in its favour for growers with little space, in so far as a large collection can be grown in a very small garden. Mr. Meiklejohn, the veteran grower of Stirling, flowers over 2000 plants, yet he could easily stow them away in the space occupied by a cottager's best room. Then there is this further point to be taken into consideration, and that is the skill of the Auricula fancier in the propagation of his plants. It is well known that some people are always buying plants and losing them, just as persistently as they purchase or beg them. Now, it is hardly a fair proposition to handicap a man who is capable of doubling or even increasing his stock three-fold year by year by stepping in and saying immediately he distances growers who remain stationary as to number of plants, that he must not compete for the smaller prizes because it is unfair to these small growers. Looking at the question of propagation as being as much a matter of skill as other points in Auricula culture, I do not see any unfairness in the practice indicated.—B.

THE HARVEST OF THE SEA AND FRUITS OF THE EARTH.

NOT only was the Exhibition of last week one of the most attractive that has been held at South Kensington, but it was attended by a much larger number of visitors than usual, and in consequence of the arrangements with the Fisheries Committee, was presumably a financial success. May I suggest that the ensuing autumn appears to be peculiarly favourable for holding a great national fruit show in connection with the Fisheries Exhibition? Some years have elapsed since the Royal Horticultural Society had a great autumn show of fruit; and perhaps acting alone, the Council of the Society would not be justified in having one this year; but jointly with the Fisheries Committee, might not an exhibition be arranged that would be mutually advantageous? The fruit crops promise to be better than the crops of recent years, and undoubtedly sufficient would be forthcoming in three months after a good schedule was issued to make a magnificent show. By the middle of September the Fisheries Exhibition will have lost its freshness, and interest in it will have begun to wane more or less. If a display of fruit could be added, such, for instance, as that provided at Edinburgh last year, it could not fail to be powerfully attractive, and a great inducement for thousands who had inspected the permanent exhibition, representative of the "harvest of the sea" to visit the gardens again to admire at the same time a show representing in the best possible manner the "fruits of the earth;" and besides, the fruit show would attract thousands more, who but for it would not "pay their way" into the gardens at all during the season.

A vast number of the millions of London have never seen a great fruit show, not because such an exhibition has not been provided, but because they did not know of its existence. In a provincial city or town any great event worthy of patronage can be brought to the notice of almost every individual in a day or two; but this cannot be done in London. Time in proportion to its vastness in area and numbers is requisite to "permeate" the enormous mass of individuals who have a thousand other things to divide their attention. The Fisheries Exhibition will teach perhaps millions of persons "the way" to the Gardens at South Kensington who were to all intents and purposes ignorant of it before. This is a most important point; and if at the opportune time suggested a really great Exhibition, showing the fruit resources of the country, could be arranged and maintained for a week or more, is there not a probability amounting almost

to a certainty that it would prove a great success both to the Fisheries Committee and the Royal Horticultural Society?

A great fruit show would at the least be as appropriate as a flower show in the Gardens during the present season. Fruit is food, and the more its wholesomeness and importance as such becomes recognised by the million the better it will be for all—for consumers and producers alike. The million, too, take quite as much interest in a fruit show as they do in an exhibition of choice plants and rare flowers. This may be seen at any time when a general exhibition is held, the crowd being usually the most dense round magnificent dishes of Apples, Pears, and Grapes. These the public understand and can appreciate their merits, but they are not educated in the points of plants with names they cannot pronounce. Roses they know, and Potatoes they know and flock round them, but they pass with a wondering stare the Orchids and other valuable plants which the trained eye admires so much. These plants and flowers cannot well be retained in a show for a week, but fruit can; and a week is necessary in London for a show to command the maximum number of visitors.

And why, too, should it not be something more than a mere "show"—a sight to be seen?—just as the Fisheries is something more. Fish is on sale there, and properly so. Why should not fruit be sold too? Let the producers of fruit, also fruiterers, bring their wares, provide a great exhibition, and let the public have a more substantial share than merely looking at it with hungering eyes, and yet with the means in their pockets for satisfying their wants. If satisfactory arrangements can be made for doing so, the Royal Horticultural Society can produce a great show of fruit; and if in connection with it a fruit fair were arranged a step in advance, and a most useful one, would be made over the stereotyped shows, while an important addition at a time when it would be welcome would also be made to the great Exhibition now being held in the gardens—an addition that would, as before suggested, be equally advantageous to the Fisheries Committee and the Royal Horticultural Society. Is this matter worthy of any further consideration?—J. WRIGHT.

UNPRUNED ROSES.

DR. WATTS speaks of the Rose as "the glory of April and May." Either it or the seasons have changed in this respect. Except the Banksians it is hard to mention many Roses of May, much less April. Between the time when Roses under glass go out and Roses in the open come in a gap occurs—a regrettable interval, which it has occurred to me may be in some measure bridged, and that is by leaving certain Roses unpruned. In this way, especially after a mild winter, blooms may be obtained certainly a fortnight earlier than they can come upon bushes pruned *secundem artem*, after the orthodox fashion. Not, indeed, flowers that would do for the "box,"

"Their manners have not the repose
That marks the ease of Vere de Vere,"

but still quite good enough for domestic decoration.

Impressed with this idea, and favoured by the season, I have left various plants trained up against a wall almost untouched, and am now expecting to see after the first warm shower (this May 19th) Reine Marie Henriette in abundant bloom, with Gloire de Dijon, the Duke of Edinburgh, and Cheshunt Hybrid close on her heels; also Fisher Holmes and Sultan of Zanzibar are coming on favourably. At the same time my orthodox plants, pruned at the end of February and breaking very correctly all down each shoot, are perfectly innocent of any such intention, and, as I trust, are reserving themselves for the end of June or July. As I have alluded to this rather early pruning, I may add that the garden of Mr. Baker of Reigate (whom I have mentioned on a former occasion as a special advocate of this) is looking at this date in the highest possible promise. The large round bed of Charles Lefebvre, the rows of A. K. Williams, and other celebrities, his various "big battalions" are advancing towards their midsummer goal in most admirable precision. The surface of the ground when I called was somewhat obscured by a comfortable mulching they had just been receiving; but if the present promise be realised it will be by mid-June a veritable feast of Roses, respecting which I will end as I began with Dr. Watts—

"Come, and I will show you what is beautiful—
It is a Rose fully blown!"

—A. C.

THE BEST POTATO IN USE NOW.—The Journal has done good service in trying to ascertain the best Potatoes for market, garden, and general purposes by publishing the results and opinions of so many competent to form correct judgments for some months past. Orchids, exotics, florist flowers, and many occupants of the vegetable

garden have their devotees, and are more or less specialities as compared to the Potato. There is a phase of the matter I would suggest—namely, what Potato your correspondents find the best at present—that is say, during the past fortnight or during the month of May?—W. J. M. Clonmel.

FRUIT PROSPECTS IN THE NORTH.

NOTWITHSTANDING the very cold weather in March (the thermometer on the morning of the 10th having been as low as 8°), the prospects of fruit are by no means discouraging. Pears are setting well, especially on the walls; and the show of Apple blossom is very great, some of the earlier sorts are setting. Plums have failed on the whole; there was very little blossom, and much of that has fallen off. Apricots are rather partial, though some of the trees have better crops than lately. Peaches and Nectarines do not thrive here out of doors. Thirty or forty years ago we had abundance on the walls, but now the crop is always precarious, and never really good. Cherries promise well, especially Morellos. Gooseberries, Currants, and Raspberries are a full crop. Strawberries, for which this soil is well suited, show a very full bloom, and must be a good crop unless the weather should be extraordinarily dry.—GEORGE KNIGHT, *Gardener, Conyngham Hall, Knarborough.*

As you invite reports with reference to hardy fruits, I may inform you that in this locality the prospect of obtaining good crops are on the whole favourable. Pears, Plums, and Cherries promise to bear heavily, especially Pears, which have set unusually thick on a south aspect. There is a brilliant display of Apple blossoms on wall and orchard trees alike. Bush fruits are promising remarkably well, especially Gooseberries and Black Currants.—D. MACKIE, *Montgomery Gardens, Ayrshire.*

VIOLET CULTURE.

To dwellers in pure fresh country air, away from the smoke of towns and the noxious fumes of factories, the culture of Violets is simple, provided timely care and attention are given to the very few details which together insure success. For so many years have I grown Violets in considerable quantities, with an amount of labour about equivalent to that bestowed upon a Cabbage bed, that I had come to regard it as an ordinary matter about which everybody knew everything; when recently, to my surprise, a clever energetic gardener, who for the first time is required to supply Violets in quantity, wrote to me somewhat to this effect—"Pray give us a paper on Violet culture in the Journal; it is quite certain to be useful, and I have no doubt that others will be as glad to turn your plain hints to account as I shall?" Such an appeal is so certain of favourable attention from the Editors, that I do not hesitate to crave space for my reply.

Devoniensis bursts freely into bloom by the beginning of September, and is soon followed by the old Russian. The first week in October the plants are lifted from the open beds and planted as thickly as possible under glass wherever space is available. Garden frames, pits, Peach house, or orchard house, are all turned to account for such a purpose; but the best place for obtaining a brisk continuous supply throughout winter is a light airy house or pit, with a flow and return pipe or flue, solely to exclude frost and promote air-circulation on dull, wet, or foggy days, but not by any means to maintain a forcing temperature. Frost may undoubtedly be kept out of frames and pits by means of mats and litter, but bunches of Violets are not to be had by the dozen in midwinter from plants kept in darkness and damp. As the plants cease flowering in March, and before spring growth begins, they are pulled to pieces and the runners or side shoots having rootlets, as most of them have, are planted in open beds of such soil as will grow good vegetables, in rows a foot apart, and 9 inches apart in the rows. To facilitate watering, a border is divided into beds 8 feet wide, with narrow paths between. As the plants gain size in summer a liberal surface dressing of artificial manure tends wonderfully to invigorate them, and its beneficial effect is soon visible in the colour, size, and substance of the foliage. When the weather proves unfavourable for the spring planting it may be kept back till any time in April, only the later it is done the greater is the subsequent amount of watering required to sustain the flagging spring growth which usually comes soon after the middle of March.

This year the planting was late, but the young plants, nearly 2000 in number, are fast gaining size and vigour. The sorts grown in addition to the two already mentioned are Marie Louise, Neapolitan, The Czar, and Victoria Regina, all good and distinct, the two last being of especial value for size of flower and

lateness. I still grow most of the old Russian for winter bloom. It never fails me, and although its small flowers are comparatively insignificant beside the new and fashionable monsters, yet they are so abundant and so fragrant as to worthily take a leading place wherever large quantities of winter Violets are wanted.

Violet culture in suburban gardens, even so far out as Lewisham and Blackheath, appears to be so generally a failure, that I dare not recommend it, for the smoke is invariably fatal to them. But knowing that readers of the Journal near London are desirous of trying again, I would advise the beds to be of very gritty rich soil upon a thick substratum of rubble, so that drainage must be prompt and sure, and a thorough washing twice daily by watering overhead with clean water through the rose of a waterpot. Even with this care I am by no means sanguine of success, for I know full well how soon every part of leaf and branch becomes coated with soot in the smoky atmosphere of our huge metropolis.—EDWARD LUCKHURST.

INARCHING VINES.

THE present time is the best to inarch Vines. Green wood unites quickly, and the rods made this season will bear fruit next year. Inarching has many advantages. By its means houses of Vines might be changed altogether without disturbing the border or uprooting a plant. Supposing a good border to have been formed some years ago and the house planted with Black Hamburgs or some early variety, the whole or part of these might be transformed to Lady Downe's, Alicantes, or Gros Colmans without any further trouble or expense than inarching. I have done much of this work lately amongst our early Vines. As we want most of the late sorts, and as we could not afford to wait while young Vines are grown, inarching on to the old rods was practised, and fruit-bearing wood secured on the kinds introduced before cutting away the others. At present a Foster's Seedling is being converted into a Muscat of Alexandria and another part of it into Golden Queen, as the latter two sorts are much better keepers in autumn than Foster's, which is not wanted.

The young Vines for making additions with should always be in pots, and they may be from one to three years old, but the best are those raised from eyes three months ago, and which have now a single young stem 3 or 4 feet in length. This should be kept in the pot and be taken close to the Vine on which it is to be inarched. It is necessary that the two parts which are to be joined together should meet conveniently, and the pot with the young plant may have to be placed on the border, a shelf, or some special erection to raise it into position. It is generally best to inarch as near the bottom of the old Vine as possible. But if the young Vine was 4 or 5 feet long I would not work it on at the bottom but at the top. This would give a good piece of young cane unused, which would be most useful afterwards to plant elsewhere or fruit in a pot.

The operation of inarching is simple, and consists of cutting a slice from the side of each of the pieces of wood which it is intended to unite. Both cuts should be the same size, and when placed face to face they should meet evenly. A piece of soft matting is then bound round them as firmly as possible. There is very little use in trying to work green wood on to an old hard rod, but if both are young growths of this year the attachment will take place more quickly, and the operation be successful. We have seen young growths unite in twelve days, and about that time the tying should be loosened a little, that the development of the wood may not be hindered. This should be looked to every ten days or so until the wood is fully expanded and maturing. Vines inarched now will soon reach the top of the house, and make canes capable of bearing next year. I do not approve of cutting away the parts underneath the connection until well into autumn, as the young rod, although drawing largely from the old Vine, also receives much support from the roots in the pot, especially if the latter are well supplied with liquid manure. In dealing with Vines in pots which are over one year old I would not work them on the old stem, but one of the fresh green side shoots would be the part used for inarching.—M. M.

CALCEOLARIAS.

ON page 366 in the Journal some remarks appeared in reference to the failure of Calceolarias as bedding plants, and the following few hints upon the subject may be useful, as I have had to deal with very light soil, which is not liked by Calceolarias. I do not take cuttings so early in the season as many do; the first week in November I find quite soon enough, as those taken earlier are too hard. I prepare a box of rather stiff soil for the cuttings, which

are inserted 2 inches apart, and remain there until about the first week in February, when they are removed to a warm border about 2 feet in width, the soil being prepared as before stated to receive them. These are protected by old lights pitched against the wall, removing them altogether whenever the weather will allow, in order to render the plants hardy. I prepare the beds by adding soil from the Melon beds, which I find suits the plants admirably but neither manure nor leaf soil is used, as this produces a fungus about the roots. The plants are lifted with a good quantity of soil attached to the roots, and in planting the soil is made very firm about them; in fact I sometimes tread the ground around them. I use a little soot and slaked lime in preparing the beds, and after the plants are into their places a thorough soaking of water is given. In dry weather a thorough watering is given once a week, as constant dribblings are very injurious to Calceolarias, which require much more water than most other bedding plants. It is a very good plan to change the stock of cuttings by making an exchange with a friend who has a different soil.

Another thing that often causes failures is planting too deeply. I am careful to keep the ball as near on the same level when planted out that it held before. Of course the wind has more effect on such plants, but this can be soon remedied by having some old brooms cut up, and two or three pieces being placed round each plant so that they give support to the branches. This may look untidy for a time, but pays for the trouble after the plants begin flowering. Nothing looks much worse than to see a batch of these plants with the branches split off and withered, which is often the case after a gale in the flowering season, causing openings that cannot be replaced, for they seldom succeed if planted out when in flower.—A SUBURBAN GARDENER.

HISTORICAL JOTTINGS ON VEGETABLES.—No. 4.

ASPARAGUS.

WHEN a lady asked Samuel Johnson, one day, why he had given a rather odd definition to some word in his Dictionary, expecting he would assign a profound reason for so doing, the great man answered, to her surprise, "Well, Madam, that was ignorance, pure ignorance." The Doctor did not know much about Greek, therefore it was probable he also failed to explain the derivation of Asparagus, which, if we had it from the Romans, is originally Greek, and, as Mr. Glasspoole observes, means the tender shoots of a plant not yet unfolded—in fact, a name used loosely by the ancients for various sprouts eaten in spring or at other seasons. It was clearly not restricted until later times to what we call Asparagus, but that plant was recognised and approved of as an article of food at least 2000 years ago. It is certain Cato the elder laid down directions concerning its culture. He recommended, amongst other things, the sowing of its seeds in those beds where the reeds were grown to support the Vines.

Two varieties of the wild Asparagus, the mountain and the marsh, are noticed and commented upon by ancient writers on natural history or gardening, and from a reference made by Juvenal to the mountain kind, when he is describing a dinner, it would seem that this was preferred to the Asparagus of the marshes. Both, however, were gathered and eaten, and in the time of Pliny the plant began to be cultivated in gardens, partly for food, no doubt, but also because it was deemed to possess medicinal virtues of no ordinary character. With his curious accuracy, Pliny notes that very fine Asparagus was grown about Ravenna, three or four heads commonly weighed a pound, and that could be bought for the low price of one as—not more than 2*d.* certainly. One Italian fashion of cooking Asparagus was peculiar; the heads were carefully dried, and then afterwards dressed by putting them into very hot water, a few minutes' rapid boiling rendering them fit for the table.

Undoubtedly the Asparagus is a true native of these islands. It is still to be found wild in the west and south-west of England. On the coast of Cornwall there is an island called Asparagus Island, and it occurs also upon the continent in many places. France and Holland formerly produced it in much more abundance than they do at present. Gerard gathered specimens of the plant in Essex not far from Thorpe and Singleton, he also observed it in some Lincolnshire meadows near Moulton. He mentions that the plant can be much improved by cultivation, but he does not state if he tried experiments with it in his garden on Holborn Hill. It is impossible to say now who was the first grower of Asparagus for the London market; there has, however, survived a fragment of history concerning a garden at Lambeth which in the reign of Charles I. was known as the "Sparagus Garden." Lambeth, once called Lamhythe, so 'tis thought, the "Haven of Dirt," from its moist soil, would be suitable enough for Asparagus, and the crop when gathered could be easily conveyed

either to Westminster or to the city. We have a clue to the position of this garden: it adjoined, perhaps was originally a part of, Cuper's gardens. This was just opposite Somerset House, and its site is crossed by the modern Waterloo Bridge Road. As was not unusual in the seventeenth century, what was at its commencement simply a place for raising vegetables became subsequently a pleasure resort, and people went to the 'Sparagus Garden to eat both vegetables and fruit probably. Pepys records that he went there in April, 1668, taking a couple of lobsters with him in the hope of meeting Knipp, the pretty actress, who had been his wife's maid, but he didn't, and had to dine alone. Evelyn, writing near the end of the seventeenth century, says in his quaint way, "The large Dutch kind of Asparagus raised in highly manured beds is not so sweet and agreeable as those of moderate size, and yet to show what *solum*, *cælum*, and industry will effect, the honourable and learned Charles Hatton made my wife a present of Asparagus, the bundle containing sixty, which weighed 15¼ lbs. Allowing them 4 ozs. to each head, one was as much as one person would desire to eat, and, what was most observable, they were not raised by any extraordinary compost, but grown in a natural, sweet, rich, well-cultivated soil about Battersea." And during the Georgian period large quantities of Asparagus were raised there, as also near Bermondsey and Deptford, though modern building has nearly, if not quite, banished this plant to places beyond the fog and smoke of London. At the west end of the metropolis the Five Fields, or at least that portion of the fields that was cultivated (for some of the ground lay waste as a kind of common), yielded Asparagus and other choice vegetables about the time, perhaps earlier, when we have the Lambeth Asparagus Garden mentioned.

It should be noted that the popularity of the Dutch variety of it is to be explained by the arrival of Dutch William upon these shores. One of the historians tells us that his manner of eating the heads clean up at the dinner-table, and not merely sucking off the tops, had to be imitated by those who were allowed to join the Royal dinner party, for otherwise William III. would have felt himself highly offended. But our forefathers in England had some odd ways of eating Asparagus; thus Evelyn, already quoted, states he had seen the heads eaten raw with oil and vinegar. In the reign of Queen Elizabeth people cut up Asparagus tops and mixed them with other vegetables used to flavour broths and soups.

An extensive list of the old cries of London fails to show that Asparagus was ever hawked in the streets, as were so many vegetables and fruits; and even now it is one of those that rarely get into the hands of the costermongers, its season being short, and the demand for it limited to those who can afford delicacies. We have taken strange liberties with its name; in Covent Garden Market few persons speak of it except as "grass," the general English appellation being "sparrow-grass," one which Batty Langley defends and explains. "It originated," says he, "in the resemblance which the top of the bud bears to the shape of a sparrow's bill." I venture, with all due respect, to think it is simply a corruption of the imported name; not the only one, for both Gerard and Parkinson state it was often called "sperage." But Langley's comment in his "Principles of Gardening" enables us to carry "sparrow-grass" back as far as 1728, "sperage" would be at least a century older.

Some particularly large Asparagus heads have been raised at Mortlake in Surrey by a Mr. Grayson, several of his samples weighing nearly half a pound each. It was one of the localities that formerly yielded considerable supplies to the markets, many acres being devoted to this vegetable; and there is still, I believe, some quantity of it grown in that vicinity every year. Abercrombie specifies the Dutch, the Battersea, and the Gravesend Asparagus as leading varieties produced by soil and culture. I am unable to ascertain anything about the variety named after the town of shrimps and watercresses, nor does it seem that any quantity of Asparagus was sent from the neighbourhood into the London market.

An odour is imparted by Asparagus to the breath, not so marked as that of the Onion and its allies, yet perceptible by most noses. As a spring esculent it is undoubtedly entitled to commendation, but its wholesomeness is often interfered with, owing to its being overloaded with melted butter. Asparagine, its active principle, has been extracted and given in various maladies. The ancients believed that a small piece of this vegetable applied to an aching or diseased tooth would facilitate its removal. There appears to be no cause for the assertion made by one of the Greek physicians that Asparagus has an injurious effect upon the eyesight.—J. R. S. C.

THE NIGHTINGALE.—The question is asked on all sides, What has become of the nightingales? They were first heard here on the

26th ult. in full song, but from about the 1st inst. no one in this neighbourhood seems to have heard them. We are afraid the cold weather has killed them. I have heard that one of our gamekeepers recently picked a dead one up in the woods.—A. O. W., *Biggleswade*.

ADENANDRA FRAGRANS.

THE Cape of Good Hope and the Rue family afford us many very distinct and beautiful plants for greenhouses and conservatories, and amongst them must be ranked the species illustrated in fig. 97. It is not one of the most brilliant of plants, but its flowers possess two great attractions—a rich but soft rosy colour, and a powerful yet agreeable fragrance, qualities which recommend it strongly to the attention of cultivators. Though requiring some little care to insure its success, it is by no means one of the most fastidious plants, and can readily be had in satisfactory condition. A compost of peat, light turfy loam, and sand suits it, the pots being carefully drained and water supplied liberally but with judgment. In the winter a much less quantity



Fig. 97.—Adenandra fragrans.

of water will be needed, though the soil should never be allowed to become dust-dry. The flowers are produced during April and May, and last a considerable time.

APRICOTS UNDER GLASS.

I WAS very much pleased to see on page 397 of the Journal an article on the dying of Apricot branches by your able correspondent Mr. G. Abbey, as I agree with him that discussion is needed upon the subject.

Although I am quite prepared to endorse much of what is stated in the article above referred to, and especially the advice therein given to plant more vigorous-growing varieties in lieu of Moor Park, which appears hitherto to have been almost invariably the variety selected, and I am sure we are all indebted to Mr. Abbey for the excellent selection of suitable varieties which he gives. I yet find, however, that my experience does not agree with his when he states that "Apricot culture under glass compares very unfavourably with that on walls." Such may be true of the southern counties, where vegetation is much earlier and the growing season consequently longer, thus giving outdoor trees a better chance of maturing their growths; but in the northern county from which I write my experience has been quite to the contrary.

In the gardens under my charge is an Apricot house—a lean-to with a south aspect—30 feet by 12, and occupied by one splendid tree (the finest I have ever met with) of Moor Park. The house was built and the tree planted more than twenty years ago in a different part of the garden from that where it now stands, and both were removed to their present site fourteen or

fifteen years since. The tree was well managed and trained when young, suffered but little apparently by removal, and is at the present time very vigorous, filling the house completely in every part with clean and healthy young growths. I have had the tree under observation for ten years, during which time it has annually borne large crops of very fine fruit, and looks likely to continue doing so for an indefinite period.

At the time the house was originally built and the tree planted a south wall 10 feet high and 40 yards long, built of stone, with a lining of brickwork, was planted entirely with the same variety (Moor Park). For a number of years these trees grew vigorously and carried fine crops of fruit; in fact, until the advent of the seven years of disastrous weather for fruit trees alluded to by Mr. Abbey. Since then the fruits produced by them have been small in size and in numbers, and in every way inferior in quality, whilst the trees have been gradually but surely losing branches, until they now are reduced to mere skeletons of what they once were. As unheated glass structures are so cheaply erected I feel quite convinced that for the successful cultivation of the Apricot in our northern counties they are much superior to an open south wall, whatever may be the variety selected for planting. I also find the house very useful in winter for the cultivation of Parsley and early salading. The requirements of the Apricot in such a house are very simple, and mainly consist of an abundant supply of water to its roots with free ventilation in all seasons. It will not endure a close atmosphere. The tree above spoken of has suffered but little from gumming, thus bearing out the truth of the modern idea that such is usually the result of cold.—W. K. W., *The Gardens, Oakbrook, Sheffield.*



THE MANCHESTER WHITSUNTIDE EXHIBITION proved as great a success financially as horticulturally, and we are informed that a surplus of £1000 is the very satisfactory result. On Whit-Monday 17,000 persons visited the Show, and the total number of visitors on the six days was nearly 60,000. Such evidence of the continued popularity of these exhibitions in the great cotton city must be very gratifying to Mr. Bruce Findlay, who has worked so energetically to ensure their success.

— MR. SANDERS desires to correct a mistake in his article on STRIKING ROSES on page 421. It reads, "Plunge the pots of cuttings." He intended it should read "Plunge the pots after the plants are taken up and potted." He is no advocate for striking Rose cuttings in heat, but when the plants are rooted and placed in gentle heat it gives them the necessary start. Our correspondent states he is now cutting some fine Roses from plants on own roots. We shall publish other communications on this subject next week.

— MESSRS. BARNICOTT & SON of Taunton send us a copy of the "COUNTRY GENTLEMEN'S REFERENCE CATALOGUE FOR 1883," which contains a full list of works on agriculture, gardening, botany, natural history, and similar subjects. It will be found very useful, as it gives a brief description of the character of each work, with the price and name of the publisher.

— DR. MACKENZIE sends the following respecting the HONEYSUCKLE IN ITALY:—"A friend residing at the Lago Maggiore informs me that the Honeysuckle they have there is beyond imagination sweeter scented than what grows in Britain. It is very common in Piedmont, and now in flower. Except that the leaf is brownish, it is not unlike British Honeysuckle; but the flowers, instead of finishing the shoot as with us, come singly from the leaf axils, all along the sides of the shoot. Can any of your readers name the coveted plant, and state where it can be obtained in Britain?"

— A "NORTHERN GROWER" sends us the following hint on REPOTTING AURICULAS:—"When shifting some plants lately I was struck with the advantage those in deep pots showed to have over those which had pots less deep to grow in. This is a point worth the attention of those who will soon be repotting their stock."

— WE learn from the schedule of the the SHROPSHIRE FLORAL AND HORTICULTURAL SOCIETY that their Summer Show will be held on August 15th and 16th, when prizes will be offered in 137 classes for plants, flowers, fruits, and vegetables, a large number being open to all competitors. Stove and greenhouse plants are especially well provided for. In one class for twenty specimens, £25, £20, and £15 are offered; while in another for nine specimens, £10, £6, and £4 are the prizes. For fruits the prizes range in value from £5 to £1, and other classes proportionately.

— IN the northern counties LAMIUM MACULATUM AUREUM is much used instead of Golden Feather by those who have not appliances for raising a stock of the latter early enough, and a very good substitute it is. It is easily propagated by division in spring or cuttings in autumn; but, like Golden Feather, it comes true from seed.

— THE ranks of AMATEUR ORCHID GROWERS have been lately increased by a useful recruit—namely, H. Little, Esq., of Hillingdon, Uxbridge; and if he brings the same enthusiasm to bear upon these plants which has already distinguished his efforts with the Pelargoniums, Cyclamens, and Primulas, he will probably soon have a large and interesting collection. His first exhibit was, we believe, that at South Kensington last week, when he was awarded the third prize in a very good class for healthy well-flowered plants of moderate size, but giving promise of future excellence.

— THE COPPER AND PURPLE BEECHES have now assumed their richest colours, and are most effective where planted in contrast with lighter-leaved trees or shrubs. There are several varieties of these, differing considerably in the depth of colour and brightness. *Fagus sylvatica purpurea*, *atropurpurea*, and *nigra* are very dark; *F. s. cuprea* is one of the brightest, and is very telling at this time of year. What a strange divergence of form and general appearance is afforded by the green-leaved varieties, *cucullata*, with its curiously contorted foliage, and *comptoniaefolia*, with its narrow irregularly cut leaves.

— THE WANSTEAD AND LEYTONSTONE FLORICULTURAL SOCIETY will hold their seventeenth Show on Thursday, June 28th, in the grounds of D. F. Morgan, Esq., Great Blake Hall, Wanstead, when prizes will be competed for in a large number of classes devoted to gardeners, amateurs, and cottagers.

— IN the ORCHID HOUSE at Kew the most notable plants at the present time are the specimens of *Epidendrum bicornutum*, which are flowering superbly. The valuable quality of this species is the great time during which the flowers continue in good condition. Although they have been expanded several weeks, they look as fresh now as if they had but just expanded. The rich golden *Dendrobium Cambridgeanum*, and the soft purplish-blue *D. Parishii*, together with the white *Thunia alba*, or *Phajus albus* as it is there named, are blooming well, while amongst the cooler Orchids are several *Odontoglossums* in fine condition. Especially noteworthy is a grand variety of *O. Pescatorei*, with large handsome flowers of excellent form, and equal to many forms of *O. Alexandræ*. The flowers are white, and have not the rich spotting which distinguishes *Veitchii*, but it would form a beautiful companion for that.

— "A FEW weeks ago," writes "Single-handed," "I saw

a vinery border taken to pieces, and had a LESSON IN DRAINING not likely to be forgotten. It was a real orthodox border—down to the 6 inches of brick rubble, which the maker had fondly hoped would provide for the removal of surplus water. He might as well have provided a layer of puddled clay. In spite of drains and rubble the border was sour—and why? Because, instead of the rubble proving the means of ready escape for water, it had only afforded space for the worms to deposit their impervious castings, effectually choking up the drainage, for the very tiles were full. It would seem, then, that borders may be made watertight either by puddling with clay or providing space for the worms to do so!

— THE HARDY AZALEAS in the pleasure grounds at Kew are now flowering profusely, and are well worth a visit. The American ground, which is known to comparatively few besides the frequenters of these gardens, is situated to the right of the Sion house vista, going towards the river from the Palm house; and those who are unfamiliar with the beauty of these Azaleas when grown in large beds out of doors would be greatly surprised at the gay and diversified effect produced. The colours are very rich, ranging through bright yellow, orange, red, crimson, and rose to soft pink and pure white. The flowers, moreover, possess a powerful and agreeable fragrance, which perfumes the air for a considerable distance around them. The pontica varieties predominate, but the larger-flowered mollis type is also well represented.

— AMONGST flowering trees at the present time, notwithstanding the attractions of the Horse Chestnut, the MANNA ASH (*FRAXINUS ORNUS*) is unsurpassed for gracefulness and beauty. Specimens of moderate size are extremely handsome on lawns, the large plume-like heads of flowers and the elegant pinnate foliage having a fine effect. The Service (*Pyrus Sorbus*) is also flowering abundantly now, and is similarly useful for shrubberies or lawns.

— AN Exhibition of plants, fruit, and vegetables is to be held in connection with the Worcestershire Agricultural Society in the Show ground at Worcester, June 19th, 20th, and 21st. The prizes are numerous and valuable, the principal plant classes being that for ten stove and greenhouse plants in flower and six fine-foliage plants, three prizes being offered, value £20, £15, and £10. For twelve fine-foliage plants £10, £6, and £4 are offered, and similar amounts for a group of plants arranged for effect in a space of 200 square feet. In the fruit and vegetable classes also there are some good prizes, which may be expected to bring numerous competitors.

— IN the stove at Leigham Court, Streatham Hill, the residence of Mrs. Treadwell, is a remarkably fine specimen of the NIGHT-FLOWERING *CEREUS* (*C. grandiflorus*) which is now producing its magnificent blooms every evening. The plant is trained over a lattice trellis, covering a space 30 feet long by 4 feet wide, and, strangely enough, has no main stem or roots, being quite unconnected with the soil, the plant existing upon the trellis, the space between which and the wall is packed with moss and occasionally syringed. Some dozens of flower buds are showing, and on Monday evening ten handsome flowers opened, the powerful Vanilla-like fragrance filling the house. They commenced expanding between 6 and 7 P.M., and some that were cut and placed in water continued open until about the same time the next morning, when they rapidly faded. There are, however, numbers of successional buds that will doubtless yield displays for several nights. It is regrettable that this grand *Cereus* lasts such a short time in beauty, for it is one of the best of the genus. The blooms average 8 or 9 inches in diameter when fully open; the thirty or forty yellow sepals are about a quarter of an inch in diameter, 4 to 5 inches long, tapering and

spreading, forming a fine fringe round the pure white petals, which are broader and shorter, in broad cup-like shape. This fine species is a native of the West Indies, and is said to have been in cultivation at Hampton Court before the year 1700.

— THE season for the use of the LAWN MOWER has again come round, and those who take pride in their lawns and delight in the tidiness of their gardens must necessarily provide themselves with this indispensable implement. The designs and the modes of working of these are various. Some of them are decidedly objectionable, and ought to be avoided; but there are also many, such as those that are advertised in our pages, upon which reliance can be placed. Among the latter we must call especial attention to one sent us by Mr. Thomas Clarke of Upper Thames Street, London, who is agent for the Excelsior lawn mower. The one sent us has a cutting width of 14 inches, and it is so easily worked that a lady or a lad would have no difficulty in using it without any over-exertion. The work is very efficiently executed, and the implement is neat, elegant, and very well made. We can strongly recommend it.

— A CORRESPONDENT sends the following on a NOVEL ARBOUR, which he thinks worth noting:—"It was formed of Laburnum and Honeysuckle. Some years ago a wooden eight-sided erection had been put up. To each post was planted a young Laburnum, and with Honeysuckles between them. These were regularly trained up the sides and tacked down to the roof, the smaller twigs being interlaced like basketwork. The Laburnum had become posts and roof; the Honeysuckle covered the sides. The wood was then removed, leaving a handsome arbour that could not have very easily formed otherwise. To many such a plan may not be new; to others the hint may be worth something."

— THE anniversary meeting of THE LINNEAN SOCIETY was held on Thursday last at the Society's rooms, Burlington House, Piccadilly. Sir John Lubbock, Bart., M.P., presided, and there was a good attendance. The following appointments were unanimously made by ballot for the ensuing year:—President, Sir John Lubbock; Treasurer, Mr. Frank Crisp, LL.B.; Secretaries, Mr. B. Daydon Jackson and Mr. George J. Romanes, F.R.S. In room of the retiring members of the outgoing Council the following were appointed—Mr. Thomas Christy, Mr. Henry E. Dresser, Mr. George Murray, Mr. Howard Saunders, and Mr. Henry J. Stainton, F.R.S.

— THE following is a list of the Orchids in Mr. J. T. Peacock's group at the great Summer Show, Kensington, last week, for which a silver-gilt medal was awarded:—*Brassia verrucosa*, *Burlingtonia venusta*, *Cattleya citrina*, *C. Mendelli*, *C. Mossiae*, *Cypripedium niveum*, *C. lavigatum*, *Dendrobium chrysotoxum*, *D. Pierardii*, *D. suavissimum*, *D. tortile roseum*, *Epidendrum vitellinum majus*, *Laelia majalis purpurata*, *Lycaste Skinneri*, *L. aromatica*, *Masdevallia Harryana*, *M. Houtteana*, *Nanodes Medusae*, *Odontoglossum Alexandrae*, *O. Andersonianum*, *O. Cervantesii*, *O. citrosum*, *O. cordatum*, *O. cordatum superbum*, *O. Coradinei*, *O. gloriosum*, *O. hebraicum*, *O. Hallii*, *O. maculatum*, *O. nebulosum*, *O. Pescatorci*, *O. Phalænopsis*, *O. polyxanthum*, *O. Roezlii*, *O. Rossii*, *O. triumphans*, *O. tripudians*, *O. vexillarium*, *Oncidium ampliatum*, *O. Kramerii*, *O. Marshallianum*, *O. cucullatum*, *O. phymatochilum*, and *Phajus Wallichii*.

— THE CALCEOLARIAS AT BEDFORD HILL HOUSE, BALHAM, the residence of J. Brand, Esq., are now at their best, and, as usual, are highly creditable to Mr. Rapley, who has for several years paid so much attention to these plants that he has succeeded in obtaining a strain of unsurpassed merit. The richness and diversity of the colours, the size, substance, and good form of the flowers, are all that could be desired, particularly in combination

with such a robust yet compact habit of growth as distinguishes the varieties in question. A cool lean-to house facing north is devoted to them, and upon the front stage the majority are arranged, forming a beautiful, bright, and varied bank. Very striking are the numerous plants of Cloth of Gold, the pure yellow self which has been several times exhibited and honoured with certificates. This is a magnificent variety, the flowers being exceedingly large, frequently over 2½ inches in diameter, full, and borne in large dense heads. Crimson, maroon, pink, and other selfs are numerous, as well as some most delicate, netted, spotted, and blotched forms; and one that is almost white will, if it can be slightly purified and fixed, be a novelty of much promise. The general condition of the plants is most satisfactory, dwarf without being stunted, and vigorous without being coarse.

— A SLIGHT mistake occurred in our report of the Implement Show at South Kensington. On page 434 it is stated that the silver medal was awarded to Messrs. C. P. KINNELL & Co., 31, Bankside, Southwark, for an open-coil Princess Louise boiler. The medal was awarded to Messrs. Kinnell for a boiler made for fitting in the end of a greenhouse, the face of the boiler, smoke-shaft, and feeding contrivance being outside the house. The fuel is placed in the furnace from the top, a moveable lid effectually closing the hopper and directing the smoke up the chimney. This appears to be a well-designed apparatus, and admirably adapted for the purpose it is intended to serve. It will be known, we believe, as the Silver Medal Horseshoe-shaped Boiler, as embodying its form and the honour it received at the Show in question.

— MR. C. PORTSMOUTH, recently gardener to Viscount Massereene and Ferrard, Oriel Temple, Collon, Co. Louth, has been appointed gardener to the Hon. and Rev. F. R. Grey, The Rectory, Morpeth.

— PART 52 of Messrs. Cassell & Co.'s "FAMILIAR GARDEN FLOWERS" contains coloured plates of *Pelargonium speciosum* and the double *Kerria*, *K. japonica* fl.-pl., accompanied by interesting descriptive matter. From the same firm part 75 of "FAMILIAR GARDEN FLOWERS" gives plates of the Sainfoin (*Onobrychis sativa*) and the Ragwort (*Senecio Jacobæa*), with historical and popular descriptions. Part 34 of "PAXTON'S FLOWER GARDEN" has a good plate of *Platycodon chinense*, a rich purple-flowered herbaceous plant closely allied to the *Campanulas*, and a rather dull-coloured representation of *Aerides roseum*, with a continuation of the gleanings and memoranda, in which are several woodcuts of rare plants.

— MR. G. DUFFIELD, Winchmore Hill, sends the following query respecting GOLD FISH DYING—"Can any of your very numerous correspondents kindly assist us with a little information regarding the following? We have a small pond in the garden here containing, besides various water plants, some gold fish, but these fish we are gradually losing in a strange manner. We frequently find one or more dead ones floating, and on examination almost invariably find a small hole, sometimes more than one, about an eighth of an inch in diameter, just behind the gills, frequently right through the fish, and occasionally one or both eyes apparently eaten out. We have lost dozens in this way, but have failed to discover the cause of the mischief."

— OUR correspondent "D., Deal," refers in another column to the "wonderful manner in which Mr. Whitwell has enlisted the aid of his neighbours" in support of the NATIONAL ROSE SOCIETY'S SHOW, to be held at Darlington on July 18th. The schedule is now before us, and it is gratifying to observe the substantial interest that is taken in the Show by the nobility and gentry of the district. Twenty-two prizes are provided in sixteen specified classes of the following amounts—namely, £8 by the Earl of Zetland, £10 by J. Sawrey-Cookson, Esq., and W.

Stobart, Esq., £3 10s. by C. R. Robinson, Esq., £5 by Viscount Castlereagh, M.P., £5 by David Dale, Esq., £5 by Theodore Fry, Esq., M.P., £5 by Mr. H. Pease, £8 by the High Sheriff, £3 by Jonathan E. Backhouse, Esq., £4 by W. H. Wilson Todd, Esq., £4 by Edward Hutchinson, Esq., £5 by John Michell, Esq., £16 by Sir J. W. Pease, Bart., M.P., and A. Pease, Esq., M.P., £5 by Mrs. Gurney Pease, £10 by E. Backhouse, Esq., and J. E. Backhouse, Esq., £5 by H. F. Pease, Esq., £5 by J. B. Hodgkin, Esq., £2 by Messrs. Cranston & Co., £5 by Mrs. Charles Pease, £2 by the Hon. F. W. Lambton, Esq., M.P., £2 by Herbert Straker, Esq., and £2 by Alfred E. Pease, Esq. In addition to these numerous subscriptions have been received, and a guarantee fund amounting to £60 has been formed to make up any deficiency that may occur. The total amount offered in prizes is £123 10s.

— A GREAT improvement has been recently effected in the GREENHOUSE AT KEW, and the appearance of the house is so much more pleasing that it is worth notice. The side shelves are of stone, and hitherto the plants have been stood on that, the even close surface of the stone interfering with the drainage of water from the pots, and, moreover, quickly becoming green from the growth of *Confervæ* or similar microscopic plants, necessitating frequent scrubbing to keep it clean. Now the shelves have been covered with a layer of the small shells such as are used for walks in some of the parks, which have the advantage of presenting a clean appearance and allowing the water to pass freely from the base of the pots while retaining a suitable moisture. The edges of the shelves, too, have been furnished with a cement rim raised 2 inches above the surface, and within this a border of *Selaginella Kraussiana* has been planted, forming a most beautiful fresh green margin. In the wings, the ordinary green and variegated forms have been planted in alternate lengths, and have a good effect. These alterations, slight though they be, have contributed greatly to the beauty of this house, which is, perhaps, the most popular in the Gardens, and is now well furnished with a variety of flowering plants, *Calceolarias* and *Schizanthuses* being especially abundant, the former with very bright heads of flowers, and the latter with graceful mauve and purplish clouds of blooms.

— A CORRESPONDENT of the *New York Tribune*, writing from Nordhoff, gives the following descriptions of SCENERY IN CALIFORNIA—"Spring is the time to see California. I speak particularly of the valley and mountain district of the southern part of the State between the higher ranges and the sea, not of the coast, for there the spring is the season of fog and wind, and the climate is most agreeable in the early winter. The fogs do not reach far inland. The scenery of the hill country is distinguished by an extraordinary variety—undulating meadows, wide grassy plains, graceful watercourses, broken ridges, chasms and wide cliffs, broad valleys vanishing in distant perspective, lofty summits, forests and open groves, thickets and natural parks, a farmhouse here and there in the midst of Wheat, few roads and fewer fences, nearly the whole lovely face of the country in a natural state. On the coast, as in many other parts of the State, there is a lamentable lack of shade. But here the timber is abundant, and one may ride all day through open woods, where the herbage is green and there is too little underbrush to arrest a horseman."

— "THE characteristic, however, at this season is splendour of COLOUR AND THE FLOWERS IN SOUTHERN CALIFORNIA. The beauty is heightened by strong contrasts and a rapidly displayed variety, and possibly, as some think, by a quality in the pure atmosphere which brings out the hues of the fields and woods and mountains as the varnish finishes the tints of a picture. And then the colours are laid upon the land in such imposing masses. I was about to add that flowers of every colour were scattered

over this fascinating landscape, but 'scattered' is a word which certainly does not apply in this case. Their profusion in the Ojai and similar valleys is indescribable. Try to picture a whole country side covered, not with any single flower, but with a score of species and varieties at once, showing a dazzling arrangement of luxurious tints—purple, and magenta, and gold, and cardinal red, and creamy white, and rising in royal splendour here and there great patches of *Eschscholtzias*, whose yellow petals deepen-

ing to a rich orange centre make the most intense colour it is possible to imagine. The purple wild Hyacinth and the yellow Pansy were the commonest flowers at the beginning of the season. Colour after colour has been added to the show, and so far the old beauties still remain by the side of the new. There is a certain favoured meadow in the Ojai Valley which looks more like a painter's palette than anything in nature, and every week I find some fresh splendour added to it. Just now, after I had



Fig. 98.—*ALLIUM NEAPOLITANUM*. (See page 452.)

thought the array exhausted, up spring masses of blue Larkspur much richer in shade and much ampler in size than the Larkspur of our eastern gardens, and the meadow takes on a wholly novel glory. The flowers will last some time yet, but the vernal brightness of the herbage is already past. At the end of March the deciduous trees, White Oaks, Sycamores, Black Walnuts, and Cottonwoods, were not yet in full leaf, some of them half bare, but the grass was beginning to turn yellow. A rain afterwards revived it. By the end of April, however, the green on the slopes

and roadsides was withering fast, and the dry and dusty ground began to suggest the pitiless summer. It is only for three or four weeks that this natural garden can be seen in its full beauty."

— AT the monthly meeting of THE METEOROLOGICAL SOCIETY, held on the 16th inst., Mr. J. K. Laughton, M.A., F.R.A.S., President, in the chair, F. A. Bellamy, T. A. Mercer, Rev. H. J. Poole, and A. Wise, M.D., were elected Fellows of the Society. The following papers were read:—1, "Composite Portraiture

adapted to the reduction of Meteorological, and other Similar Observations," by G. M. Whipple, B.Sc., F.R.A.S. It has often been remarked that one of the main, if not the chief, of the difficulties the meteorologist has to contend with is the enormous amount of preliminary labour which has to be expended in the not very pleasing task of forming the observations he may wish to discuss into tables, casting the columns of figures so obtained, and then computing the means. With the view of arriving at results by a shorter cut, the author has been led to consider the possibility of employing a method, suggested by a consideration of the highly ingenious system of composite portraiture invented by Mr. Francis Galton, F.R.S., and utilised in his anthropological studies. 2, "Note on Atmospheric Pressure during the Fall of Rain," by H. Sowerby Wallis, F.M.S. The author discusses the condition of atmospheric pressure while rain was falling during 1882, and finds that out of a total of 136 rainy days which were available for his purpose, on 54 per cent. the rain was accompanied by diminishing pressure, on 27 per cent. by increasing pressure, and on 19 per cent. by steady pressure. 3, "New Method of Reading a Thermometer and Hygrometer at a Distance by means of Electricity," by Arthur W. Waters, F.G.S. 4, "An Integrating Anemometer," by W. F. Stanley, F.M.S. 5, "Observations on the Force of the Wind at Sea," by D. W. Barker, F.M.S. 6, "Meteorological Observations at Zanzibar, east coast of Africa, during 1880 and 1881," by Surgeon-Major C. T. Peters, M.B. 7, "Diurnal Rainfall at Bangkok, Siam," by Captain G. H. Inskip, F.R.G.S.

ALLIUM NEAPOLITANUM.

DURING the present spring very large quantities of early flowers have been sent into the London markets, Primroses and Daffodils being particularly abundant, while the neat white flowers of the Neapolitan Allium have been almost equally common. Hawkers and flower-girls have had them in large numbers, thousands of bunches being sold at a penny each under the inviting name of "Star of Bethlehem." These, with the fine varieties of Anemones recently shown at Kensington, Roses, Mignonette, Violets, and many other flowers, are now extensively imported from France during the early spring months, and at the frequent auction sales in Covent Garden Market some thousands of boxes and baskets are disposed of. A large proportion of the contents of these soon make their appearance in the London streets upon the barrows and stalls of a small army of itinerant vendors. The Allium has been an especial favourite this year, and its culture must have been greatly extended, as the importation of flowers has been larger this season than we have previously observed. Nurserymen, too, who make a speciality of hardy plants have been besieged by inquiries concerning it; and that it will soon be far more widely grown in English gardens may be confidently expected, for, except where collections of such plants are particularly attended to, it is not by any means common at present. The demand thus suddenly created for it will, however, receive some check, for the stock in nurserymen's hands is not large, and will probably soon become exhausted, though in another season it will be more extensive.

Allium neapolitanum, of which a correct wood engraving is given on page 451, is a native of South Europe, and consequently rather more tender than some other members of the genus, though it can be safely and satisfactorily grown in a warm border of light well-drained soil; and it is worth cultivation in pots in a cool house, as it could be most advantageously employed in a conservatory or greenhouse. The species has not any claims to novelty, as it was well figured in Sweet's "British Flower Garden" (plate 201) in 1827, and it is there stated that a bulb had been sent some time previously to Mr. Colvill from Professor Tenore at the Naples Botanic Garden. The flowers are pure white, slightly fragrant, and borne in close umbels, which are occasionally more dense than shown in the figure, with shorter flower-stalks.

Another very beautiful bulbous plant, of which flowers are occasionally seen in Covent Garden Market in spring, is Ornithogalum arabicum, that is also a native of Southern Europe, particularly Spain. The flowers are distinguished by their great size, exceeding 2 inches in diameter, pure white, with broad elliptical petals, and a large, prominent, dark green, nearly black

ovary in the centre, which affords a most striking contrast with the white ground colour. The flowers, too, are borne in dense heads, and are very beautiful either on the plant or cut.

FORCING GRAPES VERSUS GROWING GRAPES.

THE great majority of gardeners that have average experience are perfectly aware that it is one thing to grow Grapes so as to have them fit for table in September onwards, and quite a different thing to force Grapes out of their natural season so as to have them ripe in, say, February or till July. This circumstance seems to be either unknown or ignored for some purpose by a writer who ought to know better than attempt ridiculing the instructions as to temperature given by men who have proved that the instructions they have given were necessary when Grapes had to be forced.

Such attempts to establish a new departure in Grape culture by showing that good Grapes can be grown in England under glass with little or no fire heat, resembles nothing so much as the attempt made to teach the old lady her lesson about eggs; for Grapes have been so produced in England since the beginning of the century. If he would teach his contemporaries how to produce Black Hamburgh Grapes in February and March, and Muscats in June, with the temperatures he recommends, then indeed he would confer a benefit; as it is, unqualified recommendation of such low temperatures and pretended corresponding saving of fuel, has been the cause of much embarrassment to many gardeners, whose employers do not possess sufficient technical knowledge to detect the fallacy of the teaching. They are but too ready to accept bold assertion for truth when it seems to point to any saving, and in the interests of both employers and employed I assert without fear of successful contradiction, that ripe Muscats cannot be produced in June and July, nor Black Hamburghs in February and March, or even in April and May, at temperatures from fire heat under 75° and 65° respectively; and those who have been most successful as forcing gardeners know well this is correct.

There have been other recommendations from the same source about the growth of Grapes that have been equally fallacious and embarrassing to gardeners, such as statements that common garden soil will grow Grapes as well as maiden loam. I am uncharitable enough to believe that no man knows better than he does that this is nonsense; if he does not, he stands alone. His teaching by precept does not promise to be for the general good; he should try what practice does. This *would* be a "new departure."—VITIS.

SUMMER AND AUTUMN TREATMENT OF RICHARDIA ÆTHIOPICA.

THE *Richardia æthiopica*, when well grown, is a most useful winter and spring-flowering greenhouse plant, the large white trumpet-shaped spathes borne on stout stems well above broad rich green leaves being very effective either in a cut or growing state. For conservatory, house, or church decoration this plant has few equals, and its value is greatly enhanced by the fact of the spathes and leaves keeping fresh in water for a considerable time after being cut; and yet, generally speaking, the *Richardia æthiopica*, although of easy culture, is not so extensively and well grown as it deserves to be. Therefore, this being the time to lay the foundation for securing a good floriferous display of it during the winter and spring months, a few remarks respecting its treatment may be acceptable, and prove useful to not a few readers of the Journal.

The method practised here with the best results is very simple, and is as follows:—The plants, having been thoroughly watered the previous evening, are reduced to single shoots if the object in view is to increase the stock as much as possible, and planted diagonally in rows from 18 to 24 inches apart every way in a mixture of short manure and loam. The soil is pressed about the roots moderately firm, and as the process of planting is being finished a little of the soil is drawn back from the stem of each plant so as to form a sort of basin for the reception of water, of which, when the roots have taken to the soil and in the absence of rain, they require copious and frequent supplies. A stick is then placed to each plant and the leaves tied to it to prevent their being broken by the wind. These leaves will, however, gradually die, but not before the roots are pushing forth into the prepared soil and fresh crowns or leaves are being formed, and after the lapse of a few weeks the plants will have thoroughly established themselves in their new quarters and continue growing vigorously all through the summer.

About the end of August growth should be checked a little by ringing the individual plants with a spade as far from the stems as the size pots into which they are intended to be potted. About the middle or end of September they may be taken up and repotted in a mixture of two parts loam, one of leaf soil, and one of coarse sand, then watered through a rose to settle the soil among the roots. The pots are placed in the shade for a few days until the roots have taken to the soil, after which they can be transferred to a sunny aspect, when the plants will speedily fill their pots with large hungry roots. At this stage of growth a dozen or two of the plants intended for early forcing might be rested for a few weeks by partly withholding water from the roots.

The *Richardia* being a gross feeder should have liberal and frequent supplies of liquid manure during its flowering period, which, if necessary, may be extended from Christmas to July. An occasional fumigation with tobacco and a free use of the syringe will be necessary to keep the plants free from the attacks of aphides, which are very partial to them, and if not speedily and effectively dealt with would in a short time spoil the appearance of the plants.

Eupatoriums and Solanums also do better planted out. The plants having had their heads and roots previously reduced, the former cut into shape, and the latter disentangled a little, should be planted in the manner recommended for the Callas, varying the distance between the plants according to the size of the latter; their after treatment, with the addition of pinching out the points of the strongest-growing shoots to balance the growth of the plants, being identical.—H. W. WARD.

PRUNING ROSES.

THE question of pruning has been much discussed lately in "our Journal." I agree with those correspondents who incline to late rather than to too early pruning. The base buds must be the reserve—the sheet-anchor of safety. To keep them dormant is an essential point. Of course latitude must be considered. My general rule is to prune about the middle of March, but I do not much mind if it is put off until the first week in April. Monday, the 5th of March, was memorably mild and sunny. I thought I would make an early venture for once, and so pruned a quantity of Hybrid Perpetuals, both standards and dwarfs, in a sheltered situation, and by way of experiment I included one or two Teas in the process. On a more open aspect where only dwarfs are grown no cutting was done. When that terrible snowstorm set in we wished all had been left alone. It is not till quite three weeks later that the last batch was pruned. The Teas, except those on the wall, were all pruned to the ground. In these I have had no losses, and amongst the Hybrid Perpetuals there appears only one plant dead, and that an A. K. Williams. The other plants of the same name, however, look well, and the whole of the Roses seem vigorous. I shall note carefully the difference, if any, between the earlier and the later-pruned Teas, as they were in the same position. Although the bloom may be late, we have high hopes of a good display of Roses.—A. M. B.

THE SOURCES OF GUTTA PERCHA

THE following particulars upon this subject, on which information has been requested, appear in the Kew Report for 1881.

The natural sources of supply of this important substance, and the possibility of their exhaustion, were referred to in the Kew Reports for 1876 (page 23) and 1877 (pages 30, 31). In 1878 Dr. Denny, Assistant Curator of the Raffles Museum, Singapore, made an important report to the Government of the Straits Settlement on the subject. But this document, though an exceedingly careful *résumé* of the present state of our knowledge, did little more than formally record its defectiveness as regards many of the subsidiary resources of supply. It brought, however, into prominence the rapidity with which the Gutta trees are disappearing in the Straits Settlements. Commerce will for a time have its wants supplied by collection made farther afield. But the time cannot be far distant when the natural sources of gutta percha will be definitely used up.

Gutta percha, although similar in chemical properties to caoutchouc, is tough and inelastic, in which respects it is strikingly different. It "slowly absorbs oxygen when exposed to the combined influence of light and air, and is gradually converted into a brittle resin freely soluble in hot alcohol. After having undergone this change it entirely loses its plastic character, and this is one of its principal defects; it may, however, be preserved in the dark, or under water, for an indefinite period without change."

Unlike caoutchouc, which is derived from plants of groups belonging to widely different parts of the vegetable kingdom, typical gutta percha appears to be only yielded by members of the Sapotaceæ.

MALAY PENINSULA.—1, *Dichopsis Gutta*.—There can be no doubt

from the examination of copious specimens that this is the source of the principal kind of gutta percha of commerce. The plant was originally determined and described by Sir W. Hooker in 1847 ("Journal of Botany," vol. vi., pages 463-5). M. Pierre, Director of the Botanic Garden, Saigon, is disposed to cast some doubts upon the determination, but, as I think, without valid reason. *Dichopsis Gutta* formerly existed in abundance in the southern part of the Malay Peninsula; it extends to Sumatra, Borneo, and probably other islands of the Malay Archipelago.

The gutta percha yielded by this species is known in the Straits Settlements as Gutta taban. Two varieties are distinguished—Gutta taban putih (white) and Gutta taban merah (red). The tree producing the former is said by Dr. Denny only to differ from the latter "in the fact that its flowers are white instead of red. Gutta taban, of whichever variety, produces the standard gutta percha of commerce, and is therefore of most importance."

"All accounts agree in the general features of the localities in which gutta-percha-producing trees are found to thrive. Mr. Low describes them as growing in the forests on the side of every hill and mountain in Perak, adding that they do not flourish in the plains. Mr. Murton states that the tree producing Gutta taban is most abundant on Gunongs Meeru and Sayong, and Bujong Malacca. A few large trees still exist on Gunong Bubo and the Thaipeng range, while small plants from 1 to 8 feet are abundant on the granite formations in Perak, up to 3500 feet elevation.

"In Selangor, Captain Douglas describes the trees as growing to a large size on the slopes of low hills in dense primitive forests. They prefer a rich yellowish loamy strong soil, and aspect appears to be of little or no consequence. The young trees require shade and good drainage, the one being afforded by the tree from which they spring, and the other by the sloping nature of the ground in which they grow.

"It does not appear that the juice is collected at any special period. Mr. Low states, however, that there is a very marked difference in the yield of the wet and dry seasons; at the former period an average tree will yield some five catties (a catty = 1½ lb.), while in the dry season it will only yield one. Considerable difficulty, by the way, appears to exist in ascertaining the actual yield per tree; and the difficulty will, owing to native habits of exaggeration, continue until some trustworthy European himself watches the operation. Mr. Murton states that a native gutta percha merchant mentioned 40 catties as the yield of a single tree, while he himself, from other information, puts down the yield at from 5 to 15 catties per tree, and never exceeding 20.

"In view of the enormous number of trees which must have been destroyed, if even 10 catties be taken as an average, I should be inclined to accept the higher estimate. In order to procure the juice the Taban tree is felled, and the bark is then ringed in spaces a foot wide and about 15 to 18 inches apart. The upper end of the tree is usually cut off, as this is said to cause it to bleed more freely. Buckets made of wood, Cocoa-nut shells, or leaves stitched together, are used to collect the juice, which is then poured into a hollow bamboo. Thus far the process for all varieties is the same; but in Perak, while the Teban merah is simply boiled until it solidifies, the Taban putih is boiled with water, salt, and Samak bark, the ingredients named being, it is alleged, necessary to cause solidification. In Selangor, where possibly the second variety is not found, the juice is said to be poured into an iron pan over a very slow fire until it assumes the consistence of a very stiff paste, when it is moulded into convenient shapes for transport.

"The destruction of trees involved in this process is so enormous that it seems impossible for the supply to long continue. It is computed that over seven thousand trees were cut down during 1877 in the neighbourhood of Klang, while four thousand must have perished near Selangor in a single month to furnish the 270 piculs (a picul = 133½ lbs.) returned as exported. The estimated annual export from the Straits Settlements and the Peninsula was given as ten millions of pounds in 1875, which at the high average of 15 lbs. to a single tree, would give six hundred thousand trees. The demand seems always to exceed the supply.

"The principal adulterant made use of seems to be Gutta jelutong. Singapore and Penang are the chief collecting depôts for gutta percha, and a failure in the supply might seriously injure the trade of either port."

2, *Gutta Sundek*.—Although I have constantly urged my correspondents in the Malay Peninsula to send me specimens of the now well-known tree producing this kind of gutta, no material for its adequate botanical determination has hitherto reached Kew.

Dr. Beauvisage of Paris obtained fruiting specimens from Mr. Low, British Resident at Perak, and has identified the species—(*Contributions à l'étude des origines botaniques de la Gutta percha: thèse pour le doctorat en médecine*)—with Payena (*Kerathophorus*) *Leerii*, Hassk.

Mr. C. B. Clarke having, however, examined similar specimens from Perak (communicated by Mr. Cantley, Superintendent of the Botanic Garden, Singapore) while elaborating the Sapotaceæ for the Flora of British India, is of opinion that the identification of Beauvisage is erroneous, and that "without fuller material this tree cannot be safely referred to any genus." It does not, however, seem to belong to *Isonandra* or *Dichopsis*.

Dr. Trimen, Director of the Royal Botanic Gardens, Peradenaya, states in his report for 1880, "I have during the year, through the

kind exertions of Mr. Low, our resident at Perak, received a consignment of germinating seeds of the second best variety of that country. This is called 'Gatah sundek,' and Mr. Low informs me that it forms a very large tree 120 feet high, but quick-growing. From specimens of the foliage and fruit sent with the seeds, it would appear (so far as can be identified without flowers) to be a species of *Payena*. This is a valuable gift, as 'the Gatah trees in Perak sufficiently large to produce the gum are now very rare, and very great difficulty arises in procuring seeds or specimens.' The young plants are growing vigorously in Peradeniya and Heneratgoda."

With regard to *Gutta Sundek* or *Puteh Sundek*, Dr. Dennys's report merely contains the following remarks:—"It is stated by Captain Murray to be identical with *Gutta Taban*. Mr. Murton, however, describes it as the product of a tree differing from *Dichopsis Gutta* in having leaves 'much shorter and broader,' more ovate in general outline, and the pilose hairs on the under surface not so fulvous as in that species. Captain Murray's remark, however, points to the fact that commercially *Gutta Sundek* and *Gutta Taban* are deemed much the same, the former being only an inferior variety."

It is evident from the facts stated above that the running-out of existing natural sources of gutta percha is an event within measurable distance. The preservation of the supply is peculiarly a case for Government and not for individual enterprise. I reproduce here the concluding passages of the convincing report of Dr. Dennys, in the hope that before it may be too late the policy suggested may seriously engage the attention of the Governments of some of our Eastern possessions. "Comparatively scanty as are the details as yet to hand regarding both gutta percha and caoutchouc, two facts may be considered ascertained. (1), That the demand is increasing and is likely to increase for some time to come, and (2) that the supply threatens to become exhausted within a very short period. As regards Singapore, there is ample evidence that both *Ficus elastica* and *Dichopsis Gutta* at one time abounded on the island, and that their disappearance is entirely owing to the want of foresight of those who reaped the first harvest of their yield. In view, therefore, of the very large amount of suitable unoccupied ground at Government disposal, and which is not likely to be wanted for building or other planting purposes, I would respectfully suggest that measures be taken to ascertain whether an appreciable increase to the future revenue of the colony might not be insured by selecting and planting suitable localities.

"It may be difficult for the Colonial Government to exercise a direct influence in favour of care and prudence on the part of the native administrations, but much might be done to encourage enterprise in the formation of new *Gutta* plantations. It may also be worth while to ascertain whether the appointment of European conservators under the control of the residents would not achieve the end of preserving a most valuable monopoly to the different Governments, as it may be assumed that the expenses thus incurred would be amply justified by the commercial results both to Singapore and Penang as depôts, as well as to the original collectors and vendors of such important articles of trade. It is not impossible also that fresh discoveries might be made if not of new trees yielding similar products, of subvarieties which might furnish a commercially valuable substitute, while it is more than probable that vast areas of virgin growth might be discovered in the interior portions of the Peninsula by an explorer under Government auspices.

"The principal obstacles in the way of individual enterprise lie in the time necessary to mature the tree, said to be about fifteen or perhaps twenty years at least, and the difficulty of obtaining seeds, saplings, or cuttings wherewith to commence plantations. These can only be met by the cordial co-operation of the residents and native authorities, the latter needing especially to be convinced that by aiding the movement they will not be depriving themselves of a valuable monopoly. As regards the former it is probable that but very few Europeans would embark capital which would not yield an out-turn for fifteen or twenty years, which, I am informed on botanical authority, is the average time required before a tree is ready for tapping; many trees, indeed, are reputed to be thirty years old when tapped, and it would, therefore, seem that the Government alone could afford to undertake the establishment of plantations. At present we are without data as to probable expense, but, as the trees are essentially jungle trees, and require no care when once fairly started, this may be taken as very low. Assuming that each picul of 133½ lbs. of the best qualities to represent the yield of ten trees, and to be worth 45 dols., ten thousand trees would give a gross return of 45,000 dols. The available crown lands in Singapore could probably grow one hundred thousand trees, at the lowest estimate giving 450,000 dols. in the gross out-turn, though this estimate must be mere guesswork until a proper survey be made. But assuming that the annual income of the colony could be increased by 200,000 dols., or less than half the sum named, the matter seems worth attention; while there is reason to believe that even if the yield from the native states continued at its present figure the additional supply would soon find a market without materially lowering the price."

FACTS ABOUT LEAVES.—In a lecture by Professor Beal of America upon this subject, the following remarks occur:—"As is well known, a tree cannot grow without leaves. These are put forth every year, and are a contrivance for vastly increasing the surface. An Oak

tree of good size exposes several acres of surface to the air during the growing season. It has been estimated that the Washington Elm at Cambridge, Mass., not a very large tree, exposes about 5 acres of foliage, if we include both sides of the leaves. Leaves are more nearly comparable to stomachs than to lungs. A leaf is a laboratory for assimilating or manufacturing raw materials into plant fabric. The cellular structure of the leaves, wood, and bark of a tree is a complicated subject to treat in a popular way. It requires a vast surface of leaves to do a little work. By counting the leaves on a seedling Oak, and estimating the surface on both sides of each, we can see how many inches are needed to build up the roots and stem for the first year. After the first year the old stem of the Oak bears no leaves. It is dependent on the leaves of the branches, or its children, for support. A tree is a sort of community, each part having its own duties to perform. The root hairs take up most of the nourishment. The young roots take this to the larger ones, and they in turn, like the branches of a river, pour the flood of crude sap into the trunk, which conveys it to the leaves, which are the workshops of the plant body. The trunk and main branches also support and hold out the young branches, which put forth the leaves. The assimilated or digested sap passes from the leaves to all growing parts of the plant, and a deposit is made where most needed. If a branch is much exposed to the winds, the base of it has a certain support or certain amount of nourishment. So with the trunk of a tree. If the base of a branch or the main trunk is much exposed to the winds and storms a much thicker deposit of food is made there. The winds give a tree exercise, which seems good to help make it strong. Our toughest wood comes from trees growing in exposed places. The limbs of a tree are all the time striving with each other to see which shall have the most room and the most sunshine. While some perish in the attempt, or meet with only very indifferent success, the strongest of the strong buds survive.

ORCHIDS AT HOLLOWAY.

In the extensive and choice collections of Orchids at the Victoria and Paradise Nurseries, Mr. B. S. Williams has at all seasons of the year a display of more or less magnitude. Large numbers of the most beautiful species and their finest varieties are represented by not only thousands of plants of moderate size, but also in many cases by specimens of unrivalled dimensions, which have won their owner prizes and honours innumerable throughout Great Britain and on the continent. April, May, and June are particularly favourable months for visiting these celebrated collections, and at the present time the display is most satisfactory, grand banks of flowering plants being formed in several houses, and including representatives of hundreds of beautiful varieties. There is also abundant promise of further attractions within the next few weeks, which will prolong the exhibition far into summer, so that visitors may expect ample reward for a journey thither any time within the next two or three months. Mr. B. S. Williams spares no pains or expense to render his collection as complete as possible, and novelties are being constantly added either amongst imported or established plants; and it is quite surprising to note the great number of improved varieties of well-known species that are grown, all well marked, easily distinguished, and much superior to the original forms.

CATTLEIAS.—These are now flowering superbly, varieties of *C. Mossiæ* and *C. Mendeli* being particularly prominent. The range of variation in the former species is very great, some being most richly and deeply coloured, others very delicate, but all are beautiful. *C. Mossiæ alba marginata*, *C. M. Rothschildiana*, *C. M. Alexandræ*, *C. M. elegans*, *C. M. Dodgsoni*, and the Paris variety are only a few of the most remarkable forms. One grand specimen, with 140 pseudo-bulbs and about two dozen flowers, is a great feature in the house, and has a fine effect growing upon a block. The lovely *C. Mendeli* is also in strong force, closely allied to it being that most handsome *Cattleya*, *C. Morganicæ*, which has beautifully formed flowers, white or blush-tinted, the lip fringed, blotched with crimson at the point and golden in the throat. *C. crispa*, *C. purpurata*, and its magnificent variety *Williamsi*, *C. Warneri*, *C. porphyroglossa*, with *Lælia irrorata*, and innumerable others constitute a diversity and richness of colours that no other Orchids can equal.

Cypripediums are also finely represented, the distinct and beautiful *C. superbiens*, with its green-streaked dorsal sepal and dark purple-spotted petals and large lip, is flowering well, one plant having twelve fine blooms and another six. The snowy-white *C. niveum*, the large and handsome *C. barbatum*, the long-petalled *C. Lowi*, and *C. selligerum*, all contribute to the display. *Dendrobiums* are still good, though many are over, and others are showing flowers, especially *D. suavisimum*, of which there is a fine stock.

In the cool house *Masdevallias* and *Odontoglossums* are flowering well, very handsome varieties of *M. Harryana* and *ignea*, with

Odontoglossum Pescatorei and *O. Alexandræ*, being notable. In every house, indeed, there is something of interest and beauty.

PLEROMA ELEGANS.

THIS attractive plant, once generally grown, is now too much neglected. The fact that large flowers are produced most freely on the points of last year's shoots furnishes the key-note to the method of culture to adopt. The next thing essential to success is that it will not thrive if kept in a plant-stove, nor yet will it thrive if kept in a cool greenhouse. In the one case it will get straggling, and the wood will not ripen well enough to bloom freely; and in the other the plant will assume a starved appearance, and become brown and unhealthy.

The plant, occupying a 5-inch pot now well filled with roots, we should transfer to a 7 or 8-inch, draining the pot well, using a little broken sifted charcoal over the drainage—that is, getting rid of the dust; then gently disentangle the roots outside the ball, so that they shall run at once into the new soil, taking care that before shifting the ball is thoroughly and sufficiently moistened, as fresh-potting such a plant dry is next-door to throwing it away. The soil should be in good order, neither wet nor dry, and picked-in pretty lightly among and to the roots.

For plants about this size three parts of heath soil to two of loam should be used; and one part more may consist of silver sand, broken pots, and nodules of charcoal, so as to allow free passage for

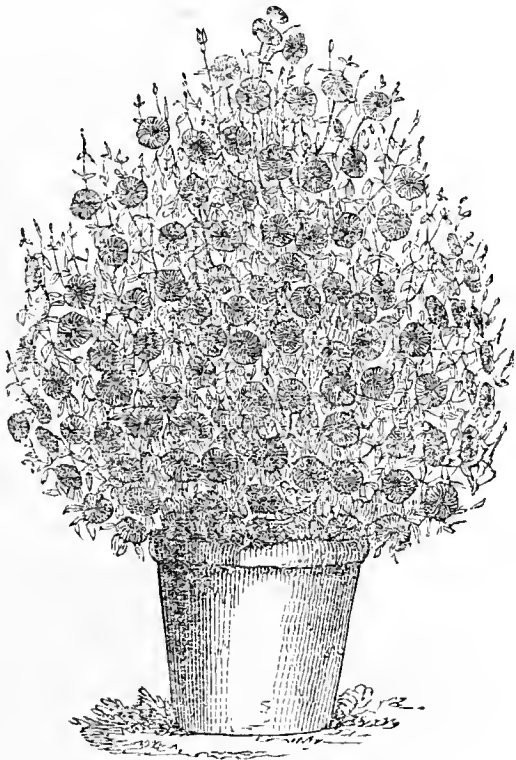

Fig. 99.—*Pleroma elegans*.

water. When the plants come to stand in a 10 or 12-inch pot the fibry loam and heath soil may be in equal proportions, and then the loam will insure more stubbiness in the growth. Then, too, a little fine aerated leaf mould may also be used in the soil. A little moss will likewise be an advantage between the soil and the drainage.

After potting it would be well to raise the temperature gradually from 50° to 60°, using a little shade in bright sunshine, and frequent sprinklings overhead, until the roots are working freely in the fresh soil. Until then water should be given carefully, so as not to deluge the fresh soil until the roots get into it. A skiff from the syringe will be useful in sunny afternoons until the end of July. As soon as the roots are taking fresh hold, the training of the plant should commence, fastening some shoots nearly horizontally, but letting their points have an upright direction, so that the plant when full grown shall have an orbicular form. Many of the shoots will need no stopping owing to their comparative weakness; but all the stronger shoots will need to be stopped several times, so as to insure compactness and regularity of growth. When blooming next season is resolved on, no stopping of shoots should take place after the end of June. Water will be required in greater quantity as the sun gains strength; and as the roots get to the sides of the pot, liquid manure will help to give strength and colour, using it in a clear and weak state. It is necessary to give the plant more air, after July, to consolidate the growths.—J. H.



HARDY FRUIT GARDEN.

GROWTH is so much encouraged by the warm genial weather that the disbudding of Peaches and Nectarines may soon be finished. Make fast to wall or trellis all new growth left on the trees; see that all fastenings are left loose enough to allow young growth room to swell freely and unchecked. If shreds and nails are used keep them away from the fruit, much of which is frequently spoilt by negligence in this matter. Bear this in mind as you are at work upon the trees, and remove any nails used in the winter training that are in the way of swelling fruit. The foliage is wonderfully free from blister this year, but a watchful eye must be kept on it as the weather grows hot, and an occasional thorough syringing given to keep down red spider. The legitimate work of the syringe is to keep the foliage clean. Thin the fruit sufficiently, water the border frequently—once a week is not too often in hot dry weather while the fruit is swelling, and by all means use sewage if you can get it. To have fine fruit in abundance there must be stout wood, large foliage, and a free steady flow of sap; therefore look well to the roots, and see that they are well fed. They are naturally greedy of moisture, and no mere surface wetting will at all suffice. If the drainage is well done there need be no fear of over-watering.

The lateral growth of Pears and Plums is all sufficiently forward for pruning now. This pruning of soft young growth is so easily done that the shoots are frequently and expeditiously nipped off with the thumb nail and forefinger. This has given rise to the somewhat misleading term of "pinching," but in reality it is not a pinch but a clean nip. About an inch of new growth is left on at the base, the object of the nipping being the rapid formation of fruiting spurs. As the season advances attention will repeatedly be called to this important detail of sound practice. Some Pears are shedding much fruit, quite two-thirds of it falling off some clusters, which shows the risk of an entire loss of the crop where premature thinning is practised.

Red and White Currants require attention now, both in nipping off the young growth in just the same manner as the Pears are done, and in keeping down caterpillars, which have already attacked some bushes. Raspberries should have the young canes thinned at once, for they are already a foot high, and will soon crowd and weaken each other if left unthinned. American Blackberries are growing freely, and should have the sturdy young shoots tied in now, and repeatedly subsequently as the growth lengthens, both for neatness and that the fruit may be got at when ripe, which is a difficult matter if the growth with its formidable spines is left untrained.

FRUIT FORCING.

Pines.—Spring-started plants which have been placed in fruiting pots will, if the roots be in a satisfactory state, be making free growth, and, to insure a sturdy habit, allow the plants a distance of about 2 feet apart every way. If favourable weather prevails ventilate betimes, keeping the heat to 85° as a minimum from sun heat, and close between that and 80° for the day; but if the weather be dull maintain at 65° only at night and 70° in the day, keeping the heat uniform at the roots between 80° and 90°. In the fruiting department artificial heat, whatever the weather may be, will be necessary to keep the heat at 75° to 80° constantly; and in proportion to the artificial heat employed the amount of moisture must be regulated, lightly damping the plants with clear tepid water whenever the axils of the leaves become dry. The suckers in the case of vigorous plants are apt to disturb the erect position of the fruit, which should be seen to and obviated by a small stake, as a fruit with a one-sided crown is very objectionable. Offset shoots or suckers which may appear at the base of the fruit should be removed as soon as they appear, as well as those at the base of the crown, and any superfluous suckers beyond the one required for stock. Plants swelling off the fruit freely will need much care in watering, and should always be done by a practical hand, as water with some stimulating agent should be given copiously whenever it is required, and at the same temperature as the roots. Take advantage of solar heat to keep the temperature for fruiting plants at 90° to 95°, closing with sun at 85° to 90°; and when there is the prospect of a sunny day give air in good time.

Melons.—Fruit now ripening will require great care in watering to prevent the fruit cracking, and atmospheric moisture must be reduced, but not discontinued, as the plants often go off quickly after a sudden check of this sort, especially when they are heavily laden; and fruit which ripens after the foliage is gone or even damaged is invariably deficient in flavour. To lessen the necessity for water after the fruit gives indications of ripening, water moderately when those are apparent, and mulch with 3 or 4 inches of short Mushroom-bed manure. Have a good stock of plants ready in pots to place out when the crops are removed, not cramping them in small pots, but shifting on, as by having strong plants 18 inches high or so three or more crops on different plants may be had from one house in a season. The cold weather has not been favourable to plants in frames, but where attention has been paid to linings and covering at nights the fruit will now be making rapid progress. Attend to stopping and thinning the growth before the foliage becomes crowded, employing quicklime upon the first appearance of canker. Raise the fruit on inverted flower pots, and mulch the beds after the final earthing to prevent rapid evaporation. Close early, and damp the foliage at the same time, the plants swelling their fruits. If the sun be powerful when the fruit is ripening a slight shade, as that of tissue paper over the fruit, will be beneficial when it commences changing colour.

PLANT HOUSES.

Petunias are useful plants for decoration during the summer, especially dwarf-growing double forms. Those rooted in autumn and grown similarly to Fancy Pelargoniums are now showing flower. Others rooted some time ago should be potted as they require it, and another batch of cuttings rooted at once. The secret of growing these plants well is to never allow them to suffer by the want of water or root room until they are in their flowering pots, and then feed them liberally. Pots 5 inches in diameter is a good size to grow these plants in for purposes of decoration.

Fuchsias are now growing freely, and if wanted allow the earliest to come into flower; if not they can be pinched again, but this will scarcely be necessary if the plants were well furnished to start with. Pot the young stock to flower in 5 and 6-inch pots as they require it, and strike more cuttings to succeed those previously rooted and in various stages of development.

Chrysanthemums should by this time be in cold frames, and if not placed in 6-inch pots no time should be lost. Those rooted first will be well established in this size, and will be growing rapidly. Ventilate freely during the day, and when mild at night also. Do not stop those intended to produce good blooms, but allow them to grow in an upright position. Pinch the Pompon varieties and those to be grown as bushes from time to time as they require it. Some care must be taken to have these plants thoroughly hardy before their 6-inch pots are full of roots, as from this size they should be placed in their flowering pots, and must be sufficiently hardy to stand outside in some sheltered position. This is one of the advantages of late propagation; if rooted early the plants must either be checked by becoming root-bound or abundance of pit room is required to protect them before they can be placed outside. Cuttings of any kinds may still be rooted, and stopped once or twice afterwards or grown on without. It is a good plan to stop all large-flowering kinds once and allow them to produce three shoots, which will carry three good blooms if the crown bud is selected, or nine fair-sized blooms if the terminal shoots are allowed to form.

Sow seed of Miles' Hybrid Spiral Mignonette in 3-inch pots to be grown for the winter. A little more seed of *Cineraria* and *Begonia semperflorens grandiflora* may also be sown at the present time.

FLOWER GARDEN AND PLEASURE GROUNDS.

Hints upon Planting.—It is altogether unsafe to predict, so very changeable and uncertain is our climate. Early in the month we ventured to assert that bedding-out would be late this season; but the sudden transition from cold to heat has altered the whole state of affairs, and bedding-out, in early localities especially, is being rapidly proceeded with. The ground has been warmed considerably, and the sooner the plants are placed out the better. This applies to Pelargoniums, Calceolarias, Verbenas, Petunias, Centaureas, Polemonium, *Königa variegata*, Golden Pyrethrum, Lobelias, Gazanias, Violas, and Dahlias. Iresines, Alternantheras, Amaranthuses, Coleus, Mesembryanthemums, Perilla, Castor Oil Plants, Solanums, Wigandias, and other tender plants will in most localities be best planted rather later, say during the second week in June. None should be planted in very poor soil. We are apt to be anxious to complete bedding-

out, but in this and other cases it sometimes happens that "the more haste the less speed." For instance, where some of the stock of bedding plants are crowded thickly in boxes, pans, or pots, and which it will be impossible to transplant with a good ball of earth, these may well be potted singly or in pairs in small pots. If these are stood in close frames or pits and shaded for a few days they will soon become well established, and will be in a better condition to withstand bright sunshine. Asters, Zinnias, Stocks, Eschscholtzias, and Helichrysums transplant badly in hot weather, and where grown thickly in seed beds, boxes, or pans well repay a little extra trouble in potting off. Care, however, must be taken not to keep them too long in pots, or they will be injured thereby. These—Marigolds, Everlasting Flowers and Grasses, Phlox Drummondii, Dianthuses, Tropæolums, Poppies, Godetias, and others—pricked out or thinly sown, ought now to be finally planted, selecting if possible dull showery days for the work. Till they are well established it will be advisable to lightly shade from bright sunshine, branches of trees being available for this purpose, and slugs should be kept closely trapped. All these are best adapted for mixed borders.

Where the flower beds which are usually filled with the summer bedding plants above enumerated are cut out of turf, the latter should be mown and the edges cut prior to the trampling consequent upon planting. It is a common practice, in villa gardens especially, to have raised beds, or with centres only very high, the edges being low. This is quite a mistake, as unless thickly planted the beds have a poor appearance, and, besides, the occupants do not thrive in hot weather. These high centres should be levelled down to the edges, the whole being then slightly above the grass. By planting according to the respective heights of the plants, we then have slightly rounded and certainly more effective displays. The surface of the beds to a depth of 6 inches should be broken up finely, and if dry and hard a watering overnight will greatly facilitate planting. The lines or circles ought to be very true, and this is best secured by marking the ground prior to planting. For this purpose we principally use large wooden compasses in two sizes, and which can easily be adjusted, one point of these being kept travelling along the edges of the beds, the other marking the proposed lines. This plan is quicker and more true than the common method of marking with the back of a rake. It is advisable to commence planting from the edges, or in the case of central groups from the outside lines or circles, and gradually fill in. By disposing the plants flatly or in a sloping direction, more especially the Pelargoniums and Verbenas, they may be easily pegged down and arranged so as to cover the beds evenly. The balls, where much root-bound, are best slightly loosened, and all alike should be in a moist state when planted, and when the ground is very dry should be watered in. Branches of trees may be employed for shading during the hottest part of the day, and during cold nights they would also prove of service in preventing the loss of heat by radiation.

It would be difficult to suggest arrangements to suit many readers, as so much depends upon the variety and quantity of plants and the shape and position of the beds in every instance. Very glaring contrasts should be avoided; at the same time if the surroundings are heavy the beds cannot well be made too bright. To produce a good effect not many kinds or varieties should be employed in one bed. A dwarf brightly coloured edging may be formed with either Lobelias, Pyrethrum, Mesembryanthemum, Alternantheras, Stellaria, Sedums, *Dactylis variegata*, *Festuca glauca*, Cerastiums, Gazanias, Violas, Ivyleaf Pelargoniums, Robert Fish Pelargoniums, *Königa*, *Stachys lanata*, and *Cineraria maritima*, the six first named being best adapted for edging where the margins of the bed are faced with *Echeveria secunda*. The next line or circle may consist either of the more dwarf kinds of Pelargoniums (variegated or otherwise), Iresines kept stopped or pegged down, Verbenas, Calceolarias, Centaureas, *Begonia Weltoniensis*, Tuberous-rooted Begonias, *Polemonium caruleum variegatum*, and *Ageratum*; while Fuchsias, Calceolarias, tall-growing Pelargoniums, Iresines, Perilla, *Verbena venosa*, Heliotropes, and *Salvia patens* are suitable for massing in the centres. In the centre circular beds a good-sized erect-growing specimen of Centaureas, *Dracena terminalis*, *D. Draco*, *D. australis*, *Yucca recurva pendula*, *Yucca aloifolia*, *Agave americana variegata*, Palms in variety, Aralias, Cannas, *Ricinus Gibsoni*, *Zea japonica*, Solanums, *Ficus elastica*, or other fine-foliaged plants will greatly improve the appearance of the beds where flatness may be objected to. All the latter are available for grouping or dotting among dwarfer-growing bedding plants. The eight first mentioned would in most cases be best plunged in pots, care being taken to keep them supplied with moisture.

Mixtures are fashionable, and, where well arranged, are very pretty. Blue Lobelias, alternated with either Pyrethrum, *Königa variegata*, Golden Thyme, *Dactylis glomerata*, and *Festuca glauca* forms a good edging, or the centre of a small bed edged with *Alternanthera amœna* or *magnifica*. Blue Violas, mixed or alternated in diagonal lines with bronze, golden, or silver variegated Pelargoniums, surrounded with a broad flatly-pegged band of Iresines and edged with Lobelias, are very effective. The same may be said of a mixture of *Verbena venosa* and Pelargonium Bijou or *Veronica Andersonii variegata*. A mixture of Iresine Lindeni and *Gazania splendens*, edged with blue Lobelias, scarlet or purple Verbenas, with Pelargonium Manglesii, edged with Pyrethrum; Iresines with yellow *Calceolarias*, edged with Flower of Spring or Mrs. Mappin Pelargoniums; *Zea japonica variegata*, mixed with *Salvia patens* or *Verbena venosa*, surrounded with Iresine Herbstii or *Amaranthus melancholicus ruber*, and edged with Robert Fish or some other golden or silver variegated Pelargonium, are all showy arrangements which may be imitated or improved upon according to the material available.

THE BEE-KEEPER.

DRIVING BEES FOR ARTIFICIAL SWARMING.

ARTIFICIAL swarming can be practised either with straw skeps or bar-frame hives. With the former it is necessary to drive out the swarm into an empty skep. The way to do this has been so often explained, and can now be seen at bee shows in all parts of the kingdom. But many may have bees for the first time this season, and for their sakes we will tell, in as few words as possible, how to drive a swarm from a skep. We must suppose the owner of the bees first ascertains that his bees are ready to spare a swarm. He will require for the purpose two empty skeps, a smoker or roll of smouldering rag, a little thin syrup, and three skewers or two pieces of stout wire bent as shown in fig. 100, which are preferable, and always handy for driving condemned bees in autumn. The best time to drive a swarm is in the middle of a hot still day, when a great part of the bees are away in the fields. Most of the young bees will then be secured in the swarm, and the brood hatching

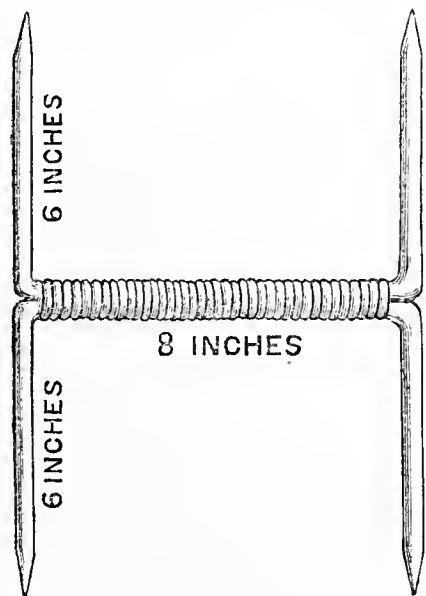

Fig. 100.

out daily will soon take their place, the returning bees taking up the duties of the hive meanwhile. A puff or two of smoke should be blown in at the mouth of the hive, and the hive gently tapped two or three times to scare the bees. In a few minutes, during which, if the skep to be operated on has a dome-shaped top, a zinc pail should be placed in a quiet spot some yards from the stand, and the wires placed handy for use with an empty skep. The other empty skep is to be placed on the stand as soon as the stock is removed—to keep the bees amused as they return from foraging. Four minutes after scaring the stock with smoke and tapping quietly, turn it upside down, and not forgetting to place the decoy hive in its position, carry the inverted stock to the pail: it will firmly stand on that receptacle. Sprinkle over the bees the thin syrup, and allow them a minute or two to gorge—they have already begun to do so from the honey-cells. This will allow time to fix the empty skep over the full one at about an angle of

45°, in such a manner as to get as much light as possible on the junction of the hives, so as to see the procession well, and, if possible, to have a good view of her majesty as she ascends. Nearly all the bees may be taken in the swarm, and thus the presence of the queen be almost certain. Gently patting the lower hive on both sides with the flat hand the bees will soon run up, and the whole thing done much easier and quicker than one can write how to do it. An artificial swarm from a bar-frame hive is a much easier matter. Sufficient bees are shaken off the frames, taken out one by one into an empty hive, the queen's, of course, being secured. A comb of brood and eggs should be placed with the swarm, and full sheets of foundation given, and the swarm will soon be as powerful as the stock.—P. H. P.

BRITISH BEE-KEEPERS' ASSOCIATION.

THE exhibition of bees, hives, honey, &c., arranged by the Committee of the above Association to be held at Bridgewater during the continuance of the Bath and West of England Agricultural Show, was opened on Monday. Although not an extensive exhibition, the show of appliances is pronounced to be one of the best ever held out of London. Prizes were awarded as follows:—For the best observatory hive, first and second prizes, Mr. T. B. Blow, Welwyn, Herts. These hives were of the best manufacture. Mr. Blow was also awarded first prize for an admirable and extensive collection of appliances. Messrs. Richards & Honey of Exeter, and Mr. S. J. Baldwin taking second and third prizes respectively. Mr. S. J. Baldwin was awarded first prizes for well-made hives in the classes at 15s. and 10s. 6d. each. Messrs. Richards & Honey, Mr. C. T. Overton, Three Bridges, Sussex, and Mr. A. Blake, Dallinghoo, Suffolk, are also prizewinners. The show of honey is small, owing to there being but a small quantity of this year's on hand.

PLEASURES AND PROFITS OF BEE-KEEPING.

FIVE and fifty years of pretty extensive experience among bees has deepened the interest and pleasure I take in their management. Unlike some poets, philosophers, and naturalists, I have kept bees for profit, and in doing so I have derived intense pleasure and enjoyment; and age and infirmity do not lessen the interest I have so long taken in the habits and management of bees. They have afforded both pleasure and profit to our family for nearly eighty years. It therefore becomes me to speak well of bees. In their history we have found problems difficult to solve, and in their habits very much to command admiration. There is something interesting to thoughtful minds in the fact that every hive of bees is a numerous, separate, and independent family, thoroughly loyal to the interests of their own community, and hold no fellowship with the bees of other hives; also that the industrial instincts of bees everywhere prompt them to seek and find their own food in summer, and store up enough, and often more than enough, for their own keep in winter. Bees work night and day, and if set in a strange place, or on a foreign shore, they go to work with all possible speed. In every bee-hive at certain seasons there is a queen, or female; males, or drones; and working bees. In this wonderful community, perhaps the most wonderful things are done in the preparations made for swarming; for the creation, birth, and enthronement of queens; the creation of drone life at the proper time, and its destruction when drones are useless and hurtful to the community. The lives of working bees, which are both masters and slaves of the community, present features of interest to men of intelligence. Amid the toils and activity of summer life, and the rest of autumn and winter, who has ever found working bees asleep? Who can affirm that they ever sleep at all? The wonders of a bee-hive has never been fully told, and we expect that future researches will discover many more pleasing features in the history of bees. All we wish to say here on this subject is, that bees have been a perennial and increasing source of pleasure to us and many of our friends and acquaintances, and doubtless will be to future generations.

We say the same thing as to profit. We are quite satisfied with our bees and with the kind of our bees. Properly managed they never fail in fair weather; and if I were to spend money in seeking better bees and hives than I have, I should fail to find them—the money would be misspent. The folly of spending money on costly hives and new bees becomes more and more evident every year. If ladies and gentlemen want to have a profitable return from their bees let me kindly suggest a diminution of expenditure on hives and a search after better bees. Our bees never degenerate. In good-sized straw hives filled with common bees we have known many swarms rise in weight to 140 lbs. and 150 lbs. each first

year or first four months of tenancy. This ground has been gone over before, but I go over it again merely to let the readers of the Journal know that my convictions and practice remain unaltered amid the reported discoveries of scientific apiculture.

So far as present appearances go we are, I think, likely to have a good harvest of honey this year. March was very unfavourable, and cast the bees back very much. At the end of the month they were much worse and of less value than they were at its commencement; but April and May have been better, and some of the strongest hives in our neighbourhood reached the swarming point at the Queen's birthday. I had one swarm on the 24th, another on the 26th of May, and some were before mine. The Apple and Sycamore trees are not yet out of blossom, and Clover, Beans, Limes, and Heather—all excellent honey plants—are yet to come into flower, giving encouragement to hope for an abundant harvest of honey this year.

I am sure that apiarians will learn by experience, and bee culture will advance and become more popular and profitable; and the more popular and profitable it becomes the more easy and pleasant it is to the bee-master.—A. PETTIGREW.

TRADE CATALOGUES RECEIVED.

E. G. Henderson & Son, Maida Vale, London.—*Catalogue of Soft-wooded Plants.*

John Laing & Co., Forest Hill.—*Catalogue of New Plants and Tuberous Begonias.*



* * * All correspondence should be directed either to "The Editor" or to "The Publisher." Letters addressed to Dr. Hogg or members of the staff often remain unopened unavoidably. We request that no one will write privately to any of our correspondents, as doing so subjects them to unjustifiable trouble and expense.

Correspondents should not mix up on the same sheet questions relating to Gardening and those on Poultry and Bee subjects, and should never send more than two or three questions at once. All articles intended for insertion should be written on one side of the paper only. We cannot reply to questions through the post, and we do not undertake to return rejected communications.

Books (*D. Lever*).—As a "compact and inexpensive work on general gardening," we know of no better volume than our "Garden Manual," price 1s. 6d., post free, 1s. 9d. (*G. D.*).—Mr. Iggulden's pamphlet on the Tomato will give you the requisite information, and can be had post free from this office, price 1s. 1d.

Duke of Buccleuch Grape (*R. P. W., Dublin*).—If neither the remarks on page 399, nor those in answer to "H. S." in the next column are sufficiently clear, please state as perspicuously as possible exactly what you desire to know, and we will endeavour to supply the information.

Lawn Mower Defective (*Master and Gardeners*).—Perhaps the plate requires grinding as well as the knives. The part of the lawn that is damp will probably need mowing twice as often as the other portion. "Ordinary smiths and engineers" vary in competency like other men. We can only answer letters that arrive on Wednesday in the briefest possible manner, if at all.

Carpet Bedding (*H. D.*).—Write to Mr. Graham, Garden Superintendent, Hampton Court Palace, Kingston-on-Thames, and he will, we think, be able to send you a treatise that will give you the requisite information. We are not certain about the price, but we think it is a shilling.

Vine Leaf (*J. C., Nubourne*).—We received your letter containing a Vine leaf to which you make no reference, and there was no insect to which you ask our attention. We unfolded the leaf carefully and made a close search for an insect, but without avail. You either omitted to enclose it or it was pulverised in transit through the post.

Inarching Vines (*E. D. Moss*).—We have no means of knowing the cause of your failure, but is the result probably of some defect in splicing. However, as the attacked Vines are in pots, you can now inarch their young growths to the corresponding growths of the stock Vines. You will find the process sufficiently detailed in another column, and if you follow the instructions there given you will succeed in effecting your object.

Manure for Mushrooms (*H. F. S.*).—It is not essential that the manure for Mushroom beds should be gathered from those stables where Wheat straw exclusively is used for litter, but Barley straw decays more quickly. Many persons grow Mushrooms without using any straw at all, but simply horse droppings, yet a considerable quantity of decaying straw is advantageous.

Cytisuses (*C. P. L.*).—The gall-like nodosities you have sent are, we think, the result of the plants having long been much root-bound, being simply an enlargement of the roots in that form by the resistance they met with to their further extension. A similar result follows with *Dracenas* and some other plants that have long been root-bound. As you have repotted the plants we apprehend they will thrive satisfactorily under good treatment, but it would have been better if they had been repotted before.

Pansies (*Grately*).—We presume the flowers you have sent are seedlings that have been raised in your garden. They are excellent border varieties, many of them of great size and good substance. They are also bright and diversified in colours, and generally above the average merit of blooms that are sent to us as the produce of purchased seed, though they are not better than those that have been forwarded by Mr. Hawley and referred to last week. They lack the properties that constitute good florists' flowers, inasmuch as the colours of your flowers "run," and the lacing is not clearly defined. Yet, notwithstanding, they are highly effective and have been well grown.

Removing Dendrobium nobile Pseudo-bulbs (*Agent*).—Some growers have advocated removing the old pseudo-bulbs, but we have found it disadvantageous in the majority of cases, and it is rarely practised except as an experiment. It is probable that the plants derive some degree of support from these old pseudo-bulbs, as other Orchids of this description do, and we have seen plants which have made comparative weak growth after such pseudo-bulbs had been removed, proving that they had suffered in some way. The plants do not require repotting every year unless they are increasing in size very rapidly, and the best time to pot them is when the growth is commencing.

Caterpillar on Pear (*Diseased Leaves*).—This is the caterpillar of the mottled amber moth, *Hybernia defoliaria*, which feeds on Oak, Blackthorn, Whitethorn, and various trees, occasionally upon the Apple, Pear, and Plum in orchards. The peculiar appearance in the leaves noticed by you arises from the effects of the sunshine upon foliage which has been partially gnawed by the caterpillars. It is easy to shake the caterpillars off the branches or twigs, or to pick them off; but they seldom appear upon fruit trees in any numbers to be injurious. As the eggs are laid upon the bark very early in the spring they may be sometimes detected and removed when other insects are being sought after. Syringe the trees with a solution of hellebore, prepared as described in answer to a correspondent on page 393 in our issue of the 10th inst.

Packing Grapes at Clovenfords (*Inquirer*).—Mr. Thomson has favoured us with the following information on this subject:—"In reply to inquiries about the way we pack our Grapes for market, I have to say that our baskets have no lids, that they are just filled and set, four in the bottom of a box, then a division-board is let in over them, but not touching them. On this four more baskets are set and the lid let down and locked, the lid not touching the Grapes either. We have a special arrangement with the railway, by which our boxes are placed in an express van, and never turned over or shaken till our agent in London gets them out of the van into a spring conveyance he sends to meet them. This system of packing would never suit where all the railway arrangements named cannot be effected."

Duke of Buccleuch Grape at Clovenfords (*H. S.*).—The Vines of the Duke are placed 6 feet apart, the variety being on its own roots, and there are from three to five rods from each main stem. Mr. Thomson cuts out as much old wood as possible every year and lays in new. This Grape fruits best on the last year's long rod—that is, a rod from 3 feet to 6 feet long. Grand crops of it are showing this year, as always on the above system. The great secret is to have the young wood well ripened by exposure to plenty of light and air. Treatment the reverse of this has led to failure. It is a most vigorous grower, and on this account it especially needs to have its wood well ripened. If the roots are outside some tarpaulin or such-like should be laid on the border to throw off the summer rains and prevent the cracking of the berries. This is the teaching of Mr. Thomson, and is founded on his successful practice.

Commercial Fruit Culture (*C. H. Van P., Antwerp*).—There are no doubt men in England quite competent to cultivate all you require—trustworthy intelligent men of irreproachable character; but the only method we can suggest for securing applications is to fully advertise your wants. We suspect a competent man would expect a reasonable fixed salary, and we have no doubt he would not be satisfied without endeavouring strenuously to earn it. We quite understand what you want, and believe such men as you require are procurable in England at the present time. The best of them, however, would no doubt desire to inspect your establishment and determine for themselves the prospect of success before entering on an engagement; and in England it is customary for gentlemen to defray the travelling expenses of men whom they invite, whether they are afterwards engaged or not. A written agreement duly signed in such a case as this would be desirable in the interests of both parties.

Pelargonium Leaves Diseased (*T. B. Jesmond*).—The leaves indicate that the plants have received a very serious check, which amounted at the time to an almost total cessation of root-action. They will not readily recover until some of the old soil is removed and the roots are placed in contact with fresh compost. This, with genial weather, will promote fresh growth. When plants are removed from the moist atmosphere of a warm house and placed in a frame exposed to drying winds and sun, the moisture is extracted from the leaves faster than it is supplied by the roots, which have been checked by the cold, and the foliage necessarily turns brown and shrivels. Had the plants been shaded for a time when placed in a lower temperature and drier atmosphere they would now be in better condition.

Wasps on Cotoneaster (*H. B.*).—They are wasps, not hornets, that you have sent, and which "for more than a week have infested in great numbers a Cotoneaster growing up the house, and which is now in bloom. They are not seen upon any other of the flowering shrubs, but many have been found under the coverings of the bee-hives." We were not aware that wasps had such a great partiality for the Cotoneaster, but we know they have for bee-hives, and are great robbers where the bees are too few and weak to successfully defend their home. By closely watching and following the wasps towards evening their nests can be found and destroyed by pouring tar into them. This should be done at night, and the holes stopped up with soil.

Training Melons (*Doubtful*).—You have done quite right so far in topping the plants and securing the requisite number of growths for covering the bed. These, you say, have grown 6 or 8 inches, and you are advised to top them again; but you hesitate doing so on the ground of too many growths resulting and overcrowding the foliage. It is a healthy sign when young gardeners think for themselves, and are able to advance a valid reason for the course they adopt. Let the growths extend until they reach within a foot or so of the sides of the frame, then nip off their points. These main growths should be quite a foot apart, as the laterals they will produce after topping will be more than sufficient for filling the frame, and after the requisite number of fruits are set you may remove the superfluous growths entirely. The fruit-bearing laterals should have the point removed at a leaf beyond the fruit, even before that leaf is larger than a sixpence. Melons should be pruned throughout the season with the finger and thumb, and thus overcrowding be prevented; this being far better than allowing a thicket of growths and then removing large quantities at a time, injuring the principal leaves in the process, and consequently impairing the size and quality of the fruit.

Cinerarias (*Mrs. Robbs*).—It is quite soon enough for sowing seed, and the plants raised now will grow abundantly large enough for your small greenhouse. Those of your neighbours now potted off will be no better than yours are if you grow them well. When very early the plants are apt to become root-bound in summer, unless repeatedly shifted, and in this case they are often grown too large for narrow stages, and the pots are unwieldy. Place rich light soil in well-drained pots filled to within an inch of the rim; water it well, then sow the seed, covering it in the lightest possible manner with very fine soil. Place a square of glass over the pot, and on this a piece of thick paper, at the same time standing the pot in a saucer of water. A moist shaded position in a frame or greenhouse will be suitable, removing the paper immediately the seed germinates, then gradually admit air to the plants until the glass can with safety be removed.

Walls at Right Angles (*E. T.*).—Undoubtedly the walls should be at right angles, and you must be unfortunate in your bricklayer if you "cannot trust him" to set out the work. There is more than one way of doing this, but as you want to proceed on geometrical lines you may adopt the method represented by the figure. The line A B is 2 inches long, and for the purpose in view

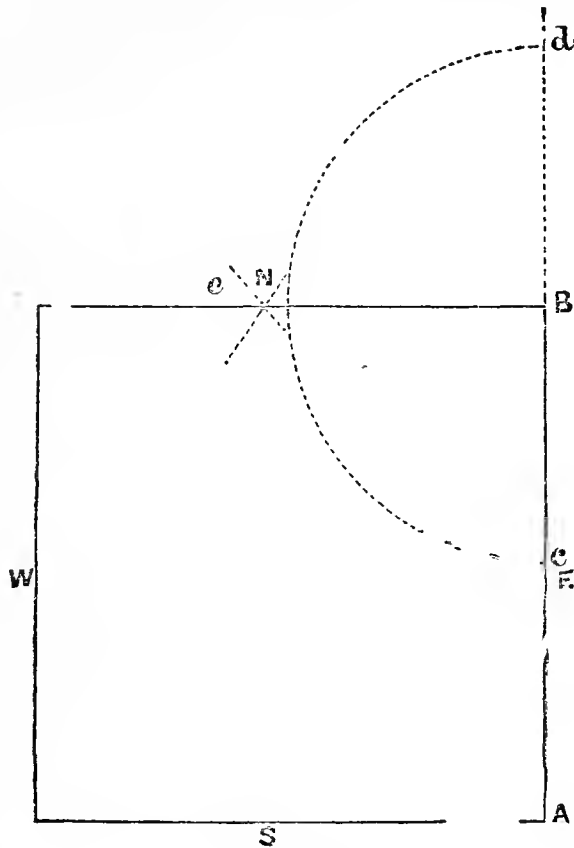

Fig. 101.

we will say that it represents 20 feet, or the wall running from south to north as above described. Extend the line 1 inch, or 10 feet beyond B, and take that length as a radius, and describe an arc touching at points c and d. The width from c to d is equal to one side of the figure. Now take three parts, or 15 feet of this width, and from points c and d describe the arcs at e, then draw a line from B through the intersection at e, and it will give you the direction the north wall ought to take to be at right angles with A B. Proceed in the same manner to find the course of the other walls, and the square will be completed.

Wireworms in Gardens (*E. Lucas*).—We know of no "easy method" of eradicating this pest. Perhaps Mr. Luckhurst's experience may be useful to you, but you may not regard his plans as "easy." He has recorded:—"Very early in the year a field was placed under my care as a kind of auxiliary kitchen garden for the cultivation of Potatoes and other culinary roots. The soil, which for many years had been stirred no deeper than about 4 inches by means of a light one-horse plough, was found to be in a very poor, almost inert condition. A liberal dressing of rich farmyard manure was carted on to it; it was well stirred and thrown up roughly to a depth of fully 9 inches with spades, and in due course about an acre of it was planted with Potatoes. Now, neither in digging nor during the planting were many wireworms perceptible, yet, upon examination a short time afterwards, there was hardly a tuber without several wireworms attacking it—some just commencing operations, others which had burrowed so deeply as only to leave a short portion of their wiry bodies visible, while all with unerring instinct were gathering to the richest feast they had probably met with during their existence. Such an unpleasant occurrence might be regarded either as a serious dilemma or as a capital opportunity of clearing the soil of such a pest, and so saving not only the present but future crops from its ravages. While taking the latter view, the former one, which seemed to point to possible failure, was only felt as a spur to exertion, and a couple of men were immediately set to take up the Potatoes one by one with trowels, destroying every wireworm that could be found, and replacing the Potatoes in the soil as they went along the rows. It was a long and tedious job, but it was undoubtedly a thorough one, for it was computed that upwards of ten thousand of the enemy were destroyed; and so the battle was gained, the crop proving an excellent one, sound and free from every blemish. The experience which has thus been gained will prove invaluable in future practice; and whenever land is found to be infested with wireworms I feel assured that Potatoes placed a few inches beneath the surface and about 2 feet apart for a week or two, will prove an unfailing bait to lure them to destruction." If any of our readers can inform us of an easier and at the same time effectual mode of extirpating wireworms, we will readily publish it.

Chrysanthemums (*J. E. B.*).—As the plants as ordinarily grown are much too large for your greenhouse, the only course we can suggest is to propagate later. Cuttings may be struck at any time until the middle of July. We have had most useful and attractive little plants from cuttings inserted in early August, and also by having large plants growing in a border, and layering

the shoots from them towards the end of that month, each shoot being twisted so as to rupture the bark before being pegged in the soil. This answers quite as well as tonguing the layers, and is safer, as they are less liable to break off when being affixed in position.

Names of Plants (*T. R.*).—*Pyrus pinnatifida*. (*C. P., Morpeth*).—1, *Ranunculus amplexicaulis*; 2, *Sisyrinchium grandiflorum*. (*A. de S.*).—The red and yellow flower is *Siphocampylus bicolor*, and the other is *Chareis heterophylla*. (*F. S. J.*).—*Celsia arcturus*. (*A. B. S.*).—1, *Diplacus glutinosus*; 2, *Celsia arcturus*; 3, cannot be determined without flowers; 4, *Kleinia tomentosa*; 5, *Tussilago Farfara*. (*Nemo*).—A fragmentary specimen like that you sent cannot be named. Your other question will be answered next week.

COVENT GARDEN MARKET.—MAY 30TH.

THERE is no appreciable alteration in the tone of business, and prices remain practically the same as last week.

FRUIT.

	s.	d.	s.	d.		s.	d.	s.	d.	
Apples.....	1	0	7	0	Grapes.....	lb.	3	0	6	0
".....	per barrel	20	0	40	Lemons.....	case	10	0	20	0
Apricots.....	doz.	0	0	0	Nectarines..	dozen	0	0	0	0
Cherries.....	1/2 sieve	0	0	0	Oranges.....	100	6	0	10	0
Chestnuts.....	bushel	10	0	12	Peaches.....	dozen	18	0	21	0
Currants, Black..	1/2 sieve	0	0	0	Pears, kitchen..	dozen	0	0	0	0
" Red.....	1/2 sieve	0	0	0	" dessert.....	dozen	0	0	0	0
Figs.....	dozen	0	0	0	Pine Apples, English	lb.	2	0	3	6
Filberts.....	lb.	0	0	0	Raspberries.....	lb.	0	0	0	0
Cobs.....	100 lb.	0	0	0	Strawberries....	lb.	4	0	6	0
Gooseberries....	1/2 sieve	0	0	0						

VEGETABLES.

	s.	d.	s.	d.		s.	d.	s.	d.		
Artichokes.....	dozen	2	0	4	0	Mushrooms.....	punnet	1	0	1	6
Asparagus, English	bundle	3	0	6	0	Mustard & Cress..	punnet	0	2	0	3
Asparagus, French	bundle	2	0	10	0	Onions.....	bushel	2	6	3	6
Beans, Kidney....	100	2	0	0	Parsley.....	doz. bunches	3	0	4	0	
Beet, Red.....	dozen	1	0	2	0	Parsnips.....	dozen	1	0	2	0
Broccoli.....	bundle	0	9	1	6	Peas.....	quart	3	6	0	0
Cabbage.....	dozen	0	6	1	0	Potatoes, New....	lb.	0	4	0	10
Capsicums.....	100	1	6	2	0	Potatoes.....	cwt.	6	0	10	0
Carrots.....	bunch	0	4	0	0	" Kidney.....	cwt.	6	0	10	0
Cauliflowers.....	dozen	2	0	3	0	Radishes.....	doz. bunches	1	0	0	0
Celery.....	bundle	1	6	2	0	Rhubarb.....	bundle	0	4	0	0
Coleworts.....	doz. bunches	2	0	4	0	Salsafy.....	bundle	1	0	0	0
Cucumbers.....	each	0	4	0	8	Scorzonera.....	bundle	1	6	0	0
Endive.....	dozen	1	0	2	0	Seakale.....	basket	1	0	2	0
Fennel.....	bunch	0	3	0	0	Shallots.....	lb.	0	3	0	0
Herbs.....	bunch	0	2	0	0	Spinach.....	bushel	5	0	6	0
Leeks.....	bunch	0	3	0	4	Tomatoes.....	lb.	1	6	2	0
Lettuces.....	dozen	1	3	2	0	Turnips.....	bunch	0	2	0	3



POULTRY AND PIGEON CHRONICLE.

HAY-SAVING BY MACHINERY.

(Continued from page 440.)

WE must now refer to the hay-drying and cooling machine, tried at the meeting of the Royal Agricultural Society held at Reading, Berks, in July, 1882. These trials took place seven or eight weeks after the failure of exhausting fans at Cardiff, notwithstanding which and the fact of Mr. M. Sutton having offered a prize of £100 for the most efficient and economical method of drying hay artificially either before or after being stacked, the Judges report that although "the various adaptations of the Neilson system exhibited have been tried on meadow hay in the stack, and three of the most powerful fans exhibited by Mr. Coultas, Messrs. Lister & Co., and Mr. Phillips, the results as regards hay can in no case be considered satisfactory, taking into consideration all the circumstances under which the hay was put together. None of the exhibitors proved that they were able to make good hay in wet weather. In a few instances where fairly good hay was obtained, equally good if not better hay might have been secured without the application of the fans." We must call this display of attempting the drying or cooling of hay by the exhausting-of-heat fans as not only a gigantic and serious blunder, but as the abortive attempt at Cardiff was before them, it makes the case more glaringly damaging to the efforts of all concerned, especially when, as is now ascertained, that these trials and the

attendant expenses cost the Society the extraordinary sum of £2241. Now all this is bad enough, but the practical farmers throughout the kingdom have been seriously discouraged thereby, as it appears to us entirely in consequence of the exhibitors of their machinery not adhering to the principles and details laid down and acted upon with success by the originator of the system, Mr. Neilson, with so much skill and perseverance, for a number of years previously.

We have next to notice Mr. W. Gibbs' hay drier, as exhibited at the Cardiff meeting. It was sent by Mr. Fuller, and was a full-sized machine, price £350, which, owing to its large dimensions, had to be sent (the greater part of it) by road from Neston Park, Wiltshire, to Cardiff. The object of this machine is to open out the masses of wet grass introduced into it, and expose all portions equally to the drying action of heated air. The grass is forked into the higher ends of two parallel troughs, one being on each side of the machine, the bottoms of which have a reciprocating action. A progressive motion towards the delivery end of the machine is given to the grass, partly by the inclination of the troughs, which is regulated by the elevators at their lower ends, and partly by the action of a set of tines carried on a crank-shaft over each trough. The two furnaces, which are fed with coke, and the fan for obtaining the blast of hot air, form a separate part of the machine carried on its own wheels. The heated air is drawn by the fan direct from the furnaces, and passed through a large tube furnished with a pyrometer and throttle valve to the series of air ducts, by means of which it operates on the grass during the whole period required for its passage along the troughs.

It would seem that success in the making of good hay is greatly due to skilful management of the machine, and care should be taken (1) that the grass be brought to be dried at one time in a uniform condition as regards moisture; (2) that the temperature of the blast be sufficient to completely effect its purpose by passing the grass once through the troughs, and that the temperature be not high enough to scorch. To obtain uniformity of moisture, or rather of dryness, would require sufficient turning in the field during the operation of withering the grass, without which it would be most undesirable to bring it to the hay-drier, which is only intended to be used as an auxiliary to the sun and wind in the making of hay. Intelligent supervision and prompt action are required to regulate the heat, amount of the blast, and the progressive motion of the grass through the troughs, for which there are proper means provided.

It will be seen that the two systems advocated by Mr. Neilson and Mr. Gibbs start fairly in the same object of completing the saving of hay after it has been about half or three parts made in the field, and to this important fact we desire to call the attention of the home farmer, and ask him to forget in the future that any such idea as stacking or treating hay or grass in the wet state and be able to reduce it to good hay has ever been advocated, or expected to be accomplished by any of the various drying machinery which has yet been invented. An observation by Mr. Champion, the manager of the Sewage Farm at Reading, is very suggestive. He says: "On behalf of Mr. Gibbs' machine, give me half-made hay, and I don't mind its being water-wet." The exhibitors of fans, on the other hand, said: "We can take green hay if only it is dry." The distinction between the two processes is thus clearly indicated. Mr. Gibbs aims at expelling the moisture of the hay, whether natural sap or rain-water. The exhaust fans are designed for the reduction of the high temperature, which is the result of fermentation. It appears that the actual result of Mr. Gibbs' process at the Cardiff meeting on a stack of 18 tons of hay, which was cut on the 15th of September, with the exception of a few streaks of white mould,

proved to be fairly good hay, though it was somewhat brittle to the touch; however, the cattle ate it readily. The market price, being the offer for it, was £3 per ton. Again, the result of the trials at Reading of hay from Mr. Gibbs' machine was very noticeable, inasmuch that while some of the hay was completely desiccated, so that it smelt like malt, and could be rubbed into powder in the hand, yet some of it emerged from the machine quite clammy.

The Judges' report gives the following information:—"Mr. Gibbs' machine was tried on meadow hay, and afterwards on sewage Rye Grass. In the first trial, which was made under fairly favourable conditions, the exhibitor failed to make hay of as good quality as might have been made in similar weather without any artificial means. The result of the second trial, which upon sewage Rye Grass was more satisfactory, and we are of opinion that on sewage farms where Rye Grass has to be converted into hay, the machine might be a useful auxiliary, but the prime cost of the machine would place it beyond the reach of ordinary farmers, while the difficulty of removal would be a serious obstacle to its general use."

We will now give a report of experiments on the use of Phillips' exhaust fan in the drying and scuring of hay in ricks carried out in a southern county, and when they were cut for inspection we were invited to be present and see the result. We found five stacks, Nos. 1, 2, and 3 being the produce of twenty acres of Trifolium and Italian Rye Grass, estimated to weigh 50 tons. The grass was cut on the 30th May and three following days. The weather continued wet, with more or less rain falling until the 12th of June, the morning of 13th being fine. Carting to the stack commenced at mid-day. Later in the day it again rained, the carting being continued for two hours in the wet. The following day carting was resumed, and the stack No. 1 was finished. The fan was used the next day, and continued every day for two hours for a fortnight. The highest temperature registered with Phillips' spear thermometer was 173° on the fifth day. Stack No. 2 was carted on the 15th in very damp condition, and subjected to the same process with the fan as No. 1. Stack No. 3 was carted on the 16th, the hay being bright in sample, yet showing dampness. The fan was used on this stack for the same time—about an hour daily. Stack No. 4 consisted of Clover and Rye Grass, the produce of 18 acres estimated at 30 tons. The grass was cut on the 13th and 14th of June, turned over on the 16th, and carted to rick on the 17th and 19th. This hay was not more than half made, but was carted dry, and allowed to remain a fortnight before using the fan. It, however, had settled off the stand on the leeward side. The hay registered 150° when the fan was used, but the stack on the leeward side had got so close that the fan could not act so as to reduce the temperature, which had risen to 180°, and it was then found necessary to cut a hole in the leeward side to prevent the hay from taking fire. Stack No. 5, newly laid down pasture grass, the produce of 10 acres estimated at 20 tons, grass cut on the 16th and 17th of June, and carted to rick on the 20th and 21st, the weather threatening rain with a dull and damp atmosphere. Experienced men as farmers said that it was madness to put the hay into stack in its then condition, and that it required at least three days more making in the field before carting. The fan was worked on this stack, and continued for an hour and a half daily for twelve days.

Condition of the hay.—Nos. 1 and 2 ricks were extensively damaged, but were worth for consumption by dairy cows at our estimated value, 50s. per ton on the spot. No. 3 was in every respect an improvement in consequence of being carted in a drier state, and we estimated its value at 70s. per ton in the place. Stack No. 4 being carted dry, had no appearance of mould, and, in our opinion, if the fan had been used as soon as the stack was finished, instead of being allowed to settle out of shape, the quality of the hay would have been first-class without overheating, and we estimate the main portion of this hay as worth 90s. per ton. Stack No. 5.—The upper part of this stack being hardly equal to the condition of the lower part, yet this turned out well, and we cannot estimate this hay at less than 90s. per ton in the place. In giving our opinion on the general results of these experimental stacks, that as ricks No. 1 and 2 were made when the hay was wet, shows that although they would have been no use whatever as food for stock without the use of the fan had been applied, yet No. 3 having been carted from the same field one day later, proved worth 20s. per ton more value, shows that no real advantage can be obtained by carting hay in the wet under any circumstances as yet available or discovered. No. 4 teaches the lesson that if the full benefit is to be derived from the use of the fan it must, when required at all, be used the day after the stack has been finished, and continued as long as may be necessary. No. 5 teaches a valuable and important fact, that at the end of three or four

days, if the hay is dry, although not fit to be carted to the rick under ordinary practice, yet it can be safely put together by the use of the fan applied immediately after the rick is finished.

In order that no suggestion be omitted which may be useful or even partially so to the home farmer, we have yet to notice another exhibitor at the Reading meeting of the Royal Agricultural Society in July last. The exhibitors, C. Kite & Co., attempt to make hay in the stack by ventilation without any mechanical aids. The stack was a circular one, about 21 feet in diameter at the base, and the Judges' report states:—"The method adopted was to build a shaft in the centre of the stack extending from the base to the apex, and capped above the roof with a patent ventilator, such as is applied by the inventor to the ventilation of sewers. The cage which forms and keeps open this shaft is of perforated galvanised iron. Communicating with this shaft were two 4½-inch flues of galvanised iron. These were laid in the same line radiating E. and W. from the centre. Each was provided with a plug, so that either or both could be used or closed at pleasure. At right angles with these tubes were two others, which, however, did not extend so far inwards as the shaft, being inserted simply for the purpose of testing the temperature of the stack. A portable slow-combustion stove was used occasionally, and the only other alteration required was attention to the heat of the stack, and the opening or closing of the flues in order to regulate it. The highest temperature reached at the end of seventeen days was 144°. When the stack was cut the light galvanised iron cage had completely collapsed, the water had run down by the side of the ventilating tube and rotted the hay in places, and the lower part of the stack was mouldy, while the upper part would have been of more value if it had been allowed to heat more. The grass of this field was much of it a sharp-edged sedge, and required heating to make it palatable to animals. It grew upon six acres, a light crop, stacked in good condition, rather green, mown July 15th, stacked July 20th, and contained about 10 tons of hay. The hay on being sold at auction realised £21. This system of ventilation in the stack was not successful in its application," and we consider that it is suggestive only. We have other plans to consider.

(To be continued.)

WORK ON THE HOME FARM.

Horse Labour.—Since the Lent corn and Mangold seed, the Carrot seed, &c., has been all sown, and we are glad to say very favourably. The horses have been continually engaged in tillage work preparing the land for Swedish Turnip seed. At other times when the rains prevented work upon the land to be first seeded, the intervals of time have been filled up by rafting the land intended as fallow for Wheat. We mean a long fallow, for it has laid deeply ploughed since Michaelmas, the land being full of white-rooted couch grass in consequence of the neglect of a former tenant. This shows how desirable it is to obtain tenants who not only understand the practical part of farming, but have sufficient capital to employ the necessary labour, and at the same time are straightforward and are impressed with the idea that the best farming is the best and most profitable to themselves. The land intended for Wheat will during the summer continue to be used as the resource of horse labour when not otherwise more beneficially and urgently employed, such as haying and harvesting. The Swede seed should now be drilled, the first and second week in June being the best time for early and dry soils and early climates; but in the northern and north midland counties and Scotland these roots have been seeded for during the month just passed. As regards the sort of Swede seed to be sown it is much a question of the purpose for which the roots will be required, that it must be left an open question to be decided by the home farmer. The earliest roots are best fitted for early consumption by bullocks in the boxes after being shut up in boxes after leaving the pastures; in which case those not having been forward enough to sell may with benefit be allowed ripe roots of Swedes in the first instance, or otherwise the yellow hybrid Turnips, now much approved not only for fattening cattle but dairy cows also where their milk is sold, or when calves are suckled to be sold as veal; but these kinds of roots are not well suited to a butter-making dairy.

Hand Labour.—We have lately been employing the men in taking up and relaying pipe-tile draining which had been laid in ditches, and it was found that the roots from the hedge woods had blocked the drains (this, too, occurred by neglect of a former tenant), although many of the hedges had in former years been grubbed and the ditches drained, and could see the benefit of it; therefore no sooner in the present instance had the draining been repaired than we set the men to fill the ditches and grub the roots of hedgewood, thus yielding more land for cultivation, and destroying a fruitful source of constant annoyance by the growth and seeding of weeds which foul the arable land. There are many advantages in removing fences which we have carried out on various estates during the past forty years under our care and management, for we have found in exposed situations, and especially near to the seacoasts in different parts of England, the corn frequently suffers severely from the effects of wind during

growth, but especially as it nears the harvest. We have noticed for many years past that where the hedges have been removed there has been less damage to the grain crops than previously, although the fences had been left ostensibly for shelter. Our usual plan of removing fences is to retain not only those required as boundaries to the highways and properties, but also to the pastures and meadow land, as a fence against horned cattle and horses. We have been in some cases induced to resort to a sweeping reform in farm management, owing to the damage which we had often observed done by high winds, particularly on the lee side of the hedges, where the eddy and whipping action of the wind has done great injury, particularly at and near harvest time, whereas in the open part of the fields where the wind passes over the fields without impediment, we have noticed that little damage has been done. This circumstance, together with the gain of land for cultivation previously occupied by the fences, decided in our mind the advantages of removing all internal hedges upon arable land, but not without draining the ditches also where required. For after the removing of fences, &c., the land may be cultivated in long straight ridges, instead of the short and costly work consequent upon crooked fences and small enclosures, to say nothing about the advantages of improving roads and the greater facilities afforded for carting manure on to the land, corn, and hay at harvest.

Live Stock will now find plenty of grass where it has been reserved. We have seen fine crops of Italian Ryegrass which had been manured with liquid drainage from the cow stalls now cutting up for green fodder for a fortnight past, and given to the dairy cows when they come in to be milked, and they go out into pastures where the grass has been early, although for a short time not abundant. Mowing Italian Ryegrass and Trefoil for hay will now be going on, for these are very early grasses, especially on dry forward soils. Trifolium now will be ready for foddering cart-horses at the stables and also fattening bullocks in the boxes. The former may not require so much corn, for we have known them sometimes refuse their regular allowance of Oats whilst eating Trifolium when at its best just about blooming time; the latter will make meat very fast by having their usual allowance of cake with as much Trifolium as they will eat readily, and we give the cake in the meal state mixed with a few cut Mangolds to prevent waste. We have never made beef faster than when feeding with grass, either Italian Rye, Trifolium, or broad Clover when at the full growth and coming into bloom; in fact, we should never think of ensilage except for dairy cows, for we prefer the soiling of fattening bullocks in the summer rather than make the grasses into hay and incur risks, because the cattle feed and fatten quicker in the summer, and the manure made in the boxes when feeding on green fodder is much richer than that made whilst the animals are consuming roots in the winter, although the allowance of cake, may be the same. Now is the time for buying calves of a good breed either for rearing or for suckling to be sold as veal; for the latter good-bred Hereford calves or Devons will be the best, for they fatten quickly and make veal of the very finest quality much better than Shorthorns, because they come to hand quicker, for Shorthorns if ever so well-bred yield more bone and coarser meat. In rearing calves for the dairy at a future time it is essential that the cow should have been a good milker from which they were bred, and also the bull should have been bred from a good milking strain. With reference to the bull calves to be prepared for steers, the very best blood for beef-making is required, as they will then during the early period of growth feed fast and improve very quickly both in size and quality of meat if well fed. It may be asked why we feed over Clovers in summer instead of making hay? We reply, We do not wish for, nor is it our usual practice, to feed fattening cattle with hay during the winter months, when they get roots and cake. Hay is too expensive a diet, besides which we find that feeding with straw is not only more profitable, but we never find them off their feed by ill-health, as they frequently are when eating hay with full allowances of roots and cake at the same time.

THE SUSSEX ASSOCIATION FOR THE IMPROVEMENT OF AGRICULTURE.—The Wheat trials of this Society have been especially useful. Unmanured land gave twenty-four bushels per acre, while manured land yielded as high as fifty-three bushels, and it was clearly proved that the highest profit was obtained from fully manured plots. With a dressing of 5 tons of farmyard manure per acre a yield of thirty-three bushels was obtained, but the addition of suitable artificial manure increased the crop to forty bushels. The special manure giving the full crop was nitrogen. Four plots had different forms of nitrogen, but the produce was nowhere so large as where nitrogen was given in the form of nitrate of soda. Nitrogen proves to be one of our best fertilisers, and the erroneous idea that it exhausted the soil is now exploded.—E. L.

REVIEW OF BOOK.

Agriculture. By WILLIAM T. LAWRENCE. Edinburgh: W. & R. Chambers.

A LITTLE work of little pretensions, but of much more than ordinary merit, bearing the above simple name, has recently been

issued by the above firm. For half a century this firm has been noted for the excellence of the different educational series issued by them, and this new venture should add considerably to their reputation. We have carefully read every one of the 340 paragraphs contained within the substantial cloth binding, and are constrained to say that nowhere have we met with a book, elementary or otherwise, containing so much information in so little bulk, and in such simple, easily understood language. Its author, W. T. Lawrence, Hereford, has proved himself particularly well qualified to reach the most opaque understandings. We can hardly think of boys so dull as to be incapable of understanding the science of plant growth as here taught, and we would urge on school boards in agricultural districts the desirability of introducing this subject as one of the necessary elements as treated in this manual. It is well printed, well bound, and low-priced.

But while bearing in mind, and placing the interest of the country first, we are not forgetful of our own readers. Frequently the treatment of gardening and farming subject from a scientific standpoint necessitates the use of terms that make the writer's words less intelligible than is desirable. This is almost always unavoidable so long as the readers know little or nothing of the science of agricultural chemistry. Frequently we have been asked to recommend books to such, to enable them to master the subject so far as to enable them to grasp the meaning of the terms now so largely used by many writers. This is a somewhat thankless task, as such works are either high-priced or useless, and generally contain an amount of matter not wanted that the general reader has not the patience to wade through and pick up the grains of knowledge he is in search of. To such we can cordially recommend this manual.

Our intention was to have made several quotations to show how simple, terse, yet clear and satisfactory, is the language used, but, though we had marked rather a large number of passages, we find selection rather difficult. Almost at random we select the following, which occurs under the heading "PROPERTIES OF SOILS."—"If you were to take three flower pots and fill the first with marbles, the second with sand, and the third with fine soft powdered earth, and then pour water into them, you would find that the water would run through the pot filled with marbles almost as soon as you poured it in; but that it would take a little longer to run through the one containing sand, and still longer to soak through the third. This shows that the finer the particles of the substance the longer it will hold water: and why? Because small particles lie so much closer together than large ones, and the spaces between them are too small to let the water run through quickly. Now clay consists of very fine particles (finer particles than any other kind of soil), therefore it is able to hold water for the use of plants better than any other soil. But the fine particles of clay may be pressed together so closely when damp that no water is able to get through at all; this is not good for plants. A field with an under soil of clay in this closely pressed condition would not allow the water to pass downwards, but would cause the top to remain soaked with stale water, which is poison to plants. Such land is very cold, and also very unhealthy both for people or animals to live on or near." Such a plain illustration it is impossible not to understand. Equally clear is the next paragraph quoted, which is intended to show the capacity of soils for manurial matter as the above is to show its capacity for water.

"We took three flower pots for our experiment in last lesson; we will now take two barrels with holes in their bottoms instead this time. Let them be set up so that we may be able to catch the water which comes through. We will fill the one with sand and the other with powdered clay soil well shaken down. We will next take some of the dark-brown or nearly black nasty-smelling water that runs from a manure heap and pour part of it into each barrel. We shall find that it comes through the sand first, but is not so dark in colour as it was when poured in. The part that was poured on the clay soil take much longer to soak through, but when at length it finds its way to the bottom of the barrel it is quite clear and free from smell." Then the reason of this is explained and the value of clay in soils made clear, also the rising of water is explained.

Space will hardly permit more quotations, but we cannot help noticing the clear way the action of drains is explained. Draining is not a very well understood part of either farming or gardening practice, we should be inclined to think from the erratic way drains are often laid. Immense sums have been thus misspent. Yet here we have the whole matter in a nutshell. After reading what is here said on the subject one can hardly understand a drainer going wrong in ordinary cases, or, in extraordinary ones, proceeding at all without proper information, for like all really good books this begets a desire for more knowledge.

The manufacture of superphosphate and its after treatment is not well understood. The action of sulphuric acid is here explained in a way that has the merit of simplicity as well as some degree of

novelty. As we have frequent inquiries on this subject we will give our readers the advantage of one quotation more.

"In this process"—*i. e.*, the making of superphosphate—"the bones or mineral phosphates are treated with sulphuric acid (oil of vitriol) and the change is produced in the way which is shown in the following table:—

Before the change.	{	Base.	Acid.	Salt.
		Lime	+ Phosphoric acid	Tricalcic phosphate.
		Lime		
		Lime		
	} +	Water	Sulphuric acid	= { Oil of vitriol (true sulphuric acid).
		Water	Sulphuric acid	
After the change.	{	Lime	+ Phosphoric acid	= Monocalcic phosphate.
		Water		
		Water		
	} +	Lime	Sulphuric acid	= Sulphate of lime.
		Lime	Sulphuric acid	

"The change is simply this: The phosphoric acid has given up two-thirds of its lime to the sulphuric acid and received water in return, and the result is a mixture of monocalcic phosphate and sulphate of lime." To this we may add that this monocalcic phosphate is only soluble so long as it remains monocalcic, and becomes insoluble the moment it meets with lime, as it always does in any ordinary soil. When this happens it becomes plain tricalcic phosphate again, but it is none the worse, but in all respects the better of the change by the time it has become by reason of its solubility well diffused through the soil. But it is quite different when this reversion takes place before application, for then the value of its solubility is gone; then it fails to diffuse itself through the soil, and is then very little, if indeed anything, superior to an impalpable powder, while it is considerably dearer. For this reason neither lime, nor ashes containing lime or other base, should be used to dilute superphosphate. Only sulphate of lime is suitable for this. Sulphuric acid displaces phosphoric acid when in combination, but the reverse action never can occur. In conclusion we advise all who are interested in the subject—and all cultivators of the soil should—to secure the book for themselves. We venture to advise the author to prepare a good index for future editions. The table of contents is insufficient for quick and ready reference to the various parts of the work.

OUR LETTER BOX.

Cream Cheese (R. S.).—This may be made from a quart of cream, to which, perhaps, a pint of new milk may be added with benefit. It is warmed in hot water to about 90° Fahr., and a tablespoonful of ordinary rennet is added. It is let stand till it thickens, then broken slightly with a spoon and placed in a frame 8 inches square and 4 inches deep, in which fine canvas cloth or straw has been placed, and then it should be pressed slightly with a weight. Let it stand for twelve hours, after which it may be lifted out and replaced in a finer cloth, over which a little salt has been powdered. It is fit for use in a day or two as a household delicacy.

METEOROLOGICAL OBSERVATIONS.

CAMDEN SQUARE, LONDON.

Lat. 51° 32' 40" N.; Long. 0° 8' 0" W.; Altitude, 111 feet.

DATE.	9 A.M.					IN THE DAY.				Rain	
	Barometer at 32° and Sea Level	Hygrometer.		Direction of Wind.	Temp. of Soil at 1 foot.	Shade Temperature.		Radiation Temperature.			
		Dry.	Wet.			Max.	Min.	In sun.	On grass.		
1893.											
May.											
	Inches.	deg.	deg.		deg.	deg.	deg.	deg.	deg.	In.	
Sun. 21	30.051	55.4	49.2	W.	54.4	60.0	48.4	76.6	44.8	—	
Mon. 21	30.202	56.1	54.0	E.	53.8	68.1	41.3	101.0	35.3	—	
Tues. 22	30.193	58.2	49.7	W.N.W	54.1	74.3	43.4	112.8	36.3	—	
Wed. 23	30.151	65.2	57.8	S.W.	55.2	79.1	48.0	121.0	42.5	—	
Thurs. 24	30.118	64.8	55.1	N.W.	57.2	79.6	49.7	121.6	44.8	—	
Friday 25	29.957	60.3	55.0	N.	58.1	73.7	49.4	103.5	43.0	0.023	
Satur. 26	29.602	56.9	54.9	N.	58.0	69.4	51.2	83.9	47.0	0.299	
	30.039	59.7	54.1		55.8	72.0	47.3	102.9	42.0	0.322	

REMARKS.

20th.—Fair, calm, and dull.

21st.—Calm, cloudy.

22nd.—Fine, bright, and warm.

23rd.—Fine, bright, and warm.

24th.—Very fine and warm.

25th.—Cloudy dull morning, fine afternoon and evening.

26th.—Dull and rainy from 8 A.M.

Early part and middle of week extremely fine and warm; cooler, wet, and uncomfortable on Saturday. Range of temperature on 22nd, 23rd, and 24th averaged 30.6°, and for the whole week averaged 24.7°.—G. J. SYMONS.



7th	TH	Royal Society at 4.30 P.M.
8th	F	
9th	S	
10th	SUN	3RD SUNDAY AFTER TRINITY.
11th	M	
12th	TU	Royal Horticultural Society. Fruit and Floral Committees at [11 A.M.]
13th	W	Royal Botanic Society (Second Summer Show). York Floral [Fête (three days). Colchester (two days).]

POTTING AROIDS AND ORCHIDS.

MY remarks on this subject are not altogether intended for the professional gardener, but for the benefit of those whose experience is limited in the cultivation of the plants that will be referred to, and for young men especially. In many gardens where choice plants are grown, the potting is generally conducted by the head gardener, or his foreman if he be sufficiently experienced, and the remaining young men have but little chance of seeing how the operation has been performed. Some will perhaps say they must keep their eyes open. I have been told this on more than one occasion when practising as journeyman, and making inquiries about such work; but this is not sufficient, for the young men are frequently engaged in other duties while work of this description is being done. In fact, men in charge of departments other than those in which the plants in question are situated may not have the slightest idea that the plants have been repotted until they notice them when walking round in their leisure hours. As the manner in which many plants are potted is an important element of success, I do not hesitate saying that if gardeners generally would show or inform intelligent young men anxious to learn how the work should be done they would be altogether better men, and soon capable of doing such work as well as the chief, and they would also work with greater earnestness and take more interest in their duties generally when they found a desire apparent to make them practically acquainted with every routine operation of the garden.

In the cultivation of choice Alocasias, Anthuriums, and Orchids too much importance cannot be attached to the way in which they are potted. These plants are not unfrequently placed in larger pots as if they were Heaths, Azaleas, or Pelargoniums. This would be perfectly right if the plants required potting two or three times during the summer; for instance, a young plant of Anthurium Andreanum in a 3-inch pot might require one three times that size before the end of the season. It is the system of affording larger pots year after year that is wrong. Continually shifting into needlessly large pots is certainly injurious, and may prove fatal to the plants under notice. If overpotted plants are examined a few living roots may be found near the surface or round the sides of the pots, but those inside the ball are generally dead. The majority of these plants have thick fleshy roots and will not thrive satisfactorily in soil that becomes close, and

sour quickly. They delight in an open compost of fresh peat, sphagnum moss, charcoal, and crocks, and should when repotted have all decomposed matter removed from amongst the roots. This need not be done annually, but at least every alternate year the old compost should be carefully picked out without mutilating the roots, and the new worked amongst them with equal care. Some Alocasias, such as *A. Lowii* and *A. intermedia*, do best when subjected to this treatment annually, while Anthuriums of the *Warocqueanum* and *Schertzerianum* types will stand well for two years, and do better than if the roots are disturbed, if given a moderate shift when required, and top-dressed the following year after potting. When potting such plants every second year it does not always follow that they require larger pots, for we frequently return them into the same size after the old compost has been removed from amongst their roots. If found in any way sour the roots should be washed in tepid water before being placed in fresh compost.

Orchids rarely succeed for any length of time when potted annually or every alternate year unless the old material is picked out from amongst their roots. There are exceptions to this rule, but the varieties that succeed are those that are inclined to throw out stem roots and live from the moisture of the atmosphere rather than from the material in which they are potted. Although these plants will flourish under such conditions with their lower roots black and dead, they grow with still greater luxuriance with their lower roots healthy and in full possession of the material in which they were potted. If we take two of the most common and easily grown of Orchids—namely, *Dendrobium nobile* and *Cypripedium insigne*, the former will grow luxuriantly while the compost remains fresh, watering and other treatment being satisfactory; but when decomposed the pseudo-bulbs gradually decrease in size. The *Cypripedium* will live in the same pot for many years, forming a hard mass of roots, the soil in which they were once growing being washed away. It is evident this good old plant would live if the roots were laid amongst charcoal or crocks and syringed and watered frequently. But what would be its condition in comparison with plants provided periodically with fresh suitable material to root in? The former would be starved and puny in appearance by the side of the latter, with large dark bold foliage and gigantic flowers with frequently two upon one spike. Many Orchids when brought into an unsatisfactory state through sour soil are often worse to recruit than newly imported plants. They may only be a little in advance of these by having a few living roots made with the last break or two. Plants of this description seldom ever make back breaks when the whole of the roots attached to the old pseudo-bulbs are dead, and even if they do the growths are so weak that they may be years before they attain a flowering size.

Peat used for these plants in lumps decomposes much sooner than the fibre with the soil shaken out. The latter is decidedly preferable for all Orchids that require abundance of water while in active growth, and should be used by all whose experience is limited in the culture of these plants. In potting those varieties that cling tenaciously to the sides of the pots it is much better to break the pots than attempt to turn the plants out and injure the roots in doing so. When broken the portions of pot attached to the roots can be left clinging

to them, and worked in when potting amongst the new material.

Cattleyas when potted with good peat in lumps may not need the material removed from their roots so frequently as many others. These plants require much less water at the roots than many Orchids, and during their resting period, which should be rather a lengthened one, they need very little, and the potting material in consequence remains in a wholesome state for a long time. Special care should be taken in selecting peat for these plants. It should be of such a nature so as to last as long as possible, for they do not like being disturbed too often, but when necessary to repot them every particle of decomposed matter should be carefully removed from the roots.—WM. BARDNEY.

TOO MUCH NITROGEN.

THE notes which have appeared in this Journal relative to the decay of the footstalks of the Duke of Buccleuch Grape, induce me to say a few words on a subject in which at present I am but very imperfectly informed. I have, however, been considering and taking notes on it for the past five months, and intend at some future time to put them into readable form; but as the present appears an opportune moment, I will roughly introduce the subject, in the hope of securing attention for it from other observers.

First, I have to express my great regret at the loss we have sustained by the death of "Inquirer" (Major-General Scott), whose notes, when criticising "Vines at Longleat," led me to think over the matter afresh, and induced me to make further experiments. I forget the exact words used by your lamented correspondent, but they were to the effect that the success I had attained might, in a great measure, be accounted for by the system of culture followed, apart from the question of manuring, and that, from a chemist's point of view, the manure used was certainly deficient in potash. There is no doubt in my mind now that he was correct as far as the potash is concerned, though I believe he, and the authorities he quoted, were incorrect in their estimate of the value of earth-closet manure.

Cultivators, as a rule, depend too much on nitrogen and phosphates, and especially on the first-named. They like to see their plants grow quickly and have dark green leathery foliage. True, they find out at times that they can go too far in this respect, for beyond a certain limit the foliage, instead of assuming a dark green, will turn a sickly yellow, and the plant will perhaps die. But still they like to go as near as they can to the point of danger without actually reaching it, believing that perfection lies very near that point. I think this is an erroneous idea, and that an excess of nitrogen may be absorbed long before the foliage turns yellow, and that its injurious effects may be observed if the cultivator will only watch carefully.

There is a great difference in plants as to their powers of discrimination. Some will refuse to grow in soil which does not contain the necessary constituents in fairly good proportions; others are such gourmands that they will grow in any soil between a stone heap and a dunghill, including the two extremes, and if one ingredient is short they will make up by absorbing others in excess. Of this nature is the Vine. Its capacity for absorbing nitrogen appears to be almost unlimited, and my observations lead me to believe that many of the misfortunes attending its cultivation arise from this. I have very little doubt that the decay in the footstalks of the Grape in question is due to this. I have no practical acquaintance with this Grape, but believe the Vine to be a vigorous grower where it does well, and the most vigorous examples would certainly be the most likely to suffer, because of their greater capacity for absorbing nitrogenous food. Mr. Thomson uses artificial manure to a great extent, and that manure is prepared with a view to supply the special wants of the Vine. It is, of course, known by every manufacturer of Vine manure that potash is an essential ingredient, and the manure is made

to contain that in ample quantities, and in such a form as to be immediately available for the Vines. Some few growers are so situated that they can obtain cow urine in unlimited quantities. They have, therefore, an abundance of potash, and know nothing of the wants of the greater number who are less favourably placed. I do not recommend anyone to use artificial manures exclusively, or even largely, for nothing at present invented can permanently take the place of decaying vegetable matter; but a manure rich in potash, used in conjunction with some vegetable matter, some phosphate such as is afforded by decaying bones, and some lime, is a necessity for first-class productions.

Some of the results following a freer use of potash are, that the growth is more woody and less soft, even when quite young; the main stems of the bunches and also the berry stalks partake of this character, and it runs right into the berry, where the stones are united to the berry stalks. The berry stalk enlarges very rapidly, and has a hardy look, with warty-like excrescences, and the older portion of the lateral assumes a greyish colour, preparatory to a brown one, even before the stoning period arrives.

Having said this much, it will not surprise many of your readers when I tell them that the substance of the flowers, their capacity for fertilisation, and consequently the stoning of the fruit, the decay of berry stems, commonly called "shanking," and many complaints of a minor character, are all intimately connected with this question, which I hope to enter into more fully when my observations have been further extended, and I have the leisure to think over the subject properly.—WM. TAYLOR.

CHRYSANTHEMUMS FOR DECORATION.

THOUGH it has been repeatedly pointed out by various cultivators that no flower is easier to grow than the Chrysanthemum, at the same time it may be not altogether amiss to remember that no plant shows the effects of want of attention or resents it longer. Shifting the plants into the pots in which they are to flower will soon require attention. The main points to be observed here are, first, to employ as strong a soil as possible, so that it is not adhesive in character, and when potting to ram the soil very firmly. I prefer a soil even without fibre, and for this reason: Turf, especially if inclined to be what is technically termed light, becomes much too quickly taken possession of by the roots of the plants. Now if we employ a soil which the roots are obliged to grow into very slowly we obtain an important advantage; and, further, when liquid manure is given the more fibrous compost does not grasp the manurial constituents so fully as does a somewhat retentive one.

Another matter to note just now is that of either allowing the plants to grow without pinching, or to pinch them back in order to keep them more dwarf. I have tried both ways, and find that varieties like Mrs. G. Rundle break so freely up the stem that pinching is not at all necessary, unless quite dwarf plants are wanted. On the other hand, Japanese varieties, like Elaine and Fair Maid of Guernsey, may very advantageously be pinched back to a foot or 15 inches above the surface of the soil. This will induce the production of more shoots, and consequently more flowers, than if grown naturally. James Salter is a Japanese which does not require pinching. It must be understood these remarks are applicable alone to plants grown for conservatory decoration and for producing flowers for cutting.

There are yet two other matters connected with the summer treatment of these plants. The first is that many grow them well enough till they become established in their flowering pots, then do not afford the plants their needful supply of water, and the result is only a few deformed blooms in winter. It cannot be too often pointed out that to allow a Chrysanthemum to be dried up in an August sun simply means ruin to the plant. They should never be allowed to approach dryness. I do not like to see the soil dry further than just to show at the base of the stem. The second point to note is the mischief which is allowed to proceed on the points of the shoots from the attacks of aphides. Regular dusting of Pooley's tobacco

powder is a simple preventive, or cure when attacked, of any harm from these. Any mildew must at once be destroyed with sulphur.

I may further note that for cutting the Mrs. Rundle type does not require the buds to be thinned. The terminal bud will have four or five buds clustering thickly round its base. These are all developed together, and the result is a very pretty bunch of flowers. Large-flowering kinds, however, require disbudding. If too many flowers are left none of them develop properly. Rich surface dressing applied when the plants are housed is of the greatest advantage. Fresh roots are formed, which aid the development of the flowers very much. The atmosphere, too, must be kept buoyant during the time they are perfecting their flowers. This is much the best means of escaping mildew, at the same time that a little rise in the temperature keeps the roots moving, and a more plentiful supply of good flowers is a consequence.—R. P. B.

MR. VAN HOUTTE'S NURSERY AT GHENT.

WHEN describing some of the Belgian nurseries about two years ago this, the largest of them all, in consequence of a domestic calamity referred to at the time was passed without notice, on that account it claims attention now. The period of inspection was in April, when acres of Hyacinths were flowering in the grounds, Azaleas under glass affording a feast of beauty, and Imantophyllums gorgeous by their brilliant heads.

At that particular time numbers of men of many nationalities were visiting the Royal Nurseries at Gendbrugge, a suburb of Ghent, and all appeared to be alike impressed with their condition, the admirable order that prevailed, the diversified character of the wonderful stock of plants, and the business-like appearance that pervaded the establishment. This is emphatically a great trade emporium, and everything is subservient to the production of the greatest number of plants in the best possible condition. There are no imposing structures, such as elaborate "winter gardens," nor Crystal-Palace-like erections to catch the eye of passers-by, for none is needed. The houses are long, low, and numerous—work-a-day pit-like erections which plants enjoy. They are, in fact, made for plants to live in, not for patrons to look at, for these are scattered over, no doubt, every civilised country on the face of the earth. The plants, too, are of all kinds, hardy and tender, rare and popular, requiring for their enumeration half a dozen closely printed catalogues—a fact that shows in the most forcible manner how utterly futile it would be to attempt anything like a detailed account of the contents of the nurseries. Passing the Palms, bewildering in numbers and variety, also Ferns and new and old stove and greenhouse plants, a pause may be made at a few of the more prominent genera which arrested the attention and evoked the admiration of visitors in April.

AZALEAS.

For forming an idea of the number of these plants that are grown here the nursery must be visited in September. They may then be seen growing in prepared beds in the open air in scores of thousands, some being then taken up and potted, but vast quantities "mossed" and sent by train and steamer to all the capitals of Europe and the chief cities of America. In the autumn, then, the greatness of the trade in these plants is seen, but in the spring the beauty of the varieties can be appreciated and the merits of the new forms estimated. Thousands of seedlings are flowered every year, raised by the industrious foreman, Mr. François de Teye, who has presumably done more than any man in Europe in improving these, the most beautiful and popular of spring-flowering plants. In the classes for new Azaleas at the Ghent Show it was surprising to observe the great number sent by M. Van Houtte, which decidedly obtained the lion's share of the honours that were awarded. As it was impossible to enumerate all the varieties in the report of the Exhibition, and as they are far too meritorious to be overlooked, they are described now.

M. Eugène Lippens.—Large double flower, white, shaded and blotched greenish-yellow at the bottom of the throat, large rounded lobes. Very fine and free flowering.

J. J. Moser.—Semi-double, well-formed flower, rose or pink ground, with flesh-coloured reflex, bordered white, maculated with deep rose and dotted with white.

Mrs. B. S. Williams.—Medium-sized flower, white, double row of lobes, quite new in shape, slightly convex and well rounded, blotch greenish-sulphur. Very beautiful.

Mrs. Arthur Veitch.—Large, beautiful, semi-double white,

round lobes, with well-prominent veins and very slight sulphur blotch.

John Lyall.—Very large and double, well rounded and undulated lobes, colour lively reddish salmon. A first-class variety.

Chas. B. Brigham.—Medium, well-formed, single flower, undulated lobes; colour deep carmine, with blood-red blotch.

Souvenir du Prince Henry.—Large, semi-double, well-formed flower; colour rosy carmine, darker at the border, deep carmine blotch.

F. W. Moore.—Double, full, and well-formed flower; colour a very lively lake-carmine. A charming variety.

John Hawkesworth.—Large flower of fine shape, with well-rounded lobes; colour fiery red, large blotch of blackish blood-red at the bottom of the three superior lobes. Very effective.

David Milne Home.—Large single flower, with undulated lobes, large and well-rounded, snow white, and a beautiful variety.

Madame Aug. Lemoisier.—Large well-formed flower; colour soft rose, striped with carmine in the interior, with white at the borders, and deep carmine blotch on the three upper lobes.

Comte de Paris.—Border of lobes white, with a star-like interior of carmine-rose, blotch deep carmine. Of first-class merit, quite new, and very fine.

Th. Reimers.—Large, double, and well-formed flower; beautiful lilac-rose.

Baron Nathaniel de Rothschild.—Large double flower of perfect form; colour light amaranth, blotched with blood-red. Very rich and striking.

Madame A. Van Wassenhove.—Large and very double well-formed flower; colour flesh, bordered with white.

Madame Alfred Chaber.—Very large single flower; colour bright rose, with white reflex, and very deep carmine blotch.

John T. D. Llewellyn.—Double medium-sized flower; flesh-coloured, bordered with white; lower petals flat, slightly undulated; upper petals reflexed and blotched with light carmine.

The above are the cream of the newer Azaleas raised in this nursery, and they will undoubtedly form a very beautiful and superior collection.

RHODODENDRONS.

Intermixed with seedling Azaleas in the houses devoted to them were many new Rhododendrons of great merit, and the following trio are worthy of being added to all collections.

Madame Wilhelmine Van Houtte.—Centre of flower white, very slightly flesh-coloured, borders carmine-rose, upper divisions dotted with deep blood-red on a rose shaded with orange ground. Quite new in colour and attractive.

Mdlle. Marie Van Houtte.—Flowers white, the borders very slightly shaded with flesh colour and blotched with bright chestnut; fine bouquet-like truss.

Baron George de Saint Genois.—Truss good and flowers well formed, white, bordered with rose. Distinct and attractive.

IMANTOPHYLLUMS.

When the newer varieties of these brilliant and effective plants become generally known they can scarcely fail to be extensively cultivated in this country. We have no such groups in England as were exhibited at Ghent, and it is noteworthy that plants from this nursery won the Van Houtte memorial medal, as well as other prizes offered for these plants. Attractive as the groups were in the Exhibition, the larger collection in the nursery, including many seedlings, was still more imposing. There is undoubtedly a great similarity between many varieties, but the following are distinct, and rank as the finest in commerce:—

Madame L. Van Houtte.—Robust plant, with very large leaves and fine truss of thirty-five to forty well-formed flowers, each measuring nearly 4 inches in diameter; colour bright orange red. A first-class variety.

Mademoiselle Marie Van Houtte.—The same as the foregoing, but flowers of a lighter orange, washed with creamy white in the interior of the throat. Very beautiful.

Madame Donner.—Dwarfer in growth than the two preceding, yet vigorous. Flowers of excellent shape, with large petals; colour red orange, washed with creamy white in the centre of the throat, extending to the rest of the petals as if flaked like a *Gladiolus*.

M. Ch. Van Eekhaute.—Plant very dwarf. Flowers less perfect in form than the others, but of a very bright orange scarlet colour, and highly effective.

Madame Peeters.—Plant vigorous, with large trusses of round pale orange-coloured flowers. Very distinct.

These must be regarded as decided acquisitions, and for con-

servatory decoration in spring it is difficult to conceive any plants more suitable where bright telling colours are required.

CAMELLIAS.

These simply astonish by their numbers, many long houses and pits being wholly occupied by them, mostly dwarf bushy plants in 4 and 5-inch pots, convenient for exportation. Liberality in the use of scions, two or three being attached to each stock just above the surface of the pot, and generous soil, contribute to well furnished plants in the shortest time. They grow, too, with the greatest freedom; and to keep them dwarf the young growths are topped as if they were Verbenas. They are copiously watered, the pots being crowded with white fleshy roots, very different in character from those of half-dried and semi-starved plants that are too numerous in this country. Sandy loam and leaf soil is the staple compost. Such free growth and thick glossy foliage could never be produced by hungry peat—a hint that perhaps may be worth the notice of some amateur cultivators where Camellias do not give them complete satisfaction. To submit Belgian Camellias to a roasting and starving process is simply to court failure, which is, however, "good for trade" on both sides of the water.

HYACINTHS.

The late Mr. Van Houtte determined on cultivating Hyacinths in his nursery the same as they are grown in Holland, and there is little doubt that there are districts in England where they might be similarly grown. The conditions requisite for success are sandy alluvial soil and an ever-present supply of earth moisture to be drawn upwards by the sun to the roots. They cannot be satisfactorily grown on a dry subsoil, and no extent of surface watering can compensate for the absence of a naturally moist base. In Holland this earth moisture is ample. In the nursery under notice much liquid support is applied, but not in the orthodox manner. The Hyacinths are grown in a perfectly level part of the nursery in beds 4 or 5 feet wide with deep paths between them—needlessly deep for the ordinary purpose for which paths are devoted; but they serve another purpose here, being flooded at night with sewage, and thus the requisite moisture is supplied to the roots without being poured on the surface of the beds. The end justified the means, for the plants were vigorous, the spikes robust, and the colours clear and bright. Several acres were occupied, forming a great level expanse of flowers in blocks of colours of every hue produced by the Hyacinth, the general effect being magnificent. According to the evidence of some Dutch horticulturists there was no better example of Hyacinth culture in Holland than the one just cursorily alluded to.

The above is a mere glance at the salient features of the nursery in April. Now and onwards the vast collection of Gesneraceous plants in charge of Mr. Charles Raes, the originator of so many new and beautiful forms, and a pioneer in the hybridisation of Begonias, which has resulted in the splendid varieties now in cultivation, will form a prominent feature of the establishment. To see everything the nursery must be visited at different periods of the year. I have seen it some half dozen times, but never to greater advantage and never in better condition than on the last occasion. It is one of those undertakings that to an outsider would appear to press with great weight on the proprietor. In this respect I only know one business that would seem even more trying to human resources, and that is the greater Chelsea establishment and its ramifications, the responsibilities of which centre in one individual, Mr. Harry J. Veitch. Such gigantic undertakings could not be smoothly worked and successfully conducted without the aid of skilled and trusted foremen. These there are in all great nurseries, and to know these men is to respect them, not more for their undoubted skill and unfailing civility than for the deep, earnest, personal interest they take in the success of the firms by which they are employed. This is apparent in every great English nursery; it is manifest, too, at Gendbrugge, and Mr. Louis Van Houtte and his industrious and accomplished sister, Mademoiselle Leonie Van Houtte, have the experienced aid and valuable services of Mr. Charles Van Eeckhaute, who is admittedly one of the most competent and practical of Belgian horticulturists.—J. WRIGHT.

THINNING AND TRANSPLANTING ONIONS.—This is an operation that should be done as soon as the seedlings are large enough to handle, and when the ground is damp and the atmosphere surcharged with moisture—assuming such favourable conditions to exist at the right time—inasmuch as the work can then be carried out more expeditiously and without subjecting the young plants to much check in the process of transplanting where blanks in the rows render the latter procedure necessary. The young plants, having had their roots shortened a little, should not be buried any deeper in

the ground than they were before, and should have the soil made firm about them with the dibber in planting. Beet, too, may be transplanted, making the holes sufficiently deep to admit the roots in their entirety, without any perceptible difference in the result of the crop, the transplanted roots being quite as good in shape and quality as the non-transplanted ones.—H. W. WARD.

COMING FLOWER SHOWS.

THE following are the dates upon which the principal horticultural exhibitions and meetings of June and July will be held, of which we have received schedules, and Secretaries of other Societies will oblige by forwarding schedules to us of any shows not noticed in this list:—

JUNE.

- Tuesday, 12th.*—Royal Horticultural Society, Fruit and Floral Committees at 11 A.M., and Promenade Show, South Kensington. Evening meeting at Burlington House at 8 o'clock.
Wednesday, 13th.—York Floral Fête (three days). Royal Botanic Society's Show. Colchester (two days); Guildford.
Thursday, 14th.—South Essex, Knotts Green, Leyton.
Tuesday, 19th.—Leeds (three days), Worcester (three days).
Tuesday, 26th.—Royal Horticultural Society, Fruit and Floral Committees at 11 A.M., and Pelargonium Show, South Kensington; Diss.
Wednesday, 27th.—Cardiff Rose Show; Croydon; Royal Botanic Society's Evening Fête.
Thursday, 28th.—National Rose Society's Show, Southampton; Richmond.
Friday, 29th.—Canterbury Rose Show.
Saturday, 30th.—Reigate (Roses); West Kent; Bromley.

JULY.

- Tuesday, 2nd.*—National Rose Society's Show, South Kensington.
Wednesday, 4th.—Wimbledon Show; Gardeners' Royal Benevolent Institution, Annual Dinner, Teddington.
Thursday, 5th.—Bath (Roses); Kingston; Farningham; Highgate.
Friday, 6th.—Sutton (Roses).
Saturday, 7th.—Chiswick, Crystal Palace (Roses).
Tuesday, 10th.—Royal Horticultural Society, Fruit and Floral Committees at 11 A.M. Oxford and Wirral Rose Shows.
Wednesday, 11th.—Royal Caledonian Society's Show, Edinburgh. Hull Show (three days).
Thursday, 12th.—National Rose Society's Show, Sheffield; Nuneaton; Braintree.
Friday, 13th.—Ludlow (Roses).
Tuesday, 17th.—Leek (Roses).
Wednesday, 18th.—Nottingham Floral Fête (two days). Darlington Rose Show.
Thursday, 19th.—Evening Fête at Chiswick; Aberdeen.
Tuesday, 24th.—Royal Horticultural Society, Fruit and Floral Committees at 11 A.M.; Carnation and Picotee Show, South Kensington.
Wednesday, 25th.—Colnbrook.
Thursday, 26th.—Eastbourne.

MAY BLIGHT.

WE frequently have to remark that a measure of truth underlies some of the popular sayings about the weather, which modern science is apt to treat scornfully. It is so in respect to what is called "a blight." On certain days that are heavy and calm, of which we always have at least one or two in May and September, country folk will tell you there is a "blight in the air." This gloom is, as they suppose, caused by the atmosphere being laden with insects. Such is not precisely the fact, but yet these peculiar days are connected with the migrations of aphides. There was a blight of this kind in North Kent on Sunday, May 20th, and another on Saturday, May 26th, each followed by a migration of aphides in the winged form. They do not, however, travel far; their object apparently is rather a change of diet than change of place. It is by such dull and close weather that the flow of sap is checked in the plants upon which, until that period, the aphid tribes have been abundant in their wingless state. As Mr. Walker pointed out, the result of this is an emergence of winged females; and these soon make use of their wings, preferring to take their journeys while there is little wind, but they will also travel when a moderate breeze is blowing. Of course the foes of the aphides, the ladybirds for instance, are frequently led to migrations about the same time.—ENTOMOLOGIST.

EUONYMUSES.

AMONGST outdoor evergreens, trees or shrubs there is none more ornamental in habit or beautiful in foliage than the Euonymus. They are green, silver, and golden in their variegation, and some of them might well be compared to hardy Crotons, as they are as beautifully variegated and showy as these favourite indoor shrubs. Some of the best varieties are *E. flavescens*, pale yellow; *E. argenteus variegatus*, silvery; *E. ovatus aureus*, golden; *E. medius pictus*, painted; *E. aureus*, yellow; *E. radicans albus marginatus*, white-edged; and *E. repens*, pink. *E. radicans albus marginatus* is an excellent variety for edging any beds in the flower garden or pleasure grounds, as it grows dwarf, and is very

showy when it forms a compact mass of silvery leaves. The other variegated kinds grow taller, some of them here having attained a height of 8 feet, and they are proportionately bushy. The green-leaved varieties, of which *E. japonicus* and *E. macrophyllus* are the best, are excellent for forming evergreen hedges with, or they may be planted as screens or trained against walls. For this purpose the variegated forms are also suitable, but the green ones grow most quickly, and this is generally a point taken greatly into consideration in hedge-making.

The variegated kinds may be planted to ornament the best parts of the pleasure grounds, and as centre bushes in flower beds they give the greatest satisfaction. For very small gardens, or where only a few little bushes are grown on the grass about villa residences, there is no class of plants more suitable, ornamental, and useful than these. Four or five years ago we advised a friend to plant the best varieties of *Euonymuses*, and now he has bushes which attract the attention of all passers, as the shrubs are now large in size and most beautiful in variegation.

Apart from all other qualities they possess two which should be specially mentioned. One is that they are the best of all evergreens to grow near the sea, and the other that they will thrive in a town atmosphere, and these two points should not be forgotten by those who are interested in planting in such positions. I never knew one of them to be killed through being near the sea, and I have seen them so close to it that they were frequently bathed with spray. As a seaside plant we have nothing to equal them, and in situations of the kind they should be extensively used. As town plants they are equally satisfactory, and the most smoke-laden atmosphere does not injure them. Smoke from copper-smelting furnaces is the most injurious to shrubs generally of all fumes, but I know some *Euonymuses* which have lived under its influence for years, and they now look as well as those in the purest air. They will bear uninjured any clipping or cutting-in, and they may be shifted with impunity, as they root closely and freely and lift with good balls, and may be transplanted at any time when the weather is favourable with every certainty of success.—J. MUIR.

CŒLOGYNE CRISTATA.

THE *Cœlogyne cristata* is designated one of the popular Orchids, and is one that may be grown in any stove—that is, where Ferns and flowering plants predominate. Those who have Orchid houses cultivate *Cœlogyne cristata* in them, but the following remarks are intended for amateurs who have a stove and require the utmost out of it. In such a structure the temperature is not kept very high—about 55° as a minimum during the winter months with fire heat, and 60° to 65° in summer, with good ventilation. In such a temperature *Cœlogyne cristata* thrives admirably, and will vie with any Orchid-house specimens. The best time to repot the plants is when growth commences, but do not shift them if they do not require it; every alternate season is often enough, but a surface dressing must be given. If the plant become very crowded with pseudo-bulbs it is best to divide it. Some growers recommend cutting the spent pseudo-bulbs out to give the others room, but I have not tried it, although it appears feasible. The best compost for the *Cœlogyne* is very fibrous peat with the finest particles sifted out, a third of growing sphagnum, with a sprinkling of charcoal and crocks. It being a surface-grower pan-pots are the best. They should be filled three parts full of clean potsherds, then fill with the compost, elevate the centre of the plant above the rim of the pot, and firmly place the compost around the roots. Take care not to cover any of the pseudo-bulbs, and give a sprinkling of water to settle the soil about the roots. From now until the plant has finished its growth it should not be allowed to suffer through insufficient supplies of water. When it commences growing freely it should be slightly syringed twice a day. About the end of October the new pseudo-bulbs will be plump, when water should be gradually withheld, but not so that the plant may suffer, until the flower spikes appear, when water should be carefully applied or the spikes will damp off. If several plants are grown and there is a warmer structure at command, place one of the plants in it, when a succession of blooms will be obtained, which is very advisable where choice cut flowers are required.—A. YOUNG.

ACACIA LINEATA.

SEVERAL useful Acacias have from time to time been noticed in these pages, and that now figured is one of the best in point of utility and beauty. It is most floriferous, of graceful habit, and, moreover, flowers freely in a small state. Plants in 48-size pots

are extremely valuable in early spring. Such specimens continue flowering for several weeks or two months, its slender branches being clothed thickly with its small dense globular clusters of golden flowers, and have a pretty effect. Cuttings strike readily in a light compost of sand and loam under a bellglass, and the plants so obtained should be placed in well-drained pots, employing a compost of light turfy loam and peat in equal parts, and a little sand. Water must be liberally supplied during growth, and very weak liquid manure occasionally will prove beneficial.

ROSES ON THEIR OWN ROOTS.

I HAVE to thank "A Judge" for his letter, and Mr. Sanders for his two letters, on this subject. I did not desire to "make out a case" in favour of stocks so much as to ascertain the truth, or at



Fig. 102.—*Acacia lineata*.

least the general opinion; and if Mr. Sanders gets growth up to 4 feet, and his best blooms of the season from cuttings inserted the previous autumn, the question seems settled, for that is a gain of a year on the man who has to plant stocks. Mr. Sanders says he does not exhibit, and therefore (as I said in my former letter) I fear the invidious question would still remain how good his best blooms were. But "A Judge," who ought to know, testifies, if I understand him right, that blooms from cuttings are as good as those from worked plants; and I confess at first sight nothing seems to be left to me to congratulate myself upon except that

rooted stocks and budding knives are likely to be drugs in the market, and I shall be able to get them cheap.

At the same time I may remark that I allowed in my last that a few Hybrid Perpetuals would grow and do well on their own roots. Mr. Sanders names only eighteen. He might add *Souvenir de la Malmaison* to his list. But this is a small number indeed, and almost justifies one in saying that it looks more like "the exception which proves the rule" than a rule of itself.

"A Judge" says, "I will perhaps admit that there is no more difficulty in striking cuttings of John Hopper, La France, Alfred Colomb, and Gloire de Dijon than there is in rooting portions of Briar and Manetti growths, and that this after all is the real question for the purpose of comparing the two methods of increase." But I will not admit this; and, according to my experience, there is much difference between the ease with which Briar and Manetti cuttings may be rooted, the latter being far the easiest to strike.

And if Mr. Sanders was cruel in limiting me to eighteen Roses, what shall I say of "A Judge" who sentences me to four only? As to the economy of budding, "A Judge" remarks on the cart-loads of prunings burned annually; but as we cannot prune in September and October, or put in cuttings in March, I must join in lamentation of the waste, but do not see how it is to be rectified.

Now, the following seems to me to be economy. Last summer I noticed in a friend's garden a nice plump-budded shoot of Countess of Rosebery about a foot long. As I had not this variety I begged the shoot, carried it home and inserted the buds, seven in number, in seven Manetti stocks. One of these buds has not started yet, but I think it will. I have, however, six strong young plants with altogether thirteen shoots, three of them over a foot long already, and I should like to back those plants against cuttings put in last autumn and similarly treated.

It will be evident therefore, I fear, that I am at present unconverted. I still hold by the dictum of Mr. Cant, "Nearly all this class (H.P.'s) grow and flower better budded than on their own roots." But if anyone beats him for the championship this year with blooms taken from Roses on their own roots I promise to devote myself to cuttings thenceforth.—A. F. M.

I HAVE written before on this very interesting topic, and have read all I see in your pages thereon. I agree with Mr. A. J. Sanders, on page 421, that the fresher the cuttings are the greater the success; but on the other hand I generally have a small percentage of success from the cuttings I make of plants bought in the autumn. These I treat like my ordinary plants—cut out in the autumn all the shoots and wood that will not be wanted for a head in the spring. The cut-out pieces are then divided into short pieces and put in to take their chance, and a percentage, small I grant, yet worth the trouble, succeed. I do not quite see why Mr. Sanders cuts out the two lower eyes. I can understand it in making Manetti plants, but for Roses on their own roots I fancy the buds underground have often saved the cutting. I have adopted my good friend Mr. W. Taylor's plan of the wood sides and sheets of glass over, pasted at the joins, with great success, and also his directions as to cutting straight across at the foot instead of slanting.

It seems to me, however, that the greater number of persons who have given their experience on this subject have made cuttings rather with a view to pot plants than to outdoor specimens. Even Mr. Sanders talks as if he potted all his cuttings, and afterwards, "late in May," planted these out. But I fancy there are many amongst us who have neither the time, the space, nor the tact to manage them as pot plants, and want from our cutting bed to plant them out. Now, I for one, would be grateful to Mr. W. Taylor or Mr. Sanders for their experience in this direction. Let me state the difficulties I have met with. First, then in the small frame or handlight the cuttings are closely packed, and, as with care almost all strike, the plants become drawn up and tender. I have met this difficulty somewhat in this way by subsequently putting a somewhat larger frame over them on bricks, so as to bring the glass much higher than before, and also by making the glasses slip in a groove so as to be able to give air. Of course, with a Cucumber frame this is easy. Then I have generally left those in the frame till autumn. Now many of these will during the summer make very good plants, some with shoots 3 feet long.

The following autumn, after planting as cuttings, I have essayed treating these as plants, and shifting them. In this I have had not a few disasters, the worst being that the junction of root and parent stem appears very frail, and a very slight strain separates it. I attribute, perhaps erroneously, the death of not a few of these plants after planting out to this fact. Last year I took out some, but have left others in what I may call the "cutting bed."

These are breaking splendidly, sending up grand shoots; and I apprehend they will not only give very good blooms this season, but that they will move with more success this autumn. But this plan keeps them two years in the cutting bed, and I fear will not do for the small frames where the packing together is tolerably close, and where so many strike.

I think in the early spring not a few cuttings strike after having made some growth from want of a little watching, especially if the sun be hot and the lights left on. In my experience the following Roses will repay the attempt:—*Madame Sophie Fropot*, *Crown Prince*, *Madame Rothschild*, *Ferdinand de Lesseps*, *Marie Baumann*, *Alfred Colomb*, *Hippolyte Jamain*, *Charles Lefebvre* among the Hybrid Perpetuals strike well; and amongst the Teas *Madame Marie Van Houtte*, *Catherine Mermet*, and *Souvenir d'un Ami* may be added to Mr. Sanders' list.—Y. B. A. Z.



A GENTLEMAN who has inspected the KENTISH ORCHARDS informs us that the only really good crop of the year will be that of Apples. The Pear crop will be very thin. Cherries set well, but in consequence of the cold nights and dry hot days they are falling in shoals. Plums there are scarcely any, *Victoria* bearing by far the best crops. There are few or no Damsons, and the *Filbert* crop will be very light. Bush fruits, such as *Gooseberries* and *Currants*, are extremely variable, in some districts the crops being good, in others light. *Strawberries* and *Raspberries* are promising, but rain is greatly needed, and if it does not fall soon the fruit will be small.

— A CORRESPONDENT mentions as worthy of note a GRAND CROP OF FIGS AT CHATSWORTH, "as many as thirteen or fourteen fruits on 18 inches of wood—in fact the house was smothered with Figs in all stages of growth; the trees are trained on a curved trellis Peach tree-like fashion, and a finer crop of Figs can scarcely be imagined." He adds, that in one of the plant houses *Anthurium Andreanum* has spathes $9\frac{1}{2}$ long by $7\frac{1}{2}$ inches wide.

— FINE specimens of the GOLDEN SYCAMORE are rarely seen, but we recently noticed a beautiful example in a suburban garden which well showed the attractions of the tree at its best. It was over 20 feet high with a fine bushy head, the foliage being of a rich golden hue, which was rendered even brighter by contrast with a large Horse Chestnut near it.

— THE SECOND EVENING MEETING OF THE ROYAL HORTICULTURAL SOCIETY at Burlington House is announced for Tuesday next, the 12th inst., when the following papers will be read:—Mr. W. Goldring on "*Cypripediums*;" Dr. Masters, "Notes on Conifers;" G. Maw, Esq., F.L.S., on "*Crocuses*;" and Herr Max Leichtlin, "Notes from Baden-Baden."

— A FAVOURITE flower at the present time is the DOUBLE POET'S NARCISS, of which large quantities are now to be seen in the London markets and on the hawkers' barrows and stalls. The blooms are large, very full, of wax-like substance, pure white, and exceedingly fragrant. Indeed they bear a close resemblance to *Gardenias*, and form by no means a despicable substitute for them.

— A CORRESPONDENT sends us the following note on an ANCIENT YEW AT ORMISTON HALL, East Lothian. From a stem measuring 17 feet in circumference at 3 feet from the ground rise great limbs which bend over, forming an arch, and reach the ground at about 20 feet from the stem. Round the outside of the branches the circumference is 550 feet, and the height is in proportion. Wishart, one of the early Re-

formers, used to preach under it, and the tree, though evidently very old, is still in vigorous health.

— THE same writer observes:—In the kitchen garden at Oxenford finely hearted examples of MCEWEN'S EARLY CABBAGE were being cut last week. Alongside was Aitkins' Matchless and Early York, but these, though quite large, showed no sign of hearting.

— IN the flower gardens the borders are exceedingly gay with many different varieties of AUBRIETIA. A neater, more telling plant of the same shade of purplish blue does not exist at any season. It is a great favourite in the north, and is really indispensable. Associated with a dense-flowering yellow Polyanthus and the charming Arabis alba it is very effective. A bed edged with the Golden Sedum is charming. It often thrives where Myosotis dissitiflora fails, but "both are best," as they are very distinct and good.

— OXENFORD is noted for good Grapes. At the end of May those in the earliest house were just beginning to colour. Later houses were looking very well, but it is too early to judge of the quality as yet.

— THE twenty-third annual Exhibition of CHRYSANTHEMUMS AT BIRMINGHAM will be held in the Town Hall on Wednesday and Thursday, November 21st and 22nd, when, in addition to the numerous prizes offered by the Society, special prizes will be offered by Mr. Hans Niemand, Edgbaston; Mr. Thomas B. Thomson; Messrs. Smith & Co., Worcester; and Mr. J. Tomkins, Spark Hill; the first-named for a bank of untrained Chrysanthemums, and the three latter for Primulas.

— REFERRING to the NIGHTINGALE, "D., Deal," writes:—"Our experience here (East Kent) is quite different from that of your correspondent at Biggleswade. I have never heard them in greater force; and now, on June 4th, they sing most delightfully. The nights have for some time been so fine that we have been enabled thoroughly to enjoy them."

— AT the recent sale of the BRENTHAM PARK ORCHIDS at Mr. Stevens' rooms, the total amount realised on the three days was £2100, some of the principal prices being as follows:—*Cattleya labiata*, true autumn-flowering variety, 30 guineas; *Lælia grandis*, 31 guineas; *Odontoglossum blandum*, 20 guineas; *Cattleya Trianae alba*, 75 guineas; *Oncidium ornithorhynchum album*, 28 guineas; *Lælia anceps Dawsoni*, 45 guineas; *Cœlogyne Massangeana*, 40 guineas; *Aerides Schröderi*, 21 guineas; *Cattleya Skinneri alba*, 38 guineas; *Cattleya exoniensis*, 110 guineas; *Cattleya labiata Warneri*, 18 guineas; *Lælia anceps alba*, with twenty-four pseudo-bulbs and six breaks, 41 guineas; *Odontoglossum coronarium*, 14 guineas; *Cattleya elegans alba*, 24 guineas; *Odontoglossum nevadense*, 10 guineas; and *Vanda tricolor formosa*, 10 guineas. All these were plants of considerable size, and several were the finest of their kind in the country.

— THE THIRTY-NINTH DISS HORTICULTURAL EXHIBITION will be held at Hall Hills, Tuesday, June 26th, prizes being offered in fifty-nine classes for amateurs and gardeners, and twenty-two for cottagers. Roses are a special feature, nine classes being devoted to them, the prizes varying from £4 to 5s.

— "P. M. M." writing respecting the COOL ORCHIDS AT TRANBY CROFT, Yorkshire, observes:—"Many fine plants have been flowering this season, particularly striking being a magnificent variety of *Odontoglossum gloriosum*, with flowers of great size and substance; *O. cirrhosum*; *O. Rossii majus*, splendid variety; *O. Pescatorei*, a variety with flowers of pure dazzling white; *Saccolabium guttatum giganteum*; *Masdevallia Veitchii*, most beautifully shaded; and a magnificent variety of *Sophranitis grandiflora*—the flowers, of intense carmine, are 3 inches

across. *Plcione humilis* is one of the most useful cool-house Orchids; the specimen there has been in flower for nearly three months. The number of plants used for house decoration is enormous, Palms, huge Tree Ferns, and banks of Poinsettias embedded in Maidenhair being grouped in the magnificent reception rooms of the mansion, and reflected in the immense mirrors, forming a scene which suggests a glimpse of Fairyland."

— THE handsome plants of *Hydrangea hortensis* that are sent to Covent Garden Market have been frequently noticed, and now *HYDRANGÆA PANICULATA* is becoming similarly popular in pots. Its attractiveness out of doors is comparatively well known, and the utility of plants in 32-sized pots bearing six to eight large trusses of white flowers can be readily imagined. Such are now common in the market, and their value for decorative purposes cannot be over-estimated. With regard to the old *Hydrangea*, it is surprising how few seem to grow it now with blue flowers. Pink, deep rose, and white are common, but the blue, which is certainly one of the most attractive, is rarely seen except in gardens where these *Hydrangeas* are prized.

— THE LEEDS FLORAL AND HORTICULTURAL EXHIBITION will take place on June 19th, 20th, and 21st, in the Horticultural Gardens of that town. It has been organised by the Committee of the above gardens, and they have obtained the co-operation of the principal exhibitors of Leeds and neighbouring towns. Over £200 prize money has been guaranteed, and will be paid over in full to the prizewinners. Sixty-three classes are enumerated for plants, flowers, vegetables, and fruits, the prizes in the chief plant classes ranging from £12 to 30s. It is to be hoped that the weather will prove more favourable than it has done at exhibitions within the past few years, and that the financial results may be more satisfactory. Schedules may be had from Mr. G. Bush, the Secretary.

— A CORRESPONDENT directs our attention to a note in the *Cottage Gardener* in 1856 on GOLD FISH DYING, and which he thinks will meet the case of Mr. G. Duffield, who seeks information on a case which he describes on page 450. The paragraph in question, written by Mr. Shirley Hibberd in answer to an inquiry, is as follows:—"Your correspondent should at once remove his fish and clear out the pond, and when he examines the bottom he will most probably find a number of water-beetles, or the larva of beetles or dragon-flies. These have probably got into the pond, and caused the havoc he complains of. *Dytiscus marginalis* and *dimidiatus* are ravenous aquatic beetles, very common in still, rank waters; and, as they occasionally take wing in the summer, they may have taken up their quarters in the midst of the gold fish, into which they would bore holes in abundance, for they feed upon their prey without previously killing it. If the pond is not at once cleared the enemy may escape detection; for many aquatic insects and their larva pass the winter in a state of torpidity, ensconced in muddy banks. Perhaps he may remember to have seen a few buzzing beetles about his pond during the past summer; and he may now, perhaps, if he looks attentively, see them rise occasionally to take air on the surface."

— ON Monday last a SALE OF ORCHIDS was held at Mr. J. C. Stevens' Rooms, King Street, Covent Garden, the whole proceeds, free of all expenses, to be given to the widows of the late Mr. Spyers and Mr. Freeman, the plants both established and imported having been, we believe, chiefly contributed by Messrs. Sander of St. Albans. For such a benevolent object as this it might have been expected there would be a good competition, but such does not appear to have been the case, for at one time during the afternoon we were greatly surprised to see only four persons present, and in consequence the plants did not realise very high prices.

— THE HIGHGATE SUMMER EXHIBITION will be held on Thursday, July 5th. Seventy-three classes are provided, three prizes being offered in each, and in addition a number of special prizes are contributed by friends of the Society.

— MR. G. ABBEY writes :—"Small plants of *IMPATIENS SULTANI*, with its brilliant rosy-scarlet flowers, are always in request for decorative purposes, especially for table decoration, where their flowers contrast well with the surroundings; indeed, it is more beautiful than any flowering plant that can be used for the purpose in so small state. It has been frequently described in this Journal, and I need only add that cuttings in thumb pots when only a few days old and a very few inches high flower freely. For small vases it is invaluable. Cuttings strike like weeds inserted in sandy soil—loam, a little leaf soil, and about a sixth of sand, and shaded from bright sun. Very neat plants can be had in thumbs, and really beautiful plants in 3-inch pots, in a month from the insertion of the cuttings. Large plants may be had in pots for decorative purposes." This plant is rapidly becoming very popular, as we foreshadowed when the woodcut was given (page 75, vol. v.), and probably no plant of recent introduction has been so quickly increased as this.

— REFERENCE was made last week to the hardy Azaleas, and now the RHODODENDRONS AT KEW deserve similar notice. The large beds on each side of the long walk are covered with large trusses, but there is too great a uniformity both in the colour of the varieties and in the form of the beds to be so pleasing as they would otherwise be if the effect was more diversified. In "the Dell," however, the beauty of Rhododendrons can be seen to the best advantage, and shows which is the most suitable mode of planting such shrubs. The walk is sunk and winds between high and irregular banks, upon which the Rhododendrons are thickly planted in dense clusters, occasionally a fine old specimen being isolated to render its attractions more prominent. A large number of handsome varieties are represented, including some of the earliest forms of the Catawbiense section obtained. Others have enormous finely formed trusses, scarlet, rose, crimson, purple, blush, and white. It is regrettable that so few are labelled; if they have labels they should at least be placed where they can be readily seen, which is so in few cases. Some of the finest varieties are Henry Drummond, Everestianum, alba lutescens, Londinense, fastuosum fl.-pl., Hannibal, roseum superbum, Alarm, Johnsoni, Candidula, Blandyanum, macranthum, vestitum coccineum, Esmeralda, Paxtoni, perspicuum, Bylsianum, Onslowianum, and Hershell. These, it can be safely said, are unsurpassed for freedom and richness of colour, and several of them cannot be equalled in that respect by any of the newer varieties. The whole of that portion of the pleasure grounds where the dell is situated—namely, between the river and the Sion House vista, is now extremely beautiful, the semi-wildness being most refreshing.

— IT is announced that a HORTICULTURAL EXHIBITION will be held in the BOTANIC GARDENS, HULL, on July 11th, 12th, and 13th of the present year, and judging by the schedule we have received, strenuous efforts appear to have been made to induce good competition. The prizes are substantial in amount, ranging from £12 to 2s. in 107 classes for plants, flowers, fruits, and vegetables, the majority being open to all exhibitors, a few classes only being devoted to cottagers within a radius of fifteen miles of Hull. The schedule has evidently been very carefully considered, very liberal provision having been made for specimen plants. The prizes for fruits are also good in the leading classes. It is stated that the object the Committee has in view is "the advancement of horticulture by the establishment of a good annual horticultural exhibition in the Botanic Gardens, and by assisting in the great effort which is being made to place these gardens on a satisfactory footing as a horticultural

and scientific establishment. One-half the nett profit of the Show is to be devoted to the former, and one-half to the latter object." The Curator, Mr. Philip MacMahon, and those interested in the matter, will, it is to be hoped, obtain the success they so well merit.

— AMONGST writers upon Orchids at the present time Mr. B. S. Williams has deservedly obtained considerable fame, and nearly half a century's experience has enabled him to master the details of culture of the difficult as well as the easily managed species. Familiarity with all the cultivated Orchids, too, has rendered his judgment most accurate as regards the merits of varieties—a point of much importance at the present day. A large portion of the information gained during this long period of observation is embodied in the "Orchid Growers' Manual," and is appearing in a more extended form in the "ORCHID ALBUM," which is undoubtedly the best work on Orchids now obtainable. The coloured plates are most beautifully executed, faithful in artistic details, and life-like in colouring, which can be said of few coloured plates of plants, particularly the chromo-lithographs. All the plates are coloured by hand, and this is a most expensive item in the preparation of such a work, though it amply repays in the satisfaction afforded. The description and cultural portions of the letterpress are ably written, and will always render it a thoroughly useful as well as an ornamental work.

— AT a meeting of the Philadelphia Academy of Practical Science Mr. Thomas Meehan recently read some interesting notes on *ECHINOCACTUS*. He announced the discovery of sensitive stamens in *Echinocactus Whipplei*. This peculiarity had been long known in *Opuntia Rafinesquiana* and allied species, as well as in *Portulaca*, which, though its natural order was regarded as very distinct in systems of classification, had much in common with *Cactaceæ*. The motion of the stamens when touched in this species of *Echinocactus* was not instantaneous, several seconds sometimes elapsing before the motion responded to the touch. The flowers of this species are unable to expand to any great extent, on account of their short tube, surrounded by long and stiff spines. Mr. Meehan further remarked that in descriptions of cactaceous plants the relative length of the pistil to petals or stamens was often given. He had observed that in many species, about the period of the ejection of the pollen from the anther-cells, the stamens and style were of about equal length, the stellate stigma being just above the mass of anthers; but the style continued to grow after the maturity of the anthers, and, in *Echinocactus Whipplei*, would finally reach to near half an inch above. He had not been able to get any genera of *Cactaceæ* to fruit under culture except *Opuntia*, unless they were artificially pollinised. By the application of the flower's own pollen to the stigma they sometimes perfected fruit.

— DR. TRIMEN'S report respecting the condition and improvement of the CEYLON BOTANIC GARDENS during 1882 is now to hand, and gives full particulars concerning the Peradenya Hakgala and Henaratgoda Gardens, the planting, clearing, houses erected, &c. An active interchange of plants and seeds has been conducted with Kew and all the principal botanic gardens and other establishments, which has resulted in adding to the collection nearly 200 species. It appears that the Coffee-leaf disease continues very serious, and in many places it has been found that the cultivation of Coffee does not pay the expenses, and is therefore being discontinued. Cinchona cultivation is being largely increased, and Dr. Trimen states that at present it constitutes the "foremost product of Ceylon." During the year ending in September 3,099,895 lbs. of bark were exported, being an increase of over a million and a half pounds on the previous year. Much attention is also being paid to Cacao culture. Indiarubber and

medicinal plants are also dealt with at length, many interesting facts being mentioned in connection with them.

— IN reference to the ORCHELLA WEED in the above report Dr. Trimen observes—"This figured as a rather large export from Ceylon, the amount in the year ending September, 1882, being no less than 1157 cwt. The plant is a Lichen, and grows in the hot dry districts of Ceylon close to the coast. Its favourite localities are seashore rocks, where on the east coast it is frequent; but it is also commonly found on old tree trunks near the coast about Jaffna. The species appear to be *Rocella Montagnei* only, no other member occurring on the island. It is a pale greenish-grey Lichen, with the fronds ribbon-like, much and irregularly cut, torn, and split up. The colouring matters litmus (solid), orchil (liquid), and cudbear (powder) are manufactured from this and other species."

— IN the "Publications of the Massachusetts Society for the Promotion of Agriculture" Mr. S. H. Scudder has given an interesting account of the habits of a small moth (*Retinia frustrana*), and of the ravages caused by it on the PITCH PINE OF NANTUCKET ISLAND (*PINUS RIGIDA*). Of late it has become so abundant as to threaten the total destruction of the Pines. Like its European congeners its larvæ bore into the interior of the healthy young shoots and destroy them. The remedy recommended is the radical one of taking off from every tree those shoots that show themselves to be infested, but the author is fully alive to the difficulties attendant upon such a recommendation, especially those of expense. The insect has not yet made its appearance on the adjoining mainland, but it seems to have been observed in other more distant parts of the eastern States. In Europe—and, indeed, in Britain—much damage is done to Conifers, especially Scotch Fir, by allied species, and they more especially infest quite young trees. Some of them principally affect the lateral shoots, and these, if not too numerous, cause no lasting injury to healthy young trees; but one especially (*R. turionella*) attacks the leading shoot, and is far more serious; in this case, if the tree be strong and healthy, a lateral shoot takes the place of the destroyed "leader," and recovery is effected by this means.

— THE culture of VEGETABLES IN THE BERMUDA ISLANDS, chiefly to afford an early supply for the American markets, has in recent years been greatly extended, and large quantities of Potatoes, Onions, and Cabbages are now grown there, together with Arrowroot. Strawberries are also being tried, and flower bulbs are being extensively grown by one enterprising individual for the New York Market. Cabbages, it is said, reach a height of 4 feet or more, producing fresh heads as the others are removed. The Potato haulm, too, is wonderfully vigorous, as might be expected in a climate where the temperature between December and March ranges from 60° to 66° Fahrenheit.

— REFERRING to these Islands the *American Cultivator* states:—"The proper time for planting Irish Potatoes in Bermuda is from January 1st to March 1st. Potatoes planted after February 25th are uncertain, on account of its being so late in the season. Arrowroot is planted in April, and early-planted Potatoes are ready to take up. Early Rose Potatoes are planted from the 10th to the 20th of October, which crop comes to New York during winter. There is no better manure in Bermuda for Onions than seaweed. Land used for Onions every season must have a good manuring once in three years. Tomatoes are planted in January, also Carrots, Peas, Cabbages, Cauliflowers, Cucumbers, Beans, Turnips, and Sweet Potatoes. In February Corn is planted, also Oats, Lettuce, Squashes, and Melons. In April Onions are cultivated for the last time. In June Onions are taken up and Melons begin to ripen. In July Onion seed is

gathered. In September Potatoes are again planted for an early crop. In fact, other vegetables may be planted at this time. In December anything may be sown that our Boston or New York gardeners would sow in June. In short, it seems as though the Bermuda gardener may sow anything he pleases, at any time he pleases; the only reason for having particular seasons for special crops is so that they may reach American markets at the right time to command the highest prices."

THE INSECT ENEMIES OF OUR GARDEN CROPS.

No. 4.

THE Gooseberry Sawfly (*Nematus Ribesii*) has been recognised for a long period of years as a foe to that fruit, and one which must be watched against every season. Lately it has been specially troublesome in many localities, even to the extent of stripping the bushes of their leaves. The consequence was that in extreme cases the fruit dropped off or else refused to ripen, and so had to be picked green. Apart from the preventive and remedial measures that may have been adopted by gardeners during 1882, the excessive humidity and general mildness of the past winter render it highly probable, I think, that the spring brood of the grubs or caterpillars has appeared in small numbers. Occasionally the cocoons of the insect may be noticed upon the

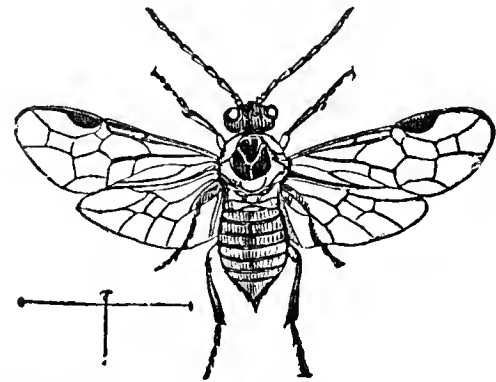

Fig. 103.—The Gooseberry Sawfly (*Nematus Ribesii*).

twigs of its food plant, but in the usual way they are hidden under the ground, to which the caterpillars descend when they are adult; hence a moist winter is likely to cause some of these to perish, and also it enables birds to get them more readily from the soil.

Although named from the Gooseberry, this pest is found also upon Currant bushes, but it seems to avoid the Black Currant. Some of the Sawflies—that of the Rose, for instance—set their eggs in grooves, cut by their saws upon the twigs or leaves. The fly of *N. Ribesii* (fig. 103), however, only places its eggs in rows along the veins of the leaves, doing this in April or early in May. This insect has four transparent wings, a head and thorax yellowish marked with black, abdomen orange, as are the legs, which have brown tips. About ten days after the deposition of eggs the young grubs appear, to feed at first in groups of from forty to seventy upon one leaf. Soon they disperse themselves over the bushes, grasping the leaves with their forelegs, while the tail or hind extremity of the body is partly curled round in the wonted fashion of Sawfly grubs. Each has six true feet and fourteen sucker-feet. These are black, and the head also; the body is green or brownish, with black spots. These will be the parents of a second brood should they escape the gardener and become flies; indeed, in some seasons the second brood is the more numerous, appearing during July; and there is generally a third emergence, the last batch of grubs feeding-up to become chrysalids in autumn. Or there may even be as many as four successive broods.

At that time of year when the Gooseberry bushes can be briskly shaken without injury to the crop, it is easy to remove the caterpillars of the above fly by placing pieces of cloth or canvas beneath the bushes to catch them as they fall, when they can be speedily killed. In small gardens patient handpicking will remove a number of them, especially if the bushes have had their branches so cut as to give them a cup-shape, a plan recommended by the Rev. J. G. Wood for this and other reasons. But there is seldom much trouble with the species if in the winter suitable operations are carried on where the caterpillars have been seen during the preceding summer. The surface soil may be removed with the chrysalids in it, or it may be forked thoroughly, while

a mixture of soot and lime is applied round the roots of the bushes. Should any earth be removed, it must be either buried deeply, or the chrysalids must in some way be destroyed, or the flies will appear after all, and manage to reach the Gooseberries to deposit their eggs. Some have highly commended the application of fresh tan, but the results of this seem to be rather uncertain, the article, probably, being of varying composition.

As to applications to the bushes, there have already been published in this Journal many commendations of white hellebore powder, a considerable demand for which has arisen owing to its proved efficacy, but on account of its poisonous qualities it ought not to be used when the Gooseberries are nearly ready for gathering. The only safe time is when the foliage is still young; early morning is very suitable for its application, the bushes being moist with dew or rain. Freshly slaked lime has been tried in a similar fashion, and flowers of sulphur dusted over the bushes by means of a pepper-box kills the caterpillars without any risk. From an extensive list of other remedies, I may add a syringing in the spring with Fir-tree oil, tobacco-water, or paraffin mixed in the proportion of 2 ozs. to a gallon of soapsuds, well stirred while it is being applied, and subsequently well washed off. Plain water as hot as the hand can bear may be safely used after the leaves have attained some strength; it will remove most of the caterpillars.

Another insect prejudicial to the Currant, but which does not touch the Gooseberry, is the small moth called the Currant Clearwing (*Sesia tipuliformis*), which I have always found, in its caterpillar state, more plentifully on the Black Currant than on the other varieties. Living concealed in the pith, the operations of the species are carried on unnoticed, till the death of the branches excites suspicion of some enemy. Where the caterpillars have been allowed to proceed from branch to branch they will, after some years it may be, kill the bushes, or at least greatly diminish the crop of fruit. Should the flylike moths chance to be observed basking upon the leaves in the midsummer sunshine no apprehension is felt that they are the cause of the unhealthy condition of the Currant bushes. By a little hand-net scores may be captured at the right season, and the production of hundreds of the caterpillars stopped. I have failed to discover the females in the act of egg-laying; the eggs, which are placed singly upon the bark, are also difficult to find. These moths (fig. 104) much resemble one of the species of *Ichneumon* flies that is upon the wing in June and July, but they have hard bodies, the moths being soft and downy. The wings are four, transparent, with yellow tips, and a black bar near the middle. At the tail is a tuft, which, when flying, the insect extends like a fan.

I believe the caterpillars continue two years in that condition, although there is a flight of the moths every summer—that is to

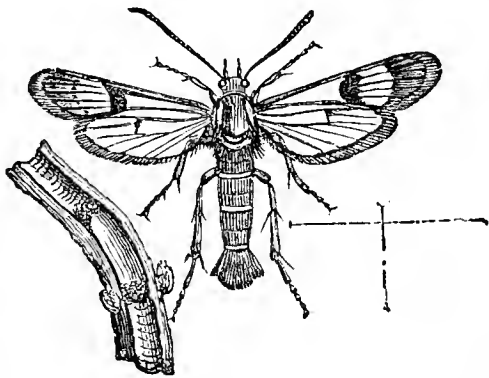

Fig. 104.—The Currant Clearwing (*Sesia tipuliformis*).

say, those that will appear this year come from eggs deposited in 1881. While young they are to be found chiefly in the twigs; as they grow they travel along the branches, or even pierce the main stem. They appear to be able to move up and down the mines or tracks they make in the pith, the twigs or branches not dying off until they have ceased to be the abode of the caterpillars. During very severe weather in winter they are in a somewhat torpid condition; the chrysalis is placed near an angle of a branch about April. Into the empty mines Acari or mites occasionally penetrate, entering at the opening left by the emerging moth.

The Gooseberry and Currant do not escape a visitation from the Aphis tribes. A conspicuous species of fly seldom leaves the Black Currant undisturbed. It raises upon the leaves reddish-brown blisters, and the insects shelter in crowds within the curling shoots. This species, called *Rhopalosephum Ribes*, appears from April to July; it is of a shining green, mottled with a darker shade. It is also found on other varieties of Currant and on the Gooseberry. Another kind that is common on various

plants, also of a bright green, is named from a favourite plant *Siphonora Lactucæ*. This shows itself upon the Gooseberry and Black Currant. *Myzone Ribes* is a larger species, which by its continued punctures disfigures the leaves of the Red Currant. They must be operated upon by washing or syringing.—
ENTOMOLOGIST.

THE PROPOSED FRUIT SHOW AT SOUTH KENSINGTON.

I WAS pleased to see the suggestion of Mr. Wright, on page 444, as to holding a great autumn fruit show in connection with the Fisheries Exhibition. I do not think we have had such a promise of Apples for many years, and combined with Pears, Plums, and Grapes a fine exhibition might be held during the last week of September. I have no doubt that if the Royal Horticultural Society were to take up the subject and carry it out on the lines suggested that many horticulturists, both amateur and professional, also fruiterers, would give it their hearty support.—
LEWIS A. KILLICK, *Langley, Maidstone.*

MESSRS. J. VEITCH & SONS, CHELSEA.

THE magnificent collections of plants in Messrs. J. Veitch and Sons', King's Road Nurseries, are now in grand condition, the multitudinous houses being filled with attractions of all kinds, from the aristocratic Orchids and *Nepenthes* to the plebeian bedding plants, which are numbered by scores of thousands. Between these extremes there are all classes of plants flowering and fine-foliage innumerable; the visitor wanders from house to house in a maze of wonderment, and leaves the nursery with a confused impression of having had the whole vegetable kingdom passed before him in review. Still more space is required, and fresh houses are being erected wherever there are a few square feet of unoccupied ground, though this extension must soon be discontinued, for the whole nursery is already nearly covered in glass. In every department the utmost skill is evidently brought to bear upon the particular plants, and the result is a uniformity of excellence that must be as satisfactory to those engaged in superintending the work as to the proprietors, the visitors, and the purchasers. A glance at the leading features of the nursery at the present time will afford some idea of the extent and merit of the collections.

ORCHIDS.

These deserve prominent notice, both on account of their great beauty and the surprising numbers grown. Houses, the majority of which are large enough to contain the whole of an ordinary private collection, are devoted to special genera, such as *Cattleyas*, *Dendrobiums*, *Lycastes*, *Odontoglossums*, *Phalænopses*, and *Vandas*. Thousands of imported Orchids, too, are seen in all situations, while two houses are just being completed expressly for establishing the newly received importations.

Cypripediums are now very handsome, many choice species and varieties being in flower. Particularly fine is *C. albo-purpureum*, of which an engraving is given in fig. 105, page 473. It is one of the most handsome of the numerous distinct hybrids raised at Chelsea by Mr. Seden, and is said to be the result of crossing *C. Schlimi* with pollen from *C. Dominicanum*, which is, strangely enough, also a hybrid obtained from a cross between *C. Pearcei* and *C. caudatum*, so that it may be said that three very distinct species have contributed to the production of *C. albo-purpureum*. It is suggestive of *C. Sedeni*, which also has *C. Schlimi* for one of its parents, and *C. longifolium* for the other. It has, however, larger flowers, the lip, petals, and sepals of a bright rosy-pink colour combined with white. The petals are 5 or 6 inches long and twisted. The great value of the plant consists in its floriferousness and vigorous habit, characters which are, however, shared by several other Veitchian hybrids, and wherever it has been tried it is spoken of most highly. Certificates have been awarded for it both at Kensington and Manchester, but even without these honours its merits are so great that it is certain to become a general favourite.

One fine specimen has been recently sold for 50 guineas, but the largest in the country, now in the Chelsea nursery, a magnificent example, is priced at 150 guineas. Another fine hybrid of which Mr. Seden speaks very highly is *C. Schröderi*, and though not now in flower it may be remarked that it is a cross between *C. caudatum* and *C. Sedeni*, and a fine plant has been sold to Baron Schröder for eighty guineas.

The large-flowered *C. Lawrencianum*, one of the finest of its section, the distinct and attractive *C. superbiens*, the dark *C. Harrisianum*, *C. selligerum majus*, and *C. Roezlii* are all flowering freely; but two other forms deserve a note, one a

Bornean species, *C. Curtisi*—named in honour of its introducer, Mr. Curtis, being in the way of *C. superbiens* but differing in the greater size of the flower, the bright rosy-crimson hue suffusing the petals and lip and the smaller denser spots. The large green striped dorsal sepal is similar in both, but the newer form may be considered as a decided improvement upon *C. superbiens*, beautiful as that species is. The other is *C. superciliare*, a hybrid between the last-named and *C. barbatum*, which has a very large

dorsal sepal, the petals bearing dark spots, and intermediate in colour between the two parents.

Cattleyas constitute a beautiful display in the house specially devoted to them, *C. Trianae*, *C. Mendelli*, *C. Mossiae*, *C. intermedia*, and *C. Dowiana* being represented by large numbers of handsome varieties. *C. Skinneri* is particularly fine, several plants being masses of lovely rosy flowers. *Laelia purpurata* is similarly attractive, the combination of rich crimson and pure



Fig. 105.—CYPRIPEDIUM ALBO-PURPUREUM.

white being most pleasing. A new *Cattleya* from the continent, which has not previously flowered in this country, is notable in one of the houses. This is *C. Keteleeri*, which is of the *C. Leopoldi* section, the lip rich crimson with pale pink lobes, the sepals and petals of a purplish colour.

Miscellaneous Orchids, including *Dendrobiums*, *Odontoglossums*, *Oncidiums*, *Vandas*, are in similar variety and beauty. The hand-

some *Dendrobium thysiflorum* is flowering freely, its gold and white flowers being produced in long pendulous racemes. *D. suavisimum*, with rich golden and crimson-blotched flowers, is equally handsome; while amongst the curiosities may be mentioned *D. Stricklandi* with greenish flowers, and *D. Curtisi* with small rosy blooms. *D. leucolophotum*, which has small white flowers in long graceful racemes, somewhat suggestive of *Angraecum citratum*,

is one of the present year's novelties, and was recently certificated at Regent's Park. *D. rhodostoma* is a beautiful form, with neat flowers, the sepals, petals, and lip white tipped with rose. The largest plant in cultivation of this Dendrobe is now in Baron Schröder's collection, having been purchased for fifty guineas.

Amongst the *Oncidium*s the well-known useful purplish *O. cucullatum* and the bright yellow *O. concolor* are very abundant, and are tastefully arranged with the *Odontoglossum*s in the long corridor. A distinct species is *O. nigratum* from British Guiana, which has flowers strangely like a diminutive *Odontoglossum cirrhosum*. The panicle is about 4 feet long, the branches short and close; the sepals and petals are narrow, white, and wavy, with dark purplish blotches, the lip being light yellow. *Odontoglossum cordatum*, *O. cirrhosum*, *O. Halli*, and many others, not omitting the beautiful *O. vexillarium*, contribute charms to the display in the corridor. The richer coloured *Masdevallias* *Harryana*, *ignea*, and *Lindeni*, with *M. Fraseri*, a fine hybrid between the two last-named species, are very effective. We feel reluctant to quit the Orchids, but there are other departments to be noticed, first being the

GLOXINIAS.

Messrs. Veitch have given much attention to these plants for many years, and they have succeeded in raising some of the finest varieties in cultivation. The erect-flowering type is most strongly represented, and are evidently the chief favourites, though there are several good representatives of the drooping group. The blooms are all distinguished by excellent form, broad rounded lobes, and bright or delicate colours. Probably the two finest scarlets are *Radiance* and *Garibaldi*, both free and intensely bright, the darkest violet purple form being *Brunette*, a new variety with large velvety flowers, very handsome. Some of the best of the others new and recent are the following—*Yacoub Khan*, purple, with a white edge, dotted with violet; *Czar*, rich purple; *Cordelia*, white, with numerous small purple dots, fine shape; *Purity*, white, fine and free; *Jeanne Meuret*, white, dotted with violet, round lobes; *Maebeth*, crimson, bluish margin, dotted; *Bayard*, very large flower, white, dotted with violet; *Miranda*, rich purple; *Coronet*, beautifully spotted with violet down to the base of the throat; *Fabiola*, very bright crimson; *William Robinson*, a fine flower, rosy crimson, netted in the throat; *Aginor*, purplish mauve; *Ariadne*, bright purple; *Clytie*, pink-spotted; *Crimson Queen*, very rich crimson; and *Lewis Castle*, neat flower, margin purple, centre of lobes and throat white. Many other handsome varieties are coming on, and will continue a display for several weeks.

TUBEROUS BEGONIAS.

A houseful of seedlings from a fine strain is now a blaze of colour, scarlet in various shades predominating and producing a most brilliant effect. Very few varieties are now named, as the strain has been raised by continued selection to such a high standard that it would be difficult to name all that are good. The plants, too, are of very good habit, strong without being coarse, compact and floriferous.

NEPENTHES.

The extensive collection of these is now in grand condition, though the pitchers are slightly less numerous than they were a few months since. *N. Mastersiana* is exceedingly good, and proves its claim to be considered one of the finest of the genus in a decorative point of view. The dark and light varieties appear to be equally free, and some of the pitchers are now attaining great size—nearly a foot long, and richly coloured. The wonderful *N. Northiana* is at present in a very small state, and it will be some time before the pitchers attain the surprising dimensions they do in their native habitats. The distinct *N. Veitchii*, however, has numerous fine pitchers. The *Sarracenias*, *Droseras*, and *Cephalotus*, which are so well grown in the little houses specially devoted to them, are in capital condition, and are alone well worth a visit.

STOVE PLANTS.

Prominent amongst these just now are the *Anthuriums*, *A. ferrierense*, with its large peculiar crimson spathes and long white spadix, being very abundant and beautiful. The old and well-known *A. Schertzerianum* occupies a house which now contains some hundreds of spathes, mostly broad, rounded, and brightly coloured; while *A. Andreanum* has its strangely blistered spathes of considerable size. The *Alocasias* *Thibautiana* and *Veitchii* are in superb condition, their handsome foliage being beautifully coloured, and several allied forms are also notable. The large yellow-flowered *Wormia Burbidgei*, which was recently certificated, is still in bloom, but its broad handsome leaves render it distinct at any time. The charming rosy scarlet *Impatiens*

Sultani is in strong force, and in a slightly cooler department are the hybrid *Rhododendrons*, of which so many grand forms have been raised. One novelty, at present unnamed, has salmon-coloured flowers of great size, about 3 inches in diameter, the largest yet obtained; the lobes are rounded, an inch or more in diameter, and the trusses are full.

As much more might be written respecting the nursery, which, at the present time, is full of interest to visitors.

BATH AND WEST OF ENGLAND SOCIETY.

BRIDGEWATER.

At the Bridgewater meeting, commenced on the 28th ult., the floral portion of the Exhibition, as usual, constituted an important feature, particularly the Orchid tent, which is superintended by the Hon. and Rev. J. T. Boscawen. In this several handsome groups of Orchids were tastefully arranged, and greatly admired by the visitors. The ten-guinea cup was won by Mr. Powell, gardener to W. E. Brymer, Esq., M.P., Ilington House, Dorchester, for a magnificent collection of well-grown plants, many being superbly flowered. The species and varieties represented were as follows, the number of spikes and flowers being stated in the most important cases:—*Aerides Fieldingii*, *Vanda suavis*, *Cypripedium niveum*, thirty blooms; *C. Laurenceanum*, *Dendrobium Dearii*, *D. moschatum*, eighteen spikes; *D. thysiflorum*, nine and eleven spikes respectively; *D. Devonianum*, 120 flowers; *Cattleya Mossiæ*, *C. labiata Warnerii*, *C. Skinnerii*, twenty spikes, a beautiful plant, for which the five-guinea cup was awarded as the best specimen in the Show; *C. Mendelli*, *Lælia purpurata*, *Cymbidium Lowianum*, *Epidendrum prismatocarpum*, *E. vitellinum*, twenty spikes; *Masdevallia Harryana*, two dozen flowers; *M. Shuttleworthii*, *Odontoglossum Alexandræ*, *O. cirrhosum*, *O. vexillarium*, *O. Pescatorei*, *O. citrosum*, *O. Wilckeanum*, and *Oncidium Marshallianum*.

Mr. Perry, gardener to Mr. Cruger Miles, Bristol, showed a beautiful group. Amongst other fine plants was a good specimen of *Cattleya Mendelli*, also several examples of *Cattleya Mossiæ*, *Aerides Fieldingii*, with two branching spikes; a fine specimen and grand variety of *Odontoglossum vexillarium*, *Cypripedium caudatum*, and other good species and varieties. There was also an attractive group from Mr. Garland, gardener to Sir Thomas Dyke Acland, M.P., Killerton Park, Broadclyst, Devon. Two large plants of *Vanda tricolor*, each with two spikes, several good plants of *Anguloa Clowesii*, two large pans of *Cypripedium barbatum*, two plants of *Calanthe veratrifolia*, and others. Mr. Denny, gardener to Sir W. Marriott, Bart., Down House, Blandford, sent a fine specimen of *Cattleya Mossiæ* with ten flower spikes; and from Mr. Bowring of Windsor came a very handsome specimen of *Odontoglossum vexillarium* with sixteen flower spikes.

Miscellaneous groups and collections of cut flowers were numerous and good. Messrs. R. Smith & Son, Worcester, contributed large and handsome groups of Clematises, herbaceous plants, and Maples, including many interesting varieties. Mr. Hooper of Bath had a collection of Pansies; Messrs. Kelway & Son, Langport, had blooms of single and double *Pyrethrus*s, including many fine varieties, Roses, *Amaryllises*, &c.; Mr. Fricker, Bridgewater, staged collections of Tuberosus Begonias; Mr. R. Nicholls, gardener to Earl Fortescue, Castle Hill, South Molton, exhibited the large specimen Palms and other plants, which at the close of the Show were sold by auction by Mr. J. C. Stevens of Covent Garden. Mr. J. Lawless, Exeter, and Mr. R. G. Evered, Otterhampton, also contributed to the display.

VARIETIES OF HELLEBORUS NIGER.

I SEND with this note foliage of four distinct kinds of Christmas Roses (*Helleborus niger*). No. 1 I had from the late Miss Hope several years ago, and is the kind she named *Helleborus niger angustifolius*. This is the earliest-flowering of the group. The variety that comes nearest to it in the general appearance of the foliage is that marked No. 3. The segments of the leaf are narrower throughout in No. 1, the serrature of the leaflets not so deep, the venation less defined, and the general appearance smoother and slightly deeper in the shade of green. The leafstalks are also much longer. Nos. 2 and 3 were found in farmers' and cottagers' gardens for the true Christmas Rose. They are, however, quite distinct; No. 2 flowering before the other, with the blooms more open and less cup-shaped, while the back of the petals is a dirty pink, No. 3 being of purest white. The foliage is larger in all its parts in No. 2, though the general appearance of the two are alike, with the exception of the larger being much more "wrinkly" in appearance. No. 4 came from Miss Hope, named "H. niger maximus." It is the latest to flower of all, and in all ways the most distinct of the group. The foliage is larger, leafstalks stronger and longer, with the colour of the foliage darker, the appearance smoother, and the serrature of the edges very much smaller than in any of the others. Moreover, several of the leaflets are bifurcated.

Our plants were all lifted, divided, and planted on a south border last year, but they took unkindly to the change and yielded hardly

any flowers in the past winter. Doubtless the work had been undertaken too late in spring. However, a liberal surfacing of manure has effected wonders in the appearance of the plants, which are now making strong foliage, and will no doubt repay us with an earlier bloom in the coming winter. We cover the beds with framesashes. They are also better for protection from frost, which is apt to injure the petals, rendering the flowers worthless. A mulching of manure at the present time will prove of benefit to plants by carrying them through dry weather in safety, and in enabling them to throw a stronger bloom.—B.

THE RELIANCE ROTARY VALVE.

NOTWITHSTANDING the changes that have been wrought and the improvements effected in valves for regulating the flow of water in horticultural heating apparatuses during the past few years, the appliance under notice, patented by the Thames Bank Iron Company, is distinct from them all. It is introduced with the following description and modest statement of claim:—"The Patent Reliance Rotary Valve is exceedingly simple in construction, and very carefully fitted. All the moving parts are of the best gun metal, and will not set fast or get out of order. The handle, being the indicator, one half turn either way opens or closes the valve, and it cannot be strained or injured by over-turning.

"It will be seen by the illustrations that this patent as applied

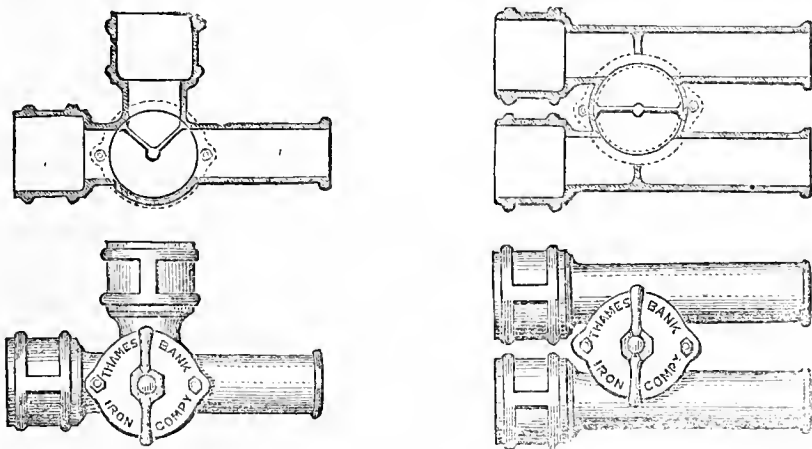

Three-way T valve.

Three-way H valve.

Fig. 106.

to H and T pipes dispenses with the necessity for the ordinary complicated three valves with their three handles, which are often turned the wrong way and thus put out of order, the one handle having control over the three water ways of the valve."

An examination of this appliance will, we think, afford satisfactory evidence that it is all that it is represented. It works with the greatest ease and smoothness, whilst the circulation in the dual or triple water ways is governed by one handle; and it is not material which way it is turned—the position of the handle as pointing in the direction of the pipes or the reverse indicating at a glance whether the pipes are open or closed. So far from this new valve being complex in arrangement, it is exceedingly simple; indeed, if simplicity of mechanism is an index of efficiency, as it not unfrequently is, and also of durability, the valve in question will quite merit the honour it won at the Royal Horticultural Society's Implement Show, at South Kensington, of a special certificate of merit.

We have not seen this valve in actual work, but are authoritatively informed that it was not until it had been fully tested and found satisfactory that its manufacture was proceeded with. The character of the firm, however, is such as to render an assurance of that kind superfluous; and the valve is submitted to the public, not as an elaborate scientific novelty, but as an article of practical usefulness.

AURICULAS AT NORWOOD GREEN AND THE MANCHESTER SHOW.

HAVING a great admiration for the Auricula, I have been fortunate enough to obtain a situation where I could gratify an ambition, long fostered, of forming a collection. I have taken full advantage of this, having in one year become the happy possessor of nearly a hundred plants, including many of the best varieties in commerce. A desire began to arise to see the Auricula at home in the north of England; and having some business acquaintance with Mr. George Rudd of Carnation and Picotee repute I wrote him, and received an invitation to visit Miss Woodhead's collection, which

I at once accepted. In due time I arrived at Undercliffe, and I was soon deep in Auricula lore with Mr. Rudd, who kindly rehearsed his successes and failures as an Auricula grower, thereby giving me some very useful hints. In raising seedlings Mr. Rudd has been most successful, with the late Mr. Woodhead. He does not believe in saving seed at random, all being carefully and scientifically hybridised, and that, too, only of flowers possessed of the very highest merit. Bright tubes being a desideratum at Norwood Green, any variety possessing this quality is eagerly sought for, the result being that most of the Auriculas raised from this collection have very fine bright tubes.

On arriving at Norwood Green, the residence of Miss Woodhead—who, on the death of her brother twelve months ago, removed from Shibden Head to this place, and where, let us trust, the Auricula will do as well as it did at Shibden Head—I was very kindly received; and after a few preliminary remarks Mr. Rudd led the way into house No. 1, which contains all the best varieties. Arranged along each side of a neatly constructed span-roofed house were between three and four thousand plants all in full bloom, some perhaps a little past their best. All the plants were in vigorous health, notwithstanding the check they received last summer in being shifted to their new quarters, and thereby delaying the potting season beyond the usual time. In this collection all the foremost varieties are well represented; George Lightbody, Alex. Meiklejohn, John Waterston, Acme, Beauty, Smiling Beauty, Colonel Taylor, Pizarro, and others being represented by nearly forty plants each. One or two varieties of recent introduction which I specially noted were Acme (Read), a grand white edge of good proportions, very smooth and flat and a most robust grower. John Simonite (Walker), another splendid white edge, but in my opinion it is inferior to Acme. It does not seem to have the same substance or finish as that fine sort; still it is a most desirable variety. Surpassing all that I have seen either at Norwood Green or anywhere else was the grand new white edge raised by the late Mr. Woodhead—Mrs. Dodwell. It is the most perfect flower I ever saw. It gained first honours in the class for seedling white edges, also a first class certificate at the National Auricula Society's Show, South Kensington, last year. Another fine white edge which was not open while I was there was Miss Woodhead, stated by Mr. Rudd to be better than Mrs. Dodwell, but I feel rather doubtful if such were possible. Among grey edges were George Rudd, a finely proportioned flower, and Charles Turner, a flower in every way deserving the name, both of them raised by Mr. Woodhead. Among older sorts of special merit Alex. Meiklejohn (Kay) stands very high, but its tube is scarcely smooth enough, otherwise it would be hard to surpass. Some very fine examples of it were in flower at Norwood Green. Prince of Green Edges is the finest colour in its class, and it is a great pity that we cannot say first-rate all round; but when we come to the tube we have to pause and admit that the weakness in this most essential point renders this fine flower ineffective. George Lightbody was in splendid condition, the flowers being large and flat. A very effective variety is Maria (Chapman), a grey edge with a very bright violet body colour, which contrasted well with its dark-bodied sisters around.

We next entered a house which is like the first one save in the contents, which consists mostly of seedlings, one side of the house being occupied with proved seedlings, the other side containing seedlings blooming for the first time. On the former side were some real gems. A few select flowers were named during my visit, but I will leave it for Mr. Rudd's more practised pen to report upon their merits. Suffice it for me to say that they were all really fine acquisitions. Some very good blooms were showing on the other side, but time will be required to prove their worth. Some very good Alpines are grown, but for fear of their pollen getting diffused among their queenly relatives they are kept separate, and when I saw them they were blooming profusely in the greenhouse, and they were by no means ineffective arranged among other plants, their delicious fragrance giving them an additional charm. Such are a few notes on the Norwood Green collection of Auriculas, my visit to which will always be a happy memory.

I returned to Undercliffe, there to wait for that great event to the northern Auricula grower, the Manchester Show. On Tuesday morning we started for Manchester, taking up Mr. Pohlman on the way with his valuable collection of plants, which made their mark so well at two consecutive shows, Newcastle being the other one. The scene in the hall where the Exhibition was held was a most lively one. Arranged along one side of the hall were the exhibitors busy getting their plants into competition form and reckoning up their chances of success. My notes were taken previous to the Judges awarding the prizes, as I had only a short time to spend in looking over the successful collections before leaving for home. The display to me was extremely imposing, the best of nearly two dozen collections being represented. One could

hardly help being struck with the many fine examples staged of such fine sorts as George Lightbody, A. Meiklejohn, Acme, John Simonite, Lancashire Hero, &c. One very fine plant of Alex. Meiklejohn shown in the first-prize collection for pairs was very much admired, and but for the tube, I suppose, it would have stood well forward for the premium. This honour, however, was reserved for that hero of a hundred fights the redoubtable George Lightbody, and a grand specimen it was, shown by Mr. Penson.

In Mr. Ben Simonite's collection were some very fine seedlings, one white edge especially, which "Ben" emphatically declares to be *the* white edge, and which he ran a narrow escape of losing, but he has succeeded after eight or nine years' watching in bringing forward a very small example of it, which, however, speaks well for its future fame. Some of Mr. Horner's grand seedlings were to be found in one or two collections. Sapphire, a gorgeously attired self of the brightest possible blue, also of fine shape and substance, was just such as to cause a short-lived pang of envy to shoot through the breast of the fancier who was not fortunate enough to be the possessor of a plant of it. Indeed the same may be said of all the seedlings shown, but long years must elapse before any of them will come within the range of a stinted income. Another fine self of Mr. Horner's production was Ringdove. Both of these varieties were shown in very good condition by Mr. Wilson of Halifax. In the collection of Mr. Samuel Barlow was to be seen the new seedling self Adonis, which gained first honours in the class for seedling selfs at the National Auricula Society's Show, South Kensington; a very neat smooth flower, but in my opinion rather small.

The Alpines were a great feature at this Show, Mr. Pohlman's collection being quite first-rate. This gentleman is to be congratulated on his success in raising such a fine batch of shaded flowers. Although there is a decided partiality at this Show for shaded Alpines, yet I am glad that there are classes for unshaded flowers also, these dark colours and bright golden centres forming a most lovely contrast. A few of the most notable Alpines were Mercury, Spangle, Col. Scott, Thomas Moore, Mrs. Thomson, John Ball, and Sidney, all of them raised by Charles Turner of Slough. Two of Mr. Douglas's varieties were extremely fine—namely, Florence and Prince.

I was rather disappointed with the Polyanthuses. Such old sorts as George IV., Lancer, Cheshire Favourite, Exile, and Lord Lincoln were very fine, but the newer varieties to my taste were very much inferior; and as for the Fancy Polyanthus, I fail to understand why a class should have been provided for it at all. I do not think it will ever become popular, or the present taste for refinement in florists' flowers will very much deteriorate; and for effect in the flower border some of the dark self varieties are far in advance of it. The seedlings of *Primula cortusoides* exhibited by Mr. Geggie were beautiful, some of them showing a decided advance in the older forms. My time now draws to a close, so after taking one last longing look at my pets I took train for auld Scotland again, having greatly enjoyed my short visit.—WM. MARSHALL.

THE OUTLOOK.

IN redemption of my promise in last week's Journal I give the results of observations I have made in many Rose gardens within the past fortnight, notably amongst the best known ones in Reigate and Canterbury—places which have made themselves of note in the Rose world. The letters also which I have received from many valued correspondents have been taken into account, comprising as they do memoranda from all parts of the kingdom; so that, with the Rose season well in view and within measurable distance of the first Rose show of the season, we may feel justified, I think, in forming a tolerably accurate estimate of our prospects; and I shall not be found, I hope, a false prophet when I say that we may, unless some most unforeseen calamity comes upon us, calculate on the very best Rose season we have had for some years, although how much depends on the weather of the next three months every Rose-grower knows. Even now (June 4th) the late lovely weather has been succeeded by a cold north-easterly gale, in which Roses cannot make much way; but knowing how rapidly they come on when the proper season arrives I hope that, notwithstanding that they are at present somewhat late, they will make up for lost time.

At Reigate I had a leisurely stroll through the four most famous Rose gardens of the neighbourhood—Mr. George Baker's, Mr. Waterlow's, Mr. Haywood's, and Mr. Wollaston's. All exhibitors know what formidable competitors these are. The gardens all differ one from the other, but in all there was one common feature—the Rose is most carefully nurtured and its wants most diligently considered.

I have never seen the Roses at Mr. Baker's at Holmfels (an

honoured Vice-President of our National Rose Society) in better, nay, in as good a condition as at present. Their boundaries have been enlarged, more Roses planted, and still I believe there are new worlds to conquer. Mr. Baker prunes early and prunes hard. His chief enemy hitherto has been the late frosts in May, and as we have escaped these his plants are of unusual vigour. The Teas especially are very fine, and we may expect to see some fine stands from this garden. The beds were all heavily mulched, and the fine rich colour of the young shoots was most cheering, giving evidence of the health of the plants. Here the seedling Briar and the Manetti are both largely used, and many very fine plants on their own roots bore witness to the success which attends this method of growing by those who have patience to wait for it. Extensive as Mr. Baker's collection is, it is not so extensive as Mr. Waterlow's, whose able and intelligent gardener, Mr. Brown, has for so many years occupied a foremost place amongst exhibitors. The Roses here, being situated on a warm slope with light soil, are more forward than at Holmfels, and the Russelliana stock is here very largely used. I have written of this before, and in Mr. Brown's hands it seems most admirably adapted for the soil and situation. Plants on it seem to be early and are vigorous; but I think the most remarkable plants here are those on their own roots. These are now some four or five years old and for vigour of growth leave nothing to be desired, while there need never be the fear of suckers or underground shoots. Mr. Brown finds no difficulty in starting some sorts which are said to be difficult, such as Baroness Rothschild: the plants of this variety were quite as fine as those of any other. A good quantity of maiden plants was evidencing signs of coming beauties. Mr. Brown pruned all his Roses about February 17th, and they do not seem to have been at all injured by the severe weather of March.

Mr. Ridout, the able gardener at Woodhatch, the charming residence of the respected Treasurer of the National Rose Society (Mr. Haywood), has his Roses in two different positions. The cutbacks are mostly in the upper part of the ground, near the house; the maidens in the kitchen garden, near the farm. And here, again, I saw the signs of advance. A far larger number of maiden plants were grown, and all the best varieties were of course represented, making it quite clear that it will not be a military promenade for those who may enter into the contest with him. Here, too, the seedling Briar is very largely used—indeed, everywhere it seems to be winning favour; which, however, in this, as in many gardens, it shares with the Briar cutting, of which Mr. Cant is the warm advocate. Mr. Wollaston's garden at The Devons has for years contributed many a winning stand to the exhibitions. His Roses are principally on cutbacks, and looked in excellent condition; while his Teas in the sheltered border in which he has them placed were forward and in good vigour. In all these Reigate gardens I was particularly struck with the cleanliness of the plants. Aphides were invisible, and the maggot not nearly so troublesome as in past years. These are two elements of success which augur well for the coming season.

I had the opportunity, through the kindness of Mr. W. Mount, of taking an afternoon's stroll through some of the Rose gardens at Canterbury—his own, Mr. Peckham's of Hall Place, Harbledown, and Mr. George Mount, the "harmonious blacksmith" (for is he not organist of his church?) who won such honours last year with his small collection of Roses; and in these, too, progress has been made. Mr. W. Mount's garden, of which I wrote some years ago in the Journal, is most charmingly situated by the banks of the Stour; but its situation exposes it to many enemies. It is very accessible to frosts and to whirlwinds, which come down from the high buildings near, consequently his Roses do not look so vigorous as they might. I am inclined to think that they have been too long in the same place, and that the ground is too full of manure. Were it mine I think I should take out the soil and fill the beds simply with good turfy loam without an atom of manure, leaving that for the mulchings which I should give them in the spring after they had started for growth; and from my own experience I should say, Lay them in until the spring, and then plant. He had a couple of hundred Roses last autumn, and of these, which were planted then, he has lost about forty. I had a hundred from the same place, which I planted in March, and of these I only lost four.

Mr. Peckham's beautiful place at Hall Place, Harbledown, looked lovely in the delightful afternoon sun. The flowering trees and shrubs were in great beauty, the spring bedding was still fresh and bright, while the glorious foliage of the trees was a picture in itself. The Roses here, too, which were many of them on low standards, were looking well, and, with the care bestowed on them by a good gardener, who has, however, a great deal of

other matters to look after, will, I should think, make a mark this year. From this to the small and noted garden of the "Harbledown Giant," as my friend Mr. Biron calls him (he is a little man), is but a step, and here too, again, progress is the order of the day—progress as far as numbers are concerned; but whether he will make much advance upon his wonderful success of last year is doubtful. A general is not always victorious; and it is not given to every general like England's "only" to have to fight against half-civilised or savage races, and so to win easily his laurels. Mr. Mount had formidable competition last year, and so no doubt he will this season, who will feel put upon their mettle to see if they cannot beat him. They will have something to do, for his Roses look in first-rate condition. He has a fine soil, a sheltered situation; is the pupil of a good master, Mr. Biron; is an enthusiast; and being at home is always popping in and out amongst his plants; indeed, I should not be at all surprised to hear some of these days that he had given up the anvil for the budding knife, and taken his place amongst the honourable fraternity of growers for sale.

Thus, as far as my observation goes, we may hope for a favourable season of exhibitions, but who can tell? The gale of the last two days has injured the foliage, and they have not that delicately fresh look that they had, while the experience of former years has taught us how unforeseen circumstances often disappoint our hopes. One thing, as I have said already, I think we may say that they are late, and that it will require fine and warm weather to bring them on for the earlier shows.

I am sure that all true lovers of the Rose will regret to hear that the veteran rosarian Mr. John Hollingworth of Maidstone is seriously ill, and will hope that he may be enabled to once more enjoy that which to him is a great treat, the Rose season.—D., Deal.

CALCEOLARIAS AT FARNHAM ROYAL.

MR. JAMES is well known as one of the most successful growers of herbaceous Calceolarias, The Redlees, Isleworth, having been long connected with his name. Probably many of his friends may not know that he retired in the autumn of last year to a comfortable and secluded home at Farnham Royal, about five miles from Slough, and in the vicinity of the far-famed Burnham Beeches. Here he has erected three substantial low span houses, each upwards of 80 feet in length, besides a lean-to from 30 to 40 feet long, all of which for some months past have been filled principally with Cinerarias and Calceolarias. The former are now considerably past their best. That the quality has been good the many certificates obtained from the Royal Horticultural and Royal Botanic Societies during the season is ample proof.

At the time of my visit, a few days since, two of the 80-foot-long span houses were each half filled with probably the finest batch of Calceolarias that have ever been produced, the banks of glowing colours being a grand sight. The remarkable evenness of the whole was most noticeable—a compact habit of growth with immense heads of bloom, carried without the support of stakes, many more than 2 feet in diameter, and all growing in 6 and 7-inch pots. Several individual flowers measured just 7 inches in circumference, the colours throughout being rich in the extreme—rich dark maroon, bright crimson, fiery red, rosy-crimson, magenta, buff and orange buff, bright yellow, pale yellow, sulphur, some approaching pure white, and various others. The dark self-coloured flowers are very rich and abundant, which with the spotted forms of all colours innumerable make a show such as is seldom seen.

One point worthy of mention is the cleanliness of the whole collection, the aphid, usually so troublesome, having been kept thoroughly under before the advancement of the flowers.—C. H.

SELBORNE, STREATHAM.

AT the leading metropolitan exhibitions within the past two or three seasons the plants from the above garden, the residence of J. Southgate, Esq., and shown by the energetic gardener, Mr. Salter, have obtained such prominent positions and so many honours that a short notice of the collection will be suitably given. The present time is peculiarly fitted for such a record, as Mr. Salter's success during the past month at the Crystal Palace, Royal Botanic and Royal Horticultural Societies' Shows was even more than usually satisfactory, the Orchids exhibited at each being highly praiseworthy. This was particularly the case with the group at "the Palace," which presented such a tasteful combination of rich, bright, and soft colours, healthy well-flowered plants, and fresh green Ferns that it was greatly admired by all, and, indeed, formed one of the most notable features of the Show.

It is well known that at Selborne Orchids constitute the bulk of the collection, and to them, therefore, chief attention will be given, though Mr. Salter has by no means confined his efforts to those plants, as the fine strain of Calceolarias, the healthy fruitful Vines, Melons, and Cucumbers, with the miscellaneous collections of Chrysanthemums, bedding, stove, and greenhouse plants, bear witness.

THE HOUSES.

There is always more credit due to the man who produces good results under unfavourable circumstances than to him who has every appliance expressly fitted to assist him, and an instance of this is afforded at Selborne. Of the half-dozen houses devoted to Orchids only two can be said to be perfectly satisfactory in construction and heating. The others are mostly too lofty, and were never intended for the purpose to which they are applied. Yet the plants throughout are as vigorous and clean as could be desired, and they flower abundantly, proving how much can be done by care to overcome disadvantages that cannot be entirely removed. The *Odontoglossum* house and the *Cattleya* house, however, are exactly what are wanted, the last-named being a new and especially well-built structure. It is a lean-to facing nearly direct east, 36 feet long by 10 feet wide, and about the same in height at the back. There are stages back and front, and beneath these are the pipes (4-inch), three rows in front and two behind. The shelves are of slate covered with a layer of small pebbles, which are also employed in the other houses, as they are found the best material to retain moisture, and yet not serve as a harbour for insects. The plants are mostly elevated on inverted pots, so that they are brought within a short distance of the glass, this being well exposed to light; and the result is strong and finely matured growths, which are now showing either flowers or sheaths by scores, promising a grand display a little later in the season.

The *Odontoglossum* house is also a lean-to 30 feet by 10 wide, shelves back and front. Provision is made so that in the winter a minimum temperature of 50° can be provided; as Mr. Salter considers that though many cool-house Orchids will endure a much lower temperature, yet they suffer more or less and are not so satisfactory as when the degree named above is made the minimum. This may be so, but I have grown such Orchids in houses where the temperature has been allowed to fall as low as 40°, frost only being excluded, and yet the plants were both strong and flowered well; indeed, in one establishment I once saw a framel of *Odontoglossum Alexandræ* which had been exposed for a whole night to severe frost, the lights and coverings having been blown off, and yet comparatively few died—certainly not more than 10 per cent.—and the others flowered as freely as usual. In this case, however, the plants had been hardened to a great extent for many months, and were thus better fitted to pass the ordeal. As regards the Selborne plants no alteration of treatment could produce better results, and, to adapt the homely proverb, "the proof of the pudding is in the eating."

Of the other structures little need be said, except to mention a porch or entrance, in which is a small rockery with flowering plants and Ferns, which serves as an introduction to the other houses, and is useful, especially in cold weather, as, the outer doors being closed before the inner ones are opened, the sudden admission of draughts of cold air is prevented—a most important point. Such porches are indeed being generally adopted wherever large and choice collections of Orchids are grown, and the addition so made to the Orchid houses at Kew some time ago was a most decided improvement, as, owing to the great numbers of persons frequently passing through, serious injury resulted to the plants from exposure to the keen air so admitted.

THE ORCHIDS.

It would be difficult and unnecessary to enumerate all the Orchids of merit in this collection, but a few of the most remarkable for beauty or rarity may be appropriately noticed. First on the list is—

Dendrobium nobile var. *nobilius*, of which Mr. H. James gave such an interesting description recently in this Journal, page 378. The largest plant has six pseudo-bulbs, and as much as fifty guineas has been offered for it and refused; indeed, an experienced Orchid grower recently stated that every growth made by plants of this variety is worth ten guineas. Some of the old pseudo-bulbs have been separated from the parent plant and tied to blocks with damp sphagnum moss, and at nearly every node young growths are starting, which will ultimately make plants if all goes well with them. Mr. Salter has tried to effect a cross between *D. nobilium* and *D. Ainsworthii*, making the former the seed-bearing parent. A pod is swelling, just showing that fertilisation has been accomplished, but what the result will be cannot

of course be yet determined, and some years must elapse before the seedlings that may be produced will flower. If, however, a satisfactory cross has been really effected between the two plants named the progeny may be confidently expected to yield something of a remarkable and beautiful character.

Many of the best Dendrobies are grown, *D. Wardianum* being in large numbers, between thirty and forty plants being in fine condition. The rich golden *D. suavisimum* is also represented by several good plants; one showing six spikes will be very handsome in a short time. Fine varieties of *D. primulinum*, *D. Devonianum*, and *D. Falconeri* are all attractive in no ordinary degree. The handsome *D. albo-sanguineum* must not be omitted, its fine buff or creamy flowers, which are relieved by the heavy blotch of rich crimson purple on the lip, are amongst the most showy of the genus. At Selborne this plant is grown in the *Cattleya* house, as it enjoys a high temperature with abundance of moisture; and when so treated it flowers well either in baskets or on blocks, and its blooms last in good condition for a long time.

Cypripediums are numerous, many specimens of considerable size being grown, and including most of the finest species, varieties, and hybrids in cultivation. Most of Messrs. Veitch's hybrids are represented by good plants. The beautiful, distinct, and floriferous *C. albo-purpureum* (see page 473) is especially well grown, and well merits the high encomiums it has received. *C. Stonei*, with eight spikes of a good variety, is notable, as also is *C. Druryi*, a rather rare form, with yellowish flowers barred with brown. The snowy-white *C. niveum* is flowering well, with many others.

Cattleyas.—The grand condition of these plants has already been referred to, and it now only remains to note that some of the finest varieties of *C. Mossiae*, *C. Mendeli*, *C. gigas* are included, the two former being particularly numerous and varied in colour and markings, the sepals and petals white bluish or rosy-tinted, the lip of all shades, from the richest dark crimson to delicate bluish, the throat streaked with gold. The handsome *C. Warneri* has three fine spikes, with a total of thirteen flowers; the variety, too, is very good, the lip large, richly coloured, and beautifully fringed. This is one of the best of the *Cattleyas* when in good form, and deservedly bears the name of an ardent Orchid lover.

Of the other tropical species *Vandas* are in strong force, the rare *V. Dennisoniana* being in fine condition. One good plant of *V. suavis* has three large spikes, *V. cœrulea* being represented by some of the best varieties, though not in flower at the present time. The neat white *Phalenopsis tetraspis*; the well-known favourites *Aerides Fieldingi*, *A. Schrœderi*, the white *Burlingtonia venusta*, and *Saccolabium ampullaceum* are all flowering freely. *Epidendrum Parkinsonianum* (paleatum) with its large flowers, the curious three-lobed white prominent lip, is bearing several blooms on a block, *Calogyne Massangeana* with a spike of twenty-three flowers, *Aerides japonica*, *Oncidium Harrisianum*, *Odontoglossum vexillarium*, *Oncidium citrosum*, and *Trichopilia crispa*, are only a few of the many fine plants in the collection.

Utricularias.—These are exceedingly well grown at Selborne, and several handsome plants suspended from the roof of the houses are very remarkable. One pair in particular, in baskets 7 inches square, have thirty to forty racemes, or considerably over 100 flowers each. Some smaller specimens of twelve to twenty racemes each. This is a beautiful plant when well grown, and it is by no means difficult to have in good condition with a little care. The temperature of any tropical Orchid house suits it, and suspended from the rafters they have a most pleasing effect, the large white flowers being relieved by a blotch of orange on the lower lip of the corolla. *U. Enlresii* is similarly well grown, though the plants are smaller at present.

COOL-HOUSE ORCHIDS.

Amongst these *Odontoglossum Alexandræ* is very well and largely grown, the varieties being numerous, the flowers large and beautifully formed. *Masdevallias* are similarly numerous, *M. ignea*, *M. Lindenii*, and *M. Harryana* being represented by finely coloured varieties. The great curiosity amongst the species of this genus is *M. Chimæra*, which has several of its strangely coloured and peculiarly marked flowers, the tails of the sepals being 9 inches long. *M. Shuttleworthii* also, though of quite a different type to the above, is likely to be one of the most useful of the small-flowered species, its purple-dotted flowers being produced so freely. Scores of others could be enumerated, but the above will suffice to indicate the extent and character of the collection.

It is agreeable to place on record that, though this might be termed a garden devoted to a speciality, every other department is well done both inside and out, and is alike creditable to Mr. Salter's energy and care.

It should be added that Orchids are not the only attraction at Selborne, for Chrysanthemums are well grown, and at Tooting and Brixton last year they were much admired. The white James Salter, named Lady Selborne, which has already been distributed and favourably received, originated as a sport in these Gardens a few years since, and has been honoured with several certificates. Melons and Cucumbers are successfully grown, and of the last-named Mr. Salter has a much-prized selection which he calls Selborne Rival, and is remarkable for its even shape, moderate size, and extreme prolificness.—L. CASTLE.

DEAD BRANCHES DETRIMENTAL.

I HAVE been asked whether the statement lately going the rounds of the American papers that "a dead branch on a tree makes almost as great a strain on the main plant for moisture as does a living one" is accurate or not. The statement is coupled with another referring to its practical application in tree culture, the conclusion being that every dead branch "should be at once cut away." Briefly it might be answered that the first statement is true in the main, and that, without any doubt at all, the conclusion is a wise one, and ought to be followed in practice. To explain this matter will take considerably more space, and in order to understand it we must go to vegetable physiology and inquire into the nature of the evaporation of water from plants. It was long supposed to be a physiological process, and was considered to be entirely different from ordinary physical evaporation. As long as this view was held the process was called transpiration, to distinguish it from the physical process. The breathing pores, the stomata, which occur in the epidermis of all leaves in great numbers, were supposed to be organs of transpiration, which was considered to be one of the most important functions of the leaf.

Within a few years, however, our knowledge of these matters has been greatly increased, and we now know that the escape of water from the leaf does not differ in any way from the evaporation of water from any other moist surface. A leaf is a mass of cells, every one of which is gorged with watery matter, which in a dry atmosphere, as a matter of course, tends to escape. The epidermis, composed of dryish impervious cells, which entirely surrounds the watery cells of the leaf, would prevent almost completely the evaporation of water from the latter were it not for the breathing pores before mentioned. These pores are for permitting the free ingress and egress of gases, particularly oxygen, carbonic acid, and probably, also, ammonia. Now, when the pores are open for their legitimate purpose it happens that more or less water escapes if the air is dry. If the air happens to be very moist the loss of water through the breathing pores is very little, or even none at all.

We may put it in this way: The leaf loses water simply because it is a watery structure; its epidermis is designed to prevent this loss, and the breathing pores with their power of opening and closing are for the same purpose. A leaf instead of being an organ of evaporation is actually a structure in which evaporation is quite successfully checked. Careful experiments made under my supervision in the Iowa Agricultural College in 1880 by Miss Ida Twitchell, a graduate student, demonstrated that the evaporation from a moist piece of dead wood was exactly like that from a living leaf. Now, when a dead branch is large enough to keep continually moist in the interior it will in dry air constantly lose water by evaporation from its surface. This water so lost is taken from the tree, and must have been supplied directly or indirectly by the living portions. Moreover, it must be remembered that a living branch is well protected against loss of water through evaporation by the epidermis which covers all its surface when young, or the impervious corky bark which is always found on it when older. When a branch dies these protecting devices soon fall into decay, and the water, so carefully guarded by the living parts of the plant, is wasted by evaporation.—PROFESSOR C. E. BESSEY (in the *New York Tribune*).

TULIP SHOW IN MANCHESTER.

THE annual Exhibition of the National Tulip Society was held on Saturday last at the Botanical Gardens, Old Trafford. The weather was gloriously fine, and there was a large attendance of the general public. The exhibitors, some thirty in number, came from all parts of the country, and the Show generally was a much better one than any of its predecessors. The flowers were stronger and in finer condition than we remember to have seen them for years, and the character of the refined blooms was far in advance of what we have been accustomed to, and were more nearly perfect than has been the case for some time past. The following is a list of the principal awards:—Five stands of twelve dissimilar Tulips, two feathered and two flamed in each class.—First, Rev. F. D. Horner, Kirkby Malzeard, near Ripon; second, Mr. W. Kitchen, Stockport;

third, Mr. S. Barlow, Castleton. Eight stands of six dissimilar Tulips, one feathered and one flamed in each class.—First, Mr. D. Woolley, Stockport; second, Mr. S. Barlow; third, Mr. W. Kitchen. Four stands of six dissimilar Tulips, one feathered and one flamed in each class.—First, Mr. E. H. Schofield, Lower Wortley, near Leeds; second, Mr. H. Houseley, Stockport; third, Mr. Thomas Baker, Pennington. Six stands of three feathered Tulips, one in each class.—First, Mr. S. Barlow; second, Mr. W. Kitchen; third, Mr. S. Schofield. Six stands of three flamed Tulips, one in each class.—First, Mr. D. Woolley; second, Rev. F. D. Horner; third, Mr. R. Sharpley, Wakefield. Three stands of two Tulips, one feathered and one flamed, of any class.—First, Mr. R. Woolfenden, Royton. Six stands of two Tulips, one feathered and one flamed, of any class.—First, Mr. H. Houseley; second, Mr. R. Sharpley; third, Mr. S. Barlow. Single bloom, feathered bizarres.—First, Mr. W. Whittaker, Salford; second, Mr. J. Knowles, Stalybridge; third, Mr. J. Morris, Bedford Leigh. Single blooms, feathered Roses.—First, Mr. H. Travis, Royton; second, Mr. J. Morris; third Mr. J. Knowles. Single blooms, feathered byblœmens.—First, Mr. D. Woolley; second, Mr. William Kitchen; third, Mr. W. Whittaker. Single blooms, flamed bizarres.—First, Rev. F. D. Horner; second and third, Mr. W. Whittaker. Single blooms, flamed roses.—First, Mr. S. Barlow; second, Mr. R. Sharpley; third, Mr. D. Woolley. Single blooms, flamed byblœmens.—First, Mr. H. Houseley; second, Mr. R. Sharpley; third, Mr. H. Houseley. The best feathered Tulip and the best flamed Tulip in the Exhibition.—Rev. F. D. Horner. Breeders.—Six stands of six dissimilar Tulips, two of each class.—First, Rev. F. D. Horner; second, Mr. S. Barlow; third, Mr. J. Wood. Six stands of three Tulips, one of each class.—First, Mr. W. Kitchen; second, Rev. F. D. Horner; third, Mr. J. Wood. Single blooms, byblœmen breeders.—First, Mr. S. Barlow; second, Rev. F. D. Horner; third, Mr. S. Barlow. Single blooms, rose breeders.—First and second, Mr. S. Barlow; third, Rev. F. D. Horner. Single blooms, bizarre breeders.—First, Mr. S. Barlow; second, Mr. Martleu, Pemberton; third, Rev. F. D. Horner. The best breeder Tulip of any class in the whole Exhibition.—Mr. S. Barlow.—(*The Manchester Courier.*)

A HARDY FLOWER BED IN THE GRASS.—I have a large flower bed in the grass beside the avenue, and away from those in the flower garden proper, that to my mind the combination is worthy of notice, especially as being effective now, the period when the spring garden is losing its beauty and the summer garden beds are not yet, in many instances, even filled. It is nearly 20 feet in diameter. The centre is *Anemone coronaria* (scarlet), massed. They are seedlings, but transplant badly, and are best the first and second year. Next *Limnanthes Douglasii*, about 2 feet of a belt around. Then Japan Primroses (red), and lastly *Narcissus poeticus*, fl. pl. Tall trees shade the bed from the midday sun, and thus the flowers keep fresh the longer.—W. J. M., *Clonmel.*



[By the most skilful Cultivators in the several Departments.]

KITCHEN GARDEN.

SOWING has been mostly brought to an end now, and when we have got in a few more rows of late Peas, Kidney Beans, and Broad Beans it will be finished. Turnips, Spinach, and salads are the only exceptions, and all of these will be sown monthly until August. Vegetable gardens have now a full appearance, and vegetables are becoming plentiful. Weeds are growing fast, and must be promptly destroyed. Many weeds are annually introduced with the manure, and in some cases they may originate from the seed which was allowed to ripen and fall last year; but few have seeded now, and timely hoeing will not only be beneficial at present, but few will appear in autumn, and they will be thinned generally. Amongst rows of young plants, such as Onions, Carrots, and Turnips, the weeds should be drawn out from between the plants with the hand, and then the hoe should be run between the rows.

Do not be in a hurry to thin Horn Carrots in the open quarters until they are large enough for use, when they may be drawn freely, and the permanent crop may be left 3 inches from plant to plant. Where Carrots, Onions, or any other young vegetable plants are dying through being eaten by some grub at the root, water the soil about them thoroughly with strong soot water.

Many plants require thinning now, especially in cases where thick sowing was practised. Unless for exhibition we never thin one of our spring-sown Onions. In some parts they are in

clusters, and here and there they have come as if they had been thinned, and in these places large bulbs are sure to form; but where they are growing so close they will only be medium in size, and this is what we want, as the smallest Onions are always the best for keeping through the winter and far into spring. At the final thinning Parsnips should not be closer than from 15 inches to 18 inches apart if really fine roots are wanted, and Beetroot should be left 12 inches apart, or less if small roots are in demand.

Our William I. Peas are now very useful, but to get these and others to fill the pods quickly the points are taken out of the shoots before they have obtained their full height. This has a wonderful effect in causing the pods to fill up quickly, and the practice acts on Broad and Runner Beans in the same way. In dry poor soils Peas will now be much benefited by being mulched. Good moist manure cannot always be obtained for this purpose, but cuttings and sweepings from lawns and any old half-decayed refuse makes very useful mulching, and should be used freely.

Vegetable Marrows and ridge Cucumbers growing on mounds are now showing fruit, and will soon give a supply; but great attention must be given to the watering, as dryness at the root causes the fruits to become yellow and drop. When spring Cabbages are cut, if it is not desired to retain the stems and grow them on to supply side heads further on, clear them all off, manure the ground in digging, and plant at once with Veitch's Cauliflower. All planting of young vegetables may be carried on as soon as ground has been cleared. The earliest Potatoes will soon be all lifted, and ground of this kind should never be allowed to remain empty; in fact, empty spaces, poor crops, or any disorder should not be visible in a kitchen garden at the present time.

FRUIT FORCING.

Peaches and Nectarines.—Trees expected to afford full crops of fruit in May and the early part of June require careful treatment to keep them in health and bearing for a number of years consecutively, as they have to make their growth at the dullest period of the year, to ripen it and rest at the hottest. It is of the greatest importance to pay particular attention to syringing and watering the trees as they become cleared of their fruit. The borders outside as well as inside must have copious supplies of water, giving weakly trees liquid manure, which will help to plump the buds and recruit the trees. All useless wood from which the fruit has been gathered must be removed at once, and if the roof is formed of moveable sashes they should be entirely withdrawn during rain, and at other times ventilate freely both night and day, which will tend to steady and perfect maturity of the wood, and prevent premature development of the buds. Those wishing for very early fruit will be acting judiciously to have the requisite number of trees to give the fruit required in a house by themselves, and not mixed with mid-season and late varieties, as trees with ripening fruit require different treatment to those with the fruit in the last stages of swelling. For ripening in April, the trees being started early in December, we have a great acquisition in Alexander, of good size, fair colour, and excellent quality.

Houses in which the fruit is ripening will not require much artificial heat, none in bright weather, but in dull wet weather a little will be necessary. In the later succession houses tying in the young growths and stopping laterals must be carefully attended to, syringing the trees vigorously twice daily in bright weather, but in dull weather do not keep the trees dripping with water. Whatever is done in the matter of syringing should be so as to allow the foliage to become dry before night. Stop the shoots beyond the fruit, and remove or turn aside any leaves that shade or interfere with the colouring of the fruit. Top-dress inside borders with short manure and apply water copiously, giving it until passing freely through the drainage. If red spider appear promptly apply an insecticide.

Vines.—Late Vines still in flower of the shy-setting kinds must have every attention, affording fire heat sufficient to maintain a circulation of dry warm air, ranging from 80° to 90° in the daytime and 70° at night, artificial fertilisation having daily attention, taking pollen from Hamburgs. When set clean the bunches by syringing with clear rain water, and proceed with thinning at once, as every day lost tells against the Vines and the crop. In the case of shy setters it is advisable to thin out the small berries only in the first instance, going over them two or three times, as the berries that have but one or two stones in them cannot well be distinguished at the first thinning. Grapes intended to hang through the winter require rather severe thinning, but not so as to produce loose bunches. Muscats and Lady Downe's passing

through the stoning process must be closely watched, especially during bright weather succeeding dull and cloudy; and if scalding sets in the night temperature should be kept up at 70° to prevent condensation of moisture on the berries, and a free circulation of air should be given, continuing this for a fortnight or three weeks, when all danger will have passed. Late Hamburgs, though only in flower, need not be hastened, but should have a liberally ventilated atmosphere and a temperature of 55° to 65° by artificial means secured to them. Vines swelling off their crops should have a healthy atmosphere secured to them, and if fire heat cannot be altogether dispensed with much may be done by early closing that will greatly economise fuel. Grapes ripening off will require a constant circulation of air, and when quite ripe the house must be kept cooler and the supply of atmospheric moisture reduced; but there must not be any approach to aridity, or the foliage will suffer from red spider, and the roots must not be allowed to become parchingly dry, or the foliage will ripen prematurely. Hamburgs that are dead ripe should be shaded from very bright sun, or the colour will suffer.

PLANT HOUSES.

Stove.—Gardenias that were cut back some time ago have now broken well into growth. Give them every attention as regards heat and moisture to encourage them to grow. Stop any young growths that are taking the lead in order to make them break back, or at the end of the season they will be straggling instead of dense bushes. Encourage the young stock, which should by this time be well established in 6-inch pots; these can be placed in larger if deemed necessary, or liberally fed with stimulants after their pots are full of roots. Give abundance of water at the roots as well as on the foliage. Cuttings rooted some time ago must be potted as they require it. Do not allow them to become root-bound. Do not shade these plants, or their growths will be soft and incapable of producing abundance of fine flowers when required to do so. Admit air daily when favourable, and close the house or pit early in which they are growing.

Gloxinias.—Plants from seed that was sown early in the season, and were pricked off in pans or small pots, are now ready for placing in pots 4 inches in diameter, and when well established in these to be placed in others 2 inches larger. After potting keep them close for a time, and then grow in more air than has been possible up to the present time. When the season has well advanced, strong heat and dense shade with moisture thrown over the foliage either from the water-pot or syringe is detrimental to these plants. Under these conditions the flowers are soft and require support, as well as possessing but little colour compared with those grown under cool treatment. From this time any of the earlier batches will do in the conservatory while in flower, and will last much longer in such positions than where moist heat is maintained. A little more seed may be sown, and the plants grown on for flowering in heat during late autumn.

Achimenes.—Those started early in the season and allowed to come forward are in flower, and the conservatory is the best place for them. Those pans that were topped and the cuttings rooted as advised are dense masses and will require staking, and by judicious treatment will form a good succession to those now in flower. The cuttings rooted early will in a week or ten days be in full flower, and will be invaluable for decoration either in dwelling-rooms or in the conservatory. Supply weak stimulants as the pots and pans become full of roots, and do not allow them to suffer by the want of water. The tops of plants from tubers started late can be taken off and rooted as previously directed.

Tydeas and Gesnerias.—Where these are intended to make a display in winter and have been allowed to start into growth in the old soil in which they rested, no time should be lost in having them shaken out and repotted. The better plan is to start them in small pots and then shift them as they require it into 5 or 6-inch pots, which is large enough for all ordinary decorative purposes. These plants delight in heat and moisture, and do best when standing upon tan or any similar material where there is slight bottom heat. Cuttings of *T. Madame Heine* may still be rooted, and will make grand plants for the winter. Those rooted as early as cuttings could be obtained and well established in 4-inch pots may have their tops taken from them and rooted.

Sciadocalyx Luciana.—Plants that are now in flower have abundance of young shoots springing from the base, which if taken off and rooted will be found most useful in winter. This plant requires similar treatment in every way to the *Tydea*, which must be perpetuated by cuttings, as it forms no underground stems, and any attempt at drying it off ends in failure.

THE BEE-KEEPER.

THE REWARD OF PERSEVERANCE.

THOSE who are beginning to keep bees may be encouraged by my experience. My first experiment was with a swarm which was found during July, two years ago (1881). None of us knew how to manage them, and they died during the ensuing winter. Last year a friend gave me her first swarm on the 20th May. I was determined not to lose my new bees by ignorance, so I read up the subject in the numbers of your Journal and in various books, and fed the bees liberally for ten days or a fortnight. On the 12th of July we had a capital maiden swarm, which we also fed for awhile. As the first swarm was in a skep, and I wished to have only bar-frame hives, in August we drove the bees into the new hive. I was obliged to leave home the next day, and when I returned I found the first swarm that had been put into the bar-frame hive in August in a deplorable state from robbers, and we were obliged to abandon the hive altogether. The maiden swarm did well, was fed in autumn and again in spring, and a super put on about the end of March. There was a swarm on the 15th of May, a second swarm on the 27th, and two others on the 31st, which two last were hived together. The bees in the old hive continue to do well. They have been working in the super, and one 2-lb. section of honey was taken out on the 27th and 28th of May. I think this proves how much may be done by feeding and keeping bees warm in winter. The gardener and I are very proud of our bees. I have found that strong tobacco cut up, damped with water, and rubbed on the place a most effectual remedy for a bee sting. It is also recommended in Mr. Payne's book upon bee-keeping.—M. B. D.

REVIEW OF BOOK.

Bee-keeping, Plain and Practical; How to Make it Pay. By ALFRED RUSBRIDGE. London: E. W. Allen, 4, Ave Maria Lane.

THIS is a volume of 140 pages in ornamental paper cover. It is clearly printed on good paper, written in a plain chatty style, and contains many illustrations. It is evidently intended as a plain guide to inexperienced bee-keepers. We extract the following on

SWARMING.

"To hive a swarm quickly and successfully is an extremely simple affair, though the novice may not, perhaps, regard his first attempt in that light. If unaccustomed to the operation it is best to avail one's self of the protection afforded by veil and gloves, through which the bee-sting cannot penetrate to the flesh. These may be had at a trifling cost. Bee veils are usually made of black net, with an elastic band at top. Worn on a broad-brimmed hat the operator may laugh at the ire of his puny assailants, and proceed calmly about the business in hand with the consciousness of perfect security.

"The time when first swarms generally appear varies somewhat according to the locality. In our district it ranges from the last week in May to the first week in June; whilst a few miles north under the shelter of the hills, it is about a week earlier. A first swarm is invariably led by the old queen, a fine day being selected for the migration. Second and third swarms, or 'casts,' are less particular in their choice of weather. The hour of swarming is, as a rule, somewhere between 11 A.M. and 1 P.M. But in cases where the bees have been kept at home for a day or two by stress of weather, and the clouds at length clear away, and the sun again appears shining clear and hot in the warm garden, then swarming frequently takes place, irrespective of the hour, unless the afternoon be too far spent. We have known swarms issue as early as eight in the morning, and as late as four in the afternoon, but these are exceptional cases, proving the trite remark that 'bees do nothing invariably.' A swarm may be expected at any favourable opportunity when the bees commence clustering outside nightly at the entrance. Sometimes, in hot weather, half a gallon or more will hang around the bottom of the mass, perhaps touching the ground. Second swarms may be expected from seven to nine days after the first.

"In starting an apiary many prefer swarms to old stocks. The latter plan, however, has its advantages, as the old hive, if a straw skep, will do for stock purposes, though it is not so manageable as a bar-frame hive, and the first swarm will repay the cost of purchase. It need hardly be observed that the discordant sound produced by fire shovel, door key, and warming pan, is certainly not calculated to induce the swarm to settle when on wing. The practice belongs to bygone generations rather than to the present day.

"As soon as the bees are gathered in a cluster, hold the hive underneath with one hand, and give the branch a vigorous shake with the other; this will shoot them into the hive, which must then be placed

on the ground, resting it on a couple of sticks to prevent crushing the bees on turning it down. Put a roof on top to shade it; in the evening set it on the stand. Some writers recommend that it be placed on the stand at once, but this is not advisable, as it would have a tendency to weaken the swarm, for many of the bees will continue flying round the site throughout the day, and failing to find the whereabouts of their comrades they will eventually return to the parent stock, thus greatly diminishing the original number of the swarm. When the bees settle in a difficult place—in the heart of a Gooseberry bush for example—gently move the boughs apart, and put the hive just over it, allowing it to remain undisturbed for a time; but if this does not allure them into it, then place the hive on its side as near the swarm as may be, and sharply brush them into it with a wing or with the hands if gloved. If you happen to get stung in the meanwhile remove the sting with the point of a penknife or with tweezers, as squeezing the base of it with the fingers has the effect of ejecting more poison into the wound. Afterwards, firmly press the open end of a padlock key over the part, which will force the poison out, and then apply a drop of salad oil, laudanum, or ammonia, and the smarting sensation will at once cease. This will be found a simple cure for stings of other insects. The relief is immediate and complete if done at once, but if delayed five or ten minutes it is not so efficacious, as the poison spreads in the meantime, and so becomes more difficult to eradicate."

This is a fair example of the volume before us both as to style and matter, the other chapters embracing the routine of bee management being similarly treated.

BEES AS AIDS TO FRUIT-GROWERS.

THAT the nectar in flowers is an aid to their fertilisation, in a general way, by inducing insects to distribute the fecundating element from the staminate blossoms, by conveying it on their bodies during their flights among the flowers while collecting the exuding sweets, is evident; that this is the sole object for which nectar is secreted does not seem admissible.

Pollen is borne from flower to flower on the breeze as well as on the bodies of insects; in fact, that appears to be Nature's prime method of conveying the fertilising germs from the anthers of the staminate to the stigmas of the pistillate blossoms. Among insects, it seems the honey bee, in her floral wanderings in search of nectar and pollen, in consequence of her peculiar form and downy covering, should be entitled to a first place in the work of direct and cross fertilisation of fruit-producing flowers of all kinds; and were it not for this generous and disinterested aid to the chances of Nature, the loss to fruit-growers would be much greater every year from sterile bloom.

That the honey bee causes injury by extracting the nectar from fruit-producing trees and shrubs is simply fallacious, notwithstanding the oft-expressed opinion of those ignorant of Dame Nature's process of reproduction to the contrary. During the past two following seasons I have observed Apple trees loaded with well-developed matured fruit trees in autumn that bloomed several days earlier than the remainder of the orchard, and were swarming with bees until the bloom from the other trees shared their attention. Two of the trees alluded to stand but a few feet from some of my hives, and have always been favourites with the bees during the season of bloom, but I have yet to note any diminution in their products caused by the bees sipping nectar from their blossoms.

The discussion of the subject of "planting for honey" is receiving merited attention. Would not a favourable influence be exercised by having a space in the bee publications in which those who have tested the qualities of honey-producing trees, shrubs, and plants of various kinds can be allowed to give their experience in detail? The names of trees, &c., and their adaptability to location is needed, as the pursuit of the apiarist is constantly prompting his attention to the sources from which honey is obtained by his bees, who is more favourably situated to observe and reduce the results of his observations to utility.

Again, if properly appreciated, a triple benefit may be derived from the result of such a consolidation of effort; a more general cultivation of food-producing trees, shrubs, and plants, a more bountiful return for apiarian enterprise, and the unequalled advantages of studying the illustrations of Nature from her open book of floral beauty.—J. F. LATHAM (in *American Bee Journal*).

TRADE CATALOGUES RECEIVED.

T. Woodcock, Woodford Nursery, Berkeley.—*List of Bedding Plants.*

J. Carter & Co., 237 and 238, High Holborn, London.—*List of Miscellaneous Novelties.*

Ant. Roozen & Son, Overveen, Holland.—*Catalogue of Dutch and Cape Bulbs.*



** All correspondence should be directed either to "The Editor" or to "The Publisher." Letters addressed to Dr. Hogg or members of the staff often remain unopened unavoidably. We request that no one will write privately to any of our correspondents, as doing so subjects them to unjustifiable trouble and expense.

Correspondents should not mix up on the same sheet questions relating to Gardening and those on Poultry and Bee subjects, and should never send more than two or three questions at once. All articles intended for insertion should be written on one side of the paper only. We cannot reply to questions through the post, and we do not undertake to return rejected communications.

Book (*Eucharis*).—Mr. B. S. Williams' work on "Choice Stove and Greenhouse Plants" will probably suit you. It is in two volumes: one devoted to flowering plants, and the other to fine-foliage plants. The former is 7s. 6d., the latter 5s., and can be had from the author at the Victoria and Paradise Nurseries, Upper Holloway.

Grapes Spotted (*B.*).—Had you sent a few leaves we might probably be able to indicate the cause of the spotting, but without seeing them, and especially in absence of any description of the spots, it is impossible to give you any useful information on the subject, however willing we may be to do so.

Melons and Cucumbers Unsatisfactory (*T. W. and C. H.*).—It is impossible to publish replies in the current issue that would be satisfactory either to ourselves or to correspondents to many letters that arrive on Wednesday morning; and, as in those under notice, answers have to be postponed until next week.

Fruit Seeds (*J. E.*).—The fruit is crushed and placed in water, the pulp being separated from the seeds as much as possible, and this and the bad seeds float, while the sound seeds fall to the bottom of the vessel when the water and residue are strained off. The length of time the fruit remains in the water depends entirely on the labour that is bestowed in separating the pulp from the seeds. Seeds of *Pernetia mucronata* are not poisonous to either man or birds.

Rainfall and Sunshine (*A Fifteen-years Subscriber*).—The Secretary of the Meteorological Society recommends as the best works for your purpose "Symons' British Rainfall," 5s. yearly, and the "Meteorological Record," 1s. quarterly, both published by E. Stanford, Charing Cross. We have yearly volumes of the former publication, and they include averages of rainfall during preceding years; and if, as there is little doubt, the other work gives averages of sunshine, a year's issue of the work would probably give you all the information you require.

Double Wallflowers Bearing Seed (*A. C. S.*).—You probably have some of the German strains, the flowers of which, though appearing full, are not so "double" that all the essential organs are obliterated. The pistil usually remains perfect; and an anther may be produced upon a petal or an ordinary stamen, as often occurs in flowers of this kind.

Holly Leaves Falling (*T. F. W., Deal*).—"Can you tell me the reason of some of our Holly trees dropping their leaves? They are fine trees and have always done well, but this year several of them have lost every leaf, and the stems are quite bare of leaves. They cannot be dead, as they have blossom on them." Not being able to answer your query to our own satisfaction we print it in case any of our readers can give information on the matter. We know, of course, that Hollies usually cast a number of leaves in the spring and early summer when new growth is being made; but it is a different thing for "several" of them to lose "all their leaves," and the difference, we suspect, can only be traced to some local circumstances. You afford us no data whatever for forming an opinion on the matter, but some of our readers may have had experience similar to your own, and have determined the cause of the defoliation. The plant of which you have sent a much-dried spray is, we think, *Lycium africanum*.

Orange Fungus on Roses (*W. H. W.*).—Your Roses are attacked by this unwelcome parasite. Sulphur is the orthodox remedy, and may either be dusted on the foliage when it is wet, or mixed in a solution of soft soap to the consistency of thin cream and applied with a syringe. It may remain on for a day or two and then be washed off. It will not injure the leaves, but will check the growth of the fungus if it does not destroy it; at the same time apply liquid manure copiously to the roots. A cleaner method of proceeding would be to apply Ewing's mildew composition through a spray-distributor. There is yet another method described in the "Gardener's Year-Book"—namely, sponge the leaves with 2 ozs. of blue vitriol (sulphate of copper) dissolved in hot water, and added to two gallons of cold water. Adopt whichever plan is most convenient, and if one fails try the other, but do not forget to afford the Roses adequate support at the roots.

Watering Gardens (*Nemo*).—By far the best time for watering flowers and outdoor crops generally in summer is the evening, as, if the water is applied in the morning, especially in bright weather, the sun will not only extract much of the moisture from the soil, but this cannot occur without a loss of heat also. It is on this account that daily sprinklings are worse than useless—dangerous. The most effectual method of applying water is to wait until it is really needed, and then give sufficient to penetrate quite below the roots, and the next morning as soon as the surface is sufficiently dry run the hoe through it to break the lines of evaporation. If this is not done the surface will shrink in drying and form innumerable fissures, through which both the moisture and warmth of the earth will be extracted by the sun. A loose and dusty surface is valuable for arresting evaporation and preserving moisture in the soil in hot dry weather. The hoe, therefore, should always follow the waterpot, and water that has been exposed to the air for some time is much better than that drawn from wells and used immediately.

Ghent Azalea Leaves Turning Brown (*C. D.*).—It is not unusual for the leaves to assume a brown or bronzy hue as the growth matures, and, provided there is no actual scorching, little or no injury is done to the plants. The

leaves you have sent are slightly scorched, and it is not unlikely that the plant at some time or other has been too dry at the roots. As it has not been repotted for a year the pot either is or ought to be crowded with roots, and very copious supplies of water, especially in bright weather, will be requisite for affording adequate support to the plant. The roots of Azaleas are very small, even hair-like in character, and if they are allowed to become quite dry for an hour they shrivel, and a check is given to the plants from which they do not soon recover. Probably the best plan will be to stand your plant in the open air, if possible behind a wall or building, not under trees, where it will be shaded from the sun from 10 A.M. to 4 P.M. for a month, then assign it a sunny position to ripen the growths. But the roots must be kept moist always, and to prevent the soil drying quickly the pot should either be plunged to its rim in ashes or soil, or sunk in a larger pot. If plunged in the soil let it stand on a smaller pot, so that worms will not have access to the roots of the plant.

Jasminum grandiflorum Unhealthy (*Idem*).—In all probability the plant was prepared in a house in which the atmosphere was less dry than that of your greenhouse, and the change in this respect to which the plant has been subjected would affect the colour of the leaves. It is not unlikely, too, that you erred in repotting the plant so soon. It ought at least to have been permitted to become acclimatised—inured to the change in its new quarters before suffering any disturbance of the roots. The practice of repotting plants as soon as they arrive from nurseries is not, generally speaking, a safe one. Some plants may need it, but the majority do not, and not a few are seriously injured by endeavouring to improve them so soon. It is not possible for any book to give precise information as to the exact time a plant should be potted. General rules and valuable hints are given in most practical works, such as the one to which you refer; but much necessarily depends on the judgment of the operator as to the time and manner of carrying out the instructions. The soil surrounding the roots of your plant may either have been too dry or too wet when the repotting was done, and there may have been some error in watering it since, as there has been, we suspect, in allowing it “plenty of air,” as this may have amounted to a draught or dry current, which with the bright sun that has prevailed has extracted the moisture from the leaves faster than it could be supplied by the disturbed and comparatively torpid roots. It is always a safe practice to keep a newly potted plant a little close for a time, syringing and shading it according to the state of the weather, to aid the roots to take possession of the fresh soil. Then, and not till then, allow “plenty of sun and air.” You had better syringe your plant twice a day at least, and shade it so long as the bright weather continues, and with judicious watering and removing the withered growths it will, we think, soon recover.

Diplacus glutinosus (*E. M.*).—The plant, of which a spray was sent, is not a *Pentstemon*, but *Diplacus glutinosus*, a useful member of the *Scrophularia* family, producing its orange-coloured flowers freely, and proving very serviceable in a conservatory. It is a native of California, whence it was introduced to this country about the year 1794, and is therefore quite an old inhabitant of English gardens, yet no other plant is so frequently sent to us for name as this. A compost of fibrous loam, peat, and sand, with a little well-decayed manure or leaf soil in place of the peat, suits it well, and the plant may be increased either by seeds or cuttings, the latter striking freely in sandy soil under a bellglass plunged in heat. *D. puniceus*, also from California, is a handsome form with scarlet flowers, and there are several other varieties differing in the colour of the flowers.

Dismissal of Gardener (*N.*).—We print the query in this case in order that our reply may be better understood and more generally useful to a large number of persons who are interested in the matter:—“Can a master legally demand a head gardener to leave his situation and turn out of his cottage in two weeks? The gardener is paid fortnightly. No charge whatever is brought against him as to honesty, sobriety, civility, or ability. The only complaint is that the garden is untidy.” In the absence of any special agreement to the contrary a master can dismiss a servant on giving him a week’s notice if he is paid weekly, a fortnight’s notice if he is paid fortnightly, a month’s notice if he is paid monthly, and so on, without assigning any reason whatever for doing so; and the gardener must also leave the cottage if it is a part of his wages and on the master’s premises, as is probably so in this case, or if the master pays rent for it off his premises. A gardener can also leave his situation and cottage on the same terms.

Disfigured Leaves on Damson (*J. W. M.*).—These have a crop of ex-resences or galls, two kinds of which occur upon various Plums in early summer. One kind is caused by the maggot of a minute fly of the *Cecidomyia* family, the other arises from a gall mite, an insect allied to the well-known red spider, but still smaller. Your tree appears to have been visited by the latter species, *Phytoptus Pruni*. We regret to state that no remedy has at present been discovered applicable to such cases. It has been conjectured that the gall mites only attack shrubs or trees already in an unhealthy state; but on this point opinions are not at all unanimous, and the specimens you sent appeared healthy. In the case of small bush and pyramid trees the foliage might be rendered distasteful to the insects by syringing with quassia water, but orchard standards could not be so conveniently treated.

Silicate of Potash (*J. E.*).—Your question is one that should be addressed to a chemical paper. Silicate of potash is very seldom, if ever, used as a manure, and so far as we know is not in the market as such. Cameron says that although it has been used in agriculture with a view to the strengthening of the straw, it is quite useless for that purpose. Silica is regarded as not essential as a plant-food, but it is supposed that it finds its way into the plant as silicate of potash. The potash is then used, and the silica deposited as a superfluity. Johnson says that when potash, soda, and silica are melted together a soluble glass is formed, and this he recommends. Much of the potash present in ordinary soil is in the form of the silicate. Some chemists have considered that this is rendered more available when hot lime is applied to the soil—the lime liberating the potash. If you intend applying silicate of potash sprinkle it over the surface and fork it in to where the roots can reach it. But when and under what conditions do you procure the compound?

Planting Vines (*W. M.*).—We are very willing to advise you, but there is one point on which we have no means of forming an opinion, and that is the nature and condition of the soil in the border. On this point you will act wisely by inviting some good Grape-grower to inspect it. Mr. Holmes, Sisters House, Clapham Common, is very competent and not far distant, and we feel sure would give you good advice. With the addition of bones the border might be made suitable; but if you have any doubt on the point, and can obtain good fresh loam, you would not err by using it. We prefer a border made in sections, a width of 3 feet being ample the first year, the front being formed with turves. The house you say will be ready in July. If our object were the production of a good supply of Grapes in the quickest time we should plant immediately the house is ready—that is, if we could obtain healthy free-growing Vines in a fresh

uninjured state. As the best way of insuring this we should procure stout young plants now in 7-inch pots, going to a nursery and selecting them. These should be, say, 4 feet high, and ready for shifting into 9-inch pots on arrival. If the Vines were larger we should not object, but the smaller they are the better they travel, and a small plant uninjured is better than a large one much damaged. By the time the house is ready the Vines would be ready for another shift, and this would be into the border, placing them there with the same care as if transferring to larger pots—that is, taking great care that the soil in the pots is sufficiently moist, and not disturbing the roots needlessly, the soil of the border to be also in a healthy state as to moisture. Planting two Vines 18 inches from the ends of the house there would be room for seven others a trifle more than 3 feet 6 inches apart. Lady Downe’s Seedling is probably the best late Grape, but if large bunches and berries are of especial importance you will find the Black Alicante and Gros Colman worth growing. The Muscat of Alexandria will succeed with these, but the fruit will not keep so long, yet one or two Vines of it ought to be included in your collection. The latest white Grape is, perhaps, the Trebbiano, which produces large bunches and medium-sized berries. You ask for well-proved Grapes that may be easily grown. Such we have named, and the number of each to plant can only be rightly determined by the particular requirements of your employer. If the chief object, as your letter appears to indicate, is the production of large bunches and berries, then the two varieties specially mentioned will be the most likely to afford them. The Muscat of Alexandria might probably succeed at the warm end of the second house; but as you do not state what varieties you grow there we are not able to say. If you plant Vines in the summer you must afford heat, moisture, and ventilation as if growing tender stove plants, increasing the ventilation and decreasing the moisture as the autumn approaches, but not materially decreasing the heat for ripening the wood. You would find two additional rows of pipes advantageous. In addition to the Vines named you may, of course, have supernumeraries, either planted out or fruited in pots, if Grapes are required next year.

Names of Plants (*T. O’G.*).—Your plant is not an *Arabis*, but *Aubrietia purpurea* or one of its varieties. (*Lorley*).—*Arrhenatherum avenaceum*, Knotted Oat Grass. The root is natural, but there is another form with simply fibrous roots. (*W. C.*).—1, *Saxifraga ceratophylla*, Stag’s-horn Saxifrage; 2, *Saxifraga hypnoides*, Mossy Cushion Saxifrage; 3, *Cherophyllum sylvestre*, Cow Parsley; 4, *Bunium flexuosum*, common Earth Nut; 5, *Stellaria holostea*, Hedge Stitchwort; 6, *Barbarea vulgaris*, Yellow Rocket, grown as a salad, and known in gardens as American Cress. (*Aurora*).—1, *Myosotis dissitiflora* (true); 2, *M. palustris*; 3, *M. sylvatica*. (*J. J., Lancashire*).—The *Odontoglossum Alexandræ* is fairly good, but not superior to many others in cultivation. The other *Odontoglossum* is *O. luteo-purpureum*, and the *Oncidium*, *O. unicolorne*. Your plant of *Utricularia montana* is fine, but we have seen others equally good or superior. (*H. C. M.*).—31, *Melica uniflora*, One-flowered Melic Grass; this is a pretty Grass, and useful for winter decoration; 32, *Luzula pilosa*, Little Hairy Wood Rush, intermixed with No. 31; 33, *Poa pratensis*, var. *subcærulea*, a bluish form of the common Meadow Grass; 34, *Carex sylvatica*, Wood Sedge; 35, *Anthoxanthum odoratum*, Sweet-scented Vernal Grass. (*R. L. K.*).—*Fuchsia procumbens*.

COVENT GARDEN MARKET.—JUNE 6TH.

A BRISK business doing during the week, all classes of goods being cleared readily, and prices well maintained.

FRUIT.		s. d. s. d.		
Apples.....	½ sieve	2 0 to 7 0	Grapes.....	lb. 3 0 to 6 0
”.....	per barrel	20 0 40 0	Lemons.....	case 10 0 20 0
Apricots.....	doz.	0 0 0 0	Nectarines.....	dozen 12 0 18 0
Cherries.....	½ sieve	0 0 0 0	Oranges.....	100 6 0 10 0
Chestnuts.....	bushel	10 0 12 0	Peaches.....	dozen 18 0 21 0
Currants, Black..	½ sieve	0 0 0 0	Pears, kitchen..	dozen 0 0 0 0
” Red.....	½ sieve	0 0 0 0	dessert.....	dozen 0 0 0 0
Figs.....	dozen	4 0 6 0	Pine Apples, English	lb. 4 0 5 0
Filberts.....	lb.	0 0 0 0	Raspberries.....	lb. 0 0 0 0
Cobs.....	100 lb.	0 0 0 0	Strawberries....	lb. 4 0 6 0
Gooseberries....	½ sieve	6 0 7 0		

VEGETABLES.		s. d. s. d.		
Artichokes.....	dozen	2 0 to 4 0	Mushrooms.....	punnet 1 0 to 1 6
Asparagus, English	bundle	3 0 6 0	Mustard & Cress..	punnet 0 2 0 3
Asparagus, French	bundle	2 0 8 0	Onions.....	bushel 2 6 3 6
Beans, Kidney....	100	2 0 0 0	Parsley.....	doz. bunches 3 0 4 0
Beet, Red.....	dozen	1 0 2 0	Parsnips.....	dozen 1 0 2 0
Broccoli.....	bundle	0 9 1 6	Peas.....	quart 3 6 0 0
Cabbage.....	dozen	0 6 1 0	Potatoes, New....	lb. 0 2 0 4
Capsicums.....	100	1 6 2 0	Potatoes.....	cwt. 6 0 10 0
Carrots.....	bunch	0 4 0 0	Kidney.....	cwt. 6 0 10 0
Cauliflowers.....	dozen	2 0 3 0	Radishes....	doz. bunches 1 0 0 0
Celery.....	bundle	1 6 2 0	Rhubarb.....	bundle 0 4 0 0
Coleworts.....	doz. bunches	2 0 4 0	Salsafy.....	bundle 1 0 0 0
Cucumbers.....	each	0 4 0 8	Scorzoneria.....	bundle 1 6 0 0
Endive.....	dozen	1 0 2 0	Seakale.....	basket 0 0 0 0
Fennel.....	bunch	0 3 0 0	Shallots.....	lb. 0 3 0 0
Herbs.....	bunch	0 2 0 0	Spinach.....	bnshel 2 6 3 0
Leeks.....	bunch	0 3 0 4	Tomatoes.....	lb. 1 0 1 6
Lettuces.....	score	1 0 1 6	Turnips.....	bunch 0 2 0 3



POULTRY AND PIGEON CHRONICLE.

HAY-SAVING BY MACHINERY.

(Continued from page 461.)

THE next machine to which we shall refer is an important one, not only for what can be accomplished by it as made and offered

for use at the present time, but also for the purposes to which it or some modification or improvement upon it may lead in the future. It is advertised as the Perpetual Press, and is an American invention, which was shown in its present form at Philadelphia in 1876. It was then described as Dederick's Hay Press, from the name of the patentee. It was exhibited by John H. Ladd & Co. of 116, Queen Victoria Street, London, at the Royal Agricultural Society of England meetings at Derby in 1881, and again at Reading in 1882. It is said to have been adopted by Her Majesty's Government for the War Department for the purposes of baling hay, straw, and fibres of all descriptions, and was awarded a special silver medal by the Royal Agricultural Society of England at the Derby meeting of 1881, and was shown in motion in the yard at the meetings of 1881 and 1882. It is variable in length, is mounted on wheels for travelling, and can be worked by either horse or steam power.

After taking particular notice of the above machine as illustrated in the Journal of the Royal Agricultural Society, we find that the hay is fed into a hopper by the attendant, and that at regular intervals, when the traverser is withdrawn, a fork or board descends and forces the hay or straw into a chamber below the hopper, where it is subject to the compressing action of a reciprocating traverser; it is then driven forward by the traverser. This combined action causes each section of the bale to be folded up and forced into the chamber, which is provided with steel springs, to retain all the hay forced beyond them and prevent expansion backwards when the traverser is withdrawn. The size of the chamber is 12 inches by 15 inches, and this, of course, regulates the dimensions of the bale, which can be made of any convenient length, although the usual size is 3 feet, by the insertion in the hopper of light wooden followers with slots on their surface, through which the wires are passed for tying the bale as it passes through the chamber. The wires of proper length being first prepared, an attendant below passes the wires through the slots in the followers, and brings them together on one side of the truss or bale with pincers. The liberation of the truss from the discharge end of the chamber by allowing some lineal expansion tightens the wires. The mouth is adjustable, so that by turning a nut the bale is released or held, thus forming light or heavy bales as required.

Two men are required to work the machine, the hay being supplied on to a platform. One feeds the machine, whilst the other attends to the wiring of the trusses or bales. The bale consists of a number of independent sections pressed closely together, so that when the ties are removed each section may be taken off without pulling the bale to pieces and without the waste inseparable from the distribution of a homogeneous mass, and this is a point of considerable importance. The sections can be piled up as so many blocks ready for use, or the bale can be placed on end and gradually reduced by the removal of consecutive sections. Considering the rapidity of the work there is very little waste. The Judges weighed a truss 12 inches by 15 inches by 36 inches, which scaled 1 cwt. 1 qr. 16 lbs., being about 42 lbs. to the cubic foot. The exhibitors, however, claim to, and probably could, compress 45 lbs. per cubic foot, which would allow 1 ton of hay to be packed within 1 ton measurement of 40 cubic feet. In a time test it was found that 3 feet 8 inches of hay was discharged in two minutes. As this weighed 191 lbs., and the work is continuous, it follows that the machine can bale about 2½ tons per hour. The Judges also considered that this machine has merit and utility for the following reasons:—The rapidity of execution and the small cost of manual attendance; the peculiar way in which the hay is passed in sections, the simple action of the pressure minimising the waste; and the advantage of rectangular form of truss for stowage as compared with cylindrical trusses.

In our idea it has yet to be decided to what extent, if any, such a machine may be applied to half-made hay, or even greener; but the opinion we find prevailing amongst men of experience and hay salesmen is that through its operation hay may be saved from the field in a greener and therefore more valuable condition for various purposes than when stacked and heated in the ordinary manner. It would be in a state well adapted for sale and transit, for an ordinary railway truck when properly packed will carry 8 tons with bales of the density of 45 lbs. per cubic foot. Again, it is extremely well adapted for packing on board ship, or in ordinary transit per waggon for delivery to towns and stations. Moreover, in ten hours from 15 to 20 tons can be baled in the field where it grew, and may be easily disposed of in a covered shed or Dutch hay barn or in an old-fashioned barn, either of which would save thatching; in fact, the hay being so closely compressed, would by excluding the air prevent heating. Again, the bales may be so piled as to secure some ventilation between them. One machine capable of pressing 2½ tons per hour could deal with a crop in the field as quickly as by ordinary stacking. The hands employed would be less in number, and when intended either for sale or for use on the home farm this method of saving the hay has all the appearance of a practical scheme. The wire rope or bands can be used over again until worn out. One more point in favour of the Perpetual Press is its useful application to the trussing or baling of straw, and especially when used for baling as the straw is leaving the threshing machine.

As our previous observations and quotations have referred almost exclusively to the application of machinery for the saving of hay, we must now, however, refer to details connected with getting the hay into such a condition as will warrant its being stacked with safety in the absence of machinery, and various other matters of protection against losses after being stacked. One of the points is whether it is gain or loss that the hay should be discoloured by heat in the rick, and also whether our present implements for tedding are injurious in any respect. In this matter it will be readily admitted that the tedding machine is so important in the saving of labour that it becomes an important question whether any objection can be raised against it to compare at all with the cost of labour saved in the making of meadow or pasture hay. Grass, when examined under a microscope, will be seen to be covered with a waxy matter on the stems, which Dr. Voelcker calls its "waterproof coat," which has been furnished by Nature for the protection and securing the nourishment or feeding value it contains. Under certain conditions, however, especially when the grasses are damp, if you ted it with the machine, which knocks and tosses it about with an energy in proportion to the supposed excellence of the machine, you will frequently rupture the best part of this covering, or injure it to some extent. Again, if after being subjected to this active process the hay is stacked without rain having fallen on it little or no harm may have been done; but in the event of rain falling upon the hay, you might just as well expect a man to stay out during a thunder shower without getting wet through, after having pulled off his macintosh and thrown it on the ground, as that the hay will not be seriously injured by the rain—much more so than if it had been carefully and gently turned with the fork instead of being teded by an improved machine. The home farmer knows by experience that grass lying untouched in the swathe, or having been carefully cocked or poked by laying each successive forkful one on the other of moderate dimensions, in either of these conditions, although subjected to a considerable fall of rain, yet it often makes good hay if allowed to remain undisturbed until the occurrence of fine weather, when it is eventually moved, and in consequence of the waterproof covering of the grass having been retained and unbroken. We must enter rather more into the realm of conjecture, as we have not so much assistance as may be required from actual experience to aid us in forming an opinion. The amount of water, however, contained in grass when cut for hay is probably about 70 per cent., or a little more; but it has been proved by analysis that hay when fit to carry without fear of over-heating has lost 50 per cent. of this moisture, and that 15 per cent. is the amount of moisture generally supposed to exist in well-made hay. It is certain that hay containing 38 per cent., as ascertained in an experiment by Dr. Voelcker, the stack heated so much that a great deal of it was reduced to carbon, and crumbled between the fingers.

(To be continued.)

WORK ON THE HOME FARM.

Horse Labour.—Preparation for the later crops of roots must be continued. The seeding for Swedish Turnips and Scotch hybrids should now be completed—the sooner the better, even in the earliest districts like the dry soils of the eastern and southern counties;

besides which there is not now so much necessity for sowing either white Swedes or late sowing for spring food for sheep, because Mangolds are now generally adopted for late feeding in connection with a change to Rye and the water meadows where available. We earnestly recommend sheep farmers to look more to Mangolds than they have hitherto done, because if Mangold roots are properly stored for the winter there need not be any late root-feeding of Swedes to hinder the sowing of Lent corn, which is frequently the case, and sometimes proves fatal to a profitable crop of Lent corn, and of Barley especially. It is true that after feeding late Swedes it is customary to sow common Turnips, and then follow with Wheat after feeding off the Turnips with sheep; but it must be remembered that two years' root crops bring a heavy charge against the rotation in rent, rates, and tithes. Where the land is strong the season has been very favourable for operations on the land, whether it is cultivated as a naked fallow or sown with Mustard or other green crops for ploughing in. If the soil is light and sandy, the succession of green crops ploughed in will not destroy the white-rooted couch, although it will the twitch or water grass, which runs and roots on the surface almost entirely; therefore, upon any land green crops ploughed in may be adopted as the best plan for cleaning the land and manuring it at the same time; and this is a most desirable and beneficial mode of management upon outlying fields and farthest away from the farm-yard. It is most beneficial under any circumstances to drill 2 or 3 cwt. of bone superphosphate with any of our root crops if the land is ever so high in condition, because it is one of the securities in favour of obtaining a full plant of roots by driving them out of the way or reach of the numerous enemies in their first leaves and early growth. Horse-hoeing must now be followed up every day where the roots like Mangold, Carrots, &c., are forward enough. The Potatoes, Beans, and Peas, also should be horse-hoed, and where lumps of couch are seen they should be forked out by women before the horse-hoeing is done. For horse-hoeing a good substitute is the use of a mule or quick-stepping ox, for either of these where accustomed to the work do not tread on the plants so much as horses, especially heavy cart-horses.

Hand Labour.—Hand-hoeing the Potatoes, Beans, Peas, Mangolds, Carrots, Cabbages, and Kohl-Rabi must now be proceeded with, also thin Wheat where drilled at 10 or 12 inches between the rows. Lent corn also where drilled wide enough. We have seen much Charlock in some fields. The plan is for men to hoe (or else horses) between the rows, and women to hand-pull in the rows. The weeding machine drawn by a horse will pull the Charlock capitally without injury to the corn, if done at the right time; in fact, hand labour, especially by women, in some districts is so scarce, that machine-weeding has become a necessity in various emergencies. In wet or showery weather some men may now be employed in drawing straw and piling it in readiness for thatching the hayricks. This saves labour at the busiest times either in hay time or harvest. The sites for ricks, too, should be fixed and decided on, so that the brushwood bays, &c., may be carted to the spot, when the horses may be driven off the fallow lands by showery weather.

Live Stock.—The lambs must now be weaned on the hill farms, and it is best to take the ewes away from the lambs and feed them out of hearing of each other; besides which if the lambs are left in the field or fields to which they have been lately accustomed, they will not be so likely to become dissatisfied or break fold and fence as when they are taken from the ewes and driven to a strange field. The dairy cows are now for the most part in full milk, and as the grass on the arable land is abundant, as well as the green fodder crops, the cows will pay better to have a bait of green fodder at milking time both night and morning, either of Vetches, Trifolium and Rye, but especially is this desirable in cases where pastures are fed bare or their run circumscribed, with but little change of fields. The oxen and steers will now be turned out entirely on the best grazing farms, and in some cases they will pay for a little cake meal given with a small quantity of cut Mangolds mixed in the troughs to prevent waste. The herdsman, too, should take care to turn the trough upside down when the roots and cake is eaten, which is not many minutes about where the animals are accustomed to it. The working oxen and farm-horses should all be fed at the stables and houses or sheds. An old barn makes excellent accommodation for working bullocks. We advocate that the oxen should be kept under cover as well as the horses, and fed at the rack, it being a manure question sometimes, not with the same food exactly, but at the same expense or cost, and by this means not nearly so many will be required as when four or six are put to one plough, for really upstanding Hereford or Sussex cattle if well kept will nearly go the pace of some horses. We know farms, where kept in the liberal manner we have named, only two oxen are put to one plough in ordinary summer fallow work, and do nearly as much in a day as some horses. For we think that with four or more animals to the plough they impede each other in some cases.

CRYSTAL PALACE GOAT SHOW.

THE Exhibition of Goats held last week at the Crystal Palace under the auspices of the British Goat Society, gave evident proof of the progress that has been made in Goat culture since the last Show of this kind held there in 1876. The class for males with horns was

probably the best yet seen, the first prizewinner being a large Dutch specimen with a good head and horns, and the second a fine, upstanding, young English "Billy" of two years, which has yet to grow and develop in size. The she Goats were divided into long-haired and short-haired, horned and hornless. Amongst the first the most remarkable was an imported Pyrenean, with long upright horns, the largest she Goat probably ever introduced into this country. It won first prize without any difficulty, and created so much admiration that the owner was repeatedly offered high prices to induce him to part with it, refusing on one occasion £20. Some fine specimens were exhibited in the Champion and Hornless classes by the Baroness Burdett Coutts, which took prizes in each case. By the side of these were some handsome little kids, a cross between their English and Nubian dams and an Angora sire, highly commended in the male class. These kids, which are quite white, show the lop ears of the Angora, but do not as yet exhibit the curly coat of the Mohair breed. Some curious young animals were shown, which took respectively second and third prizes. These were a pair of imported Nubians, jet black, with wavy coats, long silky pendulous ears, and Roman noses. As many of the best milkers that have been exhibited are crossed with this variety, the introduction of these, the first pure specimens of the kind, may be hailed with satisfaction. The Rev. Rees Mogg showed also some curious animals bred from Indian parents, which were not, however, prizewinners. There were three prizes offered for the best milkers, but only four Goats were entered for this competition. The first prize was won by the Pyrenean Goat shown by Mr. E. Dormer of 74, Grosvenor Mews, which gave 5 lbs. 14 ozs. in two milkings. The second-prize was an Irish Goat, exhibited by Mr. H. S. Holmes Pegler, which was also second in her class, and gave 3 lbs. 12 ozs. The third-prize was a cross-bred English and Abyssinian, a little Goat, with a beautifully shaped udder, that gave 3 lbs. 4 ozs. The total number of Goats exhibited was seventy-nine.

OUR LETTER BOX.

Clotted Cream (R. R. G.).—It may be made as follows:—Take four quarts of new milk fresh from the cow, put it in a broad earthen pan, and let it stand till the next day; then put it over a very slow fire for half an hour, make it nearly hot to cream, then put it away till it is cold, take the cream off, and beat it smoothly with a spoon. A method of making cream cheese was published on page 462, last week.

Food for Cattle (W. R. S.).—The following from an article in these pages upon the above subject (June 3rd, 1880) will probably answer your purpose:—Many experiments have been made with the view of ascertaining the amount of food required to produce a certain quantity of fat; but although nothing like definite results has been obtained, it has, however, been shown that 150 lbs. of Swedes given in the open air produced 1 lb. of mutton, the same result being produced respectively by 100 lbs. of Swedes given under cover of a shed, 12 lbs. of good clover hay, 8 lbs. of beans, 5 lbs. of peas, or 6 lbs. of linseed cake, and 4½ lbs. of cake and peas or beans combined. Experiments have also shown that it is impossible to fatten any animal on linseed cake, or profitably on dry food alone as a rule. Mr. Lawes tried to do so, and the results were decidedly unfortunate, even when combined with chaff. All experiments, however, point to the fact that a mixture of linseed cake and peas or beans have produced the most profitable results. In some instances barley and oats have produced greater results than beans, but that depended upon the condition of the animal, beans and cake containing something like double the quantity of nitrogen or albumen, the flesh-making properties of food, as compared with barley or oats; therefore, when an animal was in an advanced stage of fatness food containing a less proportion of albumen would suffice.

METEOROLOGICAL OBSERVATIONS.

CAMDEN SQUARE, LONDON.

Lat. 51° 32' 40" N.; Long. 0° 8' 0" W.; Altitude, 111 feet.

DATE.	9 A.M.					IN THE DAY.				Rain
	Barometer at sea level	Hygrometer.		Direction of Wind.	Temp. of Soil at 1 foot.	Shade Temperature.		Radiation Temperature.		
		Dry.	Wet.			Max.	Min.	In sun.	On grass.	
1883.										
May.										
June.										
Sun. 27	29.963	55.5	53.8	N.E.	56.5	65.3	47.8	98.4	45.0	—
Mon. 28	30.075	59.7	53.6		55.4	69.0	42.7	113.5	38.4	—
Tues. 29	30.026	63.6	53.7	S.E.	56.2	70.6	49.6	121.6	45.7	—
Wed. 30	30.207	57.7	51.3	N.W.	56.3	70.6	47.2	121.0	43.9	—
Thurs. 31	30.247	55.6	51.7	N.	56.6	71.7	44.9	118.4	40.0	—
Friday 1	30.058	61.4	53.9	E.	55.8	72.6	43.7	115.0	38.0	—
Satur. 2	30.107	65.3	58.1	N.W.	57.2	75.8	48.0	121.1	42.3	—
	30.098	60.3	54.1		55.4	70.8	46.3	115.6	41.9	—

REMARKS.

27th.—Dull morning, fine afternoon, and evening very calm.
 28th.—Fine and bright, cool wind.
 29th.—Fine generally, very calm, overcast at times.
 30th.—Fair, with a good deal of fog or smoke to the S.E.
 31st.—Hazy and dull in morning, afterwards fine and bright.
 1st.—Fine, bright, and calm.
 2nd.—Fine and warm.

A very fine week, not quite as warm as the previous one, but still above the average.—G. J. SYMONS.



14th	TH	South Essex Show, Leyton.
15th	F	York Floral Fête (last day).
16th	S	
17th	SUN	4TH SUNDAY AFTER TRINITY.
18th	M	
19th	TU	Leeds Show (two days). Worcester (three days).
20th	W	

THE ART OF KEEPING THE SOIL MOIST.

IT is not so much how to make dry soil wet as to consider how best to counteract excessive heat and drought that is the purpose in view. The weather is dry now. If rain falls before these notes are printed so much the better; it will do more good than all the papers, still the art of keeping the soil moist should be learned by all cultivators.

In hot seasons heavy land suffers least from drought, but unless the soil of such is very thoroughly pulverised it is certain to crack deeply and shrink into compact blocks, which first prevent tender rootlets travelling, and secondly become parched lumps. When well pulverised, however, and when the subsoil is damp, heat and drought only make the plants thrive the faster. As clay soils which are dug in autumn and early winter are in most districts pretty solid by spring, unless thorough forking is done, drought soon proves disastrous. Dug in spring and broken up then drought tells but lightly or not at all.

It is exactly the opposite with light sandy or gravelly soils. It is working much mischief to fork or dig these uprightly in spring or early summer, for they are thus prevented from exercising that capillary attraction which draws water from below and maintains a steady moisture when such soils have become somewhat firm by lying long or by being artificially firmed. Those who advise a liberal use of the fork will find it quite right on heavy soils which naturally become compact; but those who on gravelly or sandy soil take such advice will find that "someone has blundered," for it will be found that it would be as hopeful to water the Sahara as to moisten such soil.

While the mechanical condition of the soil has much to do with its moistness or dryness, it not unfrequently happens that plants apparently suffer from want of water, when in fact it is nitrogen that is wanting. A week ago the writer met a farmer bemoaning the want of rain. His hay crop was a failure, apparently with drought. Over the fence was the finest crop ever seen, and the owner of that other field was hoping "we wadna hae rain, it wad lay the hey." The first field was suffering from starvation, the second had been, if anything, overfed by liquid manure from the farmyard. Garden crops take up much nitrogen; usually the manure is not over-rich in that, and bad treatment makes it worse. Those who are suffering "from drought" might do worse than use a little sulphate of ammonia or nitrate of soda next time watering

is done. In nine cases out of ten it will be found to almost do instead of water.

At present those who have summer beds to fill and winter vegetables in want of planting will not be in an easy frame of mind. When there is water in abundance laid on in pipes and applied with a hose matters are all right; but those who have to carry it in cans, even though it is plentiful, are to be pitied, for such work is comparable to that of Mrs. Partington's when she tried to keep back the tide with a mop. If anything we can say could induce owners to lay on plenty of water and hose for applying it we would say it earnestly, for they are mis-spending money if they are paying for carrying water, when it would a thousand times more effectually run itself.

When planting must be done in dry weather and watering appliances ineffectual it is more than half the battle to have strong plants with a mass of earth and manure adhering to their roots. Plants put in deeply, planted firm with the dry soil, a little cup-shaped basin left round each to be filled with water, and after that soaks away with soil will not suffer for a long time, for the loose earth will be the means of preventing the water escaping into the air. On a large scale, such as the planting of Cabbages, it will be found a good plan to draw a deep furrow in which to insert the plants (from beds where they were pricked-out previously among half loam, half manure) without the loss of a fibre if possible, and then to fill each furrow with water. The evening is the best time to do this. In the morning dry soil should be made to cover the moist surface to prevent evaporation. No matter how fierce the heat, we have never found plants so treated suffer, and when in a week the roots have pushed it has been found of incalculable advantage to give each a little liquid manure.

Strawberry beds are most likely to suffer in hot weather. If so the surface should be deeply hoed, nitrate of soda sprinkled between the rows, and not a sprinkling but a flooding of water given. If the beds have been mulched with ordinary manure some time before, they are not so likely to suffer; if not, a good mulching should be given as speedily as possible. Long grass is as good as anything, short chaffy lawn grass the very worst. Tan is very good, as it keeps the fruit clean, does not prevent water descending, but keeps it from ascending, and after one good washing is very clean.

In the vegetable quarters nothing will keep the soil moist equal to a good coating of partly decayed manure, and often manure so applied is much more effective than when dug-in in the usual manner. Machine grass between the rows of Cabbages is very effective, a very little thoroughly protecting the soil.

In beds and borders leaf soil is of incalculable advantage applied an inch thick over the surface. Soil moistened now and so protected will enable the plants to grow luxuriantly without further watering for a long time. After the surface is covered with vegetation and the roots have burrowed 18 inches drought is not likely to do more than to cause a denser inflorescence. Cocoa-nut fibre is even better still, though hardly so neat, but the luxuriance following its use speedily puts the fibre out of sight though not of usefulness.

Even common soil makes a good mulch. Wrong though it be to turn the body of the soil into a loose mass, it is of great benefit to have an inch or so of loose

soil on the surface. For this reason the soil should be thoroughly hoed, and that repeatedly, especially after watering.

The watering-can in inexperienced hands is a source of much mischief. It looks so nice in the stilly evening to have the surface of the ground all dark with damp, that the temptation to sprinkle is too much for many. Either a soaking that will penetrate a foot at least or nothing should be given. Then the surface should be stirred as soon as dry enough, unless otherwise protected by mulching. Dribbling the surface is worse than drought. It robs the soil of heat and stops the growth of the plant. It entices the roots to the surface only to be killed.

When water is applied it is of much service to have it exposed some time previously to the sun and air. Pond or river water is undoubtedly best, but many places are supplied by springs and deep wells. Such water is always cold, and when applied cold it gives a severe check. Soft water is known to be best, and exposure not only warms but softens it. When tanks cannot be provided for this purpose it would pay to pass the water through an ordinary heating boiler, under which burnt a good fire, especially when the water is to be applied to Vine or Peach borders. In the case of Melons, the cans if stood in the house or frame will enable the water to attain a suitable temperature in an hour or two.

When the soil is moist, or made so and kept so, plants use the food at their disposal rapidly, and in the sunshine turn the feeding to good purpose. In dull wet weather richness does mischief often. In hot weather it is turned to riches. In gloomy years plant food plentifully applied runs into a plenitude of shoots and leaves. When the sun is out it is turned to fruit for this year, and fruit buds for next. For this reason it is good to help flagging trees now, not only with water, but water with "a cinder in it." Stable drainage, sewage, guano water, nitrate or ammonia salts applied to fruit trees and bushes now will well repay in due season.

In applying water to fruit trees it is well to remove an inch or so of soil and to form a basin rim with it; then fork another inch, and flood with liquid manure the plants needing assistance. Afterwards return the removed soil, it will act as a mulch; or, better, mulch thickly with manure.

Under the hot sun and drying winds fruit trees under glass evaporate with extreme rapidity. It is well to remember that the harder the pump-handle is plied the sooner the well goes dry; and it may be worth mention that soils which furnish food in abundance are not so much "drawn on" as others. Feed a man on rice or Potatoes and he must consume large quantities. Feed plants on water with hardly traces of the food they want, and they will try to make up for it by passing greater quantities through their system. This fact accounts for the chronic drought from which starved fields suffer.

In battling with heat and drought, then, we should aim at securing that texture of soil which best favours retention of water and maintains the greatest capillary power. To soak thoroughly and avoid dribbling; to have as strong plants to put out as possible, to injure none of their roots in the process, and to apply the water under the surface; to mulch whenever practicable, and with the best material at command, be it only loose

earth; to seize such opportunities for administering food when possible, and to remember that often enough it is not so much water as nitrogen that is wanted, as well as, perhaps, other food; and last, not least, that under a bright sun plants work rapidly, maturing the present crop and storing matter, if properly fed, for the crops of the future.—SINGLE-HANDED.

CULTURE OF KALOSANTHES COCCINEA.

TAKING into consideration all the good qualities possessed by this beautiful sweet-scented greenhouse plant, it is surprising that it is not more frequently met with in a condition creditable to the cultivator. Under good cultivation its habit is close and compact, producing a profusion of bright flowers which contrasts well with the deep green foliage. Although it is of too stiff a character to be useful for cutting (an indispensable quality with many) still, when it is grouped with other plants in the conservatory, or associated with Ferns and foliage plants for house decoration, it is generally admired.

The ease with which it is propagated, the short time required to grow it to a serviceable size, and its comparative immunity from the attacks of insects, ought to commend it to every gardener who has a conservatory to furnish or a house to decorate. In the general rage for "something new," old plants are too apt to be thrust aside and get but little attention, and so gradually creep into disrepute; and when such is the case it takes some little effort to again bring them into popular favour. Allow me to contribute my mite towards rescuing this beautiful old-fashioned plant from the depths of the "neglected list." In doing so I shall only be seconding the efforts of your correspondent "A. Y." in your issue of April 5th, page 282, who has anticipated my note on this subject, and with whose cultural directions I generally agree.

Propagation.—This is too often recommended to be done in August. It roots freely at any season, but I think the best time is from the middle of March to the middle of May, or as soon as convenient after the bloom is visible in the tips of the shoots. Select shoots that have failed to bloom and take them off close to the old wood. Trim a few of the bottom leaves off and insert them singly into thumb pots, or five into a large 60. Use a mixture of fibry loam and peat, or loam and leaf soil, with a good dash of sharp sand. Water well, and place in a warm moist atmosphere for about three weeks, when they will be rooted sufficiently to be removed to cooler quarters—a shelf near the glass in a greenhouse or Peach house, where they may remain till they fill their pots with roots.

Summer Treatment.—About the beginning of June the young plants should be shifted into a size larger pots, the single plants into 4½-inch, and those with five cuttings into 5-inch pots, using the same compost, but in a rougher state, and with less sand in it. Drain the pots well, and place a little moss over the crocks to keep them clear of soil. The plants may then be placed in a close frame till they have well rooted into the fresh soil, then gradually harden off. After this our practice is to plunge them out in coal ashes, giving them exactly the same treatment as winter-flowering Pelargoniums. Those, however, who have a very heavy rainfall to contend with should have them in frames, or a sash placed over them to throw off the heavy showers, exposing fully in dry weather. As soon as required each plant should have a small stick to it, to keep it upright and prevent its being broken.

Most writers on the Kalosanthes recommend the young shoots to be pinched. I have proved this to be quite unnecessary; in fact it tends to make a rather stiff plant, more formal than it would be if left to its natural growth. Allow the plants that have been potted singly to grow without stopping. Those intended for larger plants, the four plants round the outside of the pot may be stopped early in July, but train the centre plant to a stick without stopping. They will thus produce free natural pyramids, clothed with flowers to the edge of the pots.

Excepting that they should be carefully watered, but little attention is necessary till they are housed for the winter at the end of September or beginning of October. They should then

be placed on shelves near the glass, where they will be cool and have plenty of air. They will continue growing, and should by no means be stinted for water, as is advised by some writers. Of course as the days shorten less water is required as a natural consequence, but this does not mean that the soil is to be allowed to get dry, for the roots are very active during the autumn months, and should be encouraged. Soon after the turn of the year—say the middle of January—the plants should be shifted into their blooming pots. The single plants may be potted into 5 or 6-inch pots, and the others into 7 or 8-inch. If they can be placed for about ten days in a moist atmosphere—an early vinery or Peach house—it will be an advantage to them. The plants make rapid progress during February and March. They should be regularly attended to with water, and when the pots are well filled with roots should be assisted with a little weak liquid manure twice a week.

By the end of the latter month the plants will be showing blooms, when they must be staked and tied. Stakes should be used as sparingly as possible. One or two to each plant is generally sufficient, the other shoots being looped together for support, something after the style of tying *Phœnocomas* and hardwooded *Heaths* for exhibition. Keep the plants as close to the glass as possible till they come into bloom. They will be cooler and require less labour in watering if turned out into frames or cold pits early in May, from which they can be transferred to the conservatory as they come into bloom.

Old Plants.—These are generally considered useless as far as blooming the following season is concerned. One plant last year bloomed so freely that we had a difficulty in getting sufficient for this year's stock. I was thus induced to save a few old plants to furnish cuttings. These were allowed to become dry at the roots, cut hard back, and after giving the wounds time to heal to prevent bleeding, were placed in a brisk heat. They were afterwards placed outdoors with the others and had the same treatment, except that they were shifted when they were housed for the winter into pots a size larger. These have furnished us with abundance of cuttings, and—more than we expected—a fair sprinkling of bloom.

The *Kalosanthes* is hardier than some of our bedding plants. Some of the above-mentioned plants were outdoors in the open till the 12th of November, and endured 3° of frost without showing the least signs of having been injured. It is, in fact, one of those plants that may very easily be "killed with kindness."—R. INGLIS.

P.S.—Since writing the above I have thought of sending you a small plant to show you that *Kalosanthes* make useful little plants in twelve months without pinching, as I have recommended. The plant has not been shifted since July last, which accounts for its rather rusty foliage—the pot, a 5-inch, being altogether too small for the size of the plant. It shows, however, that they can be grown in pots of a convenient size for fitting into vases for house decoration, and that they are less stiff when not pinched. A friend informs me that he places his plants in saucers of water, which they seem to enjoy when root-bound.—R. I.

[The plant in question is a handsome little pyramid. It is in a 5-inch pot, 19 inches high from the surface of the soil, 21 inches in diameter at the base, bears twenty-four trusses of very bright flowers, and has been admirably grown.]

SCIENCE IN CULTIVATION.

FARMYARD manure in combination with artificial manure is the best form of fertiliser for all crops—best for its economy, its certainty, and its decided superiority to either farmyard manure or artificial manure alone. This is the clear and unmistakable teaching of recent experiments, marking an era in the progress of scientific cultivation, the importance of which can hardly be over-estimated, for the remarkable results attending its intelligent application upon the land points to a bright future both to the market gardener and farmer. In this sense it is of national importance, and must eventually be turned to account for the benefit of all. Market gardeners will probably be first to avail themselves of it, for their wits are sharpened by high rents and frequent contact with keen men of business; but farmers are slower generally to adopt

new ideas, persistently following tracks beaten hard and wide by their forefathers, down which many an honest man has recently gone to bankruptcy. But it is not the seasons alone, neither is it the soil, but its cultivators that are often at fault. Ville's assertion that the portion of fertility which human industry has to furnish to the earth is not more than 3 per cent., though not quite correct, is sufficiently so to show how simple, sure, and easy our work is under the guiding hand of science. Here let me say, that while conceding that the French chemist's book is very French in its general tone, yet it is undoubtedly worth careful perusal, for apart from any little puffs of national vanity, there is much good sense and careful reasoning, affording ample matter for thought, and much that may usefully be compared with the deductions of our own and German chemists.

By farmyard manure is meant all that gardeners generally obtain from pigstye, cowshed, or stable. The trials of manure by the Sussex Association for the Improvement of Agriculture by Science in the hot dry summer of 1881 affords some remarkable results, one of which was the decided superiority of the crop when artificial manure was accompanied with farmyard manure. According to Professor Jamieson, this was owing in a considerable degree to the fact that 20 tons of farmyard manure contain 16 tons of water—no unimportant matter in a dry season. Twenty tons of farmyard manure contain over 3 tons of organic matter, which, besides retaining moisture, affords protection and space congenial to the growth of tender root fibrils, and what is of even greater importance generally, is that farmyard manure contains all the ingredients essential to plants, and notably it contains potash and sulphate, both indispensable to the successful culture of root crops, and both of which one of the trial plots proved deficient in, notwithstanding Ville's sweeping assertion that all soil contains a superabundance of sulphur.

Some years ago there was a discussion in the pages of the Journal as to the most suitable condition of farmyard manure when applied to the land, and it was strongly asserted that undecayed manure was best, or, at any rate, that it contained the same elements of fertility as decayed manure, and might therefore be placed upon the land at any time with greater facility and less expense. This teaching, though not decidedly erroneous, was certainly loose and faulty. Wherever practicable, it is better to retain the manure in large heaps till spring, and then to apply it to the soil when it is in course of preparation for cropping. For example, in the culture of field Potatoes, which usually follow Oats, the land is cleared of stubble and weeds as soon as possible after harvest, and is then ploughed and so left for the winter. In spring, as soon as the land is dry enough to bear carts, the manure is carted upon it at the rate of thirty single horse cartloads per acre, which is probably equivalent to 20 tons. It is at once spread and ploughed in somewhat deeply, and when the newly ploughed soil is sufficiently dry—which is sometimes not till April—it is stirred lightly by a horse hoe and harrows, the drills drawn, and artificial manure scattered thickly along them at the rate of 4 cwt. per acre. The Potatoes are then put in the drills and the soil drawn over them, so that they may be said to be enveloped in artificial manure, much of which, however, inevitably falls upon the entire surface as it is scattered, and so comes to be tolerably well mixed with the soil by the time the roots make way through it. By way of experiment I have reversed this method for Mangold Wurtzel this year, sowing the artificial manure broadcast over the surface before the soil was stirred, afterwards making deep furrows in which farmyard manure was put, the soil turned back upon it, pressed, drilled, and the seed sown immediately above it; but in no case is manure of any kind put upon the land till spring.

Apart from all commercial considerations, this is a matter of importance to all owners of gardens, and it is hoped that good service will be done both to gardeners and their employers by calling particular attention to it. But too often many an earnest willing worker spends his strength in vain efforts to produce good crops with an insufficient supply of manure. Let me assure the employers of such good men and true that they would be well repaid for a moderate judicious outlay upon artificial manure to add to that obtained from the animals

upon the place. This is one of the things that "puts heart" into a man, and proud will that privileged gardener be when he points to the marvellous effects of the "patent enlivener," and boasts of the liberality and consideration of his employer, by means of which his labours have been crowned with success.

The present time is a good one for the application of artificial manure to garden crops. Sown broadcast over beds of Lettuces, Cabbages, Cauliflowers, Onions, and similar crops, it is soon worked into the surface by the frequent hoeing which is now indispensable to keep down weeds, and its beneficial effect is soon apparent, not only in accelerated sturdy growth, but also in the deepening hue of the foliage. Fruit and flowers, too, all thrive upon it, and to all beds and borders if applied as surface dressings very little time is required for the work, and good results are inevitable. Due care must, however, be taken not to overdo it. I have known plants stripped of foliage, and the growth of Grape Vines crippled, by an overdose of guano. This is both foolish and wasteful, and easily avoided by the exercise of caution at first. Watchfulness and care soon show one the way, and while it is good to seek advice, it is still better to try and prove all things.—EDWARD LUCKHURST.

STRIKING YOUNG GROWTHS OF VINES.

THE CORRECTOR-GENERAL OF GARDENERS.

AFTER my statement of a fact on page 402 as to the above method of propagating Vines which I saw practised in a nursery, I was not surprised to find myself again honoured with attention in another medium; but I confess I was not a little astonished that a writer who has constituted himself the corrector-general of gardeners should proclaim his want of knowledge of the process alluded to. As a fact *per se* needs no defence, and as I not only know that this mode of propagation has been practised in at least two nurseries, but have struck young growths myself, I did not intend making any reference to my critic, notwithstanding the receipt of one or two letters suggesting I should do so; but one now to hand is rather too good for the waste-paper basket, and I am tempted to request its publication in the hope that it will supply the official with a theme for another "note." The letter is as follows:—

"I think you ought to be grateful to the 'corrector' for advertising the Journal—his way, presumably, of announcing that he cannot find anything worth noticing in the other papers, though you will scarcely concur in the soundness of his judgment on that matter. On the question of Vine propagation, a seedling Vine was raised by a lady in a southern county; her husband grew and fruited it, and the fruit was pronounced very good. A north countryman (not a Scotchman), not unknown in the Grape-growing world, made a special journey to see this Grape. 'Oh,' says he, 'you had better let me have a cane of this to plant out and grow it properly; I am better up to it than you, and my Grapes will sell your Vines.' The very next season the northerner had 600 plants of this variety for sale, and a march was stolen on the honest southerner. Now, as the 'corrector' has seen and examined many new young Vines sent out by the trade and by raisers, but never yet came on one not raised from a hardwooded eye, here is another nice little piece of arithmetic for him to work out—viz., How long was the cane which travelled northwards?"

If this does not please my gentle critic I am at a loss to know what will; and if he cannot "do the sum" I fear he will have to take a lower place in the class, even if he does not run the risk of some ardent reformer voting him "unfit for the high office" he has appropriated—a vote that would certainly *not* be seconded by—J. WRIGHT.

NEW AURICULAS.

THE following is a descriptive list of varieties raised by my esteemed friend, the late Mr. Thomas Woodhead. These named only form a tithe of what he raised from seed. Owing to Miss Woodhead having to remove the plants late in the season, the potting was not completed until October. Still, although so late in potting, many of the seedlings produced good flowers—indeed, much better results than I expected. It being very probable that in the coming season the plants will be better situated for having the attention paid to them that they require than was the case last year, I expect to see a remarkably fine display next spring.

When Mr. Woodhead commenced crossing he made it his rule to only use first-class varieties for parents, more particularly

for seed-bearing—flowers having golden tubes, solid pastes, body colours not given to sporting, with smooth edges. The result thus far has justified the course he adopted, and has produced the following varieties:—

Maebeth.—Green edge, very large. Tube rich deep yellow. Paste solid and dense. Body colour black and smooth, not given to spread. Edge a fine green and perfectly smooth.

Shakespeare.—Green edge, very fine. Colour pale pea green. Tube circular, and deep rich yellow. Body colour dense and black. A very superior flower, to which the paleness of the green gives a peculiar charm.

Robin Adair.—Green edge; a deep glossy flower. Tube rich deep yellow. Paste very fine and smooth. Body colour intensely black and solid.

Adam Bede.—Green edge, raised from grey parents. Tube a deep yellow, with the anthers gathered together. Paste solid and good. Body colour black, the edge smooth and very fine.

John Wilson.—Green edge. Tube like Col. Taylor. Paste dense and circular. Body colour black, shading off to a blue-purple. Solid and firmly cut. Edge pale pea green and perfectly smooth.

Thomas Woodhead.—Green edge, a seedling from Prince of Wales and Prince of Greens. Tube rich deep yellow, closed at the top. Paste very fine. Body colour an Indian black, dense and solid. Edge smooth, and the green very fine. A flower which lasts a long time.

Mary Ann.—Green edge. Tube rich deep yellow. Paste solid and fine. Body colour black, solid, and clean. Edge smooth, extra fine.

Thomas Bower.—Grey edge. Rich golden tube. Paste solid and smooth. Body colour black. Edge circular, a dense grey.

George Rudd.—Grey edge. Tube rich golden yellow. Paste smooth and fine. Body colour black, the edge perfectly smooth. An immense flower, with a fine truss.

Mrs. Dodwell.—White edge; first-class certificate at National Show at South Kensington, 1882. This variety still maintains its promise of being one of the best white edges in cultivation. Tube golden yellow. Paste solid and fine. Body colour black and solid, and continues a long time in flower. One of the best white edges I have ever seen.

Mrs. Bower.—White edge. Tube a deep yellow. Paste solid and smooth. Body colour black. Edge good and smooth. A very desirable flower.

Rachel.—White edge; extra fine. Tube deep rich yellow. Paste dense and solid. Body colour black. Edge smooth and good, like a white George Lightbody, from which it is raised. A grand large flower.

Miss Woodhead.—White edge; an improved edition of Summer-seales' Catherina, being larger and finer. Tube deep yellow. Paste white and dense. Body colour black. One of the finest proportioned flowers I have seen; always constant and good.

Neat and Clean.—Self. Rich yellow tube. Paste wide and solid. Body colour rich maroon. A large flower, with all good properties.

Miss Black.—Self. Tube deep yellow. Paste solid. Body colour maroon. Edge perfectly smooth.

Fairy Queen.—Self. Tube pale yellow. Paste solid. Body colour crimson-maroon. A fine variety.

Bonnie Jane.—Self. Tube rich yellow. Paste dense and large. Body colour deep rich purple. Very fine.

Col. Aekroyd.—Self. Tube golden yellow. Paste solid and large. Body colour deep rich crimson. Edge perfectly smooth. A great advance on either Duke of Argyle or Marquis of Lorne.

Alice Grey.—Self. Deep rich purple, nearly black. Tube golden yellow. Paste dense, large, and circular. A splendid flower.

Mrs. Rawson.—Self. Tube deep yellow. Paste large and fine. Body colour deep purple, rich and glossy. Pips very large, and plenty of them. Altogether an extra fine flower.—GEO. RUDD.

DESTROYING GRUBS.

WITH summer suns the flies come, and after the flies follow caterpillars and grubs on boughs and at the roots. In some districts a friend of the bluebottle provides for its voracious progeny by laying its eggs at the roots of the Cabbage tribe. Delicate in its taste it is, for it very much prefers the delicate Cauliflowers, and thus they are frequently destroyed. Happily its organ of smell is also delicate, and a weak manuring of cow urine not only starts the plants, but sends the blue-tailed fly searching elsewhere. Applied stronger round the stems, but not in quantities sufficient to reach the roots—it would when strong kill them—it also kills the grubs. Sal ammoniac applied in water first, followed after

by lime water, is said also to destroy them utterly. The chemical reaction liberates the ammonia, which poisons the maggots.—N. B.

VENTILATION.

THIS subject was broached very early in the present year, and my name has been prominently mentioned two or three times in the discussion which has followed. I have purposely waited in the hope of seeing it thoroughly discussed by new pens, with the object of picking up some new ideas myself; but the subject lags so considerably that my patience is exhausted, and although I have written on it so very frequently I must have a few more words now.

Strangely enough this was the very subject on which I first ventured to send a note to a public paper. That note was sent from the same county in which "J. J." writes, and from within three miles of the famous Cucumber-growing establishment to which he refers, and appeared in the *Journal of Horticulture* about seventeen years ago. This was before Prescott had taken specially to Cucumber-growing.

I well remember the trouble I took over that letter, how many times it was re-written, and how puzzled I was to invent a suitable title for it, and how, being in Liverpool on the day of its publication, I could not wait till I reached home to read my copy awaiting me there, but nearly missed my train in procuring one from the bookstall, which I anxiously scanned with an audibly beating heart as I passed through the crowd on the platform.

In looking over the said article now I find that my ideas with respect to ventilation have not undergone any great change, and one passage appears to be singularly appropriate to quote at the present time. It is as follows:—"For growing rapidly in spring many kinds of tender and half-hardy plants I believe that ventilation (till we find some better method) as well as shading may be advantageously dispensed with. If no more fire heat is employed during cold nights and dull days than is necessary merely to keep the plants in health, and due attention is paid to the hygrometrical state of the atmosphere, the amount of natural heat and light the plants will bear profitably, and the rate and quality of their growth, will surprise those who have not experimented on the subject."

I then mentioned that I had struck cuttings of *Tropæolums*, *Verbenas*, &c., on a dung bed as late as the end of April without shading and without a leaf drooping. I may now add that when experimenting in this direction I was obliged to fasten the lights with nails to prevent any person during the hottest part of the day shifting one of them for a moment, under which contingency the cuttings would almost instantly have become tender. The frame must be almost air-tight, and there must be some mild steam rising from the well-prepared dung, and then I do not know how high the temperature may safely rise, but probably 130° in the shade would not hurt fast-growing plants.

My experiments in this direction were first made at Shrubland Park, where at the age of seventeen I found myself responsible for the production of a hundred thousand bedding plants for that then famous flower garden. I practised something of a similar method at Chiswick for the production of the plants for furnishing the beds at Kensington prior to the opening of the new gardens to the public on June 10th, 1861, and the success of the plan caused that excellent cultivator whom I now have the privilege to call my old friend, Mr. Richard Gilbert of Burghley, to exclaim to Mr. Barron, "Taylor is the fellow, he makes plants out of nothing." I have to apologise for saying so much about myself in this paper, but I do not know how else to make my views clear to your readers.

There is one phase of the non-ventilating system practised by myself which I cannot understand, neither has any person I have hitherto asked been able to solve the problem satisfactorily for me. It will be remembered that a year or two ago I wrote on a system of air-tight propagation. Now, it is not easy to believe that a cutting or a plant can live for a month in a small space without a change of air, although it is well known the change may take place very slowly indeed, and that a very slow interchange is better for cuttings or newly rooted plants than is a rapid one; but the difficulty to me is to know where and how the cuttings can get any air from under the system which I practise for winter and spring propagation.

In the dung-frame propagation I have spoken of there is no difficulty at all about that question, as the smallest apertures between the fittings of the woodwork and the glass will admit some air, and the higher the inside temperature becomes the more rapidly will the air pass through these apertures; but under the system now alluded to every visible aperture is sealed up.

Boxes are prepared by half filling them with soil suitable for cuttings, and this is made quite firm. The cuttings are inserted,

watered, glass is laid over the top, strips of paper are pasted along the edges partly on the wood and partly on the glass, and other strips are sometimes pasted across the boxes where the panes of glass meet. Now, the only place I can imagine for the air to get in is through the bottom of the box, and then through the soil; but, strangely enough, I have at times used closely made packing-boxes, and they appear to answer equally as well as the cutting-boxes proper. When the cuttings are rooted a little they soon suffer if the strips of paper are not cut through; but that such as *Roses* or *Carnations* should live from three weeks to a month and retain large healthy foliage in a place which is almost as near being impervious to air as I know



Fig. 107.—*Tulbaghia violacea*.

how to make it is to me a physiological mystery; but it goes far to prove that plants do not require so great an interchange of air as is generally imagined.

I find that I have much more to say, which must be left till another issue.—WM. TAYLOR.

TULBAGHIA VIOLACEA.

A PRETTY little hardy bulbous plant that is far too seldom seen in gardens is that represented in the woodcut (fig. 107). The name may be said to be the least recommendation possessed by the plant, for that is by no means euphonious, though the plant itself is both graceful and attractive. The flowers are rich purple, and are borne in large umbels, which have a pleasing effect when intermixed with other hardy flowers. The plant from which our engraving was prepared was growing in Mr. T. S. Ware's Hale Farm Nursery, Tottenham, and was very bright and charming earlier in the season. It succeeds in any light moderately rich soil, and requires no special attention in its cultivation.

THE NIGHTINGALE IN KENT.—The nightingale has recently been written about in the *Journal*. I may say that in this district it

has been very vocal this summer. It arrived before the cuckoo this season, as it sometimes will. The cuckoo was unusually late, but I did not note the precise time. I have had repeated evidence of the curious fact (questioned or denied by some naturalists) that there are nightingales fond of taking up a position in a spot close to a busy thoroughfare, where they will sing by day uninterruptedly if well sheltered by a hedge or thick shrub. But of course to hear a chorus we must go to places more retired—woods, for instance, or some of the deserted chalk quarries overgrown with wild plants, which seem very attractive to them.—J. R. S. C., *Gravesend*.



AT a General Meeting of the ROYAL HORTICULTURAL SOCIETY, held last Tuesday, G. T. Clark, Esq., in the chair, the following candidates were elected Fellows—viz., W. Arkinstall, Mrs. J. Cockburn Hood, Capt. R. Dallas, Augustine W. Dufrene, John H. Fisher, H. F. Partridge, J. T. Peacock, James Quick, Joseph B. Lathu-Pathy, James Savage, John O. H. Taylor, George Williams.

— A STATE CONCERT having been fixed for Wednesday the 27th, H.S.H. the President of the ROYAL BOTANIC SOCIETY has, with the consent of the Council, postponed the Evening Fête from Wednesday, June 27th, to Thursday, June 28th, to enable himself, Her Royal Highness the Princess Mary Duchess of Teck, and others to attend the Fête. Tickets issued for the 27th will be available on the 28th. A Special Promenade will take place at the Gardens on the 27th.

— A HORTICULTURAL EXHIBITION will be held at OSTEND from the 12th to 16th of August of the present year, when gold, silver-gilt, and silver medals will be offered in 165 classes for plants, flowers, and fruits. Forty-six gold medals are offered, including one by the King of the Belgians for fifty miscellaneous plants, and one by the Queen for twenty Orchids in flower. In addition the hotel-keepers of Ostend will give a prize value 500 francs to the exhibitor who contributes most to the beauty of the Show.

— THE following hint on LAWNS IN HOT WEATHER may be useful before the summer is over:—Where soil is thin or exhausted, heat and drought soon tell on lawns. Where there is any danger of the turf turning brown it will be found a good plan to raise the machines, so as to leave a good shading for the roots. It is not bareness, but smoothness and greenness, that constitutes the beauty of lawns. It will be well, too, to keep off the box and allow the cut grass to remain, thus further shading the ground. But nothing is so effective as a thorough soaking of water, unless it be a "soaking" with a little nitrate of soda in it, or sprinkled over the surface and watered in. When this is done spring begins again.

— THE PELARGONIUM SOCIETY will hold its ninth annual Exhibition at South Kensington on Tuesday, the 26th inst., and holders of tickets for the Show will have free passage through the Fisheries Exhibition. The schedule of twenty-six classes provides for all known sections of Pelargoniums, and in addition two prizes of £5 each are offered for the best hybrids of Pelargonium oblongatum and Geranium pratense. The Royal Horticultural Society supplements the list of prizes, amounting to £150, with the offer of a Banksian medal for the best specimen Pelargonium.

— RELATIVE to FRUIT PROSPECTS IN EAST LOTHIAN a correspondent states that all the smaller fruits are looking very well indeed, promising heavy crops. Apricots are very thin, so are Plums. Pears are good, and Apples show very well, but it is too soon to predict with certainty as to the crop of fruit that will follow.

— ESPECIALLY noteworthy is IRIS SIBIRICA, one of the

most lovely of the section in which it is included, and, moreover, one of the most useful. Its narrow, fresh-green, tapering, grass-like leaves in dense tufts are alone pretty, but when bearing its numerous bright-blue-veined flowers on stems 3 feet or more high it is unrivalled. Clumps of this species have a fine effect in any damp or shady place, and it is one of the freest to flower. The German Irises, with *I. lurida* and others of that group, are also now in fine condition.

— IN the west end of London this season a surprising number of MARGUERITES are employed both in pots, in the windows and conservatories, and in boxes. Indeed, some of the latter contain no other plants; but this, which graceful though it be, becomes somewhat tiring in such abundance. In one of the most fashionable thoroughfares we recently observed that quite three-fourths of the window-boxes were partly or entirely filled with plants of this Chrysanthemum. It must, however, be admitted that these are preferable to Sunflowers in similar profusion, though doubtless the latter would be more in accordance with the taste of some so-called æsthetic people.

— THE monthly meeting and dinner of the HORTICULTURAL CLUB was held on Tuesday at their rooms, Henrietta Street, Covent Garden, and was numerously attended. The following gentlemen were admitted as members:—J. H. Mangles, Esq., Valewood, Haslemere; E. G. Loder, Esq., Floore Weedon; Dr. Henry Bennett, The Ferns, Weybridge; and Henry Stevens, Esq., Byfleet. It was unanimously resolved that a life member's subscription of ten guineas be given to the Gardeners' Benevolent Institution. Most of those present afterwards adjourned to the meeting of the Royal Horticultural Society at Burlington House.

— IN the neighbourhood of the metropolis STRAWBERRIES are very promising, the show of flowers being very great, and indicating the probability of a very large crop. Most small fruits, such as Black and Red Currants, with Gooseberries, are good, though Raspberries are far from satisfactory in most gardens. Apples are abundant, Pears only moderately so, and Plums very scarce.

— IN the note respecting the DARLINGTON ROSE SHOW on page 450 it was inadvertently referred to as one of the National Rose Society's exhibitions, a mistake which was caused by the similarity between the schedules. The two societies are, however, affiliated.

— MR. MUIR sends the following note on WEIGELA ROSEA: "In the pleasure grounds here there are many plants of this in beautiful condition at present. The largest of them are about 10 feet high and 12 yards or more in circumference, and a mass of closely formed racemes of the pretty Foxglove-shaped rosy flowers. They are widely different in habit from the Rhododendrons, Lilacs, Spiræas, and Deutzias; but although some of those are very showy they are not more attractive, and certainly much less graceful, than the Weigela, which should be in every garden. It is perfectly hardy, will succeed close to the sea or far inland, and in ordinary good soil."

— MESSRS. SUTTON & SONS' Calceolarias were recently noted, and a word of praise is merited by the GLOXINIAS AT READING, for though they are not at their best, yet they are so extremely vigorous that good evidence is afforded of what may be expected. The handsome plants shown by Mr. Farey at the Reading Show last month, which were grown from Messrs. Suttons' seed, not only proved the high quality of the strain, but also how much can be done by liberal and skilful culture. This is made the rule in the Reading nursery, all plants from which seed is to be saved being treated as liberally as possible in regard to the supply of heat, moisture, and stimulants. As a result, flowers of unusual size and substance are produced, and the

strength the plants have gained enables them to mature plump substantial seed, which is the best calculated to perpetuate a really good strain of any kind of flower.

— CONTINUING his notes from last week our correspondent says:—"At Oxenford Tomatoes are grown very much as Vines are, only the plants are restricted to single rods. In this way the plants rival the Vines in bulk, and huge clusters of very fine fruit are produced."

— STRAWBERRIES IN POTS are well grown at the above place. The favourite is the old Keens' Seedling, and those ripening in May were certainly very fine, indeed all round the district Keens' Seedling is a favourite, and justly so, for it grows well and fruits heavily. At Ormiston the rows of Keens' Seedling were a sight to behold when in bloom. Doubtless the fine quality of the soil in East Lothian has something to do with it, for in some places it is a comparative failure.

— A COMPARATIVELY rare Orchid is *DENDROBIUM DRACONIS* (*EBURNEUM*) which is now flowering in a score collections. It is one of the nigro-hirsute section, and related to *D. Jamesianum*, though quite distinct from that species. The sepals and petals are thick, of a shining ivory-like whiteness, the lip being bright orange red in the throat. It is very pretty, the flowers being borne several together upon the growths.

— THE handsome *CATTLEYA MORGANÆ* has been flowering very freely in Mr. B. S. Williams' Nursery at Upper Holloway lately, and is undoubtedly one of the finest forms of the *C. Mendeli* type. The sepals and petals are broad, white or faintly blush tinted; the lip being large, beautifully fringed at the tip, white, with a gold throat, and a well-defined blotch of rich crimson in the centre. This first flowered with Mr. B. S. Williams, and was named in honour of Mrs. Morgan of New York. An excellent figure is given in the "Orchid Album."

— IN the gardens at Bushy Down, Tooting Common, the residence of J. Connell, Esq., Mr. Todman, whose fame as a hybridiser and raiser of improved varieties of popular plants is far from being merely local, has a number of beautiful SEEDLING PELARGONIUMS of the decorative type, several of which are important additions to that group. Very notable is one that Mr. Todman states is a cross between a Show and a Fancy variety, and the characters of which appear to bear out the correctness of the statement, for both in foliage, habit, and flowers there is quite an intermediate character, while it shares the good qualities of both. The flowers are neat, in dense trusses, and of a bright scarlet colour, most effective either on the plant or for cutting. Others of the larger-flowered type are distinguished by the richness of their scarlet or crimson shades and by their extreme floriferousness. The conservatory is almost filled with attractive seedling Fuchsias and Pelargoniums which have been raised at various times by Mr. Todman, while the hybrid Azaleas that have in recent years been sent out from Bushy Down are recruiting their energies for another season by making vigorous growth. In another house are several dozen extremely handsome Gloxinias, the large leaves quite concealing the pots, and bearing flowers by scores.

— IN the stove at the same establishment a rather rare Orchid is flowering—namely, *CYRTOCHILUM STELLATUM*, which is found very useful for cutting, the flowers being arranged singly for buttonholes, or wired and used for bouquets. The sepals and petals are narrow, yellowish or straw-coloured, the lip being white tinged with purple.

— THOUGH of very moderate size this may be termed a MODEL GARDEN, its general condition under glass and outside being most satisfactory, and it is only by the careful utilisation of the space at command and close intercropping that a sufficient

supply can be raised to meet comparatively large demands. A number of pyramid Apple and Pear trees were planted a year or two since round the kitchen-garden quarters, and are now progressing very satisfactorily, and in an ornamental point of view they are very pleasing, while their crops, which are yearly increasing, are greatly valued.

— "MUSHROOM CULTURE FOR AMATEURS" (170, Strand) is the title of a small work of forty-seven pages by Mr. W. J. May, and contains instructions respecting the production of this much-valued vegetable. Those cultivators, however, who grow the best crops and the finest Mushrooms do not sift the manure for the beds now-a-days.

— AT the back of the old Lily house at Kew is a large bed of an extraordinary AROID, *AMORPHOPHALLUS CAMPANULATUS*, which is now producing fifteen strangely formed and exceedingly foetid flowers. The leaves are similar to those of the better known *A. Rivieri*, having a much-divided green expanded portion at the apex of the stout blotched and spotted petioles. The spadix, which is of a dull red colour, is surrounded by a green corolla-like spathe, bell-shaped in form, as the specific name implies. The odour is indescribably the most disagreeable and powerful of any similar plants.

— THE tank of the same house now contains a fine collection of Water Lilies, amongst which the *NYMPHÆA STELLATA* VAR. *ZANZIBARENSIS* is particularly striking, owing to the remarkably rich purple colour of the flowers, quite distinct from all others of the genus. The general condition of the Nymphæas is very satisfactory, and the circular tank in which they are grown shows them to the best advantage, and the Royal Victoria itself when grown there could always be seen much better than its present oblong tank. All these charming plants are worthy of more attention than they usually receive in private gardens.

— MR. BARDNEY writes:—"The following IRISES are worth growing in any garden—*I. florentina*, white; *I. celeste*, lavender blue; Bridesmaid, white suffused lavender; Hericart de Thury, yellow, brownish crimson; Hortense, yellow; Rowlandiana, blue, the falls being reddish purple; Magpie, a good lavender; and William III., a good purple. These plants are most conspicuous when in full flower in mixed borders of herbaceous plants, but are more at home amongst dwarf evergreen shrubs. A large bed in some suitable place in the pleasure grounds would at this season of the year be charming."

— "SCIENTIA" says HAWTHORNS are flowering in the neighbourhood of Liverpool more profusely this season than they have for many years. Large bushes of the double white, pink, and bright crimson when densely laden with flowers are amongst the most striking and beautiful of flowering trees for pleasure grounds and parks. They are amongst the most useful trees that can be planted in the suburbs of our large towns. They grow in almost any soil, and much more profusely than the majority of trees where smoke abounds, and the double forms scarcely ever fail to flower. Around London these trees are greatly appreciated; they are now, however quite past their best, the dry weather we have experienced having shortened their duration considerably this season.

— "RHODODENDRONS," a northern correspondent states, "are not displaying half their usual beauty this season. They are generally flowering profusely, but the flowers are small and more or less deformed, owing undoubtedly to the east winds experienced when the buds were developing. This combined with the dry weather has been very much against them. The flowers are of very short duration, and are almost past before they are fully expanded, as they have been flagging seriously for the want of rain."

— MR. H. HASKINS of Bournemouth has sent us a spray of

his new seedling *FUCHSIA BELLA*, which is very distinct, and in all probability will become of considerable decorative value. It is the result of a cross between the good old species *F. fulgens* and the popular market variety Mrs. Marshall, and possesses the characters of both parents—the long tubular flowers of the former, and the floriferous character of the latter. The colour of the corolla is the same as that of *F. fulgens*, nearly scarlet with a tinge of purple, while the foliage is like that of Mrs. Marshall, but darker. The tube and sepals are pink. As the habit of the plant is stated to be dwarf, and as it is evidently very floriferous, it is not unlikely that the variety will become popular. The variety Lord Beaconsfield had, if we mistake not, *F. fulgens* as one of its parents, and so had the American variety *aurea superba*, but *Bella* is quite dissimilar from both, and healthy plants covered with long pendulous blooms must be highly attractive.

— MR. MCINTOSH'S GARDEN AT DUNEEVAN cannot be visited at any period of the year without affording pleasure to those, and they are not a few, who inspect it, while there is always something worthy of note that is not without interest to readers of garden literature. This is an excellently kept, admirably managed, liberally supported, and much-cherished garden, and a few of its most prominent features may be briefly referred to.

— FIRST of all demanding attention are the RHODODENDRONS. These as grouped in several large beds on the smooth daisy-less lawn arc, or were a week ago, magnificent, though several of the shrubs are not so densely covered with trusses as is customary; but where thousands are grown, and these the best varieties in commerce, a gorgeous effect is produced. A very few of the best varieties which no one can err in growing are *Garibaldi*, warm salmon with crimped petals, prominent stamens, and effective truss. *Sigismund Rucker* is a very dark flower, rich and massive. *Agamemnon* is another dark plum colour, singular by its white blotch; and to complete the trio of the deeper colours *Joseph Whitworth* commands admiration. In contrast with these the very light forms *Picturatum*, blush, maroon blotch; *Sappho*, white, chocolate blotch; and *Madame Carvalho* are chaste and charming. As a salmon rose Mrs. R. S. Holford is unsurpassed if equalled. *Kate Waterer*, deep rose; *James McIntosh*, rose, variously tinted and richly spotted; *Duchess of Mecklenburg Strelitz*, rosy pink; *James Marshall Brooks*, rich pink; *Lady Armstrong*, bright rose; *Apology*, rosy purple with a reddish brown blotch; with *Marchioness of Lansdowne* and *Vauban*, similar in character, yet quite distinct, are very telling. *Michael Waterer*, a fine standard, has been all aglow with its crimson flowers; and *fastuosum flore-pleno* with two to three hundred trusses is a splendid object on the lawn. These are mentioned as representative of this rich collection, in which are hundreds of others of equal merit.

— ASSOCIATED with the Rhododendrons are numbers of AMERICAN AZALEAS, rich and fragrant, and which add much to the beauty of the garden in June. They are too numerous to be particularised, yet the clear yellow *Nancy Waterer* should be grown by all. It is the finest of its colour, and cannot fail to give satisfaction. A seedling with orange red flowers has, as it deserves, a bed to itself. It is a rich glowing bush that cannot be passed without admiration, while the pale *viscocephala* is deliciously fragrant.

— As a relief to these dense masses of colour are a few CONIFERS, which equally merit notice, as also do one or two OAKS, relics of the forest primeval, with gnarled, massive, and gigantic trunks, such as only the Oak can produce; but to the Conifers, just two of which may be alluded to.

— IT is here that may be seen the finest specimen in England of the beautiful bright green columnar Cypress *CUPRESSUS LAWSONIANA ERECTA VIRIDIS*. It is 25 or 30 feet high, and

admirably furnished from base to summit. This is a pattern Conifer for small lawns, and should be grown as such everywhere.

— ANOTHER specimen particularly fine is *ABIES ALBERTIANA*. This is far more beautiful than the common Hemlock Spruce—more stately and massive, yet not less elegant. The Duneevan example is 50 feet high—a grand pyramid, which at the present time appears as if studded with gold, so bright are the young growths and so striking the contrast with the old dark foliage. Prince Albert's Fir is not planted so freely as its merits demand, as it is scarcely possible to conceive of a lawn ornament more graceful and attractive. Reference to Vines, Lilliums, &c., in Mr. McIntosh's garden must be deferred.

— AS Mr. Taylor surmises may be the case with Duke of Buccleuch Grape, and as 'Single-handed' has shown to be the case with Magnum Bonum and Scotch Champion Potatoes, plants with extra robust constitutions, or which are extra good foragers, may have "TOO MUCH NITROGEN" given them. Some, again, may be spoilt at one period of their growth with nitrogenous applications, and yet be benefited at others. Melons grown in soils rich in nitrogen grow rapidly and rankly, but set badly as a rule. Grown in moderately "rich" loam—that is, not rich in nitrogen—the growth is moderate, but of firm fruitful quality. However, embryonic seeds demand much nitrogen, and nitrogen given after the fruit is set materially helps to swell up good specimens and heavy crops. While, then, giving much guano water, nitrates, ammonia salts, or stable drainings to other than stunted plants in the earlier stages would assuredly do evil, their application just before and after the setting period will materially aid in securing a full crop, and in assisting the plants to mature it.

— "A. H." writes:—"The warm sun will enable growers of indoor fruit to save the coal. Much discussion is indulged in in connection with NIGHT TEMPERATURES; but if at any time low night temperatures are beneficial it is when the heat by day is excessive. Then nothing but benefit can arise from a cool air laden with moisture to the dew-point during darkness. Moreover, borders are when exposed warmed by the sun, and so the sap which Vines and other trees absorb is warm compared with what it is in sunless seasons. This of itself is equal to several extra degrees of air temperature, for it is only the extent to which the plant is warmed that influences its growth, and it is the same whether the heat comes from the sun-warmed soil or fire-heated pipes."

— MR. JOSEPH MALLENDER, The Gardens, Hodsock Priory, Worksop, Notts, sends the following report of WEATHER DURING MAY:—"We had 174.6 hours of bright sunshine, being 36 per cent. of possible duration. There were four sunless days, nearly seventy hours less than the average of the last two years. The first eleven days were cold and showery, with north-easterly winds. The rest of the month was fine and warm, the wind being principally southerly and westerly during that period. The only rain we had was during a heavy thunderstorm on the 25th, and a fall of 0.33 the next day. Rain fell on twelve days; total fall for the month, 2.31. Mean temperature of air at 9 A.M., 50.0; mean temperature of soil 1 foot deep, 51.6. The mercury on the grass fell below 32° on three nights. The warmest day was the 24th, the coldest day the 4th. The mean temperature of the month, 51.0. Large wasps are very abundant this spring. The first swarm of bees here came out on the 23rd ult., and the Oak was in leaf about twelve days before the Ash."

PREPARING STRAWBERRIES FOR FORCING.

STRAWBERRY-FORCING is an important part of the gardener's duties, and the time is at hand for preparing the plants. There are different modes of procedure in the layering of Strawberries, some being successful under one system, and some another, and

each thinks their own method is the best. Many layer into the fruiting pots at once, thinking it saves time and gives equally good results as by layering in small pots and repotting. There is not the least doubt but that time is saved, but I do not like the system, and prefer layering in small pots. Some, where pots are scarce, layer the runners on square pieces of turf, and it is a very good plan, especially for amateurs, when they wish to make a new plantation. Often they wait until the runners are rooted in the ground before they are planted out, and of course they receive a check. Under this system a season is almost lost, whereas on pieces of turf (about 4 inches square by 2 inches deep) they do not feel the check, and, if planted early, produce a good crop of fruit the following season.

The best time to layer the runners for forcing is as soon as they are procurable. The soil employed for layering the runners into is the same (except being a little finer) as is used when repotting them into their fruiting pots, and consists of four parts strong loam and one part of cow or horse manure. Place a good piece of rough soil in the bottom of the pot, over that a sprinkling of soot, to keep worms out of the pots. Press the soil firm, place the layers on the surface and well peg them down, stopping the shoot beyond the layer. Keep them well sprinkled every evening if the weather is dry, when they will soon be well rooted. They may then be severed from the parent plant, and about a week afterwards will be well established, and should then be transferred into 5-inch for the earliest, and 6-inch pots for the main batch. Arrange them on boards or bricks in the full sun, the runners being pinched off as soon as they appear, and water liberally supplied. When the pots are filled with roots, and the plants look as if a little stimulant would be beneficial, give a little soot water, which is better than exciting manure.

About the last week in October place the plants in their winter quarters. Some growers plunge them to the rim of the pot in ashes in the open air, others place them on shelves in well-ventilated houses; but I think as good a system as any is to plunge them to the rim of the pots in cold frames, the lights to be removed on all favourable occasions. They should never be allowed to suffer by want of water. The principal requirement for Strawberries in pots for forcing, is to have the pots filled with roots and well-ripened healthy crowns; but of course other cultural details must be attended to.—A. YOUNG.

COMING FLOWER SHOWS.

THE following are the dates upon which the principal horticultural exhibitions and meetings of June and July will be held, of which we have received schedules, and Secretaries of other Societies will oblige by forwarding schedules to us of any shows not noticed in this list:—

JUNE.

Thursday, 14th.—South Essex, Knotts Green, Leyton.
 Tuesday, 19th.—Leeds (three days), Worcester (three days).
 Tuesday, 26th.—Royal Horticultural Society, Fruit and Floral Committees at 11 A.M., and Pelargonium Show, South Kensington; Diss.
 Wednesday, 27th.—Cardiff Rose Show; Croydon (Roses); Royal Botanic Society's Evening Fête.
 Thursday, 28th.—National Rose Society's Show, Southampton; Richmond.
 Friday, 29th.—Canterbury (Roses).
 Saturday, 30th.—Reigate (Roses); West Kent; Bromley.

JULY.

Tuesday, 3rd.—National Rose Society's Show, South Kensington.
 Wednesday, 4th.—Wimbledon; Teddington; Norwood.
 Thursday, 5th.—Bath (Roses); Kingston; Farningham; Highgate; Hitchin (Roses).
 Friday, 6th.—Sutton (Roses).
 Saturday, 7th.—Chiswick, Crystal Palace (Roses); Brockham (Roses).
 Tuesday, 10th.—Royal Horticultural Society, Fruit and Floral Committees at 11 A.M. Oxford and Wirral Rose Shows.
 Wednesday, 11th.—Royal Caledonian Society's Show, Edinburgh. Hull Show (three days); Ealing.
 Thursday, 12th.—National Rose Society's Show, Sheffield; Nuneaton; Braintree.
 Friday, 13th.—Ludlow (Roses).
 Tuesday, 17th.—Leek (Roses).
 Wednesday, 18th.—Nottingham Floral Fête (two days). Darlington (Roses).
 Thursday, 19th.—Evening Fête at Chiswick; Aberdeen; Helensburgh (Roses).
 Tuesday, 24th.—Royal Horticultural Society, Fruit and Floral Committees at 11 A.M.; Carnation and Picotee Show, South Kensington.
 Wednesday, 25th.—Colnbrook.
 Thursday, 26th.—Eastbourne.

AUGUST.

Saturday, 4th.—Southampton (two days, or three including Sunday); Liverpool (two days, or three including Sunday).
 Wednesday, 15th.—Sutton.
 Friday, 31st.—Crystal Palace National Dahlia Show and Fruit (two days).

HOLLIES LOSING THEIR LEAVES.—When Hollies lose their leaves in large numbers just as their young leaves expand, the chances are ten to one that drought in the soil as well as in the air is the cause. Plants may be quite healthy and strong, but no robust health will do

instead of water in such seasons as we are now experiencing. The rainfall has, in many districts, been much under the average for many months past. When the soil is full of roots it is, unless in damp spots, so dry that plants which have had leaves evaporating water all through the spring—and all evergreens have—are certain to suffer, on dry soils especially, if they are thin. Hollies that drop their leaves bodily are in great want of water, and the only effectual help that can be given is to prick up the surface soil, make rims to prevent the water running away, and to give at least a foot of water, to be repeated a few days after, and then a thick mulching to prevent the applied water being evaporated.—S.

HOME-GROWN LILY OF THE VALLEY FOR FORCING.

THERE seems to be some misunderstanding about the culture of Lily of the Valley, as noted in a short communication to the Journal a few weeks ago. I will as shortly as possible note the main points of cultivation. Single crowns are not employed. Clumps are lifted out of the garden from those under culture for producing an out-of-door supply of flowers. The clumps are grown in four-line beds planted a foot apart each way. These when potted are flowered as a late batch and brought on earlier the following season. By placing lights over the beds at the time the young growths begin pushing, and keeping them there until summer weather prevails, the crowns are plumped up earlier and are more suited for forcing. However, these clumps are never employed for our ordinary supply of plants. These are grown year after year in pots, and that is the only way a natural-looking potful can be produced. Foliage and flowers are obtained to the very edge of the pot, and the results are quite as good at Christmas as we have seen with imported stuff in February. It must be fully understood that the plants must be carefully grown after the bloom is over. It may be added that clumps are taken up and potted at any time when they are wanted, say in March as a rule, and those in pots are generally repotted after the season's bloom is over.—R. T.

RAISING STOCKS AND BUDDING ROSES.

I AM desirous of trying the budding and grafting of Roses on the Manetti and seedling Briar stocks, but am ignorant as to the time when the different stocks should be planted, the time for budding, how to bud, graft, &c. I wish to see the subject fully treated. I have recently started to get the Journal, and have found it answer my purpose much better than all the others that I have tried, so you will see that I do not know whether the propagation of Roses has been treated on lately or not; if not perhaps you might find space in it to give an article on this very interesting subject. I found in the articles that appeared in the spring anent fruit-tree grafting all that could be desired—plain and practical, and think you would find that this subject I ask for would be highly appreciated by hundreds besides myself who cannot buy all the Roses they want, and therefore wish to propagate some themselves.—AN AYRSHIRE AMATEUR.

We readily comply with this request, as we have the satisfaction of knowing we have hundreds of readers who have not seen the following article written by Mr. W. Farren of Cambridge, first published by us nearly ten years ago. We do not think that this subject has ever been more fully and clearly treated, nor do we think it could be made more plain than in this admirable article entitled—

"HOW TO GROW A ROSE."

Pray don't think me vain. I know but little, but would impart that little to my fellow lovers of the Rose; and ere I begin I will beg of old practised hands to pass this article by, for I fear—nay, know—they will find nothing new here. I write this for the beginner, as there always are and must be beginners; else—but I won't moralise. Neither am I purposing to say how to raise new varieties edged and flaked like Carnations and Picotees, nor how to grow black Roses by budding on the Black Currant, nor how to grow bright sky-blue Roses by putting cobalt or sulphate of copper in their drinking water; for

"Thus the craftsman thinks to grace the Rose—
 Plucks a mould flower
 For his gold flower,
 Uses fine things that efface the Rose;"

but to make the most of what we have.

"First catch your hare" is a good old maxim, and "First get some cuttings or plants of Manetti" will be found an indispensable one to growing Roses on the Manetti stock. And having done so, select good medium-sized, well-ripened shoots of the

current year; cut them into lengths of 8 to 12 inches, according to the number or closeness of the eyes thereon—a cutting 8 inches long is equally as good as another of 12 inches with the same number of eyes; cut the bottom end of the cutting immediately below an eye, clean and level, without sloping; the top end to be cut just above an eye. All eyes are now to be cut clean out except the top two (see fig. 108.)

I find the cuttings take better and grow stronger if two or three buds are left on than they do if one only is left.

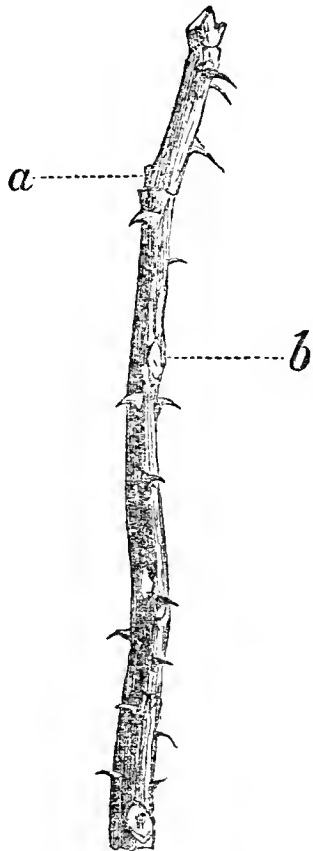

Fig. 108.—One-third natural size. Cutting of Manetti ready for planting. *a*, Lowest bud not cut out, and when planted to be earthed-up to. *b*, Highest cut-out bud up to which the cutting is to be inserted in the ground.

The cutting is now ready for planting, and the sooner this is done the better. I do not mean the same day, but if you let the



Fig. 109.—One-third natural size. *a*, Rose shoot with buds. *b*, Stock showing T-cut for bud. *c*, Bud or shield just cut from shoot.

cuttings lay a few days after preparing you must expect to see unsightly gaps where they have failed. My plan is to mark out a plot of ground in rows thus:—Two rows 18 inches apart, then a

space of 3 feet, then two rows of 18 inches apart, and so on till the plot or quarter is full. Having pegged-out the ground, we then set the line, chop out a shallow trench with the hoe, and plant the cuttings. As to distance, it is a good deal a matter of taste, but 10 inches is a good distance; either an inch or two closer or further apart will be of little consequence. Slightly lean the tops of the cuttings towards each other in the double or 18-inches-apart rows (see fig. 110). Let the cuttings be inserted in the ground to the topmost cut-out eye (see fig. 108, *b*), then tread very firmly, and earth up so as to bring the soil level with the lower of the two eyes left intact (fig. 108, *a*.)

The cuttings may now be left to themselves till the weeds begin to grow, when a scratch-hoeing will be requisite and advisable, both to destroy the weeds and to freshen-up the surface soil, as the cuttings will be much benefited thereby. Should there be frost and light rains during the winter it will be well, when the soil is dry enough, to walk up the rows and tread firm again, as the frost will be found to have loosened the cuttings, which is not good for them. If heavy rains succeed the frost there will be no need, as it will have made the soil firm enough. September and October are the best months to get in cuttings, but if you go in for a lot you may keep on planting till the end of the year. The small and rather unripe shoots may be cut into lengths and, planted closely in rows to grow into plants for the next year when they may be planted out during the winter for budding in the following year, or potted to use for grafting in the spring.

There will be nothing else to do till budding time, except to

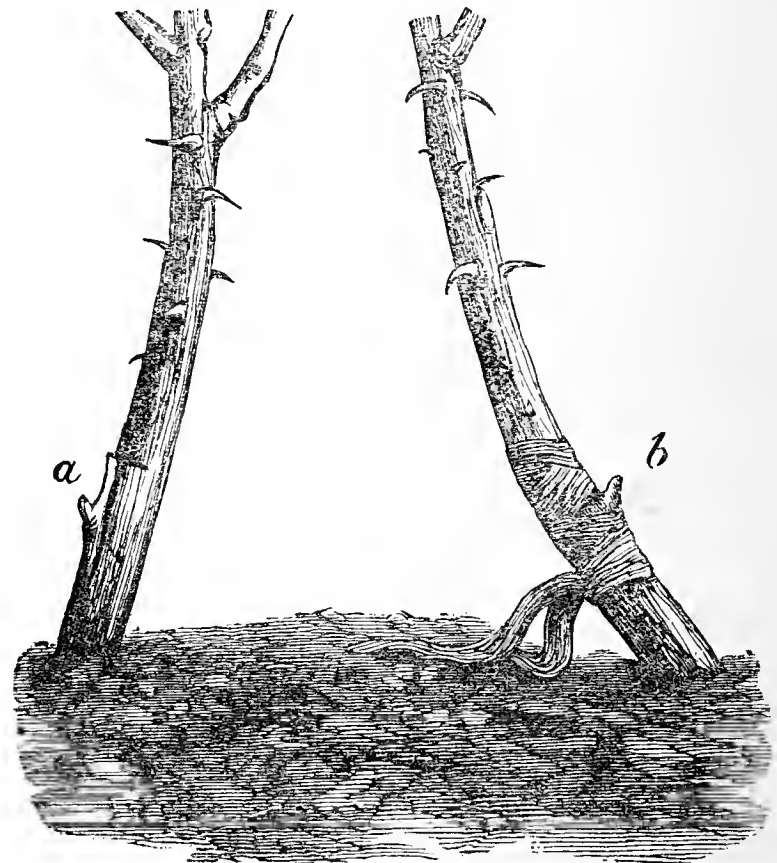

Fig. 110.—One-half natural size. End of double or 18-inches-apart rows. Soil cleared from stocks for budding. Shows also how to plant, leaning the tops towards each other. *a*, Bud inserted, top part of bark cut off so as to fit that of stock. *b*, Ditto tied.

keep down weeds. Do not be in any great hurry, as the Manetti is not so quickly unfit for budding as the Briar, and it is best to bud the Manetti after you have done the Briar. I say after the Briars, as I hope you will not give the Briar quite up; in fact, you must have it for Teas, &c., for although Teas will do well on the Boursault and some others, still the Briar for Teas and Noisettes. The first week in August is quite soon enough to begin, as I find, if the Manetti is budded too soon in the season, it is liable to overgrow and cover-up the bud; besides, you will get better, larger, and stronger buds later in the season, and they will not be so liable to start then. And now, all ye whose backs are long, who measure more than 42 inches round where the fifth button on your waistcoat is, who are liable to bilious attacks, headaches, swimming in the head, rush of blood to the brain, and other such evils that mankind is favoured with—take my advice, Don't go in for budding your own Manetti, but enjoy the good things of this world while ye may, and buy your Manetti plants ready worked, because it is possible, nay, probable, that it won't agree with you; and if standing on your head all day, with the

glass at 98°, is not one of your special enjoyments, you won't enjoy budding Manetti.

Well, all is ready, and buds got, nice plump ones. In getting buds, nice half-ripe shoots full of good buds should be taken where

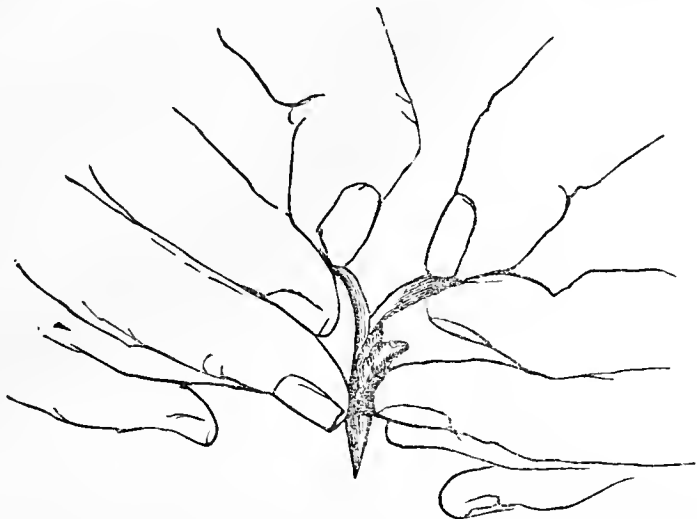

Fig. 111.—How to hold the bud when pulling out the wood. As the bark and wood separate slip the third fingers of both hands downwards gradually till the end is reached; by so doing the bark will hardly ever break.

they can best be spared. I have been asked, "Do you cut the buds one at a time off the wood, or cut lengths of wood with several buds on?" Of course the latter (see piece of Rose shoot with buds (fig. 109, *a*))—I remember the time when I didn't know—set the shoots in a small can with an inch of water to keep them fresh; clear away the earth from your stocks—don't clear too many at once, as the bark soon dies and then wo'n't work so well—down, or nearly down, to the roots; just rub your thumb and finger round the stock to clear from soil and thorns; make a cross T-cut (fig. 109, *b*), and insert the buds as in fig. 110, *a*; tie in the regular way (fig. 110, *b*), and in about a month the cotton may be removed. Should any buds have missed, insert others at once just below where the first was put in. You may do this till quite the second week in October if the weather is warm, which it generally is, with a very good chance of the bud taking.

Oh! ah!—there now! I have forgotten I am writing this expressly for those who do not know. I well remember, when I



Fig. 112.—Stock with growing bud in May; top of stock properly cut off.

began, the annoyance and vexation it was to me to find almost all writers "presume" that everyone knows such and such a thing as to the minor details, and that was the very information I wanted, and I have not said a word about preparing and inserting the buds. Well, then, get good shoots of the sorts you are going to bud, with plenty of "fat frog-nose" shaped buds, such shoots as have borne flowers, or are about to do so; often these latter yield

the best buds, as the former will have sometimes started, or even blind shoots—*i.e.*, those without flower buds, if they are not too gross and strong, or unripe and pithy. Medium-sized shoots are best, about the thickness of a "churchwarden clay" pipe-stem. As soon after you get the Rose shoot with buds I advise cutting off the leaves, so as to leave the footstalk only (see fig. 109, *a*), as by leaving the leaves on, the bark of the shoot is much sooner shrivelled-up through evaporation than if the leaves are cut off, as there shown, and will keep plump and fresh much longer. Cut out the bud, as in fig. 109, *a* and *c*, with a thin slice of wood, and in budding Manetti you want a longer heel to the bud than for the Briar. Cut the bud with the bark about an inch long, about two-thirds above the bud, and one-third below; remove the wood as in fig. 111. I cannot explain it, but take the bud in the left hand as shown there, take hold of the wood with the nails of the right thumb and finger, and pull it out. Do it without fear, and boldly, and you will not spoil one in a hundred. Now make a cut in the bark of the stock, as in fig. 109, *b*, with a cross-cut—mind your knife is always very sharp—lift the bark with the back of your budding knife, and insert the bud, as shown in fig. 110, *a*, Push it well home; cut off level with the cross cut, so that the bark may fit well with that of the stock; tie with candle cotton, not too tight, and tie with the knot behind, on the opposite side to where the bud is inserted (fig. 110, *b*).

I have been asked, "Should the earth be returned, so as to cover the stocks as before budding? Should the stocks be pruned or shortened now?" No, to both questions; leave them as they are, and the stronger they grow now the better plants you will get next year. In September and the following months to the close of the year, but the sooner the better, the shoots may be cut

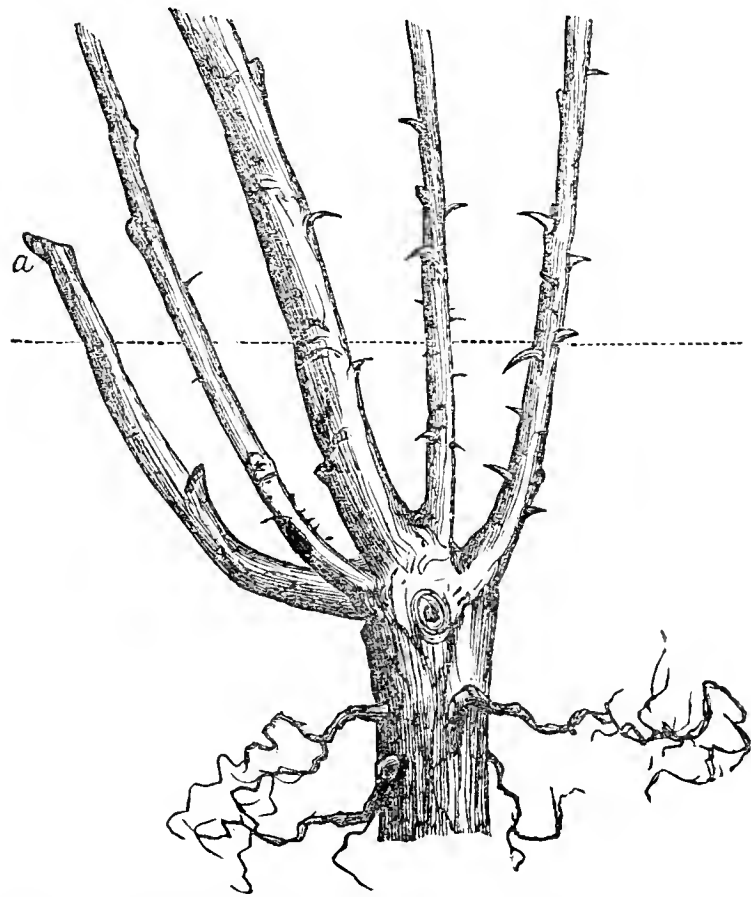

Fig. 113.—Finished plant, to be planted 4 inches above the junction of stock and scion, or to dotted line. *a*, How to cut back in March.

from the budded stocks to make cuttings as before, otherwise do not meddle with them till April, and then go over them often, and keep down the new shoots that the Manetti will be numerous and vigorously making. By that means the bud will be induced to start, if it has not done so already, and when grown 6 inches or more in May, cut the stock clean off just above the bud (see fig. 112). The cleaner this is done the better, although the Manetti stands rougher treatment than the Briar, and so is not of so much consequence. I even towards the end of May cut down those whose buds have not started, and so either make them start or kill them, for a Manetti plant in a row of new-budded stuff is such a nuisance, it grows at such a rate as to smother the young plants right and left. Where any buds have missed altogether I pull up the stocks to avoid the evil consequences of their great growth, as, when you are well off for stocks, a few are of no great note, especially when not wanted. Carefully remove any suckers that may appear, as, let the cuttings be ever so well prepared, a

few will show themselves the first year; an old chisel is a capital tool for the purpose. In budding stock plants, the only difference is that you plant your cuttings in a piece of spare ground very closely, leaving room, however, to hoe between the rows to keep down weeds, and in the autumn of the following year lift them and plant very shallow in rows, or as you like. Earth-up the same as for cuttings, and in budding let the bud be put in as near the root as possible. This is really the royal way to work Manetti, as you can get the bud so much closer to the roots than by working the cuttings as planted; but in either way the practice is the same, and the instructions for working struck cuttings will apply in every respect. The new shoot from the bud will require staking and tying, or the wind will blow many out, and is almost as fatal, if not tied, as it is to the worked Briar. I have only now to say that in setting the plants out, plant them deeply, so as to cover the union of the stock and bud 4 inches below the surface (see fig. 113.)

I have seen Manetti-worked plants, when they have been worked too far from the roots, stuck in with the union 5 or 6 or more inches above the ground and—doing wonderfully bad!

In pruning the plants cut them down in March to from 2 to 12 inches, according to the strength of the shoots, and so as to leave the top bud pointing outwards—that is, from the centre of the plant. It is always well to have an eye to the future form of the plant (see fig. 113, *a*) and keep the plant well open by thinning-out. Keep a sharp look-out for 'suekers'; they will not trouble you much, but if one do get ahead it will utterly spoil and kill the plant, the growth is so strong and rapid. I was in a garden last summer where the dwarf Roses were almost without exception Manetti plants, and the proprietor, and his lady especially, wondered they never bloomed. Truly they must have been very badly worked, but in the present state of competition and love of cheapness I do not wonder at that. I am sure properly worked Manetti plants cannot be grown at the price I have seen them advertised.

[Although the first week in August is recommended as quite soon enough for budding, and for the excellent reasons stated; yet the work may be performed sooner, and inexperienced persons will do well to commence practising as soon as buds can be obtained, in order to become competent when buds are to be inserted in the stocks in which they are required to grow. It does no harm to a Rose to take a bud from one stem and insert it in another, and no stocks are spoiled if the first inserted buds do not "take." We have seen buds inserted in June start into growth, flower the same season, and the plants sold in six months; but such Roses, though they may form attractive heads the first season after budding, they seldom, if ever, produce such vigorous growths and grand blooms as when the buds have remained dormant during the year of their insertion, and started into growth the following spring. Grafting can only be done with advantage in a propagating house in the spring, and few amateurs have the requisite means for carrying it out successfully.]

INSECT PESTS AND THEIR DESTRUCTION.

OF the various insects we have to contend with I most dread the black aphid. The ordinary large green aphid is not difficult to destroy, but the case is very different with its hardy little black relatives. In some instances where aphides infest plants in houses the best remedy or preventive is fumigation once a week, or fortnightly when the insects prove less troublesome. Our houses where Melons and Peaches are grown are very old, and it is impossible to thoroughly fumigate them without burning a great amount of tobacco paper. Small houses which are not sufficiently air-tight can be made so by covering them with mats, carpets, or bags, and if these are heavily syringed but little smoke will escape. This plan we occasionally adopt. The foliage of every plant in the house should be dry when fumigated, and even if this rule is strictly observed some injury may be done where the fumes are very strong or much heated. Consequently it is advisable to be watchful, especially when tobacco paper is employed which is not of uniform strength. Where the plants are much infested the dose should be repeated the following evening, and this will kill all, or nearly, all that escaped the first time. Some prefer to fumigate again the morning following, but as we have had plants injured by the sun's rays while the smoke remained in the house I do not recommend the practice.

A more agreeable, cheaper, and equally effective remedy for destroying insects is a decoction of quassia chips and soft soap. The chips can be procured by any chemist or druggist. We buy 6 lbs. at a time. One pound of the chips and 2 lbs. of soft soap are put into about 6 gallons of soft water, and steadily boiled till the chips sink to the bottom, and from this is strained off upwards of

1 gallon of an intensely bitter decoction. Enough is made in three boilings to fill a large flower pot. We have no fixed quantity to be used with a given quantity of water, everything depending upon the result of a preliminary trial. As a rule a 6-inch potful for 3 gallons of water, whether for dipping or syringing, is sufficient, and if soft water heated to about 100° is employed it is still more efficacious. Any small plant and the points of Peach and other trees infested with any kind of aphid and thrips are dipped into the mixture, while Melons, Cucumbers, Cherries, Peaches, Plums, or large plants in houses or on walls are syringed and thoroughly wetted with it. One application is seldom sufficient, as the black fly especially is very tenacious of life, and increases at a marvellous rate. The decoction, however, if persisted in, proves too much for them, and also mildew.

Paraffin mixture does not prove nearly so destructive as the above where the plants are in full leafage, but it is the best insecticide for a winter dressing of fruit trees—Grape Vines excepted. This, I was informed, would be the case by the originator of the remedy, Mr. D. Thomson of Drumlanrig; and I can fully endorse all that he has said in its praise, as it not only destroys any eggs deposited in late autumn by the aphid, but also any kind of scale that may infest the trees.

Next to black aphid the red spider is most to be dreaded. This, again, is not particular in its feeding ground. Given a hot dry atmosphere, and it quickly makes its presence felt upon innumerable kinds of plants, and is with difficulty dislodged from any of them. Dislodged the insects must be, or they will almost irreparably injure everything they infest. Sponging with soapy water or some kind of insecticide is a good remedy; but sponging in the majority of cases is out of the question. Those unacquainted with the symptoms will do well to examine closely the under side of Melon, Grape, or Cucumber leaves which present an unusual yellow appearance, and there in all probability they will discover a colony of very minute spiders. They are the smallest insects we have to contend with, but they are the quickest to affect the colour of the foliage and the vigour of the plant. Frequently syringing and a moist atmosphere will greatly check their ravages, but probably the majority of gardeners depend more upon the effect produced by coating the hot-water pipes with sulphur mixed with milk. At one time I was under the impression they could be destroyed in this manner, especially if the pipes were made as hot as possible; but strange to say the sulphur fumes, though almost unbearable by human beings, do not destroy the spiders nor greatly check their ravages. Has anyone seen a red spider that has succumbed to sulphur fumes not made strong enough to also destroy plant life? I have not seen such a phenomenon.

I still believe in sulphur for checking red spider, but it must be applied in a very different manner—that is to say, either dusting it through a dredger or a muslin bag on to the previously damped foliage, or mixed with water applied with a syringe. The latter method I believe originated in a garden near Bristol, and it certainly is the most simple as well as efficacious remedy I have yet tried. Sulphur does not easily mix with water, but if placed in a muslin or canvas bag, soaked a short time in a can of hot water, and then well squeezed in the hand, the sulphur quickly separates, and can then be kept mixed with the water. It requires to be frequently stirred with the syringe in the same manner as paraffin, the latter, however, floating while sulphur sinks. With regard to the quantity of sulphur requisite for three gallons of water, this entirely depends upon the nature of the foliage of the plants to be coated with it. For Peaches, Grapes, Crotons, and similarly comparatively smooth-leaved species four handfuls are necessary, or the mixture is made as thick as can be distributed by a syringe. A lesser quantity is sufficient for Melons and Cucumbers. The under side of smooth leaves are not well coated with sulphur, and as this is necessary to insure success the dose should be repeated when that first applied has thoroughly dried. The spiders seem quite unable to withstand this attack, sulphur evidently not suiting their taste, and for the first time in my life I saw some dead red spiders, these being on some young Peach trees operated upon. The sulphur is quite harmless to the plant coated with it, and can easily be syringed off at any time. Syringing must not be resorted to in the case of Vines carrying crops of Grapes, but dry sulphur does not affect the bloom of the berries, and can be cleared off under a tap running clear water. Where Vines at the present time are affected with red spider I should recommend sponging the leaves with sulphur mixed with water in preference to any other remedy. Sulphur is distasteful to other insect pests, and is one of the best remedies for mildew.

Mealy bugs once well established in a place are extremely difficult of eradication. Paraffin and soft soap is the grand destroyer of these, but not mixed, or rather applied in the form

recently described by Mr. Taylor in these pages. When at Long-leat, before the method had been described, I took particular notice of the whole process, and the next day imitated it as closely as I could. We dipped all sorts of plants in the mixture; but though thrips, scale, or green fly were destroyed, mealy bug still held its ground. It must be remembered Mr. Taylor does not grow mealy bug, but unfortunately we do, and shall not be rid of it while our houses are crowded with plants. According to my experience paraffin at the rate of 6 ozs., or three wineglassfuls, to the three-gallon can of soft water, heated to about 120°, and to which is added a lump of soft soap of the size of a hen's egg, will, to quote Mr. D. Thomson, "fetch the white jackets off the bugs," and it is almost needless to say this ends their career. We prefer the evening for the operation, and have two syringes at work—one constantly discharging the mixture back into the can to keep it mixed, the other forcibly syringing it on to the plant or plants to be cleaned. The mixture is usually syringed off in the course of half an hour, and I have never found it injure either the foliage or the roots of the plants. A few bugs generally escape, and if not treated to more paraffin or otherwise destroyed soon re-colonise the plants. It may in some cases, where recklessly applied, have injured the young leaves of tender plants and young Fern fronds. If we sponge the leaves of stove plants, such as Crotons, Gardenias, Stephanotis, and Dracænas, we invariably use a small quantity of paraffin with soapy water, and it is surprising how it expedites the work as well as improving the natural gloss on the leaves.

Vines have been injured in several cases to my knowledge by being dressed with paraffin. Ordinary gas tar mixed with an equal quantity of water thickened with clay is the best winter dressing for Vines, especially if infested with mealy bug. Both Mr. Roberts of Gunnersbury and Mr. Austin of Ashton Court advised me to use it on our Vines, and my experience fully coincides with theirs. Owing to the length of this paper this tar remedy may, and with advantage, be further discussed at a more seasonable date.—W. IGGULDEN.

CLEMATIS MONTANA.

THIS is one of our prettiest outdoor climbing plants in flower at the present time. It is quite hardy, makes shoots 8, 10, and even 12 feet long in one season, and these have blooms on their entire length the following year. The flowers are about the size of a two-shilling piece, pure white, and are produced in the greatest profusion. It is a charming plant with which to drape old walls, trellises, and stumps of trees. One of our plants cover the front of a stone lobby attached to the end of a conservatory, and as there is a large Sweet Bay tree close by the Clematis shoots have caught it and are scrambling over the tops of the branches, and the white flowers of the Clematis have a very pretty effect nestling amongst the dark Bay foliage. As to soil and situation this old Clematis is not particular, as it will grow freely almost anywhere; but it is an advantage to have the shoots in a position to be ripened by the sun in autumn.—J. MUIR, *Margam*.

ROYAL HORTICULTURAL SOCIETY.

JUNE 12TH.

THE meeting of the Committees on this occasion was held in one of the picture galleries leading from the principal exhibition buildings, the plants being arranged in the small approach tent. Exhibits were fairly numerous, hardy flowers being particularly well shown by Messrs. Barr & Son and T. S. Ware, Mr. B. S. Williams and Messrs. J. Veitch & Sons contributing new plants and Orchids.

FRUIT COMMITTEE.—John Lee, Esq., in the chair. There were also present Messrs. W. Paul, H. Howcroft, John E. Lane, Arthur W. Sutton, Thomas Laxton, G. Bunyard, Harrison Weir, G. F. Goldsmith, James Smith, Sir C. W. Strickland, Bart., R. D. Blackmore, J. Woodbridge. Mr. G. Goldsmith, Hollenden, Tunbridge, sent two boxes of very handsome Sir Joseph Paxton and James Veitch Strawberries, large and finely ripened, for which a cultural commendation was awarded. Mr. T. Laxton, Bedford, sent a new Strawberry, a seedling from a cross between Vicomtesse Hericart de Thury and Black Prince. It was named King of the Earlies, and is said to be as early as May Queen. The fruits are obtusely conical in shape, occasionally slightly wedge-shaped, of moderate size and good colour. The variety was much approved, and is to be tried at Chiswick. Mr. Stevens, The Gardens, Trentham, sent half a dozen fine Lord Napier Nectarines, large and richly coloured. Mr. C. Herrin, The Gardens, Chalfont Park, Gerrard's Cross, sent a seedling green-flesh Melon named Chalfont Favourite. Mr. Henderson, Thoresby Gardens, Notts, also sent a seedling green-flesh Melon; and Mr. J. Hyde, Watgate, Emsworth, sent a seedling scarlet-flesh variety. All these were passed. Messrs. Paul & Son, Cheshunt, sent a plant of Strawberry Pauline, which was figured in this Journal three years ago. Messrs. J. Veitch & Son, Chelsea, sent several varieties of Early Milan Turnips, one named Extra Early

Milan being awarded a first-class certificate. It is of neat form, white, with a purple top, very even and solid.

FLORAL COMMITTEE.—George Wilson, Esq., in the chair. There were present Messrs. G. Henslow, J. Douglas, John Dominy, G. Duffield, John Fraser, H. Bennett, W. Bealby, Thos. Moore, W. B. Kellock, J. James, James Cutbush, Shirley Hibberd, James M'Intosh, James Hudson.

A gold Banksian medal was awarded to Messrs. Barr & Son, Covent Garden, for a most extensive and handsome collection of Poppies, Pyrethrums, Irises, and miscellaneous hardy flowers, arranged in what Mr. Barr terms "argillaceous vases"—i.e., blacking-bottles. The collection, which was one of the finest of the kind that has ever been staged, included a great number of species and varieties, representing a large proportion of the most beautiful in cultivation. A silver Banksian medal was awarded to Mr. T. S. Ware, Tottenham, for an interesting collection of hardy flowers in neat brown-glazed bottles. A large number of species and varieties were represented, of which a few only can be noted. *Armeria plantaginea rosea* and *rubra* were very pretty, with large globular heads of delicate and richly coloured flowers. *Papaver nudicaule* and its white variety were attractive; the lemon-yellow *Onosma taurica* and the purple *Aster alpinus* were similarly pleasing. The dark purple *Phyteuma betonicæfolia* and the rich rosy red and free *Lychnis viscaria splendens plena* being very notable. Lilies and Irises were in excellent condition, some of the best of the former being *L. Szovitzianum*, yellow; *L. elegans robustum*, *L. davuricum grandiflorum*, *L. pyrenaicum* and the variety *rubrum*, with *L. monadelphum* and *L. pomponium* were charming. *Cypripedium spectabile* was very fine, and *Campanula glomerata dahurica*, with dense heads of rich purple flowers, was magnificent.

Mr. B. S. Williams, Upper Holloway, contributed a beautiful group of Orchids and choice flowers, very notable being a plant of *Nepenthes excelsior* with seven grand pitchers, one 9 inches long like *N. Hookeri*, richly blotched with dark red. *Anguloa Ruckeri sanguinea*, red-spotted, and *A. Clowesi*, light yellow, were noteworthy amongst the Orchids; as were also *Cattleya Mossia alba marginata*, *Galeandra Devoniana*, *Cypripedium barbatum giganteum*, *C. superbiens*, and a fine plant of *Orchis foliosa* with seven fine spikes. Many other choice and new plants were comprised in this group, for which a silver medal was awarded. Messrs. John Laing & Co., Forest Hill, had two new and excellent double Tuberous Begonias, the flowers extremely large, full, and brightly coloured. *Dr. Duke* is bright scarlet, very handsome, and *Prince of Wales* dark rich scarlet. Mr. Coombs, gardener to Sir H. Meux, Bart., Sheen House, Mortlake, staged a group of seedling Coleuses, comprising several distinct orange-coloured varieties. Messrs. J. & J. Hayes, Edmonton, contributed a group of decorative Pelargoniums, all well flowered and well grown, and several were certificated.

Messrs. J. Carter & Co., High Holborn, sent nine baskets of Tropæolums, comprising many distinct varieties, the best being *Tom Thumb*; *Pearl*, pale yellow; *Ruby King*, rosy; *Spotted King*, yellow with maroon blotches; *Empress of India*, rich scarlet; *Lobbianum*, *Napoleon III.*, and *Queen Victoria*, pale yellow with crimson blotches. A vote of thanks was accorded for this exhibit. A vote of thanks was accorded to Mr. Stevens, gardener to W. Thompson, Esq., The Mount, Walton, Stone, Staffordshire, for *Odontoglossum Thompsoni*, a fine variety of the *Alexandra* type, white, with large rich chocolate blotches. A similar vote was also accorded to Messrs. Veitch for specimens of *Viburnum plicatum* with heads of pure white flowers, and specimens of *Indigofera decora alba* with long racemes of white flowers. Sir C. W. Strickland, Hildenley, Malton, sent a plant of *Lælia majalis* with four fine and deeply coloured flowers. Mr. Powell, Orchid grower to W. E. Brymer, Esq., Ilington House, Puddleton, Dorchester, was awarded a cultural commendation for very handsome specimens of *Cattleya Sanderiana*, with eleven fine flowers, the lip of great size and rich crimson, white in the throat.

From Chiswick came an extensive group of Pelargoniums, *Lantanas*, Tuberous Begonias, and *Gloxinias*, all exceedingly well grown, and tastefully arranged with *Adiantums*, *Panicum variegatum*, and plants of *Ionopsidium acaule*.

First-class certificates were awarded for the following plants:—

Acer polymorphum variegatum (Veitch).—A pretty variety, with finely cut leaves, green variegated with rose and white.

Acer crataegifolium variegatum (Veitch).—Leaf three-lobed, green marbled with white and rose.

Hydrangea rosea (Veitch).—A Japanese form of the *hortensis* type, with very rich rose-coloured flowers in dense heads.

Mimulus radicans (Veitch).—A peculiar little, prostrate, creeping plant, somewhat suggestive of *Lobelia littoralis* in habit. The leaves are a quarter to half an inch long, elliptical, brownish-green, rough and hairy. The flowers have three lower round white lobes, and two upper lanceolate purple ones.

Sarcopodium Dearii (Lieut.-Col. Dear, Englefield Green).—A very distinct Orchid; the upper sepal nearly an inch broad, ovate, semi-transparent, yellow, irregularly reticulated with dull purple; the lower sepals and petals of similar colour, and with a curiously hinged lip.

Rose Princess of Wales (Bennett, Shepperton).—One of the pedigree Tea varieties, very beautiful; the petals of great substance; the margins revolute; colour rosy yellow, varying in depth from nearly white to rich yellow and warm rose.

Pelargonium Dr. Masters (George, Putney Heath).—A seedling

hybrid of the Ivy-leaf section, but presenting a combination of the Ivy and Zonal types. The flowers are large in a bold truss, a peculiarly bright rosy magenta hue. The leaves are like the Zonals in form, but of the Ivy texture.

Pelargonium Fanny (Hayes).—A decorative variety, extremely free; the flowers blush pink, the upper petals blotched with rich crimson.

Pelargonium Garibaldi (Hayes).—Also one of the decorative type; rich scarlet, the upper petals almost black. This and the preceding were certificated by the Pelargonium Society.

Pelargonium Formosum (Hayes).—A decorative variety, bright clear scarlet, with a neat white margin; finely formed flowers.

Adiantum novæ-caledoniæ (W. & J. Birkenhead).—A distinct and pretty species with pedate fronds, the pinnules deeply cut.

Polystichum acrostichoides var. *grandiceps* (W. & J. Birkenhead).—Pinnules irregularly cut, apex tufted; dark green, distinct.

Lilium longiflorum (Wilson).—"The Easter Lily of Bermuda," over 4 feet high, with fine, large, pure white flowers, the petals revolute.

Tropæolum Lustrous (Dean).—A dwarf free-flowering variety, with neat brilliant scarlet flowers.

Cycas elegantissima (Williams).—A graceful species with long pinnate leaves; the pinnules dark green, narrow, tapering, and acute.

Special Prizes for Asparagus.—The competition was good in the classes for Asparagus, but considerable difference of opinion existed regarding the merits of the prize-winning exhibits. For eighty heads Mr. F. Cole, Colchester, was first with a bundle of stout white stems, some exceeding an inch in diameter, and about a foot in length. Mr. Allan, The Gardens, Gunton Park, Norwich, was second with smaller stems; and Mr. W. Speed, The Gardens, Penrhyn Castle, Bangor, North Wales, was third with irregular but enormous stems, one exceeding 1½ inch in diameter and 15 inches in length. Mr. T. Pitt, The Gardens, Bury Hill, Dorking, was fourth with much smaller stems, green about half the length, and by many persons this was preferred to the others. There were six competitors in this class. For fifty heads Mr. Allan was first, followed by Mr. C. Herrin, The Gardens, Chalfont Park, Gerrard's Cross; and Mr. J. Stewart, gardener to H. J. Barrett, Esq., Longford Park, Maldon, Essex, the last two having very neat stems. Four competitors. For 300 heads Mr. J. Harwood, Colchester, was first with large samples; Messrs. J. & M. Poupart, Kew, being second with smaller and greener heads.

SCIENTIFIC COMMITTEE.—Sir J. D. Hooker in the chair.

Carnivorous Habits of *Cyclobothra pulchella*.—Mr. W. G. Smith exhibited drawings to show how this flower catches minute insects by means of long hairs on the perianth. The inner leaves of the perianth close over the flower, and are provided with honey glands; but these are protected by long hairs, which detain the insects and appear to consume them, somewhat after the manner of the Sundew.

***Ocoidium* species.**—He also brought several instances of plants attacked by this fungus, which appears to be extremely common this year. They were sent by Mr. Plowright, Mr. Straker, and others—e.g., *O. rubellum* forming large circular spots on Rhubarb leaves. This appears to be identical with *Puccinia phragmites*. *O. Berberidis* on the wild and cultivated Barberry, as well as on *Mahonia aquifolia*. Mr. Murray said that he had found it on *B. Darwinii* as well. *O. Thesii* on *Thesium linifolium*, which was very abundant on Purley Common.

***Euplexia lucifera*.**—Mr. Pascoe showed this day-flying moth, the caterpillar of which attacks the roots of Ferns.

Seeds of *Xiphion*?—Dr. Lowe showed pink and white oval seeds, which were found on the grass. They were thought to be the seeds of a *Xiphion* or *Colechicum*. They were referred to Kew.

Disease on Melons.—The Hon. and Rev. Mr. Boscawen showed Melon leaves attacked by some fungus. Mr. Murray suggested it might be *Peronospora parasitica*, but it was too immature. He retained the specimen for report.

***Ampelopsis Veitchii*.**—Mr. Moore exhibited specimens of dead branches with curious red filamentous processes, soluble in water, and which appeared to be gum.

Apples Attacked by Caterpillars.—From Rev. C. R. Sowell of St. Austell came shoots of Apple trees, which Mr. Boscawen said he was familiar with, as attacked by small caterpillars. Mr. Smith remarked that similar appearances are produced by *Helminthosporium pyrorum*, but this fungus was not apparent on the specimens.

Japanese Varnish Plant.—*Rhus vernicifera* (?) A plant was sent by Sir C. Strickland.

Cabbages with Maggots.—Dr. M. T. Masters exhibited plants attacked by what appeared to be some species of *Lixus* (?)

Plants Exhibited.—*Sarcopodium Dearii*, probably new, from Lieut.-Col. Dear. It bore five orange-coloured blossoms, with the peculiar oscillating lip of the genus.

***Mimulus radicans*.**—A very pretty species, with white flowers and one purple petal, with leaves closely adpressed to the soil.

EVENING MEETING.

THE second evening meeting of the Royal Horticultural Society in the rooms of the Linnæan Society at Burlington House, Piccadilly, was held on Tuesday evening last, proving equally as successful and satisfactory as the previous one. The exhibits were even more numerous, beautiful, and interesting than on that occasion, a very bright display being formed by the collections of Orchids and hardy plants

shown. The former were especially brilliant and handsome, the rich colours of the Cattleyas appearing to excellent advantage under the gaslight. Very prominent were the collections from Kew and Cambridge, which included a large number of rarities and attractive plants. In the Kew collection the singular *Amorphophallus campanulatus* and the beautiful *Nymphaea stellata* var. *zanzibarensis*, both of which are noticed in another column, the flower of the former, however, had lost its foetid odour. Fine specimens of *Hoya campanulata*—recently figured in this Journal—the large-flowered orange-coloured *Crossandra undulæfolia*, the yellow and red trumpet-shaped *Datura sanguinea*, and a flower spike of *Agave Elemetiana*, about 9 feet high, were all notable in the collection, as was also a well-grown example of the bright *Impatiens Sultanii*. From Cambridge a very choice group of flowers was contributed by Mr. R. T. Lyneh, amongst the curiosities being flowering branches of the "North American Papaw," *Asimina triloba*, which is extremely rare in cultivation, and nowhere succeeds so well as at Cambridge, where there is a fine example of it. The charming *Peperomia resedæflora*, with its conical spikes of white flowers, the yellow *Candollea tetrandra*, the pink *Spiræa bella*, and many others were attractive. A pretty table of Orchids was also sent from Cambridge, including flowers of the yellow *Lycaste Deppei*, the peculiar *Pholidota imbricata*, the distinctly marked *Epidendrum prismatocarpum*, and the white *Calanthe veratrifolia*.

One of the features of the meeting was a beautiful bank of Orchid flowers from Mr. W. Lee, Downside, Leatherhead, which comprised some grand examples of *Odontoglossums*, superb Cattleyas, and bright *Masdevallias*, with fine spikes of *Epidendrum prismatocarpum*, and large flowers of *Anguloa Clowesi*. Sir Trevor Lawrence, Burford Lodge, Dorking, also sent an admirable collection of Orchid flowers, including *Cattleya superba*, *Dendrobium superbians*, *D. suavissimum*, *D. Deari*, *Stanhopea oculata*, *Anguloa Clowesi*, *Lælia purpurata*, *Odontoglossum cordatum*, and many others equally fine. J. H. Mangles, Esq., Valewood, Haslemere, contributed largely, having a large number of blooms of *Azalea indica alba* and *amœna* from plants grown in the open air for some years. Various *Rhododendrons* were also represented, such as *R. calophyllum*, *R. cinnabarinum*, the small-flowered *R. triflorum*, and the bright *R. javanicum*. Two paintings were also noteworthy, one of *R. grande*, by Miss Alice Mangles, and the other of *R. argenteum*, by Mrs. Whymper, both very faithful representations of flowers from plants at Valewood.

Mr. G. F. Wilson, Weybridge, had his fine specimen of *Lilium longiflorum*, which was certificated at Kensington the same day, together with the bright *Dianthus hispanicus*, Lilies, Irises, *Aquilegias*, and Alliums. Mr. G. Maw exhibited some choice hardy flowers, a spike of *Eremurus Olga* over 2 feet long being very notable, as were also the yellow-spotted *Lilium Hansonii*, *Thalictrum tuberosum*, and *Xiphium filifolium*. Mr. E. G. Loder, Floore Weedon, had a table of beautiful flowers, chiefly hardy species and varieties, Irises, Foxgloves, and *Aquilegias* predominating. Professor Foster, Cambridge, sent a number of young seedlings between *Iris variegata* and *I. pallida*. Mr. W. Weckham, Binsted Wyck, Hants, had some fine flowers of *Magnolia tripetala* and *Ixias*. The Rev. H. Ewbank, Ryde, had a collection of hardy plants; and Mr. Brown, Great Doods, Reigate, had a strangely fasciated seedling of *Escheveria secunda glauca*, which was like a *Cockscomb* inflorescence in form.

Messrs. Barr & Son, Covent Garden, staged a choice collection of Irises and *Pyrethrums* similar to those at Kensington; and Mr. T. S. Ware, Tottenham, had a large group of hardy flowers and Lilliums, including many choice varieties. Messrs. H. Cannell & Son, Swanley, had a large and beautiful collection of *Pelargonium* and *Verbena* flowers, including a great number of varieties.

The President of the Society, Lord Aberdare, took the chair shortly after 8 P.M., and then Dr. Masters commenced the proceedings by a few general remarks upon peculiarities of growth in Conifers at this season. He referred specially to the fact observable in some species that the terminal bud of the branches does not start until the buds below it have made some growth, while in others the terminal bud advances first. In the former case the bud scales are hard and resist the growth; in the latter they are soft and of a different texture. The peculiarity of the Silver Firs having a white appearance during the day and green towards evening was explained as due to the twisting of the leaves, the under side, upon which the majority of the stomata are found, being turned to the light in the day and reversed at night. Mention was also made of the gyration of Pine branches, Dr. Masters stating that he had observed them make two revolutions in twenty-four hours, the apex being directed successively to all points of the compass. Specimens of the strange *Pinus tuberculata* from California were also shown bearing numerous cones, which the lecturer stated never open unless the branch is killed or injured in some way, and that they remain permanently attached to the branches. The forest fires, however, often caused the liberation of the seeds, which are winged like those of other Conifers, and are then wafted to a considerable distance. At the conclusion of Dr. Masters' remarks it was stated that *Pinus pungens* has the same peculiarity of not opening its cones unless injured.

Mr. W. Goldring next read his paper upon *Cypripediums*, to illustrate which he had obtained a number of flowers representing the principal hardy and tropical species and their different types. He described at considerable length the characters of the genus and its closely allied relative *Selenipedium*, and referred also to the singular *Uropedium*, which has three stamens (or anthers) developed, two

lateral as in ordinary *Cypripedia*, and one beneath the stigma, which appeared to be specially concerned in the fertilisation. In the *Cypripedium* the third anther or stamen is converted into an expanded plate, termed the staminode, which varies in form—square, crescent shape, and triangular, and furnishes valuable characters for the determination of the species. The geographical distribution of the *Cypripediums* was discussed fully, and it was stated that much value should be attached to the particulars furnished by collectors concerning the habitat of plants as a guide to cultivators. The bardy terrestrial species were particularly referred to, the fact of the majority growing in swampy peat or moss being, the lecturer considered, often disregarded in cultivation; though there are also some of this group which are found on limestone and other formations—peculiarities that should be imitated as nearly as possible to ensure success. In regard to these “natural conditions” of growth, as they are termed, Sir Trevor Lawrence remarked that it was a fact patent to all cultivators that they often failed to prove successful under the artificial conditions of gardens, even when imitated as nearly as possible; and he gave several instances from his own experience, in which he had only induced plants to flower in much higher temperature and with considerably more moisture than they had in their native habitats.

Mr. G. Maw then read a long paper upon the geographical distribution of *Crocuses*, in which he minutely described the several districts in which the species were most abundant. He divided southern Europe into several districts to which some species were peculiar, the head-quarters being Asia Minor, Southern Russia, and the neighbourhood of the Black Sea. He remarked that although about seventy species were known, the majority of the forms most popular in gardens are derived from *C. vernus* and *C. aureus*, especially the former, both of which flowered in the spring months. A succession of flowers from autumn till spring could be maintained, but winter-flowering species require some protection or they were very likely to be injured by frost, snow, or rain.

The meeting was then adjourned by the Chairman, who was accorded a hearty vote of thanks.

THE MONIFIETH NURSERIES, DUNDEE.

THOSE who think that they have seen the more important towns of Scotland after “doing” Edinburgh, Glasgow, and perhaps Perth, Aberdeen, or even Inverness, have really left out perhaps the busiest and best situated, if not the biggest of them all. “Juteopolis,” as Dundee is termed in commercial circles, does an enormous trade in jute goods, as well as in those of linen, and not least, from a gardener’s view-point, in marmalade. As jute, flax, and Bitter Oranges are foreign productions, and as Dundee is by no means especially favoured in the matter of situation, it will be readily granted that she possesses a full share of enterprise when it is said that Dundee is the chief seat of these as well as of other industries—whale fishing for one—in the world.

Interesting as such facts are for the general public, it cannot be expected that a gardening paper can afford room for particulars on such. We, therefore, merely touch on these points as a prelude to what we have to say about Dundee horticulturally. As in other ways Dundee shows in this, too, a vigour all her own, or rivalled by Manchester alone. Nowhere in Scotland are horticultural exhibitions so well patronised by peer and peasant, by merchant-prince and mechanic, as in Dundee, and the result is a financial elasticity that is the envy of secretaries and committees of other horticultural societies situated in towns more pretentious, but not so forward in what is rightly regarded as indicative of advancing civilisation.

Round Dundee are thickly planted gardens that are worth being proud of, for the wealthy classes are liberal patrons of horticulture. And, as is only natural, round Dundee are to be found many nurseries showing that healthy life characterising nurseries in general situated in advancing commercial localities. At present it will not be possible for us to name more than one of these, but that one is perhaps the best specimen, and therefore worth mentioning first. The one referred to is that belonging to the long-established firm of Messrs. W. P. Laird & Sinclair, and is at

MONIFIETH,

which is situated near the estuary of the Tay, and is a station of the Dundee and Arbroath Joint Railway. The nurseries are about half a mile from the station, and lie at the east end of the pleasant little village. Monifieth is distant from Dundee five and a half miles. The entrance to the grounds is off the public road by a long straight approach, lined on each side with young specimens of *Conifers* in great variety, and plants at regular intervals of *Arundo conspicua*, which is similar in habit to the Pampas Grass, but it has the advantage of flowering earlier, and the plumes are, therefore, less liable to injury from early autumn frosts. At the back of the *Conifers* are several rows extending the whole length of the approach, of ornamental deciduous trees, which have a grand effect, and are well worth the attention of those furnishing with a view to pictorial effect.

At the end of the approach is a short flight of steps, over which is an archway covered with climbing *Roses*. This leads to the greenhouse and vineries. Of the latter there are four, each 60 feet long. In front of these is a sloping bank devoted to the growing of young ornate shrubs chiefly; and at the west division of this slope, in front

of the dwelling place of Mr. Sinclair, the resident partner, the ground to the extent of a little over a quarter of an acre is laid out in a manner at once ornamental, useful, and unique. It consists of a lawn on which have been cut a number of irregular figures, containing specimens of over 250 varieties of *Conifers*, Japanese plants, and other ornamental shrubs, all definitely labelled with botanical name and native country. Each specimen is allowed sufficient space to develop its character. The design and effect is good, and it has a peculiar fitness in being close to a nurseryman’s residence. It serves as a convenient trial ground for new introductions, and anyone interested in such a collection can easily inspect the plants and choose such as best suits their wants at any season.

After the havoc wrought by frost in recent winters I was agreeably surprised to see so far north a handsome pair of Sweet Bays (*Laurus nobilis*) upwards of 15 feet high, *Laurustinus* 5 feet high and about as much through, with traces still of an abundant inflorescence. Here, too, in full bloom, is the Himalayan *Rhododendron Thomsoni*. The colour is rich crimson, and the individual bloom comparable to *Lapageria rosea*; also *Arthrotaxus selaginoides*, a fine plant 5 feet high, and *Azalea amœna* have survived with very little injury the arctic winters lately experienced. *Desfontainia spinosa* and *Fabiana imbricata* on the wall, I was told, suffered more this season than they did during the severe winters of 1880 and 1881.

The well-stocked borders of herbaceous plants of many hundred varieties especially attracted attention. As elsewhere, the plants are all carefully and legibly labelled, so the visitors, whether chaperoned or not, may freely note what most pleases their taste. Of those in flower on the occasion of my visit in the first week in May the following may be noticed:—

Primulas denticulata, *viscosa* and *viscosa alba*, *ciliata*, and *ciliata purpurea*—the latter one of the finest of all *Primulas*, being of a rich purple colour and the flower finely formed—*scotica*, *marginata*, *rosea*, *McNabiana*, *platypetala* (Arthur Damolin), and *P. acaulis* Purity; *Sanguisorba canadensis*; *Anemone Robinsoniana*, *A. Pulsatilla*, *A. vernalis* (much resembling the preceding, but with the interior of the corolla whitish), *A. nemorosa*, fl.-pl. A bed of this 6 feet square was very attractive. Its neat habit and snowy whiteness of its flowers should secure it a place wherever spring flowers are loved. *Ranunculus amplexicaulis*, *Doronicum caucasicum*, *Fritillaria meleagris*, *Orobanchis vernus* and *v. albus*, *O. venosa*, *Trillium grandiflorum*, *Dodecatheon integrifolia*, *Arabis blepharophylla superba*, *Corydalis nobilis*, *Aubrietia Hendersonii*, *Draba aizoides*, *gigas*, and *ciliaris*, *Rhododendron Chamæcistus*, and in bright patches lighting up the whole, *Valeriana Phu aurea*.

Christmas *Roses* are here grown in quantity, especially *H. niger*, *H. niger majus*, and *H. purpurascens*, as well as a collection of the more recent hybrids. Of the last we were shown a dried bloom of *H. Commerzerath Benary*, which will yet be grown in every garden. To nothing can we so truly compare it as to a very large especially fine variety of *Odontoglossum Rossi majus*. In the nursery borders we observed extensive collections of fine named varieties of summer-flowering *Chrysanthemums*, *Delphiniums*, *Phloxes*, *Pentstemons*, *Pyrethrums*, *Potentillas*, double and single *Pinks* and *Carnations*, all of which must be a source of attraction as each of them in their respective seasons come into bloom. Among the *Narcissi* now attracting so much attention are many very fine varieties. *Horsfieldii*, *Emperor*, *Empress*, *rugilobus*, *moschatus*, *obvallaris*, *maximus*, *poeticus*, *Bulbocodium*, the true *minimus*, are well represented, as well as some of others newer still, which have been raised by Leeds and Nelson.

The whole nursery is divided into parallelograms, which give an orderly appearance and facilitate the working operations. It is well stocked with the general requirements of a nursery trade. Five to ten acres are devoted to evergreen and deciduous shrubs and *Conifers*, about an equal extent to the cultivation of ornamental trees, fruit trees, bushes, &c. A considerable extent is devoted to the forest tree trade, both in the seedling and transplanted stages, the firm being extensively engaged in supplying the large annual demand from the south for seedling Larch, Scotch Fir, Norway Spruce, &c., a department in which Scotch nurserymen are well known to excel. Apart from the climate being more favourable for the raising of seedling forest trees, it is generally allowed that there is a decided advantage in the transfer of them from a northern to a southern latitude. In this department Mr. Sinclair finds a certain rotation, which he named, of unusual benefit; and certainly it would be difficult, if not impossible, to surpass the sturdy vigour of the forest seedlings.

Messrs. Laird & Sinclair seem to have confidence in the future of the nursery trade, for six months ago they leased a piece of new ground as an extension of their present nurseries at Monifieth, several acres of which they have already filled with transplanted stock of the more useful *Pines*, *Firs*, and hardwood trees. The more ornamental department also shares their attention, for the firm possesses a considerable range of glass both at their Monifieth and also at their branch nursery at Broughty Ferry, where greenhouse and stove plants as well as bedding stuff are largely grown to supply the market in Dundee and its suburbs. The offices are all arranged for the proper packing and speedy dispatch of all goods. At Nethergate, Dundee, one of the principal thoroughfares, is carried out a large business in seeds, bulbs, implements, &c. Here the premises are large, commodious, and altogether well fitted for the purpose to which they are devoted.

In conclusion I wish to thank Mr. Sinclair for the instructive and kindly way he so readily imparted any information asked. The pleasure of walking through such well-kept, stocked, and arranged grounds was doubtfully enhanced by Mr. Sinclair's kindness.—VISITOR.

CHRYSANTHEMUM CORONARIUM FL.-PL.

CHRYSANTHEMUM CORONARIUM is a well-known hardy annual, which produces its bright golden-yellow flowers in great abundance during the summer months, rendering it one of the brightest occupants of the mixed border. It also claims to be historically interesting in a certain degree, for it is the oldest of the introduced species of Chrysanthemum in England. Though a European plant it is not of wide distribution, and is chiefly found in Sicily, whence we believe the first plants or seed brought to England were obtained—namely, about 1629, or over one hundred years before any other was introduced. A variety of this plant with double flowers—that is, with all the florets become strap-shaped instead of the central ones being tubular—has been in cultivation for some years, and to a fine type of this Mr. H. Cannell has given the name of Aurora. The woodcut represents a leaf and flowers from

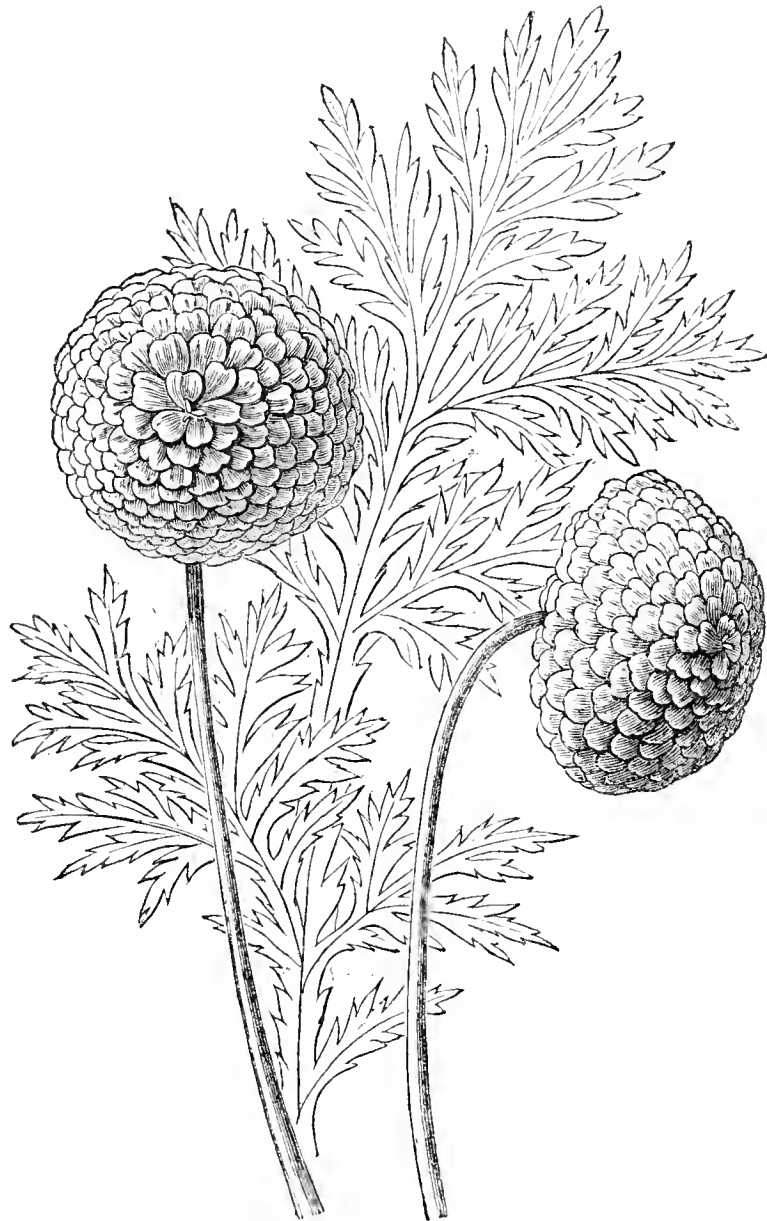

Fig. 114.—Chrysanthemum coronarium var. Aurora.

one of the Swanley plants, and faithfully shows the characters of the variety, the flower-heads being exceedingly neat in form, very regular, and rich golden yellow. They are very useful for cutting, as they last well in water, and are remarkably neat for arranging with other flowers in bouquets or vases. The plant can be readily increased from cuttings inserted in sandy soil in a cold frame, or by seeds sown under glass or out of doors. We have grown this variety for years, and have found it valuable both in the borders in summer and under glass during the winter and spring months.

ROYAL BOTANIC SOCIETY.

JUNE 13TH.

A LARGE and beautiful Show was held on Wednesday in the Botanic Gardens, Regent's Park, all the leading classes being well

filled, and the exhibits of satisfactory quality. The weather was exceedingly fine, and induced the attendance of a very large number of visitors.

Orchids.—A magnificent bank of Orchids was arranged on this occasion, the plants being numerous and many of them exceedingly well flowered. In the amateurs' class for twelve Mr. G. Catt, gardener to W. Cobb, Esq., Silverdale Lodge, Sydenham, was first with a grand collection, comprising Epidendrum prismatocarpum with eight spikes, Lælia purpurata with about twenty flowers, Thunia Marshallia with eight or nine spikes, Cypripedium Veitchii with fourteen flowers, Odontoglossum Alexandræ, five grand spikes; Dendrobium suavissimum, eight spikes; Cypripedium Parishii, nine flowers; Odontoglossum citrosimum, O. vexillarium, and Masdevallia Lindenii were also fine. Mr. Heims, gardener to F. A. Philbrick, Esq., Oldfield, Bickley, was a good second, Lælia purpurata being particularly fine, with twenty flowers. Mr. J. C. Salter, gardener to J. Southgate, Esq., Selborne, Streatham, was a close third. Dendrobium suavissimum, Cypripedium Stonei, and Cattleya gigas were the most notable plants in his collection. Messrs. J. Child, A. G. Catt, and J. Wiggins were the prizetakers in the amateurs' class for six plants, all staging good plants. In the nurserymen's class for twelve Mr. H. James, Castle Nursery, Lower Norwood, was first with a choice collection. Oncidium macranthum, Dendrobium Pierardii, and Odontoglossum cordatum aureum with five spikes were especially good. Messrs. Jackson & Son, Kingston, were second with smaller but healthy plants. Mr. James was also first with six similarly good and followed by Messrs. Jackson again.

Stove and Greenhouse Plants.—As usual these plants contributed largely to the beauty of the Show. Mr. Tudgey, Waltham Cross, gained chief honours in the open class for twelve specimen Erica ventricosa magnifica, E. Cavendishii and Azalea Criterion being in fine condition. Messrs. T. Jackson & Son were second, Azalea Grand Crimson, a mass of flowers; Francisca calycina major and Allamanda cathartica being the finest plants. Messrs. B. Peed & Son took the third position with neat specimens. Mr. J. Child, gardener to W. S. Bell, Esq., Garbrand Hall, Ewell, took the lead with six specimens, having several profusely flowered Azaleas, a good Erica depressa, and Statice profusa. Mr. C. Rann, gardener to J. Warren, Esq., Handcross Park, Crawley, followed, Apelexis macrantha rosea and Bougainvillea glabra being extremely well flowered. Mr. Hinnell, gardener to F. A. Davis, Esq., Anglesea House, Surbiton, was third. Messrs. T. Jackson & Son were placed first in the nurserymen's class for six plants, beautifully fresh and well flowered samples. Messrs. B. Peed & Son, Streatham, were second, and Mr. James third.

Fine-foliage Plants.—Several good collections of these were staged. Mr. James was first in the nurserymen's class for six with Theophastra imperialis, Cycas revoluta, and Pandanus Veitchii, very large amongst others. In the corresponding amateurs' class Mr. C. Rann was first with six, comprising two enormous Palms, Areca superba and Livistonia rotundifolia, Cycas revoluta, Crotons angustifolius and majesticus being well coloured, and Gleichenia Mendelli. Mr. R. Butler, gardener to H. H. Gibbs, Esq., St. Dunstan's Lodge, Regent's Park, was second with healthy plants of moderate size, Areca Baueri being very fine. Mr. Wheeler, gardener to Lady Goldsmid, St. John's Lodge, Regent's Park, was third, large Palms being the most noticeable.

Palms.—Mr. C. Rann was placed in the chief position with six grand specimens, but some were rather yellow, his Latania borbonica and Pritchardia pacifica were, however, very healthy. Mr. James was awarded second honours for large specimens, Stevensonia grandifolia being the finest. Mr. R. Butler followed with a creditable collection.

Ferns.—In the nurserymen's class for six plants Mr. Stevens, Putney, took first honours with very vigorous plants, Adiantum formosum and Alsophila excelsa being especially notable. Mr. James was a good second. Platycerium alcornone was large and fresh. Mr. Child won first honours in the amateurs' class with a most satisfactory collection, Davallia Mooreana, Phlebodium aureum, Adiantum farleyense, and Todea superba being in grand condition. Mr. Rann was second, and Mr. J. Wheeler third.

Pelargoniums.—Mr. C. Turner, Slough, took the lead with grandly flowered plants in the nurserymen's class for twelve show varieties, and was also first with six fancy varieties. Mr. Wiggins obtained a similar position in the amateurs' class for show varieties: and also had the best collection of six fancy varieties in the amateurs' class. Pilgrimage, Delicatum, and Roi des Fantaisies were especially good. Mr. W. Griffin, gardener to J. Wilcocks, Esq., Eliot Bank, Forest Hill, was placed third. For six Zonal varieties Mr. J. Weston, gardener to D. Martineau, Esq., Clapham Park, was first with fairly well-flowered plants. Mr. Wiggins, gardener to H. Little, Esq., Hillingdon Place, was second also with healthy plants.

Mr. J. Child was adjudged chief honours for twelve Tuberous Begonias, vigorous and freely flowered specimens. In the nurserymen's class Messrs. J. Laing & Co., Forest Hill, were adjudged the first honours for very handsome specimens, the flowers exceedingly large and richly coloured; Mr. H. Coppin, Shirley, Croydon, being placed second with smaller plants, but bearing very large flowers. Messrs. Weston and Wheeler were the prizetakers with six Fuchsias, both collections being strong and well flowered.

Cut flowers were very strongly shown. Messrs. Turner and J. Hollingworth, Turkey Mills, Maidstone; H. Hooper, Bath; W. Robins, gardener to A. Dyke Lee, Esq., Hartwell House, Aylesbury, were the

principal prizetakers for Roses. Messrs. Kelway & Sons, Langport, and Hooper, Covent Garden, for hardy flowers. Exotic flowers and Orchids being chiefly shown by Mr. A. Gibson, gardener to T. F. Burnaby-Atkins, Esq., Halstead Place, Sevenoaks; W. Jones, H. James, and E. Morse, Epsom.

Fruit.—The display of fruit was fairly good, the competition being keen in most of the classes. Grapes were well shown, the chief prizes for black Grapes being taken by Mr. G. Aslett, gardener to C. Butler, Esq., Warren Wood, Hatfield; Mr. C. Herrin, gardener to J. N. Hibbert, Esq., Chalfont Park, Slough; Mr. J. Bolton, gardener to W. Spottiswoode, Esq., Coombe Bank, Sevenoaks; Mr. W. Bates, gardener to J. E. Meek, Esq., Poulett Lodge, Twickenham, and Mr. M. W. Dixon, gardener to Sir S. M. Wilson, Searley, Uckfield. The principal prizewinners for white Grapes were Mr. E. P. Feist, gardener to R. Ashton, Esq., Bishopsgate House, Staines; Mr. A. Johnstone, gardener to the Marchioness of Camden, Bayham Abbey, Lamberhurst; and Mr. C. Herrin. Mr. Fry, The Gardens, Haydon Hall, Pinner; Mr. J. Newcomb, The Gardens, Park Wern, Swansea; and Mr. J. Harris, The Gardens, Singleton Abbey, Swansea, staged the winning Pine Apples—very fine fruits; Messrs. Hopkins, Holliday, and Goldsmith taking the prizes in that order for Melons. Peaches were of good colour but moderate size, Messrs. Robins and Bones having the best; Messrs. T. Rivers & Son, Sawbridgeworth, staging a collection of twelve dishes of Peaches and Nectarines, which were highly commended. Nectarines were good. Mr. Kemp, The Gardens, Albury Park, Mr. G. Holliday, gardener to J. Norris, Esq., Castle Hill, Bletchingly, and Mr. Bones were the prizetakers. Messrs. Goldsmith and Hickle, Lebanon House, Twickenham, were the chief exhibitors of Strawberries.

Mr. Fry, gardener to S. J. Baker, Esq., was first in the class for miscellaneous fruits with two good Pine Apples, Mr. S. Lyon, gardener to Sir E. H. Scott, Bart., Sundridge Park, Bromley, being second with a grand dish of Violette Hâtive Peaches.

Miscellaneous.—A great number of groups of plants were contributed by non-competing exhibitors, the four central groups being remarkably handsome. The following medals were awarded. Small silver-gilt medals to Messrs. Veitch & Sons, Chelsea, for a choice collection of new and rare stove and greenhouse plants very tastefully arranged; to Mr. B. S. Williams, Upper Holloway, for a magnificent group of Orchids, Ferns, and fine-foliage plants; to Messrs. J. Laing & Son, Forest Hill, for a bright group of Tuberos Begonias, Caladiums, Dracænas, and Palms; and to Mr. J. T. Peacock, Sudbury House, Hammersmith, for a most beautiful bank of Orchids, chiefly consisting of *Odontoglossum vexillarium*, with *Adiantum*, *Isolepis*, and small *Caladium argyrites*; a large silver medal to Mr. Ebbage, gardener to J. Bockett, Esq., Stamford Hill, for a fine group of Orchids, and a large bronze medal to Mr. J. Sutton for several specimen Orchids; a bronze medal to Messrs. H. Cannell & Sons, Swanley, for six stands of *Pelargonium* and *Verbena* flowers; a large bronze medal to Mr. H. Hooper, Bath, for collections of *Pyrethrum*s and *Pansies*; a large silver medal to Messrs. Barr & Son, Covent Garden, for an extensive collection of *Iris*s, *Pyrethrum*s, and hardy flowers; a large bronze medal to Messrs. Kelway & Son, Langport, for a handsome collection of *Pyrethrum*s single and double. A small silver medal to Messrs. Hooper & Co., Covent Garden, for collections of *Pyrethrum*s and *Iris*s. A large bronze medal to Messrs. Paul & Son, Cheshunt, for *Oleanders* and *Parqueritte* *Roses*. A certificate of merit to Messrs. J. Carter & Co., Forest Hill, for a collection of *Tropæolum*s. A large bronze medal to Mr. Wiggins for a collection of *Cattleya*s. A similar award to Mr. Salter for four fine specimens of *Utricularia montana*, well flowered; and a bronze medal to Mr. H. Heims for a group of *Cattleya*s.



[By the most skilful Cultivators in the several Departments.]

FRUIT FORCING.

Pines.—Young growing stock must at this season have particular attention in order to keep the plants vigorous and sturdy. In order to effect this the plants should be divided into two or three sections, as under ordinary arrangements it is impossible for the sake of appearance to give the plants the positions most suitable for them, the stronger-growing kinds coming in for the best positions—*i.e.*, that is the back rows, whilst the Queens, &c., from their dwarfer growth are placed in front. Now the Queens, to do them justice, should have a structure to themselves, Smooth Cayenne and Charlotte Rothschild being grown together. The taller section, as *Jamaicas*, *Enville*, *Montserrat*, *Prince Albert*, and *Black Prince*, should be placed together. Except for bottom heat little artificial heat will be required, the former being kept steady at 90°, for unless a genial warmth be maintained at the

roots the growth of Queens and similar tender kinds will not be satisfactory; besides, with a proper bottom heat a low night temperature occasionally will not be injurious or arrest the growth, but 70° at night should be the rule. Commence ventilating so soon as 80° is reached, and close at 85° to 90° from sun heat. Keep the house when it is closed well moistened, and sprinkle the plants overhead two or three times a week as the weather may dictate. Water the plants with regularity, only applying it when it is absolutely necessary, and then thoroughly. Continue giving every encouragement to fruiting plants.

Melons.—As delicious and cooling fruit Melons are deservedly esteemed. Frames and pits that have been cleared of bedding plants can be utilised for increasing the supply. A slight warmth afforded by a fermenting bed about a couple of feet high, the materials being well sweetened previously, will help the plants wonderfully, but the frames may be placed on a south border or other position where they will have the full sun, and a barrowful of soil placed in the centre of each light, forming it into a hillock, flattened in the centre so as to reduce the depth of soil there to a foot. It should be made firm. Keep the lights closed for a few days, which will warm the soil, and after pressing the soil firmly about the plants give a gentle watering. If the weather be bright shade for a few hours at midday until the plants become established. Very little water will be needed, as the plants have no bottom heat; indeed none beyond sprinkling the soil at closing time on fine afternoons will be necessary until the fruit is set and swelling freely. A little fresh soil should be added to the sides of the hillocks as the roots protrude. A little air should be given about 8 A.M. and increased with the heat, maintaining at from 80° to 90° during the day, closing at about 3.30 P.M. with plenty of atmospheric moisture, but avoid wetting the plants on the stems next to the collar, which must also be kept dry. Rub off all growths except four, training these to the back and front respectively, and do not allow laterals to form nearer the collar than 6 inches, and to prevent too crowded growth rub off every alternate lateral. Stop the leading shoots when a foot from their allotted space, commencing impregnating the flowers when three or four fruit blossoms on a plant are expanded, stopping the shoots at the same time one joint beyond the fruit.

In houses and pits with plants in various stages of growth, stopping, thinning, and otherwise regulating the shoots will require frequent attention. Houses in which the fruit is approaching maturity should be freely ventilated, and a rather warmer and somewhat drier atmosphere maintained, whilst in houses which have set and are swelling off their fruits the syringe should be employed freely twice a day in favourable weather.

Cucumbers.—Plants that have been producing fruit since spring will be greatly benefited by the application of a top-dressing of three parts lumpy loam and one part of thoroughly decomposed manure, giving the whole a thorough soaking with weak tepid liquid manure. Thin the shoots well, and remove as much of the old growth as can well be done without removing too much young growth, and re-arrange those retained. Syringe twice a day during bright sunny weather, and close early in the afternoon, so as to make the most of sun heat and economise fuel. Attend regularly to stopping, tying, thinning, and re-arranging the shoots, removing old growths as far as practicable, also misshapen fruit, avoiding overcropping as the greatest of evils. See that the plants do not suffer by want of water at the roots, but be careful not to give too much.

HARDY FRUIT GARDEN.

The thinning of Peaches, Nectarines, and Apricots is now nearly at an end. Assist the swelling fruit and wood growth, which now goes briskly on, by frequent watering at the roots, and keep the foliage clean by occasional syringing with clean water, taking especial care to direct the water well amongst the foliage, for it is upon the under side of the leaves that red spider most frequently becomes established. Figs are so abundant this year that a moderate thinning of the fruit is advisable. In doing this, branches fastened so closely that the fruit has not room enough to swell should be loosened, as much fruit is often spoilt by inattention to this matter. The fruit of many sorts of Pears is now sufficiently forward for thinning. Let this be done with judgment and moderation. Large kinds may have the clusters reduced to from one to three fruit, but such sorts as *Doyenné d'Été*, *Seckle*, *Dana's Hovey*, and *Winter Nelis* require very little thinning. The aim of an ordinary fruit-grower for table or market is to produce an abundant crop of fine, handsome, full-flavoured fruit, and not a few only of extraordinary size for the exhibition table.

Pay particular attention to all young fruit trees, stopping the young growth promptly where necessary, and training that which

is retained with due care. Remember that the young pliant growth may be trained to any required form with much facility, and in doing it now the foundation of a symmetrical handsome tree is begun, but too often this is neglected, hence the very numerous misshapen trees which disfigure so many of our best gardens. See that none suffer for want of water. Timely attention to this tends to promote free, strong, healthy growth, in this the golden season of the year. Caterpillars should be closely looked after on Gooseberry and Currant bushes, and also upon other fruit trees. All bush fruits may now be materially benefited by copious waterings.

PLANT HOUSES.

Stove.—Poinsettias.—Without delay a good batch of these plants should now be rooted. Select strong sturdy cuttings, which will make better plants and root more readily than those produced under shade and in strong heat. It is immaterial whether the cuttings are taken off with a heel or without. They are the best inserted in the centre of 3-inch pots in sandy loam, placing a little sand in the centre for the base of the cutting to rest upon. Water liberally after insertion, and place them in a close frame or under handlights, and keep them shaded from the sun until rooted. Bottom heat where applicable is beneficial, but it is not absolutely necessary. Plants rooted at once in the pots named will only require one shift afterwards into others 2 or 3 inches larger, and will make better plants than those rooted earlier.

Salvias.—Few plants that flower profusely during the autumn and winter are more easily grown and require less care than these. Cuttings root quickly and freely if placed in a little heat and shaded from the sun. The desired quantity may be inserted singly in small pots, and after the plants are rooted they should be pinched once or twice, hardened, and then planted in good soil outside. The points of the shoots should be pinched about once after they are planted out, which is all the attention needed until early autumn. The following are amongst the most useful—*S. splendens*, *S. Betheli*, *S. Heeri*, and *S. Gesneriæflora*.

Primulas.—Plants raised from seed sown early in the season and thoroughly established in small pots must without delay be placed in others 2 inches larger. In potting keep the plants well down, so that the soil will keep them firm at the collar; these plants when loose and shaking about in their pots are much more liable to injury through removing them from place to place and from damp in winter than when potted low. After potting place them in frames, and keep them close until root-action commences. These plants cannot endure strong sun, and if the frames can be arranged so that strong sun does not strike directly upon them, and shading can be dispensed with, so much the better. Transfer from pans into small pots those sown later. A little more seed may be sown, and the plants raised from it will be useful in spring for late flowering, or to bloom in very small pots. The double forms that have been rooted require similar treatment in every respect. Old plants that were flowering late and were earthed up with light soil—a reliable way of propagating the double varieties—will have formed quantities of roots round the collars, and should now be divided and potted singly. Any moderately light soil in which a liberal quantity of leaf soil has been intermixed suits these plants.

FLOWER GARDEN AND PLEASURE GROUND.

Arrangement of Carpet Beds.—Those beds filled with highly coloured dwarf plants, arranged in various figures, and known as carpet beds, still prove more attractive than those filled with the ordinary bedding plants. They certainly entail more labour, but from the commencement till the end of the season, whether the weather be wet or fine, the majority of the plants employed still retain their attractive colours. This cannot be said of no other style. Again, if the plants employed, more especially those forming the dividing lines and the groundwork, be judiciously selected, the same designs may be filled in with hardier, if less highly coloured, plants for the winter. It is a difficult matter to suggest designs for beds, as the latter vary greatly in shape, and besides the material in hand must be considered. Those new to the work, or who are unable to procure or originate a design or designs, may easily gain an idea from the many patterns on carpets, papers, embroidery, and book covers, which may be modified to suit the size and shape of the beds. In every case the beginner is warned not to attempt any complicated design, particularly those with intersecting figures or lines. Let every figure be well defined and separated from the others by spaces, or a groundwork at least 3 inches in width, yet the whole must form part of a settled plan. At the outset the beds should be well broken up and a quantity of leaf soil or old sifted fine potting soil be well

mixed with the soil, and the surface made level and firm. It should then be damped, the figures be traced out with the help of wooden compasses, rods, and lines, and the lines formed will be better preserved if marked with silver sand.

Supposing the beds to be slightly raised and faced with *Echeverias* as previously advised, in most cases a line of *Golden Pyrethrum* or a dwarf *Alternanthera* may well form an inner fringe to these. The *Pyrethrum* is still unsurpassed for marking the lines, as the plants are easily raised, may be dibbled in, are bright in colour, may be kept closely pinched, and are very hardy. In case these are not available in sufficient numbers and such plants as *Alternantheras* that require to be planted with a trowel, the groundwork should be first filled in, taking care to closely follow the lines, and this will admit of the figures being easily filled. *Sedum glaucum* is still one of the hardiest and most effective plants for forming the groundwork, and of green plants for the same purpose, *Sedum Lydium*, *Herniaria glabra*, and *Mentha Pulegium gibraltarica* are most suitable. All should be freely divided, and if small pieces are rather thickly pressed into the soil they will become established, and spread more quickly and evenly than if planted in large patches. They should be pressed into the ground and watered occasionally, and afterwards be prevented from encroaching on the lines of less robust plants. Moderate-sized plants of *Cordyline indivisa*, *C. australis*, *Dracæna congesta*, *D. terminalis*, *Yucca filamentosa*, *Pandanus Veitchii*, *Agave americana variegata*, *Grevillea robusta* in 6-inch or 8-inch pots may form the central plants in different figures or the centre of a small design; while such plants as *Chamæpeuce diacantha* and *C. Cassabonæ*, *Echeveria metallica*, *Pachyphiton bracteosum*, and other succulents may be planted singly or in groups in other figures. *Kleinia repens* is a very effective bedding succulent, and these may be dibbled-in thickly in lines, or, better still, in groups, and surrounded by *Golden Pyrethrum*, yellow *Alternantheras*, or *Mesembryanthemums*. The latter forms a good groundwork in which to dot plants of *Echeveria metallica*, and so also does *Sedum acre elegans*. Dwarf varieties of blue *Lobelias*, and which are best propagated by division or cuttings, form a pretty groundwork for *Chamæpeuce diacantha* and *Pandanus Veitchii*, and so also does *Isolepis gracilis*. The latter should be freely divided and dibbled-in thickly, especially if it is to form a line, for which purpose it is also suitable. *Iresine Lindenii*, if not too large, is suitable for filling-in central figures, and contrasts well with *Lobelias* and yellowish *Alternantheras*. *Alternanthera magnifica* is very bright in colour, and is probably the best of the species. It grows freely, and is most suitable for the centres. The richly coloured *Alternanthera amoena spectabile* is very effective either for masses or when dotted among *Sedum acre elegans*. The yellow *Alternanthera paronychioides aurea* is very useful, and *Oxalis corniculata rubra*, with its yellow flowers, is, though weedy, frequently much admired. Several *Sempervivums*, including *S. tabulæformæ* and *S. californicum*, are well adapted for dotting near the outer edge or for covering artificial slopes. Mixtures of *Echeveria secunda glauca*, with *Sedum Lydium* or *Mentha*, and *Sempervivum californicum* with *Sedum glaucum*, are very pretty, especially when forming corner mounds in a design, with perhaps a neat central plant of some other kind. *Pelargoniums Robert Fish*, *Mrs. Mappin*, and *Distinction*, and *Ageratum Cannell's Dwarf* are also available for carpet beds, the former in most instances requiring to be pegged down.

THE BEE-KEEPER.

REMOVING STOCKS.

WE have, during the latter part of April and the first half of May, been carrying out some experiments with stocks of bees in the way of removing them *en masse* from one part of a garden to another. But not only was our object to get them to a different place in the garden, but also to place them in a newly erected beehive with the least possible waste of bee life. As our success has been quite equal to our expectations, an account of the manner in which we went to work may be interesting, and perhaps give some useful hints to those who, like ourselves, may wish to remove a number of stocks at a critical time of year. We must first say why we wished to get our colonies into a bee-shed. Where shelter from high winds and driving storms, and a certain amount of shade in the height of summer, are obtainable by natural means we would not advocate the exclusive use of a closed shed. But we were

situated at a great disadvantage by having newly-planted premises, and by being exposed to the gales and driving rains from the south-west. These sweeping over miles of open moorland caused us great annoyance and much trouble, taking the roofs off our hives unless heavily weighted and secured, and causing the water to be driven through the smallest aperture—a veritable damper both to the bees and to our own energies.

Under these circumstances a bee-shed was decided on, and after thinking well over the matter we decided to place on brick footings a strong wooden erection, well soaked with boiling tar in which sulphate of zinc was dissolved. The roof was made steep and deeply thatched with heather with well-overhanging eaves. Rafters thrown across support a platform overhead where all kinds of apparatus can be stored away dry and warm. The house is square, and will, when full, contain thirty-six hives in two tiers. Flaps which can be opened wide in summer and closed tightly in rough weather, and in winter leaving only a slit for entrance, are hung on strong butts, two on each of the four sides of the house. A window slung on pivots on the south-east side, and a similar fanlight over the door, give ample light. The shelves to receive the hives are made of tongue and grooved well-seasoned deals an inch thick, and floor-boards may be dispensed with if we wish, as will also the heavy covers of the bar-framed hives.

We shall still continue to make our hive boxes as described in the Journal last winter. We formerly kept some of our hives in a shed and some out of doors under shelter of a high hedge; and although there are some objections to bee-sheds there are many points which can be urged in their favour, and some of our best stocks in former days we kept under cover. Well, our shed was ready early in May, and we had for the last fortnight been carrying out our plan of removal. We wished to have all our stocks housed before taking swarms. There were seven stocks to be got into the house, and they stood in two rows, four and three, some 5 yards apart both ways. We commenced by moving every hive about 2 yards towards the house, both lines advancing together. Many bees flew about the spots from which the hives were removed on the following morning, but all soon discovered their respective hives and not a bee was lost.

Every alternate night after all bees had returned home we continued the same plan, advancing every hive an equal distance and keeping the same order in the two rows. After some eight or ten removals the advanced rank reached the position on a line with the front of the shed, and now a corner was to be turned, as we wished to people the lower shelf on the south side of the house first, and the bees had been advancing from the north side of it. There was no doubt that the order in which the hives stood and which had not been changed up to this time had assisted the bees in quickly settling down to their new positions after each advance. But this order must now be broken, and the squadron extend into single line on their advance to their respective positions.

In order to assist the bees we now employed a distinctive mark for each hive. On the cover of one we tacked a sheet of white calico, on a second a strip of oilcloth, painted blue; on a third we laid some bright red tiles, &c. When the bees had become accustomed to these decorations we proceeded cautiously to elongate the line, turning the corner of the house with the first hive of the front row, and each night following on until the four were in position along the east side of the shed. The three forming the back row then advanced together until they stood in the same straight line with the four and all parallel with the east side of the house. During these advances we were careful to watch the effect on the bees. They left the hives each morning, for the weather was very fine throughout, without apparently marking any change in their positions. When they first returned they showed signs of bewilderment, settling with their loads of pollen on the spots from which the hives had been removed. This would show that a bee does not mark his hive entirely by its appearance. Surely some as yet unexplained power is possessed by her which directs her straight to the spot where she has been accustomed to enter. We cannot explain what this extraordinary homing faculty is. It is not altogether attributable to sight or scent, for either of these senses would have directed the bee at once to the entrance of the well-marked hive which had only been moved 5 or 6 feet. Most of the incoming labourers rested on the old spot, and after a few seconds again mounted into the air and seemed to be taking notice of the removal and fresh bearings to guide them in the future. The one and all ultimately entered the right hive. The only loss was that of a little time spent in finding and marking the new position. By gradual removals the extended line was now turned round the south-east corner, and the first four hives alternately gained the exact position in front of the lower flap behind which they would permanently stand. As each gained its place it was removed the same evening inside the house, and so placed on the platform that

its floor-board projected well over the flight-board. Its distinctive mark, whether white, blue, red, or whatever it might be, was fastened over the flap, so as conspicuously to mark the place of entrance. Everything happened as before; the bees settled on the ground in front of the entrance, but soon mounted, and after the usual survey entered the proper aperture. Hive after hive was treated in the same way. All are now safely located, excepting two, which will be taken in to-day and to-morrow.

We noted that after the first few hours of each day the bees seemed all to have marked their new quarters, and the work of the hive went on as if nothing had happened. Two hives would have swarmed during the operations, but by abstracting brood and giving extra room we managed to delay this event. It is now our intention to take two strong swarms of equal weight, headed by queens of the same age, and to all appearance of equal fertility. We shall endeavour to give both swarms the same amount of care and encouragement in every way save one. Mr. Pettigrew believes that bees will build comb from food or collected honey as quickly without as with foundation. We intend to provide one swarm with full sheets of foundation and to give only strips as guides to the other. We know that an exact account of the progress of these hives will be acceptable to many, and we shall take constant notes and weighings in order to prove what to us is a foregone conclusion—viz., the great utility and saving of honey and time foundation is to bees and bee-master.—P. H. P.

TRADE CATALOGUES RECEIVED.

Thomas S. Ware, Tottenham.—*Catalogues of Single and Double Dahlias, Choice Hardy Perennials, and Florists' Flowers.*

Kane, Kells, Meath.—*List of Bedding Plants.*

Charles Leicester, Crompton Road, Macclesfield.—*Catalogue of Gooseberries, Fruit Trees, Florists' Flowers, and Miscellaneous Plants.*



* * All correspondence should be directed either to "The Editor" or to "The Publisher." Letters addressed to Dr. Hogg or members of the staff often remain unopened unavoidably. We request that no one will write privately to any of our correspondents, as doing so subjects them to unjustifiable trouble and expense.

Correspondents should not mix up on the same sheet questions relating to Gardening and those on Poultry and Bee subjects, and should never send more than two or three questions at once. All articles intended for insertion should be written on one side of the paper only. We cannot reply to questions through the post, and we do not undertake to return rejected communications.

A Mushroom Farm (*H. C., Sheffield*).—You will find your question fully answered in the work on Mushrooms, which you have by this time received.

Repotting Peach Tree—Horn Shavings (*R. H. R.*).—We cannot reply to your letter so fully as is desirable until next week.

Horticultural Shows (*E. M.*).—We are greatly obliged by your letter containing corrections, suggestions, and additions, all of which shall have the attention they merit.

Tomatoes (*W. Hawley*).—We are glad our advice to you proved useful. The fruits you have sent are very fine indeed and most creditable to the cultivator, but the variety is certainly not Vick's Criterion.

Correspondence (*A. Hunt*).—A postcard was sent to you to 27, King Street, Covent Garden, the address given at the head of your letter, but it has been returned to us. If you will send your proper address we will communicate with you.

Roses for Market (*W. S.*).—Without some more definite particulars as to the date when the article appeared we cannot give the precise information you require; but in addition to Isabella Sprunt the useful variety Niphotos should be tried, as that is grown in large quantities in some market gardens, particularly at Mr. Ladd's of Bexley Heath. Madame Falcot is also a favourite for buttonholes.

The Manna Ash (*E. K.*).—*Fraxinus Ornus* (*Ornus europaea*), the Flowering or Manna Ash, is a native of Italy and Sicily, and from this and *F. rotundifolia* the substance termed manna is obtained. It is the concrete juice of both these trees which exudes after wounding the bark. Manna is a gentle tonic, usually mild, but in some cases producing flatulence and pain.

Orange Fungus on Roses (*J. P. T.*).—Your Roses are attacked by this destructive parasite. Relative to its extirpation we have nothing to add to a reply we gave on page 481 last week to "W. H. W.," except that if the remedies there suggested fail you might try the application of sulphur prepared as described by Mr. Iggulden on the page quoted in our reply to "G. L." Apply liquid manure to the roots of your Roses copiously.

White Pink (*T. Bush*).—We have grown the variety you have sent, but do

not know its name. Perhaps it never had a name. It is more solid and compact than the old white Pink, with broader and less deeply serrated petals. It used to be plentiful in some districts thirty years ago, but it is by no means generally cultivated in gardens. It is a very useful border plant, but not equal in merit to the purer and smoother Mrs. Sinkins, which received the award of a first-class certificate of the Royal Horticultural Society, when it was exhibited by Mr. Charles Turner three years ago.

Mildew on Vines (G. L.).—You will find an article on this subject on page 376, the issue of the 10th ult., which you will do well to peruse. The writer there states he found Ewing's mildew composition to answer its purpose admirably. You will find the best method of preparing sulphur for destroying mildew and red spider on page 496 of the present issue. Mildew is much more prevalent in some districts than in others, and a close moist atmosphere is favourable to its increase. Ventilate the house freely, and especially very early in the morning.

Removing Manure from Vine Border (Idem).—You had better proceed cautiously in this matter, as it is not improbable the material has encouraged the production of roots at or near the surface of the border, and to remove the whole of it and fork the soil would almost inevitably result in great injury to the Vines. You might, perhaps, with advantage remove some of the manure, but how much we cannot say, as that depends on its thickness and the condition of the roots of the Vines. Your guide must be this: If there are roots near the surface preserve them by keeping the soil moist, and not kill them by exposing it to the drying action of a burning sun.

Double Pyrethrums (Maria).—The easiest method of increasing the plants is by offsets. They may be taken up any time after flowering and divided, choosing dull moist weather for the operation. The rooted portions may be planted a foot apart in light rich soil, and the unrooted pieces inserted in sandy soil in pots and placed in a frame or under a handlight, affording the requisite shade and moisture for keeping them fresh until roots are emitted, when air must be gradually admitted, preparatory to the full exposure of the plants. Those planted out must also be watered as needed. Strong rooted portions inserted now and well tended during the season will make good plants that will flower freely next year. They are highly effective border plants, and succeed in any ordinary fertile soil in town or country gardens. Some plants that have flowered freely do not produce offsets till the autumn.

Duchess of Albany Pelargonium (J. Lewis).—This new variety, of which you have sent a flower, belongs to what is called the Regal section, or show decorative type. The flower was shaken in transit, and we can only say that it is rich in colour—crimson-scarlet with maroon blotches on the upper petals. We are not at all certain that a first-class certificate would be granted for the variety if a plant were exhibited before the Floral Committee of the Royal Horticultural Society. If you wish to exhibit it at South Kensington write to Mr. Barron, Royal Horticultural Society's Gardens, Chiswick, London, and he will inform you how to proceed.

A Quartett of Choice Garden Pinks (Amateur).—You are quite right; we did refer to four good Pinks last year, and as you would "like the particulars" this is what we said about the varieties:—"Mr. Ware has sent us from Tottenham a quartett of garden Pinks, which are worthy of a place in all hardy flower borders. Lord Lyons is large, smooth, rich deep pink in colour, and very fragrant, the flowers being produced with great freedom. Ascot is an upright grower, colour delicate pink with maroon centre, free; and Mrs. Sinkins is the finest of all the white Pinks, being very large, very free, and very sweet. Ware's Clove Pink is a small much-fringed flower, deep pink in colour, and powerfully and deliciously fragrant. Both for producing an excellent effect in the garden, and for affording a supply of acceptable cut flowers, these useful Pinks should be grown everywhere."

Pyrethrums and Honeysuckles from Cuttings (Keswick).—Cuttings of these plants strike freely in pots of sandy soil kept constantly moist and placed in a close frame in the summer, or in a heated frame or pit in the spring. The growths when 3 or 4 inches long are thinned-out and made into cuttings. These growths can generally be well spared, and those remaining produce finer flowers. Each cutting, if it is not stopped, produces one flower the same season, and also forms growth at the base for another year's blooms; it is advisable, however, to sacrifice a small flower and make a strong plant. The cuttings must not remain in heat a day after they commence rooting. Cuttings of the Trumpet Honeysuckle made when the wood is getting firm, and inserted in sandy soil under a handlight, will strike freely. Young shoots will also strike in a warm propagating house, and portions of ripened wood will grow inserted in a shady border in September.

Asparagus Failing (J. H.).—The present dry season has been very unfavourable for newly planted Asparagus, and the older the plants were the more liable they would be to fail to grow; indeed if the roots were dry on arrival a large per-centage of them would almost inevitably die. We have known salt to injure Asparagus when it has been given too liberally, and it is far more likely to do injury in dry than in wet weather. It is impossible for us to say whether salt has "bad anything to do with the failure in the present case," as you do not state the quantity that was applied to a given surface of beds; but we suspect dry weather has contributed mainly to the loss of the plants, and it would have been well if the surface of the soil had been covered with short manure for preventing the evaporation of moisture from the earth.

Bouquets of Roses (Hut).—We doubt if the Secretary of the National Rose Society would consider it within his province to indicate to intending exhibitors how they should make bouquets, and how many blooms they should include in each for exhibiting at Sheffield. All rosarians know how willing Mr. D'Ombra is to give advice that may be useful relative to Roses and exhibiting them, but he must draw the line somewhere. We have no assurance that he would venture so far as to say whether the twelve and six bouquets should consist each of one variety of Rose, or be arranged in mixture. It is customary in offering prizes for bouquets to encourage individual taste in arrangement, in order that even directors of shows and judges, as well as the public, may derive a lesson in the attractive association of flowers. The stipulation of bouquets "for the hand" sufficiently denotes that they must not be grouped in boxes of moss, but exhibited in separate appropriate receptacles. Many bouquets of Roses are too "lumpy," and consist of too many varieties of too large flowers. They are, in fact, not infrequently the disappointing feature of a Rose show, and the offer of the prizes in question, in our view, constitutes an appeal to individuals to show a more excellent way of grouping Roses as hand bouquets than at present generally obtains at exhibitions. Our columns are open to those who may desire to give information on this subject.

Stopping Vine Laterals (J. W., Isle of Wight).—The gentleman who told you that you had done wrong by stopping the laterals so soon, and that "they ought not to be stopped till the fruit is set and the growths are 5 or

6 feet long," has something to learn on Vine-dressing. Instead of stopping them too soon you did not remove the points beyond the bunches soon enough, as you say you "never stop the shoots till they are 2 to 3 feet long." The established practice of the best gardeners is to take out the points of the shoots with the thumb and finger immediately from one to three leaves have formed beyond the bunches, the length of the lateral being governed entirely by the space between the Vines. If there is only space for one leaf to develop, only one is left; if there is room for two to expand without crowding, two are retained, and so on. Usually there is space for two leaves, and there ought to be. Suppose there is, then as soon as two are formed, and before the second is as large as a shilling, the point of the shoot is nipped off, and the sub-laterals that follow are nipped off at one leaf before it exceeds the size of a sixpence, and the practice is pursued throughout the season. The process of stopping is illustrated on page 81 of Mr. Barron's work on the Vine, and this work you might appropriately recommend the gentleman to purchase. It could scarcely fail to be of great service to him, and through him—in his capacity of adviser—to others who may not be able to purchase the book for themselves. The gentleman may be quite right in saying that the "leaves of your Vines are not large enough." On this point we have no means of judging, as you have neither sent an example nor indicated the size of the foliage; but this we know—that overcrowding the growths contributes directly to small and undeveloped leaves, weak Vines, and inferior crops of fruit.

Cucumbers Unhealthy—Non-Ventilation (C. H.).—Are you quite sure the roots are not dry at the bottom of the bed immediately over the bot-air chamber? We are inclined to think they are, or have been. Although we have seen Cucumbers grown without ventilation other than that afforded by laps in the glass, we are not able to advise the adoption of the practice by everyone. Numbers of persons would not supply anything like the requisite supply of moisture for insuring success, and they would be too prone to open the doors too often to "see how the plants are getting on" to be good for the crop. Until a person can comprehend the reason why there should be danger in opening the doors too often he had better adhere to the orthodox method of culture with ventilation, especially as crops of the most satisfactory kind are obtained by this practice. The circumstance that many of the fruits refuse to swell but shrivel at the point is indicative of imperfect fertilisation—that is, unless they are unfortunately overtaken with the very serious disease to which they are liable; but in this case the leaves do not necessarily turn yellow. They flag and wither, however, if attacked with disease at their roots in the form of small tubercles or excrescences. You had better examine them, and if you find no signs of attack there we advise you to use water more copiously. Give liquid manure, and mulch the surface of the bed with rough rich food; and you had better also consider the advisability of abandoning the practice of attempting to grow them without ventilation—not because that system is wrong in itself, but because you fail in some way unknown to us in carrying it out successfully.

Melon Plants Gumming (T. W.).—The cause of gumming or gangrening is an over-abundant supply of nutriment afforded the plants by their roots, and is very different from canker at the collar and in the stems. Quicklime rubbed into the parts affected with canker will arrest its progress provided the conditions that cause it be removed—viz., too moist and close an atmosphere; but lime is of no value in stopping the gumming, as it is internal, and cannot be reached by any outward application. The soil, in the first instance, is too rich and is kept too moist. Turfy loam laid up until the grass is killed is a material quite rich enough without any addition of manure, and it can hardly be put together too firmly, so as to induce sturdy, short-jointed, fruitful growth. If inclined to be heavy all the better, but light loam made firm will grow Melons well, only more frequent waterings are necessary, as it is not so retentive of moisture as the stronger soil. Lime rubbish is not necessary, as for light soil it only makes the mass more porous and increases the necessity for water, thus aggravating the evil. Plants that show a tendency to gum should be kept dry at the roots, no more water being given than will prevent flagging; and if the gumming be excessive shading must be resorted to for a few hours in the middle of the day, so as to lessen the necessity for water in order to prevent flagging. The atmosphere must be kept drier and warmer, so as to allow of freer ventilation, which will cause more rapid evaporation and enable the plants to part with the superfluous moisture. Gumming is, however, better avoided than remedied. The soil should not be kept very wet in the early stages of growth; indeed no more water should be given than to keep the plants in steady progressive growth until the fruit is set and swelling, when copious supplies will be necessary. Encouraging a free growth in the plants in the early stages and up to the fruiting stage, and afterwards keeping the growths closely restricted, is likely to induce gumming, as are also large reductions of growth at one time and at distant intervals. If you follow Mr. Iggulden's instructions you will succeed.

Grafting Vines (Kaffir).—We are not able to state the precise time for grafting your Vines, as the season of growth in South Africa is different from that in England; and, moreover, the condition of the stocks wherever they are situated is of far greater importance than any mere date of the calendar. Undoubtedly the safest and best mode of changing the varieties in Vines is by inarching, either on the old or young wood; but in your case this method may be impracticable, inasmuch as you may not have Vines in pots for attaching to the stocks. If the work is done on the old wood in spring Vines in pots are not requisite, as if grafts of ripe wood a foot long or more are sliced in the middle to the extent of 5 or 6 inches and attached to the stocks from which corresponding slices have been taken, the lower end of the scions being inserted in bottles of water, this will support them until the union is complete, and the original Vines can be gradually headed down. We presume your Vines are growing in the open air, in which case the bottles could be stood on the ground or partially sunk in it, and the scions attached to the main stems at any convenient part, or they may be affixed to the lowest lateral of young wood. As your Vines are young and healthy you might safely inarch to the main stems. The slicing should be done rather deeply—almost down to the pith of the scion, and carefully fitted to the stock and secured with tape or matting, no clay nor grafting wax being required. The time for performing the operation is just when the Vines are starting into growth, the scions being a little later, for insuring which they must be taken off in the winter and stored in damp soil in a cool position. Vines can be headed down and grafted, but with by no means the same safety and certainty as in grafting Apples or Pears. If the Vines were cut down in winter or early spring, as in the case of those fruits, there would be such a flow of sap that no grafting wax could arrest, and the grafts would be flooded. The time for cutting down the Vines is after they have made some growth, such as about the flowering stage. Mr. Barron in his practical work, which you should read, says:—"A very good test for ascertaining the exact period we have found to be this—Take the point of a knife, and just prick through the bark; if a little moisture exudes, the stock is in condition for the graft; if there is none, it is too late to attempt it; but should it happen that there is a great flow, continuing for some days, do not attempt to graft so

as to ent the stock any more until th's flow has somewhat subsided. This pricking will not, from the smallness of the incision, do much harm to the plant, but injury would assuredly result were the cut to be enlarged, as would be required in grafting; while from the amount of bleeding and the presence of extravasated sap the union could not, under such circumstances, take place." The scion must be much later than the stock. The method of securing the grafts is illustrated in the work just referred to, and reproduced in this Journal on page 181, March 1st, 1883.

Transplanting Fruit Trees (Idem).—If the trees are young, healthy, and well rooted, and the season is conducive to their free growth, they may be grafted the spring following the autumn in which they were planted; it is customary, however, not to graft transplanted trees until the second year after their removal. The question can only be rightly decided by the condition of the trees. In reference to your last question you cannot do better than write to Messrs. Lejeune & Perken, 24, Hatton Garden, London, and state your requirements. We think they will be able to supply you with what you need.

Names of Plants (A. H.).—Although the specimens were not numbered, you will know to which the names refer. *Pinguicula vulgaris* (Butterwort), the succulent alpine; *Pedicularis sylvestris*, common Lousewort; *Polygala vulgaris*, common Milkwort. This plant varies very much in colour from the most intense blue to almost pure white. It is common in many places, but we never saw it more plentiful than on the Wiltshire Downs a short time back in all its various shades of colour. (*L. B.*)—*Carex paludosa*, Marsh Sedge; the specimen with yellow flowers is *Gemm urbanum*, yellow Avena or Herb Bennet. (*D. T.*)—1, *Papaver nudicaule*; 2, *Chelidonium majus*; 3, *Funkia undulata variegata*; 4, insufficient. (*W. J.*)—*Streptocarpus biflorus*. (*Rev. A. K.*)—1, *Dendrobium Parishii*; 2, *Maxillaria tennifolia*. (*W. C. Kippax*)—1, *Pavia flava*; 2, *Ptelia trifoliata*; 3, *Potentilla anserina*; 4, *Alopecurus pratensis*; 5, *Melica*; 6, *Anthoxanthum odoratum*. (*X. F. Z.*)—*Cerasus Padus*, the Bird Cherry, which can be obtained of any of the principal nurserymen who make a speciality of trees and shrubs. (*J. G.*)—The fleshy-leaved plant is a very healthy example of *Kleinia repens*; the other *Alternanthera magnifica*. (*E. K.*)—*Fraxinus Ornus*, the Manna Ash; see reply above.

COVENT GARDEN MARKET.—JUNE 13TH.

OUR market has been well supplied with all classes of goods, and prices generally have been easier. Outdoor Strawberries being backward, house fruit have well maintained their value.

FRUIT.

	s.	d.	s.	d.		s.	d.	s.	d.		
Apples.....	½ sieve	2	0	7	0	Grapes	lb.	2	0	6	0
".....	per barrel	20	0	40	0	Lemons.....	case	10	0	20	0
Apricots.....	box	2	0	2	6	Nectarines..	dozen	9	0	18	0
Cherries.....	½ sieve	0	0	0	0	Oranges	100	6	0	10	0
Chestnuts.....	bushel	0	0	0	0	Peaches	dozen	9	0	18	0
Currants, Black..	½ sieve	0	0	0	0	Pears, kitchen ..	dozen	0	0	0	0
" Red.....	½ sieve	0	0	0	0	dessert	dozen	0	0	0	0
Figs.....	dozen	4	0	6	0	Pine Apples, English	lb.	4	0	5	0
Filberts.....	lb.	0	0	0	0	Raspberries	lb.	0	0	0	0
Cobs.....	100 lb.	0	0	0	0	Strawberries	lb.	2	0	6	0
Gooseberries	½ sieve	3	6	4	6						

VEGETABLES.

	s.	d.	s.	d.		s.	d.	s.	d.		
Artichokes.....	dozen	2	0	4	0	Mushrooms	punnet	1	0	1	6
Asparagus, English	bundle	3	0	6	0	Mustard & Cress ..	punnet	0	2	0	3
Asparagus, French	bundle	2	0	0	0	Onions.....	bushel	2	6	3	6
Beans, Kidney	100	1	0	2	6	Parsley..... doz.	bunches	3	0	4	0
Beet, Red.....	dozen	1	0	2	0	Parsnips	dozen	1	0	2	0
Broccoli.....	bundle	0	9	1	6	Peas.....	quart	2	0	0	0
Cabbage.....	dozen	0	6	1	0	Potatoes, New	lb.	0	2	0	4
Capsicums.....	100	1	6	2	0	Potatoes.....	ewt.	6	0	10	6
Carrots.....	bunch	0	4	0	0	" Kidney.....	ewt.	6	0	10	0
Cauliflowers.....	dozen	2	0	3	0	Radishes.... doz.	bunches	1	0	0	0
Celery.....	bundle	1	6	2	0	Rhubarb.....	bundle	0	4	0	0
Coleworts....doz.	bunches	2	0	4	0	Salsafy.....	bundle	1	0	0	0
Cucumbers.....	each	0	4	0	6	Scorzoneria	bundle	1	6	0	0
Endive.....	dozen	1	0	2	0	Seakale.....	basket	0	0	0	0
Fennel.....	bunch	0	3	0	0	Shallots.....	lb.	0	3	0	0
Herbs.....	bunch	0	2	0	0	Spinach.....	bushel	2	6	3	0
Leeks.....	bunch	0	3	0	4	Tomatoes.....	lb.	1	0	0	0
Lettuces.....	score	1	0	1	6	Turnips.....	bunch	0	2	0	3



POULTRY AND PIGEON CHRONICLE.

HAY-SAVING BY MACHINERY.

(Continued from page 483.)

MR. NEILSON'S system, to which we have referred incidentally in the course of our observations, deserves to be fully explained, especially as he was the originator of the plan of securing hay by the use of the fan for exhaustion of heat in the stack, and thus keeping it under control. It is generally admitted by those who have adopted the system that it has answered their purpose, and that failures which may have occurred has been in consequence of neglect or ignorance of the details as stated by the originator, and sometimes by an attempt to improve upon it by expecting the exhaust fan to remove the water when the hay has been stacked whilst wet with rain.

Mr. Neilson's buildings were used as a double or single range of sheds upon the principle of what is commonly called the Dutch barn. The shed is a single-span iron harvesting shed 90 feet long by 20 feet wide by 14 feet high to eaves, for harvesting four stacks 20 feet by 20 feet. An underground pipe of earthenware is laid, so that it may be used for a single or double row of sheds or barns, from which branches connect the bosses or centres to each stack of 20 feet by 20 feet and the air vault under the exhaust fan at the end of the shed or sheds, because one is made to operate upon four or eight stacks as in the case of single or double row of sheds. There is a damper with rod to open or close at each boss or iron centre structure to each stack. Ventilators are also attached to the roof of the shed exactly over the centre of each stack. Where a number of stacks are built each in connection with one system of earthenware piping a powerful fan for steam, water, or horse power will be required capable of exhausting 108,000 cubic feet of air per hour when going at 4500 revolutions per minute, with iron knee pipe for connecting with air vault or direct to the underground pipe. This statement shows what would be required in case of a large growth of hay near to the homestead; but this entails an extra amount of work and cartage if grown on some distant fields or meadows, and at the busiest and most important juncture when every hour connected with hay-saving is of the utmost consequence. We must also allude to the plan used for operating on stacks made on the ground under ordinary circumstances and in situations nearest to, or in the field, where the hay is produced. In this case a wooden shute or pipe is laid on the ground, one end terminating in the cavity which may be made without difficulty by drawing a sack stuffed with straw upwards as the stack is being made, and the operating fan is connected with the shute by an iron knee-pipe.

We must now consider whether the heating of hay in the stack is desirable or otherwise. Upon this point we have no hesitation in saying that hay grown for sale may with advantage be subjected to a slight heat in the rick, so that it may truss out closely, and thereby be handled in trussing and loading without waste. By purchasers in general the fact of the hay being slightly heated is approved, principally by reason of its possessing more or less of a very taking and pleasant aroma, and if the colour is merely nut-brown buyers usually prefer it in that condition. We cannot, however, ignore the facts presented to us by chemical analysts and scientists that when we require hay for use on the home farm and gentlemen's establishments for their hunters or carriage horses it is objectionable; for we feel assured that although heated hay may possess an agreeable aroma, and be readily eaten by animals, yet analysis proves that the cause of heating in the stack is the presence of starch and sugar in the hay, combined with more or less moisture. This produces fermentation, and during the process a certain amount of the starch and sugar, and, therefore, the nutritious property of the hay, is lost, so much so that it has been ascertained by analysis that in some ricks all the sugar has been dissipated and passed off in the form of acetic acid, which is usually present in hay to a considerable extent.

Let us now refer to the point of temperature to which a rick will reach before spontaneous combustion takes place; but this is by no means certain under varying circumstances, and authorities differ on this point. Mr. Neilson, in one of his late experiments on the regulation of the temperature in hay ricks by the use of the exhaust fans, allowed a rick to take fire purposely, and he gives 200° as the temperature to which it attained. On the other hand, some careful experiments reported in a German agricultural paper went to show that the temperature reached was nearer 500° than 200°. The truth, however, may be probably somewhere between the two, and that Mr. Neilson's thermometer did not reach the hottest portion of the stack. It is, however, immaterial, we think,

for us to come to a conclusion on this point, as there can be little question that whether a rick will fire at 200° or not it will be found decidedly too hot to furnish good hay. We are also inclined to the opinion that field hay or meadow hay may ignite at a temperature to be defined, and that the former would ignite much before the latter, although the temperature may be the same. We well recollect a circumstance of a herdsman when cutting out water meadow hay for his dairy cows at some time after Michaelmas that it ignited whilst loading on a cart, which was tipped up in great haste to prevent serious mischief. Actual combustion may therefore be deferred for a longer period with meadow hay, and in some cases may probably not ignite at all if the stack is not opened until the following spring season.

It is very much to be regretted that the trials and experiments which cost so much money at the Royal Society's meeting at Reading turned out so badly, and we have strong reasons for fearing that these unsatisfactory trials will have caused considerable injury to the reputation of what we believe to be a valuable system if properly applied. It has been proved in various instances (irrespective of the long usage of the plan by Messrs. Neilson and Knowles with success) that during several past seasons the control of ricks of hay which had previously been partially made and had kept within reasonable temperature is quite practicable. How often do we see a field of hay which up to a certain time has been well made, but yet it is not quite fit to carry on a particular day, deluged with rain the next day and completely spoilt, when by using Mr. Neilson's system it might have been carried one day earlier and saved in consequence. Again, referring to the abortive trials at Reading, it was very unfortunate that the Royal Agricultural Society did not adopt the suggestion of Mr. Howard by sending round a committee of inquiry to those farms where the process had been adopted during the year, instead of spending so large a sum of money by the attempt to hold those elaborate trials. Mr. Neilson himself was most unfortunately, and we think unfairly, shut out from the competition for Mr. Sutton's prize by having overlooked the time of entry for his fan, and this fact alone went far to rob the trials of much of their interest and public benefit. All the other exhibitors of fans were simply copying his mode of proceeding more or less, yet thinking probably that they could improve on it they all departed from it in one particular. Instead of drawing up a stuffed sack to form a central air shaft, they inserted vertical cages or bosses of wood or iron. The weight of the hay, however, settling down caused the bosses to collapse, and the wet hay being tightly compressed on the top of them became impervious to air, and caused great mould and injury to the hay. It is also a great point with Mr. Neilson in constructing his stacks that they should have their sides of equal measurement, or else when the fan is set to work it will draw out all the heat from the side on which the rick is thinnest, as of course the air will pass through the hay the shortest way. Various objections have been taken to the work done by the tedding machines, but it must be remembered that if a little injury is suffered in some cases, yet as an implement and machine in general use the benefit to be derived from it is very great, especially in those districts where hand labour is scarce and dear, and which is usually the case in many wide pasture districts of the kingdom.

WORK ON THE HOME FARM.

Horse Labour.—It is a busy time with the horses, and the weather so perfect, too, without the slightest delay to the operations on the home farm, nothing having occurred to impede the ploughing and seeding the land for the various root crops, some cases are likely to occur in which the turnip-flea or beetle may do some injury. We think it is advisable in some cases to drill White Mustard seed in admixture with Swede or common Turnip seed, as these vegetate more quickly than the Turnip seeds, and engage the attention of the fleas, and allow the Turnip plants to take possession sufficiently to carry them through any injury to be done by after attacks of their enemies. The mowing machines will now be in full use on the Clovers and Sainfoin, Rye Grasses, &c., and if the present brilliant weather continues the carting and stacking may employ both horses and men until the conclusion of haying in the early districts. Let us hope that it may turn out thus, and enable the home farmer to dispense with any extraneous or additional assistance from the exhaustion-of-heat system of hay-saving, for however we may value and approve of its uses in difficult and catching seasons, yet we freely admit that all the best hay we have ever made or seen has been the result of good management of the grass during the driest and most sunny seasons; and with the assistance of the mowing machine, the tedding machine, the horse-rake, and the elevator at the stack, the work of making and stacking the hay may be made at the least cost and of the finest quality. The long-continued succession of difficult seasons will, no doubt, have taught the home farmer many valuable lessons, which could not have been acquired in such a practical form by any other means. The horse-hoeing of the Mangold, Carrot, Cabbage, and other root crops should

now be daily continued, not only for the destruction of weeds, but for the assistance of the root crops also; and we advise that in those cases where, from unforeseen causes, these crops may not be so promising as could be wished, the application of 1 cwt. of nitrate of soda may be given between the rows of plants just before the horse-hoeing. This will have an instantaneous effect, especially with Mangold and Cabbage crops; and on Potatoes also if they do not grow as could be wished the nitrate of soda may be applied before hilling the plants in the rows.

On some farms, but especially upon some light soils, like the white land on the chalk hills, are much given to the growth of Charlock, which appears to be indigenous to these lands, and to rid them is a matter well worth the consideration of the home farmer. Instead of complaining of these weeds and the cost of killing or destroying them in our crops, let us take the opportunity of using the Charlock when just coming into bloom as the means of manuring the land, and ridding it as much as possible at the same time. For instance, if we have a field known to produce Charlock in abundance, greatly to the disadvantage of our farm crops, instead of seeding for a Turnip crop, grow a crop of Mustard with Charlock. If the land has been fallowed a good depth by a winter ploughing, work the land fine in the early spring, and allow the Mustard and Charlock to become a strong and thick crop, then plough it under and press, and work the land fine, and sow Mustard. Another crop of Charlock is again almost assured, which if ploughed in when at full growth and flower will prove valuable manure. Let this be repeated several times during the summer instead of growing Turnips to be fed off by sheep, and a valuable crop of Wheat may be grown without any other manure. The same if the land is held on for Lent corn may be done with advantage, taking care, however, to press the land and seed the corn with the aid of the press drill, which will give the rows of corn at about 10 inches apart, and at this distance when the Charlock comes again, which it will probably do, though in diminished numbers, it may be horse-hoed between the rows of corn, and the weed-eradicating machine drawn by one horse will complete the work of destruction. Still, on some soils it will come again whenever the fallow crop occurs, and then the ploughing-in for manure operations by growing Mustard may be repeated without loss, except the manuring by sheep, which will be well substituted for a manuring far more powerful and enduring than the sheep-dressing, for it is well known to those who have practised the system that the death and decay of green crops yield the most valuable manure for the production of cereals at a far less cost than any other manure.

Hand Labour will now be required in various ways. The Quickset hedges, in fact any hedges, should be trimmed at or before mid-summer day for the first time, and at the same time to prevent any weeds or coarse grass seeding on the borders or in the ditches, these may, if not having been previously cut for green foddering of cattle, be cut and disposed of, together with the hedge trimmings, which may be raked together when dry if it can be reached without injury to any growing crop, and carted to a rick or secured in heap, for the purpose of covering and protecting Mangold or Potato store heaps during the winter. If, however, it cannot be removed at the time, let it be raked together and heaped in large heaps on the borders, in readiness to be cleared away after harvest. In this manner the hedges will be preserved, the ditches kept open, the borders clean and tidy, and no weeds, &c., allowed to seed the adjoining land. At the same time, it will have yielded enough to pay for cutting, by affording either fodder, or bedding adapted for covering our root-store heaps.

METEOROLOGICAL OBSERVATIONS.

CAMDEN SQUARE, LONDON.

Lat. 51° 32' 40" N.; Long. 0° 8' 0" W.; Altitude, 111 feet.

DATE.	9 A.M.					IN THE DAY.				Rain
	Barometer at 32° and Sea Level	Hygrometer.		Direction of Wind.	Temp. of Soil at 1 foot.	Shade Temperature.		Radiation Temperature.		
		Dry.	Wet.			Max.	Min.	In sun.	On grass.	
1833.										
June.	Inches.	deg.	deg.		deg.	deg.	deg.	deg.	deg.	In.
Sun. 3	30.174	66.0	55.9	N.	57.6	74.9	49.8	117.4	40.8	—
Mon. 4	30.021	61.8	57.5	N.E.	58.7	73.7	46.4	119.9	43.9	—
Tues. 5	29.869	63.7	54.3	N.W.	59.5	76.5	48.3	119.6	45.4	—
Wed. 6	29.859	57.4	51.3	N.E.	59.7	70.4	45.2	114.3	45.3	—
Thurs. 7	29.787	51.0	49.2	N.	59.8	64.7	49.4	73.6	45.4	—
Friday 8	29.804	58.8	52.9	E.	58.1	67.4	50.1	92.6	42.3	—
Satur. 9	29.832	62.6	57.2	N.E.	57.7	76.1	47.0	117.7	39.3	—
	29.915	60.2	54.1		58.7	72.7	48.0	107.9	41.2	—

REMARKS.

- 3rd.—Fine and bright.
 4th.—Rather overcast in morning; fine bright afternoon and evening.
 5th.—Fine and bright; much wind and dust.
 6th.—Fine throughout.
 7th.—Calm, dull, and cool; slight shower 8 A.M.
 8th.—Fine; cloudy at intervals.
 9th.—Fine bright morning; afternoon dull and stormy-looking; large drops of rain 4 P.M.
 A very fine week, temperature above the average. A heavy thunderstorm occurred in the valley of the Thames, with 1.75 inch of rain in an hour and a half, but no measurable quantity fell here.—G. J. SYMONS.



21st	TH	Leeds and Leicester Shows (last day).
22nd	F	
23rd	S	
24th	SUN	5TH SUNDAY AFTER TRINITY.
25th	M	
26th	TU	Royal Horticultural Society's Committees; Pelargonium Show.
27th	W	Cardiff and Croydon Rose Shows.

SHADE AND SHADING.

LIGHT is undoubtedly of primary importance in the growth of plants, yet there are times when they have too much of it, and shading is resorted to. Then too often the other extreme is reached, and instead of too much sun the plants have too much shade, for shading, like other practices that are good in themselves, is open to abuse. Some cultivators boast that they never shade their plants and crops; and by a sound system of ventilation, and the intelligent regulation of atmospheric moisture in a house or frame, there is no doubt they succeed in producing good crops of Grapes, Melons, and Cucumbers, and have generally healthy plants. Yet it is observable that these non-shaders are sensible of the advantage of a cool north border, and are in the habit of removing portable frames there in hot weather for the accommodation of many kinds of plants.

Ask a gardener situated on the southern slope of a hill and on a dry gravelly soil, with no wall or other building running east and west, nor any other kind of screen to break the rays of the sun from a slip of ground, if he is perfectly happy during a dry and brilliant summer? Instead of being uninterruptedly happy and gratefully content, he will have many hours of misery and daily longings for the shade that the position denies him.

A gardener thus situated labours under great disadvantages, and the summer is the time when the importance of a shaded border can be best appreciated by those who have the power in many cases to remedy the one great defect in their gardens. Walls are often out of the question, but a close screen of Lombardy Poplars may be provided at a trifling cost; and such a hedge when neatly clipped is an ornament rather than an eyesore, while it may be kept at any height required for any number of years. A border thus shaded and covered thickly with ashes is the best possible position that can be found outdoors for Camellias, Azaleas, Roses, Cytisuses, and numerous other plants that enjoy a sojourn in the open air, and of others which must have it whether they enjoy it or not. It is also precisely suitable for frames in which Cinerarias, Primulas, Calceolarias, Fuchsias, Auriculas, Cyclamens, and many other plants are prepared that must be grown in quantity for decorative purposes. Then for the propagation of plants hardy and tender a shaded border is indispensable. A screen such as that recommended is quite as good if not better than a wall, for it does not give a dark dense shade. There are glints of

sunlight through it and an infiltration of air, both of which are conducive to the well-being of plants. The shadow of the hedge, too, is infinitely safer than that afforded by the horizontal branches of trees, under which plants are often placed most injuriously, in consequence of the drip from the trees when showers occur; but there is no drip from a well-managed screen of Lombardy Poplars.

But greenhouses, conservatories, and pits cannot be removed to the shade, and other means of shading have to be resorted to. There are two distinct kinds—permanent and portable. The latter is generally preferable, but in the case of certain houses the former is invaluable. Lofty conservatories which are kept gay with flowers, relieved with Ferns and ornamental-foliaged plants, may be safely and usefully shaded by the application of a pigment, such as whitening and milk with a little oil, to the glass outside, and this may be made to have a pleasing appearance rather than otherwise. It is suitable also for houses of Camellias, and for Ferns, Palms, and shade-loving plants generally. What is known as the French lattice-work shading is the best and most durable, though its first cost is necessarily greater than that of textile fabrics such as canvas. These when resting on the glass exclude the circulation of air through the roof between the laps of the glass, which is an evil, if not the greatest evil attending too close shading. With the French blinds there is no great impediment to the circulation of air.

When canvas blinds are used on houses and frames they should, wherever it is possible, be supported a few inches above the roof with iron rods. Those who have not tried this method of shading have no conception of its great superiority over letting the blinds rest on the glass. Under the latter plan the plants become drawn, weak, and when the shading is abused insect-infested. Under the former they remain sturdy, because they have air, just as plants outdoors remain sturdy when the weather is dull.

In the case of Cucumbers, Melons, and many plants grown in pits and frames in a sunny position, a slight shade afforded by hexagon netting is often of great service in the middle of hot days; but always remember that it is desirable to avoid shading as much as possible, and when it is given to give as little as possible.

Shading should never be regarded as a substitute for watering, except on Sundays, and then it is permissible. We often find expressions of sympathy with cabmen, railway guards, and policemen who have to work on Sundays; but their work is pleasure in comparison with that of a young gardener when it is his "turn in" on a sunny and windy Sunday, for he often has the work of two or three men to do on that "day of rest," and he should be allowed the assistance of a little extra shading to prevent the necessity of hours of laborious watering. This extra shading once a week I know from long experience does no harm, though I fear there are still persons who would regard it almost as a crime to depart an iota from the ordinary week-day routine.

An efficient system of watering lessens the necessity for shading, and in hundreds of instances shading is given when water is needed. This is decidedly wrong, but effective watering means anticipating the wants of the plants, not waiting for an expression of their

exhaustion by flagging before water is given. When drooping occurs shading must often accompany the watering, but the material should be removed as soon as the foliage recovers its lost freshness.

Ventilation well conducted either renders shading superfluous or reduces the need of it to a minimum. A man who is master of the art of ventilating glass structures will keep a house cooler with the lights half open than another man can who has never been properly taught the work with which he is entrusted. The one proceeds on the principle of opening the ventilators before, apparently, it is necessary, and lets the rising temperature follow the ventilation; the other waits until the house has got "hot," and air must be admitted to prevent immediate damage being done—then the lights are opened wider and wider to "bring down" the heat. The former is the right method, and the latter the wrong one. By the right plan the heat is kept to the proper figure without opening the ventilators to anything their full extent; by the wrong one it cannot be kept down at all. And just as ventilation is faulty, just in the same proportion will shading become requisite, and in the same ratio also will the plants, whatever they are, be weakened.

The time above all others when a watchful eye must be kept with the object of shading, if it is needed, and not a moment before, is when a few dull days are followed by a fierce sun. It is then that the foliage is the most liable to scorching, and often a quick syringing of the glass with a thin mixture of whiting and water has saved the foliage of Vines, Melons, and Cucumbers, and consequently the crops of fruit. The first shower cleans the glass again, and until that shower falls the sprinkling of whitewash does no harm.

It is often of far greater importance to shade the pots in which plants are growing than the foliage, hence it is that plunging is beneficial in hot weather. If plants outdoors cannot be plunged, shade the pots by some means; keep the soil sufficiently moist, and the tops of the plants may almost be left to themselves so far as regards the question of shading. The exact reverse of this practice is too common, and hundreds of unsatisfactory plants are the direct consequence.

Perhaps these notes on shading may be useful before the summer is over, and the more immediately so if rain should be falling when they appear, to be suddenly followed by burning sun.—A NORTHERN GARDENER.

RENOVATING CAMELLIAS.

IN the issue of this Journal of March 15th of the present year appeared some historical and cultural notes on these handsome and deservedly popular shrubs. As was indicated, more remained to be said on the management of the plants, and it will not be unseasonable, this being a very good time for repotting some Camellias, to say it now.

Having referred to a healthy plant, and noted how it may be made to fail or to flourish, it cannot but be useful to commence with an unhealthy plant and suggest how it may be improved. The stems have a black, wiry, hide-bound appearance, the leaves are greenish-yellow, the flowers few, because the majority of what buds there were fell off like nuts in the autumn. Let us turn such a plant out of the pot and examine the roots. What do we find? An inert mass of soil, possibly black sour peat, and something like a root or two trying to escape through the drainage, yet arrested by worms. This is no imaginative case. There are thousands of plants in that state—dying by degrees from the want of a fair chance to

grow. They cannot get out of the pots and shake off the soil that is killing them; therefore we must help them. This must be done carefully. Every fresh root must be preserved. If the case is a bad one—few white roots, but the majority black and dead—not only should all the soil be picked or shaken out, but the roots should be washed, as if washing a mop. Cut off the dead portions—indeed, cut until life is found; then, while still wet, dust the roots heavily with silver sand and repot in as small a pot as possible. Drain it well, and protect the drainage from the soil with clean turf fibre, which dust with soot. For a plant of the kind under notice this is the compost: Half rather light but decidedly turfy loam containing no lime, the remaining half to consist of very fibrous Heath or Azalea peat—not bog—and leaf soil from leaves that have not fermented; mark the condition. To this add crushed charcoal and silver sand liberally, say together, so as to form an eighth part of the bulk. Mix the whole thoroughly. If this compost will not incite the production of roots nothing will.

When should this be done? is the next question. It is best done in early spring just as the plants are commencing growth, or trying to do so, by those who have a stove or other structure where the temperature ranges from 55° to 85°, and where syringing can be done freely and a moist atmosphere maintained. Those who have not such convenience, but possess a vinery in which the Vines start in a natural manner, may repot their Camellias when the Vine leaves fairly cover the roof, as the temperature suitable for Vines at that stage and onwards will be also suitable for the plants under notice. If the pots can be placed on a bed of leaves or other moist base it will be decidedly advantageous to the plants. With only a greenhouse at disposal the repotting should be deferred until the night temperature is 60° or thereabouts, and the plants should be grouped where they can be kept as close as possible, also shaded. This with light syringings will lessen the necessity for frequently watering the soil, and healthy root-action will be the sooner induced. Further details for watering a plant after it has been potted are given on page 211.

A good guide for repotting unhealthy Camellias when there was not the requisite convenience for dealing with them before, is when the young growths cease to extend, and just as the last-formed leaves are attaining their full size; but the longer the potting is deferred the greater must be the care in preserving the healthy roots and preventing them drying; and the more radical is the treatment, such as pruning off decayed parts and washing the roots, the greater is the necessity for heat, shade, and moisture for effecting the recovery of the plants.

Many Camellias while not being so healthy as they should be do not need to have the whole of the soil removed. The soil itself (and the condition of the roots) will suggest to what extent it should be picked out. When the plants are sufficiently healthy to form flower heads they may be repotted when these buds are about the size of Radish seeds, as if they are allowed to grow much larger before the roots are disturbed, as they must be to some extent in repotting, there is danger of their dropping, this mishap resulting in nine cases out of ten from defective root-action, the tenth being immature wood and excessively luxuriant growth.

The practice of cutting down Camellias has been recently alluded to. Any moderately healthy examples, but tall and loose, with naked branches, awkward and ungainly, may be cut down to any extent provided they can be placed in a warm steaming atmosphere, where they will shortly bristle with young growths, and in a short time form handsome bushy specimens. Numbers of Camellias could be named as not worth 5s. each a few years ago that were subsequently cut down, treated well, and which could not now be purchased for as many pounds.

As to varieties. Camellias should be chosen on the principle of special adaptation to circumstances. Some may require small plants for small greenhouses, others free growers for large specimens, and others, again, sorts for covering the back walls of vineries and Peach houses, which can be furnished more attractively and profitably with these plants than any others. The following short selections, made with care in the great Camellia house of Messrs. W. Paul & Son at Waltham Cross,

are adapted for the purposes and positions indicated, and may be useful to some readers.

Twelve Camellias of Compact Habit, which Flower Freely in a Small State.—Old Double White, still one of the most useful; L'Insubria, deep clear red striped with white; Fimbriata, white—a charming variety of long-proved excellence; Countess of Orkney, white, often slightly flaked with crimson; Lavinia Maggii, white, broadly flaked with carnation; Montironi, white—Madame Lebois, crimson, perfect shape; Angustina Superba, pink, large and fine; Henri Favre, deep pink or rose; Comte Boutaulin, rosy crimson shaded, large and fine; Rafia, very dark crimson, fine; Comtesse Hainault, blush with peach base, fine shape and lovely colour.

Twelve Camellias, good for Specimens in Tubs or Pots or for Planting Out.—Old Double White; Imbriata, crimson; Countess of Derby, blush white broadly flaked with rose; Conspicua, rose, semi-double, fine large thick petals, very showy; Donckelaarii, crimson flaked with white, semi-double blooms in grand masses; Emilia Campioni, red with white stripes; Monareh, fine crimson, very large; Belle Jeannette, crimson banded with white; Marchioness of Exeter, deep soft rose, makes a splendid tree; Benneyi, red, sometimes striped with white; Eugène Massina, rose, white border, beautifully shaded; Duchesse d'Orleans, flesh colour beautifully flaked with crimson.

Twelve Camellias, Free-growing and Free-flowering Varieties, suitable for Covering the Back Walls of Vineries or Peach Houses.—Ninfa Egeria, white, very free and pure; Elegans, pink; Reine des Fleurs, fine dark red; Lueretia Gazzarino, rose banded with white; Cup of Beauty, blush white flaked with crimson; Beali, fine scarlet-crimson; Mathotiana alba, fine white; L'Avenir, bright rose; Rose la Reine, crimson, occasionally striped with white; C. M. Hovey, scarlet-crimson; Livia Borromeo, rose colour with broad white stripe; Baron de Vrière, peach, faint white stripe.

Camellias that are quite healthy, have made their growth and set their buds, no longer require a close moist atmosphere, but on the contrary, light, without fierce sun, is requisite for maturing the growths. Camellias should not be placed in the open air until the buds are set, and then especial care must be taken to supply the plants with the requisite quantity of moisture, also to prevent worms entering the pots.—J. W.

WATERING VEGETABLES.

THROUGHOUT June, July, and August many kinds of vegetables are much benefited through being well watered at the roots. In rich ground with plenty of rain and heat everything will come quickly to maturity; but although we generally have sufficient heat for vegetables the requisite moisture is often wanting, and it is this which requires attention.

Really good well-flavoured vegetables are never produced in a dry soil, especially if the soil is poor. There are various ways of watering, and some crops require more than others. Celery, for instance, can hardly be overwatered, and Peas and small salading may be largely supplied with advantage in hot weather. Some of our William I. Peas which were ready for gathering a week ago would have been soon over if we had not watered them copiously, thus securing better filled pods and a longer continuance of them. Flavour, too, is secured by watering in such cases, as the Peas are more juicy and sweet than when starved. We hardly ever water Peas or Beans unless they are in bloom or pod, but Celery is watered from the first day it is put in the trenches until it has been earthed up at least once, and it is very rare that a plant bolts or seeds prematurely.

In very dry weather Cauliflowers, Brussels Sprouts, and Broccoli are watered as soon as they are planted, and this is repeated if occasion requires until they commence growing, when watering ceases. Lettuce just beginning to turn in are well soaked once a week or so. Potatoes are never watered, and they come as quick and of better quality when the soil is dry. Vegetable Marrows and ridge Cucumbers on mounds have large quantities given them, and Carrots and Parsley in small quantities have unstinted supplies. Radishes in dry soil can only be had sweet and crisp by constant attention to

watering. They are sometimes watered before beginning to bulb, but as a rule it is only when maturity is approaching that water is most wanted.

In all cases where young plants are inserted only clean water is used, but in watering to increase and prolong the crop liquid manure is given. This may consist of drainings from stables, cattle sheds, or manure heaps, or may be made of artificial manure, such as guano; one small handful of guano dissolved in 4 gallons of water makes an excellent stimulant. Soot tied up in a bag and soaked in a water tank soon makes the water most valuable for applying to all kinds of vegetables, particularly those liable to be injured by grubs or insects.

In watering vegetables for exhibition liquid manure may be given every other day in dry weather. Some who are anxious to gain size and rapid perfection are very apt to give liquid manure too strong, but it is much safer to give it moderate in strength and frequently than check growth altogether by poisoning the roots. Onions, Globe Artichokes, and Broad Beans will bear high feeding.

Where mulching can be practised in connection with watering the benefits will be increased. The best way is to water thoroughly, and then mulch immediately afterwards to prevent evaporation. Where mulching has been done water may be applied all the same, as it will wash down the good properties of the manure to the roots, but any crop that is mulched never requires water so often as crops in bare open soil. Many object to water vegetables generally, and so do we unless they really want it, but it is an unprofitable mistake to carry the non-watering idea too far. We also object most decidedly to surface sprinklings. This is absolutely bad practice and cannot be too severely condemned. It is deceptive in every way. A wet surface and dryness underneath is ruinous to plants indoors and in the open air alike, and it is infinitely better to thoroughly saturate the ground once a fortnight than wet the surface every day. In the former case roots, leaves, and fruit are all stimulated, but with the latter they remain unchanged for the better, indeed are often made worse.—J. MUIR, *Margam*.

ROSES ON THEIR OWN ROOTS.

"A. F. M." is an agreeable controversialist, even his god-natured cynicism of getting budding knives cheap is agreeable. He is a doughty champion of worked Roses, but which I think no one has assailed as such. No one asserts that Roses worked on the Manetti and Briar stocks and grown in good soil will not produce grand blooms; my contention is that not three nor even eighteen only, but the majority of Hybrid Perpetuals, will produce equally fine examples on their own roots in similarly good soil. I venture to affirm, too, that when cuttings are so plentiful as to be burned by barrowloads that good plants can be raised from them in less time than equally fine examples worked on the Manetti, dating from the time the cuttings of the latter are inserted, for I presume they must be struck before they become stocks. If "A. F. M." will not admit this, on what just and fair ground does he base his argument? Weak growers are assisted by being worked on stronger stocks, but the good growers, and they are the majority, are not improved by any stock; and, moreover, I have found, not once nor twice only, but many times, that cuttings of them strike as freely, as quickly, and as certainly as cuttings of Manetti do, both being inserted at the same time and manner.

It is very new to me to be told that we cannot prune (for cuttings) in September and October, since I have a very clear remembrance of procuring and inserting them for at least a dozen years consecutively; and not only so, but to the advantage of the plants from which they were taken. The summer and early autumn pruning, or thinning out superfluous shoots of Roses, is too much neglected, and it would be better for hundreds of Roses if cuttings were taken from them by enabling the wood remaining to be better ripened and the buds firmer and bolder, for the best buds give the best shoots, and the best shoots the best Roses; and if we can get three "bests" from one operation, and a number of fine young plants into the bargain, we ought, I think, to be improving.

There is no question whatever that the quickest method of increasing new and scarce varieties is by budding and grafting, the latter being the more expeditious mode of increase, at least so I have found it; but where cuttings of the strong-growing varieties are so plentiful, those who require them may as well convert them into plants as destroy them.

Half of the plants on the Manetti that produce grand exhibition blooms are supported in great part on their own roots. If they were not—had not rooted from the collar, but were sustained wholly by the Manetti roots—the growth would not be so vigorous nor the flowers so fine. In numerous instances I have known the whole of the Manetti roots die after “own roots” became plentiful, and have cut off the former, replanted, and had as fine growths and blooms as before.

Your able correspondent is on safe ground in promising that if anyone beats Mr. Cant for the championship with own-root Roses this year, he (“A. F. M.”) will devote himself to cuttings henceforth. But perhaps Mr. Cant will not be defeated at all, and then if the losers have grown their blooms on worked plants, as will probably be the case at least to a very large extent, will it be said that the cup was lost because of the inferiority of the stocks? No, nothing so illogical will be adduced. It will simply show that soil has more influence than stocks.

Again, I think it can scarcely be expected that with ten thousand to one against them—for there is probably that proportion of worked and “own-root” Roses—the latter can win in great contests; if so, large standing armies might safely be abolished. A fairer test will, I think, be the relative merits of the blooms from the plants in Mr. Baker’s garden at Holmfels, where “D., Deal,” thinks (see p. 476) those on their own roots are “the most remarkable.” I do not want to “get up a case” for own-root Roses, but let them have justice.—A JUDGE.

VENTILATION.

I HAVE repeatedly said that with forcing houses giving air should, with very rare exceptions, be only for the purpose of preventing too high a temperature. Opening ventilators for the purpose of changing the air is generally quite unnecessary. True, my friends will have it that when writing in this strain I am only thinking of the management of the large vinery under my charge, but I beg to assure them that my thoughts are not always confined to this vinery, nor even to the garden over which I have the command. The principle of ventilation is the same in one garden as in another, but the practice has to be varied to suit local circumstances. A house in which Grapes are now ripe was only aired on three occasions during two months, and had there been no likelihood of the temperature rising to a dangerous height it would not have been aired as often as that. Why should it? Our houses are not air-tight cases. There is constant ventilation to all of them whenever there is considerable difference between the internal and external temperatures. The system of growing Cucumbers without ventilators is thoroughly in accord with my ideas, if it can be managed without the temperature rising to a dangerous height. I should be glad to know what is the angle of the roofs of the houses in which this is practised, on what system they are glazed, what is their aspect, whether they are ever shaded, and what is about the highest point reached by a shaded thermometer placed in one of them.

There are two distinct practices in vogue of giving ventilation to hothouses, and both have their disadvantages. My practice and that of a few other growers is to give air very early and let the rise of temperature take place mostly after it is given.

The other practice is to give a certain amount of air when a certain temperature is reached, and add to that when the mercury has risen to another certain point.

The principal disadvantage in my system is, that sometimes as soon as we have done our work as regards opening the ventilators, the sun goes in and we lose the benefit of the high natural temperature we might have secured and kept for some time had we not opened the ventilators at all.

By the other plan, that of giving air after a rather high temperature has been reached, we lose more atmospheric moisture, and the plants are apt to droop.

I was glad to see from a correspondent’s note some time back that an amateur was trying to make an automatic ventilating apparatus. I hope he will be successful, and that he will not be discouraged by the few words I am going to say on the subject.

I once puzzled a little over a self-acting plan for ventilation. I thought of making use of the metal which is the most sensitive to temperatures, making coils of it, and using multiplying wheels, so that when the metal lengthened by expansion, the ventilators, which would be very numerous and be furnished with springs gently forcing them outwards, would open gradually as the heat increased, and close again as gradually when it declined. But I suddenly woke up to the conclusion that our theory of ventilation is radically wrong, and that we must some day take a “new departure;” for if, as I maintain, ventilation is only given to hothouses generally for the purpose of preventing them reaching too

high a temperature, why not prevent the high temperature in another way and get rid of the disadvantages of ventilation? In short, is it not refrigeration or allaying of heat we often want rather than ventilation?

There is no difficulty about the egress of air from ordinary hothouses. Even when the ventilators are closed as tightly as possible there is a very rapid change going on. All we want then is some method of bringing in cool air at the lower part of the house in sufficient quantity to prevent too high a rise. Can this be done by any kind of pumping apparatus, and thus save us the cost of making ventilators and the pain of seeing our plants dried up by the wind when they ought to be rejoicing in a balmy atmosphere? —WM. TAYLOR.

CENTROPOGON LUCYANUS.

FEW winter-flowering plants are more serviceable than the above, and it is worthy of extended cultivation in all gardens where winter and spring flowers are in demand. While in bloom it is at home either in the stove, intermediate house, or the conservatory, and on this account is doubly valuable. It is more useful than many plants grown for flowering at that season of the year, because it will unfold its terminal truss of bright scarlet flowers in the dark days of November, and the same plants will continue to produce in succession bunches of flowers from the axils of every leaf along the shoots until April.

It is of easy cultivation, and a good stock can soon be raised by means of cuttings. Cuttings taken with or without a portion of the old wood attached, root readily if inserted in sandy soil and plunged in slight bottom heat and placed in a close frame or under bell-glasses. As soon as the cuttings are rooted they should be placed singly into 2 or 3-inch pots, and kept in a warm house until they commence growing freely. The growths of the young plants that have been rooted seldom extend to any great length, but after a time strong vigorous shoots are produced from the base. These, if pinched well back, will be the means of other strong shoots springing from the base, which should be encouraged to extend. Stopping is of but little service towards producing bushy specimens, for they seldom break into more than one or two shoots again at the most. If by repeated pinching bushy specimens could be produced it would by no means add to the beauty of these plants for purposes of decoration. When twisted for the purpose of dwarfing them they have a stiff formal appearance compared with those that have been allowed to extend naturally, as the upright arching spikes display their real beauty and true character when in flower and arranged amongst dwarf plants.

As soon as the small pots are full of roots the plants should be placed in others 5 or 6 inches in diameter, which are large enough for decorative purposes. The pots should be drained liberally and the soil pressed moderately firm, especially when placed in the last-named sizes. They are not very particular about soil, and do well in almost any mixture; but the one we have found most satisfactory is good loam, a seventh of manure, a little charcoal, and a liberal dash of coarse sand. These plants should be grown warm until they are well established in their flowering pots, and then more air should be given them until they can be gradually hardened to cool-frame treatment during the warmest months of the year. They can remain in this position until there is fear of the temperature falling from 55° at night, when they must have a position where that temperature can be maintained. While under cool treatment the frame in which they are grown should be closed early in the afternoon while the sun is upon it.

Light shade is beneficial during very bright weather in the earlier stages of the plants’ growth, but at no stage must light be excluded from them. Towards the close of the season they must have full exposure to sunshine to harden and mature their shoots.

The syringe must be used freely, for these plants are subject to red spider, and liberal applications of water must be given at the root while in active growth, and weak stimulants when the pots are full of roots.—SCIENTIA.

NIGHTINGALES IN KENT.—I have watched the papers during the last two months expecting to see a peculiarity of the Nightingale noticed that I have never seen during the last twenty years. There are many places within a few miles of this town where the Nightingale may be annually heard, and many a time have I peered into the foliage of the trees to catch a glimpse of the songster, usually a difficult task. This season they have perched boldly on outside twigs adjoining the public roads, almost within reach, and without the shelter mentioned by your correspondent “J. R. S. C.” In fact, so tame have they been that on two occasions when mentioning this peculiarity a Nightingale has settled in the road in front of us. Can

any of your correspondents say whether this betokens any particular season to be expected?—L. A. K., Maidstone.

THE STRAWBERRY-EATING BEETLE.

THIS beetle, which did so much mischief last year, may return with the berries again, so it is well to know how to circumvent him. Last year I laid down slates and boards as traps, under

which they hid in numbers during the daytime. But when the boards were lifted it was found impossible to "lay salt on their tails," so another plan had to be tried. The most effectual was that of filling drain pipes loosely with hay. In these they took lodgings. Lodging houses and all were then carried away, and the hay shaken into hot water, or where the beetles could be caught and killed. In this way a countless devastating host was speedily reduced to a harmless few. It, however, will be well, where last year they were troublesome, to begin to trap before the

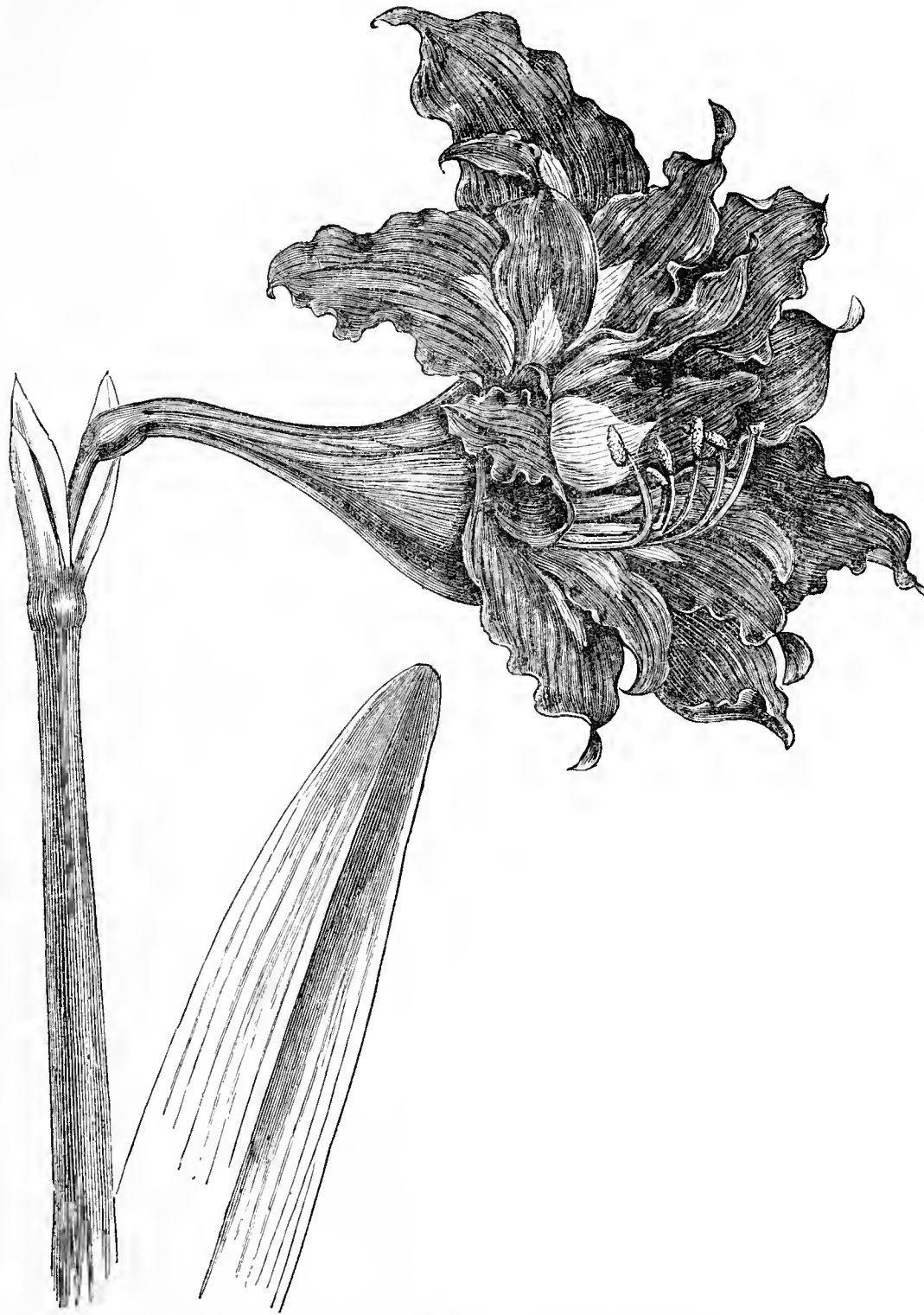

Fig. 115.—HIPPEASTRUM EQUESTRE VAR. SEMIPLENUM.

crop is half ruined—in fact at once, for the sooner the better.
—A. H.

HIPPEASTRUM EQUESTRE VAR. SEMIPLENUM.

A SHORT time since we received from Messrs. Curtis, Sanford and Co., Torquay, flowers of a very distinct double Amaryllis, or, more correctly, Hippeastrum, which is such an uncommon character that we have had an engraving (fig. 115) prepared to show the character of the variety. It is evidently a double form of *H. equestre*, the type of which was well figured in the "Botanical Magazine" in 1795, and a considerably larger variety, named major, was represented in the "Botanical Register" for 1817.

The species was described by the younger Linnæus, and it is stated in Aiton's "Hortus Kewensis" that it was introduced by Dr. W. Pitcairn from the West Indies in 1778.

The double or semi-double variety was, we believe, first described by Herbert in his work on the Amaryllis family as *H. equestre* var. 3 semiplenum, the pulcherrima of gardens, and is said to have been found by Fraser in Cuba near Havannah, and it has also been imported from Bahama. Messrs. Curtis & Sanford state that they received their bulbs from India, but from what part is unknown, but it is probable that bulbs have been introduced there from the West Indies, as we have been informed that in some of the islands it is very abundant.

In a horticultural point of view the plant is interesting as a

distinct departure from the ordinary type, the bright scarlet and orange flowers with a light centre being freely produced on scapes of moderate strength.

PLANTING AND EARTHING-UP CELERY.

DURING the next few weeks the main plantings of this much-esteemed vegetable should be made. There are various methods of growing it, some growers planting from two to four rows in a bed, and others only one row in a trench. The latter mode of procedure is adopted where quality rather than quantity is the object in view, and generally practised by gardeners. We shall, therefore, confine our remarks to the single-row system of planting.

It is almost impossible to keep Celery too moist at the roots during the growing season; but after the plants have completed their growth it is necessary that there be no lodgment of water, as that would cause the blanched heads to decay; therefore if the ground be low it will be absolutely necessary to plant in shallow trenches—that is, on the surface of trenches which had been previously opened and filled again with short dung and soil. The rows should run north and south, be 16 inches wide, 9 inches deep, and 4 feet from centre to centre. Where the ground is high there need be no apprehension of the roots and lower part of the stems being saturated during the winter months; therefore the trenches may be made 15 inches deep and half filled with rich manure, which, as in the preceding case, should be dug into the trenches. The ridges, which are formed between the trenches by the soil excavated, should be made to slope inward with an angle of 50°, so as to allow the Celery the full benefit of summer showers.

The plants in the nursery bed should be watered a few hours previous to being taken up, as they can then be removed with plenty of soil adhering to the roots. They should be planted 9 inches apart in the rows, and watered through a rose to settle the soil among the roots, care, in the meantime, being taken to remove the offsets, if any, from the individual plants.

In earthing-up Celery the soil should first be pulverised with the spade, placed around the plants with the hands, care being taken not to let the soil get into the hearts of the plants. But before the soil is applied a few of the outside leaves should be removed, with any suckers that may have sprung from the crown. Moreover, instead of being earthed-up when only 6 or 9 inches high, as is not unfrequently the case, it will be advisable to defer the work until the plants have attained a height of 12 or 16 inches, thereby not only economising labour, but also lessening the chances of the soil choking the plants; and the primary object—the blanching of the head—is secured as completely as by adding the soil at more frequent intervals. At each stage of the earthing process the soil should slope from the sides to the plants, so as to form a receptacle for water, of which, as already stated, they cannot well have too much at the roots while growing. A fine day, when the leaves of the plants are thoroughly dry, should be selected for earthing the crops.—**HORTUS.**

CCELOGYNE CRISTATA.

IN drawing the attention of amateurs to the easy and successful manner in which this useful Orchid may be cultivated in any ordinary plant house in which a little heat is regularly applied through the coldest part of the year, Mr. A. Young (page 463) has done them a good service. One point in his notes may, however, be with advantage more particularly noted, and I think corrected.

Instead of cutting out what are termed exhausted pseudo-bulbs, by which I judge are intended pseudo-bulbs in the centre of an overcrowded plant which have cast their foliage, I would strongly advise dividing the plant as your correspondent advises, but by all means retain all the bulbs which are seen to be alive, potting in separate pots. Treat as advised for others, and in a short time almost every pseudo-bulb will start one or more growths.

I have this season from plants divided in this manner, in addition to growths from pseudo-bulbs carrying foliage, twenty-four growths from bulbs without any foliage. In some pots I have eight pseudo-bulbs with six young growths coming away freely. I lately saw a pot having about a dozen so-termed exhausted pseudo-bulbs starting eight capital healthy and strong growths, which was taken from the centre of a plant 3 feet across and potted for experiment.—**T. P. GRINDROD.**

ALLIUM NEAPOLITANUM.—We can confirm the high estimation in which this charming novelty, referred to at page 452 of the *Journal of Horticulture*, is held. We introduced it prominently to the

public two or three years ago, having become personally acquainted with its beauties whilst on a visit to the south of Europe. Unlike the generality of the genus, the perfume of *Allium neapolitanum* is of an agreeable and refreshing character.—**JAMES CARTER & Co.**

PARAFFIN OIL IN VINERIES.

THOSE who fear to syringe Vines with water which contains paraffin oil, even though emulsified with soap, may try the following plan, which is perfectly harmless, and is said to be efficacious in the prevention of red spider in vineries. It is simply to damp the hot-water pipes every now and again with the pure oil. About Stirling and near Falkirk this system has been practised for a couple of years, and certainly when persistently carried out red spider never appears in the houses. We know of one grower whose earliest house was invariably badly attacked by May, or just as the Grapes began colouring. Spider has put in an appearance this year in many places sooner than usual; but in this vinery, in spite of a hotter drier season than has been experienced for some years, no insects have appeared, and the only preventive measure employed was the bi-nightly painting the pipes with paraffin oil. The heat volatilises the oil, and going into a house so treated one's eyes and nostrils smart, yet no harm ever happens the foliage or fruit. Of course an hour or two dissipates the oil.—**OBSERVER.**

[While the above is without doubt an accurate record of facts communicated by an excellent gardener and close observer, we would yet advise caution in the use of paraffin in the manner indicated, as by its application to hot-water pipes in a house of Camellias in Belgium this spring much injury was done to the plants, and the owner regretted he had adopted the practice that he had seen recommended in an English paper. We examined the plants in question, several of which were seriously damaged, while some were dead.]



WE are requested to state that visitors to the PELARGONIUM SOCIETY'S EXHIBITION on Tuesday next will have to pay 1s. to enter the Fisheries, and an additional 2s. 6d. to enter the flower show; members' tickets, as a matter of course, admit to both. Saturday next is the last day for entries of exhibitors.

— MR. C. WARING informs us that there is at the present time to be seen at the RHODODENDRON GARDENS near Bidston Hill, Cheshire, the best display of flowers seen there for many years, and admirers of this flower who are in the neighbourhood will be well repaid by a visit, the public being admitted at certain hours while the plants remain in flower.

— MR. ALLIS sends us flowers of AZALEA INDICA ALBA from a plant that has been growing in the open ground at Old Warden, Biggleswade, for upwards of twenty years without any protection. Our correspondent never having seen it grown out of doors before in the midland counties has induced him to send the blooms to show that this plant is hardy. It flowers more or less every year.

— A CORRESPONDENT, who is evidently an excellent florist, suggests the desirability of holding an AURICULA SHOW IN SCOTLAND. This is a good suggestion, but whether it can be successfully carried out depends on the support that would be accorded by professional and amateur cultivators of the favourite alpine. There is no doubt that the pure air and cool breezes of the north are favourable to the growth of Auriculas, and we believe many are grown in Scotland, as it is certain they are produced in the finest condition in the north of England. We will readily publish any suggestions that may be sent to us by northern florists on the subject in question.

— THE START IN LIFE TO PLANTS, as well as human

beings, determines to a very great extent the success or otherwise attending their cultivation. For most vegetables and also bedding plants it will be found of immense service to give them a good start. Cabbages, Celery, Lettuces, Stocks, Asters, Petunias, Verbenas, Calceolarias, Coleuses, Alternantheras—indeed, nearly all such, if planted thinly in soil half loam, half flaky manure, some time before final planting on a hard bottom (in boxes or on the ground), will not only grow robustly, and at once, but will make mats of roots that need not be injured in removal. Still the removal causes some check. To cure this a soaking of liquid manure should be given after the roots have fairly travelled into the new soil. The energies of the plants are devoted to searching for food; when they find it the energy is expended on the tops, and is enhanced by plentiful supplies of food.

— WE are informed that Messrs. Foster & Pearson, Horticultural Works, Beeston, Nottingham, have received the GRAND DIPLOMA OF MERIT FOR HOTHOUSES at the Amsterdam Exhibition, an honour which has been withheld in many other departments.

— WE are informed that at the ROYAL OXFORDSHIRE HORTICULTURAL SOCIETY'S COMMEMORATION SHOW, held last week, thirty-three prizes were awarded to specimens of vegetables grown from seed supplied by Messrs. Webb & Sons, the Queen's Seedsmen, Wordsley, Stourbridge.

— A VERY marked change has occurred in the WEATHER IN AND AROUND LONDON, the temperature being much lower. Hail fell last Saturday, in some localities very freely, doing damage to tender plants that had just been placed in the beds. No great quantity of rain has fallen, but it threatens; and a good shower would be acceptable, with warm weather afterwards, as at present vegetation is moving very slowly.

— THE specimen of CEREUS GRANDIFLORUS at Leigham Court, Streatham, which was recently noted in these pages, has, Mr. Butts informs us, borne about forty flowers, which expanded in batches of ten, eleven, nine, and eight on four nights. Other buds are showing, but it is doubtful if they will develop, as the plant is exhausted in a measure, as it has produced far more than in previous seasons. Occasional syringing has encouraged the growth considerably, and has no doubt contributed in some degree to its floriferousness this year.

— WE have received through Messrs. Carter & Co. very creditable examples of TOMATOES, which have been grown from their seed by Mr. J. Abbot Jarman, Mead House, Redhill. Dedham Favourite, crimson, is smooth and richly coloured, the cluster of three fruits weighing 1 lb.; three of Holborn Ruby, quite ruby in colour, weigh 16 ozs., Vick's Criterion and Orange-field being smaller. The two first-named, especially, are very handsome, and are undoubtedly excellent varieties.

— MR. W. J. CLARKE writes on FRUIT PROSPECTS IN WORCESTERSHIRE:—"The prospect of a heavy fruit harvest which we anticipated in the spring has been somewhat disappointing. Pears on walls are very good and promise over an average crop. Plums, Peaches, and Apricots are almost a blank. Sweet Cherries are poor, but we will have a full crop of Morellos. Apples will not be an average crop, and the same may be said of standard and pyramid Pears. Strawberries are splendid and ripening well. Small fruits are particularly good. At the Manor House, Bewdley, the wall trees are excellently fruited, particularly Pears, Peaches, and Nectarines. The Ribbesford Cherry orchard is not up to its usual average this year. Plums and Damsons will be very scarce everywhere in this neighbourhood."

— THE Rhododendrons at Dunevan were referred to last week, but there are other features in MR. MCINTOSH'S GARDEN worthy of a passing notice. The glass ranges erected five years ago are now completely furnished, and the well-covered roof of

the chief range shows how much can be done in a short time by good cultivation. All the leading varieties of Grapes are grown, and the crop is as full and regular as could be wished. All the bunches are tapering, no angular shoulders being permitted. There is no loss of Grapes by their removal, as a greater number of bunches are retained, and there is a gain by their symmetrical appearance. There are few gardens in which Mrs. Pearson Grape is grown better than in this, and it is preferred to Golden Queen, which it surpasses in size of bunch, quality, and good-keeping properties. Foster's Seedling and Buckland Sweetwater are also excellent; so indeed are all the Grapes, black and white, except Waltham Seedling, which fails to set its fruit regularly. Peaches in the adjoining division have made similarly good progress. They have evidently been grown on the extension system, and it has answered well.

— THOSE who have seen the LILIUMS AT DUNEVAN when in full beauty amongst the Rhododendrons will not soon forget them. They are promising well this year, and eventually will produce a grand display. *L. giganteum* is also producing its spikes, but they are not so massive as we have seen them in former years. Under glass *L. szovitzianum* is bearing nine flowers on a stem, and is very beautiful. *L. Hansoni* will shortly be in full beauty, and will be, as it always is, much admired by its numerous small flowers with massive segments and bright colours. The Oregon Lily, *L. columbianum*, was also flowering. It is considered by some to be a small variety of *L. Humboldtii*, and is brighter and more clearly spotted than *L. parviflorum*; and *L. cordifolium* is also producing spikes. Liliams will continue flowering throughout the season in this collection, and some new varieties are expected.

— IN another range of glass there is what may be described a MUSEUM OF MELONS, almost all the new and many of the older varieties being represented. It is too soon to attempt an estimate of their merits, but the trial will be interesting and also instructive if a record is kept of the experience that will be gained. The variety Masterpiece at the present time is one of the most promising, and is evidently a good and free bearer.

— MR. TAYLOR'S (Mr. McIntosh's gardener) method of making SULPHUR WATER FOR DESTROYING MILDEW ON VINES and other plants may be usefully described in his own words:—"I put as much sulphur as will lie upon a shilling into the middle of my left hand, add a few drops of rain water, and mix very smooth with the finger of the right hand, then wash my hands in four gallons of tepid rain water. As soon as the sun is off the house, the Vines, &c., are syringed with this. I have tried a teaspoonful to four gallons of rain water after the Grapes were stoned, but found it too strong to continue daily." Mildew is rather prevalent in the house in question, and the above is found the safest and best way of dealing with it.

— "A. H." writes on AN EFFECTIVE IF SIMPLE FLOWER BED:—"It is not always in fine gardens that one can best pick up useful hints. Not long since I saw the sweetest and perhaps simplest spring bed I have seen for some time. It was composed of a mixture of *Dactylis glomerata* and London Pride, and adorned the green slope at a railway station. The white *Dactylis* with the innumerable spikes of the airy light Saxifrage with its setting of emerald turf, made the best harmony in colour I have seen for some time, the green of the grass complementing the pink of the Saxifrage, and the white of the *Dactylis* harmonising with both."

— WE have received the following note relative to the BLOSSOMING OF TREES IN SCOTLAND:—"In spite of the dull season of 1882 seldom have trees of all kinds, with the exception, perhaps, of Horse Chestnut, bloomed so profusely. All over

Scotland fruit trees, especially Apples, were wreathed in bloom. At present Rhododendrons are one blaze of colour; Hawthorns, Laburnums, Lilacs, and neglected hedges are covered with flowers. Most crops are fairly well forward, but rain is much wanted. Farmers on heavy clay lands have some difficulty in getting soil pulverised enough for sowing Turnips, and on dry soil the Turnip fly has appeared. On gravelly or badly farmed land the hay crop will be poor, on heavy or well-manured land fairly good. It is almost too late now for rain to help it. Potatoes are looking exceedingly well."

— "L. R. C." wants to know a **LITTLE MORE ABOUT NITROGEN** than appeared on page 492 last week:—It often happens that crops do fairly well up till flowering or fruiting time, and then growth fails. When this happens it is said that the cause is the demand made on the plants. This truth half covers a fallacy. It is partly because the plants cannot readily find nitrogen enough just when the demand for it is greatest. While at certain seasons a plentiful supply of this would only cause rank unfruitful growths and had much better not be given, its application at others would do much to help overworked and under-fed trees. Strawberries, Apples, and some other fruits are heavily laden this year. For want of a little timely aid not only may smaller crops and less fine samples than is desirable be produced, but plants and trees be exhausted and rendered unable to repeat this year's gifts. If all heavily laden fruit trees were timely treated to nitrogen, along with plentiful supplies of water, in any of the forms suggested on the page quoted, it would produce good results, especially when it is certain that phosphates, potash, magnesia, and lime are also present in plenty. The hot sun, otherwise mischievous, will convert these into plant food with a rapidity unapproached in dull wet seasons, and will not only enable the plants to perfect the heaviest crops in the best manner, but will store the trees with supplies for future years.

— At a meeting of the Academy of Natural Sciences of Philadelphia held recently Mr. Thomas Meehan read a paper ON THE RELATIONS OF HEAT TO THE SEXES OF FLOWERS. He referred to the fact, that in monœcious plants female flowers would remain at rest under a temperature which was sufficient to excite the male flowers to active development. Hence a few comparatively warm days in winter or early spring would bring the male flowers to maturity, while the female flowers remained to advance only under a higher and more constant temperature. In this manner the explanation was offered why such trees were often barren. The male flowers disappeared before the females opened, and hence the latter were unfertilised. He referred especially to some branches of *Corylus Avellana*, the English Hazel Nut, which he exhibited before the Section last spring, in which the male flowers (catkins) were past maturity, the anthers having opened and discharged their pollen, and the catkins crumbling under a light touch, but there were no appearances of action in the female flower-buds. There were no nuts on this tree last season. The present season was one of unusually low temperature. There had not been spasmodic warmth enough to bring forward the particularly excitable Maple tree blossoms. The Hazel Nut had not, therefore, had its male blossoms brought prematurely forward. He exhibited specimens from the same tree as last season, showing the catkins in a young condition of development, only half the flowers showing their anthers, while the female flower buds had their pretty purple stigmas protruding from nearly all of them.

— A CORRESPONDENT, "A. W.," sends us the following note on PEACHES AND GRAPES AT BURGHEY:—"The crop of Peaches and Nectarines out of doors is something marvellous. At any favourable season it would have been fine; but considering the character of this spring it is almost incredible to think that these

trees, so free from mildew, aphid, curl, or blister, have passed through that ordeal. I thought such trees and such strings of fruit were a dream of the past, in the midlands at all events; but here evidently with proper care and attention it is still possible to get good outdoor crops of Peaches and Nectarines. No more excuses will hold good after this. The scrupulous cleanliness of everything under Mr. Gilbert's care is quite a treat to see. He slyly endeavoured to make me believe he was eaten up with spider and mildew, but a glance convinced me of the nature of his observations. Good culture of everything under his care is one of the chief characteristics of the place. His favourite Strawberry is Sir Charles Napier, and good it is. The Gros Maroc Grape is the most noteworthy Grape he has—splendid 3-lb. bunches when ripe, and a heavy crop."

— At a meeting of the promoters of the GRAND NATIONAL DAHLIA SHOW it was determined to accept the liberal offer which had been made by the Crystal Palace Company in reference to the Show of 1883; and on the occasion of the Autumnal Fruit Show of the present year (August 31st and following day), to hold an exhibition of Dahlias at the Palace on a scale at least equal to that of 1882. The Crystal Palace Company offers to provide, as before, a sum of £50 towards the prize fund if the growers and admirers of the Dahlia will subscribe a like sum for the same object; and as there are certain additional and unavoidable expenses it is imperative that the subscription list should exceed this amount. In the Treasurer's report it is stated that "Considering the number of years during which metropolitan Dahlia shows had been in abeyance, the effort of 1882 may be regarded as fairly successful, though the subscriptions, aided by the Crystal Palace contribution of £50, did not quite cover the amount of prize money awarded. The object of the promoters was to secure a grand show, and, with this object, prizes amounting to £128 10s. were offered, of which sum £117 was awarded. The total amount of the fund raised was £123 12s. 6d.—namely, by subscriptions £73 12s. 6d., and by contribution from the Crystal Palace Company, £50. After paying the various expenses incidental to the Show, amounting to £13 13s. 6d., there was found to be a deficit of £7 1s., which was divided proportionally between the two largest prizetakers, Mr. Turner and Messrs. Keynes, and deducted from the amounts paid to them respectively, Mr. Turner losing £4 8s. 8d. and Messrs. Keynes £2 12s. 4d. Should it be thought desirable to carry on the Show another year—and in fact most of the growers have expressed a hope that it should be continued annually—it is but seemly that in future the funds provided should be ample for the purpose, so as to relieve the executive officers from the unpleasant task of offering to the winners apologies instead of prizes. The growers of Dahlias, both amateur and professional, as well as the admirers of the flower who are not cultivators, are therefore urged to contribute more generally and more liberally to the prize fund in order that the Show may be kept up to a high standard of excellence. It is further to be hoped that amateurs will more generally take part in the competition under the several classes provided for them."

HERBACEOUS BORDERS IN JUNE.

Just now herbaceous borders are looking lovely. What a wealth of beauty is to be found in a well-arranged collection of these simple flowers! but, unfortunately, well-arranged collections are exceptional. Herbaceous borders as a rule are too much neglected; yet, in my estimation, they ought to stand in the very front rank of garden adornments. Perhaps the day is not far distant when a larger portion of the time devoted to carpet and other bedding will be given to this forgotten part of many gardens; and if so I venture to say the result will be satisfactory to all concerned.

The cold backward weather we have experienced throughout the month of May has greatly added to the floral wealth of June. Border *Auriculus* have just ceased blooming, *Polyanthus* are still in

flower. How exquisitely beautiful these dark selfs look, with their bright golden centres sparkling in the sunshine. Many laced flowers grow side by side with them, but are not nearly so effective. *Ranunculus acris* fl.-pl. and *R. aconitifolius* are making a grand display just now, while the gorgeous blooms of the *Pœonias* are very conspicuous and are fine for distant effect. Clumps of *Aubrietia grandiflora* are completely covered with flowers in many shades of blue and purple. *Anthericum Liliastrum* is a lovely plant, its spikes of pure white flowers being very chaste. The bright golden flowers of *Trollius europæus* are most effective, but they do not last long. *Veronica gentianoides*, with its delicately shaded flowers, is a mass of loveliness. *Lupinus polyphyllus*, with its long symmetrical spikes of blue flowers, is grand in the back row just now, while many of the *Delphiniums* will soon contribute their noble spikes. *Saxifraga granulata* fl.-pl. and *S. Wallacei* are in full bloom; and the simple but lovely *Anemone sylvatica*, with its pure white flowers, contrast strikingly with that most gorgeous of all the *Anemones*, *A. stellata fulgens*. The intensely bright scarlet colour of this flower renders it quite conspicuous among the other occupants of the border. *Campanula glomerata* is most effective now, while *C. turbinata*, *C. Hendersonii*, *C. persicifolia*, and *C. persicifolia* fl.-pl. are following fast. The whole of this family are grand border plants, the pure white flowers of some of the varieties being very useful for table decoration. *Saxifraga pyramidalis* is a gem of the first water, with its long branching spikes of lovely spotted flowers, the spikelets being most serviceable for cutting. Large clumps of *Narcissus poeticus* fl.-pl. and beds of *Lily of the Valley* fill the air with a most agreeable and refreshing perfume. All the above I have noted specially; but what with *Forget-me-nots*, *Violas*, *Daisies*, large-flowering *Pyrethrums*, *Cheiranthus alpinus*, perennial *Candytuft*, the display is most delightful, while the foliage, clothed in all the verdant greenery of spring, gives to the whole that natural fresh appearance which is so sadly wanting in our bedding systems of decoration.

I would advise all those who are commencing to form a collection of herbaceous plants to raise as many as possible from seed. Seed of almost all kinds of hardy perennials can be had at a very reasonable price, and with good attendance and acting in accordance with the proverb, "What is worth doing is worth doing well," in less than two years each packet will have produced a hundred plants. I generally sow all hardy perennials as early in spring as possible in well-drained boxes of equal parts of loam and leaf soil, with enough sand to make the whole porous. The soil is well watered through a fine rose, and a covering of moss laid over the top of the box; they are then placed on a shelf in the greenhouse, where they stand generally without further attention until the seed germinates, then the moss is removed, and as soon as the plants are ready they are pricked off into boxes also. Those having cold frames to spare will find it more convenient to fill the space required with the compost recommended for the seed boxes and prick the seedlings out there, give a gentle watering, keep the frame close and shaded for a few days, gradually inuring the plants to the light and air, until the sashes can be removed altogether during the daytime. About a fortnight before planting out the seedlings should be exposed day and night; sturdier plants are had in this way than by the coddling which generally falls to the lot of those that are brought forward in boxes. In the month of May they are planted out in nursery rows on a spare piece of ground, where they spend their first winter, transferring them in spring to the borders. For the benefit of those that require a different soil from the ordinary border soil a pit is made, and the compost suitable for the intended occupant is filled in.

I may mention here that the packet of *Auricula* seed from "Single-handed" has germinated very well indeed. I shall have upwards of two hundred plants from it, and shall look forward to the flowering stage with some degree of interest.—WM. MARSHALL, N.B.

APRICOT BRANCHES DYING.

(Continued from page 443.)

STOCKS for Apricots are of several kinds, but taken altogether there can be no question that the Mussel is the most suitable. But the whole question of stocks is uncertain, nothing more needing to be advanced in proof than that so many have been recommended. The Breda and Brussels varieties of Apricot from their hardiness have of late years been used as stocks for the choicer description of Apricots, and the result so far as the immunity from gum is concerned is very favourable; indeed, seedling Apricot trees do not exhibit the tendency to gum in anything like the same degree as those budded on Plum stocks, and this description of stock is, I think, likely to supersede others, for of all stocks those raised from suckers or layers are most likely to induce gum

or canker. It may be said the Apricot is too tender as a stock. To this I demur, for the temperature of the atmosphere is the same as the earth at a foot depth, and if the branches of the Apricot can live and thrive in the atmosphere, why not the roots in the soil at its foot? What little experience I have had with Apricot trees budded on seedling Apricot (Breda) stocks is highly encouraging. There is no gum, which I believe is the experience of those who have resorted to the practice as a means of inducing the early fruiting of seedlings, whilst seedlings seldom gum when on their own roots or on stocks raised from stones.

Allow me before proceeding further to thank "W. K. W." for his friendly criticism and recording his experience with the Moorpark Apricot under glass, which is extremely valuable, as showing the tenderness of that variety, as well as that this choicest of Apricots can be successfully cultivated under glass. The secret seems to rest on "free ventilation," as the Apricot "will not endure a close atmosphere." "W. K. W.'s" experience places beyond question that gumming in the Moorpark Apricot is "the result of cold," which is also the dictum of the author of the "Fruit Manual." See page 177 of that work. It is questionable, however, whether the tenderness in question is due to the over-vigour of the trees, induced by the stock, or to the variety, for "W. K. W.'s" trees on the open wall made growth which could not have heat enough to ripen it thoroughly, and in consequence suffered from cold—tissues ruptured, and gumming ensued. How would it have been had the trees been root-pruned or the food supplies restricted? Would not the wood have been shorter-jointed, firmer in its growth, and more perfectly ripened? I think the trees would not have gummied any more than the very vigorous specimen under glass, which had a more favourable climate for ripening its growths, as the more vigorous the trees the more heat and time they require to ripen their fruit and wood.—G. ABBEY.

(To be continued.)

GALLS AND GALL-MAKERS.

MR. P. INCHBALD, F.L.S., published some time ago in the *Entomologist* the result of his observations upon the small four-winged and two-winged flies that are concerned in the production of various galls occurring upon wild and cultivated plants. From his article we select a few facts that are likely to be of interest to gardeners.

Salix Capræa.—Upon this shrub were noticeable two kinds of rosettes. The upright ones yielded in April the little fly *Cecidomyia rosaria*. From the deflected rosettes, which sometimes have the appearance of a loop, emerged another *Cecidomyia*, the name of which is at present uncertain.

Common Birch.—A small gall-gnat issued from the catkins about the end of March, at an early hour in the morning, pupation having lasted through the winter.

The Dog Rose (*Rosa canina*).—From the peculiar mossy tufts that sometimes adorn the twigs and stems of this species the Bedeguer *Cynips* (*Rhodites Rosæ*) appeared at the beginning of June. It is very liable to be ichneumonated, but few seemed to be attacked this season.

The Common Pea.—In the tendrilled leaves are driven the mines of the fly called by Curtis *Phytomyza nigricornis*, the pupa case being at the end of the mine; the species is on the wing in June.

The Onion.—About Harrogate the particular "fly" that affected this plant in 1882 turned out to be *Chortophila platura*, coming forth on the wing during July. The grub reduces the plants to a foetid mass, and then becomes a pupa in the earth close to the bulb. Another observer reports that he has bred from the Onion two more species of *Chortophila*, and it is now amply proved that there are several species of Onion fly.

The Carrot.—Early in August the grubs of the Carrot fly (*Psila Rosæ*) were very apparent in places where the insect had been left undisturbed. The numerous tunnels on slight examination revealed the presence of the grub at their openings, preparing to quit and become pupæ. It is evidently a matter of uncertainty, depending upon the season, whether these yield flies in September or remain dormant until the succeeding spring. But Mr. Inchbald thinks it is highly probable that each year witnesses several generations of the Carrot fly.—J. R. S. C.

STRAWBERRIES.—These should receive a final heavy watering forthwith, and then be thoroughly mulched with grass, rushes, or other suitable material, to keep the fruit from the soil and the roots cool and moist. This mulching is very important, and ought always to be done, even if Strawberry tiles or wires are used to elevate the fruit. Plant Strawberries that have been forced as soon

as possible after they are turned out of the houses, in order to have them established as quickly as possible in the soil, and to avoid waste of time and labour in watering, which must be daily and copious if they are let stand about in pots. Planted early, they sometimes afford a little autumn fruit, but that is a trifling gain in comparison with the strong growth and heavy crop of fruit which rewards such timely culture in the following year.—L.

A VILLA GARDEN,

AND WHAT CAN BE DONE IN IT.

OFTEN a curious view of the tastes and circumstances of the dwellers in many a suburban villa is had when passing along one of the lines of railway which pass through the outlying parts of our great metropolis, and I have often been interested in seeing the way in which they are occupied. Here we find one who is decided on utilising, as he calls it, his bit of ground; Cabbages, Peas, and the inevitable Scarlet Runner tell in which way his taste runs. We next find pets cherished; and so rabbit hutches, pigeon boxes, and other contrivances fill up the allotted space. One dweller feels that in our tropical climate shade is desirable, and so he has planted some trees, which he soon finds fill up his plot and leave him no room for anything else; while another, if he do not want to sit under his own Fig tree, pines for his own Apple tree, the productions of which tree he finds, however, are considered fair game by some of the naughty boys of the neighbourhood. Then, again, the gardening tastes of the occupants vary. One is evidently impressed with the idea that he must bed out, and hence his small garden is one blaze of colour; another is fond of a mixed border; another is a grower of some special favourite flower, the cultivation of which does not add to the picturesqueness of his garden, and all of these are more or less successful in the pursuit of their favourite object; but I hardly think in the whole environments of our great metropolis there is a more successful case of what can be done in a small space than in the garden of my worthy co-Secretary of the National Rose Society, Mr. E. Mawley, at Lucknow House, Addiscombe; and when we hear people complain of situation or soil or narrow limits, we can safely point to this garden, and tell them what it is and what success it has attained to.

Now the garden here is just one-third of an acre, and is not ten miles from Charing Cross. It does not labour under the disadvantage of having manufactories pouring out their volumes of horrible smoke, nor such abominations as the chemical works at the east end of London; but with this exception it has no advantage that might tempt anyone to try his hand at growing Roses or anything else, yet success of a very marked degree has been the lot of this garden. I have lately recorded my experiences of the Rose gardens I have visited this season, in order to be able to gain some idea of the present condition and prospects of the Rose for this year; but I can with all confidence say that in none of those, celebrated as most of them are, have I seen better examples of Rose-growing than in this small garden. Indeed, but that it was fully ten days since I had seen the others, I should have said Mr. Mawley's Roses were the stronger; but, knowing what ten days have done elsewhere, I prefer the more moderate statement. But, at any rate, it is quite impossible to imagine finer or more healthy plants than these. Standards and dwarfs were alike good, and as Mr. Mawley is not an advocate for hard pruning the state of the Roses in this garden is a point in favour of those who are opposed to it. There was one plant of Louis Van Houtte (not by any means, as we all know, a vigorous grower), but not even a John Hopper or Etienne Levet could be more vigorous, while promising buds gave a good indication of coming blooms. By-the-by, my friend Mr. Biron, in going over his own Roses the other day (the very opposite kind of garden to this), says—and I should like it to be confirmed or otherwise—that when in an early stage of the bud colour shows on one side you may be quite sure that you will not have a large-sized flower. The Teas, also, looked very well, and are carefully looked after. Along the wall there is a framework placed, and on this some of Collinge's shading is fixed, drawn up when the weather is fine, and let down during severe winds and frosts. It is not enough to draw the plants, but sifts the wind, as it were, and softens its influence on the plants. I have in a previous paper hazarded the opinion that the Manetti is an unsuitable stock for A. K. Williams, but the experience of this garden does not confirm this view. A row of it budded on the Manetti by Mr. Mawley himself was as vigorous and healthy as one would desire to see plants—in fact, for their age they were as good plants as any I have seen anywhere. Mr. Mawley has a small, a very small, house in which he grows a few Teas; but small as it is, I believe it has now and then stood him in good stead: for, as we all know, he is not

contented with being a Rose-grower, but is an exhibitor also—nay, a most successful one, and I very much question whether there is a garden of its size that has taken so many prizes; indeed, I think it may fairly challenge a comparison with that of Mr. Geo. Mount of Harbledown.

But besides Roses Mr. Mawley grows a very nice collection of Pansies in beds. These were looking in robust health when I saw them, and some very fine blooms bore witness to the superior character of the varieties. Moreover, there were some Chrysanthemum plants coming in for exhibition, although, as may be readily supposed, the Rose is the flower of the garden.

But it is not only as a Rose-grower that Mr. Mawley is known, or as Secretary of the National Rose Society. His little garden is one of the most complete stations of the Meteorological Society—in fact, I should say, house and garden, for a remarkable contrivance on the top of the house attracts one's attention, and I irreverently asked when I saw the balls swinging about whether he went in for anything in the pawnbroking line! This is an anemometer. Then when you get into the house there is a perfect army of barometers and thermometers, while the garden suggests a series of man-traps or, to the uninitiated, pigeon boxes or, in fact, anything; but really the most perfect set of meteorological instruments possible. Perhaps the most interesting, as certainly the most novel, is Casella's self-registering rain gauge. This, by a most beautiful contrivance of clockwork machinery, connected with the rain-receiver, registers on a metallic paper barrel the rain as it falls; so that not only, as in the ruder gauges which poorer mortals are contented with, is the daily amount of the rainfall registered, but the hours in which it fell. It would, by-the-by, have had a busy time of it had it been here on Thursday last, when in the space of an hour and a half the rain gauge marked 2.65 inches—between the ninth and tenth part of our whole average rainfall for the year. Then there are earth thermometers, and all other kinds of meters, and that all this is brought to bear on Rose culture no one who has read Mr. Mawley's most interesting contributions to the "Rosarians' Year Book" year by year can for a moment doubt; for while there recording the experiences of the past he draws his lessons for the future. All who know him will readily believe that the garden is the very picture of neatness; not a weed to be seen, or anything out of place. In fine, I must end as I began. Let any growler over the want of room or difficulties of Rose-growing visit this garden, and I am quite sure that he will go away feeling that he has no cause for complaint, and will be encouraged to attempt what he may have considered a great difficulty. Let me add that Mr. Mawley's Roses only confirm the more what I have already stated—that we are on the eve of an exceptionally good Rose year.—D., Deal.

THE EASTER LILY OF BERMUDA.

WILL you allow me space for a small addition to your note (page 498) on the Easter Lily of Bermuda exhibited by me at South Kensington on the 12th? As shown it hardly did itself justice. When cutting the stem I had to leave about 7 inches for the sake of the bulb, and 8 or 9 inches more were hidden in the bottle of water in which it was placed, so much of its height was thus lost. When growing it was just 6 feet high, the stem and leaves 15 inches across. It bore six flowers. I heard of the Lily first at Bristol from a gentleman who had seen it growing in Bermuda. Messrs. Wrench of London Bridge gave me two bulbs to prove. These were potted, one placed in a cool Orchid house, the other in an unheated orchard house. The first was the one exhibited; and from the appearance of the second, which is now in bud, it seems that the Lily will require some heat to develop the full growth. I believe that it will prove to be only a fine form of *L. longiflorum* increased in size, first in bulb and then in growth, by heat.—GEORGE F. WILSON, *Heatherside, Weybridge*.

EASILY GROWN PLANTS.

POTHOS AUREA.

WE have often had inquiries for plants that will flourish without that constant attention and skilled cultural care that are requisite for growing many plants satisfactorily. Of the free-and-easy-growing plants that luxuriate in the stoves and greenhouses of amateurs, and rendering them agreeable, are such as the *Tradescantias*—discolor, multicolor, and variegata—which ramble over rockwork, and droop in long sprays from pots, baskets, or rustic pockets on walls. Of the same nature is the *Mother of Thousands* (*Saxifraga sarmentosa*). The pretty *Panicum variegatum* is similarly free, and the *Isolepis gracilis*. Give them plenty of water and more or less of shade and they grow with a wild gracefulness

that many admire. Common such plants as these may be, but they are not too common to be grown in the Royal Horticultural Society's gardens at Chiswick, and few prettier effects are seen anywhere than in a small stove there, with the stages margined with the *Isolepis* falling down in a fresh green fringe, just touching and partially intermixing with a still deeper and very charming fringe of the *Panicum*, the pots of which are arranged on a shelf

fixed partly under and below the stage, the growths of the plants falling to the floor. At Drumlanrig the exceedingly chaste and beautifully veined *Fittonia argyroneura* is planted in the gravel base on which the pots of Orchids and other plants stand, producing a most agreeable effect, while the plants above enjoy the partial shade and steady moisture that are afforded to their roots.

In the category of free-growing plants comes *Pothos aurea*.



Fig. 113.—*POTHOS AUREA*.

It is not new nor expensive. We first saw it on the continent, but it is now found in most nurseries where stove plants are grown. We have, however, never seen it so brightly and beautifully variegated as during the present year. It is not certain that every leaf produced under different circumstances of culture will be as effectively marked as those represented, yet we have seen many sprays equal and some more distinctly coloured than the

one under notice. The plant grows freely in ordinary rough compost of loam and leaf soil made porous with charcoal, so that abundant supplies of water can be given. It also delights in heat, a moist atmosphere, and partial shade. It is adapted to the various decorative purposes above indicated, and has a fair claim for a place amongst easily grown plants.

We are indebted to Mr. Bull for the figure, and the following

is an accurate description of this Pothos from his new plant catalogue:—"This remarkably distinct Aroid, which is of climbing habit, has been imported from the Solomon Islands. The leaves are strikingly variegated, heart-shaped, and unequal-sided, of a dark green, boldly and irregularly marked by bands or fantastic-shaped blotches of creamy yellow, here and there suffused with pale yellowish green. Being of free growth, and having a boldly marked variegation, it will be an ornamental object in the tropical plant stove, where it will find itself at home in clothing walls and artificial rockwork."

WASTE WATER—A PRETTY RIVULET.

FROM a small terrace fountain provision had to be made several years ago to convey the waste water away through a small pipe not more than an inch in diameter; and though the quantity was no more than could readily pass through such a pipe, yet in the aggregate it was so considerable as to give rise to the thought that it could be turned to some account after it had passed through the fountain. There was not enough of it to excite an ambitious wish for a cascade, or even the musical ripple of a running stream, so it was turned into a little hollow below which the soil was excavated for a pool, and thrown up into a long gently sloping bank. After the pool was filled the water was made to trickle over some masses of sandstone downwards to another hollow which was gradually extended into a little dell, beyond which the water trickled onwards and was lost to sight under the overhanging fronds of Ferns and spreading branches of Rhododendrons. But even then the waste water was still required to fill another excavation which had been made for a Watercress bed, and still lower it was again in requisition to impart a swamp-like moisture to some beds of American Cranberry, whence it passed out of the boundaries of the garden, and was turned to account by the gamekeeper to fill yet another pool for a ducklings' nursery, where they could safely enjoy their favourite element till old enough for a more adventurous existence upon larger ponds.

It may be thought that because so much use was made of a mere trickle that water was scarce and hard to obtain; but such was not the case, for in a valley close by, or rather two valleys, springs abound, and there are ponds by the dozen with cascades streams, and waterfalls, making the valleys resonant with sounds most pleasant and replete with sights most agreeable. Yet there was no water upon the plateau by the house, so that without the waste water of the fountain there would have been only the ordinary repetition of lawns, flower beds, and shrubbery in the dressed grounds, but with it features were added that at once imparted much striking variety, and which have grown in beauty with the years that have passed since they were made. Let me describe them, for sure I am that something similar to them might advantageously be added to many a garden, and thus help to brighten a scene which is so often little more than a tame repetition of dozens of others.

In the hollow above the pool a bed of *Iris pseud-acorus* was planted in ordinary soil, or rather mud; the plants soon spread into dense mass, which is just now quite gay with yellow flowers springing up among the bold dark green foliage. At the head of the hollow a Pampas Grass has grown into a veritable giant; and fringing the *Iris* where the hollow joins the pool is a flourishing bed of *Calla palustris* spreading freely in the mud and shallow water, which suits it admirably. On one side of the pool the lawn slopes gently downwards to the water's edge; but on the opposite side, where the excavated soil was thrown, a single layer of rocks was made in imitation of natural strata close to the water, and beyond the rocks a bold mass of many varieties of hardy Heaths was arranged, almost all of which have grown freely and become blended together very much as one sees the wild Heaths. The Cornish, Irish, and Mediterranean varieties are among the most vigorous, the latter kind forming an admirable background, while an occasional specimen of *Erica codonoides* imparts relief to the sorts of more spreading growth. In the pool a selection of the best aquatic plants are thriving, our greatest novelties being a couple of pink *Nymphæas*, both now growing freely, and the larger of which had several rich-coloured flowers last year. With few exceptions aquatic plants become established quickly, and spread so freely that some care is required to keep them within bounds, *Aponogeton distachyon* being the greatest offender, sending its seedlings out in such profusion as to crowd out everything else, and yet its flowers are so lovely and so fragrant that one destroys it with regret. Clumps of the bright rosy *Lythrum roseum superbum* and the yellow *Ranunculus lingua* spring high out of the water close by the rocky margin, over which at other places soft green cushions of *Silene maritima* spread downwards to the water.

Along the dell below the pool the small *Typha* is mingled with *Lythrum* and various bog plants in the slowly trickling water, and along the damp margin some *Sarracenas* and *Cypripediums* are now well established, *Cypripedium spectabile* bearing flowers so lovely as to be no unworthy rivals of any of the more delicate species. *Onclea sensibilis* is thriving well and spreading into large tufts, the handsome fronds being larger this year than they have ever been before. *Lomaria magellanica* also answers well, and its large curious fronds are very effective among *Osmundas* and various other Ferns with which it is mingled. Many other plants might be mentioned, but it is hoped that my description has been extended sufficiently to show how much may be added to render a garden additionally attractive without any great outlay, and to induce something being done in many a garden where hitherto a plant or two in a fountain basin has done little, if anything, to illustrate the real beauty of water plants; and a few plants of Heaths arranged in formal rows in a bed have shown nothing of the beauty of bold masses of these universal favourites growing in a state of semi-wildness, and with a freedom and vigour that has much of grace and beauty without an iota of stiffness or formality.—EDWARD LUCKHURST.

COMING FLOWER SHOWS.

THE following are the dates upon which the principal horticultural exhibitions and meetings of June and July will be held, of which we have received schedules, and Secretaries of other Societies will oblige by forwarding schedules to us of any shows not noticed in this list:—

JUNE.

- Tuesday, 26th.*—Royal Horticultural Society, Fruit and Floral Committees at 11 A.M., and Pelargonium Show, South Kensington; Diss.
Wednesday, 27th.—Cardiff Rose Show; Croydon (Roses); Royal Botanic Society's Evening Fête.
Thursday, 28th.—National Rose Society's Show, Southampton; Richmond.
Friday, 29th.—Canterbury (Roses).
Saturday, 30th.—Reigate (Roses); West Kent; Bromley.

JULY.

- Tuesday, 3rd.*—National Rose Society's Show, South Kensington.
Wednesday, 4th.—Wimbledon; Teddington; Norwood.
Thursday, 5th.—Bath (Roses); Kingston; Farningham; Highgate; Hitchin (Roses); Romford.
Friday, 6th.—Sutton (Roses).
Saturday, 7th.—Chiswick, Crystal Palace (Roses); Brockham (Roses).
Tuesday, 10th.—Royal Horticultural Society, Fruit and Floral Committees at 11 A.M. Oxford, Wirral, and Hereford Rose Shows.
Wednesday, 11th.—Royal Caledonian Society's Show, Edinburgh. Hull Show (three days); Ealing.
Thursday, 12th.—National Rose Society's Show, Sheffield; Nuneaton; Braintree.
Friday, 13th.—Ludlow (Roses).
Tuesday, 17th.—Leek (Roses).
Wednesday, 18th.—Nottingham Floral Fête (two days). Darlington (Roses).
Thursday, 19th.—Evening Fête at Chiswick; Aberdeen; Helensburgh (Roses).
Tuesday, 24th.—Royal Horticultural Society, Fruit and Floral Committees at 11 A.M.; Carnation and Picotee Show, South Kensington.
Wednesday, 25th.—Colnbrook.
Thursday, 26th.—Eastbourne.

AUGUST.

- Saturday, 4th.*—Southampton (two days, or three including Sunday); Liverpool (two days, or three including Sunday).
Thursday, 9th.—Beverley.
Wednesday, 15th.—Sutton.
Friday, 31st.—Crystal Palace National Dahlia Show and Fruit (two days).

CHOICE HARDY FLOWERS.

IT is interesting to note the position these begin to occupy in flower shows, and particularly so to observe the keen interest evinced in them by the majority of visitors. Stove and greenhouse plants certainly attract, while Orchids captivate; but there is something peculiarly homely in many of the old-fashioned garden denizens, while the newer kinds of hardy flowers awaken a keen desire to know more about them. Several fine groups were exhibited at Manchester last month, and I noted a few of the most showy and interesting plants there brought together.

Chief amongst the amateurs' collection was that belonging to Joseph Broome, Esq., of Didsbury, carefully grown and staged by his excellent gardener and good botanist Mr. T. Entwistle, whose knowledge and love of hardy plants is well known. Among the alpines was a grand pan of *Sempervivum arachnoideum*, most prettily grown—this is one of the prettiest Houseleeks. *Anemone alpina* and *sulphurea*, the latter being undoubtedly a varietal form of the former, having white and clear sulphur-coloured flowers respectively. These are both charming alpines and well worth having. *Phyteumacomosum*, a very rare species, forming a dwarf tuft, with small globose heads of deep blue flowers about 3 inches high. This is a difficult plant to establish. Secure the crown firmly between two small pieces of limestone, and let the soil be composed of leaf soil, good loam, and grit, and never allow it to

be saturated. *Lychnis pyrenaica* is also a rare plant; the slender stems are terminated by white flowers about half an inch across. *Ranunculus pyrenaica* is less uncommon, but very pretty. It appears very capricious. I know of some places where it apparently refuses to grow, and of others where it increases very rapidly. Ask Mr. Loder of Weedon how it thrives with him. *Ranunculus amplexicaulis* is a very pretty Buttercup, pure white flowers about the size of a shilling, with stout glaucous foliage. This does well in a cool damp position in the border or at the foot of the rockery. *Alyssum alpestre* is by no means a common plant, very dwarf, with straggling stems, terminated with small cymes of yellow flowers. *Armeria setacea* is one of the prettiest and dwarfiest of the Thrifts, forming close radiating rosettes of leaves, from which spring the very numerous small flower-heads of a light pink colour not more than 2 or 3 inches high. I wonder if Mr. Entwistle has *A. juniperina*; if not, it should be a companion of *A. setacea*. *Androsace carnea*, with very fine leaves and pleasing pink flowers, is very charming, and many others made up a most interesting group, and not the least pleasing feature was the labels, which were very neatly and correctly written—an example, *en passant*, which might have been followed by others.

In Mr. Broome's collection several good plants were noticeable. *Cypripedium parviflorum* arrested attention. The leaves are finely spotted with reddish brown, lanceolate in form. Sepals ovate acuminate, about an inch long. Petals $1\frac{1}{2}$ inch long, linear lanceolate, twisted, both chocolate brown and green. Lip nearly an inch long, pouch-like, deep yellow, with the margin of the orifice bright chocolate, the inside spotted with crimson. It is common in the United States, and is one of the very numerous family of hardy Orchids which might be easily cultivated. *Lychnis Haageana* was very bright, with the large brilliant red flowers more than 2 inches across. Our native Orchid *maculata* revealed its beauty when massed together as exhibited. St. Bruno's Lily (*Anthericum Liliastrum*) is very handsome with its white Lily-like flowers and grass-like leaves. *Cardamine pratensis* fl.-pl. The old *Spiraea Ulmaria plena* is welcome at all times, although forced into bloom: this is a plant far too seldom seen in our gardens. *Thalictrum purpurascens* is indeed a very fine species; tall-growing, with dense heads of pale purple flowers, most effective with the elegant leafage. The Fair Maid of France (*Ranunculus aconitifolius plenus*) was very striking with its small white rosette-like flowers, each one of great service in floral work. This is one of the finest hardy flowers extant. *Lychnis viscaria* fl.-pl. also showed up well with its racemes of deep rose-coloured flowers; very lasting and hardy, forming nice cushions of greenery on the rockery or in a warm sunny border. *Delphinium tricornis* also in good condition—and this is rare—very dwarf, less or not more than a foot high, with pale blue flowers. Native of N. America. *Narcissus bicolor* was staged by Mr. Joseph Way of Kirkham. This is the latest of the Trumpet section. Some cultivators tell us there is a form named *bicolor maximus* which is even later.

Noticeable in the excellent collection of Messrs. James Dickson and Sons of Chester were the following. *Tulipa retroflexa*, a bright yellow-flowered kind; very showy. *Mertensia virginica*, which is an excellent border plant, much less common than it should be. *Lilium Thunbergianum atro-purpureum*, a very dark-coloured variety tinged with purple. *Dielytra spectabilis alba* was also in excellent condition, being a good colour and well flowered. *Dianthus hybridus Napoleon III.* indicated its usefulness for supplying good flowers; perfect little Pinks are the flowers, of a deep crimson colour, with stiff footstalks, so that they can be easily wired, and they stand remarkably well after being cut. *Eulalia japonica variegata*, a very fine specimen of which was shown, is really the finest hardy variegated Grass I am acquainted with, and gracefulness of form and variegation render it strikingly effective. There were many other plants which might be mentioned in this group, but space forbids. In Mr. Brownhill's collection *Cypripedium pubescens* (shown under the name of *calceolus*) and *C. spectabile* were conspicuous. These are both excellent border flowers. It is a pity that *N. odoratus* var. was exhibited as *N. juncifolius*, which is quite a different plant, much earlier and smaller in all parts than those shown. The various forms of *Primula Sieboldi* were very showy, and gave good evidence of the value of these Japanese Primroses for garden or house decoration. *Dodecatheon Meadia album* was in excellent condition. This is one of the best forms of the American Cowslip: flowers pure white, freely produced. The variety named *splendens* (*D. integrifolium*) is a charming companion; flowers deep magenta, very freely produced. Both grand plants enjoy a damp situation to grow in.

Amongst the alpine plants the two finest in my opinion were *Viola pedata alba* and *Onosma taurica*, both in Messrs. Dickson's collection. The *Viola* is a gem with its numerous pure white

flowers nestled amongst the leaves; it is quite hardy, very showy and useful. The *Onosma* is proverbially a difficult plant to manage, but this plant was crowded with flower spikes; it enjoys a rich stiff soil, and a good depth of it.

Messrs. Roger, McClelland & Co. of Newry exhibited a most interesting collection of hardy flowers. They were not only greatly appreciated by the specialist in hardy flower culture, but by the general public. Baskets of Anemones in various colours, Oxlips, and Pansies, while a multitude of other gems made up the collections. A list of a few must satisfy my readers, as a detailed description would occupy far too much space. Hardy Orchids, many varieties; *Primula Balbisi*, *Dianthus glacialis*, *Gnaphalium alpinum*, *Romanzoffia sitchensis*, *Gillenia stipulacea*, *Iberis gibraltarica hybrida*, *Dodecatheon integrifolium*, and *Gentiana verna*,



Fig. 117.—The Kittatinny.

all of which are worthy of culture. It is gratifying to see such encouragement given to hardy flowers, as these displays enable gardeners to appreciate the great value of hardy plants for decorative purposes.—RAMBLER.

AMERICAN BLACKBERRIES.

I AM told by a person who has resided in America that the Brambles there are thrice the size of ours, and that if we exercised the same care in culture as they do "over there," we might improve our wilding and have as fine Blackberries as they have. I should be glad to know if this is so, as I have as luxuriant Brambles as I can imagine growing in deep rich soil, yet they produce nothing like the fruit that I have heard of, but not seen. I should be glad of any information on the subject, as I confess I am a little suspicious of "tall talk" on this matter.—J. E. D., Devon.

[The large-fruited kinds referred to are not descended from our

common Bramble; they are varieties of an American species, *Rubus occidentalis*, popularly called the Western or Virginian Raspberry. The Kittatinny is a favourite variety in America, and is represented in the figure. They do very well in this country.]

HISTORICAL JOTTINGS ON VEGETABLES.—No. 5.

THE BEAN.

WE cannot say that the Bean, a plant which formerly had a renown for various reasons besides its value as an edible, has entirely lost its old fame. Some folklore yet survives connected with its name, for do not the employés in many houses of business or manufacture still hold their annual bean-feasts? Beans may, or may not, form part of the repast; generally they do, since these excursions take place in the summer as a rule, but the Bean once gave them a sacredness they have no longer, for there is evidence that such jovial assemblies of fellow workmen—still held—lead us back to ancient festivals of Pagan times when Beans were offered in sacrifice made up into cakes. And it may also have been the case, as some think, that the Bean being regarded as a token of good luck, our superstitious forefathers considered that a feast named from this vegetable would be likely to result in a year of prosperity to master and man alike. There was, too, an old custom we have most of us read of, by which a Bean was placed in the Epiphany or Twelfth-tide cake, and when this was cut up he was regarded as a fortunate person to whose share fell the slice in which the Bean was lodged.

The Egyptians and the early Greeks did not agree amongst themselves as to the place the Bean should occupy. While some ate the vegetable others inclined to worship it, holding it sacred to the dead because of the black spot left on the point of attachment to the pod. Amongst the patriarchs of Syria, before Jewish history began, the Bean, like its ally the Lentil, had probably a favourable repute, and the Rabbis state that after the Israelites settled in Palestine they planted the Egyptian Bean there, which was, however, forbidden to the priests on particular occasions lest it should make them drowsy. Some of the Westerns held quite an opposite idea; they believed that Beans were to be shunned as foes to tranquillity of mind. In Italy the Romans grew Beans many centuries before the Christian era, and the Fabian family took its appellation from the plant. Pliny notes that it was usual to set them during the later autumn, so that they might winter underground; but in some parts of Greece the plant was disrespectfully treated, for rows of Beans, just as they came into flower, were ploughed in by the farmers to fertilise the soil. This old naturalist's view that North Africa is the habitat of *Vicia Faba*, the seeming stock of our many garden varieties of Bean, is likely enough to be correct; and then, so several authors tell us, the Moors brought the vegetable to Spain. Through Spain it subsequently came to England, perhaps; but one cannot be positive as to how long the Broad Bean has been cultivated in our island. It preceded the Kidney Bean, and was evidently well known in the days of the Edwards and the Henries, possibly for centuries, cultivated more as a food for horses and cattle than for mankind. Gerard, writing in the sixteenth century, does not commend the vegetable particularly, though he remarks it was one that could be much improved by a rich soil.

The mention in old books upon gardening of Spanish and Portugal varieties of the Bean certainly indicates the introduction of Beans from the Peninsula to England at a later period at least. An old variety of forward character, the Mazagan (also called Maragan) Bean, is stated to have come from Morocco. The Sandwich Bean may be really French, for about the year 1530 refugees driven from France by religious persecution landed at Sandwich in Kent, formed gardens near that place, and gradually pushed their way towards the metropolis. Another arrival of Beans belongs to the reign of William III. The Windsor Bean is attributed to some one of his Dutch gardeners, and a field not far from that town used to be pointed out as the first producer of a crop of this sort. One of the old cries of London that is chronicled for us in a quaint collection of ballads is "Ripe Beans;" but this may have referred to the Kidney Bean, and not the Broad Bean, as the former used to be vended when the seeds had grown to their full size in the pods, from which they were taken and fried, cut up, boiled or baked. Shredding the entire pod while it is not yet matured is a modern style of preparing the Kidney Bean and Scarlet Runner for the table. The Romans, indeed, did bring into their banquets the entire pod of this Bean, which was served up with vinegar and spice at the commencement in order to give appetite for the succeeding dishes; it was evidently eaten raw. And a passing remark of Gerard's intimates that during the reign of Elizabeth some persons ate the young

pods boiled whole if the more general and economical practice was to allow the Beans to ripen in their pods before gathering.

Haricot Beans, produced by a variety of the Kidney Bean, are still much liked on the Continent, and moderately patronised in Britain; and it somewhat favours the theory that the Kidney Bean is a native of the sunny East that the flavour of its seeds is superior when they are grown in Asia or Africa, or in such regions of Europe as "sunny Italy"—by report, however, less sunny these recent years than it used to be. Alexander the Great, not much honoured as a benefactor to his race, is yet credited with the introduction of the Kidney Bean to Europe, he having had his attention drawn to the plant growing in a field across which he was marching; but the tradition is doubtful, only we are assured this species of Bean was well known in ancient Greece and Italy. As some folks called it the "Roman Bean," when referring to it during Queen Elizabeth's reign, an Italian variety must have reached our island then, yet this kind was not the pioneer. This seems to have been the white Dutch Kidney Bean, brought over from the Netherlands about 1509. Gerard calls it the "Sperage Bean" and the "long Peason." He evidently considers it more akin to the Pea than it is to the Broad Bean. The Battersea Kidney Bean is one of the few varieties often mentioned by gardeners of the eighteenth century, that moist district of Surrey formerly yielding very abundant crops of this vegetable.

A year or two ago the march of improvement led to the removal of an old Lambeth residence, called Turret House, which had, in fact, escaped destruction longer than might have been anticipated. It was a house not uninteresting to all lovers of horticulture, for in a building more ancient than stood on the spot (a portion of which was incorporated with a newer structure) lived the Tradescants, father and son. Of the elder Tradescant it was said that "he first introduced botany to this country;" the younger is credited with the introduction of exotic Ferns; both, indeed, imported and grew a variety of rare plants. Their garden ground was in the vicinity of the South Lambeth Road, and its fame attracted visitors from remote places; but, alas for local popularity, the neighbours perverted the name to "Tradescin," and the son fared badly in consequence of the troubles arising that ended in civil war, for he held an appointment under Charles I. It was in 1633, for the date seems to be unquestionable, that Tradescant brought from South America the Scarlet Runner without any idea of its economic value. The seeds were sown at Lambeth, and the plants allowed to cover trelliswork and walls, attracting notice by their scarlet bloom, which was gathered for nosegays, but the pods remained in neglect until Miller pointed out that they were edible. It was not until the reign of George II. that he drew the attention of the slow-moving English public, leading people to cultivate Scarlet Runners as an adjunct to the Bean crops. A white variety of this kind, mentioned by Abercrombie and others, became somewhat a favourite in London gardens.

We should add that the Lentil (*Ervum Lens*), the powder of which under fancy names is so persistently bepudded now-a-days, has never been grown to any extent in this island for the purpose of supplying food to mankind. Disregarding the opinion of the ancients, who set store by the Lentil because its pottage was nutritious and invigorating, English gardeners, after growing a few specimens at the time of its introduction, about 1548, left the plant to the farmers, by whom Lentils were cultivated during some years only as a cattle food. There once were fields of Lentils near London, and in some of the midland counties they grew large crops formerly.—J. R. S. C.

YORK FLORAL FÊTE.

JUNE 13TH, 14TH, AND 15TH.

A QUARTER of a century of flower shows is a long period to look back upon, and when a career of such a length has been as satisfactory as that of the York exhibitions it must afford much pride and gratification to those who assisted in the inauguration and in the subsequent support of such an institution. The York Floral Fête has gradually become one of the most popular holidays in the north of England, and it still appears to be growing in general favour year by year. Thousands of visitors assemble from all the chief northern towns, and the fact that the railway companies should find it necessary to run some fourteen or fifteen excursions to the town on the second day of the Show is a good indication of the reputation it bears. This second day is the most popular one, and on Thursday last no less than 24,000 persons passed the gates, bringing the substantial sum of something like £1200 into the coffers of the Society.

Horticulturally the Exhibition was very successful; perhaps in some classes there have been more numerous entries at some previous shows. The large specimens which were arranged upon the central

circular stage were not so abundant, and in a few other classes a slight falling-off was observable; but, on the contrary, to compensate for this, some other classes were more than usually well filled, the competition being keen and the exhibits highly satisfactory. These remarks especially apply to the Pelargoniums, which were magnificent, and the large marquee devoted to them was alone worth a long journey to see. Ferns, too, were in stronger force, both hardy and exotic, and very rarely do we see such healthy vigorous specimens staged; indeed, there was scarcely one that was not in highly satisfactory condition. Then, too, the Roses in pots were an important feature, mostly superior to the exhibits in the same classes at several preceding shows; while groups, bedding plants, stove and greenhouse plants, fine-foliage, and many other plants were all contributed in large numbers.

The general arrangement was similar to that adopted at previous Shows—one large central circular tent, with a stage in the middle, contained the large specimen stove and greenhouse plants and Ferns, while from this radiated six long marquees, devoted respectively to Pelargoniums, Roses, fine-foliage, Ferns, groups, fruit and vegetables. The tents are very spacious, each having a stage in the centre and one round the sides, so that an enormous amount of produce can be accommodated. Of course tents thus formally arranged do not admit of any artistic effect being produced, such as can be done at Regent's Park; but the respected Secretary, Mr. J. Wilson, does the next best thing—he studies the convenience of exhibitors and judges, the entries in the respective classes being placed together, and the public also thus have a better opportunity of comparing the merits of the exhibits than when they are scattered over a large tent, and perhaps after all not producing a more effective display.

PELARGONIUMS.

These deserve prominent notice, because they undoubtedly constituted the chief feature of the Exhibition, and, beautiful as they always are at York, they were even finer than ordinary on the occasion now being noted. A grand central bank of Show and Zonal varieties was simply unique, the plants being in fine condition, well and neatly trained without being too formal, the flowers most abundant, and the colours very clear and bright. The side stages were principally occupied with the Bronze and Tricolor varieties, which are always so well shown there, better probably than at any other exhibition in the kingdom. Fancy varieties were not numerous, and rarely are, which is greatly to be regretted, as the plants staged are invariably admirably grown though of moderate size, and they serve to break the uniformity of the other types, being so distinct in character. The class for twelve Show varieties was the principal one of that section, and in that Mr. C. Rylance, Ormskirk, took first honours with superb specimens as nearly perfect as possible; such well-known varieties as Claribel, Amazon, Jewess, Grandiflorum, and F. A. Dickson were all in grand condition. Mr. Eastwood, gardener to Mrs. Tetley, Foxhill, Westwood, Leeds, was a close second, his most noteworthy varieties being Queen Bess and Kingston Beauty. Messrs. Lazenby & Sons, York, followed; Mr. H. May being awarded an extra prize. These four collections nearly filled one side of the central stage. On the other side were the Zonals, and for twelve plants Mr. Eastwood was again successful in obtaining the first place, some of his finest examples being Lucy, Caxton, Masterpiece, Princess of Wales, and Lord Derby. Mr. J. Carter, gardener to J. Bellerby, Esq., Burnholme, Heworth, York, was a good second, other prizetakers being Messrs. R. Simpson and Hingston. Messrs. Eastwood, May, and Rylance were the principal exhibitors of Fancy varieties, which, as already stated, were not very large or abundant. The Bronze and Tricolors were, however, far more numerous, and most of the best varieties in cultivation were represented by well-grown, healthy, richly coloured plants. The Rev. — Gardner and Messrs. Cholmley, Rylance, and Jackson secured the majority of the leading prizes in the various classes for these plants, all exhibiting well.

GROUPS.

Though the competition was not remarkably keen in the classes for groups arranged for effect, the collections entered were sufficiently close to cause a little difficulty in determining the awards, at least in one class—namely, that for a group to occupy a space of 250 square feet. In this there were four competitors; Mr. Berry, gardener to W. Dove, Esq., York, securing the chief honour for a light, graceful, and bright group, but a little formal in shape—a square with rather sharp corners. The foliage plants comprised Dracaenas, Cordylines, Palms, and Coleuses, the latter with Pelargoniums, Ericas, and other flowering plants forming a pretty groundwork surrounding the larger specimens. The margin of variegated Panicums was pretty, and the whole group was very pleasing. Mr. McIntyre, gardener to Mrs. G. Pease, Woodside, Darlington, was placed second, and in the opinion of some this deserved a higher position, and it was undoubtedly very close in merit to the first. Its merits were a light and very informal margin and graceful outline, and its defects a slight tendency to crowding in the centre, and scarcely sufficient colour. It could, however, easily have been rendered equal to or even superior to the first. Mr. R. Simpson, Selby, was accorded the third position for a group arranged in a similar style to the two preceding, but much more crowded; Messrs. Bailey of Fulford taking the fourth place with a collection to which the same remark applies. In the other class for a group to occupy a space of 150 feet Mr. McIntosh,

gardener to J. T. Hingston, Esq., Clifton, York, took the lead, having a bright collection of ordinary fine-foliage and flowering plants. Mr. J. Noble, gardener to T. Fry, Esq., M.P., Woodburn Gardens, Darlington, and Mr. A. Scott, gardener to J. Buckle, Esq., Monkgate, York, were respectively second and third.

STOVE AND GREENHOUSE PLANTS.

The great class for these is always that for ten specimens, in which prizes of £20, £14, and £8 are offered. These usually bring some fine collections, but this season both Mrs. Cole's and Mr. Tudgey's plants were missed. Mr. Letts, gardener to the Earl of Zetland, Ashe, Richmond, was awarded first honours for very handsome specimens of considerable size, the fine-foliage plants being especially large. Croton Queen Victoria, Cycas revoluta, and Croton majesticus were in grand condition, extremely vigorous, and the Crotons beautifully coloured. Amongst the flowering plants the finest was a magnificent specimen of Anthurium Schertzerianum with sixty or seventy large richly coloured spathes, and for which the Veitch Memorial medal and prize of £5 for the best stove or greenhouse plant in the Show was deservedly awarded. Other good plants were Ixora coccinea and Allamanda grandiflora, both well flowered. Mr. J. Cypher, Cheltenham, secured the second prize, his two leading specimens being Cycas revoluta and a wonderfully fine Erica Cavendishiana 6 or 7 feet in diameter, the same height, and flowering abundantly. The third prize was awarded to Mr. Noble for rather small but healthy plants. For six specimens Mr. Letts was again the leading exhibitor, having a plant of Allamanda Hendersoni 6 feet high by 6 feet in diameter, and most profusely flowered, a good Ixora coccinea, and Dipladenia amabilis in superb condition, with fifty or sixty large and richly coloured flowers. Mr. Berry was second, and his best plant was Clerodendron Balfourianum 8 feet high. Mr. Sunley, gardener to W. M. Champion, Esq., Halifax, took the third place with plants of average merit. In the class for three specimens Mr. Rollisson, gardener to W. Bateman, Esq., Harrogate, was the principal exhibitor, gaining the first prize, Kentia Fosteriana and Croton variegatus being remarkably good.

ORCHIDS.

It is regrettable that more attention is not given to Orchids at the York Fête, as it occurs at a time when a very fine display might be readily obtained. It is true a three-days show is rather too long for choice Orchids, but if some kind of special provision was made for them it would be a great additional attraction to the Show. Only three classes are devoted to them, and the prizes are not very high in amount. For six plants Mr. Mitchell, gardener to Dr. Ainsworth, Broughton, Manchester, won chief honours with fairly good specimens, principally, however, "made up." Phalænopsis amabilis was very notable in this respect, quite a number of plants being placed together, though these, it must be stated, were flowering well. Aerides Lobbi Ainsworthi had a fine spike of its rich rosy crimson flowers, and Phalænopsis Luddemanniana was good. Mr. Cypher had well-grown examples of Cypripedium Lawrencianum, Aerides Fieldingi, and Odontoglossum vexillarium, the latter a genuine specimen of moderate size and very healthy, and with nine or ten fine spikes of dark-coloured flowers. Mr. E. Bridge, Greenhill, Hington, was third, Cypripedium villosum being his finest plant. Mr. Mitchell was also first with three Orchids—Dendrobium Parishii superba, a finely coloured variety of this beautiful species, Phalænopsis grandiflora with four spikes, and Saccolabium præmorsum with three spikes. Mr. Eastwood was second with several good plants, but his finest was Aerides Fieldingi with two spikes, one with three branches, the central one a foot long, and for which the Veitch Memorial prize for the best Orchid in the Show was awarded. Mr. Mitchell had the best single specimen, Vanda Dennisoniana, with fourteen flowers on two spikes.

FERNS.

Well-grown specimens of Ferns always contribute greatly to the beauty of an Exhibition, and this was very decidedly the case at York in all the classes. The largest specimens were those in the class for eight exotic Ferns, in which Mr. Berry was adjudged the leading prize, Gleichenia rupestris glaucescens, nearly 8 feet high and 6 feet in diameter, Cyathea medullaris, 10 feet high, was similarly noteworthy. Microlepia hirta cristata in fine vigorous health being one of the largest examples of this fine Fern we have seen exhibited. Messrs. Bailey and Noble followed; each had good plants, but considerably smaller than the first-prize lot. The best four exotic Ferns were staged by Mr. A. Scott, gardener to J. Buckle, Esq., Monkgate, York, Todea superba and Adiantum gracillimum being the two finest examples in his collection; Mr. Wright, gardener to G. Talbot, Esq., Southfield, Burley, Leeds, being a very close second with Pteris scaberula in fine form, and Gleichenia Mendeli in similarly good condition. Mr. G. Lister, gardener to H. S. Brogden, Esq., Heworth Hall, York, was a good third. In the hardy and British Fern classes the prizetakers were Messrs. W. R. Robinson, Scott, Rodwell, and Rylance, who contributed a great number of beautiful specimens. Very noteworthy in Mr. Robinson's collection was a noble Struthiopteris pennsylvanica, the Athyriums and Lastreas being represented by a number of handsome varieties. Three beautiful collections of Selaginellas were staged, Mr. Scott winning chief honours with good pans of Wildenovii, Martensii, cæsia, and stolonifera. Mr. Berry was a close second, and Mr. McIntyre third, each with similar varieties.

ROSES.

A large tent was almost filled with Roses in pots, and, as already remarked, they appeared in much better condition than usual, at least as regards the leading collections, the plants being extremely vigorous and well flowered, the blooms large and the colours clear. Messrs. Pybus & Son, Ripon; H. May, Bedale; and Jackson & Co., Bedale, were the principal exhibitors and prizetakers in the open classes, and they nearly equally shared the prizes between them. Several very good plants of Princess Mary of Cambridge were shown, and Abel Grand was similarly notable in two or three collections. Madame Nachury, Paul Neyron, and Duchesse de Caylus were also good. The leading amateurs were Mr. Fieldhouse, gardener to Miss Steward, The Laurels, Bishopsthorpe, York, Mr. McIntosh, and Mr. Eastwood, who had some good plants, but their beauty was impaired in a great measure by the large straight pots employed.

FINE-FOLIAGE PLANTS.

In the class for eight specimens Mr. Noble won the leading prize with fine Palms and Cycads, vigorous healthy specimens. The smaller class for four fine-foliage plants was better filled, Mr. Rollisson taking the chief prize with *Cycas revoluta*, *Cocos Weddelliana*, and *Dion edule* in first-rate condition; the latter was especially fine. Mr. Letts followed closely with *Dasyllirion acrotrichum* and *Croton Mortii*, the last-named having particularly large richly coloured leaves. Mr. Berry had the best single specimen, a fine example of *Dæmonorops fissus* 9 feet high. Mr. McIntyre was the leading exhibitor of four *Crotons*, plants of moderate size but richly coloured. The *Coleuses* were not quite so large as customary, but mostly very neat conical specimens and extremely well coloured, especially so in the collection from Mr. Lazenby, gardener to the Rev. G. E. Gardner, Heworth Vicarage, York, for which the first prize was awarded. Mr. Stephens, gardener to J. Bellerby, Esq., Heworth, was a close second with plants of similar size and form, Messrs. Bailey & Sons taking the third position.

Bedding plants, Fuchsias, and Gloxinias were well exhibited, the principal prizewinners being Messrs. R. Simpson, McIntyre, Rodwell, Buckle, Baker, Lazenby, and Dawe. Table plants were similarly well represented, most of the plants being very neat and suitable for the purpose. Tuberous Begonias, Dracænas, and alpine plants were well exhibited by Messrs. Rodwell, Simpson, Bailey, Berry, and Fry.

For table decorations and bouquets Mr. Cypher was the most successful, Messrs. Wilson, Talbot, and Rutherford also securing prizes. Cut flowers were not very abundant, but mostly fresh and bright.

FRUIT.

The exhibits in these classes were not quite so numerous as is generally the case, but the quality was fairly good, though the white Grapes were not quite satisfactory, some being so green that it was a pity they had been cut. The chief class was that for eight dishes of fruit, Mr. G. T. Miles, gardener to Lord Carrington, Wycombe Abbey, Bucks, securing the principal honours for good bunches of Black Hamburg and Foster's Seedling Grapes, an even Queen Pine Apple, Empress of India Melon, Elruge Nectarines, Brown Turkey Figs, and Black Circassian Cherries very fine. Mr. J. McIndoe, gardener to Sir J. Pease, Bart., M.P., Hutton Hall, Guisborough, was a close second, the best dishes in the collection being the Black Hamburg and Muscat of Alexandria Grapes, with a good fruit of Best of All Melons. Mr. Westcott, gardener to the Duke of Cleveland, Raby Castle, Darlington, was third, the Black Hamburg Grapes being fine in bunch and berry, but rather rubbed. For six dishes Mr. J. Clayton, gardener to J. Fielden, Esq., Grimston Park, Tadcaster, won chief honours, having good examples of A Bec Peaches, Violette Hâtive Nectarines, and Black Hamburg Grapes. Equal second and third prizes were accorded to Mr. McIndoe and Mr. Wallis, gardener to Sir H. M. Thompson, Kirby Hall, York, who each showed creditable collections. The prizetakers for four dishes were Mr. A. Wilson, and Mr. Elphinstone, gardener to E. M. Mundy, Esq., Shipley Hall, Derby.

Grapes were fairly represented, the black varieties being in better condition than the whites. Mr. Wallis had the best three bunches of Black Hamburgs, gaining the first prize in the class. The bunches were of fair size, the berries large, and the bloom good. The Veitch Memorial prize for the best examples of black Grapes in the Show was awarded to Mr. Clayton, who had three fine bunches well coloured and with large berries. Messrs. Elphinstone, McIndoe, and A. Wilson were the prizewinners for white Grapes, the first-named having Muscat of Alexandria, large and fairly ripened. Peaches, Nectarines, and Melons were not very largely shown. There were, however, five entries for Messrs. J. Carter & Co.'s prizes for two Melons, Carters' Emerald and Blenheim Orange, Messrs. Rodwell and Neville being the successful exhibitors.

Tomatoes were especially good, ten dishes of twelve being staged in the class provided. Mr. Miles took the lead with beautiful examples of Hathaway's Excelsior—even, large, and finely coloured. Mr. McIndoe followed closely with Stamfordian, also very even and fine. Mr. Wadds, gardener to Lord Middleton, Birdsall, York, was third with the same variety, being slightly inferior in quality. Mr. Wadds was first in this class for a brace of Cucumbers with good samples of Telephone—neat, even, and with good colour; Mr. Thellusson being second with Yorkshireman, and Mr. C. Rylance third with a similar variety.

Vegetables were not largely shown, but three fine collections were staged for Messrs. Backhouse's prizes, Mr. Miles taking the lead with excellent specimens of Pride of the Market Peas, Stamfordian Tomatoes, Tender-and-True Cucumbers, The Queen Onions, and Canadian Wonder Beans—all very even, clean, and good. Messrs. H. Wilson and Cholmeley were second and third respectively.

Special prizes were also contributed by Messrs. J. Laing & Co., Forest Hill, for Tuberous Begonias; Paul & Son, Cheshunt, for Rose blooms; Burley & Son, Fulford, for Tuberous Begonias; Laird, Edinburgh, for Pansies; Cranston Nursery and Seed Company, Hereford, for Rose blooms; Lazenby & Son, York, for bedding plants; H. May, Bedale, for Rose blooms; and G. E. Elliott, Huddersfield, for Cucumbers, all the classes bringing numerous competitors.

Miscellaneous exhibits were not very numerous, but Messrs. R. Smith & Co., Worcester, had a good collection of Clematis blooms; J. Laing & Co. Tuberous Begonia blooms; and Laird of Edinburgh Pansy and Viola blooms.

THE GREENHOUSE AND ITS INMATES.

SYRINGING.

THE syringe is an indispensable instrument wherever there are any number of plants. Its use is to spray water on to the plants for the purpose of refreshing or clearing them of dust, insects, &c. On the evenings of hot summer days a gentle shower of clear water of the same temperature as the house promotes luxuriance among greenhouse plants. Dust, and in towns soot, sometimes cover the leaves, and a dashing shower from the syringe helps greatly to keep them clean, although there is nothing like a sponge and soft soapy water for properly cleaning dirt-becovered plants, especially the kinds having large smooth leaves. Aphides are sure to appear among a miscellaneous collection of plants. A dash from the syringe will remove and destroy many, and the same instrument may be used for distributing soft soapy or tobacco water, both of which if properly, timely, and repeatedly applied will prevent its appearance. Water, if plentifully applied, will soon put an end to any attack of red spider.

PLUNGING.

Many greenhouse plants may be placed outside with advantage during the summer months, such as Camellias, Azaleas, Tea Roses, Callas, Cytisuses, and many other plants, after their growth is made. The pots require to be plunged, so that the roots which cluster round the sides of the pots may be kept in a cool moist condition; for when the pots are exposed to the full blaze of the summer sun the soil is rapidly dried, as well as heated, to an extent which causes destruction to the young active roots, to say nothing of the greater necessity for more frequent supplies of water. Plunging provides against all this, and should always be practised. The very best material to plunge the pots in is ashes. Plunging in common garden earth is commonly practised; but it is not a good plan, for worms find their way into the pots, to the detriment of the roots and injury to the plants. Worms do not pass readily through ashes, and therefore ashes should be chosen for the purpose. Tanners' bark, leaf soil, and cocoa-nut fibre refuse are often used for the purpose, but all are bad for the same reason that common earth is.

FUMIGATING.

Through neglect, or otherwise, plants which are liable to be attacked by aphides become so badly infested that they can only be cleaned by being fumigated. When only a few plants are infested they may be placed in a frame, but when green fly is all through the house it is best to fill the house full of smoke at once, unless it adjoins and opens into the dwelling house. The operation should be done on a still evening, and care should be taken that any apertures where smoke may find an exit are properly closed. The foliage of all affected should be slightly dewed over with the syringe, so that the smoke may "hang on" the better.

Some of the advertised fumigators should be used, as they greatly facilitate matters, but these handy appliances are not altogether necessary. A common 8 or 10-inch flower pot, according to the size of the house to be fumigated, will do. The tobacco or tobacco paper should be separated into flakes, and if at all dry damped a little, so that it may not take fire and burn. A little damp moss should also be had in readiness to apply should burning be imminent, for burning will prevent the production of smoke, and it is a dense column of smoke which should be produced. Having all these things in readiness, as well as two bricks to stand the pot on, so that the air may be allowed to enter by the bottom hole, a few red-hot cinders should be placed in the bottom of the pot, and over that a few pieces of charcoal, which will grow red and carry on the burning as long as may be necessary. As soon as the charcoal ignites some of the tobacco paper should be put on the top, and a little be added from time

to time until the pot is full enough, when a layer of damp moss may be placed on top to insure the production of a dense cool smoke. The apparatus should be watched from the outside to see that no flame breaks forth, and for this purpose it should be quite close to the door, so that one may be able to open the door, place on a little damp moss if necessary, and be out again before any considerable amount of smoke has escaped. Next morning the plants should be well syringed, and the ventilators opened in time to allow of the moisture being early dried.—J. H.



[By the most skilful Cultivators in the several Departments.]

KITCHEN GARDEN.

Celery.—This important winter crop should now have the best of attention. Many wait in the hope of rain falling, but planting should not be delayed too long on account of dryness, as the plants may become too large and suffer from overcrowding. Where plants are from 4 to 6 inches high they should be put out at once, and copious waterings given to them twice or three times weekly until they are established or well supplied with rain. The trenches should not be more than 6 inches deep, and they may be made wide enough to hold from one to half a dozen rows, according to the fancy of the grower. We prefer growing only two rows in each trench, as the Celery is then most convenient for earthing. It is generally understood that plenty of manure is necessary to produce the best Celery, but of all manures which can be used for the purpose none is equal to that from earth closets.

Broccolis, Brussels Sprouts, and Savoy.—These should be planted at every opportunity. Where the plants have been transplanted they will now lift with soil adhering to the roots, and if planted in this state it will be a great advantage, but where they have to be pulled up from the seed bed they must be dibbled in and watered immediately afterwards. Such plants are always put out by us in the evening, and by the following morning they have revived a little, and although they fall down under the influence of the sun they do not suffer severely.

Asparagus.—This is now growing freely, and no more heads should be cut after this time. On the first rainy day a surface dressing of salt and guano, or salt and soot, should be given, and this will keep them growing for the remainder of the season. We put a small handful round each root, and it is soon washed down. Where the stems are becoming tall and liable to be blown over they should be secured to stakes. At present some of our Asparagus growths are 8 feet high, and we have had to put larch stakes upwards of a thousand plants. The young plants from seed sown in spring are now several inches high, and where they are crowded the weakest should be drawn out. Frequent hoeings must be carried on to prevent the spread of weeds.

Seakale and Rhubarb.—These are throwing up flower spikes, and unless seed is wanted cut away the flowering shoots as soon as they are seen. Tender young Rhubarb may be secured very late by drawing the old stems off now and causing the roots to throw up fresh growths. This is a good way of securing Rhubarb in autumn suitable for exhibition.

Tomatoes.—These are getting over their first strong flush of growth, and as their rooting space becomes filled we find them more disposed to form fruit than run to wood. If any which have outgrown the positions are cut down and allowed to grow up again they will produce a very satisfactory second crop. Where the crop is excessive some of the most forward of the green fruits may be cut off and hung up to ripen in a dry warm place. Later fruits will then come forward quicker and finer in quality than would otherwise be the case. Outdoor plants growing against walls should only be allowed one stem, as superfluous growth retards fruiting.

Crops Failing.—It will now be seen if any of the main vegetable crops are likely to fail, and if any indication of this is shown sow more of the same at once, and with a favourable soil and situation a serviceable crop may be secured before winter sets in.

FRUIT FORCING.

Figs.—The second crop in the early house will now have attained a good size, and judiciously thinned the trees will swell off a full crop of fine fruit, the foliage of course being kept free from

insects, and the roots well supplied with nutriment. Second crops of Figs as a rule do not require much artificial heat, but during cold sunless weather it is absolutely necessary not only by night, but frequently in the daytime; and as moisture alone does not always keep red spider in check, an insecticide or the use of sulphur on the pipes must be resorted to, and before the pest has obtained a firm hold. Borders that were allowed to become somewhat dry during the ripening of the first crop of fruit must be brought into a thoroughly moist condition by repeated waterings through a good mulching material. If the second crop needs further thinning it ought now to be attended to, and where there are succession houses to follow choice should be made of the most forward fruit growing near the base of the shoots, as they ripen first, and give more time for the young growths and the trees to be rested early in the autumn. Syringe freely twice a day in fine weather. Commence ventilating early on fine mornings, and close at 80° or 85° with sun heat. With the fruit changing colour in succession houses more air should be given with a gradual reduction of moisture, exposing the fruit to the influence of the sun as much as possible. Attend to tying and stopping in late houses, keeping work of this kind well in hand, guarding against crowding the young growths, and allowing room for the access of light and air.

Peaches and Nectarines.—In the early house some careful treatment is necessary for some time after all the crop is gathered. The trees so soon as the fruit is all off should be thoroughly cleansed of insects by frequent washings with the syringe or garden engine, and if this is not sufficient an insecticide must be applied, as the foliage must be kept clean and healthy. The borders must be kept mulched and plentifully supplied with water, and if the trees are at all weakly apply liquid manure. All shoots rendered useless by the removal of the fruit should be cut out to give place to growths of the current year, in order that the buds by exposure may be properly formed and ripened. Care must be taken that by premature ripening of the foliage the buds do not get too far advanced before autumn weather sets in, or they will probably flower too early. Ventilation should be liberal, and the entire removal of the lights at the beginning of July will greatly benefit the trees. Keep all gross shoots pinched, and side shoots stopped to one or two leaves in order to equalise the flow of the sap. Former instructions with regard to succession houses—that is, tying and regulating the shoots, syringing and ventilation, must have attention. When the fruit is stoned all that on the under side of the trellis should be turned up to the influence of the sun and air so as to colour well, as colourless Peaches are not much prized. Trees in late houses may now have their final thinning and tying, and in the case of unheated houses aim at short-jointed well-ripened wood, which can only be maintained by occasional autumnal root-pruning, free ventilation, and closing early with sun heat.

Cucumbers.—These are now being produced in such numbers that they cause a heavy strain on the plants, and good feeding must be attended to. Where the mounds in which the plants are growing are completely filled with roots, as will generally be the case, a top-dressing of rough rich material composed of half loam and half manure should be given. Other plants not requiring this addition should have liquid manure twice weekly. The leaves and fruit should always be thinned before they crowd each other. Where Cucumbers have been bearing for the last three months, and are not likely to continue to do so until autumn, some young plants should be ready to plant out in a month hence. These we raise from cuttings from the old plants, and root them in gentle bottom heat, plants so raised being more sturdy in growth and earlier in fruiting than seedlings.

PLANT HOUSES.

STOVE.—Crotans.—Young plants that have been rooted from time to time will now need attention, and must be transferred as they require it into larger pots. The tops of plants rooted early in the season and now established in 6-inch pots should, if properly treated, be highly coloured and in the best condition for decoration. Where plants in larger pots can be employed place some of the most promising in pots 2 or 3 inches larger, in which noble specimens will be produced, with bold large foliage down to the rims of the pots. To have the foliage of these plants highly coloured grow them close to the glass and fully exposed to the sun. Look diligently after thrips, for if it becomes established on these plants their beauty is soon destroyed.

Dracenas.—From amongst the plants now established in 6-inch pots, which is the most suitable size for decoration, select a few that possess the best foliage at the base, and place them at once in 10-inch pots. Water them carefully at first, and give abundance of heat and moisture, and they will with judicious treatment develop into useful specimens for the stove. In growing these

plants into specimens either from rooted tops or portions of the stem or root they should never be allowed to suffer by the want of root room until they have received their final shift. Keep them as close to the glass as possible, and give abundance of light, but shade them from the strong rays of the sun.

Thysacanthus rutilans.—Cuttings rooted some time ago in small pots should as soon as possible be placed in those in which they are intended to flower. Keep them close after potting until the roots are at work, then gradually harden them by giving more air until they can be placed in cold frames. This plant does much better under cool treatment during the summer than when grown in a stove temperature, where they soon become tall with leafless stems and fall a prey to insects. While in cold frames ventilate daily, but close early so that the temperature will rise with sun heat. Light shade is necessary during the hottest portion of the day.

Plumbagos.—Pay particular attention to the stopping of the shoots of these plants, because they are liable to grow tall without branching freely, and in this condition half their beauty is gone when required for furnishing purposes in 6-inch pots. As soon as the earliest-rooted plants are ready place them in their flowering pots and give them abundance of heat and moisture for some time yet. Push on as rapidly as possible those rooted later and now in 3-inch pots.

Euphorbias.—Cuttings may still be rooted as rapidly as they can be obtained, but all inserted and rooted after this date should be grown on without having their shoots stopped. Place earlier batches in larger pots as they become ready, but do not grow them too warm or they soon become tall. It is useless to pinch the points of the shoots of these plants to cause them to branch, for in the majority of cases they will break away again with only one shoot. The better plan is to cut them back to where the wood is moderately firm, and then three or four shoots will be produced instead of one.

Sericographis Ghiesbreghtiana.—This is an old but a most useful conservatory plant during the winter. If still growing in heat gradually harden them by the admission of more air, and then grow them under cool treatment afterwards. Care must be taken in removing these plants from heated to cool structures, or they may be seriously checked and stand still in consequence for a long time. Pot on the various batches as they require it, and where large plants can be accommodated a few may be grown in 8 or 9-inch pots, but those in 2 and 3 inches less are most serviceable.

Liliums.—Two of the most useful for indoor decoration early in the season and late in autumn are *L. longiflorum* and *L. candidum*. Those that have been forced into bloom, hardened, and stood outside should now have attention. No attempt should be made to dry them off, but, on the contrary, when grown in pots they should be liberally supplied with stimulants until their flower-stems naturally die away. Long before this takes place root-action has commenced and the new growth starts. Those flowered in 5 and 6-inch pots should be transferred into others 2 or 3 inches larger. Use for a compost good loam, manure, leaf soil, and sand. In potting do not disturb the old ball further than to remove the drainage from amongst the roots. After potting plunge outside, give water when necessary, and the result will be abundance of white Lilies from November to January, which will well repay for any trouble in producing them.

Calceolarias.—Where a display of these plants are required early in the season a little seed may now be sown. In preparing the pan for the seed use a light soil, and make the surface fine on which to sow the seed, but do not attempt to cover it. After sowing water with a fine-rose can, and then cover with a square of glass on which is laid damp moss. Place in a cold frame and shade when necessary.

Richardias.—Those required for autumn and winter flowering should be hardened off and planted outside, where they can remain until the middle or end of September. Where the spathes are required as long as possible it is a good plan to take strong plants that spring from the base and establish them in 6-inch pots ready for planting out. If this has not been done half the stock can be operated upon and the other half kept flowering. In planting out a trench should be made similar to those required for Celery. Place at the bottom a good layer of manure, which should also be liberally mixed with the soil taken out of the trench ready for returning to them when planted out. When the plants are turned out of their pots they can be divided into two, three, or inserted singly, according to their size and the requirements of cultivators. Injury to a few roots will prove no detriment to the plants. A spade can be employed for dividing them. In planting, make the soil moderately firm about their roots and leave the surface a little concave when finished, so that liberal

supplies of water can be given. Each plant should be supplied with a stake to support the foliage as long as it will remain fresh. Watering is the only attention needed during the summer.

Solanums.—Where these plants succeed outside they should now be gradually hardened and planted out in a warm sunny position. This applies to old plants that have been cut back and are growing, as well as young plants raised from cuttings either in the winter or spring. In many instances they have to be grown entirely under glass in order to produce them in the best condition, and well they repay for the room and trouble devoted to them. When in frames repot the old plants, and give the final shift to the young ones as early as possible. Plunge the pots in some moisture-holding material to prevent them drying quickly. Ventilate liberally when the weather is favourable, and syringe freely before their flowers open and after their berries are set, but not while in flower. Do not shade these plants.

Salvias.—Few plants that flower profusely during the autumn and winter are more easily grown and require less care than these. Cuttings root quickly and freely if placed in a little heat and shaded from the sun. The desired quantity may be inserted singly in small pots, and after the plants are rooted they should be pinched once or twice, hardened, and then planted in good soil outside. The points of the shoots should be pinched about once after they are planted out, which is all the attention needed until early autumn. The following are amongst the most useful—*S. splendens*, *S. Betheli*, *S. Heeri*, and *S. Gesneriæflora*.

Bouvardias.—Old plants that have been cut back and have started into growth should have their old roots partially reduced and repotted in fibry loam, a seventh of manure, and sand. Place them in a cold frame and keep close until rooted. Stop any shoots that take the lead as they require it, in order to keep the plants bushy. After they have commenced active growth they can be grown under cool-frame treatment, or be plunged outside in their pots, or planted out in a warm sheltered position; the latter in favourable localities being an admirable practice. Young stock rooted early are now established in small pots, and the points of the shoots must be pinched out when three or four joints of wood have been made. Give more air than has been necessary up to the present time in order to have a firm sturdy growth. These can either be placed when ready in their flowering pots, or planted out and treated like the old stock. Those only just rooted should be grown on in pots in heat for some time yet, and if then placed in cooler quarters will make valuable plants by winter.

THE BEE-KEEPER.

THE MOST PROFITABLE RACE OF BEES.

[The following essay read by Mr. H. R. Boardman, with the discussion thereon, we cite from the *American Bee Journal*.]

ONE of the most prominent objects of my early boyhood recollections is the old box bee-hive out in the garden under an old Apple tree, with its inhabitant the black bee. By the hour have I laid on the grass under this old Apple tree and watched with eager interest those mysterious little workers.

Many wonderful things have I been told about them, and the economy and government of the multitudes within their well-guarded home, which to me was shrouded in the deepest mystery, and their well-kept secrets, guarded with a dignity and honesty which I had never presumed to question. I had been told that they had a form of government like a nation of people, and had a king who sat upon a throne, and all his subjects paid implicit obedience to his commands and rendered the utmost respect to his sovereign wish, and I had noticed upon all combs that had been removed from the hive undoubted proof of this. The throne upon which the king sat, I have since learned, were old queen cells. I had been told that these communities were systematically divided, and that each division had its particular work to perform, and leaders or overseers were placed over them to superintend the work in each department, and some were assigned the position of guards at the entrance of the hive, and did not have to gather honey.

I watched them swarm with more than idle curiosity, and I heard older people say that when the swarm issued they followed the king out, and wherever he went they followed, and if the king died in a colony they would all stop work and never do anything more, and would finally all die. I watched them toil the summer through to accumulate their sweet stores of food to provide for the coming winter, only to be robbed of them and cruelly

murdered in the fumes of the foul brimstone pit. I said it was cruel and wrong, and that there ought to be some other way; and if their stores must be procured in that piratical way, although honey to me was a tempting luxury, I preferred, for one, to forego the pleasure of such luxury.

How did anyone learn these wonderful things, I said, unless by patient and careful watching? and if others have discovered these wonderful things why not I, by patient observation, penetrate the mysterious precincts of these wonderful little insect people? And I did watch with all the energy awakening curiosity could arouse, and I listened often with my ear close to the hive to their mysterious bee talk; but their secrets remained untold, and their every movement remained a dark unsolved enigma.

But a new era came, light dawned. There came the moveable frame and the new bee, the yellow bee, with its wonderful reputation for penetrating the depths of the rich red Clover; and what then? Then came a knowledge of the mysterious things within the hive, improvements and progress in bee-culture, old superstitions vanished, new and startling truths were brought out, until that mysterious hive of twenty years ago is to-day a thing of practical fact, within the comprehension of the veriest novice. Italian queens were introduced into our colonies of black bees, and in an incredible short time the whole colony was changed from black to yellow bees, discovering the startling fact to even old bee-keepers of the brief, almost ephemeral, existence of the honey bee during summer.

So readily was this change made, and so apparent the benefits gained thereby, that Italian queens were rapidly imported, queen-breeders sprung up over the land everywhere, and the queen has become a common article of trade in the market of bee-keepers' supplies, and the superiority of the yellow race of bees over the black became almost universally acknowledged. But a mountain of difficulty arose in the pathway of queen-vendors, especially importers. A standard of purity was necessary to preserve the reputation of the imported stock, and to distinguish it from the plebeian race; but in attempting to establish this it became apparent that even the imported stock would not stand any single test, so various were their markings and characteristics. Suspicions were awakened among unprejudiced bee-keepers that the race of bees from which we were receiving importations were not a pure race, and this suspicion has been strengthened into fact by the knowledge that black bees are found in Italy. As a result of these variations different strains of bees began to be brought to notice, each possessing particular valuable qualities as set forth by their particular champions, and many a sharp contest has been carried on in the bee papers by the advocates of some particular stripe, or tint, or tinge in his favourite strain, and now we have almost as many strains of bees as there are breeders.

Who that has read the bee literature has not a vivid recollection of the sharp criticisms upon the dark queen sent out by Messrs. Dodant—even unkind reflections upon their integrity? They have outlived it all, and float successfully now above suspicion.

Some breeders take pride in publishing what they no longer hesitate themselves in believing—that they are breeding a cross of the black and yellow race, and no longer consider yellow bands a test of excellence or a guarantee of purity, and that although beauty and amiability may be desired, they are too often obtained unwisely at a sacrifice of more sterling qualities.

The reports of large yields of honey coming from colonies not possessing the requisite number of yellow bands to entitle them to a certificate of royalty has become too frequent to be accidental, and the wise apiarist will hesitate long before superseding the queens of such colonies with those having the regulation markings.

We are, without doubt, largely indebted to the introduction of the yellow race of bees into this country for the knowledge and improvements in modern bee-culture.

But while Mr. A, and B, and C have made a paying business rearing queens, and have made a hobby of yellow bands and golden tints, we, as practical bee-keepers, are looking to a different source for our revenue, and are only anxious how we may obtain large yields of honey. Beauty and pleasure are secondary considerations. Honey gathered by the black or hybrid bees brings as much money in the market as that obtained by the most beautiful golden Italians—and in fact it is claimed that honeycomb made by the black bees is whiter and more delicate in appearance than that made by the yellow race.

But what shall we say of the new races more recently introduced into this country by Mr. D. A. Jones of Canada at such great expense both in time and money? The Cyprians and the Holy Land bees, what can we say of them except that they are an experiment, and, like all experiments in bee-culture, should be tried with much caution? There is an old maxim, "Let well

enough alone;" not altogether a noble one, yet for all that successful for the moderately ambitious, and perhaps a very safe one for the average bee-keeper. We can but admire the enthusiasm of Mr. Jones, which has prompted him to such untiring energy and to make such sacrifice of time and money in his search for some superior race of bees by which he might benefit mankind. And Mr. Frank Benton, too, his assistant, has done much to command our esteem and admiration.

But all great enterprises of this character are measured by their ultimate success or failure. The reports that have already been received from his importations seem to promise but little or any improvement upon the yellow races of bees already so universally diffused over this country, of which I prefer to consider them only a strain, and, indeed, the Cyprians have already gained a reputation of being very unamiable in disposition, and often becoming angry without provocation.

By what name, then, shall we know the coming bee? We might adopt the phrase used by Mr. Heddon and applied, not to bees, but to bee-keepers, "Get there success," as it is very comprehensive of the qualities we think essential, but we prefer that other more beautiful and more significant name already heralded forth among progressive bee-keepers, *Apis Americana*.

C. E. Newman asked if Cyprians or Holy Land bees had proven more profitable than the Italians.

Mr. Boardman said he thought the Italians were the most profitable.

S. F. Newman said he had tried both Cyprians and Italians, and in his experience the Italians had proved to be fully equal to the Cyprians as honey-gatherers, and were not as irritable. At times it was almost impossible to handle the Cyprians unless they were chloroformed.

Mr. Bartow said he preferred hybrids to Italians; they protected their stores better than other bees.

Mr. Bartow asked whether Holy Land bees were more likely to be pure than the Italians.

Mr. Boardman said he thought the Holy Lands as likely not to be pure as the Italians.

The President.—We are ignorant as to the fact whether the Cyprians are indigenous to the island of Cyprus, or whether they were Italians modified to a certain extent by climate and other causes. The important question to be decided is, Which race of bees will give us the largest amount of honey, and thereby fill our pockets with money? He wanted no pure bees, but preferred hybrids.

Mr. Whitney asked Boardman which produced the best workers, an Italian queen mated with a black drone, or a black queen with an Italian drone?

Mr. Boardman did not know which would produce the best results. The facts are that Italian queens generally mate with black drones.

Mr. White.—An Italian queen mating with a black drone produces better workers than the reverse.

TRADE CATALOGUES RECEIVED.

Barr & Son, 12, King Street, Covent Garden, London.—*List of Pyrethrums and other Flowers.*

Osman & Co., 14, Windsor Street, Bishopsgate, London, E.—*Wholesale List of Horticultural Sundries.*

Ernest Riemschneider, 42, Hamburgh Street, Altona-Hamburgh.—*Price List of Lily of the Valley and Bulbs.*



** All correspondence should be directed either to "The Editor" or to "The Publisher." Letters addressed to Dr. Hogg or members of the staff often remain unopened unavoidably. We request that no one will write privately to any of our correspondents, as doing so subjects them to unjustifiable trouble and expense.

Correspondents should not mix up on the same sheet questions relating to Gardening and those on Poultry and Bee subjects, and should never send more than two or three questions at once. All articles intended for insertion should be written on one side of the paper only. We cannot reply to questions through the post, and we do not undertake to return rejected communications.

Fasciated Asparagus (*W. Vick, Ipswich*).—We have seen many similar examples of monstrous heads, but not often so large as those shown in the

photograph—namely, 2 inches in diameter. We must congratulate you on the production of this photograph; it is very beautiful, and most creditable to the artist.

Pinks (T. B.).—We have received the flowers, and will refer to them next week.

Cephalanthera ensifolia (J. H., Ayrshire).—This is one of the most lovely of the terrestrial Orchids, and is too rare to be lightly disturbed. If the plants are on your own property, and there is no danger of their being "collected," we should hesitate to transplant them, as, unless you have a position in your garden similar to that where they are now established, they would almost certainly fail to succeed anything like so well as where they are now growing so freely and flowering so charmingly.

Roses Injured (G. Rawlings).—It is absurd to suppose that established Roses could be injured by drought in the way of those you have sent. The fumes of boiling tar are most injurious to vegetation, and those who cause the destruction of property in the manner indicated are, as they ought to be, liable to be mulcted in the cost of making good any loss that has been sustained on a case being proved against them.

Ants Eating Rose Buds (E. N.).—What is new to you is not so to us. We have seen many Roses ruined by ants eating the swelling buds, but why they should prefer this kind of food we are unable to say. They are usually first attracted by the presence of aphides. We know of no means of preventing the ants ascending the trees than by wrapping bands of cotton wool or some other material round the stems and smearing it with tar, or, what is perhaps better, a mixture of resin and sweet oil, two-thirds of the former melted, and one-third of the latter, as this mixture keeps moist longer than tar, and until it is dry neither ants nor snails can travel over it.

Air-tight Propagation (J. S.).—We are glad you have read Mr. Taylor's article on ventilation (page 489) so intelligently. It is not every reader who would detect any ambiguity in the sentence which states that removing the lights would cause the cuttings almost instantly to become tender. The word "tender" ought to have been printed "tinder," in reference to the cuttings shrivelling by the sudden exposure to air. This explanation will render his observation quite intelligible.

A Vine Mystery (P. H. P.).—As you shook out every alternate Vine and spread out the roots, and all which were so treated have refused to grow, while the remainder which were planted with balls entire have all done well, we must think in the absence of more precise information that there is something unsuitable in your soil, and those which are apparently doing well are living merely on the old balls of earth. You had better examine the roots and see if any of them are taking at all kindly to the new soil. If you refer to "Vines at Longleat" you will find that Mr. Taylor planted his Vines in a growing state at midsummer, and at that time the soil must not be shaken from the roots; but it is the practice to remove the soil from them when planted in a dormant state, or just starting into growth. When you cut down the Vines you can take up two rods from those that have done well. They will bear quite as well as if confined to one rod each.

Heating Greenhouse (C. D., North Wales).—As we have many times stated, we are quite unable to recommend any particular boiler. It would be obviously unfair for us to do so to the makers of others not mentioned, and yet in no way inferior. All the boilers advertised in our columns are good, and if you state the size of your house to the manufacturers of them they will send you the size of boiler and price with or without pipes, and you can then choose for yourself. As much depends on the setting of a boiler and the arrangement of the pipes for heating a house satisfactorily as on the particular kind of boiler employed. A practical gardener near you would give you good advice on this matter.

Manure for Mushrooms (H. S. H. P.).—Place the manure in a heap until you have sufficient for a bed, throwing the slops on it so as to make it sufficiently moist for decomposition, then turn it over as described on page 28 of Mr. Wright's treatise, until the mass is in the condition indicated in the following chapter. It will not be advisable to use the slops after you commence turning, or the mass would not be made sweet; and further applying water to manure that is too hot usually makes it hotter. When a bed is made as described on page 33 of the manual the manure is hot, but a method is there named for preventing excessive heat and drying. The proper temperature for inserting the spawn is stated on page 44 of the work in question.

Sulphate of Ammonia (T. Wells).—The proper kind for manurial purposes is sold by dealers in artificial manures in nearly all large towns, also by most of the large metropolitan and provincial nurserymen and seedsmen, as well as by dealers in horticultural requisites who advertise in our columns. However, you may perhaps find it easier to procure nitrate of soda, and if so you may use it instead of the other, as it will probably answer your purpose equally well. Both are very quick in their action and powerful, and care must be taken not to use them in excess. An ounce to each square yard of soil is generally sufficient for one application.

Preserving the Colours of Flowers (Inquirer).—It is by no means easy to preserve the colours of flowers in drying, particularly some delicate shades. After placing the specimens between sheets of blotting or the ordinary drying paper employed for botanical purposes, press firmly with a hot iron, which will fix the colours of some flowers, as quick drying is the principal object. Another system, which is often efficient if well performed, is the following: Secure the stems of the flowers to fine wire, and dip each separately in a thin clear solution of gum arabic, then suspend them until thoroughly dry, when they can be carefully pressed. The gum forms a slight glazing on the surface of the flowers that is hardly perceptible, and yet sufficient to prevent the air affecting the colours.

Tropæolum (Vindex).—There are several varieties so closely resembling each other that it is not possible to determine the names of any of them without actual comparison of the flowers. It is for this reason that we do not undertake the naming of varieties, but only species of plants. If you send a few flowers, with a stamped directed envelope, to Mr. Cannell of Swauley he will probably compare them with others in his collection, and send you the name of your variety if he can determine it. It is very good indeed; well formed, with stout petals, and brilliant colours.

Zonal Pelargonium Leaves Injured (T. B. Jesmond).—We think we told you the injury was caused by removing the plants from a moist house to the full sun in the open air, and your further experience confirms this opinion. They may have been too wet at the roots, causing them to decay; if so, this would aggravate the evil, as the moisture would evaporate from the leaves more quickly than it could be supplied by the injured roots. Your plants are evidently

in an unhealthy state. Allamandas are found in Guiana, Paraguay, and Brazil; Dipladeuias mostly in Brazil.

Horn Shavings (R. H. R.).—The horn waste from comb manufactories is of great value. A few years ago a similar waste sold at some £40 per ton, but about half this sum is nearer the value an agricultural chemist would give it. For mixing with poor potting soils, especially for foliage plants, it is very good. There is a good deal of difference between horn and bone. Horn waste contains—or should contain, but much depends on the dust mixed with it—nitrogen, equal to 18 or even 21 per cent. of ammonia, bones not over from 4 to 4½, and not always that; but bones are valuable because of the phosphates (some 50 per cent.) they contain. Horn contains practically none. The finer the particles the more rapid is the action of horn. Shavings act at once, gritty matters last for years, according to their bulk. When a lasting nitrogenous manure is wanted no better exists than the waste you name. Ordinary nitrogenous manures are not lasting, evanescence is their chief character; but bones are more or less lasting according to the fineness of their particles. Horn shavings are worth about £20 per ton more or less, bone not very much more than half that sum.

Repotting Peach Tree (Idem).—The tree ought to be potted so soon as the growth becomes firm in late summer and before the leaves have fallen, doing no more in disturbing the roots beyond loosening the sides of the ball a little and removing the drainage. The pot must be well drained, and some rough material placed over the drainage to insure its working satisfactorily. Good turfy loam with a fifth of well-decayed manure is a suitable compost. If deficient of calcareous matter, a little old mortar rubbish may be added and intermixed. In potting make the soil quite as firm as that of the old ball, and give a thorough watering afterwards, subsequently giving water as required. If the potting be done carefully the foliage will not suffer, but if the weather be bright shading may be necessary for a few hours in the middle of the day, and syringing morning and evening. The roots will soon start working in the new material. The tree should be placed under glass, so that it may have its growths solidified as made, for if left outside it is likely the wood will not ripen well, or the buds not be sufficiently perfected to insure a crop of fruit next season. The size of pot is suitable.

Dendrobium Dalhousianum (E. Masters).—We cannot give you a better description of this species than by citing from Mr. B. S. Williams' "Orchid Manual," and the plant referred to there will also answer your inquiry as to its being a free bloomer:—"This is a beautiful Indian evergreen species; the stems, which are elegantly marked with reddish-crimson, grow from 4 to 8 feet high; it blooms from the old growth in April and May, producing numerous flowers on a spike. The flowers are large; sepals and petals of a pale lemon colour; lip the same colour, with a pink margin and two dark crimson spots in the centre: it lasts four or five days in beauty. This will grow either in a pot or basket, with moss. Specimen plants of this are scarce, and justly prized by those who possess them, as it makes a good plant for exhibition purposes. This plant was exhibited by Capt. Shaw at Blackburn, 1872; it had forty-three spikes, many of which had fourteen flowers on them; there were 440 flowers in all, 400 of which were open at the same time, the individual blooms measuring 4½ inches in diameter."

Preserving Cut Flowers (J. P., Dublin).—More depends on the condition of the Fern fronds and flowers when placed in water than anything that can be added to the water in preserving their freshness. The soft young fronds of Ferns grown in a moist shaded house do not keep fresh half so long when cut as older and harder fronds do that have been grown more or less in the sun. It is an excellent plan also to immerse Fern fronds in water for an hour before they are packed or placed in vases. Flowers always last longer when cut early in the morning and before they are fully expanded than if they are older and cut in the sun. There is no method so effectual for retaining the petals of Pelargoniums and similar flowers that "fall" quickly as sealing the petals at the base by touching the centre of each flower with a drop of gum. We know that salt, nitrate of soda, charcoal, and a few drops of hartshorn in the water have been recommended for prolonging the freshness of flowers, but we have not had occasion to try any of them, as by adopting the precautions above indicated, changing the water daily, and cutting off a small portion from the ends of the stalks at the same time our flowers last as long as we wish them. At the same time, if any of our readers have found the addition of any ingredients to the water advantageous for the purpose in question we will readily publish their experience if it is communicated to us. Your other question cannot be answered this week.

Introduction of the Moss Rose (Hants Vicar).—We have referred to many old authorities, and the results of our search are that Parkinson in his "Paradise," published in 1629, Rea in his "Flora," published in 1665, and Bauhin in his "Pinax," published in 1671, enumerate many Roses, but the Moss is not among them. It was introduced or raised in Holland probably at the close of the seventeenth century, for Dr. Martyn, in his edition of Miller's "Gardeners' Dictionary," says it is in Furber's catalogue in 1724. We have seen a copy dated 1727; it is entitled "Catalogue of English and Foreign Trees Collected, Increased, and Sold by Robert Furber at his Nursery over-against the Park-Gate at Kensington, near London." Faulkner in his "History of Fulham" says that Mr. Rench was the first to introduce the Moss Rose into this country, the original plant of which is supposed to have been brought from Holland. Rench lived at South Field Farm, near Parson's Green, a farm possessed by his family for two centuries. He was buried in Fulham churchyard, where there is this inscription to his memory on a headstone:—"Under this stone are deposited the remains of Nathaniel Rench, late of this parish, gardener, who departed this life Jan. 18th, 1783, aged 101 years." So he may have introduced the Rose before 1724, for in that year he was forty-two years old. The Moss Rose was first portrayed in the "Botanical Magazine," plate 69. It is described as the *Rosa muscosa*, or Moss Rose, and the plate is dated December, 1788. Mr. Curtis observes that, though Miller thought it a distinct species, Linæus considered it only a variety of *Rosa centifolia*.

Span-roof Pit (Trike).—Excavate the whole of the soil to the floor of the pit, build outer walls to support the roof, and low interior walls, mentioned in our first reply as retaining walls, along each side of the footway. You will thus have a passage with parallel pits or trenches along the entire length of the building. Divide these midway by a door in the passage, and a wall across each side pit of the same height as the passage walls, with a glazed partition resting on it. On the side for pot plants fill the pit between the outer and inner wall with rubble, covered at top with fine gravel or coal ashes, for the pots to stand upon. On the side for summer Cucumbers and Tomatoes fill partly with rubble, leaving a foot at the top for soil. Summer Cucumbers require no bottom heat; but as you now mention provision for that and forcing, four rows of 4-inch pipes will be required, two for bottom heat and two for top heat. Bottom heat will probably only be required in one of the side pits of the warm end, and no

rabble will be required there. Put the pipes, a flow and return, just above the floor. Have a chamber above them by laying slabs of wood or stone a foot above them, across from the inner to the outer wall, upon a few courses of brickwork built against each wall for that purpose. Two-inch planking lasts three or four years, and answers perfectly to support soil or plunging material, the top heat to be afforded by a flow and return along one side slightly above the top of the interior pits, and resting either upon a ledge of brickwork or iron crutches. These pipes are to run through the entire length of both compartments, but close by the warm side of the partition they must be connected by T-pieces with a valve upon the flow pipe to shut off heat from the cool end, circulation then going on by means of the T connections only in the warm end. A valve should also be put upon the flow pipe for bottom heat near the boiler to shut off heat at will. If you can afford space for a cemented tank, water in it would be of the same temperature as that of the pit, and therefore suitable for the plants, just as it would be in a tub or waterpot standing in the pit. The upper part of both ends should be glazed uniform with the partition. Side ventilation is not required for so small a building. The open-feed syphon is not what you suppose, and you had better make other provision as suggested for warm water. If you have had no experience in setting a boiler and fixing pipes you had better get some competent person to do this work for you. If you send an accurately drawn plan to the firm you mention, and state exactly what you require, they will send you the necessary connections for making the apparatus complete.

Names of Plants (J. W. K.).—1, *Lamium Orvala*; 2, *Saxifraga Geum*; 3, *Veronica gentianoides*; 4, *Polygonum Persicaria*. (*F. C. D.*)—1, *Veronica rupestris*; 2, *Centaurea montana*; 3, *Hemerocallis flava*; 4, *Habrothamnus fascicularis*. (*A. B. C.*)—*Sedum acre*. (*M. J.*)—1, *Ptelia trifoliata*; 2, *Philadelphus coronarius*; 3, *Sedum carneum variegatum*; 4, *Begonia insignis*; 5, *B. manicata*; 6, *Lastrea decomposita*. (*H. M.*)—1, *Omphalodes*, perhaps *O. amplexicaulis*, but specimen insufficient for determining the point; 2, *Limnanthes grandiflorus*; 3, *Orchis maculata* if the leaves are spotted, *O. pyramidalis* if they are green. Thrushes kill shell snails, but we do not remember whether black-birds do so. (*R. Ogston*).—*Dendrobium Dalhousianum*, which flowers on the old growths, and your plant has evidently done well. See a reply to another correspondent. The other flower you have sent is *Maxillaria nigrescens*. (*S. T.*)—1, *Cypripedium superbiens*; 2, unrecognisable; 3, *Ranunculus aconitifolius* fl.-pl.; 4, *Begonia marga*. (*C. W. S.*)—*Crataegus mexicana*.

COVENT GARDEN MARKET.—JUNE 20TH.

OUTDOOR Strawberries are now making a good appearance, and prices are much lower, indoor fruit being nearly exhausted. Our market is also well supplied with all classes of goods. Trade brisk. Grapes heavy.

FRUIT.

	s.	d.	s.	d.		s.	d.	s.	d.		
Apples.....	½ sieve	2	0	7	0	Grapes.....	lb.	2	0	to 5	0
".....	per barrel	20	0	40	0	Lemons.....	case	10	0	20	0
Apricots.....	box	2	0	2	6	Melons.....	each	3	0	7	0
Cherries.....	½ sieve	0	0	0	0	Nectarines....	dozen	6	0	18	0
Chestnuts.....	bushel	0	0	0	0	Oranges.....	100	6	0	10	0
Currants, Black..	½ sieve	0	0	0	0	Peaches.....	dozen	6	0	18	0
"..... Red....	½ sieve	0	0	0	0	Pears, kitchen..	dozen	0	0	0	0
Figs.....	dozen	4	0	6	0	dessert.....	dozen	0	0	0	0
Filberts.....	lb.	0	0	0	0	Pine Apples, English	lb.	4	0	5	0
Cobs.....	100 lb.	0	0	0	0	Raspberries.....	lb.	0	0	0	0
Gooseberries....	½ sieve	3	6	4	6	Strawberries....	lb.	1	0	3	6

VEGETABLES.

	s.	d.	s.	d.		s.	d.	s.	d.		
Artichokes.....	dozen	2	0	to 4	0	Mushrooms.....	punnet	1	0	to 1	6
Asparagus, English	bundle	3	0	6	0	Mustard & Cress..	punnet	0	2	0	3
Asparagus, French	bundle	2	0	0	0	Onions.....	bushel	2	6	3	6
Beans, Kidney....	100	1	0	0	0	Parsleys.....	doz. bunches	3	0	4	0
Beet, Red.....	dozen	1	0	2	0	Parsnips.....	dozen	1	0	2	0
Broccoli.....	bundle	0	9	1	6	Peas.....	quart	2	0	0	0
Cabbage.....	dozen	0	6	1	0	Potatoes, New....	lb.	0	2	0	4
Capsicums.....	100	1	6	2	0	Potatoes.....	cwt.	6	0	10	0
Carrots.....	bunch	0	4	0	0	Kidney.....	cwt.	6	0	10	0
Cauliflowers.....	dozen	2	0	3	0	Radishes.....	doz. bunches	1	0	0	0
Celery.....	bundle	1	6	2	0	Rhubarb.....	bundle	0	4	0	0
Coleworts.....	doz. bunches	2	0	4	0	Salsafy.....	bundle	1	0	0	0
Cucumbers.....	each	0	4	0	6	Scorzoneria.....	bundle	1	6	0	0
Endive.....	dozen	1	0	2	0	Seakale.....	basket	0	0	0	0
Fennel.....	bunch	0	3	0	0	Shallots.....	lb.	0	3	0	0
Herbs.....	bunch	0	2	0	0	Spinach.....	bushel	2	6	3	0
Leeks.....	bunch	0	3	0	4	Tomatoes.....	lb.	1	0	0	0
Lettuces.....	score	1	0	1	6	Turnips.....	bunch	0	2	0	0



POULTRY AND PIGEON CHRONICLE.

CORN-SAVING BY MACHINERY.

ALTHOUGH we have contributed our opinions, as well as the best practices of intelligent farmers, on the subject of harvesting Wheat, Barley, and Oats in three numbers of this Journal, dated 1st, 8th, and 15th of August, 1878, we still think it important to consider the attempts which have been made to exhaust the heat from corn stacks, as well as those of hay during the past year. We must say that our opinion was that reducing the heat of corn ricks by the use of the fan would prove much more easy, as well as more effective, than when used upon hay stacks. We

also looked forward to the trial of fans at Reading, for it must be remembered that Messrs. Suttons' prize of £100 was offered for the best method of drying hay and corn, and the Judges appointed to decide the matter thought it desirable that some of the fans should be tried upon some description of corn crop; and it seemed probable that these machines might succeed in drying sheafed corn, although they had failed in saving hay in good condition. The Judges selected the fans to compete in this trial—three of those exhibited by Messrs. Coultas, Lister, and Phillips. We take our information from the Judges' report, published in the Journal of the Royal Agricultural Society of the proceedings at the Society's meeting at Reading, 1882, which states:—"On the 9th of August the Barley, which had not ripened so kindly and evenly as had been expected, was thought fit for cutting. It was not dead ripe, and there were some patches of the field which were certainly unripe. Much of the crop was so laid and twisted about that the cutting was not very easily done."

In uncertain and broken weather farmers are frequently tempted to stack their corn when it is only half dry, especially of those crops like Oats and late Barley, which come in for consumption on the farm both corn and straw; and in wet harvests it is almost impossible in certain districts of the kingdom, especially when the harvest is late, to secure the Barley in which Clover seeds have been sown in really good condition, and at such times much corn is often either spoiled in the field or mow-burnt, and seriously injured in the stack. "As, however, a large proportion of the material of a corn stack is ripe straw without sap enough to make it heat, and further as a rick of corn when first made is much more open to admit the air than one of hay, there seemed in the opinion of the operators of the fans to be fair grounds for supposing that exhaust fans would be working under favourable conditions if applied to the stacks of corn; and it must be remembered in this case that the absence of green Clover was fully supplied and compensated for, so far as regards these trials, by a plentiful supply of Thistles and a thick undergrowth of weeds and trumpery. The crop was purchased by the Stewards of the Society for the purpose of the trials upon corn stacks. The field was divided into three equal portions, and three reaping machines, which Messrs. Hornsby and Sons were good enough to lend to the Society, called the "Indispensable" spring-balance self-raking reapers, and one of these were started in each plot on the morning of the 9th August. The competitors drew lots for the different shares, and the result was that Mr. Coultas had plot 1, Mr. Phillips plot 2, and Messrs. Lister & Co. plot 3. The first day of working was very bright and warm, and a continuance of such weather would have balked the competitors, by leaving them no chance of exhibiting the powers of their fans; but the morning of the 10th was cloudy and threatening, and the Thistles and weeds were green and full of sap when the sheaves were bound. Stacking was begun, however, about nine o'clock on the morning of the 10th, and pretty well completed on the evening of the 11th. The exhibitors had made their preparations for the stacks before the cutting of the corn began, in accordance with the directions they had received. They were told that each exhibitor would have to deal with two stacks of about the same size, and they were invited to place their fans in such a position and to lay dampers, or otherwise to make their arrangements, so that they could work both stacks at the same time, or each one separately, as they may prefer. They were also directed to supply themselves with thermometer tubes, which were to be placed in the stacks pointing to the N., E., S., and W. The tubes were also to be made of wood, as being considered to be more trustworthy than those of iron. The shafts in the centre of the stacks were formed by a wooden cage, 2 feet square at the base, and tapering to

13 inches square at the top, the height of two of the cages varying from 9 feet 6 inches to 12 feet 6 inches, the latter being that of Mr. Coultas. Mr. Phillips placed his fan a little in front of the line of stacks, and, consistently with his theory that all angles should be avoided, laid his flues in two curved lines, which started from the stack centres, and touched each other just in rear of the fan. These flues were tubes of galvanised iron, 8 inches in diameter, and made in 3-foot lengths, with a tapered edge at one end of each section. Messrs. Lister & Co. put their fan between the two stacks, and ran a continuous flue of sheet iron, 9 inches in diameter, in a straight line from the centre of one stack to that of another. Midway between the stacks a right-angled junction with the fan was made. At least two of the abrupt turns might have been easily avoided, and if the other angles had been rounded off it is reasonable to suppose that the fan might have proved more effective. The shafts in these two stacks were made by circular cages 7 feet high, 30 inches in diameter at the base, and 18 inches at the top."

The result of the operations of the fans are voluminous and cannot here be given, although they were taken daily, except Sundays, from the 11th of August until the 11th of September, and were almost constantly at work during the daytime. The power of the fans to reduce the heat of the stacks is evidenced by the difference between the morning and evening observations on days when at work had been done, and also by the sudden rise which sometimes occurred after a day when the fans had been idle. The maximum temperature of the stacks during the trials, as found in the stacks of each competitor, was in Mr. Coultas' stack, on August 14th, 119°; Phillips' stack, August 24th, 131°; Lister & Co.'s, August 4th, 145°. It will thus be seen that four out of the six stacks developed their greatest heat within three or five days after the stacking; while in the two stacks which heated most, the hottest time was thirteen days after the corn was put into stack. It was also noted that those ricks which had most weeds in the sheaves showed the highest temperature.

"On the 11th of September the Judges, having inspected the stacks, came to the conclusion that it was useless to carry on the experiment any further. Though the fans had been at work for a month there was evidently a good deal of latent heat. Orders were therefore given for the thrashing of the corn. In Mr. Coultas' stacks the upper portion of the corn was bright and uninjured, though few of the sheaves were dry inside; the lower portion was compressed, and the corn was discoloured. The insides of many of the sheaves were almost rotten, and some of the grains had germinated. The second stack was less injured, but the fan seemed to have had no effect at all on the lower part of it, many of the sheaves being still very wet. Phillips' stacks were in the upper parts like those of Coultas'. The lower part of the second stack, particularly on the eastern side at 5 feet above the ground, was pressed as close as millboard, and the grain was heated brown. All the corn in these stacks had a most disagreeable fusty smell. Messrs. Lister & Co.'s stack A had in it some corn which was about on a par with the better part of the other stacks. Stack B was in a frightful state, many of the sheaves were completely rotten, and all the south-eastern quarter was reeking like a heap of heated farmyard manure."

Near the end of the report we meet with the following remarkable statement:—"The trials of the fans upon corn must be considered as having been a complete and disastrous failure." Now, after having given the observation of the Judges, stating how the competitors conducted their trials of fans upon the corn in stack, and the great disappointment to many of the result, we feel it incumbent on us in another issue of the Journal to practically consider the matter in order that business men may not be discouraged.

(To be continued.)

WORK ON THE HOME FARM.

Horse Labour.—This is still connected with the tillage for Turnips, also at intervals the carting of Clover, Sainfoin, and hay to the stack. Unless the weather is very drying, with a harsh east wind, the hay is scarcely ever in first-rate condition for carting early in the day like corn, because the night dews, when the weather is still and quiet, if it is ever so hot, are often heavy, in which case we prefer to effect some tillage operations, or otherwise some work preparatory to the carting of hay, and thus deferring the hay-stacking until about ten o'clock. If, on the other hand, the strong east winds, such as we experienced in the last days of May, prevail, the carting may be commenced early in the morning without let or hindrance, for in such a case the hay makes night and day, but especially when the surface of the land is dry and hot. Since the haying began we have not, up to the time of writing, experienced any threatening weather sufficient to induce the advocates of using the exhaust fans to prepare them for the haystacks, still we find that many persons have decided on using these machines if the weather should prove fickle and uncertain. The ridge-ploughing and sowing of Turnip seed will now be pro-

ceeded with as fast as the land can be made ready. The Grey Stone Turnip is our favourite variety, but especially the improved sort, which is red in colour, and by some farmers called the Red Mammoth. Both these varieties are not only very quick of growth, but also of excellent quality, and very much hardier than the White Rounds or Green Globe varieties. After Trifolium we have land to come in for Turnips, and as fast as it is cleared we half plough, then scarify across the rafters. This opens the land, and is favourable to the combing out couch, of which we have some quantity to deal with through the neglect of a late tenant. Early crimson Trifolium is now nearly gone, but we have a capital succession in the second early pink-blossomed variety just fit for cutting, which we expect, together with the later white sort, will continue in good feeding condition until about the 10th of July.

Mangold and Swede-hoeing, also Potato-hilling, will engage an odd horse or two now for some time when the weather is dry. Where the growth is not luxuriant we sow 1 cwt. per acre of nitrate of soda by hand between the rows of plants; but this application is not advisable for Swedes or Turnips, as it forces the plants too much by throwing up long stems and rendering the roots more likely to decay in the autumn. To supplement horse labour on farms where steam-cultivating machinery is not used it is difficult to hire steam power, as so many farmers require the tackle simultaneously. We therefore recommend, as a great economy, the use of oxen, and now is the time to purchase them for six months' working on the land. We advise the selection of animals at four years old and broken in to farm work, and in good fleshy condition. They will each take the place of an ordinary farm horse for cultivation, such as ploughing, harrowing, and scarifying, and from this time they may continue to work on the summer tillage whilst the horses are busy at hay-carting or harvest-carting. We prefer the Hereford and Sussex oxen for this purpose, and being powerful animals with a quick step, they are enabled to supplement the horse power of the farm by working two to a plough; but they must be kept in good and improving condition during their work. To effect this they must be fed and kept up the same as horses, at least at the same cost, both as regards food. After taking part in the cultivation of the farm until the fallows are all ploughed for the winter, they will be found in improved condition, and worth at least 20s. each more than they cost, and may then be placed in the boxes or stalls for fattening. At the end of twenty-one weeks they will be in good condition for the butcher, and also come to market at the time of year when beef sells at a good price. The result of six months' work on the land will compare well with horse labour, for the bullocks will have gained in value £1 per head, whereas the horses during the same period will have depreciated in value £2 each.

Hand Labour.—After the hedge-trimming is finished, Turnip and Mangold hoeing and singling will be going on, with hay-stacking during intervals of dry weather. On the later fallows, which may be required for late Turnips or be held on for seeding with Wheat, couching and burning will be going on oftentimes, but we prefer to cart the couch away to heaps instead of burning. We have for many years acted upon a rule, never to burn anything which will rot, unless we may be in actual want of ashes for drilling with manures. Also in case of land having run to waste and neglected by a tenant, we like to burn all the couch and weeds and a considerable quantity of earth attached, which saves some of the labour of tillage. When burned in large heaps upon the principle of stifle-burning—that is, charring as much as possible, we often obtain an amount of ashes sufficient to manure the land. This plan answers well in outlying fields, as it saves cartage of yard manure; and we have found, too, that the charred earth and weeds make a lasting manure for future crops, especially for roots.

METEOROLOGICAL OBSERVATIONS.

CAMDEN SQUARE, LONDON.

Lat. 51° 32' 40" N.; Long. 0° 8' 0" W.; Altitude, 111 feet.

DATE.	9 A.M.					IN THE DAY.				Rain
	Barometer at 32s and Sea Level	Hygrometer.		Direction of Wind.	Temp. of Soil at 1 foot.	Shade Temperature.		Radiation Temperature.		
		Dry.	Wet.			Max.	Min.	In sun.	On grass.	
1883.										
June										
Sun. 10	29.950	64.6	57.2	N.N.	58.2	73.6	49.7	113.2	43.9	—
Mon. 11	30.134	54.6	52.6	N.E.	58.8	61.2	49.5	81.0	47.8	—
Tues. 12	30.326	61.4	55.5	N.W.	57.4	75.8	41.4	125.3	36.3	—
Wed. 13	30.412	67.9	60.2	N.	59.7	78.2	54.1	121.7	43.2	—
Thurs. 14	30.293	65.3	60.4	N.	61.1	78.3	56.3	120.5	49.5	—
Friday 15	29.927	60.6	55.3	N.	62.4	64.3	55.1	85.3	50.3	0.114
Satur. 16	29.829	52.8	48.9	N.W.	59.9	64.3	44.2	109.8	44.8	0.053
	30.124	61.0	55.7		59.6	70.8	50.0	106.1	45.9	0.167

REMARKS.

10th.—Fine, warm, and calm.
 11th.—Cloudy and cool, finer in evening.
 12th.—Fine and bright.
 13th.—Fine and warm, close and stormy-looking at intervals.
 14th.—Fine and bright.
 15th.—Cool, cloudy, rain in morning and at night.
 16th.—Morning bright and fine, afterwards showery.
 Temperature very variable, but on the whole near the average cooler and cloudy at the end of the week.—G. J. SIMONS.



28th	TH	National Rose Society, Southampton. Richmond Show.
29th	F	Canterbury Rose Show.
30th	S	Reigate Rose Show. West Kent Show.
1st	SUN	6TH SUNDAY AFTER TRINITY.
2nd	M	
3rd	TU	National Rose Society's Show, South Kensington.
4th	W	Gardeners' Royal Benevolent Institution, Annual Dinner.

MAKING MISTAKES.

NOTHING is more easy than to make mistakes in gardening. The best gardeners of the day have committed many errors, though it is not quite customary to own to them. Mistakes are made in heating, watering, ventilating, potting, pruning, digging, manuring, sowing, and planting. Those persons are wise who recognise their blunders, remember them, even write them down, forming a chart, as it were, with the hidden rocks marked by beacon lights to guide safely along in the future.

But if gardeners make mistakes employers are not always free from errors; and while it is not improbable that a hard master has more than once blighted the prospects of a good man, it is very certain that numbers of good masters have been driven to lose interest in their gardens by the imprudence of their gardeners. This is the greatest mistake of all that a gardener can make.

A tolerably long experience with gardeners and owners of gardens enables me to say positively that many gentlemen who are accused of being hard and unreasonable are in reality often very forbearing. When a master wants one thing and a man another, and the master yields, does he not make a sacrifice; yea, as great a sacrifice as a gardener does when a young man under him does not comply cheerfully with his wishes, and yet is kept in the hope that he may eventually become more tractable? It must never be forgotten that he who bears the cost of a garden has an undoubted right to do what a gardener may deem wrong. A plant may be grown for twelve months, be watched, tended, and cherished by a gardener, then in a moment may be spoiled by having its head cut off, because the flower would be particularly cherished as cut and placed on the table of the owner. There it would give satisfaction, but the plant itself might not be cared for, except for the purpose of producing other flowers for cutting in the same manner. In such a case it is to the gardener's own interest to grow such flowers and cut them cheerfully. A gardener who readily, and, as a rule, complies with what he occasionally feels is an unreasonable request, will be far more likely to be allowed to gratify his own desire in a special matter than will a man who gives grudgingly what an owner wants of his own.

I could tell of a gardener who for years had his own way, growing what he liked, and only cutting what he wished in a beautiful garden (which the owner did not much enjoy, because he felt as if it was not quite his

own), now in a very different position. The estate changed owners, and the new proprietor took a fancy for Orchids, but in this particular way—that immediately a flower or spike expanded it was to be cut, no matter what it was, and sent into the owner's room. It was, moreover, the same with all other flowers; every flower had to be cut daily, whether it spoiled the look of the plant or not. The gardener did not take kindly to the change, and felt and said he could “never live with a gentleman so unreasonable.” He wisely, however, hesitated in relinquishing a not laborious charge, with £100 a year and the usual privileges. He made, indeed, a mistake in prejudging a gentleman whom he now considers amongst the most reasonable of employers. The gardener gradually fell into the way of cutting the flowers, which was at one time almost as painful to him as cutting himself, but seeing the pleasure they gave to the owner, who in that form appreciated them so highly, he (the gardener) at length came to have pleasure in doing that which previously gave him pain. He cuts choice flowers now with alacrity, and the more he has the greater he enjoys the work, because he now says the “dear old man almost worships them.” In return for this cheerful compliance with the wishes of an “unreasonable” master, this gardener, who so nearly made an almost fatal mistake, has had instead £50 a year added to his salary and was never before so comfortable as he is now. If the owner wanted a Vine cut down and taken in to show the crop of Grapes this happy gardener would now cut it down in a moment without any compunction, with perhaps a remark, “It is his Vine, not mine, let him have it.”

I could tell of another gardener, whose life is practically that of a gentleman, whose employer certainly ranks amongst the most influential half a dozen individuals in the realm, who attributes all the comfort he enjoys, and the confidence of the employer he serves, to sinking altogether his own fancy and commencing to do what he had been all his life taught to be unreasonable. He enjoys the garden in his charge, because its owner has been led to enjoy it also, instead of having been alienated from it by a different course of conduct on the part of his gardener—a “standing up” as he might mistakenly have called it for the “dignity of the profession,” which, being interpreted, means the dignity of nonsense and the indignity of himself.

Yet another example I could adduce. A nobleman, the owner of one of the most princely estates in the kingdom, engaged a gardener. This gardener, on hearing that his new employer was most unreasonable, hard to please, and that “nobody ever stopped with him,” was on the point of cancelling his engagement, and would, I believe, have done so had it not been for a good adviser, who, knowing the man's tact and ability, urged him to give the place a trial. On reflection he said, “I will, I will try and manage Lord X. for a year, and if I succeed in that I know I can manage his garden.” That was a wise resolve. He ascertained the peculiar requirements of this “unreasonable” family, and now there are probably few men more comfortable and more safely established than my friend is in his splendid charge.

I have given instances of mistakes that have fortunately been averted. It would be easy to give more that have been committed of individuals resigning, because they could not bend to an employer's wish,

and are now living a life of drudgery, painfully conscious and ready to admit the great error that they might so easily have avoided.

There are, of course, instances where a gardener cannot consistently with his own self-respect and without sacrificing his manliness of character endure the pressure that is put upon him, and he decides to take his departure as the lesser of two evils. The only consolation attaching to a case of this kind is that the really hard and unreasonable taskmaster usually has inflicted on him a worse gardener than the one he drove away, and it would be no worse if owners of gardens would recognise that contingency.

Individuals who are really the most hard to serve are those who are ever changing their minds—fanciful, impulsive people, who see something, go into ecstasies over it, and “must” have it. A gardener strives to meet the wish, and works for a season diligently to that end, yet when he has accomplished the object for which he has laboured, instead of meeting with approval, he has the mortification of finding his labour has been in vain, time has been lost, space wasted, and patience exhausted, for something else is wanted now, and so the worry goes on. It is in this way that employers make mistakes, lose good men, and get inferior servants.

Patience and tact are of great advantage to much-pressed gardeners, for, as a rule, those who possess these qualities triumph over their obstacles sooner or later. Some years ago the family of a gentleman were so fond of flowers that they were in the habit of pulling, not cutting, Camellias, splitting off the branches, and, of course, preventing future flowers; they would also in cutting Amaryllises take off the top of the bulb because they liked the green with the flowers. That was an exceptional case, and these things are not done now. The gardener's patience stood him in good stead, for it enabled him to continue until the young ladies grew up, and he taught them that plants will not live without leaves and with such treatment the bulbs would die, and now he is one of the happiest old men alive.

Mistakes in routine, such as those indicated at the commencement of these notes (and which will perhaps be further noticed) are often inconvenient enough, and should by every possible means be avoided; but they are trivial in comparison with the fundamental errors that are too often committed by masters and men; by the latter often hastily, by the former unconsciously and thoughtlessly, for, as has been truthfully observed, “evil is wrought by want of thought more than by want of heart.” With more consideration there will be fewer mistakes, and owners of gardens will be better satisfied and gardeners more contented.—EXPERIENTIA DOCET.

ELLIOTT'S YORKSHIREMAN AND SANDERS'

TELEPHONE CUCUMBERS.

A BREAKDOWN OF THE “EXPRESS.”

ALLOW me to call the attention of the readers of the Journal to these Cucumbers. It is seven weeks to-day since the seed was sown, and I think the plants are worth looking at. Those who cannot see them may fancy a plant with six or seven Cucumbers, each weighing from 2 lbs. to 1½, these at this weight being very young, with the flowers still on them. In my experience Elliott's variety beats all for rapidity of produce. The flavour of both is all that can be desired. Telephone is not quite so free in bearing, but the fruit is longer. I shall grow a larger quantity of it next year; and now having the pen in

hand I will endeavour to give you a brief account of my attempt at the Express system of Cucumber-growing.

First, I may say my early house is a lean-to, 70 feet long, 11 feet wide, 10 feet high at the back, and 5 feet in front, this giving me 11-foot rafters. The roof is well glazed with squares 12 by 20 inches. I am particular in giving sizes to benefit others. It is heated with two rows of 4-inch pipes under the bed; two rows along the front, and four rows in the path for affording top heat. There is thus a good amount of piping, also a good boiler to work it. The back wall is white or lime-washed.

On the first Saturday in March, having strong plants, a start was made, under the impression that we had passed through the rough weather; but it was not so, for as you are aware, winter began in earnest after the first few days of that month. The house faces west, so gets very little morning sun. I had been at the trouble to visit one place where the Express system was at work, so provided troughs 3 feet in length for covering the whole of the pipes, as I was informed that much atmospheric moisture would prevent the necessity of ventilation.

Time went on, and I thought, notwithstanding the cold winds which compelled me to fire rather hard, that I was on the right track, but I soon found I was miserably disappointed. I got the roof nearly covered with grand healthy-looking foliage, and fruit showed in plenty. Not one, however, in ten could I set. I kept working away, however, with both fire and water, yet with no better results. I then called in a cultivator who had made a speciality of this system, and he at once told me I was wrong. In the first place there were too many evaporating pans by two-thirds, and the soil was too loose in the bed, causing me to give too much water. The next day, a very hot one, the temperature of the house was 120° with no ventilation, and of course no shade. The result was that the plants were burnt to that degree, that after trying them a fortnight longer with shading as required, I pulled them up and planted again. Well, these plants are doing on what I call my old plan, which is plenty of fire, plenty of water at the roots, not too much syringing, as little ventilation as possible; in fact, none if they will do without it, but affording shade with scrim canvas as required. The failure of this house was very serious to me, as I never in the best week cut over twenty Cucumbers, and these of such a pale colour and small, that they only realised a low price in the market.

The causes of failure in this house I attribute to excessive moisture in the atmosphere and dryness of the roots, for certainly I did not give sufficient water. I believe in a well-drained bed with pipes under it that it is almost impossible to give too much water. One cause of the burning of the foliage I now find to be in the fact of the wires being only 14 inches from the glass. They ought to be twice that distance.

The variety I grew was the “Special Express” from Preston, obtained through a friend. The fruit I like much, though I suppose it is only a crossed Telegraph. It, however, does not come large with me. The new lot of plants with shading endure a temperature of 120°; in fact, they like it.

Were I to start early another season I feel sure I could succeed, being perfectly satisfied where my mistakes occurred. I started on the new plan because last year the plants had a slight touch of disease caused by want of water and low temperature, the result of being short-handed during the Grape-thinning period. In my next I will give particulars of culture in a house facing east.—STEPHEN CASTLE, *The Vineyard, West Lynn.*

SOME THOUGHTS ON GARDEN MANAGEMENT.

THE term Garden Management is expressive yet relative. It may mean management of soil, of means, of men, occasionally of masters; the latter an accomplishment which it is to be hoped does not require a large number of students, though as a study it may be an exceedingly useful one in some cases. The management of the soil is particularly a matter requiring long experience and careful attention. An experience of one or two years will not ascertain either the weak or strong points in a soil, and anyone taking a garden in hand and thinking that just so much digging, manuring, and seed-sowing are

necessary to secure good crops, is a mistake. I always think the thorough knowledge of his garden possessed by the man who has passed the greater part of his working life in one place, is a feature at once as noticeable as it is creditable to its possessor. With his experience he never attempts to grow certain crops in some positions, and he will year after year have some vegetable in one particular quarter. When a man has had charge of a garden for seven years he may at that time be considered a journeyman. It is only after years of patience that he can take his place beside the masters.

As to the management of means, this should always be resolved into a question of "means to ends." Place the end in view before a man, give him the means to reach that end, and very few would fail in reaching it. The mistake is, that both with employer and gardener there is a want of definiteness about what is wanted for a certain sum spent. I think, for instance, gardeners have themselves partly to blame for employers insisting on purchasing seed in "collections." If the seed list is made up carefully, so that economy is practised, not in buying cheap articles, but in doing with few sorts, and no more of a kind than is fairly sufficient, there can be no saving in "collections." If, on the other hand, a gardener must have a dozen varieties of Onions, half as many of Celery and other vegetables in the same way, we have an expensive seed bill at once. Again, if you have the opportunity of inspecting a series of seed lists, it will be found that the orders for various seeds are in the most extraordinary proportions. Here are items from one: 2 ozs. of Sweet Peas, 2 of ozs. Golden Feather Pyrethrum, and a quarter of a pound of Perilla nankinensis. Collections in such cases become weapons of self-defence to an employer.

I will now turn from these questions to other points of management, lying very often beyond the power of the gardener either to change or to mitigate; such, for instance, as the suitability or the unsuitability of a garden site, which once fixed, and the garden in working order, is practically unalterable. The wettest, or the shallowest, or the coldest spot on an estate is selected with infinite pains by some bygone sage, and we, of the present day, like the chieftain for his child, "are left lamenting." I was requested a year or two ago to estimate the approximate cropping value of a vegetable garden, and at the same time to give a rough idea of the lowest cost it would involve to work it and keep it in good condition. What I found was this, and some of these figures will be found to be at the least striking. The area enclosed was $4\frac{1}{2}$ acres, of which walks covered three-quarters of an acre, fruit houses with borders one-third of an acre, open quarters and borders for vegetable cropping and small fruits less than $2\frac{1}{2}$ acres, the remainder of the ground being occupied by a system of narrow borders sacred to the culture of Apples, with 2 feet alleys round them, the latter reaching considerably over a quarter of an acre in the aggregate. The corner devoted to the reception of rubbish, soils, and manures was so situated as to be on an average for the journey to and from the garden just a quarter of a mile off. Now we cannot do without walks, and in gardens proportionately more than in any form of open field culture, but a case that requires an acre set apart for means of carrying and locomotion to every $3\frac{1}{2}$ occupied by crops, surely is past a paying or necessary proportion. But not only was much of these walks and alleys lost ground, it was more than lost; being, in fact, a continual drag throughout the busiest months of the year to keep in presentable condition. But further, only a comparatively small portion was used by workmen, the remainder being kept free from traffic to save work in keeping them clean. Possibly the per-centage of ground under walk-culture in the above instance was considerably above the average. The question is, of course, one for proprietors to see to, and they may depend on it that all extra work which can be by any means saved, pays not only in as far as it saves labour in a direct manner, but workmen always work with a keener relish when they find there is no wasting of their strength on labour which under an enlightened management would be altogether unnecessary. A gardener by himself can only save his men in details; backed by his employer, not only can he save in details, but the necessity for much of his labour can be saved altogether.

These thoughts are only a small contribution to a very wide subject, which there is every reason to believe that in the future, as the struggle for place increases, and as the purchasing power of money narrows; as men of business habits multiply as employers in the gardening community, and bring these habits to bear on our craft in all its bearings, will revolutionise much which at the present day is allowed to remain as part of a system which, to say the least of it, is not always carried on on sound principles.—B.

PIMELEA ELEGANS.

Most of the Pimeleas are useful greenhouse plants, easily grown, free-flowering, and of graceful habit—all recommendations of great value. *Pimelea elegans* is one of the most distinct species, and is deservedly a favourite with many cultivators, as its large heads of creamy white or occasionally nearly pure white flowers are produced so abundantly that the plant is ornamental in no ordi-



Fig. 118.—*Pimelea elegans*.

nary degree. Small specimens in 60 or 48-size pots flower very freely; and this is an especially useful character, as such plants are always in request for conservatory and greenhouse decoration. A moderately light compost of turfy loam and peat with a little sand is most suitable for this as well as the majority of other Pimeleas, and with good drainage water can be supplied liberally whilst growth is advancing. It flowers during the spring months and continues for a considerable time. The woodcut (fig. 118) represents a small branch with a head of the flowers about the natural size.

CELOGYNE CRISTATA.—If Mr. Grindrod will read my article again on the above plant he will find I do not recommend cutting out leafless pseudo-bulbs. What I stated was merely this. "If the plant becomes very crowded with pseudo-bulbs it is best to divide it. Some growers recommend cutting the spent pseudo-bulbs out to

give the others room, but I have not tried it, although it appears possible." What I had in view were large specimens to be retained as such, not to be divided; as I am perfectly aware, if a plant were divided it would be folly to cut away the leafless pseudo-bulbs.—A. YOUNG.

NEW AND COSTLY VEGETABLES.

EVERY year seedsmen's lists contain some novelties in the way of new vegetables, which are offered for the first time at what appears to many a high price, and for this reason many will not buy new vegetable seeds for some years after they are sent out and until they become cheaper. This, no doubt, appears economy to them, but I question very much if it is so. The best and most valuable vegetables remain high in price for many years after their introduction, and in my opinion it would be cheaper for all to buy every new vegetable of merit the first year it comes out, and make the most of it afterwards. Those who this year bought, say, Evolution Pea at 5s. per packet, and Paragon at 3s. 6d., would not get much seed for their money, but they would have a small handful, and enough to form a good row sown thinly, and if half of the produce of this is allowed to ripen for seed, more may be saved than could be bought next year at 10s. If the two Peas we have named are like some others we know, their price and quantity will be about the same next year, and those who have purchased and will save them this season will find themselves gainers to a considerable extent.

I have taken Peas to illustrate what I mean, but the same remarks apply to Beans and many other vegetables. In the month of March last I had about a thimbleful of a new Dwarf Kidney Bean seed sent me, but the seeds were so few that we determined to make the most of them, and on the day they came here they were sown in pots and the plants grown under glass. By the middle of May they had not only fruited but matured their seed, which was gathered and planted in the open quarters. The thimbleful of seed we had in March had become a good handful in May; by September it will be a pint or more, and then we shall not only have made the most of our stock, but have proved the value of the Bean both as a forcer and a main-crop variety in one season. It is by working new seeds in this way that many persons might test their qualities and make the most expensive profitable. I merely throw out this hint for the benefit of any of your amateur readers interested in such matters.—J. MUIR.

DO FLOWERS EXHAUST PLANTS?

THERE are numerous opinions on this subject, nevertheless it is one worthy of consideration and discussion. I am inclined to believe if the majority of practical gardeners were asked this question they would answer it in the affirmative. There are, however, others who would quickly tell us that the advocates of such views had yet to prove the exhaustive effects of flowers upon plants. A very similar declaration was made some time ago in this Journal, and from the most careful observation since that time I am more convinced than ever that a bountiful supply of bloom has a very exhausting effect upon a great variety of plants. Upon no class of plants is this exhaustive tendency more marked than amongst Orchids; it is evident with many species and varieties even before the flowers fade. Take, for instance, a plant of *Odontoglossum cirrhosum*—one that has a pot full of living roots, and is in every respect healthy and vigorous. Suppose this produces one or two large spikes of bloom, carrying, say, fifty flowers on the one spike, or eighty or more on the two. If allowed to remain upon the plant until they fade, what will be the appearance of the plump healthy pseudo-bulb? It will be more or less dry and shrivelled, and the support the flowers have required has been the means of producing it. This shrivelled appearance can be prevented by the removal of the flowers some time before they fade, and the plant would be much benefited by such a course.

If we allow only one or two flowers to remain until they fade on plants that have been imported twelve months, of such varieties of *Odontoglossum* as *Alexandra* or *triumphans*, or any similar variety, they will stand still for a long time before new growth is produced; but if these flowers are removed as soon as they can be observed the plants immediately push forth their growth, thus clearly showing that the flowers take the support stored up in the pseudo-bulb. If the flowers are produced in such numbers as to draw from the plant the stored-up nourishment until the pseudo-bulb shrivels, the next season's growth must naturally suffer. Is not this state of things equally as marked amongst *Dendrobiums*? Take the old *D. nobile*, for instance, one of the freest of all, which may be strong and the picture of health. Ripen the growth thoroughly until every growth will flower profusely, and allow the whole to remain upon the plants until they naturally fade,

and I ask those who ignore the idea that flowers exhaust plants whether the plant referred to would produce equally as vigorous growth and strong thick pseudo-bulbs the following season? Declining vigour is equally marked in other varieties, and there is no comparison between the growths made of imported plants of *D. Devonianum* *D. Wardianum* and others that have been allowed to produce a mass of flowers and retained until they fade, and those from which the flowers were removed as soon as they could be seen. What is more affected by continual flowering than the *Phalaenopsis*? If a start is made with small plants, and strong vigorous specimens are the object, it is a mistake to allow them to carry all the flowers they will produce while in a young state. Under a continual flowering system the progress of the plants would be slow in comparison to those from which the flower spikes had been removed.

If we glance at *Azaleas* and *Camellias*, will not an enormous quantity of bloom have an exhaustive tendency upon them? Take two plants of the former, healthy continental specimens, that are imported annually and generally flower so profusely. They should be the same variety, and placed side by side, and given exactly the same treatment, with the exception of allowing one to flower and their removal from the other. At the end of the first year compare results, and the verdict will be in favour of the one from which the flowers were removed. Grow these two on the same principle for three or four years, and the non-flowering plant will be more healthy and considerably larger than the one allowed to flower annually. Do not the same remarks apply with equal force to *Ericas* and other hardwooded greenhouse plants?

Is not exhaustion equally apparent with that free-growing plant the *Chrysanthemum*? Grow these strong so that the plants will produce 200 blooms each, and what will be the number and condition of the suckers that spring from the base after flowering? Will they be as early, numerous, and strong as from a bush plant that has produced only a few inferior blooms? This exhaustive tendency is even marked where the whole forces of the plant are concentrated towards the production of large blooms. Growers of this class of plants have often a difficulty in obtaining cuttings through the exhausted condition of their plants.

Take two *Zonal Pelargoniums*, as I have done, and give them exactly the same soil and treatment; allow one to flower and remove the flower trusses from the other, and what is the condition of growth and vigour of the one that flowers compared with the other?

I could go on enumerating many other plants that are exhausted by flowering; but when we find from careful observation that plants of such luxuriant growth as *Chrysanthemums* and *Zonal Pelargoniums* are brought into an exhausted condition, it does not require much intelligence to realise the fact that plants are exhausted through the production of flowers, more or less according to their luxuriance and the length of time the flowers remain upon them.—W. BARDNEY.

PLANTS AND GRAPES AT LILLESDEN.

THE grand conservatory adjoining Lillesden House, Hawkhurst, Kent, under the able management of Mr. Channing, is always attractive. The climbers are particularly well selected and well grown. The whole structure is highly perfumed by a large freely flowered specimen of *Rhynchospermum jasminoides*; this well covering one high pillar, and in addition a considerable portion of the trellis over the roof. The double-flowering *Tropæolum Hermine Grasshoff* also proves particularly well adapted for covering the pillars and trellises of conservatories whether planted out or in pots. At Lillesden the plants are completely covered with orange-scarlet blooms; these, being very double, of large size and sweet, are serviceable when cut. This *Tropæolum*, being of the easiest possible culture, ought to find a place in every conservatory or greenhouse.

The Rose-flowered Bramble (*Rubus rosæfolius coronarius*) in this conservatory is very ornamental as a wall plant. It throws up suckers and spreads freely. The foliage is fairly attractive, and the double white blooms, from 2 to 3 inches in diameter, are produced continuously throughout the winter and spring months. Altogether it is a serviceable plant, whether for conservatory decoration or for furnishing cut blooms for hand and buttonhole bouquets. Any ordinary soil appears to suit it, and at Lillesden I saw it growing freely planted out on a bank.

Lapagerias are grown remarkably well. The strongest specimen of the beautiful white-flowering variety I have seen is growing in a slate tub. A compost, consisting principally of roughly broken turfy loam and fibrous peat, abundance of moisture at the roots varied occasionally with liquid manure, and an ordinary conservatory temperature, exactly meets its requirements. Many of the

growths of this and the rose-coloured variety attain a length of upwards of 20 feet, and I am informed flower throughout nearly the entire length. They are also seeding freely.

What, however, most pleased me in this conservatory were the banks of grand Camellias, Palms, Musas, and Ferns. The former are principally planted out in large borders filled with loamy soil, and a finer lot of plants I have never seen. Many of them were at one time freely cut back by Mr. Channing, and this, coupled with good culture, has resulted in dense pyramids and bushes ranging from 6 to 9 feet in height. These, being clothed with large and glossy foliage, are always ornamental, and when in full bloom must present a magnificent appearance.

The collection of Ferns includes several large Alsophilas, Cyatheas, and Dicksonias, and among the dwarf-growing choice species are Gleichenias, Davallias, Adiantums, and Gymnogrammas, in good condition. There is also a fine plant of Lomaria discolor bipinnatifida, and this comparatively little known variety would, if grown as well as at Lillesden, tell well in a collection of exhibition Ferns. In habit it somewhat resembles Blechnum brasiliense, but it is more elegant and scarcely so long in the stem. The fronds, which are fully 2 feet in length, are very abundant, slightly crisped, and of a pleasing shade of green. It is found to best succeed in a conservatory or warm greenhouse temperature, and strong plants produce side-growths freely, which, however, are best separated, or the appearance of the specimen owing to its habit of growth may be marred.

Early Grapes are highly creditable to the cultivator. The varieties grown include Foster's Seedling, Black Hamburgh, and Madresfield Court. All were carrying heavy crops of medium-sized and well-finished bunches, but in point of quality I certainly prefer the latter. Grown under precisely the same conditions as Black Hamburgh, the Vines of it have perfected many handsome bunches, the berries being large and well finished, and were the most attractive in appearance in the house. All are rooted in a slightly protected or thatched outside border, yet the Madresfield Court has not cracked, nor is cracking anticipated. Under cooler treatment the variety apparently is most liable to crack, but forced as at Lillesden or grown with Muscats, or rather treated to the high temperature the latter usually receive, it does not crack badly, and the flavour developed is Muscat-like and very pleasing. If the Black Hamburgh is ever superseded to any material extent I should say it would be by Madresfield Court.

I see Mr. Barron, in his valuable work on "Vines and Vine Culture," gives it as his opinion that Madresfield Court should not be grown in heat, but is best adapted for cool-house treatment. I can truthfully assert that I have never yet tasted any grown under cool treatment to equal those grown on a Vine which I found in a Muscat house, and erroneously labelled Mrs. Pince's Muscat. It is, in common with the Muscats, rooted entirely in an outside border, and but few berries crack. Mr. Barron also remarks on the variety, that "if allowed to hang long the berries are somewhat liable to crack." I am under the impression they are more liable to, and do generally, crack before they are fully ripe, but will also crack if kept too long. It is by no means a late Grape. At Gunnersbury, where the variety is grown extraordinarily well, and under what I suppose would be termed cool treatment, although rooted exclusively in inside borders, it is found necessary to keep the borders very dry at the ripening period, in order to prevent cracking. This dryness at the roots must injuriously affect the varieties adjoining, and also I should think colour of Madresfield Court. Do they under this treatment develop a more "distinct Muscat flavour?" and would not a few hints as to the best methods of growing and ripening this splendid variety be very acceptable if forthcoming from experienced growers?—W. I. M.

PROSPECT OF THE POTATO CROP IN IRELAND.

I HAVE lately been through much of Leinster and Munster, and have had reliable correspondence from the other two provinces that enables me to send you notes on this subject with some confidence, relying mainly, however, on my own experience in our vegetable garden and fields.

Early Varieties.—Around here Early Rose is more grown than to my mind its inferior quality deserves. It has one merit, however—it comes in, planted in exactly the same way and at the same time, ten days earlier than any of the Ash-leaved Kidneys, Myatt's included. I planted it with three (named) Ash-leaved kinds, Beauty of Hebron, Early Border, First Crop (Carters'), and Eight-weeks (Carters'), on the 22nd of February last, and tried them on the 10th of June. The last-named (Eight-weeks) had the largest tubers and of the best quality; then Early Rose. The others were not fit to make any use of then. A week afterwards I planted White Elephant, Porter's Excelsior, the old Forty-

fold, that beautiful new variety Cosmopolitan, and Snowflake. Tried to-day, I cannot say any of those named are fit for use—none as large as hens' eggs, so far as I could see. One peculiarity I observed in the foliage of Carters' Eight-weeks—the leaves are invariably marbled white. Lord Donoghmore's gardener and Mr. Bagwell's, in the vicinity, had Potatoes, I see by a local paper, fit for table use a week before the date mentioned. Among at least the above early varieties around here there has been no check or failure. Above I should have named the Flounder as very generally grown; a heavy cropper, but inferior in quality and a bad keeper.

Late Varieties.—These are decidedly of the greatest importance. I had several tons of Champions direct from Forfarshire, and though very promising and robust, sown in lea ridges, I should like now a heavy downpour of rain for them. In moister soils it is luxuriating, and the Potato prospect generally is most hopeful, even on cold mountain sides. I have the next largest extent under Magnum Bonum. I have found it this year one of the best late keepers, lasting well up to the present, and this is the general experience. It cannot, however, compare in quality with the Champion early in the season. Schoolmaster promises well so far, and yielded fairly last year, but cannot come near White Elephant or Beauty of Hebron. So far two of my most robust growers are Woodstock Kidney and Holborn Favourite. I venture to say, as regards either quantity or quality, Potatoes will be the best for years past.—W. J. M., Clonmel.

CHELSEA GEM PELARGONIUM.

HAVING a few plants of this choice semi-double pink-flowered variegated-foliaged variety planted out before the heavy rain came last week, I am very pleased to see how well both plant and flowers stand the weather. I am particularly taken with it for pot culture. In pots the foliage itself is worth admiring, but when it comes into flower it is grand. All visitors notice it and would like a plant, but having only a limited stock I keep it for propagating. Never having seen a notice of this plant I draw attention to it thus early, considering it the gem of the season for either bedding or pot work. This variety is of robust growth, and yet of a symmetrical habit, and with me produces good trusses in small 60's; the older plants, however, in 48's do the best, being of course more striking with two or three good trusses of bloom. I have not a large stock, yet it is so readily propagated that I have never missed rooting every cutting. I will send you a line later on to report the result of the summer growths.—STEPHEN CASTLE.

THE WEST LYNN VINEYARD.

THE east coast of England is a favourite resort during the summer, the wholesome and pleasant breezes from the North Sea being particularly refreshing and invigorating. Tourists in increasing numbers appear to be recognising this, and possibly the more because of the admirable train service between Liverpool Street and the chief towns in Essex, Cambridgeshire, Norfolk, and Suffolk, with, now, a swing round into Lincolnshire and Yorkshire. On this line, too, the Great Eastern, are what may be termed some noteworthy seats of horticulture. Almost before we are out of the smoke of the metropolis we are at Low's of Clapton, Fraser's of Lea Bridge, Ware's of Tottenham, and anon we reach the famed nurseries at Waltham Cross, and almost smell the Roses at Cheshunt. Then there is the world-renowned fruit establishment at Sawbridgeworth, for which, however, Harlow is the most convenient station. At Colchester grow the grand Roses with which Mr. B. Cant so often triumphs at the great contests; at Chelmsford is the home of the Queen Apple, and where every autumn may be seen those beautiful Asters which Messrs. Saltmarsh exhibit so successfully at the Crystal Palace Shows; and at Cambridge is the Botanic Garden, which is increasing in interest yearly under the skilled curatorship of Mr. Lynch. Besides these there is a still more wonderful sight at St. Osyth, where Messrs. Carter grow flowers by the acre, field after field being glowing masses of colour, producing a spectacle that in July has few, if any, equals of its kind in this country. These establishments are known, by repute at least, by most, if not all, readers of these notes; but there is another, and differing from them all, that is less familiar, yet not less worthy of notice, Mr. Cooke's vineyard at West Lynn.

Mr. Cooke is one of those great farmers of Norfolk who so worthily represent British agriculture—indeed, he presumably occupies on lease the largest farm on Lord Leicester's estate, and by generous culture, well-applied skill, and intelligent action, founded on practical and scientific principles, has contrived to live

and prosper during a period in which too many have succumbed to the vicissitudes of the seasons and the force of circumstances. Instead of grieving at the cruelty of Fate, and moving slowly on the old lines as if there were no American grain and cattle, he admits the competition and endeavours to meet it. Both in stock and cropping he knows only the best will pay. With labour and manure he is generous, the most approved machinery being provided for expediting the former, while artificial manures best suited for each crop and the soil are largely and profitably employed, very careful experiments having been conducted for determining their adaptability in every case.

As an instance of the manner in which stimulants are used, 30 tons of nitrate of soda have been applied to certain crops during the present season; and as an example of the manner of working, the peculiar state of a Barley field and its treatment may be adduced. The growth of the Barley was regular, yet irregular, for between breadths that were satisfactory were strips apparently worthless—strips of luxuriance alternating with others denoting exhaustion. Various fertilisers were tried on small portions and the effects carefully watched for; but there was no response and it was eventually surmised that as the Turnips were trimmed and removed from the land that the tops that were cast on each side by the trimmers were not spread equally over the surface before ploughing, and in such a case the portions cleared would be deprived of potash, while the others where the tops were cast and ploughed in would have a double quantity. Potash was then promptly tried on the exhausted corn, and the effect was almost magical, the signal for a sufficient dressing being given to every part needing assistance. The result of this will be found at harvest, but can be foresadowed now, for instead of a comparatively worthless crop, over about half the field a level yield of 7 qrs. per acre is expected. As yet there is nothing much pertaining to Vines. The reason of this is we are not yet at the Vineyard, but at Mr. Cooke's residence at Fritcham Abbey, some eight or nine miles distant, and the experience narrated is far too suggestive to be overlooked, even if it blocks the way to a chat about Grapes. Mr. Cooke's experience with artificial manures is so great that it is hoped he may at some convenient time be induced to communicate his information, which would be valuable. Both of the garden and home-farm departments of this Journal he is an attentive reader, and it is only justice to the skilful writer of the latter to say that he has won the approbation of such a close observer and competent agriculturist as Mr. Cooke.

Now, at last, to the vineries. They are at Lynn—West Lynn it is called, because it can only be reached by a ferry over a broad tidal river, near its effluence with the Wash. The Grapes are grown here for two reasons, and both substantial. First because the Vineyard is on Mr. Cooke's freehold, and secondly because the land is far better, being rich alluvial soil, than the drier, poorer, thinner chalk formation at Fritcham. The soil around Lynn, marshland, is a rather strong greasy loam, calculated, agriculturally, to produce food for a bullock and five sheep per acre. All kinds of fruit trees grow well, and Strawberries luxuriate. It was therefore conceived that good Grapes ought to be produced if suitable structures were erected and competent supervision provided. Good structures there are, also a very competent manager in Mr. Stephen Castle; and Grapes of the late varieties are plentiful and of the first quality.

Mr. Cooke's object in growing Grapes was twofold. First because of the pleasure their good culture would afford him, and secondly because he expected a fair return for his outlay. Anything beyond a moderate return he neither hoped for nor expected. In this he was undoubtedly wise, for it is certainly not everywhere that a fortune can be made by Grape-growing now-a-days. Indeed, those who have not had much experience in the work usually lose before they gain, and gather wisdom as they go, profiting eventually by mistakes; while as for private gentlemen expecting to defray the cost of their gardens by selling the surplus crop after consuming the best produce, the idea, broadly speaking, is preposterous, yet it is entertained by some, to the discomfort of some correspondingly distracted gardeners.

The vineries are commodious, carefully designed, substantially built, and well-finished structures, efficiently heated, and a good water supply provided. They are, in fact, just such as we should expect to find in the well-appointed garden of a nobleman. They are also as clean and orderly as if adjoining a mansion. The principal range a lofty lean-to, faces the south. At right angles with this are two other lean-to's, each 80 feet long, one facing west, the others east. The space thus enclosed on three sides is occupied by span-roofed structures running east and west, the whole forming a very compact block of excellent houses three or four years old.

Before the space was occupied with Vines Tomatoes were grown

extensively, and with great success; but their culture commercially is now being practically discontinued, and they never proved so remunerative as many have supposed them to be. On this account probably it is that the two long lean-to's facing east and west are now occupied with Cucumbers, but it is not unlikely that one of them at least will eventually be devoted to Muscat Grapes. Mr. Castle can detail his experience in growing Cucumbers on the non-ventilating system, his first failing then succeeding better than I can; and it is only necessary to add in confirmation of his observations (on p. 530), on watering, that beyond question one great cause of failure was an insufficiency of moisture at the roots. The soil was moist on the surface, but on digging down to the base of the bed over the hot-water pipes it was dry as dust. The direct result of this is that fruit forms and the flowers expand, but there is no further progress; the small Cucumbers turn hard, curl up, decay at the points, and all is over. When the cause of the evil was determined water that was before given hesitatingly was now applied copiously, gallon after gallon being poured in as fast as it drained away. The result was almost magical, and fine fruits are now swelling freely—a hint that may perhaps be turned to account by those who have Cucumbers that are not satisfactory, and the plants growing and trying to produce fruit over hot-water pipes.

Two varieties of Cucumbers grown at West Lynn merit attention—namely, Elliott's Yorkshireman and Sander's Telephone. These are very free and very fine. The Yorkshireman averages 18 inches long, is short-shouldered, blunt-ended, of uniform thickness throughout, good colour, inclining to dark, and carrying a thick bloom. Telephone is somewhat longer, a little thinner, and slightly tapering, also a shade lighter in colour, yet is a very attractive fruit. Both these Cucumbers are of good quality, and according to the report on page 522 they secured the chief prizes in competition at the York Show. Notes on Grapes at Lynn must be postponed.—INSPECTOR.

ROSES ON THEIR OWN ROOTS.

UNDER the above heading I ask a little more space in your valuable paper, hoping thereby to clear up the mystery in some form as set forth by "A. F. M." (see *Journal*, June 7th, page 467) as to how good my "best" Roses are. I stated in the first place I was not an exhibitor, and only claim for my Roses average merit, yet surely it will be allowed that a gardener can and does do a thing well, though he be not allowed to exhibit.

Bearing this in mind, I send two or three of my average Roses taken from plants on their own roots, each plant carrying from one to two dozen Roses in different stages of development. The cuttings were inserted in the autumn of 1881, and the plants grown without any special preparation in an ordinary kitchen garden border, and I beg of the Editor to give his opinion as to their merits. If considered by him second or third-rate for the season I am content, and will strive to do them better another year. I have noticed particularly this spring as they open those on their own roots, those worked on the Briar, and those on the Manetti. As regards the bloom one is equal to the other, so far as I can see. Charles Lawson does the kindest of any I have tried on its own roots, and John Hopper next; the same difference may be noticed, I think, no matter on what stock these may be worked.

I feel sure "Y. B. A. Z." had he studied my paper on preparing the Rose cuttings and inserting the same, that he would observe two buds would be beneath the soil. I cannot say why I remove the two lower buds, unless it be that cuttings root more freely, but looking at the subject from a practical point of view one bud removed would suffice for that purpose. Hitherto I have potted all my stock, and do not consider it time wasted, but rather a gain. If "Y. B. A. Z." really cannot find time for this I would advise him to use a one-light frame, or as many with one light as he might require, and place the cuttings 6 or 8 inches apart each way. They might then be left for one or two years before finally transplanted; but so practical does his writing appear that I fear he might learn me a lesson rather than I teach him.

I ought to say I do not grow a large quantity, but just so many as I think I can attend to well. This applies to other things as well as the Rose. My entire stock of pot Roses (proper) all told is only fifteen. If I do these well they are worth more than double that quantity badly done. I beg to thank "Y. B. A. Z." for the list of varieties given, and wish him hearty success with the Rose.—A. J. SANDERS.

[Considering the age of the plants, and that each is bearing from one to two dozen blooms, we consider three of the examples before us—La France, John Hopper, and Charles Lawson—excellent; the remaining one, Capitaine Christy, not being expanded.

We expect to see hundreds of worse blooms in prize stands before the season is over.]

THE GREENHOUSE AND ITS INMATES.

THE CITRUS OR ORANGE FAMILY.

AN Orange plant in fruit is as interesting and handsome a plant as any amateur could wish to possess. Neither is there any particular care necessary in their cultivation. Plants require to be bought, for only those that are grafted produce fruit on small plants. Many amateurs have found this out after sowing seeds taken from ordinary Oranges. Plants thus raised grow freely enough, but they very seldom produce anything except leaves and thorns. Grafting an Orange tree is very different from grafting a Pear, and requires appliances which ordinary amateur gardeners do not possess. Propagating houses furnished with close cases are necessary for their propagation.

They thrive in good fibry loam mixed with a little bone dust and leaf mould. Careful drainage is necessary, for good supplies of water must be given when the plants are growing, and a steady moisture maintained even when they are at rest. If only one or two plants are wanted the temperature of an ordinary greenhouse will suit them, but when a good number are grown for the sake of the fruit a separate house with a high temperature should be given. However, we suppose few of our readers will grow Orange plants except for ornament. A warm sunny place should be given them when they are in flower and also in winter, but during the hot days of summer the shade afforded to ordinary greenhouse plants will be beneficial to them.

Scale and red spider are apt to infest these plants. To keep these plants the use of the sponge and syringe is necessary. Indeed, a dewing overhead in the evening after hot days will do them good, even should no red spider be visible, and, when it is, forcible syringings are absolutely necessary.

There are a great many kinds of Citrus, but perhaps the best one for adorning the greenhouse and fruiting in a small state is *C. nobilis*, the Mandarin Orange.

CLIANTHUS OR GLORY PEA

All the species of *Clianthus* grow better as climbers, planted out in a well-drained border composed of fibry loam and peat, with pieces of sandstone and charcoal to keep it open, than in pots. At the same time they may also be grown in pots and pinched into bush form.

Water in good quantity is necessary while the plants are growing, and, to keep down red spider, smart syringings, especially during hot weather, are necessary. *C. Dampieri* is the best, but *C. magnificus* and *C. puniceus* are both well worth growing.

CYCLAMENS.

Cyclamens are very neat, beautiful, winter-flowering plants that should be grown by everybody who can maintain a temperature of 50° or so. The main reason why so many people fail to grow Cyclamens successfully is that they keep them too cold and damp or them to make satisfactory progress. Loam, leaf soil, decayed cow dung, and sharp sand sum up the ingredients necessary to compound a soil of, which will suit them to perfection. Those who can command some heat in spring may raise a stock from seeds, but as most small growers require only half a dozen or a dozen at most, the best plan is to purchase plants. The best time to pot them is in autumn just as they start into fresh growth. After potting they should be put into a frame and the most made of the sun's rays to maintain a suitable temperature. This will cause a vigorous start. As the nights lengthen and the air becomes cooler, say by the middle of September, they should be removed to the house and kept at such a temperature as we have indicated.

In supplying water care should be taken to pour it on the soil and not on the crown, or the result will be damping-off. Watering should be done just as seldom as possible, but it must be thoroughly done, so that a properly humid state of the soil may be secured without incessant dribbling of water on the surface. After the flowering is past watering should be gradually withheld until the leaves ripen off, but care must be taken not to starve them off prematurely by giving them too little. After the plants go to rest they should be placed under a handglass or in a frame—not for the sake of heat, but to protect them from soaking rain. On the other hand, dust-dryness should be guarded against. The varieties of *C. persicum* are best for greenhouse decoration.

COMMON SENSE ABOUT VINE BORDERS.

A "MYSTIFIED CORRESPONDENT" asks for some "common sense remarks about Vine borders, as he has read up the subject until he feels as if he knew little about it." Perhaps the following article

may in some degree meet his wants. It is the production of a gardener than whom few have proved more successful as a cultivator of fruit:—

When we consider what vineyards are in Vine-growing countries, and observe how little manurial matters, comparatively speaking, the Vines are allowed, we may naturally feel astonished at the singular discrepancy in practice between the culture of the Vine under natural conditions, and as a matter of art in Britain. Many a Vine border in these kingdoms, appertaining to a house some 30 or 40 feet in length, has consumed as much of valuable manures and composts in half a dozen years as would serve, on the average, a Rhenish vineyard of an acre or more.

This I believe to be within the mark; and if so, we are naturally led to consider why such should be the case. That Vines out of doors, under the hot suns of Vine-growing countries, are more severely taxed in regard of their perspiring, as compared with their absorbing, conditions, I should think might be fairly assumed, especially when we take into consideration the generally drier conditions of atmosphere as compared with that of Britain. If so, why, then, with a heavier demand on their foliage, should they succeed with so much less food?

To be fair, however, in the statement, it is proper to observe that a Vine up a hothouse rafter in Britain, bearing annually, if all be well, from 20 to 30 lbs. of Grapes, has more work of that kind to perform than one like a large Raspberry bush up a stake, with perhaps a dozen pounds' weight of Grapes, and not by any means so much surface of foliage exposed to the light. This statement, I think, opens the case fairly; and let us look a little further into it.

One feature of a most salient character appears to me to present itself in the van of this argument. It is this: Will the Vine succeed well in such a material as a good mellow or free loam, otherwise called "maiden soil," from the circumstance of its having escaped tillage for some time, and thereby being rich in organic materials, but not in exciting manures?

I believe that a jury of really good British gardeners would affirm such to be the case. On the heels of this, however, arises yet another question of importance to all those who do not possess broad acres. Will the Vine succeed in common garden soils? We all know that Vines do succeed very well in various parts of the kingdom, out of doors, at least, in very ordinary soil, such as gardeners long accustomed to the term "loam" would despise.

Again, I have known an instance or two of Vines thriving tolerably well in the *débris* of an old wall; in fact, growing out of the very bricks; and a similar liberty they take, we are told, in wine-making countries, fastening on the *débris* of rocks and other disintegrations. I have also known the Black Hamburgh thrive to admiration entirely in old tan, in what had been a Pine house, the pit still retaining the original plunging material of tan, which had, of course, become almost black mould.

It must be admitted that with all these facts before us the most experienced in gardening affairs cannot but feel a slight degree of wonderment, and naturally approaches the subject with measured steps. However, a little reflection, and a desire to place the subject in as simple a light as possible, and not to be misled by collateral considerations of a trivial character, will soon show that it is not alone in this soil or that, neither on the amount of manurial matters alone, that the question hinges. Whatever the compost or soil be, there can be no question that its mode of receiving moisture and of parting with it, more determine the fate of the Vines than the previous considerations.

The free admission of the air to the borders has ever been deemed a matter of the highest import; but I must confess I have been exceedingly astounded at the reported success of our concrete men; and, had it not been for the well-earned reputation of some, I should have had doubts of an insuperable character. I cannot give up my ideas that the atmosphere ought by no means to be excluded. I much fear that in such cases the Vines, like some retired little gentlemen, are living on their former gotten wealth; perhaps on the very capital itself.

To sum up the evidence, then, the case may possibly stand thus:—Have you got what is called a good medium loam, rather sandy, and containing much organic matters? Rest assured, then, that you need not invest much capital in the purchase of gross manures; certainly not in the dead carcasses of animals. Have you nothing but a good garden soil, which smells strong of the spade, and which possesses no amount of coherence? Let me advise you, in the absence of more powerful materials, to add what may supply the deficiency, by trying to represent the organic matters the aforesaid loam possesses, such as old linings of hotbeds, half-decayed leaves, or vegetable matter, possessed of strong fibre. Other materials might be named, but I fear to tamper with the question, as I merely write for the inexperienced.

I do not wish here to affect to repudiate the idea of a compost

when thrown together by experienced persons, whose practice is dictated by something more than mere rule. I believe it possible to add something of much service, but not with the single idea of enriching the compost, but rather for the sounder purpose of securing a long-enduring texture in the soil. Lime rubbish, especially mortar and plaster from old buildings, charred and burnt materials, these can seldom be wrongly introduced, unless in thoughtless excess. But their presence in a compost, or their amount, should ever be ruled by the texture of the chief body of the soil; they are opener, opposed to cohesion, and to introduce them liberally to a light and stringy soil would be to expose the compost to every extreme vicissitude of drought; and we must endeavour to be prepared for every contingency, if possible.

I need scarcely point here to the necessity for the most perfect drainage beneath. All the world now are unanimous as to that; but one thing more I would name, and that is the immense benefit of surface-dressings of rich manurial and organic matters. This



Fig. 119.—*Boronia tetrandra*.

is the best way of forcing the powers of the Vine when requisite. There it interferes not with the mechanical texture of the soil, and if Vines were planted on a well-drained bottom, on sound turfy loam of only 6 inches over the drainage material, there is no doubt that they might be annually decoyed upwards several inches every year by this process; downwards they would scarcely require to go.

BORONIA TETRANDRA.

SIMILARLY to the *Pimelea* figured in another column, this *Boronia* is a useful spring-flowering greenhouse plant that is now known and appreciated in many gardens. It is by no means a novelty, as its introduction to this country dates back to the year 1824, and specimens of great size are now occasionally seen in old gardens. Though not novel, it is, however, well worth attention, as it is yet unknown to many who nevertheless might value useful plants. *Boronia tetrandra* and *B. pinnata* have been somewhat confused in some gardens, the former being frequently wrongly referred to the latter species, a mistake which has been chiefly caused by the similarity of the foliage. The leaves of *B. tetrandra* are, however, smaller than the true *B. pinnata*, and while the species represented in fig. 119

has the flowers nearly sessile in the axils of the leaves, the other produces its blooms in short racemes. In the one now being considered the flowers are pale pink, differing slightly in the depth of the tint, according to their age, the older ones becoming almost white. They clothe the branches thickly, springing from nearly every axil. A similar compost to that recommended for the *Pimelea* will suit this *Boronia*, but a little more loam may be employed, and it is important that the pots are not too large.

GRAPE DUCHESS OF BUCCLEUCH.

ALTHOUGH universally acknowledged to be the best flavoured of Grapes, this has yet dropped out of cultivation to a considerable extent, chiefly owing to the smallness of its berries, which are below medium size, and partly because it sometimes does not set as freely as some. But when we consider that it ranks as the best in flavour of any, ripens in a Hamburgh temperature, and is a prodigious cropper when well treated, it will be seen that for supplying a private table plentifully with superior produce it is worthy the attention of growers, especially those who possess no Muscat house, and whose range of vineries is not great. At Hope Park, Bonnybridge, the residence of George R. Ure, Esq., may be seen very particularly fine samples of this fine Grape. The vinery in which it is grown is but small, and the climate is none of the best, being cloudy and wet. To make matters worse the vinery gets no afternoon sun, yet by starting early the growths are well ripened. The Vines were planted in 1877 from eyes struck the same season, and have been heavily cropped every year since. This season the crop is, as usual, very heavy, but none of the varieties is so striking as Duchess. Numbers of the bunches are over 20 inches long and 14 inches across, and are borne in such profusion that they could easily be linked in one continuous chain from top to bottom; yet these are borne on rods that have been pronounced overcropped every year. The soil is of a by no means favourable description, much of it being roadside turf. But they have been plentifully fed on food, though usually regarded as waste, yet plentifully supplies everything wanted.—OBSERVER.

CHERTSEY DISTRICT SHOW.

SUBURBAN district horticultural exhibitions are peculiarly enjoyable gatherings, always provided the show day is fine. The gardening of a district is represented on an acre or two of ground in some gentleman's park, and music is provided to enliven the proceedings. A district may embrace a dozen parishes or an area of several square miles, and all the gardeners within the charmed circle are eligible to compete. Numbers of these do compete, and hundreds more visit the show to take stock of their neighbours' doings—to admire, criticise, and give and gain hints on the work of their lives, for a great deal of earnestness and keen rivalry exists amongst suburban gardeners. The wealthy and well-to-do of the districts, also, have a sort of horticultural field day, and it is wonderful to see the number of "carriage people" who attend these shows. At the one under notice the aristocratic-looking and well-appointed equipages appeared almost or quite as numerous as at one of the Royal Horticultural or Royal Botanic Society's exhibitions in London.

The Chertsey District Horticultural Society has as patrons most of the leading inhabitants around, a President of world-wide horticultural fame—Mr. G. F. Wilson—a very practical working Committee, and a Secretary in Mr. Rawlings who combines business aptitude with courtesy, and who has discharged with success his duties for eighteen years—this being the eighteenth Exhibition. The shows are moveable, and are usually held in the grounds of the local gentry, who kindly place them at the disposal of the Committee. The Exhibition in question was held in Ashley Park, the seat of J. S. Sassoon, Esq., whose Cromwellian residence is pleasantly situated in a well-wooded demesne of some 500 acres, where thriving young Conifers link the present with the past, as represented by iron-bound and venerable Yews.

Of the Exhibition itself nothing like a detailed report will be attempted, but only its general character will be as briefly as possible described, and a few noteworthy productions particularised.

Half a dozen marquees were in requisition—one, very large, being devoted to plants, another to fruit and cut flowers, a third to "effect" groups, a fourth to cottagers' products, and the others to administrative purposes. Although the prizes were not large the competition was good, and the Show on the whole decidedly creditable to the many competent individuals who brought examples of their cultural skill, or displayed their taste in floral arrangement.

In the plant classes Mr. Cornhill, gardener to C. Pettit, Esq., Oatlands Park, an exhibitor of more than local fame, took the lead in most of the chief plant classes, staging flowering, fine-foliage plants, and Ferns of large size and in admirable condition. Very noteworthy was a splendid variety of *Anthurium Schertzerianum*, remarkable for brilliancy of colour and handsome spathes, some of which when fresh were upwards of 7 inches long. Mr. Plowman, gardener to

C. Lavers Smith, Esq., Oakfield, Walton; Mr. Povey, gardener to A. Gillespie, Esq., Weybridge; Mr. Millican, gardener to Mrs. Corbett, Walton; Mr. Frankis, gardener to J. M. Wilson, Esq.; Mr. Reid, gardener to C. A. Ledward, Esq., Oatlands Park; Mr. Sutton, Ashley Park; with Messrs. Mann, Waite, and Beckett, were amongst the successful competitors in the large tent. Fuchsias were very good, Caladiums excellent, Ferns and Selaginellas generally superior, Achimenes variable—some good, others fading; Show Pelargoniums, except from Mr. Beckett, inferior; Zonals also faulty, except a fine specimen from Mr. Plowman; and Begonias fresh, bright, and good. These plants staged in large numbers in the several classes made a fine display, the beauty of the tent being materially enhanced by a most meritorious contribution of Heaths, Orchids, &c., from Messrs. Jackson & Sons, Kingston, effectively arranged by their skilled and experienced cultivator, Mr. Puddock.

The tent in which the groups were arranged for effect was a great centre of attraction. The groups, semicircular in form, were arranged round the sides of the marquee, the centre being quite free for promenade purposes. This is a very good plan of arranging this department of a flower show, and this method of exhibiting enables many persons to compete who are not required, or have not the requisite means, to grow specimen plants. Since the grouping system of exhibiting has become general there has been a great development of taste in associating plants agreeably; and it is not too much to say that the worst collection in the tent at Walton would have insured a first prize half a dozen years ago.

The competition was very keen, and the Judges had no easy task in making their awards. In the large class of semicircular groups 14 by 7 feet Mr. Cornhill won the premier position. The groundwork was composed of Adiantums, among which were grouped at the back Spiræas, and towards the front Kalosanthes and, sparingly, Saxifraga pyramidalis, with near the margin Orchids and Gloxinias peeping from the Fern. The back comprised Palms and Humeas, brightened with Delphiniums. The entire arrangement was free and pleasing, and not a pot was visible. Mr. Beckett secured the second place with a group rather too thin and a little "lumpy." The good quality of the plants was possibly not overlooked here, for it must be remembered that good culture will always tell. Mr. Povey had the third prize with, perhaps, the most light and elegant arrangement of all, and would no doubt have had a higher position had not all the pots in the front row been as visible as the shields of footlights in a theatre. Mr. Sutton was fourth with the brightest arrangement of all, Corn Marigolds being freely used, but it had evidently been arranged hurriedly, and some of the pots were obtrusive. A fifth prize was awarded, but we did not obtain the name of the exhibitor.

In the smaller groups, 10 by 5 feet, Mr. Plowman fairly distanced all competitors with a full, but not crowded, arrangement, in which Lilioms umbellatum and longiflorum were effectively associated with Palms, the margin being composed of Adiantums and good Gloxinias. Mr. Millican followed: he had a charming margin of Panicum, Ferns, and Gloxinias, but the back of the group was weak. The third prize was awarded to Mr. Reed for a pretty arrangement. The general result was highly creditable to the exhibitors; and if they will take as a type for margins the work of Mr. Cornhill and Mr. Millican, and for the body of groups the examples of Mr. Plowman and Mr. Povey, still better effects will be produced next year.

The tent containing the cut flowers, fruit, and vegetables was crowded throughout the afternoon. Epergnes and similar floral arrangements were attractive, and two prominent stands of flowers from Mr. Wilson, containing fine central spikes of Lilioms Szovitzianum and Hansoni; but the centre of attraction was a fine collection of Mr. Bennett's Pedigree Roses. There were boxes of each of the following varieties:—Henry Schultheis, a fine, rich, deep rosy salmon variety of the John Hopper type; Lady Mary Fitzwilliam, blush, of the Niphetos form, solid and conical; Earl of Pembroke, bright crimson, conical when expanding, the petals afterwards recurving, very rich; Mrs. George Dixon, a fine flower of the La France pattern, but darker, yet not so fragrant; and Princess of Wales, delicate rose, salmon centre, and very charming. These effective boxes of blooms were much admired and highly commended.

The Roses in competition were generally small, and those in the boxes of twenty-four blooms were too much flattened down in the moss, an error which veteran exhibitors never commit. The prize-takers were Mr. Sparrow, gardener to Rev. A. Bramwell, Barrow Hill, Chertsey, and Mr. Waite, Glenhurst, Esher. In the class for twelve the blooms were shown in clusters of two or three flowers, with semi-expanded and unopened buds, and the boxes were decidedly pleasing, the prizes going to Messrs. Cornhill; Felgate, gardener to T. F. Bircham, Esq., Burhill, Walton; and Millican.

Splendid stands of stove and greenhouse flowers were staged by Messrs. Cornhill, Plowman, and Povey, who secured the prizes in the order named; and trusses of Zonal Pelargoniums from Messrs. Sparrow and Plowman were very fine indeed.

Fruit was sparingly exhibited, yet good produce was staged. In the class for white Grapes Mr. Cornhill was first with good but not quite finished Muscats, Mr. Sutton following with well-ripened Foster's Seedling. In black Grapes Mr. Hill, gardener to A. Savory, Esq., Potters Park, Chertsey, was far in advance, and easily secured the chief prize, followed by Mr. Watford, gardener to J. G. Holloway, Esq., Sunbury, and Mr. Sutton had the chief prize for a collection of six dishes of fruit. Good Melons were staged by Messrs. Frankis,

Sparrow, Manderson, and Millican, who were awarded the prizes, by far the best fruit being a seedling green-flesh by the first-named exhibitor. It has some resemblance to Hero of Lockinge, but distinctly richer in flavour than fruits of that variety, with which it was tested, and the Judges marked their approval of it by granting it a certificate of merit. A similar award was made to a new Cucumber—Beckett's Victory, the result of a cross between Victory of Manchester and Model. The fruits were 19 inches long, slender, dark green with a thick bloom, slightly ribbed, and carried their flowers. This appears to be a very superior variety, and was exhibited by Mr. Beckett, Sandown House, who also staged one of the finest collections of six dishes of vegetables we have ever seen—Telegraph Peas, Woodstock Kidney Potatoes, Nantes Carrots, White Naples Onions, Canadian Wonder Beans, and Excelsior Tomatoes, all of the first order of merit. Mr. Hill also staged admirable produce, as did Messrs. Millican and Sutton, those cultivators having the remaining prizes; and Mr. Millican was highly commended for a group of skeletonised leaves, the best and most artistically arranged we have yet seen as the production of a gardener. The exhibitor was, we believe, a pupil of the late Mr. Robert Fish, and presumably learned the virtues of patience and perseverance from that fine gardener and great teacher of practical horticulture. A number of Excelsior lawn-mowers were on the ground, recommending themselves by the excellence of their work. Such is an outline of a suburban district show, and the Committee of the Chertsey Society are to be congratulated on the results of their labours.



IN consequence of the lateness of the season the CARDIFF ROSE SHOW has been postponed for a week—namely, from June 27th to July 4th.

— AT a General Meeting of the ROYAL HORTICULTURAL SOCIETY, held last Tuesday, James McIntosh, Esq., in the chair, the following candidates were unanimously elected Fellows—viz., Colonel Lovibond, Alexander Macmillan, Alfred Hutchison Smee, W. Taylor.

— WE remind our readers that the NATIONAL ROSE SOCIETY'S EXHIBITION will be held in the Royal Horticultural Gardens, South Kensington, on Tuesday next, July 3rd, and the entries are very numerous. Messrs. J. Carter & Co.'s prizes for new Peas will be offered on the same occasion.

— FROM reports received from some of the villages around Sittingbourne it appears that last Monday's THUNDERSTORMS did great damage, chiefly caused by the hail, the stones being as large as Walnuts, cutting Potatoes and Hop plants severely, and injuring the young Wurtzel plants, beating down the corn and stripping the fruit trees, and a Rose-grower had the whole of his stock swept away.

— ALMOST every week we receive PACKAGES OF CUT FLOWERS without any letter accompanying them, and without receiving any note in reference to them through the post. Last week a box of very fine Pansies reached us, also a white Stock, some Roses, and a parcel of Ferns. We mention this in order that the senders may know that the fault is not entirely our own if the flowers are not acknowledged or mentioned in any way in our columns.

— THE Society of Arts' Albert medal for "distinguished merit for promoting arts, manufactures, or commerce" has been awarded to Sir Joseph Hooker for the present year for the eminent services which, as a botanist and scientific traveller and as Director of the National Botanic Department, he has rendered to the arts, manufactures, and commerce by promoting an accurate knowledge of the flora and economic vegetable products of the several colonies and dependencies of the Empire.

— MR. J. CLARKE writes from Brynkinault, North Wales:—

"I am sorry to say the POTATO DISEASE has put in an appearance in this part of the country. It has shown itself in the first earlies, such as Veitch's Improved Ashleaf, also Myatt's Prolific Ashleaf. I noticed it in the last-named a fortnight ago. The generality of Potatoes are looking exceedingly well."

— PROBABLY the finest specimen of VANDA TERES VAR. ANDERSONI in cultivation is now flowering in one of the Orchid houses at Wood Lawn, Didsbury, Manchester, the residence of J. Broome, Esq. This plant is of globular form, about 4 feet high and as much in diameter, and it has borne over 250 spikes, some of the spikes having six flowers each. Although a large number of these have been removed the plant still appears a mass of flowers, and has a grand effect on a stage at one end of the house. It is an imported plant, purchased about twelve months since, and said to be one of those obtained by the late Mr. Freeman. The growth has been surprisingly vigorous, and the remarkable number of flowers proves how floriferous this variety is when well treated.

— SOME very fine Strawberries were exhibited at the Walton Show by Mr. Thomas Sharpe from his STRAWBERRY GARDENS AT KNOWLE HILL, CHERTSEY. The fruit is there grown for sale, and a system of disposing of it is not generally practised—namely, the public are admitted to the beds (2 acres in extent) and allowed to gather and eat the fruit at 6d. each person. We may add that Knowle is a mile from the Virginia Water station on the London and South-Western Railway.

— THE majestic beauty of HERACLEUM GIGANTEUM is unrivalled by any of its numerous relatives, and when plants occupy suitable positions their effect is unique. Often we have admired this plant in the London parks and subtropical gardens, but we have never been so impressed by its appearance as when viewing a large clump from the old walls of Chester. Its grand Acanthus-like leaves and massive umbels of flowers could be then seen to the best advantage, and afforded convincing evidence of its utility in conspicuous positions. In the Grosvenor Park of the same city several good clumps are notable, but it is there known as *H. ponticum*, under which name Mr. Siddall informs us it was originally received from the Liverpool Botanic Gardens.

— THE practice of CUTTING DOWN CHRYSANTHEMUMS at this period of the year, although not general, is practised by some of the best cultivators whose object is the production of the finest exhibition blooms on moderately dwarf plants. The plants, from 2 to 3 feet high and hitherto untopped, are cut down within from 6 inches to a foot, according to judgment, of the surface of the pots, and the growths that issue are allowed to produce blooms from crown buds. If the plants were not cut down the crown buds of some varieties would be too early, and, besides the plants being taller, several of the blooms would have to be taken from terminal buds, and thus be smaller if more compact. All the late varieties that it is intended to have dwarf should be cut down at once; the earlier sorts in the course of a week. As soon as the plants break—and they break quickly—they are shifted into the pots in which they are intended to flower. Cultivators who have not adopted this practice may well try the experiment on a few plants. We have seen excellent results from it, and, if we mistake not, many if not most of the blooms with which Mr. Harding won the great trophy at the Kingston contest last year were from plants that had been cut down in the manner indicated.

— A CORRESPONDENT writes:—"The fruit crops AROUND HAWKHURST, KENT, are on the whole very promising. The one great failure there, as elsewhere, is Plums, the choicer varieties being almost without a fruit. Small fruits of all kinds are

heavily laden, Strawberries in particular being very good. Of Pears the highly prized Marie Louise is scarce, neither is Williams' Bon Chrétien and Glou Morceau so plentiful as one would wish. Strange to say, these three varieties are also lightly cropped in districts widely remote from Kent. Such varieties as Louise Bonne of Jersey, Fondante d'Automne, Duchesse d'Angoulême, the superior Pitmaston Duchess, Easter Beurré, Beurré Rance, Crassanne, Beurré d'Amanlis, Beurré Clairgeau, and Van Mons Leon le Clerc are all carrying good crops, and appear to be very popular."

— PEACHES, in spite of several successive bad seasons, are still cultivated extensively on the open walls in Kent, and in some instances with good success. It is very rarely that the PEACHES IN THE GARDEN OF THE REV. CANON JEFFREYS fail to perfect valuable crops of fruit. Last season they were very good, and there is every prospect of an average crop being secured this season. Old half-dead trees are not relied on, but one or two young trees are planted every year, and these, in addition to being sufficiently vigorous, are rooted and encouraged by mulchings and a clear space. Under these conditions a healthy root-action is maintained, and without which the proper ripening of the wood cannot be reasonably anticipated. Peach houses or cases, although highly serviceable where there is a good water supply, are not absolutely necessary in Peach and Nectarine culture, and proprietors of gardens and gardeners should not too readily give up open air culture. No particular varieties of Peaches are considered indispensable. For instance, the presumably delicate Noblesse perfects excellent crops, Barrington is usually very fine, and Princess of Wales proves profitable. Royal George, although there, as everywhere else, is very liable to mildew, is grown, and has been for many years, on account of its very superior quality; while for the earliest crops the small but highly coloured Early Alfred bears well, and is of excellent quality.

— MR. SIDDALL of Chester informs us that at Pendyffryn, about a mile and a half from Penmaenmawr station, is a fine old mansion, the residence of W. Smith, Esq. In the conservatory attached to this is a grand plant—one of the finest in the country—of *Cereus grandiflorus*, the Night-flowering Cactus, the flowers of which are about 6 inches in diameter. From sixty to eighty flowers open every night and fade in the morning. The plant, we understand, covers the entire wall of a large house, and the effect must be surprisingly fine.

— MR. HARDING, Orton Longueville Gardens, writes to us:—"I send you some flowers of ORCHIS MACULATA that I have taken out of a wood. You will see there are various shades of colour in this species. I intend planting it for supplying flowers for cutting, as it bears transplanting well. Although naturally it grows in the shade in woods in rather a heavy soil, some plants of it that I have planted on the open rockery in a lighter soil and in the full sun have come very much finer. The best time for transplanting is just as growth commences in the spring." The flowers are varied and beautiful, and this plant is admirably worthy of cultivation in gardens. When grown as Mr. Harding grows it in the Marchioness of Huntly's Garden, it astonishes by its vigour and is an object of interest and beauty.

— AT the annual meeting of the SCOTTISH PANSY SOCIETY recently held at Edinburgh Mr. McComb and Mr. Miller of Leek, Staffordshire, brought up the question of exhibitors failing to attach the names of the individual blooms to stands of Pansies as a direct infringement of the rules. The question was warmly debated, but finally the question was left an open one. The practice of showing produce without names is very prevalent in Scotland, and without a doubt detracts very sensibly from the

enjoyment of visitors, who like to know what they are looking at. The Pansy Society might have done better.

— MR. DOWNIE told the history of the beginning of the Society. About forty years ago some growers in the Glasgow district sent a challenge to the men of the "cast countrie" to meet them with their Pansies. Mr. Downie and other two gentlemen met at Falkirk, talked the matter over, and agreed to start a Pansy Society. The first Exhibition was held in Falkirk, and the thirty-ninth had been held that day in the Waverley Market.

— AT the dinner in connection with the above SOCIETY, Mr. Ross, Laurencekirk, replying to a vote of thanks to the Judges, spoke of the high quality attained by Fancy Pansies, as demonstrated by those shown in the Waverley Market that day. When he first got them he thought so slightly of their qualities as to throw the entire lot out, and for years he had disliked them; but now they were quite as good in all qualities as the English (Show) Pansy, and eclipsed them in size of bloom, richness, and variety of colouring. It may be stated that the Fancy Pansy is of Belgian origin, and was taken in hand first of all by Mr. Downie.

— MR. WARE of Tottenham has sent us a beautiful bouquet of GARDEN PINKS, consisting of Lord Lyons, rich rose, very useful; Snowdon, broad petals, smooth, pure; Ware's Clove Pink, deep rose, serrated petals, free, fragrant, should be in every garden; Ascot, lavender, dark blotch, useful; Mrs. Sinkins, very large broad petals, slightly serrated, the finest white variety; Derby Day, lavender, maroon blotch, effective; Early Blush, rosy lilac, deeply fringed, distinct and pretty; Device, white, distinct dark central blotch and coloured margin, telling; Volunteer, blush white, with deep maroon blotch, extending to the edge of the petals, a fine striking variety; and Fimbriata major, white, deeply serrated, giving it a feathery appearance, very chaste. There are no more attractive border flowers than these at this season of the year.

— WE are asked to state that the glass structures in the gardens of Mr. McIntosh at Duneevan, mentioned in our "Notes and Gleanings" last week, were erected by Mr. James Gray, Horticultural Builder, Danvers Street, Chelsea, S.W. They consist of a range of lean-to vineries, Peach house, and Lily house, and a range of half-span forcing houses. We think we have stated this before, and can now add that the whole are in excellent condition, and as sound and good as when first erected, five or six years ago.

— IN answer to a correspondent who has asked what is the best OLD OR LAST YEAR'S POTATO in use now, "L.A.K." writes:—"From my own experience and what I hear from different parts of England the Magnum Bonum is the one most used where obtainable."

— VERY attractive just now are the varieties of LUPINUS POLYPHYLLUS, and amongst other hardy plants in beds and borders they are very striking. Their long cylindrical and tapering spikes of blue, purple, rosy, and white flowers tower above the majority of occupants of such positions, and serve to relieve the slightly too-flat appearance often characterising borders of herbaceous plants.

— MR. GILBERT, Burghley, writes on PROPAGATING BEDDING PLANTS:—"What your esteemed correspondent, Mr. W. Taylor, says on page 489 about my remark to Mr. Barron is perfectly true. Since those happy days at dear old Chiswick I have seen numbers of propagators, but I never met William Taylor's match. This is not all; he could grow the plants afterwards. The great majority of Verbenas, for instance, we meet are simply little sparrow quills with a few leaves on each side; but friend Taylor's were all dwarf bushy specimens, cover-

ing the pots with healthy foliage." An opinion is somewhat widely entertained that Verbenas have degenerated, and cannot be well grown now-a-days; but Mr. Taylor has every year beds at Longleat as fine as any that were produced in the palmy days of this flower.

— A NOBLE plant for the subtropical garden or in any prominent position is POLYGONUM SACHALIENSE, one of the largest-growing forms of the genus, and has an imposing effect. The stems are stout, 12 to 14 feet high, the leaves shield-like in form, about a foot long by 9 or 10 inches broad, and thickly clothe the stems from the base to the top. A vigorous specimen 3 or 4 yards in diameter is now very notable in the herbaceous grounds at Kew, where also the better known and similarly useful *P. cuspidatum* is represented by fine clumps.

— IN striking contrast to the above is the dwarf POLYGONUM ALPINUM, which does not exceed 3 feet in height, and is of straggling habit, but becomes covered with feathery clusters of white flowers, which are fragrant and somewhat suggestive of Sweet Scabious. The extreme floriferousness of the plant is very notable, and for trailing over rockeries it is invaluable.

— AT a recent meeting of the York Students' Association, an interesting lecture on "INSECTIVOROUS PLANTS" was delivered by Mr. Philip MacMahon, Curator of the Botanic Gardens, Hull. Dr. Anderson presided. In his discourse Mr. MacMahon showed that the researches of Darwin and other scientists had dissipated the generally accepted doctrine that vegetables were made for the support of the animal creation, and that animals invariably fed upon vegetables. He lucidly explained the structure and *modus operandi* of the various carnivorous plants which had come under observation, and pointed out the variety which existed in their construction. The *Dionæa muscipula* was formed as a trap, whilst the *Drosera* by its tentacles conveyed the insects down to its centre. The *Pinguicula*, which curls its leaf when an insect alights on it, was contrasted with the *Sarracenia*, and the various "pitcher plants" that are also believed to consume insects were described. At the conclusion of the lecture a hearty vote of thanks was accorded on the motion of the Chairman, seconded by Mr. Gough, B.Sc., to Mr. MacMahon.

— AN excellent fruit-grower sends us the following note on MULCHING FRUIT TREES:—"Mulching with manure such fruit trees as Apples, Pears, Plums, Peaches, &c., will be very beneficial this season; and the present is the best time to apply it, as the fruit is now swelling. After a good rain is the best time to mulch. Some gardeners recommend watering the trees first. We could never find time for that; but by mulching them before the ground was dry we always managed to have good fruit. Pears on the Quince stock and Apples on the Paradise are very much benefited by a summer mulching, and the fruit attains a large size."

— THE same gardener also writes on DESTROYING THE BLACK FLY:—"Many gardeners find a difficulty in extirpating this pest, and as 'a stitch in time saves nine' it is as well to be on the alert. On the first appearance of the insects give the trees a thorough syringing in the evening with the following: 1 quart of tobacco water to 4 gallons of warm water at a temperature of 130°, and on the following morning syringe with clear water. We always found this effectual, but the tobacco water was of the best quality, some being weak and inferior."

— MESSRS. JAMES CARTER & CO. have sent for our inspection some blooms of their International Prize Pansies, from which their stock of seed is this year to be produced. They are very large indeed, bright and varied in colour, while some of them are remarkable for their chaste pencillings, which imparts to them a novel appearance.

— A CORRESPONDENT of "Vick's Illustrated Magazine" gives the following account of PLANTS IN NEW ZEALAND:—"Many of the double Gilies grow here to the height of 4 feet 6 inches, and you may fancy what a thicket of them I had, having planted them according to height in catalogue; the single ones were from 1 foot to 18 inches high. The double Clarkias and Godetias make the grandest show I ever saw: there are some of both of these plants which grow in tree form that are nearly 5 feet high. The tall double Scabiosa grows 5 feet 6 inches in height. Snapdragon, which in Canada grew about 18 inches high, grows here in the third year from planting 5 feet 2 inches, and reached the same in circumference. One year after sowing a plant of Verbena covered a space of 5 feet; what length it would have reached I cannot say, as I cut it back to keep it off the garden walk. I have Mignonette, the seed of which was sown last November, and one plant of it covers a space of over 3 feet. On the other hand, there are several flowers that do not do so well, notably the Zinnia and Balsam. The Zinnia gives very few double flowers, and will not stand transplanting. The Balsam gives few flowers, and those very weak. The Snowball and Lilacs do miserably, but Roses here go far beyond anything I ever saw in America, and are of the easiest possible culture."

— THE *American Cultivator* states that "Every spring PEACH-GROWERS select specimen branches from variously situated trees, and these are placed in hothouses and their ends dipped in water that is kept tepid. Then the buds are forced until an expert can tell, with the aid of a microscope, precisely what the nature of the coming crop will be. From these and other recognised indications it is thought that the yield this year will be of average bulk and of the finest flavour." This "finest flavour" prognostic as determined by the microscope, we think rather clever.

— THE closing meeting of the METEOROLOGICAL SOCIETY of the present session was held on Wednesday evening, the 20th inst., at the Institution of Civil Engineers, Mr. J. K. Laughton, M.A., F.R.A.S., President, in the chair, when the following papers were read:—1, "On the Structure of the Ice-cloud Disposed in Threads, proposed to be called Cirro-filum," by the Rev. W. Clement Ley, M.A., F.M.S. Of the cirriform clouds one of the most important to the weather forecaster is that to which the author has given the name cirro-filum. Having from the time he was twelve years of age carefully studied this cloud whenever visible, and having for the last twenty-five years made it the subject of minute study, he is enabled to bring forward some results which may prove of value. The author then gave, first, a short account of the mode in which he was led to prosecute this study; secondly, a classification of the more recent and reliable observations; and, lastly, an explanation of the principal phenomena observed. 2, "Notes on a Second Series of Experiments on the Distribution of Pressure upon Flat Surfaces Perpendicularly Exposed to the Wind," by Richard H. Curtis, F.M.S. The results obtained in these experiments agree very closely with those of the former experiments. 3, "On the Reduction of Wind Records," by the Hon. Ralph Abercromby, F.M.S. The author discussed the significance and best method of deducing from anemographic records the total quantity, the quantity from different points of the compass, the relative frequency, the mean and annual velocity, the mean velocity from different quarters, the resultant, and the mean and diurnal direction of the wind. 4, "The Spectroscope as an Aid to Forecasting Weather," by F. W. Cory, M.R.C.S., F.M.S. 5, "Note on River Temperatures as Compared with Air Temperatures at Greenwich and Bremen," by Robert H. Scott, M.A., F.R.S. The author compared the results given in a recent paper by Sir G. B. Airy on a comparison between the records of the temperature of the Thames and those

of air temperature taken at Greenwich with those published by Herr von Freenen for the temperature of the Weser, as compared with that of the air near Bremen, for the ten years 1858-67.

AMERICAN WONDER PEA.

AS the season of Peas is come round again, perhaps a few words on the above variety will not be out of place here, and may be of service to a few persons who have not grown it. I think it is the most useful Pea I have ever grown, and this year it has been particularly satisfactory both as regards quantity and quality and the time of producing. Sown here ten days later than Suttons' Ringleader, pods were fit to gather just a week before Ringleader, and they are a full fortnight before Suttons' Little Gem, which I consider a very useful Pea. The aspect in all three cases are the same, only that the Wonder has the least manure and the rows are 2 feet apart, whereas the others are 4 feet, and at the least there is double the quantity of the Wonder on the same space of ground as the best of the other two, which is Little Gem. They are as near as possible 1 foot high, and average from eight to twelve pods on a plant, and six to eight peas in a pod. When it is better known I think it will find a prominent place in every garden. Sown here in an unheated Peach case on 9th of February, I gathered from them on May 31st, but the crop was not so heavy as it was outside. I think Messrs. Sutton are to be congratulated on the production of this Pea.—J. SMITH, *Surrey*.

THE PROPOSED SCOTTISH AURICULA SOCIETY.

WITH regard to your note concerning the initiation of an Auricula Society for Scotland I have no doubt that it could easily be attained. The number of growers is increasing year by year, and several I know have collections of a few hundred plants. A society to bring growers together in friendly rivalry is just what is wanted, and perhaps there is no fitter time than the present to start one. I have mentioned the matter to a few growers, and though each and all admitted the desirability of such a society, they wanted something more to induce them to take up the matter seriously. Although there are growers round the three large centres—Dundee, Glasgow, and Edinburgh, it might be difficult to maintain good working societies for each of these centres. The question then would be which centre to take. I would say Edinburgh, as its position is the most central of the three. There are in addition to the many growers round that city a very large contingent in the Merse and on both sides of the Border who naturally gravitate to Edinburgh, while Stirlingshire and Fifeshire growers are quite as near that city as the others named. I know there are many Auricula growers who are Journal readers, and I am sure the Editor would make room for the opinion of any of those who are favourable to the scheme of forming an association for the better cultivation of the Auricula in the north. Personally I think the time is ripe for such an association, and I shall be glad to support it if formed.—R. P. BROTHERSTON.

[Another letter on this subject arrived too late for insertion; it will be published next week.]

GARDEN VIEW IN MADEIRA—QUINTA ST. ANNA.

FEW places are more favourably situated for the growth of flowers, fruits, and vegetables than the small Island of Madeira, situated in the Atlantic Ocean, on the north-western coast of Africa. The area of the island is considerably less than 400 miles. It is one huge basaltic rock, the highest point reaching an elevation of upwards of 6000 feet above the sea level. The mountainous sides of the island are traversed by narrow valleys and streams of water. The sheltered valleys abound with vineyards and gardens. The climate is mild and equable, the mean temperature being about 68°. These conditions are highly favourable to the health of residents and visitors, and the place has been a health resort for centuries. The island has one drawback in the hurricanes of wind which at times pass over it. The capital town is Funchal, from which all the exports of fruit, &c., are made. This town is constantly visited by steamers bound for South Africa, South America, the West Indies, and other places, and the environs of the town are studded with mansions and villas frequently clad with Bougainvilleas. Our illustration, Quinta St. Anna, is a typical view of a house and garden belonging to this rocky island. In such gardens the Hibiscus, Pelargonium, Heliotrope, Plumbago, Brugmansia, Bignonia, and various succulent plants, as Mesembryanthemums, Cacti, and Euphorbias, grow

without protection. The Banana and Date Palm are cultivated with Maize, Batatas, Coffee, Camphor, Olives, Figs, Pomegranates, and numerous other roots and fruits. Amongst flowers the Bougainvillea, Thunbergia, and the orange-flowered Bignonia venusta are amongst the most remarkable. Cannas, Ipomæas, Lantanas, Abutilons, and Poinsettias abound in all the gardens, whilst the Hyacinth, Belladonna Lily, and Agapanthus are to be seen in every direction. Woodwardia radicans grows in the more moist and shady places. The Pelargonium from its luxuriance of growth and its brilliantly coloured flowers is one of the most noteworthy plants of the island. Camellias and Roses also grow in great profusion and perfection. Amongst notable trees are Magnolias, Salisurias, Dragon Trees, Araucarias, Allspice, Locust, Jacaranda, and Clethra arborea. Amongst Grasses giant specimens of the Bamboo. Besides the fruits we have already mentioned the Loquat grows to great perfection, the fruits of the edible Passion Flower, various Grapes, the Avocado Pear, Custard Apple, and Mango. Most of our best known garden vegetables

grow admirably during the cooler months of the year, together with the Yam (*Caladium esculentum*).

WORCESTERSHIRE AGRICULTURAL AND HORTICULTURAL EXHIBITION.

JUNE 19TH, 20TH, AND 21ST.

THE Worcestershire Horticultural Exhibition was held in connection with the Agricultural Show this year in the show ground, Battenhall, Worcester, on June 19th and two following days. The two Shows combined are conducted on much the same principle as the Bath and West of England, and are held in a different part of the county each year. On the opening day the weather was all that could be desired, a number of visitors assembling. Unfortunately the two last days were anything but favourable, with heavy showers at intervals. In the agricultural department the attractions were somewhat limited, but the horticultural section was well represented, and in most of the classes the competition was keen and spirited.] [The

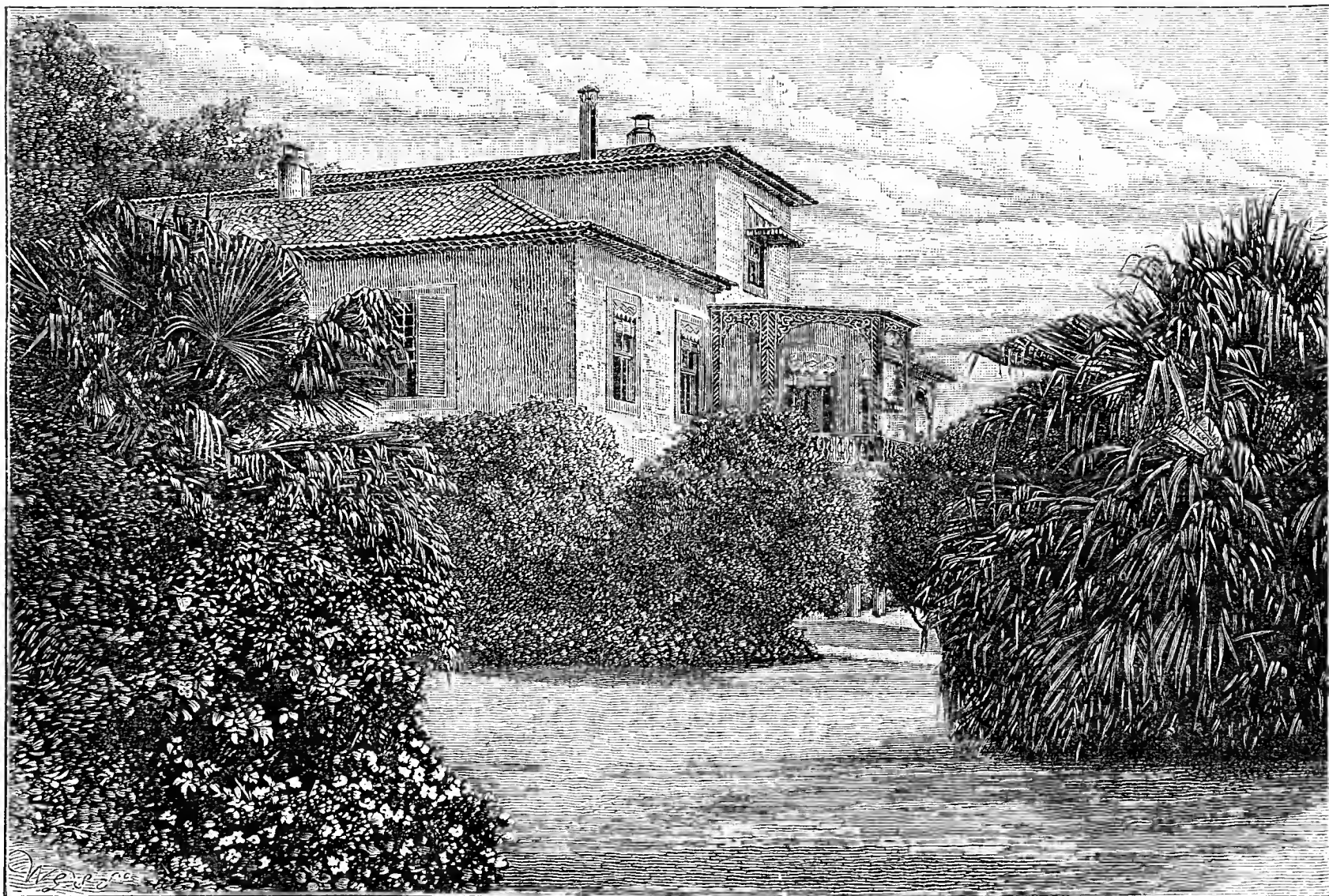

Fig. 120.—GARDEN VIEW IN MADEIRA—QUINTA ST. ANNA.

exhibits were shown in three large tents, most of the space being well occupied.

STOVE AND GREENHOUSE PLANTS.

For the premier prize of £20 for ten stove and greenhouse plants in bloom and six ornamental foliage plants arranged for effect Mr. James Cypher, Cheltenham, secured first honours. His plants consisted of a large *Latania borbonica* occupying the centre of the group; on the left was a good *Cycas circinalis*, to the right was a handsome plant of *Encephalartos villosus*, a good *Cycas revoluta*, *Croton majesticus*, about 6 feet high and nearly as far through, well coloured, and *C. Queen Victoria*, also well coloured. The flowering plants were perfect, including his well-known plant of *Erica Cavendishiana* laden with its bright yellow flowers, a good example of *Dracophyllum gracile*, *Hedera tulipifera* well flowered, a large plant of *Azalea Brilliant*, *Allamanda Hendersonii*, *Clerodendron Balfourianum*, *Stephanotis floribunda*, *Ixora coccinea* and *I. Williamsi*, and a well-flowered *Erica Aitoniana*. Mr. Tudgey, Waltham Cross, was a good second; his foliage plants comprised *Latania borbonica*, *Pritchardia pacifica*, *Stevensonia grandifolia*, *Cycas circinalis*, and a splendid plant of *C. revoluta*. Amongst the flowering plants were fine plants of *Azalea*

Criterion, *Ixora Williamsi*, *I. Fraserii*, a monstrous *Azalea magnifica*, *Erica Cavendishiana*, a perfect plant of *E. ventricosa magnifica*, *Clerodendron Balfourianum*, *Dracophyllum gracile*, *Anthurium Schertzerianum*, and *Hedera tulipifera*. The third prize was taken by Mr. J. F. Mould, nurseryman, Pewsey, Wilts, with much smaller but well-grown plants. The six foliage plants included *Cycas revoluta*, *Phormium Vcitchii variegatum*, *Croton Queen Victoria*, *C. Prince of Wales*, *C. majesticus*, and a very healthy plant of *Gleichenia rupestris*. Amongst the flowering subjects was a good well-flowered plant of *Statice profusa*, *Erica insignis*, and *Ixora regina*. An extra prize was awarded to Mr. Plevy, gardener to E. J. Morton, Esq. For six stove and greenhouse plants in bloom Mr. James Cypher was again to the front with good plants of *Erica Cavendishiana*, *Dracophyllum gracile*, *Ixora Fraseri*, *Azalea Brilliant*, *Allamanda nobilis*, and a good *Aphelaxis macrantha purpurea*; Mr. Tudgey taking second honours with handsome well-flowered plants, but smaller than the first. Third Mr. J. F. Mould.

FINE-FOLIAGE PLANTS.

For twelve ornamental foliage plants arranged for effect Mr. Cypher was far ahead of the other competitors, his chief exhibits

being a very large *Areca lutescens*, *Verschaffeltia splendida*, *Seaforthia elegans*, *Croton Disraeli*, and *C. Sunset*, both well coloured. Mr. Tudgey was second with much smaller plants, and lacking the brightness of colour which was so prominent in Mr. Cypher's group, the chief plants in this group being *Dicksonia antarctica*, *Geonoma gracilis*, and *Cocos Weddelliana*. Mr. Plevy was third, the plants being small compared with both the previous groups, but still were healthy and very creditably grown. An extra prize was awarded to Mr. J. F. Mould. In the class for six ornamental foliage plants grouped for effect Mr. Cypher was again first with plants of *Pritchardia pacifica*, *Croton Queen Victoria*, *Cordyline indivisa*, *Cycas revoluta*, *Kentia Fosteriana*, and *Dasyliroton acrotrichum*; Mr. Tudgey taking second honours, and Mr. Plevy third. In Mr. Tudgey's group *Croton Andreanum* figured conspicuously, being remarkable for the size and high colour of the foliage. For one ornamental foliaged plant Mr. Cypher was again at the head of the list with a splendid plant of *Cordyline indivisa*; Mr. Plevy second with *Cocos Weddelliana*; and Mr. Lott, gardener to E. Humphries, Esq., third with *Latania borbonica*.

The class for a specimen stove or greenhouse plant in bloom brought three competitors. Mr. Vicarage, gardener to Mrs. Allies, was first with a good-sized plant and moderately well bloomed of *Dipladenia Brearleyana*. Mr. Cypher was second, his plant being *Dracophyllum gracile*. Mr. Tudgey third, with *Aphelexis macrantha floribunda*.

GROUPS.

In the class for miscellaneous plants grouped for effect, to occupy a space of 200 square feet, five competitors entered, this class being one of the great attractions to visitors; Mr. Cypher and Mr. Cowan, gardener to H. Walker, Esq., Purdeswell, Worcester, dividing first and second honours. Both groups deserve a word of praise, Mr. Cypher's evidently being the strongest in flowering plants, Mr. Cowan's in foliage. Third Mr. Hellman, gardener to H. Bramwell, Esq., Crown East Court, Worcester. In the class for a group occupying 100 square feet Mr. Vicarage was first with a very tastefully arranged group, second and third falling to Mr. Lawley, gardener to T. C. Quarrell, Esq., and Mr. Plevy respectively.

Fuchsias.—For three varieties Mr. Lawley secured the first prize very easily with three splendid plants between 7 and 8 feet high, well furnished, and densely flowered; the varieties being *Bacchus*, *Venus de Medici*, and *Rose of Castile*. Mr. Thomas, gardener to John Corbett, Esq., M.P., was second, and Mr. Norman, gardener to A. W. Knott, Esq., third.

Ferns.—In the class for six Ferns and Mosses Mr. Cypher was once more to the front, staging a first-rate half-dozen, including a good *Dicksonia antarctica*, *Cybotium regale*, a splendid plant of *Neopteris Nidus*, a good *Gleichenia Mendelli*, *G. flabellata*, and *Selaginella umbrosa*. Mr. Jones, gardener to Col. Middlemore, was second with much smaller plants. Mr. Cypher was first for a specimen Fern with a nice plant of *Alsophila elegantissima*.

Pelargoniums.—For six *Pelargoniums*, Show or Fancy, Mr. Cypher took the lead with a well-grown half dozen, Mr. Lawley being second. Mr. Cypher and Mr. Lawley were first and second respectively for three plants. In the class for six Zonal *Pelargoniums* Mr. Lawley was the only exhibitor, with very large and well-flowered plants. Two of the plants each measured between 4 and 5 feet in diameter.

Heaths were admirably shown by Mr. Cypher and Mr. Tudgey, who were first and second in the order named. Mr. Cypher's plants comprised the following varieties:—*Erica tricolor elegans*, *E. ventricosa magnifica*, *E. ventricosa superba*, *E. v. Bothwelliana*, *E. depressa*, and *E. Cavendishiana*. Mr. Tudgey's best plants were *E. ventricosa magnifica* and *E. v. superba*.

British Ferns were well represented, two classes being provided—one for twenty-four, the other for twelve; in the class for twenty-four Mr. J. H. White, Worcester, being the only exhibitor. For twelve varieties Mr. Vicarage was first with a magnificent collection, the plants being large, clean, and well grown. Mr. J. H. White was second with very good plants; and A. W. Knott, Esq., third with much smaller examples. Classes were provided for *Gloxinias*, *Tuberous Begonias*, and *Caladiums*; but in none of the three classes was anything very striking exhibited.

Orchids.—Only one class was provided for Orchids—viz., six varieties, Mr. Cypher being first and second, the chief plants being *Cypripedium villosum*, *C. Lowii*, *Epidendrum vitellinum*, and *Odontoglossum vexillarium*, single plant with ten spikes of flowers. Vases of cut flowers for dinner table, bouquets for bride and ballroom, funeral crosses and wreaths, were fairly represented and greatly admired.

Roses were well shown. Three classes were provided—viz., for thirty-six, twenty-four, and twelve. For thirty-six distinct varieties Messrs. Cranston & Co. were first with even bright blooms; Mr. Drew, gardener to Mr. W. J. Grant, second. For twenty-four distinct Messrs. Cranston were again first; Mr. J. Walker, Thame, second; and Mr. J. Lewis, third. Twelve distinct, Mr. Ennis, gardener to the Rev. F. S. Taylor, first, Mr. J. W. Grant second, and Cranston & Co. third.

FRUIT.

For a collection of six dishes (Pines excluded) there were only two entries. Mr. Barker, Hindlip, was well to the front, staging some magnificent Black Hamburg Grapes, the berries large and well finished; Duke of Buccleuch, berries large but scarcely ripe; a beautifully netted William Tillery Melon, Stanwick Elruge Nectarines,

magnificent Royal George Peaches, and Brown Turkey Figs. Mr. H. Gough, Worcester, was a very fair second with Black Hamburg and Golden Champion Grapes, Queen Emma Melon, Pitmaston Orange Nectarine, Grosse Mignonne Peach, and President Strawberry.

Pine Apples.—Mr. Barker was first with two grand Queens, crowns small, but perfect in other respects; Mr. Hellman, Crown East Court, was second with smaller fruits. For a single specimen Mr. Barker was again first with a magnificent Queen, Mr. Hellman second.

Black Grapes (Hamburg).—Mr. Barker took the lead with good bunches, large berries, and perfection in finish; second Mr. Gough, also with good bunches; Mr. W. H. Jones was third. Black Grapes (any other sort).—Mr. Barker won chief honours with well-finished bunches of Madresfield Court; Mr. Gough followed, and Mr. Hellman was third with Kempsey Alicante, the berries large but not ripe. In the white Grape classes the principal prizetakers were Messrs. H. Gough, Thomas, and Barker.

Mr. Barker was the principal exhibitor of Peaches, being well in front of the other exhibitors with Royal George; Mr. Cowan second, and Mr. Thomas third. For a dish of six Nectarines only two exhibitors appeared, Mr. Barker again coming to the front with Stanwick Elruge, the fruits large, and in colour almost approaching black.

For a dish of nine Figs Mr. Barker was the only exhibitor, staging a capital dish of Brown Turkey. Melons (green or white flesh).—In the two classes provided for Melons several good fruits were exhibited. In the above-named class Mr. Little, gardener to J. F. G. Williams, Esq., Henwick Grange, was first with a splendid fruit of Hero of Locking; Mr. Barker second with a hybrid of rather peculiar shape; Mr. Thomas third with a good fruit of Davenham Early Melon. For scarlet-flesh Melons Mr. Barker was first with Blenheim Orange, Mr. Cowan second with a good fruit of Scarlet Premier, Mr. Styles third with a well-netted fruit. A class was provided for largest Gooseberries and largest Strawberries, also one for best-flavoured Strawberries. Of the latter Mr. Barker came in first with good fruits of President, Mr. Thomas with fine fruits of Sir C. Napier, and Mr. G. M. Stratton third with Stirling Castle.

VEGETABLES.

Collection of Six Dishes.—In this class four competitors entered, the first prize being awarded to Mr. Gough, who staged William the First Pea, Dean's Snowball Cauliflower, Green Globe Artichokes, Large Red Tomatoes, Mona's Pride Potatoes, and Canadian Wonder Beans. Mr. J. C. Reed, Great Malvern, was second, and Mr. Barker third. An extra prize was awarded to Mr. Hellman, Crown East. Cauliflowers, Turnips, Potatoes, Carrots, Onions, Beans, Peas, Tomatoes, and Cucumbers were very creditably shown. A basket of salad was shown by Mr. Hellman and Mr. J. C. Reed, the former of which was full and fairly well arranged, the latter being much too flat to set the exhibits off to advantage.

Miscellaneous.—Mr. J. S. Heywood, nurseryman, Worcester, staged a very creditable group of plants, adding much to the attraction of the Show, their chief plants including *Dracenas*, Ferns, Pandanus, and flowering plants. Messrs. R. Smith & Co., nurserymen, Worcester, also staged a very effective group of plants, showing to advantage some of their fine Clematises that of late have become so popular amongst horticulturists. The latter were mostly of the Jackmanii type, purple being the predominating colour. The plants were well grown and exceedingly well flowered. The chief varieties were *C. rubella*, Thomas Moore, Alexandra, Madame Thibaut, Magnifica, Star of India, Victoria, Lady Boville, and Mrs. J. Bateman. Several varieties of Japanese Maples were also staged in the group, greatly adding beauty to the general effect, together with splendid standard and dwarf *Euonymuses*, *Araucarias*, Palms, *Cordylines*, and flowering stove and greenhouse plants. One of the greatest attractions of the Show was a group of cut flowers of hardy herbaceous plants exhibited by the above firm. The colours were bright and varied and admirably arranged. Many of the genera were shown in collections, the grand flowers of *Pæonias*, *Pyrethrums*, *Potentilla*, and *Irises* being greatly admired. Many others were well shown, including *Papavers*, *Thalictrum*, *Dictamnus*, *Rheums*, *Erigerons*, *Liliums*, *Lychnis*, *Delphiniums*, *Muscari*, *Digitalis*, *Spiræa*, *Campanula*, *Baptistia*, *Echium*, *Carduus*, *Hemerocallus*, *Tritoma*, *Centaurea*, *Ixia*, *Centranthus*, *Alliums*, *Hieraciums*, *Brodiaea*, *Gaillardia*, and hardy Orchids, including *Cypripedium spectabile*, bearing very large and richly coloured flowers. Mr. Barker exhibited two bunches of Lady Downe's Grapes that were ripe in September of last year. Some of the berries, however, were slightly shrivelled, others were plump and good with a beautiful bloom, and pronounced by the Judges to be excellent in flavour.

SCOTTISH PANSY SOCIETY.

THE thirty-ninth annual Exhibition of the above Society was held in the Waverley Market, Edinburgh, on the 22nd inst., when a much larger number of exhibitors staged blooms than at any other show held by the Society. In quality the flowers surpassed any that have been seen for at least the last five years—perhaps the best, on the whole, that have ever been brought together. There were in all ninety-one classes in which prizes were offered. Of these we will note some of the more important. In the classes set apart for nurserymen the twenty-four Show and twenty-four Fancy Pansies respectively were the chief competitions. For twenty-four Show

Pansies eight competing lots were staged; the whole of these were generally good. Mr. J. Sutherland, Lenzie, took first place with a lot as remarkable for the size of blooms as for quality and purity of marking. For twenty-four Fancy Pansies nine lots were staged, and the running was so close in these that the greatest difficulty was experienced in making the awards. Mr. Sutherland, Lenzie, was first. Names of these were not attached, and although we might name many of them, the likeness is so close in many sorts that we do not run the risk of making a mistake. Messrs. R. B. Laird & Son were second, very closely following the first; and Messrs. Paul & Son, Paisley, third. For twenty-four bunches of bedding Violas, Messrs. R. B. Laird & Son were first; and Messrs. Dickson & Co., Leith Walk, second. For six seedling Show Pansies, dissimilar, Messrs. Paul and Son were first, and the Dickson Company second. In the classes devoted to practical gardeners Mr. Borrowman, Beeslack, was first with eighteen distinct Show sorts with a remarkably firm and even lot. Mr. R. Stewart, Lenzie, was second also with very fine blooms; and Mr. D. Findlay, Lennox Castle, third. Mr. Borrowman was again first for twelve; while for six sorts Mr. Stewart was first. For eighteen sorts, Fancy Pansies, Mr. Borrowman took premier position with an extra clean and fine lot; Mr. Findlay being second, and Mr. McComb, Montrose, third. For twelve Fancies Mr. Borrowman was again first, while Mr. Findlay took first for six blooms.

In the amateurs' classes there was a very large and keen competition. For eighteen Show varieties Mr. Pitcher, Denny, took first honours, closely followed by Mr. Stewart, Campsie, who was second, Mr. Fleming, Berwick-on-Tweed, being third. For twelve Show blooms Mr. Ritchie was again first, Mr. Fleming second, and Mr. Dick, Kirknewton, third. For six Show varieties Mr. Ritchie was once again in the highest position, Mr. Black, East Calder, being second, and Mr. Buchanan third. The Fancy Pansies were an equally strong, or perhaps a stronger, competition than the Show section. Here Mr. Stewart held first place with a very grand lot, Mr. Ritchie, Denny, being second, and Mr. Dick third. For twelve kinds Mr. Dick was first, Mr. Stewart second, and Mr. Ritchie third; and for six sorts the two higher prizes went to the same persons, Mr. Buchanan being third. Mr. Black took a special prize for six seedling Fancies. For six Show and six Fancy Pansies Mr. Dick was first with remarkably fine blooms. For six Fancies a special prize was awarded to Mr. Dick. In the classes open to gardeners and amateurs Mr. A. Cassie, Calder Hall, was first for six Show and six Fancy distinct. In another special prize for six Show and six Fancy Mr. Fleming was first. For a special for eighteen Fancies, dissimilar, Mr. Findlay, Lennox, was first with a very fine lot, Mr. J. Armstrong, Polton, being second. For twelve Show and twelve Fancy Mr. Findlay was first with really fine and fresh blooms, Mr. Fleming, Berwick, being a close second. Several other classes of six of each variety were offered, prizes going to very much the same exhibitors. It seemed as if a large amount of money was frittered away in this matter of special prizes, which were mere repetitions. For six Fancy Pansies of one sort Mr. McComb was first with Mrs. T. McComb, a remarkably fine variety. A very large number of classes were devoted to three flowers of a given variety, the recital of which would be of no general interest.

The best white self Show Pansy in the room was M. H. Miller, from Messrs. Dickson & Co.; the best yellow self Show, Gomar, from Messrs. Paul & Son; the best blue self Show, Abbotsford, from Mr. Skinner, Penicuik; the best mauve self Show from Mr. Ormiston; the best yellow self Fancy, Miss Bliss, from Mr. Black. Other single blooms we found no means of noting. Prizes were also given for bedding Violas, and for glasses, baskets, &c., filled alone with Pansies and greenery. None of these was at all effective.

Of exhibits extra to those staged for competition Messrs. R. B. Laird & Sons showed a collection of ten dozen Fancy Pansies, every one of which was wonderfully fine. The same firm also showed a collection of sixty double Pyrethrum blooms. Messrs. Jas. Cocker and Sons, Aberdeen, staged a collection of these, some sixty-six blooms being shown. Each bloom was collared with a circular piece of white cardboard, which did not improve the appearance of the blooms. Collections of Show and Fancy Pansies were shown by Mr. John Scott, Florist, Ancrum, from Mrs. Taylor, Corstorphine; and a collection of the best Show and Fancy Pansies from Messrs. Dickson & Co., Leith Walk. Bunches of bedding Violas were also shown by the same firm, who in addition staged a quantity of large foliage plants amongst the tables. By Messrs. R. B. Laird & Sons foliage plants were also contributed.

LEEDS HORTICULTURAL SHOW.

JUNE 19TH, 20TH, AND 21ST.

FOR several years in succession the Leeds Flower Show has been held under most unfavourable circumstances as regards the weather, and the Exhibition in 1882 proving even more unsuccessful than usual, the result was that the old Society was unable this season to organise another. In this unpleasant state of affairs the shareholders of the Horticultural Gardens came forward promptly to project a show upon their own responsibility, so that the town should not lose its exhibition which has horticulturally always been creditable to the district. The efforts thus made have in some degree met with the success they so well deserved. The weather upon the opening day—Tuesday, was much finer than usual, for though dull no rain fell; the second day was not quite so favourable, but the third day was

comparatively bright and rainless. It is to be hoped that a cycle of success has thus been commenced which will again place the Exhibition on a substantial foundation as one of the best in the north of England.

Three large tents were devoted to the exhibits, the largest containing the stove and greenhouse plants and the principal groups; the two others, running at right angles from each end of the former, being occupied with the Pelargoniums, Ferns, small groups, fruit, flowers, Fuchsias, and table plants. In most of the classes the competition was fairly good, and the general quality both of plants, flowers, and fruits was very satisfactory. The arrangement adopted, too, was good, and much praise is deserved by the Secretary, Mr. Bush, who has worked very energetically to insure the success of the Show.

STOVE AND GREENHOUSE PLANTS.

Three classes were appropriated to these, that of leading importance being for twelve specimens, open to all exhibitors, in which four good collections were staged. The chief prize (£12) was won by Mr. Letts, gardener to the Earl of Zetland, Aske Hall, Richmond, Yorkshire, with large, healthy, well-grown examples of *Erica oblata*, 5 feet in diameter, extremely vigorous; *Ixora coccinea* with large handsome trusses, *Dipladenia amabilis* with numerous richly coloured flowers, *Croton Mortii* very handsome and brightly coloured, *C. majesticus* similarly good, *Statice profusa* a mass of flowers, an extremely handsome specimen. *Croton Johannis* and *Dracophyllum gracile* were also good plants, and the collection altogether well deserved its position. Mr. W. Tuke, gardener to G. Gelder, Esq., Cliff View House, Headingley, Leeds, succeeded in obtaining the second prize with good plants of *Clerodendron Balfourianum*, *Ixora floribunda*, *Dasylyrion longiflorum*, *Allamanda grandiflora*, *Ixora Fraseri*, and *Azalea Model*, all healthy and fresh. Mr. J. W. Frankland, gardener to J. Barran, Esq., M.P., Chapel-Allerton Hall, Leeds, followed closely, his best specimens being *Azalea Brilliant* and *Allamanda Schotti*, the last exceedingly well flowered. These plants were arranged on a circular stage at the end of the large tent, and the collections in the smaller class for six plants were similarly arranged upon a stage at the opposite end of the tent. The best of these were also from Mr. Letts, who gained the premier position, the most notable plant being the fine *Anthurium Schertzerianum*, for which the Veitch Memorial medal was awarded at York. Mr. Tuke was a close second with creditable specimens, *Clerodendron Balfourianum* being exceedingly handsome. In the class for three plants the specimens were mostly small.

GROUPS.

These always constitute one of the chief features of the Leeds Show, and although the entries were not quite so numerous on this occasion, the taste displayed in the arrangement generally was very striking, especially in the class for a group to occupy a space of 200 square feet, in which the chief prize was a handsome timepiece, presented by the Mayor of Leeds, E. Woodhouse, Esq. This much-coveted honour was awarded to Mr. J. Eastwood, gardener to Mrs. Smith, Headingley, for a most graceful and light arrangement, containing sufficient colour to render it bright without being glaring, and sufficient foliage to impart an airy appearance to it. The centre specimen was a fine *Cocos Weddelliana*, surrounding it being a due proportion of *Liliums*, *Pelargoniums*, *Roses*, with *Caladiums* and *Coleuses*, the margin being chiefly *Panicum variegatum* and *Pteris serrulata*; but the most notable plants were fine examples of *Spiræa Aruncus*, the tall feathery panicles of which were very prominent, and most telling in the effect. The second position was accorded to the Liverpool Horticultural Company (Manager, Mr. Cowan) for a pleasing bright group, in which *Crotons*, *Cycads*, *Caladiums*, and *Ferns* were the principal foliage plants; the flowering portion comprising *Roses*, *Amaryllises*, *Ericas*, *Calceolarias*, and *Fuchsias* arising from a foundation of *Adiantums*. Mr. W. Bonsall, gardener to J. Rhodes, Esq., Potternewton House, Leeds, was third with a rather heavier group, but including some fine *Erythras* and *Spiræas*. In the class for a group to occupy a space of 100 square feet there were three competitors, but none of the productions were equal to some we have previously seen there. Mr. Tuke was first with an effective collection of *Fuchsias*, *Gloxinias*, *Saxifraga pyramidalis*, *Lilium auratum*, and *Palms*, with a margin of *Panicum variegatum* and small *Ferns*; Mr. H. Wright, gardener to G. Talbot, Esq., Southfield, Burley, being second with a miscellaneous collection of fine-foliage and flowering plants in very good condition and fairly well arranged.

PELARGONIUMS.

A very bright display was afforded by these, a beautiful group being arranged at one end of a long tent, all the plants being grandly flowered. The exhibitors were principally those who competed at York; Mr. C. Rylance, Ormskirk, securing the chief prizes. His premier collection of six Show varieties, the best specimens *Queen Bess*, *Goliath*, and *Prince of Wales* very well flowered and well trained. Mr. Eastwood, gardener to Mrs. Tetley, Foxhill, Weetwood, Leeds, followed with similarly good plants, *Mary Hoyle* and *Conqueror* being admirable specimens. Mr. H. Wright was a good third with healthy plants. Two very pretty collections of six Fancy varieties were staged, for which Messrs. Eastwood and Rylance were awarded equal first and second prizes. The plants were in excellent condition, fresh, healthy, and beautifully flowered. The most notable varieties were

Delicata, Mrs. Hart, Roi des Fantaisies, Mrs. Montel, and Lucy. Zonal varieties were well shown by Messrs. G. Pybus & Son, Monkton Moor, Ripon, I. Eastwood, and H. Wright, who secured the chief prizes.

FERNS.

Several remarkably vigorous collections of Ferns were contributed in the classes devoted to them. For six plants Mr. J. Eastwood won chief honours with fine examples, a *Dicksonia antarctica* being especially large and fresh. *Leucostegia chærophylla* was also exceedingly good, over 4 feet in diameter, in beautiful condition. Mr. Bonsall was a good second, his finest specimens being *Cibotium Schiedei*, *Microlepia birta cristata*, *Adiantum gracillimum*, and *A. decorum*. Mr. J. Eastwood followed also with fresh plants. Messrs. H. Wright and Bonsall were the prizetakers for three Ferns, the last-named being also first with six well-grown *Selaginellas*. Hardy Ferns were admirably shown, as fresh and healthy as possible. Mr. Goodchild, gardener to Mrs. C. Naylor, Potternewton, had the best six plants, comprising beautiful examples of *Osmunda spectabilis*, *Nephrodium Filix-mas cristata*, and *Onoclea sensibilis* being the best. Mr. Rylance was a close second, his collection comprising a beautiful specimen of *Athyrium Filix-fœmina Vernoniae*, a very handsome variety. Mr. C. Rylance had the best three Ferns, *Athyrium Filix-fœmina Craigii* and *Scolopendrium crispum* being excellent. Messrs. Goodchild and Frankland were second and third, the former collection comprising *Scolopendrium multifforme* and *Polystichum vulgare cristatum* in very fresh condition.

Mr. Letts had the best six fine-foliage plants, securing the principal prize with richly coloured *Crotons*, *C. Queen Victoria* being very fine. *Dion edule*, *Encephalartos Vroomi*, and *Gleichenia Mendeli* were also large and healthy.

ROSE BLOOMS.

For such a comparatively early period of the season the exhibits in the classes devoted to Roses were extremely good, the blooms being remarkably fresh, of good size and substance, and rich clean colour. The principal class was that for forty-eight varieties. Mr. H. May, Hope Nurseries, Bedale, was first with a very handsome collection, comprising beautiful examples of Mrs. Baker, Maréchal Niel, Dupuy Jamain, Felix Genero, Capitaine Christy, Madame Hunnebell, François Michelin, Alfred Colomb, Victor Verdier, and Baronne de Rothschild. The second honours were obtained by Messrs. Paul & Son, Chesbunt, for a collection of similar merit, but with rather smaller blooms, R. N. G. Baker, Madame Prosper Langier, and Marquise de Castellane being extremely bright. For twenty-four varieties there were five collections. Mr. H. May again taking the chief position with very fine blooms, the substance, form, and colour being all that could be desired; the Rev. J. B. M. Camm, Magna Charta, Alfred Colomb, Princess Beatrice, Marie Baumann, and Madame Charles Wood. Messrs. Paul & Sons followed with neat blooms, A. K. Williams, Ferdinand de Lesseps, and La France being very fine. Mr. G. Prince, Oxford, was third with small blooms, chiefly Tea varieties. Messrs. H. May, G. Prince, and Paul & Son were the prizetakers in that order for twelve Tea varieties, the second-prize blooms being the best in the opinion of many visitors.

Miscellaneous plants and collections of flowers were contributed by several exhibitors, very prominent being those from the Liverpool Horticultural Company, which comprised a large number of useful fine-foliage and flowering plants, and specimens of the dwarf compact *Pteris serrulata Cowani*, for which a certificate of merit was awarded. Messrs. Kelway & Son, Langport, Somerset, were also awarded certificates of merit for four boxes of handsome *Pyrethrum* blooms, single and double varieties. Mr. Kaye of Gatley, Manchester, had a pretty case of skeletonised leaves. Mr. W. Z. Rider, Moortown, Leeds, contributed *Rhododendrons* and *Azalea* flowers; Messrs. Cranston & Co., Hereford, had four boxes of fine Rose blooms; and Mr. G. Prince of Oxford also staged some handsome Rose blooms, chiefly Tea varieties.

FRUIT.

The exhibits in these classes were generally distinguished by good quality, the black Grapes being well coloured; Peaches and Nectarines fine, but the white Grapes were a little deficient in finish except in the leading collections. Mr. H. Clayton, gardener to John Fielding, Esq., Grimston Park, was first with six varieties. The Grapes were Black Hamburgs and Muscat of Alexandria, good bunches and well ripened; *Violette Hâtive* Nectarines were good, A Bec Peaches and fine fruit of Hybrid Melon were also notable. Mr. Edmonds, The Gardens, Beetwood Lodge, Nottingham, was second, having good Elruge Nectarines and Chancellor Peaches; and Mr. W. Wallis, The Gardens, Kirby House, York, was third with Black Hamburg Grapes and Royal George Peaches. There was good competition in the class for four varieties, Mr. Edmonds securing the chief prize for good examples of Black Hamburg Grapes, fine berries and well coloured; Chancellor Peaches of good size and colour, Queen Pine Apple, and William Tillery Melon. Mr. Clayton followed closely with good Black Hamburg Grapes, *Violette Hâtive* Nectarines, A Bec Peaches, and Hybrid Melon. Mr. Wallis was third, having Golden Perfection Melon very well netted.

In the Grape classes the competition were rather close, the principal prizetakers being Messrs. R. Johnson, gardener to Thos. Statton, Esq., Stand Hall, Manchester; W. Wallis; T. Goss, gardener to C. J.

Milnes Gaskell, Esq., Thornes House, Wakefield; and T. Hare. Peaches, Nectarines, and Melons were fairly represented.

ROYAL HORTICULTURAL SOCIETY.

JUNE 26TH.

BOTH Committees were well attended, and a number of plants and other exhibits were submitted to their consideration. The weather unfortunately proved very unfavourable, heavy showers prevailing throughout the day.

FRUIT COMMITTEE.—H. Webb, Esq., in the chair. There were present Messrs. H. Weir, G. Goldsmith, J. Bunyard, C. Silverlock, Z. Stevens, H. Veitch, A. W. Sutton, John Lee, S. Lyon, Sir C. Strickland, Thomas Laxton, J. Burnett, Dr. Hogg, J. Roberts. Messrs. J. Veitch and Son, Chelsea, exhibited plants of a number of varieties of Pears that had been sown from March 14th to 24th, and which had been ready for gathering from June 19th to June 25th. The varieties were Dr. Hogg, Alpha, Chieftain, Optimist, Unique, Masterpiece, Minimum, Little Gem, Extra Early, Dickson's First-and-Best, Sangster's No. 1, Kentish Invicta, and Early Sunrise. A vote of thanks was accorded. Several samples of Onions were also sent with the new form, The Queen—a neat variety of moderate size, pure white, and early. A letter of thanks was accorded. Mr. Harris, The Gardens, Singleton, Swansea, sent nine good Pine Apples, weighing from 4 to 5 lbs. each, several being of excellent form and colour. A silver medal was awarded for them.

Mr. Laxton, Bedford, exhibited fruits of a new Strawberry, The Captain, which is described as a perpetual bearer, being in fruit from early June until late September. The fruits are large, wedge-shaped, and of fairly good colour. The Committee thought highly of it, and it is to be tried at Chiswick to test its late-bearing qualities. Mr. Hudson, the gardener, Gunnersbury House, Acton, sent fruits of a new scarlet-fleshed Melon, a cross between Turner's Scarlet Gem and High Cross Hybrid. Mr. Goldsmith, Hollenden, Tonbridge, sent a new scarlet-flesh Melon of good size and finely netted. It was named Hollenden Favourite and is said to be a cross between Earl of Beaconsfield and Read's Scarlet-flesh. A first-class certificate was awarded for it. Mr. C. Ross, Welford Park, Newbury, also had a seedling Melon, a green-flesh variety from William Tillery crossed with Dell's Hybrid, a fruit of moderate size, good depth of flesh, and well netted. Messrs. Carter & Co., High Holborn, sent six baskets of Lettuces and nine dishes of fine Peas.

FLORAL COMMITTEE.—G. F. Wilson, Esq., in the chair. The following were also present—Rev. G. Henslow; and Messrs. C. Green, J. McIntosh, H. Bennett, J. Fraser, J. Cutbush, A. M. Ridley, J. Dominy, J. Hudson, G. Duffield, J. Wills, W. B. Kellock, and Dr. M. T. Masters.

Mr. T. S. Ware, Hale Farm Nurseries, Tottenham, staged one of the most handsome groups of hardy flowers that we have ever seen exhibited, comprising a great number of the choicest and most beautiful species and varieties in cultivation, and most tastefully arranged, the bottles employed being to a great extent concealed, the margin being formed of neat plants of the hardy *Selaginella helvetica*. Lilies were in strong force, some of the best being *L. pardalinum pumilum*, orange-spotted, dwarf; *L. pomponium*, orange red, small but very free; *L. colchicum*, pale yellow, free, handsome; *L. longiflorum*, and *L. auratum*. Varieties of the charming *Gladiolus ramosus* were a feature in the group. Princess Marianne, delicate peach with rose blotches, was very notable, as was also the pure white *Colvillii* The Bride. Of *Campanulas* the dark purplish blue *glomerata grandis alba*, *persicifolia alba*, and the pale purple *macrantha* were good. The graceful white feathery *Spiræa Aruncus*, the rosy *Armeria plantaginea rubra*, dark-coloured blooms of *Cypripedium spectabile*, with *Ixias*, *Pyrethrums*, and innumerable others constituted a group of considerable beauty. A vote of thanks was accorded for it.

Messrs. H. Cannell & Sons, Swanley, exhibited extensive collections of plants and cut flowers, comprising some grand spikes of *Delphiniums*, rich dark blue and delicate pale blue shades being abundant. The dwarf free double-flowered pink Zonal *Pelargonium* Princess Stephanie, and the similar scarlet and salmon *Comtesse de Tannberg*, were notable. Baskets of the large-flowered useful *Lobelia* Swanley Blue were very prominent, together with stands of hose-in-hose *Campanulas*, the fringed crimson and white *Petunia Avalanche*, the common floriferous *Lupinus Sabinianus*, and a beautiful collection of *Violas*, including New Guinea, rich yellow; Star of the Garden, deep purple; Mrs. Gray, white; Queen of Spring, bright yellow; Countess of Kintore, purple and white; and Mulberry, rich crimson purple. Votes of thanks were accorded for these groups.

Votes of thanks were also accorded to the following:—Messrs. Barr & Son, Covent Garden, had a large collection of hardy flowers, Irises being very numerous and fine. Poppies, Phlox, Lilliums, *Pyrethrums*, *Pæonies*, *Ixias*, and *Gladiolus* were largely represented by many handsome varieties. Messrs. Kelway & Son, Langport, Somerset, had two boxes of excellent *Pyrethrum* blooms, single and double, including several particularly fine varieties. Messrs. W. Paul & Son, Waltham Cross, staged fourteen boxes and baskets of grand Rose blooms, the colours extremely rich, and the form good. The delicate creamy white Damask Madame Hardy was finely shown, as was also the white Moss Blanche Moreau. Of other varieties the most noteworthy were A. K. Williams, Marie Baumann, Queen of Queens,

M. Noman, Madame Ducher, and François Michelin. Mr. H. Bennett, Shepperton, Middlesex, showed four boxes of handsome Rose blooms, the varieties Earl of Pembroke, Lady Mary Fitzwilliam, and Mary Bennett being in fine condition, together with two varieties that were certificated.

An extensive collection of Zonal Pelargoniums was shown by Mr. J. R. Pearson, Chilwell Nurseries, Nottingham, including a great number of handsome varieties, fine shades of scarlet, pink, and orange. A cultural commendation was awarded for a plant of Metis with six expanded trusses of bright scarlet flowers. Mr. G. Prince, Oxford, exhibited three boxes of Rose blooms, chiefly Tea varieties, and all in fine condition. Mr. C. Turner, Slough, exhibited a stand of handsome Carnation blooms, large and diversely coloured. Mr. H. Hooper, Bath, sent several boxes of Roses, Carnations, and Pansies, representing a great number of fine varieties. Mr. H. S. Dutton, Newbridge Hill, Bath, showed a silver-foliaged Pelargonium, Duchess of Connaught, with double pink flowers, a very attractive variety. Mr. E. J. Lowe, Sbirenewton, Chepstow, was awarded a vote of thanks for flowers of curious Pansies. Mr. Hooper, Bath, sent several brightly coloured Pyrethrums. Mr. W. Stacey, Great Dunmow, showed stands of Verbenas, several of which were certificated.

G. Hardy, Esq., Pickering Lodge, Timperley, showed a plant of *Cattleya Sanderiana* with two handsome flowers, the lip very large and intensely rich crimson in colour, a band of white at the base relieving it grandly. The sepals and petals are also of a warm crimson hue. A vote of thanks was accorded for it, and a good variety of *C. Warneri* with four fine flowers, and *Lælia purpurata* with two spikes, four flowers each. Mr. H. James, Castle Nursery, Norwood, sent several choice and rare Orchids, including *Trichopilia picta*, *Thunia Marshalliana*, and *Nanodes Medusæ*. A cultural commendation was awarded to G. F. Wilson, Esq., Weybridge, for a fine stem of *Lilium Szovitzianum*, about 5 feet high, and bearing fourteen large flowers.

Mr. B. S. Williams, Upper Holloway, exhibited a beautiful group of Orchids and choice stove and greenhouse plants—*Cypripedium superbiens* with twelve fine flowers, *Thunia Bensoniæ*, *Dendrobium suavissimum*, *Cattleya Mossiæ*, *Mendeli*, and *Morganicæ*, with *Trichopilia suavis alba* were very notable. Messrs. Veitch also showed a dark-coloured *Heliotrope Roi des Noirs*, and spikes of *Andromeda speciosa pulverulenta*, with large white bell-shaped flowers, very beautiful. Several new plants were shown and certificated. A cultural commendation was awarded to Mr. J. Yelks, The Gardens, Higham Hill, Walthamstow, for a grand spike of *Cymbidium Lowianum*, with twenty-seven flowers. A vote of thanks was accorded to J. Gair, Esq., Falkirk, for flowers of a superb variety of *Cattleya Warneri*, the lip extremely rich crimson in colour.

First-class certificates were awarded for the following plants:—

Rhododendron Diadem (Veitch).—A magnificent variety of the greenhouse hybrid section, the flowers nearly 3 inches in diameter, the petals broad and rounded, of a fine orange scarlet hue.

Yucca gloriosa variegata (Veitch).—A distinct variety, with narrow leaves streaked with white and cream.

Pritchardia grandis (Veitch).—A handsome Palm, with broad roundish ribbed leaves, regularly cut at the margin.

Pratia angulata (Veitch).—A clump of plants lifted from the ground was shown, covered with small white Lobelia-like flowers.

Leucothoe Davisæ (Veitch).—A compact-growing evergreen shrub; the leaves elliptical, an inch long, dark green; the flowers are white, bell-shaped, and borne in dense racemes clustered near the summit of the stems.

Begonia Prince Albert Victor (J. Laing & Co.).—One of the finest double forms of the Tuberos section, globular, dense, nearly 3 inches in diameter, and bright scarlet.

Delphinium Dick Sand (Belby).—A double-flowered form, with rich dark purple flowers on a dense spike.

Rose Violette Bouyer (J. House, Peterborough).—A Hybrid Perpetual, one of Lacharme's Roses of last year, a seedling from Jules Margottin, white or delicately blush-tinted, with shell-like petals; neat and compact, and very sweet.

Verbena Delicata (Stacey).—Flowers very large, pale pink, trusses dense.

Verbena Miss Maynard (Stacey).—Flowers neat, rich purple, white eye.

Verbena Mabel (Stacey).—Flowers of moderate size, mauve, good truss.

Verbena Fantastic (Stacey).—Flowers large, pink, curiously streaked and spotted with scarlet.

Begonia Zenobia (Benary).—A double tuberos variety, very dark scarlet, very full and handsome.

Begonia Orange Giant (Royal Horticultural Society).—Flowers of great size, 5½ inches in diameter; petals very broad, orange scarlet in colour.

Rose Henrich Schultheis (Bennett).—A Hybrid Perpetual pedigree Rose; large, full, with broad rounded petals of a deep rose hue.

Rose Mrs. George Dickson (Bennett).—A Hybrid Perpetual pedigree variety, with neat conical flowers; broad petals, the margins revolute and of a delicate soft pink colour.

SPECIAL PRIZES.

Seven competitors entered for Messrs. Webb & Sons' prizes for six dishes of vegetables. Mr. Beckett, gardener to J. P. Curric, Esq., Sandown House, Esher, took the lead with a good collection, includ-

ing White Naples Onions, fine Woodstock Kidney Potatoes, Early London Cauliflowers, Canadian Wonder Beans, Early Nantes Carrots, and Culverwell's Telegraph Peas. Mr. Ward, gardener to the Earl of Radnor, Longford Castle, Salisbury, was second with a very creditable collection. Leviathan Beans, Telegraph Peas, and White Naples Onions were admirable, Early London Cauliflowers being also fine. Mr. Haines, gardener to the Earl of Radnor, Colleshill House, Highworth, was third; and Mr. Meads, gardener to Viscount Barrington, Beckett Park, Shrivenham, was fourth.

Messrs. Sutton & Sons, Reading, offered three prizes for four dishes of Peas, Mr. Ward taking the first position with President Garfield, Laxton's Supreme, Culverwell's Giant Marrow, and Laxton's Jobn Bull—all fine well-filled pods. Mr. G. Goldsmith, Hollenden, Tonbridge, was second with smaller examples of Hero of Kent, Day's Early Sunrise, Improved Champion, and Ringleader; Mr. Haines following with small pods of First-and-Best, Ringleader, Kentish Invicta, and William I. The prizes offered by the same firm for six varieties of Lettuces were well competed for, seven collections being staged. Mr. Beckett won the chief prize with fine examples of All-Heart, Superb White, Improved Black-seeded, Blonde de Berlin, New Marvel, and All-the-Year-Round. Mr. Fyfe, gardener to W. F. Dick, Esq., Thames Ditton House, Surrey, followed closely; Superb White Cos, Neapolitan Cabbage, St. Albans, All-Heart, and Marvel being the best varieties; and Mr. Meads was third.

Mr. Goldsmith had the only collection of twelve Gloxinias in the class for Messrs. Sutton & Sons' prizes, and was awarded the first prize for remarkably good plants, some with two dozen flowers.

SCIENTIFIC COMMITTEE.—A. Grote, Esq., in the chair.

Melon Leaves Diseased.—Mr. G. Murray reported that he had examined the leaves sent by Mr. Boscawen to the last meeting, and found that the treatment of sulphur and lime had quite destroyed the fructification of the fungus, but the mycelium was still present within the tissues of the leaf. He thought it might prove to be a *Peronospora*, but would examine it further and report.

Potato Disease.—Mr. S. Wilson forwarded fresh material for Mr. G. Murray to examine, remarking that the results of the chemical tests he had applied were that the so-called sclerotia were insoluble in spirit, not coloured by iodine, but are soluble without effervescence in nitric acid; they are also soluble in acetic acid. Alkaline tests had not been applied. They fall out readily from the macerated tissue, not being in the cells but between them. Mr. Wilson also adds that Prof. Dickson distinctly denies that they are *Tuberinia* or *Protomyces*. Mr. G. Murray will report further on the nature of these sclerotoid bodies.

Alchemilla vulgaris.—Mr. G. S. Boulger exhibited a fine specimen of the common Ladies' Mantle grown in a garden for three years, and which then formed a very ornamental plant.

Pinus Thunbergii (Massoniana of gardens).—Dr. M. T. Masters showed young cones of this species having anthers at the base. He observed that he had seen a similar occurrence in *P. rigida*.

Torsion in Sweet William.—Mr. Bennett exhibited a stem showing the spiral arrangement of the leaves by torsion. It is noticeable that the "opposite and decussate" arrangement characteristic of the *Caryophyllæ* is not departed from, but one leaf of each pair grows slightly higher than the other in contact with the next pair, thus producing the spiral torsion. Teazle stems grown from seed were used as parasol handles under the name of *Eucalyptus* (!) having the same torsion.

Synanthic Digitalis.—Mr. Loder showed a plant where the terminal flower had grown in a campanulate form by two or three flowers having combined. It was fully expanded, though the raceme was blossoming upwards as usual.

Ranunculus aquatilis.—Mr. Henslow showed a specimen growing on damp soil, in which several of the usually floating leaves were partially divided, showing a transition to the filiform state, while the latter, which formed a perfect carpet, were provided with abundance of stomata, though when submerged they are devoid of them.

PELARGONIUM SOCIETY'S SHOW.

JUNE 26TH.

ALTHOUGH the large tent devoted to the Pelargoniums presented a display of great brilliancy as a general view, we have seen the exhibits more numerous and also of better quality generally. Several competitors who have taken a prominent part in previous Shows were absent, and the Uxbridge specimens, which are usually of such fine quality, were not up to their usual standard, and judging from this Exhibition the Pelargonium Society cannot be congratulated on the advancement that has been made in the culture of its special flower.

Show Varieties.—These were fairly but not largely represented, Mr. C. Turner, Slough, taking the chief prize for six plants, healthy and fairly well flowered. Victory, Despot, Modesty, Amethyst, Archduchess, and Mountaineer were the varieties. Mr. J. Wiggins, gardener to H. Little, Esq., Hillingdon, Uxbridge, was second, but his plants were not of their usual good quality. For eighteen varieties Mr. Turner was first with very healthy plants, bearing large richly coloured flowers, but rather scanty in number on some of the plants. Amethyst, Statesman, Victory, Comet, and Joe were, however, in fine condition. Mr. Wiggins followed closely with similar plants but rather smaller. Ruth Little, Rosalind, Formosa, and

Amethyst were very good. A silver Banksian medal was awarded to Mr. C. Turner for a handsome plant of Amethyst in the above collection. It was about 4 feet in diameter, very healthy, and with over 100 trusses.

Fancy Varieties.—Two fairly good collections of these were staged, Mr. Turner taking the chief prizes with six, including Mrs. Pope, Delicatum, Lady Carrington, Pilgrimage, Mrs. Pottle, and Nellie Fordham, which were healthy, freely-flowered specimens. Mr. Wiggins was second, a plant of Delicatum being shown in uncommonly fine condition, a mass of pretty white and rose flowers.

Decorative Varieties.—The collections of these constituted the chief feature of the display, a considerable number of fine plants of showy varieties being staged. For six varieties Messrs. J. & J. Hayes, Edmouton, were first with well-grown specimens of Maggie Improved, Garibaldi, Lady Isabel, Duchess of Bedford, and Gold Mine. Mr. Wiggins followed, showing Triomphe de St. Mandé, Madame Favart, and Morning Star in admirable form. Mr. Turner took the third place, his best plant being Comtesse de Choiseuil. Messrs. Hayes were also first with eighteen varieties, finely flowered examples of Garibaldi, Maid of Kent, Digby Grand, Gold Mine, Bouchardet, Delicatum, and Mrs. J. Hayes. Mr. C. Turner was a close second, the pure white Marie Knecht, Kingston Beauty, Robina, and Comtesse de Choiseuil being very fine. Mr. Wiggins was a good third.

Zonal Varieties.—A bright display of these was contributed, but the plants were not quite so numerous or fine as usual. Mr. Weston, gardener to D. Martineau, Esq., Clapham Park, was first with six vigorous specimens of Lizzie Brooks, Rosamond, Laura Strachan, Lucrezia, Hettie, and Rev. F. A. Atkinson. Mr. W. Meadmore, Romford, and Wiggins, were second and third respectively. For eighteen varieties Messrs. Weston, Saltmarsh & Son, Chelmsford, and Wiggins were the prizetakers in that order, showing small plants of the principal varieties.

Double varieties were not largely shown, the plants being mostly small and poorly flowered. Messrs. Saltmarsh & Son were first with eighteen plants, the best being Mrs. Arthur Lattey, Guillon Mangilli, Prince Teck, Duchess of Albany, Earl Beaconsfield, and Emile de Girardine. Mr. Wiggins was second with larger older specimens bearing some good trusses of bloom. Mr. W. Meadmore was third.

Ivy-leaf Varieties.—Only one collection of nine Ivy-leaved varieties was staged by Mr. Wiggins, who was awarded the first prize. The plants were 3 or 4 feet high, of pyramidal or cylindrical shape, the varieties being Galilee, Eurydice, Sarah Bernhardt, Perle, Gloire d'Orleans, Mdle. Jean Wonters, Anna Pfitzer, Madame Emile Gallé, and Elfrida.

Cut Blooms.—Several handsome stands of these were staged, the Zonal varieties being especially good. For thirty-six varieties Mr. C. Turner won chief honours with fine examples. Messrs. H. Cannell and Son, Swanley, were first with twenty-four varieties, uncommonly fine in size and colour, Messrs. Saltmarsh and Meadmore following in that order. For thirty-six single Zonal varieties Messrs. H. Cannell & Sons took the lead with a magnificent collection, Messrs. Saltmarsh gaining a similar position with twenty-four varieties, followed by Mr. W. Meadmore. Messrs. H. Cannell and Sons were also first with thirty-six double Zonal varieties, very handsome, Messrs. Saltmarsh and Meadmore taking the prizes for twenty-four double varieties. For twelve single Ivy-leaved varieties Mr. J. George, Putney Heath, was first with fine blooms of Argus, La France, St. George, Progress, Nemesis, Gem, Mrs. Cannell, Diadem, and several seedlings. Mr. Wiggins was awarded the second prize for twelve double Ivy-leaved varieties.

NEW VARIETIES.

For three Show varieties not in commerce E. B. Foster, Esq., Clewer Manor, Windsor, was first with *Brilliant*, bright scarlet, with a black blotch on the upper petals; *Diadem*, neat flower, scarlet lower petals, darker upper, white throat, and *Adventure*, flower large, lower petals pink, upper dark scarlet, shading lighter on margin, centre white. Mr. Wiggins was first with one new Show variety, *Mrs. H. Little*, for which also a first-class certificate was awarded. The flowers are large, of good form, even rounded petals, the lower being pure white, the upper rich dark crimson in the centre, with a white margin. Messrs. J. & J. Hayes were first with three Decorative varieties:—*Formosa*, bright scarlet, white centre, and a narrow white beading, very neat and free; *Fanny*, delicate blush pink, crimson-blotched in upper petals; and *Bouquet*, white, with a few rose streaks in the centre of the petals, fringed and free. Mr. C. Turner had the best single Decorative variety, *Dresden China*, a peculiar form, the flowers white irregularly splashed with rose and crimson. For two Decorative varieties Mr. W. Brown, Hendon, was first with *Beacon*, fiery red, the upper and lower petals with dark blotches in the centre; and *Lustrous*, similar in colour, but with the blotches confined to the upper petals. A first-class certificate was awarded to J. Bealby, Esq., Roehampton, for *La Cygne*, a double Zonal variety, pure white, very full and with a large truss.

COMING FLOWER SHOWS.

THE following are the dates upon which the principal horticultural exhibitions and meetings of June and July will be held, of which we have received schedules, and Secretaries of other Societies will oblige

by forwarding schedules to us of any shows not noticed in this list:—

JUNE.

Thursday, 28th.—National Rose Society's Show, Southampton; Richmond.
Friday, 29th.—Canterbury (Roses).
Saturday, 30th.—Reigate (Roses); West Kent; Bromley.

JULY.

Tuesday, 3rd.—National Rose Society's Show, South Kensington.
Wednesday, 4th.—Wimbledon; Teddington; Norwood.
Thursday, 5th.—Bath (Roses); Kingston; Farningham; Highgate; Hitchin (Roses); Romford.
Friday, 6th.—Sutton (Roses).
Saturday, 7th.—Chiswick, Crystal Palace (Roses); Brockham (Roses).
Tuesday, 10th.—Royal Horticultural Society, Fruit and Floral Committees at 11 A.M. Oxford, Wirral, and Hereford Rose Shows.
Wednesday, 11th.—Royal Caledonian Society's Show, Edinburgh. Hull Show (three days); Ealing.
Thursday, 12th.—National Rose Society's Show, Sheffield; Nuneaton; Brantree.
Friday, 13th.—Ludlow (Roses).
Tuesday, 17th.—Leek (Roses).
Wednesday, 18th.—Nottingham Floral Fête (two days). Darlington (Roses).
Thursday, 19th.—Evening Fête at Chiswick; Aberdeen; Helensburgh (Roses).
Tuesday, 24th.—Royal Horticultural Society, Fruit and Floral Committees at 11 A.M.; Carnation and Picotee Show, South Kensington.
Wednesday, 25th.—Colnbrook.
Thursday, 26th.—Eastbourne.



[By the most skilful Cultivators in the several Departments.]

HARDY FRUIT GARDEN.

WALL TREES.—*Peaches and Nectarines.*—Assist the swelling fruit by copious weekly waterings of sewage, but if this cannot be had, scatter artificial manure thickly over the border before watering. Some trees so treated recently have grown with extraordinary freedom, and the large deep green foliage bears no trace of noxious blight or insect. It is the slower growth of weakly under-fed trees that is usually attacked by red spider, which must be kept under by frequent syringing with clean water. Lateral growth is now coming freely, and some of it may be retained with advantage upon young trees of much vigour where space can be spared for it. We have frequently obtained excellent fruiting wood in this way from long gross growth, which, if bereft of its secondary shoots, would have been worthless and barren.

Pears, Plums, and Cherries.—If Pears, Plums, and Cherries of sorts bearing the fruit upon spurs have not yet had the first growth shortened to within an inch of its base, let there be no more delay in doing it in order to secure the benefit of midsummer growth, which is just beginning. Thin the new growth of Morello Cherries, and tie in the remainder. Look sharply after black aphides, which usually attack the tips of Cherry shoots about this time, and promptly check it by dipping the affected parts in a solution of 2 to 3 ozs. of Gishurst compound in a gallon of water.

Figs.—Growth of undue vigour may in some measure be turned to account by nipping off the ends to induce lateral growth for bearing fruit next year. Very vigorous growth is apt to be barren; note such trees in order that they may be root-pruned next autumn.

TREES IN THE OPEN.—*Espaliers.*—Young trees should either be trained as cordons or palmette verriers, the two forms wherein economy of space, equal distribution of vigour, and fruitfulness is best combined. Train the leading growth to the required form, taking especial care that the swelling growth is not hurt by careless tying, and at once loosen any tight strings; also watch closely for caterpillars, from which the leading shoots of the Apple, Pear, and Plum are all liable to suffer. Shorten the laterals as directed for wall trees, and see that none of the trees suffer by want of water, but rather anticipate such wants by a regular system of watering in dry weather. This, of course, applies to all young trees of whatever form. The treatment of established fruiting trees at this season of the year resolves itself into shortening lateral growth, thinning fruit, attention to cleanliness and health of the foliage, and occasional heavy waterings in very dry weather.

Pyramids.—Pay particular attention to the growth of the lower branches of young trees, and, if it is unsatisfactory, at once check the stem growth by nipping off the top. Let there be no hesitation about this, for if each tier of branches is not rendered thoroughly stout and vigorous at first no subsequent care will render it so. Where all is going on well the leading shoots may be stopped at

14 inches and the laterals at an inch. See that the laterals are pruned on fruiting trees to promote the formation of blossom buds and to admit air and light freely among the branches.

STRAWBERRIES.—Layering.—Runners are now appearing in abundance, but they cannot be turned to account upon beds in full bearing, yet it is so important to do layering early that enough vigorous plants should be kept from fruiting for this purpose in every garden; very few would suffice for the requirements of small gardens, and in large ones space can always be had for such a purpose. First ascertain the number of plants you require, then fill enough 3-inch pots firmly with very rich soil, allowing a margin for accidental losses. Plunge each pot half its depth in the soil near the runner, which press into the centre of the soil in the pot, and fasten it there by a peg thrust firmly into the soil close outside the pot. The slight plunging keeps the pot soil moist and promotes the quick rooting of the runner, which must not be separated from the parent plant till its roots touch the sides of the pot. An occasional watering will accelerate matters, and is quite worth while, our object being early planting, in July if possible, in order to obtain an abundant supply of early and fine fruit next year. We give this well-tried method of layering fully, for it never fails us, always affording the best plants either for new beds or for potting, and there is no subsequent check to the growth, whatever be the purpose for which the plants are required.

FRUIT FORCING.

VINES.—Thinning Grapes and Stopping Laterals.—Complete the thinning of late Grapes with as little delay as possible. Late houses of Hamburgs intended for use from October to January will need more thinning than is necessary where the Grapes are used in the summer season, and medium-sized bunches will keep better than those which are large and heavily shouldered. When the berries are beginning to swell freely all weak laterals may be allowed to grow, but the gross ones will require close stopping in order to equalise the flow of the sap, as well as to insure short-jointed firm wood that seldom fails to ripen well.

Grapes Scalding.—The earliest-started Lady Downe's, as well as the main crop of Muscats, will now be about stoning, and will require close attention to prevent scalding. It is always the most troublesome when we have sudden changes from heat to cold, being aggravated by a rapid rise in the temperature, especially if it occur before air has been given. It is a mistake to consider that berries not directly exposed to the sun will be safe, as those beneath the foliage are equally as much affected, as the berries having become cold through the night moisture is condensed, and the skin, from the rapid evaporation, becomes injured. To prevent the evil a warm and rather dry atmosphere should be maintained through the night with a little ventilation, increasing the temperature before the sun acts powerfully upon the house. With the Vines in a healthy state and the roots in properly drained borders, scalding, or the liability thereto, does not extend over a fortnight; but when the roots are in cold borders the scalding extends to three weeks or more.

Watering Vines.—The recent rains have done good service in thoroughly moistening outside borders; and where there are tanks, as there ought in every garden, the surplus water should be given to the internal borders, which is profitable employment for the outside hands on wet days, and is in every way preferable to allowing the surplus water to run into the drains. Vines on advancing growth and those swelling off their crops will take large quantities of water of a stimulating nature; therefore give liquid manure in a tepid state copiously, none being better than the drainings of the dungheap.

Enfeeblement and Renovation.—The earliest forced Vines having become enfeebled through repetitions of the process, and the roots having the run of inside and outside borders, one or other of these may be taken out as soon as the crop is cleared. In order to successful lifting and laying-in of the roots in fresh material it is necessary that it be done quickly; therefore before the work is begun the fresh compost and drainage should be prepared and be within easy reach, so that the work may be done expeditiously. The house should be shaded and kept moist to prevent the foliage flagging, as well as to prevent the roots from suffering. Every particle of soil should be removed, even if part of it be returned, and the drainage should be taken out and thoroughly re-arranged, unless it be found satisfactory. When all is finished the roof will require shading on bright days, syringing the Vines frequently, and maintaining a close, moist, and warm atmosphere from solar heat until new growth is perceptible, when the ordinary treatment should be followed, and the Vines will be in good order for starting again at the usual time, or in December.

Planting Vines.—If it be thought advisable to replant Vines in early houses they should be cleared of their occupants at once. Good vigorous canes from this year's eyes are, next to cut-backs shaken out and grown on, most suitable for the purpose. With proper treatment they will fill the house this season. A ridge of compost along the front of the house will be sufficient for this season, and may be doubled next and each year until the whole of the border is made. Plump buds, though the growth be strong, even rampant, will ripen at the base for cutting back to, and these push strong fruiting canes another season.

The Cherry House.—When the crop of fruit on the trees is cleared the trees should be thoroughly cleansed of all insect pests by syringing morning and evening forcibly for red spider; use tobacco water or fumigate for green and black aphides, and take every opportunity of giving the trees free exposure, which is essential in order to prevent a second or premature growth, which, if allowed to become developed, is fatal to next year's crop. Keep the borders thoroughly moist. As soon as the leaves and buds show indications of ripeness it will be necessary to remove all the roof lights, also the side lights. Newly planted trees will be benefited by having the roof lights over them a little longer in order to effect early ripening of the wood and buds, and thereby accelerate the forcing process another season.

PLANT HOUSES.

Calanthes.—Those in active growth will require liberal supplies of water at the root, and weak stimulants given occasionally will prove beneficial. Where large pseudo-bulbs were placed in small pots when started they can, especially *C. Veitchii*, if strong and vigorous be placed in others a size larger. Keep them as near the glass as possible, and let them have abundance of light, which is essential to success, at the same time the strong rays of the sun must not shine directly upon them. Syringing may now safely be practised.

Cattleyas.—Many of the varieties of *C. Mossiæ* and *C. Mendelli* will still be in flower, and if placed in a cooler and drier atmosphere than where the general stock is grown their gorgeous flowers will last very much longer in good condition. These plants will, if in a healthy condition, now require more moisture, both at the roots and in the atmosphere, than at any other season of the year; yet care must be exercised that the plants are not kept in a saturated condition continually, or the atmosphere allowed to become stagnant, or much harm will soon result. Shade must be carefully and judiciously applied, and not overdone, as is too frequently the case with these plants.

Dendrobiums.—Few Orchids delight in heat and moisture more than these do while making their growth. Constant attention in watering and syringing will daily be needed, whether grown in pots, baskets, or upon blocks suspended from the roof. Those suspended will need syringing at least twice in the day, besides being thoroughly soaked frequently in a tank of tepid water. Some Dendrobiums are liable to red spider, which if allowed to establish itself upon them soon arrests their growth, and the pseudo-bulbs in consequence are small. Eradicate all insects by means of sponging with soft water in which a little soft soap has been mixed.

Cool House.—Orchids.—The various plants grown in this house will no longer need artificial heat, except on solitary occasions when the external temperature falls very low, as has been the case recently. The majority of the occupants of this house will be growing vigorously, therefore water should be applied copiously, and no harm will result from it being applied overhead at this season of the year when abundance of air can be daily admitted. Although *Odontoglossums*, *Masdevallias*, and others will bear heavier shade than the majority of Orchids, yet shading is often carried to the extreme with these plants. Strong sun they dislike, but every ray of light that can be admitted is necessary to insure sturdy growth and solid pseudo-bulbs, which alone will produce stout stems and large bold flowers.

Impatiens Sultani.—This promises to become a popular plant, and will be largely grown for decorative purposes. It is of easy culture, and can be freely propagated by means of cuttings, which root readily in heat and will commence flowering even before they have formed roots. It will also come freely from seed; and if flowering plants that stand upon gravel, ashes, and other moisture-holding material, are allowed to form seed pods, these will burst as soon as they are ripe, and the seeds will be dispersed in every direction. The result is that a stock of young plants can soon be raised, for the scattered seed appears to germinate most freely amongst the material upon which the plants have been placed, and often many yards away.

FLOWER GARDEN AND PLEASURE GROUND.

Roses.—Those budded last season are forming remarkably strong growths; and these, especially in the case of standards, must be kept carefully tied to the light stakes previously fastened to the stocks, or they may yet blow off. If large blooms are required disbudding should be resorted to, retaining the strong central bud only, unless this be injured or deformed in any way. This disbudding greatly strengthens the reserved bud, and we practise it with all our Roses, not always, however, leaving the central bud, but it is advisable where they are grown principally to cut from to select side or later buds, thereby securing a more continuous supply. Some of the lower side buds on strong shoots are also retained. All spray should be thinned out of crowded heads. On warm walls *Maréchal Niel* will have nearly done blooming, and if the old growths are cut hard back strong young shoots will result, which, if carefully secured, will flower at every joint next season. During showery weather give good waterings with liquid manure.

Herbaceous Plants.—Pentstemons, Antirrhinums, Campanulas, Choice Phloxes and Delphiniums should be kept neatly tied up, or heavy winds may at any time greatly damage them. All are benefited by soakings of liquid manure, the Phloxes especially, unless recently replanted, requiring abundance of rich food, and they ought also to be freely thinned out where at all crowded. After the borders have had a soaking of water, or after heavy rains, it is advisable, on light soil or in hot positions especially, to mulch either with short manure or grass from the mowing machine. Double and single Pyrethrums are now becoming unsightly, and if cut down near the ground another supply of bloom will be obtained. Double and single Rockets should also be similarly treated.

Pinks and Carnations.—Among the former the white *Clove Mrs. Sinkins* has proved a valuable acquisition, and will rapidly replace the old white Pink, being what is termed perpetual-flowering. Blooms should be freely cut, as this will benefit the successional flowering shoots. If cuttings of this and any other varieties, including the beautiful *Derby Day*, *Reliance*, *Rival*, *Mrs. Pettifer*, *Inspector*, *Victory*, *Petrel*, and *Lady Blanche* are not already inserted no further time should be lost, as they strike root best when taken off plants in flower or before they have become soft. The back of a north wall or hedge, or failing these under the shade of fruit trees, providing the position is not very dark, is most suitable for striking them. The commoner kinds will strike root in fine and firm sandy soil without the aid of glass, but handlights or boxes covered with pieces of glass are preferred for choice sorts. Our handlights are stood on a hard bottom, and about 3 inches of fine sandy or gritty soil is levelled inside of each. The cuttings or pipings—that is to say, small side growths, are pulled, slightly trimmed, dibbled-in firmly about 2 inches apart each way, watered, covered with glass, and carefully shaded from bright sunshine till rooted. In some districts it is found necessary to form shallow hotbeds for striking Pinks with the aid of mild bottom heat, and kept carefully shaded they root quickly, and it may be advisable to try both systems where Pinks are in great request. Both plans are also recommended for propagating Carnations and Picotees, or they may be layered later on. Seedlings of the two latter are the best bloomers, but should not be retained more than two seasons, unless they have been prevented from blooming to an injurious extent. It is rather late to sow seed, but fairly strong plants may yet be secured if it is sown thinly either in handlights or boxes, and covered with glass. Use light sandy soil, do not bury the seed deeply, and shade from bright sunshine.

Myosotis and Campanulas should be sown at once if not already done, as in many cases, and choice varieties of the former may be increased by division. *Myosotis dissitiflora* is the best for bedding purposes. Cool shady positions suit divided plants of *Myosotis*, *Daisies*, *Polyanthuses*.

THE BEE-KEEPER.

BRITISH BEE-KEEPERS' ASSOCIATION.

WE desire to call the attention of our readers to the annual Exhibition of this Society, which takes place at the Duke of Wellington's Riding School at Albert Gate, Knightsbridge, on July 5th, 6th, 7th, and 9th. Since 1877 this Exhibition has been

held annually in the Royal Horticultural Gardens at South Kensington, but owing to the Fisheries Exhibition occupying all the available space during this year, the Association has been compelled to seek fresh quarters. The matter having been brought to the notice of his Grace the Duke of Wellington, he very kindly placed his Riding School at the disposal of the Committee. The date of the Show has been fixed nearly a month earlier than usual, in order to give those who are staying in London for the season an opportunity of visiting this interesting and instructive Exhibition; no better date could have been selected. The present season has been one of the best on record for the production of early honey, the warm sunshine of the past few weeks tending to the secretion of honey, and large quantities have been gathered by the bees from the fruit blossoms, early Clover, and other sources. Unusually large entries have been made in the honey classes, and the present Exhibition will fully illustrate the advantages to be derived from keeping bees in an intelligent and humane manner.

The old-fashioned bee-keeper who lets his bees look after themselves until the months of August or September, and then "takes 'em up," consigning the industrious bees to the brimstone pit, will look on with wonder and astonishment at the great display of comb honey in 1 and 2 lbs. sections, and extracted honey in neatly labelled glass jars, the whole of which has been secured by the third week in June, or even earlier in some districts. The Exhibition will contain an interesting collection of bees confined in observatory hives. No bees will be at large; the most timid may, therefore, visit the Show in perfect safety. No pains have been spared by the Committee to make the proceedings of a thoroughly interesting character. Practical instruction in the art of bee-keeping will be given at intervals on each day, the modern methods of managing bees during the spring, summer, and winter months being fully explained by the most advanced bee-masters. Special addresses will be given by Frank R. Cheshire, Esq., on Saturday, July 7th, on "The Structure of the Bee in Relation to Fertilisation," and on Monday, July 9th, on "Bees as Hybridisers and Fruit-producers, or the Dependence of Orchard Crops upon Bees." These addresses will be given at 4 P.M. each day.

BEEES AND HORTICULTURE.

"IF some of our fruit-growers were to write upon this subject they would place as the title—*Bees versus Horticulture*. Some of our ablest entomologists are persuaded that bees do not always play the rôle of friends to the pomologist.

What I am to say of bees would apply equally well, in some cases, to many other sweet-loving insects, as the wild bees, the wasps, and many of the dipterons, or two-winged flies; only as early in the season other insects are rare, while the honey bees, though less numerous than they are later in the season, are comparatively abundant, even early in the spring months.

My first proposition is, that plants only secrete nectar that they may attract insects. And why this need of insect visits? It is that they may serve as "marriage priests" in the work of fertilising the plants. As is well known, many plants, like the Willows and the Chestnuts, are diœcious. The male element, the pollen, and the female element, the ovules, are on different plants, and so the plants are absolutely dependent upon insects for fertilisation. The pollen attracts the insects to the staminate flowers, while the nectar entices them to visit the pistillate bloom. Some varieties of the Strawberries are so nearly diœcious that this luscious fruit, of which good old Isaac Walton wrote, "Doubtless God might have made a better fruit than the Strawberry, but doubtless God never did," would in case of some varieties be barren except for the kindly ministrations of insects. Other plants are monœcious—that is, stamens and pistils are on the same flower, but the structural peculiarities are such that unless insects were wooed by the coveted nectar fertilisation would be impossible. Many of the plants with irregular flowers, like the Orchids, as Darwin has so admirably shown, are thus entirely dependent upon insects to effect fructification. In many of these plants the structural modifications, which insure fertilisation consequent upon the visits of insects, are wonderfully interesting. These have been dwelt upon at length by Darwin, Gray, Beal, and others, and I will forbear to discuss them further.

But many of our flowers, which are so arranged that the pollen falls easily upon the stigma, like the Clovers, Squashes, and fruit blossoms, fail of full fruitage unless, forsooth, some insect bear the pollen of one flower to the pistil of another. As has been repeatedly demonstrated, if our fruit bloom or that of any of our cucurbitaceous plants be screened from insects the yield of seed and fruit will be but very partial. Professor Beal and our students

have tried some very interesting experiments of this kind with the red Clover. All of the plants under observation were covered with gauze that the conditions might be uniform. Bumble bees were placed under the screens of half of these plants. The insects commenced at once to visit and sip nectar from the Clover blossoms. In the fall the seeds of all the plants were counted, and those from the plants visited by the bumble bees were to those gathered from the plants which were shielded from all insect visits, as 236 : 5. Thus we see why the first crop of red Clover is barren of seed, while the second crop, which comes of bloom visited freely by bumble bees, whose long tongues can reach down to the nectar at the bottom of the long flower tubes, is prolific of seed. This fact led to the importation of bumble bees from England to New Zealand and Australia two years since. There were no bumble bees in Australia and adjacent islands, and the red Clover was found impotent to produce seed. When we have introduced *Apis dorsata* into our American apiaries, or when we have developed *Apis Americana*, with a tongue like that of *Bombus*, seven-sixteenths of an inch long, then we shall be able to raise seed from the first crop of red Clover, as the honey bees, unlike the bumble bees, will be numerous enough early in the season to perform the necessary fertilisation. Alsike Clover, a hybrid between the white and the red, has shorter flower tubes, which makes it a favourite with our honey bees, and so it gives a full crop of seed from the early blossoms.

In all these cases we have proof that Nature objects to close inter-breeding; and thus through her laws the nectar-secreting organs have been evolved, that insects might do the work of cross-fertilisation. As in the case of animals, the bisexual or dioecious plants have been evolved from the hermaphroditic as a higher type; each sex being independent, more vital force can be expended on the sexual elements, and so the individual is the gainer.

It is sometimes contended by farmers that the visits of bees are detrimental to their crops. I have heard farmers say that they had known bees to destroy entirely their crops of Buckwheat by injuring the blossoms. There is no basis of fact for this statement or opinion. Usually bees visit Buckwheat bloom freely. If for any reason the seed fail, as from climatic condition and influence it occasionally will, the bees are charged with the damage, though their whole work, as shown above, has been beneficial, and that only.

It is true, as I have personally observed, that species of our carpenter bees (*Xylocopa*) do pierce the flower tubes of the wild Bergamot, and some of our cultivated flowers, with similar long corolla tubes, that they may gain access to the otherwise inaccessible nectar; the tubes once pierced and our honey bees avail themselves of the opportunity to secure some of the nectar. I have watched long and carefully, but never saw the honey bee making the incisions. As I have never heard of anyone else who has seen them, I feel free to say that it is entirely unlikely that they are ever thus engaged.

My last proposition is, that though bees, in the dearth of nectar secretion, will sip the juices from crushed Grapes and other similar fruits, they rarely ever, I think never, do so unless Nature, some other insect, or some higher animal, has first broken the skin. I have given to bees crushed Grapes from which they would eagerly sip the juices, while other sound Grapes on the same stem—even those like the Delaware, with tenderest skin, which were made to replace the bruised ones—were left entirely undisturbed. I have even shut bees up in an empty hive with Grapes, which latter were safe even though surrounded by so many hungry mouths. I have tried even a more crucial test, and have stopped the entrance of the hive with Grapes, and yet the Grapes were uninjured.

In most cases where bees disturb Grapes some bird or wasp has opened the door to such mischief by previously piercing the skin. Occasionally there is a year when an entire vineyard seems to be sucked dry by bees in a few hours. In such cases the fruit is always very ripe, the weather very hot, and the atmosphere very damp; when it is altogether probable that the juice oozes from fine natural pores, and so lures the bees on to this Bacchanalian feast. I have never had an opportunity to prove this to be true, but from numerous reports I think it the solution of those dreaded onslaughts which have so often brought down severe denunciations upon the bees, and as bitter curses upon their owners.—A. J. COOK (in *The American Apiculturist*).

TRADE CATALOGUES RECEIVED.

J. R. Pearson, Chilwell Nurseries, Nottingham.—*List of Zonal Pelargoniums.*
Stephen Brown, Weston-super-Mare.—*Catalogue of Flower Seeds.*



* * * All correspondence should be directed either to "The Editor" or to "The Publisher." Letters addressed to Dr. Hogg or members of the staff often remain unopened unavoidably. We request that no one will write privately to any of our correspondents, as doing so subjects them to unjustifiable trouble and expense.

Correspondents should not mix up on the same sheet questions relating to Gardening and those on Poultry and Bee subjects, and should never send more than two or three questions at once. All articles intended for insertion should be written on one side of the paper only. We cannot reply to questions through the post, and we do not undertake to return rejected communications.

Books (Youngster).—The two best works of the character you name are Johnson's "Gardeners' Dictionary," price 7s. 6d., or post free from this office 8s. 3d.; and Paxton's "Botanical Dictionary," price 25s., published by Messrs. Bradbury, Agnew & Co., Lombard St., London.

Cucumber House (J. M. K.)—We have not yet obtained the information you require, but hope to do so.

Onions Decaying (J. C.)—Plants in the state of those you have sent are incurable, the maggot has done its destructive work.

Chip Funnets (W. H.)—It is contrary to our rule to recommend dealers through these columns. You will find the information you require in Wright's "Mushrooms for the Million," which can be had post free from this office in return for 7d. in stamps.

Cabbage Lettuce (P. H. W.)—The Lettuce you have sent is a fine example of the Brown Silesian, a very useful variety, which, however, you may not find under that name in catalogues, and you will do well to procure seed from your neighbour who grows it.

Gardenias (A. E. S.)—Gardenias can be procured from any nurseryman who grows stove plants, also in Covent Garden Market. We can scarcely help expressing our surprise by being so frequently asked to recommend dealers, since we have so many times stated that it is contrary to our rules to do so.

Singular Worm (J. W.)—This object did not unfortunately reach us alive, and its shrivelled condition renders it difficult to determine what it is; but it does not appear to be a vegetable feeder. It looks like a small intestinal worm, such as are occasionally dropped by dogs, cats, or even by poultry and other birds. These will sometimes live for hours after quitting the animal in which they have been secreted.

Tea Roses not Flowering (J. H. P.)—We are not able to say why your maiden Teas that grow so freely do not produce flowers satisfactorily, but we have seen many similar instances. We have also seen those strong growths shortened at this period of the year, cutting them down to some promising buds, then start again, and flower profusely in the autumn. You might try the experiment on a few that are making the strongest growth.

Tradescantia virginica (E. D.)—The plants you have received under this name—that is, assuming they are named correctly—are quite hardy. If they have been grown in pots it is for the purpose of packing them so as to travel safely at any period. We have never seen this plant grown in pots in private gardens. Plant them in the border rather deeply, water them, and they will flourish.

Paraffin and Sulphur in Vineries (Reader)—We are obliged by your letter, which we will publish next week. You are quite right; competent and cautious persons may and do use insecticides with advantage, while other persons do far more harm than good by using the same preparations imprudently. Burning sulphur in vineries is undoubtedly a dangerous practice.

Cucumbers not Swelling (E. Jacques)—If your plants are not affected by the disease to which the Cucumber is liable, and of this you make no mention, the most likely cause of the failure is an insufficiency of water at the roots, and possibly too much moisture in the atmosphere. The bed may appear moist on the surface, but the soil may be dry below. You had better ascertain if this is so or not, and if it is pour in water copiously until every particle of soil is thoroughly moistened. You had better also apply top-dressing of rough loam and manure to the beds to encourage the production of surface roots.

Fertiliser for Asparagus (X. Loughgall)—Nitrate of soda is one of the best stimulants you can apply, giving a dressing of from one to two ounces to each square yard, and watering it in if the weather is not showery. You will find applications of liquid manure, such as is obtained from stables, valuable during the summer if the weather should prove dry. Liquid manure, however, should not be given very strong if the plants are small. A peck of soot tied up in old sacking and suspended in a tub containing thirty or forty gallons of water would give you good and safe liquid manure for the beds.

Melons not Swelling (E. E. Moss)—If the blossoms are not fertilised the embryo fruits will not swell. In fine weather, and with sufficient ventilation to dry the pollen, fertilisation is often effected in a natural manner—that is, without manipulative aid; but undoubtedly the safe course is to apply pollen to the fruit-bearing flowers. Even when this is done swelling of the fruit does not always follow, and especially when the plants are very vigorous, and are permitted to ramble in wild luxuriance over the bed or trellis. Immediately fruit-producing blossom is formed, and before it expands, the point of the shoot should be nipped off at the first leaf beyond it, leaving the leaf to develop. The soil should be firm and the roots moist, guarding at the same time against a saturated atmosphere by early ventilation, as with dry soil and much moisture in the air Melons will not set and swell freely. You are not the first, nor even the tenth, person who has complained of the size of the type in this column, therefore we have decided to make a slight alteration, which will enable our replies to be more easily read.

Pegging-down Dahlias (Inquirer)—There is no difficulty whatever in pegging Dahlias close to the ground if they are planted rightly for that purpose,

but there would be a difficulty if they were planted wrongly. We have pegged down double Dahlias for years, and singles are equally amenable to that treatment, and, well managed, produce beautiful masses of flowers. When the plants are intended to be pegged to the soil instead of secured to stakes they must be planted slantingly, just as if they were being "laid in by the heels." If planted upright they cannot be bent down flat to the ground. If yours have been so inserted you may with care and good attention change their position without checking the growth materially. Take out a spadeful of soil from the front of each plant and partially undermine it, then insert the implement under the plant, raise it gently and bend it over, pressing down the roots, watering thoroughly at once and shading if needed. It is not the best plan to peg the plants flat to the ground at first, but they should be secured in an oblique position until they are established and are growing freely. When plants are affixed to the soil they produce growths from almost the entire length of the stems, and these must be pegged on each side, as if securing the side branches of a young tree to a wall.

Grubs Destroying Cauliflowers (I. Welch).—We fear you will have great difficulty in destroying the grubs, whatever they are, without injuring the plants. Ammoniacal liquor from gas works, diluted with six times its volume of water; petroleum at the rate of an ounce of the oil to a gallon of water; or 2 ozs. of hellebore powder made into a paste and then dissolved in a gallon of water, are the most likely remedies we can suggest. Try them, or any of them, experimentally, and oblige us with the results. You will find an application of gas lime dug into the ground in autumn beneficial. This reply is equally for another correspondent who has sought advice on the same subject.

Ornamental Pots (Mrs. Lucas).—Your gardener is certainly wrong. Most kinds of plants will grow as well in glazed ornamental as in rough garden pots. We have referred to this subject before, and may again say that never did we see a more forcible illustration of the importance of being "well fitted in the arts" than when we saw plants unsurpassably well grown rendered repulsive by being in vulgar, highly reddened, common garden pots. They were in the entrance hall of a mansion. That hall was fitly furnished, everything around was congruous, neat, yet elegant. Nothing was discordant but the flower pots, they were rude and offensive both in form and colour; they were unfitting both to the place and to the plants growing in them. Common pottery is suitable to the greenhouse and frame. In the halls



Fig. 121.

or corridors of a mansion the plants should be in porcelain pots. An illustration will enforce what we mean. How deprived of effect would this Caladium appear if in a common flower pot! It quite suffices, however, that the plants be prepared in ordinary pots of a correct size that the pots in which they are grown may be inserted as required into the ornamental pots. No injury is then done to the roots, and it is surprising in what a small pot a plant may be healthily grown if assisted by a full supply of water—liquid manure when suitable to the nature of the plant. Preferable to common clay pots are ornamental latticework covers, or elegant designs which are now worked by the fret saw. Some of the latter are very attractive, and are permissible as substitutes for the more valuable porcelain receptacles.

Pinks (T. B.).—We have not read the remarks to which you direct our attention, nor is it necessary that we should read them, as we do not form our observations on what is published in other papers. If we did it were obviously useless sending specimens to us for our opinion thereon. The flowers you have now sent differ in one rather important particular from the others we examined. Those now before us have stalks sufficiently long to show the branching character of the variety; the others had been cut with scarcely any stalks, and did not show this character. The large-flowered Pink that we have grown for many years does not differ from yours in the flowers, yet it does not usually branch, and it is a few days later than the common white Pink. In that respect—branching—the varieties may be dissimilar, or the difference may

merely be a question of soil. But whether they differ or not does not affect the merits of your variety. It is a good Pink, (much larger and finer than the time-honoured old favourite generally grown in gardens) and well worthy of culture as a border flower; but we are bound to say that the flowers we have seen of Mrs. Sinkins are superior to those you have sent. This, too, may be a question of soil. We cannot tell whether or not yours would be equal to some splendid examples of Mrs. Sinkins now in our office if both had been grown together by Mr. Ware at Tottenham. Mr. Turner may consider your variety better than Mrs. Sinkins, but there is certainly nothing to that effect in the citation from his letter that you have sent; nor does Mr. Cannell imply anything of the kind. We should attach very great weight to the opinion of either of these florists; at present we can but express our own—namely, that good as your flowers are, they are not quite equal to Mrs. Sinkins as we have seen grown both by Mr. Turner and Mr. Ware, therefore the variety last named we must still consider the best white Pink in cultivation. When a better is sent to us we will gladly record the fact; indeed, we should be pleased rather than otherwise to assign Mrs. Sinkins a second place, because we should then soon have a superior variety for our garden.

Peach Leaves Eaten (A Surrey Physician).—We suspect your trees have been attacked by the Peach or Poplar Saw-fly (Teutredo populi). The fly makes its appearance in April, about the time the leaves first come forth. The female lays her eggs at different times, to the number of thirty or forty, which she arranges in rows on the surface of the leaf. The process of hatching occupies only a few days if the weather is fine, and from them a greenish-white grub is produced, and these shortly after spin themselves a web, under which they take shelter. They soon after their birth commence devouring that portion of leaf after leaf which best suits their palate, for, like some other insects, they never consume the entire leaf. Their period of grub existence extends to five or six weeks; they present the appearance of light green grubs with black heads, having three pairs of fore feet and one of hind ones. When full grown they drop to the ground and form for themselves a dark-brown covering or case, and in this they remain an inch or two under the surface of the earth until spring. The best mode of subduing this injurious insect is to gather off the surface soil under the trees, particularly along the bottom of the walls, and have it barbed or burnt. This should invariably be done as soon as the leaves have fallen. The pale yellow eggs may also be easily detected in spring, immediately after they are laid on the points of the young leaves; as they are laid pretty closely together great numbers of them may be thus destroyed. The trees, when much infested by this insect, present the appearance as if they were covered with cobwebs. The specific name, Populi, is not very appropriately given to this insect, which has led Mr. Westwood to remark that there must either be considerable diversity in its habits, feeding as it does at one time on the Poplar and at another on the Peach and Apricot, or the specific name must have been applied improperly. If so, it should be changed to prevent confusion. The fly in general appearance and at a little distance is not unlike the common house-fly, but somewhat larger, and, like all hymenopterous insects, has four wings. The greater part of the body is black, but towards the abdomen whitish square incisive appear, extending from both sides towards the middle in almost parallel lines. The palpi and tibiae are yellow, as are also the feet; thighs black; antennae simple and jointed.

Names of Plants (Mr. Blenkinsop).—We do not undertake, as we have many times stated, to name Roses or varieties of other florists' flowers; besides, the solitary bloom you have sent without foliage is quite insufficient for identification. It resembles Pierre Notting, but we by no means pledge ourselves on the accuracy of the name. (A. B. Shrimpling).—1, Chlorophytum orchidastrum; 2, Begonia insignis; 3, Specimen insufficient; 4, resembles B. fuchsoides, but is inferior in colour; 5, B. Weltoniensis; 6, Hoya bella. (H. C. M.).—33, Melica uniflora; 35, Briza minor, Quaking Grass; 36, Cynosurus cristatus, Crested Dogtail; 37, Lolium perenne, Rye Grass. The one not numbered is Festuca pratensis, Meadow Fescue. (Hortus).—2, Geranium sanguineum; 4, Mertensia virginica; 5, Phlox ovata; 7, Lychnis diurna fl. pleno; 8, Nepeta Mussini; 9, Corydalis lutea. We can only name six specimens at once, and we cannot undertake to name any surplus plants in the following week. (X. Y. Z.).—Phlomis fruticosa. (H. M.).—Hedysarum coronarium, a native of Italy, but quite hardy. The Canterbury Bell, Campanula medium, is a biennial. (J. Smith).—No. 1 is probably Quercus coccinea; 2, a variety of Q. cerris, perhaps the Fulham Oak; but no one can tell with certainty from a couple of leaves and without any information as to the habit and character of the trees.

Bees in Walled Garden (E. B.).—Some of the most productive hives we have seen were in a garden "walled all round."

COVENT GARDEN MARKET.—JUNE 27TH.

OUR market remains the same, with a brisk business doing, Strawberries being in good supply, and Peaches in fair demand. Vegetables plentiful.

FRUIT.

	s.	d.	s.	d.		s.	d.	s.	d.			
Apples.....	½	0	7	0	Grapes	lb.	2	0	5	0		
".....	per	barrel	20	0	40	Lemons.....	case	10	0	20	0	
Apricots.....	box	2	0	2	6	Melons.....	each	3	0	7	0	
Cherries.....	½	sieve	0	0	0	Nectarines....	dozen	6	0	18	0	
Chestnuts.....	bushel	0	0	0	0	Oranges	100	6	0	10	0	
Currants, Black..	½	sieve	0	0	0	0	Peaches	dozen	6	0	18	0
" Red....	½	sieve	0	0	0	0	Pears, kitchen ..	dozen	0	0	0	0
Figs.....	dozen	4	0	6	0	dessert	dozen	0	0	0	0	
Filberts.....	lb.	0	0	0	0	Pine Apples, English	lb.	3	0	4	3	
Cobs.....	100	lb.	0	0	0	Raspberries	lb.	0	0	0	0	
Gooseberries	½	sieve	3	6	4	6	Strawberries	lb.	0	9	1	3

VEGETABLES.

	s.	d.	s.	d.		s.	d.	s.	d.		
Artichokes.....	dozen	2	0	4	0	Mushrooms	punnet	1	0	1	6
Asparagus, English	bundle	3	0	6	0	Mustard & Cress ..	punnet	0	2	0	3
Asparagus, French	bundle	2	0	0	0	Onions.....	bushel	2	6	3	6
Beans, Kidney	100	1	0	0	0	Parsley.....	doz. bunches	3	0	4	0
Beet, Red.....	dozen	1	0	2	0	Parsnips.....	dozen	1	0	2	0
Broccoli.....	bundle	0	9	1	6	Peas.....	quart	1	0	1	3
Cabbage.....	dozen	0	6	1	0	Potatoes, New	lb.	0	2	0	0
Capicums.....	100	1	6	2	0	Potatoes.....	cwt.	6	0	10	0
Carrots.....	bunch	0	4	0	0	Kidney.....	cwt.	6	0	10	0
Cauliflowers ..	dozen	2	0	3	0	Radishes....	doz. bunches	1	0	0	0
Celery.....	bundle	1	6	2	0	Rhubarb.....	bundle	0	4	0	0
Coleworts....	doz. bunches	2	0	4	0	Salsafy.....	bundle	1	0	0	0
Cucumbers.....	each	0	4	0	6	Scorzoneria	bundle	1	6	0	0
Endive.....	dozen	1	0	2	0	Seakale.....	basket	0	0	0	0
Fennel.....	bunch	0	3	0	0	Shallots.....	lb.	0	3	0	0
Herbs.....	bunch	0	2	0	0	Spinach.....	bushel	2	6	3	0
Leeks.....	bunch	0	3	0	4	Tomatoes.....	lb.	1	0	0	0
Lettuces.....	score	1	0	1	6	Turnips.....	bunch	0	2	0	0



POULTRY AND PIGEON CHRONICLE.

CORN-SAVING BY MACHINERY.

(Continued from page 528.)

It must not be supposed that corn can be saved like hay because a little extra heating is not a matter of so much importance in hay, whereas extra heating of a corn stack is injurious. If it is heated entirely by the straw being green and unripe the heat may destroy the germinating power of the grain; yet the straw would be in many cases valuable as sweet and wholesome fodder with a not disagreeable odour; but if heated by water in the sheaves the grain may not only be quite useless for seed and not good for either malting or mealing purposes, but the straw would be valueless for foddering cattle, and only fit for littering the yards, stables, or cattle boxes. Leaving out of sight the chemical changes which result from heating corn and the damage done to grain required for consumption by man or beast, it is sufficiently evident that the germinating power of corn in a moist condition may very easily be destroyed by a comparatively small rise of temperature. In the case of Barley, any injury to the grain greatly diminishes the marketable value; and a sample which would have been, if well saved, of first-class malting quality, may have been lowered to the rank of grinding and mealing Barley by a little haste on the part of the farmer in stacking it, in consequence of heating in the stack.

It is of great importance for us to consider the temperature to which corn in the stack might safely be exposed, and upon this question the following communication, made to the Judges at the Reading meeting, from Mr. Carruthers, the consulting botanist to Royal Agricultural Society, is of the utmost importance, and of very great interest at the present time in connection with our subject of corn-saving. He states, "The temperature which grains of Wheat can endure without being killed has been made the subject of investigation by Sachs. He found that air-dry seeds of Wheat heated to 149° Fahr. for an hour so far retained their vitality that in one experiment 25 per cent. germinated, and in another 98 per cent. But tissues that contain water are more speedily injured by heat than those that are dry, so that seeds of Wheat which had been soaked in water were killed at a temperature of 127° Fahr. Seeds exposed to water vapour would be destroyed at the lower temperature, and also seeds not fully ripe. The injury caused by heat is due to the coagulation of the nitrogenous compounds stored up in the embryo and in the cells containing the starch. These compounds, when the seed begins to germinate, supply the protoplasm, or active living portions of the cells, to the young plants. The life of the nitrogenous compounds is destroyed by coagulation, and though the constituents of the seed may appear on the most careful investigation to be present, this change would entirely destroy the germination. It would be dangerous to raise the temperature of corn stacks to 127° Fahr., for though the coagulation of the nitrogenous compounds may not take place below that point, a considerably lower temperature has an influence on the seed, for the seeds of Wheat will not germinate if the temperature is raised to 104° Fahr. In the view of these facts it appears to me that no injury should result to a corn stack if the temperature is never allowed to exceed 100 Fahr."

In any attempt to save corn in the stack by exhaustion of heat it is necessary to be far more particular in obtaining accurate observations of the heat than in hay-saving, and it is recommended that only the best kind of self-registering thermometer should be used for the purpose. The one sold by Messrs. Negretti & Zambra, called the self-registering maximum thermometer, is recommended and is described as consisting of a tube of mercury with the degrees engraved upon it. Above the mercury the tube is free from air, and just above the bulb is inserted a small piece of glass, which acts as a valve. When the mercury has once passed through the valve and has risen in the tube the upper end of the column registers the maximum temperature. To remove this mercury to the bulb it is necessary to swing the thermometer bulb end downwards, when the column of mercury in the tube will unite with that in the bulb. The thermometer is enclosed in a sheath of glass, so as to protect the division, and the whole is secured into a brass jacket having a slit the whole length of the range of degrees. This jacket is perforated at the bulb, so that the air may

have free access to the mercury. These thermometers are found to answer their purpose, but are rather fragile, and in the hands of a labourer who has no great nicety of touch they soon come to grief without extreme care and caution.

In considering the detail and nicety required in ascertaining the heat in a rick we scarcely think, from the point of view of the practical farmer that the matter is yet decided as to the temperature which corn will bear without injury. We have always found in offering samples of corn for sale that both millers and maltsters are very discriminating, and object to the slightest smell which has tainted the grain, whether by heat or mould. In consequence it will prove very difficult to make sure of a perfect sample if judged by the thermometer only. The lesson taught by the heating of ricks of sheafed corn at the Reading trials induces us to ask why the corn was not put into the rick loose instead of in sheaves; for we say, as the result of our long experience, that it could not possibly have been saved by any exhaustion-of-heat process yet discovered when stacked with thistles and weeds tied up with the sheaves. Still we do hope that in the future, in case of Clover, as it is often found in the Barley crop, the corn being carted loose and partially dried in the field, may be saved frequently by the exhaustion of heat, and thus preserve not only the colour and quality of the Barley when stacked without being wet or damp, but the fodder also, including both straw and Clover. To show how desirable it is to ascertain how this can be done we have only to recollect that when there are Clover or weeds in the Barley the sample of Barley is always greatly injured as malting grain after taking a day or two of rainy weather in swathe. Oats in the same way, when they contain Clover, should not be tied if it is wished to stack them early and reduce heat by machinery, especially if the straw is green and the Oats of a white variety. In fact, when the sheaves of any kind of corn get wet in the centre whilst in the field it takes often a long time before they can be stacked safely without producing a white mould and fusty smell, whether the stack is treated with the exhaust fan or not. The only way that a crop of late Oats can be well saved when required for consumption on the home farm at a very late period and in the western and late districts of the kingdom, is by storing them as ensilage daily as fast as the crop is cut and tied, the Oat sheaves and Clover being reduced to chaff and managed upon the plan as stated by Mr. C. A. Kemble, and fully described by us in this Journal in the number dated the 5th of April, 1883, under the heading of "Ensilage."

In constructing a rick of corn to be operated on, if required for the exhausting of heat, the stack ought to be built in a circular form and not exceed 20 feet in diameter, the corn being in a loose state, for we doubt very much if the attempt to draw a sack stuffed with straw up the centre of a stack composed of sheaves whether it would stand, as we have sometimes seen a stack fall apart whilst building if the centre had not been properly constructed; at all events, if the sheaves were unripe in the straw, or contained water in the centre, either with or without Clover and weeds, no exhaust fan could reduce the heat so as to secure both grain and fodder in perfect condition. These last remarks are intended to apply chiefly to stacks when built in the field where the grain is grown and which we approve, because it is the best economy, the cartage being most easy. In some districts the covering of corn ricks is of much importance, for thatching is costly both in labour and straw, and the question of using galvanised corrugated iron for the purpose may well be considered. On small farms, or where several homesteads are available, the Dutch-barn principle becomes important, because there is an advantage in being able to discontinue carting and storing at short notice in case of heavy storms occurring as compared with the ordinary mode of making stacks in the field. We must, however, conclude with the notice of a building we have seen illustrated as invented by Thomas Pearson & Co., Midland Iron Works, Wolverhampton, being a double or treble range of silos, which when filled with ensilage, with a Dutch-barn iron roofing over, affording a secure space for stacking any kind of grain.

WORK ON THE HOME FARM.

Horse Labour.—This is still employed alternately with hay-carting and tillage work connected with the Turnip land and preparation for the late sowings. The earliest Swedes are showing the second leaf, and are being horse-hoed, as are also the Mangold and Carrot crops, some of which have been singled, and should now be horse-hoed the second time, also immediately hand-hoed, so as to get as much hoeing done as possible, but especially singling, before the harvest commences, as this work being so much more costly when effected during the harvest period. In the southern and eastern districts of the kingdom tillage is still continued for the common Turnip, and alternately with work on the fallows for Wheat. Our practice in the latter instance is to clean the land of couch without very much

labour of rolling and harrowing, preferring to cart the couch away, although not quite free from the soil, to large heaps in the corners of the fields, so that a large quantity of ashes may be available for manuring the land for Wheat, as we consider that 300 bushels of stifle-burnt ashes per acre a sufficient dressing on a fallow preparation, if applied just previous to the last ploughing, to produce forty bushels of Wheat per acre of an average season upon sound loamy soil.

There will be but little waste time for horse labour on the land with average weather, but at all leisure times the horses may be employed in fetching chalk and heaping in readiness to be applied to the land the first opportunity. This is a favourable time for chalk-carting, as it is at all times heavy carriage; but now the roads are firm and the chalk dry it is easier work. In those districts where chalk is not to be obtained the question of liming must not be forgotten, and if lime is stored at the farm in a dry shed it will then be ready when required for the dressing of either pasture or arable land.

The Wheat fallows may be now cross-ploughed at any interval of delay in other tillage work, such as the completion of Turnip-sowing. Many farmers will now be carting manure to heap in the field where required, especially in case of the land intended for the Wheat crop is lying at some distance from the homestead. It is, however, worth consideration whether farmyard dung should be drawn long distances when we have artificial manures of equal efficacy obtainable for dressing land for the Wheat crop; and in such case the advantage of ploughing in green crops, such as second-growth Clover, or on a fallow surface late Vetches and Turnips, may be further considered as saving the long carriage of manure. Upon farms, however, where a large flock of sheep are kept, all green and root crops will be fed off on the land, and thus prepare the land for Wheat; upon heavy land, however, where no sheep are kept the system of ploughing in green crops has long proved a successful practice; but in the opinion of many farmers the keeping of stock sheep is considered a necessity, but we cannot, and do not, acknowledge that as correct, but view the matter as it exists as a fashionable style of farming, only practised by the majority, without any inquiry as to the benefit to be derived as compared with ploughing in green crops for manure, either on very light land or heavy strong soils.

Hand Labour.—Hoeing and singling the root crops will employ men, women, and boys with benefit, if properly directed and superintended. Mowing water meadows, too, will be going on, for in many cases the mowing machines cannot work amongst those narrow beds and numerous water channels and carriers. Hay-making in the meadows and pastures should be pushed forward in order that this kind of work may not interfere with the harvest for early Peas, winter Oats, as the early White Oats will require cutting probably ten days before the general Wheat harvest commences, even in southern and eastern counties.

Cabbages where they have not been on the land may now be planted. The first to be planted is the Champion Cattle Cabbage, and next the Drumhead Savoy, the latter being the best for milch cows. Our plan is to either stretch the land and bury the dung in the centre of each stretch, or otherwise to lay the dung out and rake it into every third or fourth furrow, and set the plants directly over the manure on top of the furrow. Many persons suppose that the planting cannot be done without injury to the growth of the plants in dry weather, which may be true if planted in the usual way with the setting stick. For more than twenty years past adopted the plan of setting with a light spade introduced at an angle of 45°, with women to follow introducing the plants at the back of the spade, the man putting his foot on earth adjoining the plant and passing along. This plan is well adapted either for dry weather or damp, for the plants are buried deeper and feel the moisture from the subsoil immediately. While the land is too deep and adheres to the spade it is better than the setting stick, which kneads the soil round the plant. Again, in case of very large or very small plants they can be buried with regularity in spade-planting, but not so with the setting stick.

Live Stock.—All the young calves may now lie out at night, but it should be upon dry pasture situated above the fog level, which often occurs at night time in the neighbourhood of rivers or brooks, as it is from this cause that many promising young stock animals suffer from the quarter-ill, which is one of the most fatal diseases the cattle breeder has to contend with, but it refers especially to the heifer calves, as the steers are not so susceptible of this complaint. Most of the stock lambs of the various breeds of sheep are now being weaned, and they should be well fed out of hearing of their dams, and upon the same principle as they have been fed previously in advance of the ewes.

REVIEW OF BOOK.

Life on the Farm—Plant Life. By MAXWELL T. MASTERS, M.D., F.R.S. London: Bradbury, Agnew & Co., 1883.

THE set of seven small volumes edited by Mr. J. C. Morton, and called the "Handbook of the Farm Series," is intended to discuss the cultivation of the farm, its live stock, its cultivated plants, farm and estate equipment, the chemistry of agriculture, and the processes of animal and vegetable life. The present volume, which deals with the phenomena of plant life, has been entrusted to Dr. Masters, and could not have been placed in better hands. The main facts and processes of vegetable physi-

ology are briefly but clearly described, the chief stress being laid on those points which are of special use to the farmer. Where necessary these are illustrated by the results of actual experiments. Thus, under the head of the Evaporation of Water from the Leaves of Plants, and, again, under that of Manures, copious reference is made to the long series of experiments carried on by Sir J. B. Lawes and Dr. Gilbert at Rothamsted.

We may take as an illustration of Dr. Masters' mode of treatment, his remarks on the Principles of Manuring and on the Apparent Power of Selection of Plants. The nitrogenous and the saline substances, he says, are taken from the soil, used up in the plant, and removed in the crop. The annual produce of hay on unmanured land at Rothamsted is about 23 cwt. per acre over an average of twenty-five years, the range of variation, according to season, being from 8 to 39 cwt. The most highly manured plot has yielded for the same period an average of 64 cwt. of hay per acre, varying in different years from 40 to 80 cwt. The decline, not only of produce, but also in mineral and nitrogenous ingredients in the soil, has been most marked in the continuously unmanured plots at Rothamsted. To insure continued fertility therefore, and to obviate exhaustion, some restitution must be made; and this is effected by the addition at the right time, in the right condition, and in the right quantities, of an appropriate manure, or the exhaustion may be compensated by suitable rotation. But it has been found experimentally that different crops will extract the soluble materials out of the same soil in different proportions. Nor is the chemical constitution of the plant a guide to the description and amount of manurial constituents which will be most effective. Thus Wheat removes more phosphoric acid from the soil than does Barley; but, notwithstanding this, the application of phosphates to the soil is more beneficial to Barley than to Wheat. Cereal crops and Grasses generally are specially benefited by nitrogenous manures, though they contain relatively little nitrogen as compared with Clover and other leguminous crops, which are nevertheless not particularly benefited by nitrogenous manures. Beetroot and Potatoes, again, which contain a considerable proportion of potash, are not proportionately benefited by the application of potash manures, though they are to some extent. The theoretical explanation of these facts is that by virtue of the varying osmotic and digestive powers of the plant particular species take what they want and take it when they want it, and are not induced to take more by the addition of larger supplies. The practical conclusion is that it is not safe for the farmer to trust too implicitly to the results obtained by the chemist in the laboratory, and that it is not necessary to supply to the land all the constituents that have been removed from it, or that would be contained in the crops it is wished to grow, but that we should apply all or some, more or less, according to circumstances. On these and other points the practical agriculturist will find a safe guide in this little volume.

OUR LETTER BOX.

Cow Unsatisfactory (*J. P.*).—When a cow fails to bring a calf it is well to try another bull, at the same time mix a little barley meal with the other food you give; if with green fodder cut a little into chaff to mix with meal. There is, however, frequently a constitutional tendency towards barrenness, and especially when the cows continue to make flesh and fat whilst giving milk. If change of food and mating the cow with another animal does not succeed in producing a calf the cow had better be sold as soon as her milk diminishes in quantity so as to be unprofitable.

METEOROLOGICAL OBSERVATIONS.

CAMDEN SQUARE, LONDON.

Lat. 51° 32' 40" N.; Long. 0° 8' 0" W.; Altitude, 111 feet.

DATE.	9 A.M.					IN THE DAY.				Rain
	Barometer at 32° and Sea Level	Hygrometer.		Direction of Wind.	Temp. of Soil at 1 foot.	Shade Temperature.		Radiation Temperature.		
		Dry.	Wet.			Max.	Min.	In sun.	On grass.	
1883.										
June.										
Sun. 17	29.935	56.2	48.9	W.	78.0	62.9	41.3	110.1	38.1	0.60
Mon. 18	29.971	58.4	52.4	N.	77.8	63.8	46.9	116.5	42.7	—
Tues. 19	29.923	54.2	51.2	N.W.	78.7	67.2	48.6	111.5	48.4	0.015
Wed. 20	29.830	58.8	52.4	E.	78.6	62.5	49.3	100.7	45.2	0.245
Thurs. 21	29.894	59.8	55.5	E.	58.0	64.7	52.3	103.3	52.4	0.068
Friday 22	30.037	57.3	51.7	N.W.	57.4	67.7	49.7	119.4	48.7	0.012
Satur. 23	30.034	59.4	53.5	S.W.	57.9	72.8	52.6	115.2	48.6	—
	29.951	57.7	52.2			66.7	48.7	109.5	46.3	0.400

REMARKS.

17th.—Cold and showery.
 18th.—Fine throughout.
 19th.—Fine morning; overcast afternoon; heavy shower 4.30 P.M.
 20th.—Cold and showery; sunshine at intervals.
 21st.—Dull and overcast; a very sharp peal of thunder at 3h. 1m. P.M., when a flash of lightning damaged two houses in Kentish Town.
 22nd.—Fair; occasionally dull, with slight rains.
 23rd.—Fine; overcast at times.
 A variable and rather cooler week, with several slight showers.—G. J. SYMONS.

70

