

★ UMass/AMHERST ★

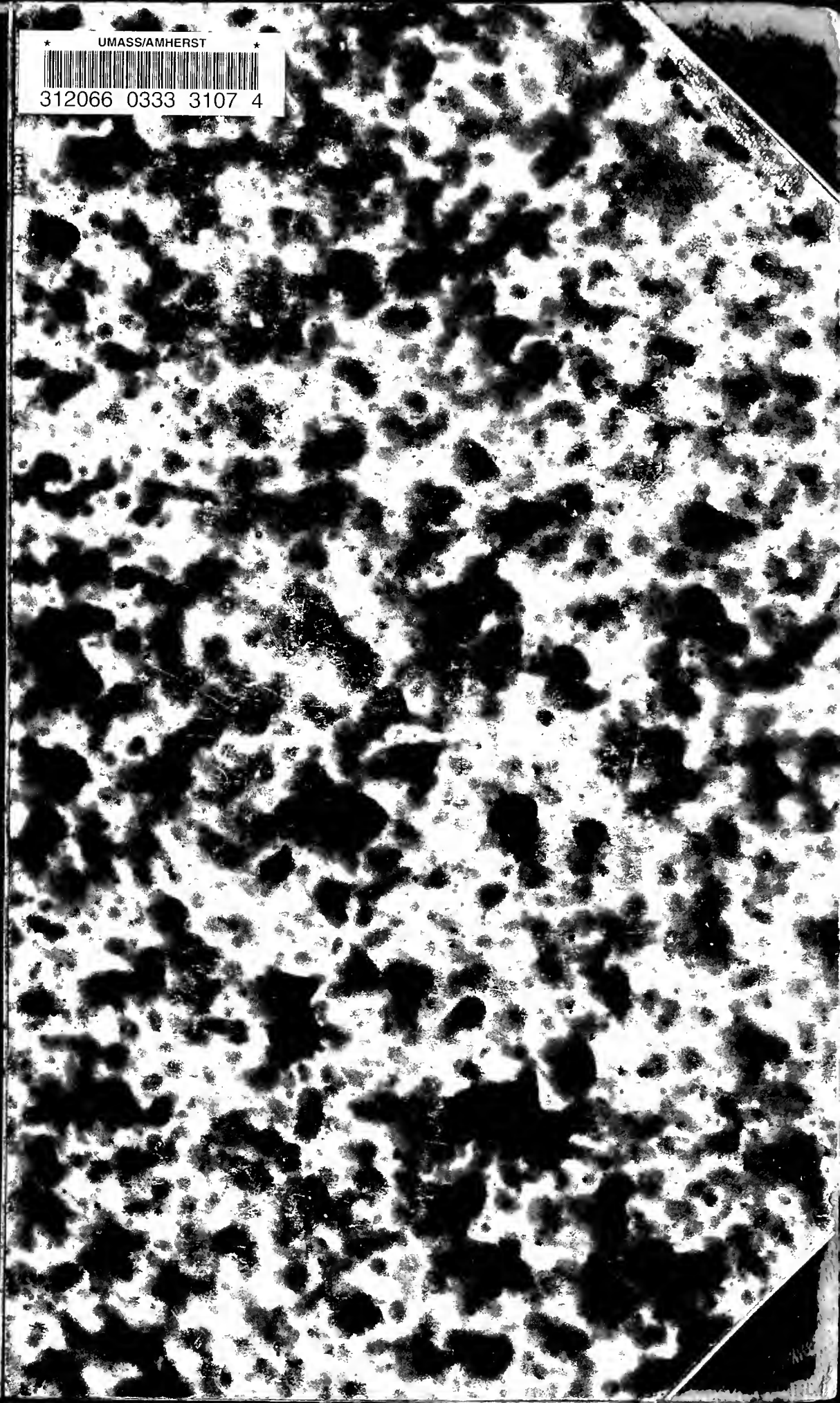

312066 0333 3107 4



Handwritten notes at top left of page.

LIBRARY
OF THE

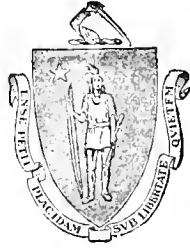

MASSACHUSETTS
AGRICULTURAL
COLLEGE

NO. 5660 DATE 6.1.7

SOURCE J. H. W. French

C Per
J8265 ^{no. 11} _{v. 6}

This book may be kept out

TWO WEEKS

only, and is subject to a fine of TWO
CENTS a day thereafter. It will be due on
the day indicated below.

NOV 1 1911
LIBRARY OF THE
UNIVERSITY OF CALIFORNIA
BERKELEY

Handwritten text, possibly a signature or initials, located in the bottom right corner of the page.

THE
JOURNAL OF HORTICULTURE,
COTTAGE GARDENER,
AND
COUNTRY GENTLEMAN.

A MAGAZINE OF GARDENING, RURAL AND DOMESTIC ECONOMY, BOTANY AND
NATURAL HISTORY.

CONDUCTED BY

GEORGE W. JOHNSON, F.R.H.S., AND ROBERT HOGG, LL.D.

THE KITCHEN GARDENS, by Mr. J. Robson, Gardener to Viscount Holmesdale, M.P., Linton Park; and Mr. T. Weaver, Gardener to the Warden of Winchester College.

THE FLOWER GARDEN, by Mr. D. Thomson, Archerfield Gardens; and Mr. G. Abbey, Stansty Hall.

STOVE, GREENHOUSE, AND WINDOW GARDEN, by Mr. R. Fish, Gardener to Colonel Sowerby, Putteridge Bury, near Luton.

FLORISTS' FLOWERS AND FLORICULTURE, by the Rev. H. H. Donbrain.

GARDENING CALENDAR, by Mr. William Keane.

POULTRY-KEEPING, by Mr. J. Baily, Rev. W. W. Wingfield, E. Hewitt, Esq., and other well-known contributors.

BEE-KEEPING, by H. Taylor, Esq.; T. W. Woodbury, Esq.; "B. & W.;" and Mr. S. Bevan Fox.

HOUSEHOLD ARTS, by the Authoress of "My Flowers," and others.



VOLUME VI., NEW SERIES.

VOL. XXXI., OLD SERIES.

LONDON:

PUBLISHED FOR THE PROPRIETORS, 171, FLEET STREET.

1864.

J. H. ...

LONDON:
PRINTED AT THE JOURNAL OF HORTICULTURE OFFICE,
171, FLEET STREET.

LIBRARY
UNIVERSITY OF
MASSACHUSETTS
AMHERST, MASS.

TO OUR READERS.

“You are repotted. Take care you don't get overpotted!”

This was the address, not of our old friend Miss PENELOPE POMEROY, but of an old spademan who thinks he has known us long enough to venture to be impertinent.

We *have* been “repotted;” but, to continue the simile, it has not been a large shift—it is only from a No. 162 to a No. 171; and the shift was not made until our increased growth had rendered it absolutely necessary.

As to being “overpotted”—which our old curmudgeon friend meant as a professionally-expressed warning not to occupy larger offices than we need—we have a just pride, and a hearty gratitude, whilst we record again that you, our Readers, do not permit that fear to restrain us.

“Overpotting,” to resume the simile, results in the production of an excess of leaves; but our conservatory—for such we may call our warehouse—reveals no such excess. We go on increasing our Numbers printed, but our Numbers remaining—our excess of leaves—is nowhere apparent. We fear that Miss POMEROY would be down upon us if we said that we are exactly potted as we ought to be, and that this is shown by our being very fruitful—extraordinarily fruitful indeed—inasmuch as that you, our Readers, as well as ourselves, are quite contented with the produce.

To maintain that fruitfulness will be our continued effort; and we promise that, as in times past, so in times to come, no fear of cost, no fear of authority, will render us recreant from our motto—

“FOR GARDENING AND GARDENERS.”

INDEX.

AMARLENSHIRE POULTRY SHOW, 45

Accrington Poultry Show, 305
 Achimenes, *Purpurea elegans*, Leopard, 57
 Acorns for planting, 21
Acrocoma sc. crocarpa, 201
Ada aurantiaca, 235
Adenantha pavonina, 202
Ecbmea distichantha, 455
 Alexandra Park Horticultural Show, 169
Alocasia metallica deficient in leaves, 235
Alstrœmeria Caldasii, 397
 Alyssum seedlings, 423
Amaranthus melancolicus ruber, 208; culture, 355
Amaryllis—culture, 49, 72; list of, 74; formosissima, 337
 Amateurs, a word to, 401
 American domestic fowls, 203
 American blight, 462
 Anemones in pots failing, 321
 Annuals—with *Saponaria calabrica*, 82; for bedding, 113, 210; half-hardy, 166, 192; hardy, culture, 225; list of, 226; growing tender, 270
 Ants in hothouse, 271
 Aphis destroying, 355, 452
 Apples cracking, 133
 Apricot blossoms falling, 256
 Apricots failing, 337
 Arabis, varieties of, 245
Aristolochia leuconera, 56
 Arnott's stove—instance of inefficiency, 155; and hot water, 172
 Art, bazaar in aid of female school of, 349
 Asparagus—culture and forcing, 20; beds, managing old, 117; planting, 335
 Asphalt walks, 81, 482
 Atherton Poultry Show, 289
Athyrium Filix-fœmina variety, 479
 Aubrietia sowing, 388
 Aucuba, the female, 211
 Australian Poultry Show, 322
 Azalea Forget-me-not, 397
 Azaleas—in heat after blooming, 200; after blooming, 222; growing prematurely, 321
 BALM, VARIEGATED, 6
 Balsams, compost for, 371
 Bantam roopy, 465
 Bantams—breeding Game, 68; prizes for, 87; size of, 124; eggs of Sebright, 114; breeding dock-winged, 206; for exhibition, 258; Buff-coloured, 324
 Barkeria Skinneri superba, 235
 Basket plant, 235
 Baskets—flowering plants for, 182; hanging, 195; plants for veranah, 483
 Bath and West of England Poultry Show, 462, 484
 Beas v. Gooseberry caterpillar, 379
 Bedding plants—propagating, 80; turning out, 240; shifting, 270; without artificial heat, 418, 477; and mixed borders, 476
 Bee-keeping—practical, 184; in Devon, 205
 Bees—foul brood, 25, 47, 67, 87, 105, 124, 141, 163, 186, 241, 273, 323, 374, 445; Australian, 46; keeping in the olden style, 27; as regicides, 67; flowers for, 68; first load of pollen; do mice eat bees? 106; Bees—season commenced in Scotland, 124; acclimatisation, 142, 164; mice eat them; travelling by rail; early pollen-gathering; swarming extraordinary; premature drone production, 143; Mignonette for, 144; supering stocks; autumnal feeding, 164; Woodbury-hives, 164; removing; symptoms of dysentery; East Indian, 194; in Lanarkshire, 205; chilled brood, 224, 242; last season in Salop, 224; drone-breeding queens, 242; stocking an observatory-hive, 257, 274; water for, 257; raid-, 258; including to work in supers, in Oxfordshire, honey-dew, 274; early breeding, 290, 308; Dahlia flowers for, 290; foul brood, and what has been written about it, 306; uniting weak stocks, 307; artificial swarms, 308, 322, 339, 357, 373, 425, 484; uniting, 308; in roof, 308; why they work in the dark, 324; artificial combs; chilled brood and wax-moth larvæ expelled, swarm in place of stock, transferring, 340, 358, 445; swarm without drones, mode of driving, 372; fixing combs in box-hives, accepting a foreign queen, 373, 408; early swarms, 389, 390; artificial swarms; death of Ligurian, premature drone expulsion, gloves for apiarists, 390; driving and preventing swarming, 407, 408; conversion of bar-hives into frame-hives, Ligurian in Australia, gloves, 408; artificial combs, early honey, in Yorkshire, 426; artificial swarm deserting hive, 443; artificials warming, 444; do young queens breed drones? 444, 486; fed on unboiled syrup, 446; after hiving, 446; do they prey on fruit? 455; supering swarms, 466; parasite, 466; young queens, in Suffolk, 485; extraordinary Ligurian swarms, second swarms, 486
 Beet, Red, for bedding, 208
 Beetles, destroying in orchard-house, 101
 Begonia—leaves cracking, 221; Manni, 235
 Beverley Poultry Show, 424
 Birmingham Poultry Show, irregular admission, Capt. Heaton, Mr. Hindson, &c., 23; irregularities, 44; Mr. Williams's Game fowls at, 63; difficulties, 160, 161
 Birmingham Rose Show, 380
 Blackberries, Lawton & Dorchester, 139
 Blossom thinning, 254
 Boiler—wrongly fixed, 193; heating a cylindrical, 222; setting tubular, 255; for small fernery, 337
 Boilers—for garden structures, 56; saddle, setting, 96; proposed, 103, 139; requiring no setting, 139; consumption of fuel, 287
 Bomarea multiflora, 398
 Books for a gardener's library, 355
 Border planting, 178
 Botanic (Royal) Society's Shows, 229, 280, 295, 327, 376, 393, 429, 451; florists' flowers at, 293, 344
 Botanical specimens, drying, 271
 Bottom heat, 21; from hot-water pipes, 55; deficient, 201, 222, 305
 Bougainvillea speciosa culture, 138
 "Bouquet, the Illustrated," 236
 Bouquets, 467
 Bouvardia—triphylia culture, 138; longiflora culture, 431
 Brubma Footra prizes at Birmingham, 442
 Bridge Hill, Belper, 40
 Brisbane—gardening at, 433; Botanic Garden, 478
 Brosimum Anblethi, 201
 Brussels Horticultural Exhibition, 310; Congress, 383
 Buckingham, gardens worth seeing, 19
 Buds—falling prematurely, 107; preserving from birds, 157
 Buff Cochins, Captain Heaton's, 48
 Bulbs—in pots, 235; and bedders together, 255
 Bull's Nursery, Chelsea, 262
 Butter not forming, 48
 Buyers and sellers, 44
 CABBAGE, HOW TO CUT, 491
 Cabbageworts, their merit, 253
 Cactaceæ culture, 69, 94
 Caladium roots decaying, 82
 Calampelis scabra, 370
 Calceolarias—bedding, 75, 132; wintering hedging, 171; shrubby, culture, 96, 174; wintering and propagating hedging, 194; white bedding, 216; in cold pit, 271; for pot culture, 304; shrubby, 424
 Calla æthiopia culture, 304
 Camellias—cutting back, 21, 102; Sarah Frost, 57; bloom not expanding, 62, 120; buds falling, 82, 107, 138; leaves discoloured, 82; leaves falling, 102; potting, 182; Conte de Gomer, 397
 Canary wheezing, 308
 Canaries, teaching, 340
 Cannas, some handsome-foliaged, 423
 Cansera Parishii, 155
 Capar bush, 196
 Cape Gooseberry, 287
 Carnation seedlings, protecting from sparrows, 303
 Carrots, keeping, 182
 Cattleya Lindleyana, 455
 Cauliflower culture, 386
 Cedar seeds sowing, 440
 Celery—in winter, 60; leafstalk rooting, 255; culture, 480
 Celosia culture, 256, 342
 Centaurea candidissima from seed, 321
 Cerastium tomentosum and Biebersteini culture, 355
 Chain border, 304
 Chamber strops, 138
 Charcoal for manure, 255
 Cheiranthus sowing, 388
 Cherries under glass, 419
 Chickens—management of early, 222; lice on, 242; pecking their feet, 274; dead in the shell, 374; destroyed by crows and rats, 466
 Chitteprata, 466
 Christ's Thorn, 160
 Chrysanthemum cuttings and plants, 271
 Chrysanthemums—twelve show, 21; Lord Clyde and St. Margaret, 153; stopping, 200; (Pompon) Firefly, Vida, and Lizzie Holmea, 235; (large) Prince Alfred, and Princess of Wales, 236; of last season, 246; dwarf, 321
 Cinerarias—not blooming, 74; blind, 103; leaves injured, 241; sowing, 287; for seed, 304; Flower of the Day, Rembrandt, Eliza, 455
 Circassian Beans, 202
 Clematis Fortunei, 450
 Clerodendron seedlings, 222
 Clianthus—Dampieri seedlings, 121; seed sowing, 287
 Climata affected by trees, 455
 Cliveden, 416
 Clover stems, 103
 Coccospisididicolor, 235
 Cochinchinas—extra prizes for Partridge, 66; combs black, 106; food for, 144; Partridge cock's tail, 144; breeding, 164; white powder on legs, 164; eggs not hatching, 186; extra prize for Buff, 372; cock leg weak, 374; corns in, 408
 Cocksoombs—culture, 342; compost for, 371
 Cocoa-nut fibre refuse, 13; for Ferns, 354
 Colons Verschaffelti, 208
 Colours, harmony of applied to flower gardening, 395
 Colours, harmonising and contrasting, 71
 Collecta bictoniensis, 477
 Composts, materials for, 12
 Concrete, materials for, 284
 Conservatory—construction, 120; on north aspect, 441
 Cookery for the working classes, 206
 Copper for garden structures, 112
 Cordon training, 381
 Cork Poultry Show, 66
 Coronilla glauca culture, 103
 Cotton Plant in England, 363
 Covent Garden Market, 21, 43, 62, 81, 102, 119, 137, 158, 182, 209, 221, 249, 255, 270, 280, 303, 321, 336, 354, 370, 387, 404, 423, 440, 461, 482
 Cow-house vinery, 222
 Cow, produce from an Alderney, 242
 Crève Cœurs, derivation of name, 124
 Crickets on Vine shoots, 101
 Crocus not flowering, 103
 Crocuses, taking up, 388
 Crowing an annoyance, 466
 Crystal Palace, 366; Flower Show, 393; Bird Show, 162; florists' flowers at, 414; bedding out at, 420; Rose Show, 472
 Conifer seeds, sowing Japanese, 159
 Cucumber and Melon-house constructing, 159; heating, 160
 Cucumbers—useful sorts, 43; in winter, 60; early, 63; in pots, 72; culture in pots, 91; and Melons in pots without bottom-heat, 133; with Violes, 138; training, 222; the longest, 288; gum-diseased, 321; for winter, 388; culture of, 441; withering when young, 442; shrivelling, 461
 Currant from Malta, 43
 Custard Apple, 193
 Cuttings, management when rooted, 145; of bedding-out plants, 181
 Cyanophyllum magnificum—propagating, 159; culture, 201
 Cyclamen—seedlings, 62; persicum in pots failing, 321; seedling culture, 441
 Cypridians, North American, culture, 355
 DAHLIA—PRINCESS ALEXANDRA, 317; flowers varying in colour, 420
 Dahlias—starting, 43; list of pompon, 139; propagating, 239
 Dairy produce and management, 185
 Daisies failing, 256
 Daugstein, 9
 Daphne odora diseased, 200
 Darlington Poultry Show, entries at, 21

Bees—season commenced in Scotland, 124; acclimatisation, 142, 164; mice eat them; travelling by rail; early pollen-gathering; swarming extraordinary; premature drone production, 143; Mignonette for, 144; supering stocks; autumnal feeding, 164; Woodbury-hives, 164; removing; symptoms of dysentery; East Indian, 194; in Lanarkshire, 205; chilled brood, 224, 242; last season in Salop, 224; drone-breeding queens, 242; stocking an observatory-hive, 257, 274; water for, 257; raid-, 258; including to work in supers, in Oxfordshire, honey-dew, 274; early breeding, 290, 308; Dahlia flowers for, 290; foul brood, and what has been written about it, 306; uniting weak stocks, 307; artificial swarms, 308, 322, 339, 357, 373, 425, 484; uniting, 308; in roof, 308; why they work in the dark, 324; artificial combs; chilled brood and wax-moth larvæ expelled, swarm in place of stock, transferring, 340, 358, 445; swarm without drones, mode of driving, 372; fixing combs in box-hives, accepting a foreign queen, 373, 408; early swarms, 389, 390; artificial swarms; death of Ligurian, premature drone expulsion, gloves for apiarists, 390; driving and preventing swarming, 407, 408; conversion of bar-hives into frame-hives, Ligurian in Australia, gloves, 408; artificial combs, early honey, in Yorkshire, 426; artificial swarm deserting hive, 443; artificials warming, 444; do young queens breed drones? 444, 486; fed on unboiled syrup, 446; after hiving, 446; do they prey on fruit? 455; supering swarms, 466; parasite, 466; young queens, in Suffolk, 485; extraordinary Ligurian swarms, second swarms, 486
 Beet, Red, for bedding, 208
 Beetles, destroying in orchard-house, 101
 Begonia—leaves cracking, 221; Manni, 235
 Beverley Poultry Show, 424
 Birmingham Poultry Show, irregular admission, Capt. Heaton, Mr. Hindson, &c., 23; irregularities, 44; Mr. Williams's Game fowls at, 63; difficulties, 160, 161
 Birmingham Rose Show, 380
 Blackberries, Lawton & Dorchester, 139
 Blossom thinning, 254
 Boiler—wrongly fixed, 193; heating a cylindrical, 222; setting tubular, 255; for small fernery, 337
 Boilers—for garden structures, 56; saddle, setting, 96; proposed, 103, 139; requiring no setting, 139; consumption of fuel, 287
 Bomarea multiflora, 398
 Books for a gardener's library, 355
 Border planting, 178
 Botanic (Royal) Society's Shows, 229, 280, 295, 327, 376, 393, 429, 451; florists' flowers at, 293, 344
 Botanical specimens, drying, 271
 Bottom heat, 21; from hot-water pipes, 55; deficient, 201, 222, 305
 Bougainvillea speciosa culture, 138
 "Bouquet, the Illustrated," 236
 Bouquets, 467
 Bouvardia—triphylia culture, 138; longiflora culture, 431
 Brubma Footra prizes at Birmingham, 442
 Bridge Hill, Belper, 40
 Brisbane—gardening at, 433; Botanic Garden, 478
 Brosimum Anblethi, 201
 Brussels Horticultural Exhibition, 310; Congress, 383
 Buckingham, gardens worth seeing, 19
 Buds—falling prematurely, 107; preserving from birds, 157
 Buff Cochins, Captain Heaton's, 48
 Bulbs—in pots, 235; and bedders together, 255
 Bull's Nursery, Chelsea, 262
 Butter not forming, 48
 Buyers and sellers, 44
 CABBAGE, HOW TO CUT, 491
 Cabbageworts, their merit, 253
 Cactaceæ culture, 69, 94
 Caladium roots decaying, 82
 Calampelis scabra, 370
 Calceolarias—bedding, 75, 132; wintering hedging, 171; shrubby, culture, 96, 174; wintering and propagating hedging, 194; white bedding, 216; in cold pit, 271; for pot culture, 304; shrubby, 424
 Calla æthiopia culture, 304
 Camellias—cutting back, 21, 102; Sarah Frost, 57; bloom not expanding, 62, 120; buds falling, 82, 107, 138; leaves discoloured, 82; leaves falling, 102; potting, 182; Conte de Gomer, 397
 Canary wheezing, 308
 Canaries, teaching, 340
 Cannas, some handsome-foliaged, 423
 Cansera Parishii, 155
 Capar bush, 196
 Cape Gooseberry, 287
 Carnation seedlings, protecting from sparrows, 303
 Carrots, keeping, 182
 Cattleya Lindleyana, 455
 Cauliflower culture, 386
 Cedar seeds sowing, 440
 Celery—in winter, 60; leafstalk rooting, 255; culture, 480
 Celosia culture, 256, 342
 Centaurea candidissima from seed, 321
 Cerastium tomentosum and Biebersteini culture, 355
 Chain border, 304
 Chamber strops, 138
 Charcoal for manure, 255
 Cheiranthus sowing, 388
 Cherries under glass, 419
 Chickens—management of early, 222; lice on, 242; pecking their feet, 274; dead in the shell, 374; destroyed by crows and rats, 466
 Chitteprata, 466
 Christ's Thorn, 160
 Chrysanthemum cuttings and plants, 271
 Chrysanthemums—twelve show, 21; Lord Clyde and St. Margaret, 153; stopping, 200; (Pompon) Firefly, Vida, and Lizzie Holmea, 235; (large) Prince Alfred, and Princess of Wales, 236; of last season, 246; dwarf, 321
 Cinerarias—not blooming, 74; blind, 103; leaves injured, 241; sowing, 287; for seed, 304; Flower of the Day, Rembrandt, Eliza, 455
 Circassian Beans, 202
 Clematis Fortunei, 450
 Clerodendron seedlings, 222
 Clianthus—Dampieri seedlings, 121; seed sowing, 287
 Climata affected by trees, 455
 Cliveden, 416
 Clover stems, 103
 Coccospisididicolor, 235
 Cochinchinas—extra prizes for Partridge, 66; combs black, 106; food for, 144; Partridge cock's tail, 144; breeding, 164; white powder on legs, 164; eggs not hatching, 186; extra prize for Buff, 372; cock leg weak, 374; corns in, 408
 Cocksoombs—culture, 342; compost for, 371
 Cocoa-nut fibre refuse, 13; for Ferns, 354
 Colons Verschaffelti, 208
 Colours, harmony of applied to flower gardening, 395
 Colours, harmonising and contrasting, 71
 Collecta bictoniensis, 477
 Composts, materials for, 12
 Concrete, materials for, 284
 Conservatory—construction, 120; on north aspect, 441
 Cookery for the working classes, 206
 Copper for garden structures, 112
 Cordon training, 381
 Cork Poultry Show, 66
 Coronilla glauca culture, 103
 Cotton Plant in England, 363
 Covent Garden Market, 21, 43, 62, 81, 102, 119, 137, 158, 182, 209, 221, 249, 255, 270, 280, 303, 321, 336, 354, 370, 387, 404, 423, 440, 461, 482
 Cow-house vinery, 222
 Cow, produce from an Alderney, 242
 Crève Cœurs, derivation of name, 124
 Crickets on Vine shoots, 101
 Crocus not flowering, 103
 Crocuses, taking up, 388
 Crowing an annoyance, 466
 Crystal Palace, 366; Flower Show, 393; Bird Show, 162; florists' flowers at, 414; bedding out at, 420; Rose Show, 472
 Conifer seeds, sowing Japanese, 159
 Cucumber and Melon-house constructing, 159; heating, 160
 Cucumbers—useful sorts, 43; in winter, 60; early, 63; in pots, 72; culture in pots, 91; and Melons in pots without bottom-heat, 133; with Violes, 138; training, 222; the longest, 288; gum-diseased, 321; for winter, 388; culture of, 441; withering when young, 442; shrivelling, 461
 Currant from Malta, 43
 Custard Apple, 193
 Cuttings, management when rooted, 145; of bedding-out plants, 181
 Cyanophyllum magnificum—propagating, 159; culture, 201
 Cyclamen—seedlings, 62; persicum in pots failing, 321; seedling culture, 441
 Cypridians, North American, culture, 355
 DAHLIA—PRINCESS ALEXANDRA, 317; flowers varying in colour, 420
 Dahlias—starting, 43; list of pompon, 139; propagating, 239
 Dairy produce and management, 185
 Daisies failing, 256
 Daugstein, 9
 Daphne odora diseased, 200
 Darlington Poultry Show, entries at, 21

Bees—season commenced in Scotland, 124; acclimatisation, 142, 164; mice eat them; travelling by rail; early pollen-gathering; swarming extraordinary; premature drone production, 143; Mignonette for, 144; supering stocks; autumnal feeding, 164; Woodbury-hives, 164; removing; symptoms of dysentery; East Indian, 194; in Lanarkshire, 205; chilled brood, 224, 242; last season in Salop, 224; drone-breeding queens, 242; stocking an observatory-hive, 257, 274; water for, 257; raid-, 258; including to work in supers, in Oxfordshire, honey-dew, 274; early breeding, 290, 308; Dahlia flowers for, 290; foul brood, and what has been written about it, 306; uniting weak stocks, 307; artificial swarms, 308, 322, 339, 357, 373, 425, 484; uniting, 308; in roof, 308; why they work in the dark, 324; artificial combs; chilled brood and wax-moth larvæ expelled, swarm in place of stock, transferring, 340, 358, 445; swarm without drones, mode of driving, 372; fixing combs in box-hives, accepting a foreign queen, 373, 408; early swarms, 389, 390; artificial swarms; death of Ligurian, premature drone expulsion, gloves for apiarists, 390; driving and preventing swarming, 407, 408; conversion of bar-hives into frame-hives, Ligurian in Australia, gloves, 408; artificial combs, early honey, in Yorkshire, 426; artificial swarm deserting hive, 443; artificials warming, 444; do young queens breed drones? 444, 486; fed on unboiled syrup, 446; after hiving, 446; do they prey on fruit? 455; supering swarms, 466; parasite, 466; young queens, in Suffolk, 485; extraordinary Ligurian swarms, second swarms, 486
 Beet, Red, for bedding, 208
 Beetles, destroying in orchard-house, 101
 Begonia—leaves cracking, 221; Manni, 235
 Beverley Poultry Show, 424
 Birmingham Poultry Show, irregular admission, Capt. Heaton, Mr. Hindson, &c., 23; irregularities, 44; Mr. Williams's Game fowls at, 63; difficulties, 160, 161
 Birmingham Rose Show, 380
 Blackberries, Lawton & Dorchester, 139
 Blossom thinning, 254
 Boiler—wrongly fixed, 193; heating a cylindrical, 222; setting tubular, 255; for small fernery, 337
 Boilers—for garden structures, 56; saddle, setting, 96; proposed, 103, 139; requiring no setting, 139; consumption of fuel, 287
 Bomarea multiflora, 398
 Books for a gardener's library, 355
 Border planting, 178
 Botanic (Royal) Society's Shows, 229, 280, 295, 327, 376, 393, 429, 451; florists' flowers at, 293, 344
 Botanical specimens, drying, 271
 Bottom heat, 21; from hot-water pipes, 55; deficient, 201, 222, 305
 Bougainvillea speciosa culture, 138
 "Bouquet, the Illustrated," 236
 Bouquets, 467
 Bouvardia—triphylia culture, 138; longiflora culture, 431
 Brubma Footra prizes at Birmingham, 442
 Bridge Hill, Belper, 40
 Brisbane—gardening at, 433; Botanic Garden, 478
 Brosimum Anblethi, 201
 Brussels Horticultural Exhibition, 310; Congress, 383
 Buckingham, gardens worth seeing, 19
 Buds—falling prematurely, 107; preserving from birds, 157
 Buff Cochins, Captain Heaton's, 48
 Bulbs—in pots, 235; and bedders together, 255
 Bull's Nursery, Chelsea, 262
 Butter not forming, 48
 Buyers and sellers, 44
 CABBAGE, HOW TO CUT, 491
 Cabbageworts, their merit, 253
 Cactaceæ culture, 69, 94
 Caladium roots decaying, 82
 Calampelis scabra, 370
 Calceolarias—bedding, 75, 132; wintering hedging, 171; shrubby, culture, 96, 174; wintering and propagating hedging, 194; white bedding, 216; in cold pit, 271; for pot culture, 304; shrubby, 424
 Calla æthiopia culture, 304
 Camellias—cutting back, 21, 102; Sarah Frost, 57; bloom not expanding, 62, 120; buds falling, 82, 107, 138; leaves discoloured, 82; leaves falling, 102; potting, 182; Conte de Gomer, 397
 Canary wheezing, 308
 Canaries, teaching, 340
 Cannas, some handsome-foliaged, 423
 Cansera Parishii, 155
 Capar bush, 196
 Cape Gooseberry, 287
 Carnation seedlings, protecting from sparrows, 303
 Carrots, keeping, 182
 Cattleya Lindleyana, 455
 Cauliflower culture, 386
 Cedar seeds sowing, 440
 Celery—in winter, 60; leafstalk rooting, 255; culture, 480
 Celosia culture, 256, 342
 Centaurea candidissima from seed, 321
 Cerastium tomentosum and Biebersteini culture, 355
 Chain border, 304
 Chamber strops, 138
 Charcoal for manure, 255
 Cheiranthus sowing, 388
 Cherries under glass, 419
 Chickens—management of early, 222; lice on, 242; pecking their feet, 274; dead in the shell, 374; destroyed by crows and rats, 466
 Chitteprata, 466
 Christ's Thorn, 160
 Chrysanthemum cuttings and plants, 271
 Chrysanthemums—twelve show, 21; Lord Clyde and St. Margaret, 153; stopping, 200; (Pompon) Firefly, Vida, and Lizzie Holmea, 235; (large) Prince Alfred, and Princess of Wales, 236; of last season, 246; dwarf, 321
 Cinerarias—not blooming, 74; blind, 103; leaves injured, 241; sowing, 287; for seed, 304; Flower of the Day, Rembrandt, Eliza, 455
 Circassian Beans, 202
 Clematis Fortunei, 450
 Clerodendron seedlings, 222
 Clianthus—Dampieri seedlings, 121; seed sowing, 287
 Climata affected by trees, 455
 Cliveden, 416
 Clover stems, 103
 Coccospisididicolor, 235
 Cochinchinas—extra prizes for Partridge, 66; combs black, 106; food for, 144; Partridge cock's tail, 144; breeding, 164; white powder on legs, 164; eggs not hatching, 186; extra prize for Buff, 372; cock leg weak, 374; corns in, 408
 Cocksoombs—culture, 342; compost for, 371
 Cocoa-nut fibre refuse, 13; for Ferns, 354
 Colons Verschaffelti, 208
 Colours, harmony of applied to flower gardening, 395
 Colours, harmonising and contrasting, 71
 Collecta bictoniensis, 477
 Composts, materials for, 12
 Concrete, materials for, 284
 Conservatory—construction, 120; on north aspect, 441
 Cookery for the working classes, 206
 Copper for garden structures, 112
 Cordon training, 381
 Cork Poultry Show, 66
 Coronilla glauca culture, 103
 Cotton Plant in England, 363
 Covent Garden Market, 21, 43, 62, 81, 102, 119, 137, 158, 182, 209, 221, 249, 255, 270, 280, 303, 321, 336, 354, 370, 387, 404, 423, 440, 461, 482
 Cow-house vinery, 222
 Cow, produce from an Alderney, 242
 Crève Cœurs, derivation of name, 124
 Crickets on Vine shoots, 101
 Crocus not flowering, 103
 Crocuses, taking up, 388
 Crowing an annoyance, 466
 Crystal Palace, 366; Flower Show, 393; Bird Show, 162; florists' flowers at, 414; bedding out at, 420; Rose Show, 472
 Conifer seeds, sowing Japanese, 159
 Cucumber and Melon-house constructing, 159; heating, 160
 Cucumbers—useful sorts, 43; in winter, 60; early, 63; in pots, 72; culture in pots, 91; and Melons in pots without bottom-heat, 133; with Violes, 138; training, 222; the longest, 288; gum-diseased, 321; for winter, 388; culture of, 441; withering when young, 442; shrivelling, 461
 Currant from Malta, 43
 Custard Apple, 193
 Cuttings, management when rooted, 145; of bedding-out plants, 181
 Cyanophyllum magnificum—propagating, 159; culture, 201
 Cyclamen—seedlings, 62; persicum in pots failing, 321; seedling culture, 441
 Cypridians, North American, culture, 355
 DAHLIA—PRINCESS ALEXANDRA, 317; flowers varying in colour, 420
 Dahlias—starting, 43; list of pompon, 139; propagating, 239
 Dairy produce and management, 185
 Daisies failing, 256
 Daugstein, 9
 Daphne odora diseased, 200
 Darlington Poultry Show, entries at, 21

Bees—season commenced in Scotland, 124; acclimatisation, 142, 164; mice eat them; travelling by rail; early pollen-gathering; swarming extraordinary; premature drone production, 143; Mignonette for, 144; supering stocks; autumnal feeding, 164; Woodbury-hives, 164; removing; symptoms of dysentery; East Indian, 194; in Lanarkshire, 205; chilled brood, 224, 242; last season in Salop, 224; drone-breeding queens, 242; stocking an observatory-hive, 257, 274; water for, 257; raid-, 258; including to work in supers, in Oxfordshire, honey-dew, 274; early breeding, 290, 308; Dahlia flowers for, 290; foul brood, and what has been written about it, 306; uniting weak stocks, 307; artificial swarms, 308, 322, 339, 357, 373, 425, 484; uniting, 308; in roof, 308; why they work in the dark, 324; artificial combs; chilled brood and wax-moth larvæ expelled, swarm in place of stock, transferring, 340, 358, 445; swarm without drones, mode of driving, 372; fixing combs in box-hives, accepting a foreign queen, 373, 408; early swarms, 389, 390; artificial swarms; death of Ligurian, premature drone expulsion, gloves for apiarists, 390; driving and preventing swarming, 407, 408; conversion of bar-hives into frame-hives, Ligurian in Australia, gloves, 408; artificial combs, early honey, in Yorkshire, 426; artificial swarm deserting hive, 443; artificials warming, 444; do young queens breed drones? 444, 486; fed on unboiled syrup, 446; after hiving, 446; do they prey on fruit? 455; supering swarms, 466; parasite, 466; young queens, in Suffolk, 485; extraordinary Ligurian swarms, second swarms, 486
 Beet, Red, for bedding, 208
 Beetles, destroying in orchard-house, 101
 Begonia—leaves cracking, 221; Manni, 235
 Beverley Poultry Show, 424
 Birmingham Poultry Show, irregular admission, Capt. Heaton, Mr. Hindson, &c., 23; irregularities, 44; Mr. Williams's Game fowls at, 63; difficulties, 160, 161
 Birmingham Rose Show, 380
 Blackberries, Lawton & Dorchester, 139
 Blossom thinning, 254
 Boiler—wrongly fixed, 193; heating a cylindrical, 222; setting tubular, 255; for small fernery, 337
 Boilers—for garden structures, 56; saddle, setting, 96; proposed, 103, 139; requiring no setting, 139; consumption of fuel, 287
 Bomarea multiflora, 398
 Books for a gardener's library, 355
 Border planting, 178
 Botanic (Royal) Society's Shows, 229, 280, 295, 327, 376, 393, 429, 451; florists' flowers at, 293, 344
 Botanical specimens, drying, 271
 Bottom heat, 21; from hot-water pipes, 55; deficient, 201, 222, 305
 Bougainvillea speciosa culture, 138
 "Bouquet, the Illustrated," 236
 Bouquets, 467
 Bouvardia—triphylia culture, 138; longiflora culture, 431
 Brubma Footra prizes at Birmingham, 442
 Bridge Hill, Belper, 40
 Brisbane—gardening at, 433; Botanic Garden, 478
 Brosimum Anblethi, 201
 Brussels Horticultural Exhibition, 310; Congress,

- Dendrobium—*Farmerii*, 96; *ellatum*, 155; *Litawianum*, 256; *luteolum*, 317; *macrophyllum*, 321; *harbatulum*, *intumbidum*, 307; *Farmeri* var. *aureoflava*, 455
Desmodium *Skinneri* var. *albo-lineata*, 455
Deutzia—*sanzuinea*, double, 75; *gracilis* not flowering, 159
Dichytia—*spectabilis* seedlings, 237; *ocularia* culture, 355
Dinner-table decoration prizes, 227
Disas, various, 222
Dog, giddiness in, 206
Dorsing—*co*'s comb frosted, 68; with a tuft, 68; chickens, rearing early, 164; *cock*, diarrhoea in, 209; chickens dying, 462, 483
Dorkings, 206
Dormice, 143
Doves—*Australian* Bronze-winged, 274; small, 358
Draena australis, 63; culture, 256
Dropmore, 456
Dublin, Royal, Society's Show, 272
Ducks—breeding probably, 88; disordered, 358
Dung, beating by, 462
EAST INDIAN DRAKE'S HILL, 242
Echinocactus *scopa*, 397
Edinburgh Botanic Garden, 392
Edinburgh Botanical Society, 478
Egg—producers in winter, 308; within egg, 339
Eggs, 356; hens not laying in winter, 88; *musty*-flavoured, 164, 258; two laid daily, 256; ascertaining their fertility, 274; added yet not patrid, 374; a little more about, 388; hatched after being chilled, 443; chilled, 465
Endive culture, 256
Entomological Society's Meeting, 77, 155, 263, 268, 435
Entries, relative, 24, 140; comparative, 372
Epacris not flowering, 223
Eranthemum—*tuberculatum*, 155; *arenulatum*, *v. grandiflorum*, 317
Erythrina *caffra* culture, 304
Espalier rods, wood *v. iron*, 271
Espaliers, wire for, 22
Eucalyptus *obliqua*, 63
Eurybia *corymbosa*, 63
Evergreens—by sides of railways, 4; under Chestnut trees, 43; preparing ground for, 240
Everlasting-Flowers, yellow, 201
Exhibition—fowls, rule as to ownership, 103; prizes and entries, relative, 267
Exhibiting fowls not the exhibitor's, 183, 184
FAIRLAWN, 432, 453
Fairy rings on a lawn, 419
Fancier, recollections of an old, 204, 272
Feathers of white fowls, cleaning, 124
Fern—spores, sowing, 241; houses and green glass, 297
Fernery—construction of hardy, 31; management, 370; stand for, 371
Ferns—cultivation of, 10; for sunny aspect, 82; for baskets, 187; how to raise them, 243; in cocoa-nut shells, 433
Fig trees—re-potting, 81; in pots, management, 153; in pots, culture, 222; culture, 339, 367, 369
Fires, how to manage, 159, 309, 326
Floor of propagating-house, 96
"Floral Illustrations," 19
Floral criticism, 328
"Flower Gardening, Spring and Winter," 38
Flower—forcing, 61; garden, its arrangements, 70
Flower-garden—management, 89; spring propagation, 109; plan, 151, 316, 348, 349, 354; geometrical, 266, 271; winter decoration, 331; planting at Luton, 404
Flowers—*influence* of, 366; mis-called forced, 395; unsapplication of, 467
Flue tiles, 15
Flues, joints cracking, 256
Flying, preventing poultry, 106
Food for poultry, 288
Forcing flowers, 199
Forrestia *hispidula*, 155
"Fowls," 67
Fowls—price of, 242; cannibalism in, 258; *polls* pecked, 274
Frames, covering for, 132
Friends, failure of some old, 153
Frosted plants, 137
Fruit—walls, aspect for, 14; room, 63; trees failing on gravel, 121; trees dressing, 181; in pots, 233, 254; trees, summer pruning, 399; flavour of under glass, 437; trees, importation of, 461
Fuchsia culture, 231, 239; breaking weakly, 249
Fuchsias—list of, 103; potting, 138; in a cellar, 159
Fungigating, 138, 386; bellows, 318
Fungus on tan-plunged pots, 62
Furze obnoxious to caterpillars, 366
Furze *v. Gooseberry* caterpillars, 395
GAME—FOWL, PRIVATE MARKINGS AT EXHIBITIONS, 84; Mr. Williams's disqualified at Birmingham, 86; *cock* case, the, 104; fowls disqualified at Birmingham, 121, 139, 141; fowls for exhibition, 124; fowls, trimming, 161, 203, 223, 256, 338; mating, 164; condition of, 223, 241; *heas* and pullets, classes for, 288
Gapes, 340; remedies for, 258
Garden plans, picturesque, 398
Gardens worth seeing, 40, 52, 57
Gardens, villa, decorating, 219
Gardeners' Friendly Society, 255
Gardeners' Union, 21
Gardeners, overworked, 422
Gardening in England one hundred years since, 16
Garibaldi and the gardeners, 316, 347
Gas—like as a manure, 57; heating a greenhouse, 159; heating by, 388, 419, 476
Gate—a cheap, 299; posts, to fix, 459
Geranium—leaves spotted, 63; *Christine* spotted, 209; cuttings, striking in spring, 350; cuttings, 433
Geraniums—cuttings, pottin', 102; cuttings in spring, 103; Madame Vaucher, and *Christine*, 120; variegated, cuttings of, 189; in a cellar, 159; for the flower-garden and culture, 172; new, 179; for bedding, 201; Mr. Beaton's seedling, 263; in cold pit, 271; spring treatment of scarlet, 278; plunging and propagating, 405; from eyes, 441
Gishurst compound, 200, 420, 434
Gladioli, planting, 230
Gladioli—*sericeo-villosus*, 155; *Randle Jackson*, 155; culture, 330
Glass-case—*heating*, 160; plants for, 271
Glass structure, a useful, 366
Gloxinias—*Lady E. Villiers*, *Lady V. Harcourt*, and *Mademoiselle S. de la Courallerie*, 37; double, 102
Godetia *rosea alba v. Tom Thumb*, 317
Gold fish changing colour, 390
Goodyera *pubescens* culture, 261
Gooseberry—trees on walls, 78; bush buds protecting, 93; buds, preserving, 113; caterpillars destroying, 246, 281, 314; caterpillars, preventing, 214, 218, 232; caterpillars, Furze as a preventive for, 395, 421, 423, 430, 455; caterpillar *v. Beans*, Furze, and Alum, 479
Goose, how to roast, 258
Grating mastic, 434
Grape—*Duchess of Buccleuch*, 250, 251; bunches becoming tendrils, 305
Grapes—desirable varieties of, 30; the *Tokay*, 43; Early Hamburgs, 57; in *Camellia*-house, 201; rusted, 201 423; shanking, 337; spotted, 387; setting, 387; mis-called flavoured for out-doors, 423; New Frontignan, 433; choice of, 454; mildewed, 482
Grass, sowing and liming, 159
Grasses—list of ornamental, 103; ornamental, 201
Gravel walks, weeds on, 337
Green fly on wall trees, 424
Greenhouse—*heating*, 82, 461; beating small, 138; blinds, 159; painting, 169; use of cold, 201; stage for, 219; creepers for, 257; climbers for, 305; heating from sitting-room, 370; plants, list of, 441
Greenhouses, iron-framed, 271
Grotto, roofing for, 255
Guano nuts, 201
Guano as a Vine manure, 257
Gymnogramma—*pulchra* variation, 120; *chrysophylla* culture, 238
Gynerium *argenteum* in a pot, 82
HAMBURGS—BREEDING SILVER-SPANGLED, 68; tails of Silver-spangled, 124; Golden-spangled, plumage, 224; single-combed pencilled, 390
Hants (North) Poultry Show, 442, 483
Hardening-off plants, 181
Hatching—artificial, 164, 186; temperature, 274
Heating, 63, 230; horticultural buildings, 15; a plant-house, 222; economic, 234, 267; by stove or hot water, 281
Heckmond-wike Poultry Show, 24
Hedge—by a wall, 440; quick-growing, 483
Hedychium—*Gardnerianum*, hardness of, 34; in a greenhouse, 424
Helieryum *Mannii*, 235
Hen—incubating on her back, 339; with *cock*'s plumage, 448, 483
Hens—*laying* whilst perched, 258; with swelled heads, 290; eating eggs, 290; feather-eaters, 308
Hive, observatory, 324, 374
Hives, 206
Hollies—decaying, 192; removing large, 221
Holly hedge, cutting down, 255
Hollyhock culture, 369
Hollyhocks—not blooming, 82; of last season, 293
Honey, obtaining from the comb, 224
Horseradish, planting, 198
Horticulture, honour to, 273
Horticultural structures, wood *versus* metal for, 91
Horticultural (Royal) Society, 29, 189, 230, 247, 280, 375, 468; exhibitions and prizes in 1864, 33; Schedule for 1884, 90, 110, 151; Fruit Committee meeting, 98; illegal proceedings, 125; mistakes, 136; report of annual meeting, 126; comments on, 130; Dr. Hogg's resignation, 147; Report of Council, 151; adjourned meeting, 165, 167; Floral Committee, 212, 261, 313, 350, 377, 413, 451; Show, 211, 260, 312, 411; encouraging fish-culture, 265; objection to the two-days Show, 281, 296, 314; flowers mis-called forced at, 296; Exhibition on Queen's birthday, 347; Floral Fête, 393
Horticultural Congress at Brussels, 383
Hotbed—making, 120; inflammable gas in, 195, 217
Hotbells, a gossip about, 329
Hot-house building, 363
Hot-water apparatus—safety cock for, 196; an amateur's, 216
Hoya—*carnea* decaying, 43; *imperialis* culture, 355
Humea *elegans* culture, 431
Hyacinth—buds failing, 138; Show, Cuttubs's, 249; Mr. W. Paul's lecture on, 280
Hyacinths, 211; not blooming, 74; bloomed in glasses, 221; done blooming, 240; after forcing, 388; Robert Fortune, 397
Hydrangeas—blue without artificial applications, 135; blue, 197
ICE STORING, 42
Indian Corn, 388; for fowls, 340
Insects, destroying, 238
Ipomœa *filiculis*, 155
Iron—for garden structures 92, 112; fountain corroding, 159
Ivy failing, 63
JAPAN, LETTER FROM, 74
Japanese—work on gardening, 266; plants, sale of, 293
Jedburgh Poultry Show, 85
Jeffersonia *diphylla* culture, 264
John o'Groat's, a note from beyond, 18
Juniper seeds sowing, 440
KALE, Scotch, 370
Kales, various, 319
Kendal Poultry Show, 64
Kerguelen's-*hind* Cabbage, 391
Kew—some things to be seen at, 131; gardens, curatorship of, 314; Royal Botanic Gardens at, 345; retirement of Mr. J. Smith from curatorship, 342
Kidney Bean—the longest, 287; culture, 438
Kirke, death of Mr. J., 277
Kirkcaldy Ornithological Show, 65
Kitchen-garden seeds for an acre, 120
LABELS, 43
Lageria—*rosea*, planting out, 120; *rosea* culture, 287; *alba*, 455
Lardizabala *bicolorata* culture, 461
Lawn—grass seeds for, 201; weedy, treatment of, 461
Leaves—do they absorb moisture? 38; and flowers shrivelled in a new greenhouse, 72; browned and spotted, 120; browned, 204
Lemna minor, 249
Leroy Nurseries, 352
Letterwood, 21
Lilacs not flowering, 102
Lily of the Valley forcing, 304
Lilies, Japanese, 75
Lime-kilns, heating by, 15
Lincolnshire, gardens worth seeing in, 57
Liparis *Lœselii*, habitat of, 400
Liquid manure, 387; applying, 322; how to save, 439
Lobelia—*speciosa* for present year, 138; failures, 153, 191, 246, 282; *speciosa* culture, 231
Locust tree, the red, 401
Lycaste Skinner variety, 317
Lychnis *Senno*, 317
Lycopod cultivation, 409; list of, 411
MACAW—BLUE AND YELLOW, 124; Palm, 201; disordered, 206
Magnolia *Léand*, 155
Magna *cock*, hoarseness in, 106
Manchester Poultry Show, Game prizes at, 25
Manufacturing towns, trees and shrubs in, 433
Maranta and other leaves turned brown, 441
Marks, private, on exhibited towels, 103
McIntosh, Mr. C., death of, 54
Meady bug, destroying, 160
Melon—training, 222; culture, 326, 371, 405; house, 356; culture, seedling bed; sowing, 474; seedlings, maintaining heat, re-potting, fruiting bed, 475, 482
Melons—late desirable, 53; in a viney, 240; Water, 271; elevating above the soil, 461
Menispermum *planifolium*, 63
Meteorology of 1863—and effects of its autumn, 34; Ireland, 55; Sligo, 72; Weston-super-mare, 95; Manchester, 99; Lancashire, 135
Metrosideros *fruticulosa* culture, 103
Mice, traps for, 176; preserving Peas from, 182
Midland Counties Canary Show, 78
Mildew on Peaches and Nectarines, 388; on Roses, 388
Milton House, 52
Miltonia *Regnellii*, 317
Mimulus—*repens*, 57; *cupreus* and *maculosus*, 120; *maculosus* culture, 256
Mistletoe propagation, 240
Moss on grass land, 201
Moulting, change of colour in, 28
Mushroom—spawn, raising, 185; bed management, 157; beds, 198; covering, 255
Mushrooms, growing, 447
Mussett's hot-water apparatus, 221, 379
NANTWICH POULTRY SHOW, 122
Narcissus, extraordinary, 193

- Natal Horticultural Show, 478
 Natural-history specimens, collecting and preserving, 22
 Nectaries even in middens, 51
 Nectarine-buds falling, 21
 New Year's Eve Dream, 1
 Nierebergia gracilis from seed, 138
 Nightingale, imitators of, 426
 Northamptonshire, gardens worth seeing, 19, 40
- OAK-STUMPS, PLANTS FOR, 371
 Oleander treatment, 201
 Onions—falling, 221; sowing, 237
 Orach, Purple, 208
 Orange—trees, repotting, 200; (Mandarin) seedlings, 304
 Orchard-house, controversy, 93, 148, 190; management, 158; my, 359, 415, 450; in the north, 346, 420, 441
 Orchard-houses, 213, 246, 261, 269, 294, 315, 381, 472; definition, 150; pathway in, 219; at Sawbridge-worth, 248; in the Channel Islands, 325
 Orchids—N. American Terrestrial, 263, 292; Mr. Warner's, 399, 420
 "Our House and Garden," 406
- PAINT, PLANTS SUFFERING FROM, 283
 Paisley Poultry Show, 44
 Paliorna aculeatus, 160
 Pampas grass planting, 43
 Panax dendroides, 63
 Pansy soil, 287
 Pansies, growing superior, 437
 Paris, notes from, 473
 Parrot—plucking cut its feathers, 88; tail diseased, 164; having fits, 206
 Parsnips, sowing, 238
 Pasture improvement, 305
 Pea—the largest, 237; culture, 335, 386
 Peach—buds falling, 21, 108; trees, pruning and managing old, 116; house heating, 121; trees, pruning pyramidal, 233; culture, 236; trees, insect on, 270; tree blossoms, thinning, 278; ripening wood, 285; house building, 355; tree laterals, 371
 Peaches—under glass v. on open walls, 37; trees in pots, and in wet districts, 52; failures in culture, 55; bloom-buds falling, 62; in pots out of doors, 62; American, 325; on open wall falling, 337; mildewed, 441; in orchard-house, 450; number a tree can bear, 461
 Pea fowl, rearing, 466
 Pears—on quince stocks, 31; cracking, 123; grafting, 138; good late, 139; Easter Beurré ripening, 182; trees at Trentham, 201; trees blooming profusely, 304; diseased, 321; leaves blighted, 388; cause of falling, 429
 Peas—culture of early, 4; early, on clayey soil, 113, 117; raising early, 157, 268; sowing, 253; early, 422; crops of late, 427; culture, 438; selection of, 442
 Pelargonium—Bowkeri, 57; Diadem, 455
 Pelargoniums—of the season, 50; list of Fancy, 103; management, 119; spot in, 119; stopping, 139; frosted, 159; from seed, 370; blooming indifferently, 388; in a window, 441
 Perilla nankinensis, 20; management, 405
 Petunia, striking cuttings of double, 441
 Pheasant, hen assuming male plumage, 425
 Philodeodron fruit, 424
 Phlox—frondosa culture, 160; Drummondii culture, 441
 Phloxes—culture of perennial, 111; list of dwarf, 139
 Pierce's system of heating, 59
 Pigeon—why does it tumble? 104; retching, 308; disease, 374
 Pigeons—breeding Barb, 68; new varieties, 161, 272; Satinette, Iceland, and Blue Brunswick, 204; Archangel, 241; Nuns, 425; diseased, 466; Carriers not feeding their young, 466; diarrhoea in, 483
- Pimeleas done flowering, 371
 Pine for sandy soil, 54
 Pine Apples—culture, 259, 291, 341, 360, 428, 463; succession plants, 360; abortive, 493
 Pineas and Melons in same house, 304
 Pinks (hybrid), Striatiflorus, Marie Paré, and Rosette, 236
 Pipes—for hot water descending, 139; position of flow and return, 279
 Pit, the cold, 298
 Pits—of earth and turf, 134; formed of concrete, 232; turf and concrete, 254
 Plant—case, plant for centre, 102; shrubs for, 120; distribution, mysteries of, 300; exchanges, 420
 Plants—with dark foliage, 207; distribution of, 391, 430
 Planting, 36; in March, 121
 Plum tree on south-east wall, 102
 Plums—dried, from Spain, 21; drying, 54; in greenhouse, 336
 Poinsettia—pulcherrima, propagating, 62; pulcherrima culture, 111; management, 146; alba, 139; pulcherrima, stopping, 221
 Poisonous garden plants, 116
 Polish cock's crest discoloured, 308
 Pork, how much a bushel of corn makes, 390
 Potato seedlings, 252; planting, 253
 Potatoes—early, 43; and Greens, growing conjointly, 351, 364; cut and ncut, 434
 Pots, London sizes of, 405
 Potted plants, soil for, 288
 Potting, 320
 Poultry—plumage mutilated at shows, 24; market at Christmas, 25; fattening, 28; and refinement, 82; judging, 84; not injurious to pastures, 106; for farm, 124; show schedules, 122; breeds unseparated, 144; profitable layers, 144; fanciers, caution to, 162; food required by, 164; show improvements, 161; shows, frauds at, 202; schedules of, 202; relative entries, 223, 338; straying, 224; shows, long continuance of, 305; relative merits, prizes, and entries, 305; and the poor, 306; average day's food for, 324; keeping disappointments, 338; shows, judges, and exhibitors, 371; judging, rules for, 406; yard troubles, 465; in cellars, 466; poisoned by paint, 466; Club's Show, 484; exchanges, 486
 Primroses, Japanese, 74
 Primula—seed sowing, 240; sineasis sowing, 287
 Primulas—management, 336; culture of Chinese, 361; alpine, 391; alpine, culture, 430
 Propagation of flowers in spring, 109
 Propagating—shelf for, 201; pit, with flue, 62; pit, heating, 82
 Property, what is bona fide? 389
 Prostanthera lasiantha, 63
 Protection—in winter, 42, 61; for fruit blossom, 303
 Prunus trioba, 420
 Pullet's stripping-off feathers, 124
 Puttridgebury, 113, 176, 260
 Putty and paint, solvent for old, 324
 Pyrethrums—and their culture, 130; Salter's double, 417
 Pyrus japonica fruit, 442
- QUAMOCLIT NATIVUS, 235
 Quassia water v. aphides, 461
 Quick hedges, making, 244
- RABBITS—LENGTH OF EARS, 164; ejected, 308
 Raspberry training, 61
 Red spider—does sulphur kill? 150, 194; destroying, 379
 Reidia glaucescens, 317
 Roehia falcata culture, 133
 Rhododendron—Princess of Wales, 57; ponticum poisonous, 186; javanicum culture, 201; Nuttallii, 299; flowers spotted, 370
 Rhododendrons—rabbits eating, 224; Sikkims and Ludia, 402; at Fair-lawn, 432
 Rhnbarb culture, 319
 Rhynchospermum jasminoides culture, 461
- Ribbon-border, 19, 232, 271, 837
 Rivina humilis culture, 221
 Rooka, 872
 Root-pruning, 7
 Roots and leaves, 7, 36
 Roses—catalogues for 1863-4, 33; protecting budded, 43; Baron de Rothschild, 57; forcing, 138; trees on their own roots, 193, 228; in the suburbs, 210; cuttings and grafting, 287; on the briar, 296; Beauty of Waltham, 314, 344, 362, 379, 399; flowering but not growing, 816; critiques on new, 378; beetles on, 388; in pots, pruning, 388; notes on a few, 418; first seed by Banksian, 419; leaves falling, 440; with green centre, 441; Madame Victor Verdier, 455; in France, 473; mildew on, 482
 Roup, 442; in Bantams, 374
 Rust c arhours, &c., 57
- SACCOLABIUM HARRISONIANUM, 235
 Salt and guano, 77
 Sand, sea, for cuttings, 201
 Sandingham Gardens, 455
 Saranitalia procumbens as an edging, 304
 Scarborough Lily, 356
 Scarlet Runners, 302
 Schizostylis coccinea, 57, 155
 Sciara pyri, 429
 Screen—plants for a wall, 103; trees for a high, 182
 Scutellaria Costaricana, 317
 Sea-kale—on sandy soil, 139; blanching, 238; tough, 253; culture, 254, 302, 319
 Season—flowers in bloom, 8; in Devon, 33; Northumberland, 41
 Seeds, tropical, sowing, 241
 Sewage of house, 462
 Shading, simple mode, 320
 Shallots, planting, 238
 Sheepdung from butchers, 221
 Skeletonising leaves, 475
 Skins—how to dress? 106; preserving hare and rabbit, 124
 Slings—trapping, 6; in Mushroom-heds, 100
 Smith, Mr. John, retirement of, 342
 Soapuds and their utility, 113
 Solanum anthropophagorum, 57
 Solomon's Seal forcing, 271
 Spanish fowls, breeding, 390
 Statice profusa culture, 228
 Stokesia cyanea culture, 43
 Stove—heating a forcing-house, 97; heating by iron, 269; plants, list of, 441
 Stoves for small structures, 43
 Strawberries—mowing off leaves, 9; every month, 29; forcing, 61; Carolina superba, culture, 62; in New Zealand, 267; forced, falling, 337; packing, 405; unfruitful, 440; protecting fruit, 460; for forcing, 461
 Strawberry—forcing, 303, 396; forcing-house, 315; forcing, pit for, 359; insects, 355; culture, 369; unfruitful, 388; plants falling, 399, 405; house, temporary, 403; Princess of Wales, 473; Jean Powell, 479; failures, 480
 Sulphur and red spider, 239, 238
 Summer-house, plants to cover under trees, 22
 Super-phosphate of lime, making, 349
 Suple-jacks, 292
 Swans, food for young, 374
- TABLE DECORATIONS, 461
 Taccna not blooming, 271
 Temperatures for forcing, 158
 Testaceus hallioteuda, 418
 Thibandia sarcantha, 455
 Thorne Poultry Show, 464
 Thoros—useful and ornamental, 248, 276; list of, 277
 Tobacco fumigators, 136, 138
 Toddorden Botanical Society, 135, 299, 473
 Tools, repairing, 250
 Transplanting, 8, 36
 Trellis for fruit trees, 303
 Trentham, the small garden at, 63
 Trichantha minor, 155
 Trichinium Manglesii, 455
 Tritelia uniflora culture, 222
- Tritonia aurea frosted, 388
 Tropaeolum—canariense for beds, 139; not blooming, 222; elegans sowing, 240; azureum culture, 388; tricolor and Jarratti, sowing, 441
 Tuberoses—notes on the, 76; double, culture, 139
 Tulips—in flower-beds, 370; early, Proserpine, Keizerkoon, Roi Pepin, 455
 Turf for composts, 12
 Turkey sitting without laying, 358
 Turkeys—crops enlarged, 124; nesting without laying, 324
 Turnip—tops, blanched, 219; culture, 439
 Turtle Dove's eggs unproductive, 466
- ULVERSTON POULTRY SHOW, 141
 Utricularia, propagation of, 401
- VACCINIUM ERYTHRIUM CULTURE, 256
 Vallota purpurea, 337; culture, 43
 Verbena and Calceolaria leaves injured, 482
 Verbenas—planted out, 62; list of, 103; damping off, 121; new, 138; for pots and cut flowers, 182; green fly on, 287; Conspectua, Mrs. Nichols, and Gen. Bazaine, 317; New Italian, 397
 Veronica speciosa, hardness of, 34
 Victoria regia, growth of, 346
 Vien-sienxia fugax, 317
 Villa front garden, evergreens for, 275
 Vine-borders, 6; carriage added to, 103; mature for, 120; temperature of, 209; deepening, 271; covering, 336
 Vineries—heat ng, 21, 63; starting, 22; large v. small, 188, 215; on east aspect, 189; roof, glass for, 253; wide without pillars, 287; construction of, 233; planting, 282; borders for late, 405; glass and wires, 354; glass for, 357; construction of, 457, 462; ground, 469
 Vines—cause of their exhaustion, 2; culture at Berkhamstead Nursery, 6; for greenhouse, 21; lifting and inarching, 52; breaking, 62; in-arching, 81; planting in a greenhouse, 82; in pots in greenhouse, 103; inarching, 120; cutting down young, 120; in pots, 138; and Cucumbers together, 138; leaves rusted, 222, 256; falling, 240; stock for grafting, 240; diseased, 271; artificial impregnation, 294; in pots, planting out, 304; leaves spotted, 304; not starting regularly, 304; blistered leaves, 304; flower-stalks falling, 317; border, 321; mildewed, 370; forced, 370; injured by guano water, 371; leaves spotted, 389; beetles on, 385; trellis, 436; leaves scorched, 441; leaves injured, 461; Peaches and plants under, 482
 Violet, the blue wild, 305
 Violets—culture of double, and Neapolitan, 221
- WAITZIA CORYMOSA, 397
 Walks—keeping of, 353; weeds on, 371, 388
 Wardian case, plants for, 305
 Water-Cress culture, 221
 Water-flow management, 160, 162
 Watering—in gloomy weather, 76; how to regulate, 459
 Weather—the, 400; in June, 414
 Weed volunteers, 218
 Week, work for, 19, 41, 59, 78, 99, 117, 136, 156, 180, 197, 218, 237, 268, 284, 301, 318, 334, 352, 385, 402, 421, 437, 458, 479; Doings of last, 20, 42, 60, 79, 100, 118, 136, 157, 180, 198, 212, 237, 253, 268, 285, 302, 319, 335, 353, 368, 386, 403, 421, 438, 458, 480
 "We must draw a line somewhere," 406
 Wellingtonia gigantea, 195; planting, 43; largest, 380
 Wellingtonia, large, 434
 Wharfdale Poultry Show, 322
 Wigton Poultry Show, 289

Wild plants, plea for, 454	Woodbridge Poultry Show, 406	Yew—trees, making hedge of old, 22; poisonous to deer, &c., 28; are they poisonous? 68; green, not poisonous to deer, 88; donkey killed and sheep uninjured by eating, 106; not poisonous to deer, 106; herbivorous animals among,	144; propagating and grafting the Golden, 159; green, fatal to oxen, 206; Irish and common, pruning, &c., 271
Williams's Nursery, 379	Woodlice in frames, 201		Yuccas, removing, 287
"Window gardens for the people," 367	Worms—habits of, 6; ammoniacal liquor for destroying, 82; in hot-bed, 159; in walks, 321		ZINC FOR GARDEN STRUCTURES, 112
Winsford Poultry Show, 28	YEAR, REVIEW OF, 22		
Wood—for garden structures, 92; and iron for garden structures, 112			

WOODCUTS.

	PAGE.		PAGE.
Apple-tree Training	383	Gas-heating	476
„ Grafting by Approach	383	Gate, a Cheap	299
Arrott's Stove for Heating Greenhouse	172	Geometrical Flower Garden	266
Bees, Driving	373	Glass Structure, a Useful	366
Bulb Planting in Pots	235	Gloxinia becoming Double	102
„ Garden at Dropmore	456	Gooseberry Tree, Training	78
Buasen's Burner	476	Grafting by Approach	383
Caper-bush	196	Heating, Economic	234, 267
Cliveden Flower Gardens	39, 416, 417	„ by Lime Kilns	15
Colletia bictoniensis	477	Hot-water Apparatus	217
Cordon Training	382, 383	Linton Park Winter Garden	332
Dendrobium Farmerii	96	North Walls, Fruit Tree Training for	14
Dropmore Bulb Garden	456	Peach Tree Cordon Training	383
Embroidery, Garden	332	Pierce's System of Heating	59
Flower-beds, Planting	318, 349	Pits, Earth and Turf	131
Flower-garden Plans, 39, 114, 115, 154, 176, 177, 251, 266, 316, 416, 417, 456	15	Putteridge Bury Flower Gardens	114, 115, 176, 177, 251
Flue-tile	15	Vineries, Construction of	282, 283, 457
Fruit-tree Training	14	Vine Trellis and Training	436
Garden, Plan for Laying Out	398	Winter Garden at Linton Park	322
Garden Seats	58		



WEEKLY CALENDAR.

Day of M'nth	Day of Week.	JANUARY 5—11, 1864.	Average Temperature near London.			Rain in last 37 years.	Sun Rises.	Sun Sets.	Moon Rises.	Moon Sets.	Moon's Age.	Clock before Sun.	Day of Year.
			Day.	Night.	Mean.	Days.	m. h.	m. h.	m. h.	m. h.	m. s.	m. s.	
5	Tu	Groundsel flowers.	41.7	30.2	35.9	13	8 af 8	3 af 4	44 3	41 0	26	5 29	5
6	W	EPHAPHANY. Twelfth Day.	41.1	29.5	35.3	13	8 8	4 4	54 4	27 1	27	5 56	6
7	Th	Redbreast sings.	41.4	28.7	35.0	14	7 8	5 4	0 6	24 2	28	6 22	7
8	F	Grey Wagtail seen.	40.6	30.0	35.3	11	7 8	7 4	58 6	34 3	29	6 48	8
9	S	Linnets congregate.	40.9	30.8	35.8	14	6 8	8 4	45 7	54 4	30	7 14	9
10	SUN	1. SUNDAY AFTER EPIPHANY.	41.6	30.3	36.0	16	6 8	10 4	25 8	17 6	1	7 39	10
11	M	Plough Monday.	41.4	30.9	36.1	19	5 8	11 4	55 8	41 7	2	8 3	11

From observations taken near London during the last thirty-seven years, the average day temperature of the week is 41.3°, and its night temperature 30.6°. The greatest heat was 54°, on the 5th, 1844; and the lowest cold, 6°, on the 9th, 1841. The greatest fall of rain was 0.77 inch.

A NEW YEAR'S-EVE DREAM.

Hilltop Rectory, Wilts.
New Year's-eve. 1863.



ALF-PAST ten o'clock. Let me see! The whole of the evening's duties and social pleasures are fulfilled and over. New Year's-eve—Little ones in their order sent off to bed, with a few words, according to their ages, about the past year said to each one while sitting on my knee; little flaws, naughty tempers and passions whispered about, and promises of amendment from each little listener for the

future year—promises sealed with a very loving kiss. Then the reading aloud of my eldest boy; my dear school-girl, now home for the holidays, practising my favourite piece, "Chime Again, Beautiful Bells!" upon her piano. Prayers over, and all off to bed except my reverend self. Ah! there is mamma's step in the nursery for a farewell peep at the little birds there fast asleep. Pat! pat!—now she is in the boys' room. Back again: there, now, the footsteps pause near the little cot in her own room. Oh, happy home! Thank God for it! and amid all its trials, still say I, blessed life of a married country parson.

Well, now, how forgiving I am! Good reader, I will tell you why I say this. Just as Materfamilias looked in at my study on her way upstairs, she caught me getting out of my closet—"my sacred place,"—the last year's pile of JOURNALS OF HORTICULTURE, and she said very decisively, "Do put those things away, there's a good husband. Once get them out, and you will be sitting up ever so late. What pleasure can you find in reading over and over again what those queer-named people write—'D., of Deal's,' 'B. & W.'s,' 'Upwards and Onwards,' 'Once Bit Twice Shy,' 'Egomet's,' and 'Meipsums?' Besides, dear, you may fidget; but your eyes are not so good for candlelight reading as they used to be. How red your eyelids looked in the pulpit on Sunday after you had sat up late the night before, preparing old Joshua's funeral sermon."

I heard, and — was silent. But when the door was closed, "Now," said I, "for my turn. I'll preach, as we used to say at school, and tell all about you, good kind wife, my caretaker for these many years. Don't you like me to read to you all the tit bits in our Journal (we always call it ours in this house) every week? and were you not saying, while looking at the Trentham views, 'How pretty the engravings are now!'"

Now I feel satisfied, for I have said my say; but I don't feel inclined to go to bed yet. Dear me! how we feel the wind on the hill! why, the park trees are sonorous with it! Yes, the gale is rising; and but that I know I am inland, and, better still, at home, I should feel sure that it was the sound of the sea. But it is only the wind swaying this way and that way the branches

of those fine "Wiltshire weeds," as John Evelyn called them—our beautiful Elms. Flip-flap against the window—there's a branch of one of my Cloth of Gold Roses got loose! Is it possible that can be a shy-blooming Rose? Why, here on my south front I have had a hundred and fifty blooms out at once; and on the east side, even, some few blossoms of a colour far surpassing those in the south, because uninjured by a scorching sun. But then this is Wiltshire air and soil, good reader, not terrible east of England—how that word "east" grates through one!

"Of a' the airts the wind can blaw,
I dearly lo'e the west."

Well, I will sit up and keep awake; it is a master's duty to do so this stormy night. Who can tell what accidents may happen? Now my conscience is easy—yes, it is a duty. Down, Mettle; lie down, old dog. What, not like the wind! Poor, faithful fellow, lying paws stretched out and head on them, eyeing master for the word, "Go to bed, Mettle," and then off to your box in the kitchen. It's New Year's-eve, old boy, and we will sit up awhile yet, and keep awake too. How much better you are! you're a real black and tan terrier—just like the one figured in "Bell's British Quadrupeds"—than one of those mongrel Italian Greyhounds called toy terriers.

How the wind is blowing! I open the study-door, cross the hall, tap the barometer—it goes down like a shot—it is nearly as low as it was when the "Royal Charter" was lost.

Now for "our Journal." What a pile of them! How soon a man gets interested in a periodical! Just, and only just, two years ago I saw a Number for the first time in a gardener's cottage (fit place for a COTTAGE GARDENER); and now I look forward to Wednesday's post, and cut the Journal open quickly, and know the different styles of the writers, and read my own articles.

Dear me, how cosy this fireside is! My feet are so comfortable, I think I'll indulge in a sit in my easy chair, for there is no fear—I never sleep out of bed. January's first Number lies on my knee. Very pleasant is the warmth to my legs. Wind is very lulling, they say—Mettle—wind—Rose—Cloth of Gold—my eyes are surely getting very dim: I can't see the title. How very easy this chair is! What next? Good reader, I fell asleep, and "I dreamed a dream."

Methought I stood in a large hall decorated with evergreens. I was standing, and everybody else was sitting. I stood at an open desk, and what strange canonicals I had on! My surplice was bright green, with flowers in every part. My scarf was soft and featherlike to feel, formed, in fact, of gold and silver-spangled, gold and silver-laced, and gold and silver-pencilled feathers. I turned to my hood: it was of finer feathers still—far softer; it resembled nothing so much as a huge jacobin pigeon's chain and hood, and I felt inclined to put it on, monk fashion, to keep off the cold. And I felt my bands, and they were embossed with golden bees. On the desk before me lay a piece of

parclement on which was written, "You, Wiltshire Rector, are our chaplain for the coming year." Signed, "Editors of JOURNAL OF HORTICULTURE." "N.B.—Address all present from the words 'Good will to all.'"

Before me sat in seats of honour the whole staff of the Journal, behind them occasional contributors, and then such a multitude! These were "our readers." The hall seemed boundless. I could see far away heads growing less and less, but I could not, so it seemed, see all, there were so very many. I recognised shrewd Scotch faces; plenty, too, of young English gardeners. I saw old experienced gardeners; country squires not a few; clergymen, dear me! what a number! and many honest-looking faces whom I felt sure were lovers of poultry, some of them having a pin in their bosoms with a head shaped like a game cock. There were boys and girls, too, who looked very interested and whispered something about "our pets;" but crinoline in point of number, beat all to nothing. Some ladies had on beehive-shaped hats, others chicken-coop-like bonnets, many with dove-coloured mantles, and a very great number, far the most, wore flowers by no means artificial.

I began to address the company, and I thought, nay, felt sure, that my voice reached every one. My text has been fixed for me, my friends; it is, "Good will to all." I shall speak on these words briefly, but I trust to the point. First, I shall address all the writers of our Journal; secondly, all the readers of the same. But, like our Journal, my address must have another division; to the writers and readers of the floral department, and to the writers and readers of the poultry department.

Before anything special, let me say to my friends all of you, What advantages are ours! No differences of politics affect us; it is nothing to us what ministry is in or is out; wars matter not to us; quiet pursuits, quiet pleasures are ours—pleasures that never tire, for we have to do with Nature, and "Nature never did betray the heart that loved her." How genuine our pleasures are! Everything in our Journal aids pure wholesome employment or recreation. The pursuits we love tend also to friendliness. I have begun acquaintances by admiring a flower in a garden, which acquaintances so made have ripened into friendships. I have introduced myself to the Misses——(Oh! dear me, no names), as a lover of poultry, and I now spend long summer days with them.

The subjects upon which our Journal treats are calculated to cause good feeling, to soothe tired minds, to make men love hobbies which have given them pleasures for life still more. But (I began to feel nervous, for sundry faces showed a keener interest when I had pronounced that little word, "but"), brother contributors to the flower department, our subjects forbid ought but kindness. The bee has its sting, the cock will peck sharply at an adversary, the very hen will scratch; but flowers only speak of gentleness and kindness. So pray, during this coming year, employ no words that sound hard, perhaps only in sound. Kind, gentle criticism should be ours, full allowance being ever made for differences of opinion, and for different temperaments. Write kindly, then. There are differently constituted minds; let none despise another; "We are all of us human, and all of us erring."

Brother contributors to the poultry department—for I am one of you too—let us, if exhibitors, avoid the least approach to dishonesty, everything in the least degree opposed to right principle—no ingenious sickle-feather-and-sealing-wax-like tricks. And writers, though cocks and hens may peck, and some on coming to the scratch prove themselves game, yet, remember, our best game is the game of kindness. If we sell or exchange let all be done in perfect fairness, doing to others as we would others should do to us.

And, then (feeling my hands), you writers in the bee corner—a very large corner sometimes—your favourites make honey, how sweet-tempered then you should be; how gentle your buzzings!

And now, lastly, readers of all classes, we work for you, we labour for you, and we do not work (your numbers show it), in vain. Professional reader or amateur, are we not benefactors to you both? Good will, good wishes to you all, may you all be our readers for many years yet.

A HAPPY NEW YEAR TO YOU ALL.

And here the silence seemed broken at once, by the many

"Happy New Year's to you, Chaplain." Amidst the noise I awoke. There was Mettle watching me still. "Go to bed old boy!" and so will I, this was added in a lower tone. I rattled the fire out of the grate and upstairs I went. "My dear! I did not get farther than the title page of the first January Number of 'our Journal.'" "That was very good of you!" Of my dream I said nothing, that shall be read.—WILTSHIRE RECTOR.

A FEW OF THE CAUSES BY WHICH VINES ARE EXHAUSTED.

For the accomplishment of any specified object upon which the inexperienced have set their mind, it is well to have a directory which shall trace out the proper means and applications by which the object is most surely to be attained. Without some guide there must be many haphazard and unsuccessful attempts which nothing but the experience and close observation of almost a lifetime can prevent. Whether it be a passage across the deep, or an excursion along some unknown path, it is not only most desirable and necessary to have a guiding chart to point out the right and safe way, but it is also most important to have the hidden rocks and shoals charted out, the precipices and deceiving quagmires carefully noted, so that the dangers that beset us may be guarded against and avoided. Success, even to the most efficient, is not the work of a day, it is realised and built up little by little like human character itself. True, the most gigantic objects and puzzling problems are triumphed over by time and perseverance; but it is well when we can shape our course and calculate our ends by the facts and ascertained results of those who have gone before us. The deductions of experience, and the results of reflection and careful inference, cannot fail to be valuable to those who are seeking the attainment of any given object. This is applicable alike to the moral and physical world, and in no small degree to the operations of the gardener.

The gardener has to deal with the most exquisitely organised bodies, possessed of a certain kind and degree of life, which are as capable of being affected by every variation of temperature and chemical change of atmosphere from without, and by imbibing from the earth and air around them extraneous matter into their systems, as is the fearfully and wonderfully formed human frame itself. Indeed, some of the functions of the two forms of creation are so marvelously alike that it cannot be otherwise. The laws by which the vitality of plants is governed are so easily deranged, and plants themselves so subject and sensitive to all deteriorating influences, that it is most desirable to be thoroughly aware of at least the most prominent of those causes which produce injurious influences that so greatly affect their health and longevity.

The attempts which are now so numerous and laudably made to grow Grapes under glass by those who are entirely without experience, and, to a large extent, ignorant of the physiology and functions of plants, renders it the more likely that any remarks which may be made in reference to the heading of this article, may be of some slight service in helping the inexperienced to gain the pleasing and wished-for object of sitting under their own fruitful Vine: therefore it is that I have to offer a few remarks on some of the dangers and mistakes into which the youthful Grape-grower is most likely to fall. The excellent publications on the Vine which have from time to time appeared, but especially of late, are all that could be desired. They were never intended, however, to deal with every case which might possibly arise, nor to supersede the more desultory province of the journalist. The two provinces are so entirely distinct that the one can never supply the place of the other.

The Vine is not naturally a short-lived plant. The contrary is just one of its chief characteristics, whether it grow on the slopes of a salubrious continent, or in the vineries of our own island. To give proof of this would be mere waste of words, so many instances being known of old Vines, which are still bearing heavy crops of good Grapes yearly. Nevertheless, the well-being and longevity of the Vine is so largely affected by errors in management, combined with local circumstances, that it is perfectly astonishing what a number of Vines year by year pass off the stage in their

very infancy. Indeed, if it were not so, and all the Vines grown in the kingdom were to take up new ground, the face of the country would soon be dotted over with vineries at a rate which it would be most desirable to see.

The causes which I purpose to enumerate are only a few of the most destructive, and likely to be overlooked by amateurs and others of the most limited knowledge and experience of Grape-growing.

1st, *Too Rich Borders.*—Gross feeding has too often been supposed, and said to be, a chief feature in the nature and requirements of the Vine. There never was a greater mistake. If large and spongy wood instead of fruitfulness and good Grapes were the object, then the border might safely consist of large proportions of gross manures, such as animal excrement and offal. But even with this object in view, such a border would only answer while the organic part of the mixture was decomposing, and till it had become effete and, I had almost said, poisonous. True, we hear of some who look for an El Dorado of Grapes from one fat border, and who boast of canes, at two or three years old, of such and such a diameter, as if the chances of fine fruit were in the same instead of an inverse ratio. There never was a greater day-dream. The fact is, Vines in such circumstances are very much like a man long accustomed to plain and wholesome food, who is, under the mistaken notion of improving his health and prolonging his life, obliged to take to the strongest food and noxious potions, by which the functions of his body are overcharged and obstructed, and who at last becomes the subject of speedy decline and certain dissolution, unless by some curative means his system can be cleared from such matters.

I know of Vines which have made great growths for several years in such borders, the evil of which is now being pointed out, but from which not a presentable bunch of Grapes has been produced. This error, disastrous under any circumstances, is the more to be dreaded in localities where, from damp soil and the greater prevalence of clouds, and vapours, and heavy rains, the consequent evils are aggravated instead of mitigated. To ripen such growths in the colder and wetter localities a wasteful amount of fire heat must be resorted to; and even by such means the solidity and ripened fruitfulness of Vines cannot be accomplished in the course of our short summers. But this is not all. There is no guarantee that such a strong growth will be upheld. The consequences are the very reverse, because the assimilation is unnatural; and something like the premature development of the youth who is growing into the grave at the expense of a well-compacted frame, the Vine feasts on the over-rich border, and makes an unnatural development of growth till the border arrives at that stage of decomposition at which it is reduced to a solidified mass of soil, effete and pulpy, in which the roots of the Vine can neither ripen nor live; and what else but the most undesirable results can follow such a state of things? Nothing can produce satisfactory results but the entire removal of such soil from any contact with the Vines, and if this proceeding is not resorted to in time their existence will soon be brought to an end.

The inexperienced cannot, therefore, be too urgently advised to avoid such border-making as one of the greatest evils, and one which cannot be well counteracted by any other points of management. Large bunches are the "will o' the wisp" object of such borders; but a scanty crop of long straggling, shanking bunches is the unavoidable reality. But why this itching after large bunches of Grapes? Generally they are the worst finished, and, when to be dished in a neat and presentable manner for table, the least desirable. A medium-sized bunch generally swells finer berries as to size and flavour, and is much more useful. When large bunches are craved after simply for their size, a Vine or two of some of the several large-bunching sorts might be planted, which would be a much more likely way of gaining the end in view than by planting the smaller and more useful Grapes in the rich borders. There can be no greater delusion in connection with Grape-growing, than to suppose because Vines have made enormously strong growths, that they will therefore produce enormous bunches. Beyond a certain point, the reverse is the rule. This idea is especially to be avoided by those who have only a greenhouse vinery, from which Grapes are expected without the least application of artificial heat. In their case success is impossible from borders which

produce that grossness of growth which cannot be made fruitful by proper ripening.

2nd, *Too Heavy Cropping.*—This, if practised for a few years, especially in the earlier stages of the Vine's existence, is as certain to cause a break-down as is the overworking of a young and undeveloped frame to be attended with deformity and premature old age. To avoid this evil it requires a deal of what may be termed moral courage to apply the knife or scissors to the bunches till they be reduced to that number which Vines can carry with impunity. A heavier crop than is judicious may be and often is matured to a wonderful degree of perfection, but not without taxing the Vine to a degree which it cannot bear many years in succession without suffering severely, and refusing to bear even moderate crops. It is no uncommon case to meet with Vines having the fruit-bearing spurs much too closely set on the main stem, with a bunch, and sometimes two, on each shoot. This is the most cruel and suicidal treatment that can possibly be attempted. A moderate bunch to every foot of main stem is quite sufficient, and should not be exceeded by any who wish to keep their plants in a vigorous and fruitful condition. This is a rule which the inexperienced can easily apply and modify according as the bunches are larger or smaller, and the Vines in good condition or otherwise, and it will in the end be found much more profitable than the leave-all system so often met with.

3rd, *Crowded Training and Close Stopping.*—It is not required to enter into any argument to show that vegetables or fruits when crowded together, not only cease to develop themselves properly and bear their respective crops in a satisfactory manner, but that such a state of things proves, in many cases, the utter ruin of all that are placed under such circumstances. It is only necessary to sow a row of almost any vegetable, and leave it unthinned, or not to thin it sufficiently, or to allow a Gooseberry bush or many other plants to become overcrowded with wood, to see the evil effects of such a state prominently exemplified. This applies with great force to the cultivation of Grapes. Failure from this cause is not unfrequently met with in its very worst forms; and I cannot help thinking that the great majority of our Vines would do very much better if they were allowed more room. At least the main stems or rods of Vines should not be closer together than 2½ feet from rod to rod as the closest that is compatible with successful management; while 1½ foot more is a great advantage when the object is to obtain the best possible development of both foliage and fruit. With the greater amount of room there would be no risk in exceeding the weight of crop that has been named above for a minimum or moderate space allowed to each Vine. The fruit-bearing powers of a Vine must be measured by the amount of foliage and root-action which it is encouraged and allowed to make more than by any amount of stimulants which can be applied when the action of the leaves and roots is checked by overcrowding and close stopping. The latter practice is one which generally and necessarily accompanies thick training, which, in conjunction with heavy cropping, will work the destruction of Vines as quickly as anything that can be named, and all the more so, as other evils follow in their wake. Train Vines 3 or 4 feet apart from stem to stem, with fruit-bearing spurs not closer than 20 inches or, better still, 2 feet, and leave three or four leaves beyond the bunch instead of only one, or, as I have seen practised, stop at the bunch itself, and there is encouraged the machinery that will soon establish a Vine of a strength that will throw far finer crops than when crowded and pinched as I have referred to. Under such circumstances there is a scale of action going on which can make good use of stimulants when they may be thought advisable. There is as much difference in results between these two rules as there is between the delicate seamstress who sits blanchéd and pale at her needle, deprived of light, air, and exercise, and the active out-door Amazon who is accustomed to the muscular work and fresh air of the field. To establish strong Vines there is nothing like room, light, and air.

4th, *The Premature Destruction of Foliage.*—As the pulmonary arteries convey the blood to the lungs there to be exposed to the air we breathe, and undergo changes, and be diffused through the system for its nourishment, so is the sap sent up to the leaves by the roots to undergo changes necessary for the well-being of the plant. Premature de-

struction or injury to the lungs does not more certainly lead to fatal and injurious results to the animal body than does the destruction of leaves before their proper time lead to like results in a plant. This, in the case of Vines, cannot be too carefully borne in mind, for it is impossible that Vines should be subject to having their leaves destroyed prematurely for years in succession by the ravages of red spider, without being correspondingly weakened and rendered less fruitful. This evil more generally arises from the ravages of the red spider than from any other cause. True, scorching through negligent ventilation does sometimes occur. The crowding of Vines and the tender foliage which follows as a consequence, is a cause which predisposes to red spider; and, probably, too much fire heat, and too little fresh air are the most likely to unite and bring it into activity. I am not, however, forgetful of the fact that dry, light soils in times of drought have to do with the presence of red spider, and so have other collateral causes in a minor degree—such as sudden checks, inattention to scrupulous cleanliness, and a few more that might be named; but those especially pointed out may be regarded as the principal causes of the appearance of this insect, which often does so much mischief by destroying the foliage.

5th, *Very Early Forcing with the Roots in a Cold Border.*—Very early forcing—that is, forcing in the winter months to ripen Grapes in March, April, and May, without attention to the temperature of the soil, is sure to weaken and destroy very quickly the constitution of Vines. Even under the most efficient and favourable means this is a trying process, as the growth has to be made in the absence to a very great extent of light. And hence the reason why Vines started in August and September to ripen Grapes in January, do not suffer so much as those started in November. This is, however, an evil which comes less within the range contemplated in these remarks, and applies more to men of experience who are supposed to be able to meet or avoid as much as possible the evils dependant on it. Comparatively few amateurs, and others almost wholly inexperienced, attempt forcing Grapes at so early a season, and I therefore dismiss the subject by simply remarking that Vines forced under such circumstances, unless the soil be heated, and the vineries made so as to catch and admit as much sunshine as possible, must not be expected to do anything else than succumb to a fate which cannot be long delayed.

6th, *Too Limited an Extent of Border.*—To make a narrow border however well of so many feet in width when the Vines are planted, and to leave them unheeded or uncared for in this respect, is a matter attended with no small mischief. More particularly does this apply to localities where the surrounding natural soil is not suited to the nature and requirements of the Vine. Vine roots travel farther and quicker than many imagine, and their inclination if left to themselves is always outwards and onwards, yes, and downwards, too; and I think I am correct in saying that it is upon the farthest-off roots from the stems of the Vines that their produce and condition depend more than on those nearer home, however good may be the medium. The nearer you get to the stem the fewer of those greedy, active rootlets or fibres are to be found. They are to be met with in greatest abundance at the extremity of the border, and any one who has lifted old Vines to preserve their roots need not be reminded how strikingly this is the case. This, then, is the place where nourishing matter ought to be most applied to the roots. The plan of making a yearly or biennial addition in width to a Vine-border is the surest way of maintaining health and vigour. Hence it is strongly to be recommended that borders should be made by degrees, and to a greater width than is general; and when circumstances render it imperative to circumscribe the field, and the surrounding soil is bad, the border should be surrounded with brick and cement, though which the roots cannot escape. After this every encouragement should be given to make the roots multiply near the surface of the space to which they are ultimately confined. In cases where there was nothing more formidable than a path or walk in the way of the roots getting through to a good wholesome soil, where they could ramble without injury, I would say, Up with the walk at once, if its position cannot be altered, and reconstruct it by filling up with rough stones, good loam,

and bones, and let them feed under your feet for a while and then pass on.

7th, *Fungi.*—These are not only injurious to the Vines, but are certain death to a great many. They are produced in numberless instances by the liberal use of leaf mould, with bits of wood, Beech-nuts, &c., intermixed with it, which in a certain condition of soil, as to dryness, very soon fills the border, particularly inside and under the arches of fruit walls, with fungi. These seize on the roots of the Vines, and work sometimes up the stem, rupturing the tissues, and literally killing the Vines; and when they do not prove so fatal, it is considered that they so permeate the soil that they exhaust it and render it less healthful and available for the Vine. Everything in the shape of pieces of wood or imperfectly decayed leaves should, therefore, be avoided in any soil which is intended for Vines.

Such are what I conceive to be the most prominent dangers which beset beginners and others of little practice and experience, and who have not studied this subject to any extent, and I trust these remarks will be found useful.

D. THOMSON.

GROWING EARLY PEAS IN THE OPEN GROUND.

THE frequent failures in the early sowings of this much-esteemed vegetable are, in a great measure, owing to the ground not having been properly prepared for the reception of the seed. The ground in which Peas are to be sown should be trenched fully two spades deep, shovelling up the bottom of the trench as the work goes on, and dug over twice with a five-pronged digging-fork one month at least before the Peas are sown.

I will detail my own successful method of sowing. I choose a fine day, and having at hand the following mixture:—One bushel of newly-slaked lime, half a peck of fresh soot, and two bushels of hotbed manure almost in a state of dust, the whole well mixed up together.—I stretch the line where the Peas are to be sown, and spread this mixture at the rate of three bushels and a half to every 20 yards, and about 1½ foot wide along the side of the line. I then fork it in about 15 inches deep, mixing it thoroughly with the soil. I again stretch the line down the centre of what I have dug, and draw a drill 2 inches deep and rather wide, and sow the Peas at the rate of 1½ pint to every 20 yards of drill. I draw the soil over the Peas with the rake, and then sprinkle over the drill some sifted coal ashes, or some river or drift sand having a little soot mixed with it.

Last of all, I stretch a line of cotton along the drill about 2 inches above the ground, not forgetting to apply a few mouse-traps baited with peas.—DAVID PRATT, *Gardener, Ashleigh, Ireland.*

EVERGREENS AS ORNAMENTAL OBJECTS BY THE SIDES OF RAILWAYS.

THANKS to railway travelling, the superior cultivation or management of one district is not likely to be confined to that locality alone; for the inquiring gaze of some professional traveller or of the pleasure-seeking tourist will be sure to pounce upon it, and straightway it goes into print. If by accident the writer's views are erroneous, he is quickly put right by some one better versed in the matter, and the public at large are in the main benefited by the publicity given; and rapid as are the movements of these public conveyances, the careful looker-on has yet time at places to note down some of the most interesting features of cultivation to be met with in his way.

In the rich valley of the Thames, for a few miles both east and west of London, he will have time to see the great accuracy with which vegetable crops are put in, and the good quality of the produce. Celery, Asparagus, and Rhubarb, as well as the smaller crops of Lettuce, early Cabbage, and the like are all good. Farther from town fruits become more the objects of cultivation, and mixed plantations of Currants and Gooseberries, with Apple, Plum, or Pear trees overhanging them, are succeeded in turn by acres of Peas for market, or it may be Potatoes, for all are wanted; while longer journeys reveal other crops required for the supply of

the great metropolis. If we take a journey on the Great Northern line in the early part of August, an hour's travelling will bring us in sight of some of the largest and loveliest flower-beds in the kingdom—richly scented, too, for several acres of Lavender may be seen in bloom, presenting a mass of flower which we vainly attempt to excel in the parterre. Less gay, certainly, but not less useful, are the acres of Onions grown in the same neighbourhood, and seed is ripened also. A field of Cucumbers is not so interesting to look on; but if the day be hot a disposition to relish an article so cool and agreeable is conjured up. Carrots and some other products are also extensively met with in the same neighbourhood; but the rapid movement of the iron horse leaves the spectator little time to recognise them, and still less to notice the nice little fronts some of the railway stations present if he is borne along by express train.

Considerable advance has been made of late years in the decoration of the waste plots of ground around railway stations, and as this movement is still going on it ought to receive every encouragement. Taking another line of rail, the South-Western; if the train is a slow one there will be plenty of stoppages to see many features in villa gardening, some elegant, others less so; but the general fertility of the first dozen miles or so has much in it to admire. Farther on a less promising country is met with, but all parts have their beauties; and although the enterprising improver sees much on which he thinks a judicious outlay would be sure to bring its reward, we will dismiss that subject. Retracing our steps once more to the great centre of attraction, we will take a short journey by the South-Eastern, and there see if within a very short distance of the starting-point there are not extensive plots of waste ground by the side of the railway itself requiring some one to take them in hand.

Neat, orderly, and even tastefully-planted and kept as are some of the station fronts as well as the gardens which are attached to the stations, especially a few miles away from town, there is, nevertheless, a large tract of waste land on the slopes themselves, near London, that might assuredly be made more productive, and in suitable hands remunerative. This, however, is the affair of the Company, not that of the station-masters, whose efforts to make their premises so attractive deserve all praise. In this age of progress, especially in the decorative art, something more might be done by the great railway companies in patronising gardening along their lines. Notwithstanding the gay appearance of the creepers and other flowers on the station fronts (not forgetting the careful and intelligible way in which the names of many stations are written down on the banks in large letters of flint, a plan which I believe first originated at one of the stations on this line), there is still ample room for some further improvement, which it is obviously the duty of the proprietors of such places to go into—I mean the planting of shrubs as permanent features. Before discussing this matter, however, I may say that many private occupiers worthily emulate each other in their endeavours to present a nice appearance to the railway front, and they may be sure the thousands of passengers passing by applaud them for it. The outskirts of most large towns present some good examples of this.

I remember once noticing some very creditable garden fronts by the side of the Great Western Railway, at more places than one; and by the side of the Midland Railway, at Leicester, were some tastefully cultivated plots, which at the time I saw them were all the more interesting by their being in more cases than one evidently tended by ladies, who were seen thus engaged. Certain localities, however, offer insuperable barriers to much being done in this way. The black country, as it is called, between Wolverhampton and Birmingham, gives little hope of any success; and the cold, bleak districts of still more northern counties admit of but little chance of a luxuriant vegetation, more especially when the atmosphere is tainted with factory smoke or other nuisances.

Returning, however, to the subject of planting evergreen shrubs by the sides of railways, we think much might be done by this means to enliven the monotonous lines of naked cuttings and embankments. Evergreen shrubs are now to be had in great variety and at a cheap rate, and they give a clothed appearance to a place, which deciduous shrubs or trees fail to do; in fact, as objects of decoration

they are more important than flowers, as they are permanent in their usefulness. Considerable variety in outward form and appearance can always be had amongst them, while some of them are second to no bedding plant whatever for the richness of colouring and abundance of their flowers. No *Calceolaria* that I am acquainted with excels the double-blossomed *Gorse* or *Whin* in brilliancy, while the *Broom* is scarcely less so. The *Rhododendron* also affords many other tints, and in winter we have the *Laurustinus*, which no introduction of late years has approached for general usefulness. Shrubs having fine, bright, and shining leaves are too numerous and too well known to require mention. Ask any one having the management and decoration of private grounds, What could be done without evergreens? and the answer would be, that we should be very badly off indeed for seven months in the year without these highly necessary adjuncts; for a pleasure ground without evergreens would be like a house without furniture—very well as far as it went, but deficient in the main essentials for comfort.

I believe some will argue against my recommending the more extensive planting of evergreens by the sides of railways, that they might increase the danger of fires from the passing engines. This, I think, will not be the case. The outer foliage is always green and fresh; and the old leaves dropping in summer would not be in much danger of receiving the sparks when the plants became old, for they would then be covered by a living foliage, and while the plants were young, the presence of grass or weeds would prevent any serious conflagration. It would, however, be prudent to inquire whether any accidents have occurred from fire. We all know that herbage when dead and perfectly dry often enough does ignite and burn to a certain extent in very dry weather; but whether this would be the case with the old cast-off leaves of Laurels, Holly, and other shrubs is uncertain. Judging from the rarity of such occurrences amongst shrubberies kept by private individuals, there is reason to believe that fire will not be likely to occur; or if there were any danger, it would be easy to avoid coming near dwelling-houses, or other valuable property of a combustible kind with such plantations. At the same time the examples of such companies as have ornamented a portion of their line, or at least the environs of their stations in this manner, may be consulted; and if the shrubs are not liable to take fire, then let their example be copied if practicable.

That such examples exist need not be told, but they are less numerous than they ought to be. The best that I have seen are on the line of railway from Birkenhead to Chester and some other places around the latter city, and the clothed appearance which the evergreens gave the sloping banks and outskirts of the station certainly struck me as well worth copying. The time I saw them being summer, there was no lack of foliage elsewhere, but they looked well, and doubtless appeared to still greater advantage when summer flowers were gone and deciduous trees were devoid of verdure. In the long winter months they must exhibit that lively appearance which enhances their value so much in the dressed grounds surrounding a private residence; and if patches of them were more plentifully scattered along the line of some of the important railway arteries, an impetus would be given in a direction both useful and ornamental.

Before closing these notes, I will observe that some railway cuttings and embankments exhibit of themselves several interesting specimens of indigenous plants. Some of those through chalk present *Wallflowers*, *Antirrhinums*, and *Valerian* in great abundance, the last-named very showy indeed. *Heath* and wild *Thyme* are also beautiful; while some sandy districts are crimson with *Poppies*. The native *Heaths* are also found in abundance in the proper localities and ever and anon the *Ox-eye Daisy* presents its starry front. But as there will still be ample space left for these after the evergreens noticed above are all planted, it would be only multiplying the objects of attraction to sow such. And if the time should ever arrive when the good-keeping of our railway embankments, cuttings, or waste lands equalled that of our public or private gardens, and their products though less numerous were likewise interesting, those who were pioneers in such an ornamental work would deserve the grateful acknowledgements of their neighbours. It is, therefore, to be hoped those railway companies having the means will set apart a sum for this purpose, and at the

end of two years they will find that whatever sum they may have appropriated to this purpose will have borne better fruit than double the same amount that may have been expended in law matters, waged against some rival company for an object of little importance to any concerned excepting, perhaps, to those learned gentlemen of the long robe, whose actions, unlike those of the plauter, become the worse by being fully carried out, and in the end realise but little of any importance excepting misfortune to those concerned, and certainly nothing whatever to the outside public.

J. ROBSON.

VARIEGATED BALM—TRAPPING SLUGS— HABITS OF WORMS.

I NOTICED a short time since in your Journal, that a complaint was made that some Golden Variegated Balm had become green, and I beg to say that I purchased a plant from Messrs. Carter & Co., in September last, and the new growth since then is more brilliant than the old.

I have tried iodine and starch for trapping slugs, as recommended in your Journal, and find that they are attracted, but not more so than by slices of Swedish turnips. The pieces must be examined in the evening between the hours of eight and ten. I lately found twenty slugs of different sizes on a piece of turnip which I had placed near a plant of *Stachys lanata* which they were completely destroying. The best plan is to throw the turnip with the slugs into a vessel of water, which can be brought into the house. The turnip should be then taken out and some lime thrown into the water. The pieces of turnip will last a long time. No other kind of turnip than the Swedish will answer.

Why do the large worms draw stems, pieces of stick, and anything of the kind they can move into their holes, and gather all the small stones within their reach and pile them in a heap over the entrance?—J. L.

[We have always considered that worms draw vegetable substances into their burrows to feed upon them whilst decaying; and the heaps of pebbles they collect over the entrances of their burrows we have similarly concluded were to preserve a temperature agreeable to the tenants.]

VINE-GROWING AT THE BERKHAMPSTEAD NURSERY.

WILL you inform me whether we are to understand Mr. Fish as saying, in No. 142, page 472, when explaining the manner in which Messrs. Lane plant Vines, that nine-tenths of the trouble and expense of making Vine-borders is unnecessary, and that by procuring a quantity of tan and loam, just sufficient for the roots to run in, success is as certain as if the Vines were planted in a border thoroughly prepared?

Are we also to understand that the natural loam of the common *Wiercin* Roses, *Rhododendrons*, *Portugal Laurels*, *Deodars*, &c., grow most luxuriantly, and where *Araucaria imbricata* grows so compactly and beautifully "as to be worthy of being photographed and engraved," is only to be obtained in very few places in England? If so, I think Mr. Fish is not sufficiently plain in his article on that subject.

I also feel inclined to think that unless the above questions are answered, many gentlemen will feel disposed to consider that they have been put to useless expense in the preparation of their Vine-borders, although the situation, soil, &c., may have been altogether very different.

I do not ask for these explanations in a captious spirit, but because I think Mr. Fish is not so lucid in the statement referred to as I generally find him.—F. D.

[We beg to assure "F. D." and all other friends, that we have a strong impression that the man who cannot bear even unfriendly criticism and make the best of it is thoroughly unfit to write for any periodical, and the best thing he can do for his own comfort is to keep his opinions and facts to himself; and this, too, will generally be best for the community, as it is seldom that thin-skinned people have much of value to communicate. Friendly criticism, on the other hand, must ever be very agreeable, as it shows that attention has been paid, and affords an opportunity of giving explanations of matters that otherwise might seem

obscure. Whilst pleased, therefore, with the approbation as to our lucidity in general, we are sorry that the article at page 472 is not sufficiently plain to our correspondent; and we regret this all the more, since, by looking over it, we fear it is not in our power to make it plainer or more lucid. However, we will try, and thus at least show that we are willing to oblige.

The only error that we see worth noting is that made by our own carelessness or a slight slip of the engraver, by which the border, as shown on the south side of *fig. 2*, is higher than it really is. As far as we recollect, it will scarcely be two-thirds of the height there shown, and we mention this just to show that the border made above the natural soil was even more shallow than is there represented.

Now, before answering the two chief questions, our correspondent will allow us to remind him, first, that a critic should be sure to quote correctly the opinions which he chooses to criticise; and, secondly, that what is said of these Vines is less a reference to opinions and recommendations of peculiar systems than it is a mere statement of the facts of the case.

In answer to the question if the loam of the common is to be matched in few places in England, we should say decidedly. Yes, in abundance of places, especially where a gardener could get liberty to take the surface from upland pastures, or even to skim the surface turf from the sides of some old highway in a loamy district. The loam on the common is very good brown stuff; but there is plenty as good at no great distance from most gardens, provided the gardener can obtain it. But in many places you might as well cut down some old tree as obtain leave to move a sod of turf. In the description of the things that are grown at the common, a good way off from the Vine-house, our correspondent speaks of "*Araucarias* growing so compactly and beautifully as to be worthy of being photographed and engraved." Our words are, "Among the large quarters of fine *Araucarias*, there are two or three so compact and beautiful," &c. We think we should have added "plants" after the word "three," as it was these two or three specimens, and not the fine *Araucarias* in general, that we deemed worthy of being photographed, as being out of the common way.

To the second question, "Is the preparation of Vine-borders unnecessary?" we unhesitatingly reply, By no means. Nor do we see that we have said a word to lead gentlemen to grumble at the expense of a Vine-border, providing good Grapes are produced from it. The making or not making a border had nothing to do with our statement of the facts of the case. As a rule, when we have said anything on the subject, we have recommended such borders to be elevated and drained. We had just been describing how such borders were carefully made at Keele Hall and Trentham, and had we the chance it is such modes we would like to follow, and especially for Vines that were wanted to ripen fruit at all early. But that had little to do with the propriety of chronicling the fact of very successful Grape-growing with but little of this careful preparation. No mere opinion, no advocacy of systems, will neutralise a fact. Of course, the roots would not be confined to the narrow border. Measures are even spoken of as in contemplation to secure continued fertility to the Vines by making the inside border. There can be no question, however, that there are many positions in which the Vine will flourish as well or better in the natural soil than in any soil that can be given to it, unless a pasture could be thinly pared on purpose and all stagnant moisture guarded against. The late Mr. Wilmot, of Isleworth, grew first-rate Grapes from Vines that were planted in a path amongst clinkers and boulders. The late Mr. Glendinning, at Chiswick, had fine Grapes that, as far as we recollect, seemed to have little better to grow in than a rough gravel walk. No doubt many other instances may be given. No doubt there is something in the natural soil at Berkhamstead that suits the Vine besides the little fresh loam that was given to them. That can only be known on trial. One thing such a fact as our statement proves abundantly, and that is the impropriety of going down from 2 to 6 feet and clearing all out to form a border, which will be no higher, or perhaps below, the surrounding level, instead of making the border much more easily by placing it chiefly above the surface level. The Vines at Berkhamstead may at least give us a lesson in the simple modes of treatment.

We should also bear in mind that having first-rate Grapes in May and in September requires rather different conditions for insuring success.—R. F.]

ROOTS AND LEAVES.

(Continued from page 371.)

FIBRES are formed in proportion to the wants of the stems and leaves; are increased by transplantation and a poor soil; and destroyed by transplantation, improper and too rich soil, and stagnant water. There are many minor causes of the increase or decrease of fibres, some of which will, no doubt, be brought to light in the course of inquiry. Transplantation has various effects, and is resorted to, first, to increase the formation of the fibres or mouths of a plant; second, to check vigorous and rampant growth; third, it is simply the removing of a plant from a place where it is not wanted to one where it is desired.

Transplantation with the first-named object in view is chiefly practised on Lettuce, Celery, and the Cabbage tribe. Pricking-out breaks the radicle or perpendicular root, and from it fibres are abundantly emitted close to the stem. This enables the cultivator to transplant with a ball one mass of fibres, the operation itself causing the emission of more owing to their extremities being cut off; but there are sufficient spongioles in the ball to absorb the copious waterings that follow transplantation, and to prevent the leaves flagging, which would take place if the plant had nothing but its leaves and the naked root-stem to absorb moisture. The pricking-out of anything is simply robbing it of a few roots to give it more, and to bring them nearer the stem, so as to enable the plants to bear removal better. Transplantation not only increases the number of mouths, but induces sturdy growth, small stems, and large leaves. It also enables the cultivator to place food in close contact with the feeders, whilst if not practised it would be of little use placing food near the stems, for the radicles would soon run through it, having the fibrils at their extremities: therefore, rich soil near the stem would yield no nutriment to the plant. The aim of transplantation in this case is to limit the radicle root-action to a minimum, and promote fibry root-action to a maximum. It is the fibres that are wanted, for they give sturdy growth and large leaves with but little stem, and the larger the leaves the more useful are vegetables.

Transplantation, however, in certain cases is not beneficial. Tap, fleshy, or otherwise fusiform-rooted plants, as Carrots, Parsnips, and nearly all tuberous roots, are deteriorated by transplantation. Roots, nevertheless, that emit a quantity of fibres, and have the root for the most part or wholly above ground, stand transplantation better than those with the root underground; but the effect produced is not uniform in varieties of one species. For instance: White Turnips will not do well after transplantation, but Swede Turnips transplant as freely as Cabbages; Red Beet does not transplant well, for it is apt to become stringy and woolly after transplantation; but Mangold Wurtzel is equally fine transplanted as when allowed to grow where sown. Transplanting Potatoes, or any root crop, is not necessary, except to fill up gaps in the main crops. Potatoes and Jerusalem Artichokes transplant freely when the top is but a few inches in height. In a cottager's garden last year I saw a bed of Potatoes with the sets about 3 inches apart every way, and was struck with the novelty of the system. He had taken a plot of garden ground, and did not come into possession until the 12th of May, and by transplanting the Potatoes he was likely to obtain a prodigious crop, whereas had he kept the sets out of the ground until he took possession of the garden, he would not have had a crop worth mentioning. The gardener does nearly the same with his other crops. He raises his plants in small beds, and then transfers them to their final quarters, very often ground in which a few days before some other crop was growing. If the seed had been sown when the previous crop came off much time would have been lost.

Transplantation should be practised with everything that will bear it. It saves space, insures a quicker and more certain rotation of crops, and increases the vigour and productivity of plants. It also enables them to stand changes

of temperature better, increases their supply of nutriment, for many mouths require more than few, and enables the plant so treated to derive the greatest possible amount of benefit from the food supplied. Transplantation is identical with repotting a plant. We do not plant a cutting in a No. 1 pot at once, but we put it in the smallest size possible, and when its roots have run through the soil in the small pot, we shift it into one a size larger, and not into the pot which it will require as a specimen. We are not long before we repot again, and so on. But what is all this repotting and trouble for? Why not put the plant into a large pot at once? Some will tell you that cuttings always strike more freely when placed round the sides of a pot; but what can burnt clay have to do with the striking of a cutting? Really nothing. We are aware that if we at once place a small plant in a No. 1 pot, it never makes so fine a specimen as a plant which is shifted from a 60 into a 48, 32, 24, 16, 8, and 1. There may be no difference in the compost, either in quantity or quality; nevertheless, the once-shifted plant wastes more than it collects, but the other uses every particle of nutriment the soil contains. The roots of one are not confined, those of the other are. Their case is the same as that of two farmers, of whom one turned his cattle into his field when the grass was grown a little, whilst the other would not allow his to be turned out until the grass was fit for cutting and making into hay. The first knew that there was enough grass for his cattle to eat at once, and that by the time they had eaten it more would be grown or growing; but the other calculated that the more food there was the more the cattle would eat; and he, like many advocates of the "one-shift system," forgot that they would eat their fill and then waste the rest. The parallel between the case of the farmers and their cattle, and shifting a plant often and but once, is exact. The one plant is supplied with food to meet its wants for a certain period, and by the time that is exhausted more is given as its necessities require. The other is supplied with the food it is to have during its existence; but, instead of husbanding its means, it lavishes it away in gross growths, and very soon has run through its allotted space from which there is no returning, the fibres matting round the sides of the pot, and leaving the ponderous ball for the most part unexplored. Roots naturally never return to collect food once neglected or not wanted, but their business is extension outwards from the stem; and much as some people talk about roots being attracted by food to grow in a particular direction, they never yet have told of one instance in which they knew it occur. We always find roots most plentiful round the sides of a pot, and this has led many to conclude that the pot attracted the roots. If we dig round a plant and put in an edging or division of stone we find them matted there as in a pot. The sides of a pot simply prevent root-extension, cause the multiplication of fibres, and act in the same way as transplantation. They limit the roots to a given space, and the food is given in a more concentrated form than when the roots have unlimited space to run through and collect nutriment from.

The second reason for transplantation—to check over-vigorous growth—is of great importance to all cultivators, and is resorted to in order to induce fruitfulness. The operation requires skill, and should only be done when other remedies have failed. I have seen root-pruning practised where there was no necessity for it. It is well to see that a plant is not too highly fed, and what judiciously stopping the branches, and exposure to more light and air will do towards removing barrenness and promoting fertility, before such an extreme measure as root-pruning is adopted. Simply draining the land in many instances increases productiveness by freeing the soil of the superfluous moisture which rendered it cold, and induced late growths in autumn instead of the ripening of the wood. Stopping gross shoots to a certain extent limits root-action, and in many instances promotes fruitfulness, but may also create a multiplication of rank growths. When, however, any of the above means have been adopted and fail to induce fruitfulness, root-pruning and lifting may be successfully resorted to. Small trees may be lifted without checking growth too much. The operator will be careful to retain all the fibres that are near the stem of the plant, pruning only the thick roots most distant from it, with the object of causing fibres to be emitted nearer the stem than

hitherto, the aim in a case of this description being to promote the action of the fibrous roots, and thus cause food to be collected slowly instead of rapidly as before lifting took place. The operator must discriminate between a plant with an unbragous head and one which is of erect growth. The fibres of the former are situated at a greater distance from the stem than those of the latter: a greater root is, therefore, necessary to be allowed the former than the latter. The head of an unbragous tree keeps off the wet, and so destroys the fibres near the stem, so that the fibres are situated at the outside of the space sheltered by the head.

In lifting any plant to induce fruitfulness too many fibres cannot be preserved on the roots, nor can the roots that strike perpendicularly into the soil or travel a great distance without emitting fibres, be brought by pruning too near the stem. In the almost total absence of fibres root-pruning should be limited to removing the thickest and oldest roots, for these rarely emit fibres of any consequence, whilst the young and small roots should be scrupulously preserved. Very vigorous trees may be deprived of half their roots, but weak growers and such as have naturally many fibres cannot have too much root left on removal. The roots in all cases should be spread out upon the surface, and be above rather than below the adjoining ground level. They will emit more fibres by being near the surface, derive more benefit from rains, and be more under the influence of the sun than when planted at a greater depth. Any one at all acquainted with meteorology knows that the temperature of the surface of the earth changes with that of the surrounding air; and it is only common sense to conclude that the more the roots of a plant experience the changes to which the head is subjected, the more uniformly will they be able to work. Roots at a great depth are not so suddenly influenced by the atmosphere as those situated near the surface, and so continue to act irrespective of the head; hence deep-rooted plants do not suffer so much from drought as those with roots near the surface. But this advantage is more than counterbalanced by another circumstance—they are continually transmitting sap to the stems and leaves, and so force the half-ripened buds into growth by a superabundance of food which the leaves cannot fully elaborate, and so growth progresses; whereas the whole vital energies of the leaves are, when the roots are near the surface, concentrated on the ripening of the wood and the maturation of the buds at their axils.

Trees that are old and large may be partially cured of barrenness by digging round them at about half their height from the stem, and cutting all roots that travel beyond that distance. If the roots, however, are deep it is necessary to lift them in order to promote fruitfulness; but this operation, in many cases, cannot be performed. In such a case ringing the stem, although a barbarous system, is often very successful; but caution is necessary, for an old tree is sooner killed than a young one. Ringing is simply taking a portion of bark from the stem at its junction with or a little above the roots. If about an inch be thus taken from the stem halfway round it, leaving the other half unmoistened for the elaborated sap to return by, and a ligature of moss is bound round the ringed part, it is not improbable that a callosity will be formed there; and if so, the moss should be kept moist, so as to further the profusion of roots. On their appearance soil must be placed for the roots to extend in, and when these attain any dimensions the other half of the stem may also be ringed, by which means many trees might be provided with a new set of roots, and measures taken to prevent these penetrating too deeply into the soil.

Peach, Plum, and Apple trees very often form large knots or excrescences just above the surface soil; but this is not a case of vigorous root-action, but the reverse. It is an effort of vegetable life to provide new parts necessary to the existence of the subject. If soil be placed around these protuberances and kept moist, in time roots will be put forth, and the vigour and healthfulness of the tree will, as a necessary consequence, be increased. Many trees now prolonging a miserable existence by growing in an improper soil or otherwise lacking support, might thus become resuscitated without the expense of making new borders and waiting for the production of fruit.

Although these excrescences are mostly formed between the roots and the origin of the branches, yet there are instances in which they occur along the stem at some dis-

tance from the root, and not unfrequently along the branches. They are always more or less indicative of imperfect root-action, and are more common on the Apple and Plum than any other fruit tree. If boxes be made to hold earth near those parts and the soil be kept moist, roots will be emitted from the excrescence, and, if afterwards duly attended to with water and root-action encouraged, the box will soon become full of fibres. The stem may then be cut below the box; the part above unnailed from the wall if trained to one, and lowered to the earth, when it may be planted, and if watered in spring it will start into growth and make a fruitful tree in half the time that a young one would, and have in addition the advantage of being on its own roots. I cannot think any plant improved by growing on other roots than its own, though in this way we are enabled to grow many plants unsuited to the soil of the locality where we happen to be situated.

Lifting is practised on miniature or dwarf fruit trees pretty extensively, and has for its object the limitation of root-action in proportion to the demands of the head. It causes the production of fibres, gives a plant many mouths, but of an annual character: hence, the plant is fed slowly, the growths are small, and the leaves and fruit large in proportion to the size of the tree, and the wood short, close-jointed, and well matured. The roots never travel far, but are kept near the stem; therefore, an addition of rich soil mostly accompanies the operation. It is seldom that trees so treated need lifting oftener than biennially, and not always then; but whenever the trees show a disposition to make wood which does not by stopping yield fruit-buds, it is an indication that they need lifting. A certain amount of root-pruning is practised in such cases, but it should be limited to thinning and shortening the fibreless roots.—G. ABBEY.

(To be continued.)

PLANTS IN FLOWER AT CHRISTMAS IN THE ISLE OF WIGHT.

THE climate of Great Britain is proverbial for its changeableness, yet in few countries is the population more healthy. My present object, however, is not to speak of the inhabitants but to make a few remarks upon the weather which we had here last autumn, and to give the names of the principal plants which are now in flower out of doors without having received any protection. I do not remember any Christmas-day so much like that which is just past as the Christmas of 1837, which more resembled a beautiful day in September than the time of Christmas logs, cheerful blazing fires, and merry games upon the ice. 1837 was my first year in England, and having come from a good way north, where the frost generally comes on much earlier and with more intensity, I was then much surprised, having seldom seen the grass fields so green in the end of September. We mowed all the short grass in the pleasure grounds during last December, and some of it is now too long, and we must be at it again with the scythe, unless frost visit us soon and check its growth. I may remark, that it is far from desirable to mow short grass in December, for it will not stand well against the scythe in many places from the thinness of its growth, and the mowing machine is out of the question while everything keeps so damp.

To return from this digression. In front of the greenhouses are several sorts of Fuchsias, which remain in the border all winter, being merely cut down to within a few inches of the soil, and then protected with old mat several times doubled, so as to be some inches thick, with a few pegs round the sides to hold it down. These Fuchsias are not now generally grown, but were considered good eight or ten years ago. They grow up quite vigorous in summer, and when neatly staked they present a very gay appearance, rising above the lower flowering plants. In the same border are now in flower Tom Thumb and Christina Geraniums, Virginian Stocks (very gay), Mignonette, several sorts of Roses, and the common Marigold; more in the open ground there are blue Ageratum, Cuphea plancycentra, Virginian Stocks, Mignonette; *Calceolaria Amplexicaulis*, *Rugosa*, Prince of Orange, *Ancea floribunda*, *Latifolia*; several sorts of Nosegay Geraniums; *Veronica speciosa*, *Lindleyana*,

and the variegated-foliaged one; several sorts of common Fuchsias, such as the old and low-growing Globosa, and Coccinea. No doubt many others would have been in flower had we not destroyed them in order to dig the borders and beds, those enumerated growing in a few of the mixed borders.

Of more hardy plants now in flower, there are a good many Roses, Wallflowers, and several splendid bushes of Laurustinus—a shrub which tells well at this dull season. A bush of Laurustinus of from 6 to 8 feet high, and fully as much in diameter, having its whole surface about equally divided between its open bunches of flower and the green leaves, is a beautiful object, and the property which the plant has of flowering in winter is to my mind a great recommendation. *Coronilla glauca* is now nicely in flower, its yellow blossoms contrasting very pleasingly with the beautiful green foliage; also many of the common yellow hedgeside Primrose. Of *Leycesteria formosa* the flowers are nearly over; they are never very pretty, but the racemes of fruit clustering and hanging down from the ends of the slender curved branches always render the plant an object of interest in the shrubbery, and the graceful curving of the branches affords a pleasing contrast with the more stiff outline of most other shrubs. Chinese Privet is another shrub, which is much to be recommended from its flowering at the duldest part of the year. Several plants of this have been in flower for six weeks. The common Furze, from its telling effect when in flower at this season, is well worthy of a place in a shrubbery, especially if in a neighbourhood where it is not to be seen growing naturally in the hedges. *Chrysanthemums* have given a very good display this autumn, some are very gay yet. Of Violets we have had the single blue Russian in flower for six weeks or more, and now the light blue Neapolitans are in flower. The common Daisy is plentiful.

I saw it stated in the newspapers, some time ago, that green Peas were gathered, not far from here, in the middle of last month; and with reference to this, I will just remark that these were from old Peas which had stood over from the month of August, when they had been sown to give a late autumn crop, and that the dull, cloudy, and rainy weather which followed prevented their yielding a full crop; at least such was the case at this place, where our late-sown Peas were much torn about by the wind, otherwise they would have yielded green Peas quite as late. We pulled them up three weeks ago, and then they had many flowers upon them, and about a teacupful of Peas. I give this little account of having green Peas in the middle of December partly to rectify a popular error, many supposing these Peas had not been sown any length of time.

Many winged songsters have been inspiring us all through December with their cheerful voices, reminding us more of April than dark and dull December.—G. DAWSON.

[Besides the foregoing we have received the following:—

“As a proof of the wonderful mildness of the season, I send you three flowers which I have just picked (Christmas-day) in my open garden, and which I think will interest you. They are *Acacia* (*longiflora*?), *Lardizabala bitermata*, and *Euryops punctata*. The *Lardizabala* is nailed against an east wall; the other two are in the open border, but in rather sheltered places. The *Euryops* is a mass of blossom.—H. N. ELLACOMBE, *Bitton, Bristol.*”]

THE STRAWBERRY CONTROVERSY.

A WORD IN CONCLUSION.

THE Strawberry controversy is terminated, and it is quite obvious that Mr. Reid has fully made up his mind to pursue his own course, and he is perfectly right in so doing since the result is satisfactory to him. So, on the other hand, I shall adhere to the system that has proved very profitable here, and which system I have seen adopted in other places, and always with success.

In the year 1860 I happened to be in Edinburgh, where I saw the scythe in operation mowing off all the Strawberry leaves, and in the following season the result was a very good crop of fine fruit. Whether it was the annual practice there, or whether it was done merely as an experiment, I

am not prepared to say; but at all events it was in the Experimental Garden, Inverleith Row.

A friend, the other day, wrote to me as follows:—“I have read with much interest the Strawberry discussion between you and Mr. Reid. I must certainly coincide with your statement, for it is the same system as I adopt, and it leads to good success, so far as a good crop of fine fruit, strong plants, and tidiness are concerned, and that is all we can possibly wish for in that department. When at Thorndon Hall we used the scythe for that purpose, after clearing all the leaves off, and likewise the fern that was laid down for the protection of the fruit against dirt, &c. The beds were then manured and forked directly, and I am sure no one could wish for finer fruit or stronger and better-looking plants than those were. I never before heard of Strawberries requiring protection in winter.”

I should be most happy if Mr. Reid could make it convenient to pay me a visit in due season—say in the beginning of June. I should feel a pleasure in pointing out to him every plant that has been subjected to this treatment in order that he might see and judge for himself; therefore I give my name and address.—JAS. BECKETT, *The Gardens, Cranbrooke Park, near Ilford, Essex.*

VISITS TO GARDENS PUBLIC AND PRIVATE.

DANGSTEIN.

WHAT lover of horticulture has not heard of the Lady Dorothy Nevill?—of her ardent love for and liberal encouragement of all that pertains to a garden, and how she has made Dangstein a household word amongst the lovers of flowers? Could it be otherwise, then, when ministerial work called me within eleven miles of her residence, that I should desire to see both it and its fair and noble owner? But how to get there was the difficulty. It does not lie in the way of railways; omnibuses don't run there; and to walk it was rather beyond my powers on a dull November day. But a friend in need came to my mind, and, mounted on one of Lord Leonfield's horses, and armed with a letter of introduction from his lordship, I set forth; and in truth it was a ride full of many memories. The road lay through Midhurst, where thirty-three years ago I had been a school-boy. And as I rode through Cowdray Park, then the residence of the Poyntz family, and now of Lord Egmont, how many a spot came back to my recollection! There, on the hill, stood the grove which had been the scene of many a storming party; here the avenue of noble trees under which Easebourne Fair used to be held; and there, long before Aunt Sally was invented, with a gusto, equal to that of noble dukes and earls engaged in its modern rival, did we undertake to knock over Jack-in-the-boxes, and other valuable and important treasures. There, before my eyes is a clasp-knife, which, I remember at the time I considered equal to the finest production of Toledo or Damascus, fell to the prowess of my aim—alas! to find out that it was only a bit of soft iron. And then, as I passed the old school, with what a melancholy feeling did I see its windows broken, tiles off, “its garland fled, and all its halls deserted”—all the more sad because, owing to the obstructiveness of one trustee, who, worse than the dog in the manger, will not consent to its passing into the hands of the Charity Commissioners; but one feeling above all others predominated—thirty-three years had passed since I had been there.—Of my schoolfellows many, indeed the greater number, had passed away from my memory. But one I had met last year—a clergyman, with, of course, a flourishing family; another is a major-general in the army; another holds high rank in a highland regiment; and so on. But I myself? Why, I had passed through many a varied scene since then, not one of which I then cared to know; but I could say that “goodness and mercy had followed me;” and that, however exalted might be the position in life of those who started with me, I had that for which I would not exchange mine, humble though it was.

Well, I must not sermonise, but hasten on to Dangstein. Let me, however, say a word about the gardens at Petworth House. I endeavoured to give some idea of them during the summer, and when in their fulness of fruitfulness; but I like to see what a gardener is doing during the winter

months, and what preparations he is making for a future campaign. Here it was just as I expected. An abundant crop of Mushrooms testified to the excellence of the plan adopted here. The houses were all in good order. Some had been improved since my last visit. In the pits Asparagus was being cut, and Beans were being gathered. Cucumbers were abundant, while some fine Grapes were hanging in one house, full and juicy as in August; and altogether there was just that order and care which one might have expected from Mr. Jones's well-known practical and scientific gardening. I found that he made the same complaints with regard to Apples and Pears that have appeared in your columns already, and which "M. J. B." has descanted upon in a contemporary. Specks appear "without rhyme or reason," and then away goes the Apple or Pear, while many of the latter ripen months earlier than they ought to do; so that, notwithstanding an abundant crop and an admirable fruit-house, he expected soon to run short of his supply. Amongst Apples there was not one that tasted or kept better than the Cackle or Nutmeg Pippin.

Some places celebrated in the horticultural world have attained celebrity by the beauty of their situation, or the picturesque character of their grounds, or by the extensive character of the gardens. The fame of Dangstein rests on none of these. It is situated on an eminence which, indeed, commands a very extensive and beautiful view. Before it are the South Down hills; while on one side the valley of the Rother on towards Midhurst and Petworth, on the other the Hampshire downs, give great diversity and beauty to the view. But there are no grand avenues of trees, no noble specimens of the forest, no umbrageous valleys or "bushy glens;" the whole place looks new, and the most interesting portion of it is so. To make it what it has been a work and labour indeed, but it has been one of love; and under the excellent taste and openhanded liberality of its owner, and the scientific management of Mr. Vair, Dangstein has become a famous place—famous for a collection of plants of such rarity and beauty as are seldom to be met with save in public institutions. It would be useless and uninteresting to transcribe the names of the various productions that the numerous houses contained, for it would be simply to copy out the most noticeable plants in a modern catalogue, and to add to them some which never find their way there. I shall, therefore, simply notice a few things that struck me as exceedingly interesting either for their rarity or excellent cultivation. To me the glory of the houses, as far as the latter point is concerned, were the *Ancetochilus* and the Lattice-Plant (*Ouvirandra fenestralis*). One generally sees the former in small collections, half of which are in a moribund state—"fogging off," as the technical and significant term is. Not so the Dangstein collection under Mr. Vair's management; all were in good health. Healthy and well-foliated plants of *A. setacea*, *petala*, *Bulleni*, *Veitchi*, *Lowii*, *Lowii virescens*, *xanthophyllus*, and many others amply testified to the excellent and skilful management which had led to such results; and certainly nothing can well be more beautiful than the rich and varied markings of their beautiful foliage, but these were exceeded even by the wonderful growth of the *Ouvirandra*. Mr. Vair told me that when first received the greatest difficulty had been experienced with it, that various "artful dodges" had been tried, but all had failed until it was determined to let it "gang its ain gait;" and the result was that, like most wilful things, it did well when it had its own way. One plant had two hundred of its beautiful and curious leaves on it, while a number of its progeny were flourishing in small pots round it. Another plant seemed to be equally vigorous, and, in fact, there was no more trouble in growing it than a Water Lily. In the same house were some fine Pitcher-plants; amongst them *Nepenthes Dominiana*, the pitcher of which holds nearly three-quarters of a pint of water; *Sarracenia flava*, *purpurea*, and *variolaris*; and some rare and beautiful Filmy-Ferns. Amongst the plants remarkable for fine or curious foliage were *Aralia papyrifera*, *Cheirostemon platanoides*, *Monstera deliciosa* (*Philodendron pertusum*), *Saururus Gardneri* flowering from the axils underneath, *Dracaena draco*, a shoot of the famous tree at Oratava in Teneriffe, supposed to be the oldest tree in the world, presented to Lady Dorothy Nevill by Mr. Skinner; *Ananassa sativa variegata*, *Ficus ferru-*

ginae and *elastica*, *Rhopalas*, and the plant which produces the vegetable ivory.

In the fernery were some remarkably fine specimens, as well as many rare and curious varieties. A noble plant of *Cibotium Schiedeii* is in the centre of the house; then there were *Cyathea medullaris*, *Alsophilas*, *Davallias*, *Lastreas*, *Todeas*. The silky-looking material which envelopes the opening fronds of this fine Fern are extensively used as a styptic, and much of it finds its way from here to London for that purpose. Here, too, was a case of *Hymenophyllum tunbridgense* most beautifully managed. A sort of loose wall was built up in a glass case in a dark part of the house, and the Fern was planted amongst the stones, and had thriven most admirably; in fact we have never seen it in such thoroughly good condition.

Most interesting, too, is the tropical fruit-house. Here *Passiflora quadrangularis*, with six or seven dozen of large and ripening fruit ran over the house; while in it were planted Loquats, Mango, Guavas, &c. The Loquats were bearing abundantly, as do the Guavas. The Mangosteen has proved to be a wrong kind, greatly to the disappointment of both the owner and the gardener; for this is the fruit of which it is said it is worth a voyage to Singapore to eat it. There were, besides, the Nutmeg and Pimento, Rose Apple (*Eugenia jambos*), and various other rare and seldom-met-with fruits. Of course there was no lack of the more ordinary fruits to be found in every good garden; and a new vegetable garden has just been formed with immense labour, but promises to repay the trouble and cost, for everything looked in a most flourishing condition.

Nothing could exceed the readiness and zeal with which Mr. Vair entered into the various subjects on which our conversation turned—amongst others, orchard-houses, about which I should like to say a few words; but I must reserve that for another opportunity. It is well known that Lady Dorothy Nevill has been one of the enthusiastic promoters of the *Ailanthus* silkworm culture, and has given us the most readable book on the subject to be met with in our language. She is still carrying it on; and in her ladyship's museum in the Fern-house may be seen specimens of the silk, and the perfect insects and other subjects connected with its culture.

Such is a hasty and most imperfect sketch of Dangstein. I should have entered more into particulars about it, but that a very lengthened and able description of its treasures appeared in *THE JOURNAL OF HORTICULTURE* for December, 1861; and I hope that I have said enough to induce any travellers in that neighbourhood to turn a little out of their way to see it. It is now to be reached from Petersfield (where the direct Portsmouth line now runs), from which it is distant five miles. The gardens and houses are open to view every day except Sunday; and visitors may rely on having every courtesy shown to them; and it will be well for them to see how much the cause of English horticulture owes to such liberal and discriminating patrons as Mr. and Lady Dorothy Nevill.—D., *Deal*.

CULTIVATION OF FERNS.

THERE is no doubt that whatever is worth knowing in horticulture is pretty sure to spread about among the whole gardening fraternity, and those amongst its numbers who pretend to have any secrets by which they are able to command a greater amount of success than their neighbours, may be stigmatised as either self-deceived, or willing deceivers. From being accidentally possessed of some peculiarly favourable condition of soil, climate, water, position, or some other advantage, they either mislead themselves, or would deceive others into the belief that their success is owing to some particular process which they have been clever enough to discover.

That such has been the case I have observed instances; and these knowing individuals, when asked how they manage such and such a thing, give a very wise and complacent shake of the head, and say, "they would not have known how to have done it if they had not studied the matter," and would make believe that they could tell a great deal if they had a mind. Such are just the persons who could tell nothing worth hearing, and generally they are extremely

ignorant of the principles on which the most ordinary gardening operations are performed, and, more than that, they are not only ignorant of their own ignorance, but ignorant of others detecting it.

In the various handicrafts of the mechanic and the artisan there may be secrets profitable to conceal. Among those classes there are some who have amassed fortunes through working out processes known only to themselves; but this is scarcely possible in a calling where Nature is not only the motive, but the ruling power, and must be obeyed implicitly or she will refuse her co-operation. Possibly nothing is more simple than this obedience to the laws of Nature, so essential to successful gardening; and still more probable is it that their very simplicity is the cause of so many straying from them, we being so apt to overlook the fact, that all the operations of Nature are performed in a plain and simple manner, with the strictest regard to economy, and that however Art may assist, it cannot improve Nature.

Nature, it is well known, has many secrets, but she never hides them from observers, and they are only secrets to those who do not inquire after them. Those who do inquire find her as willing to teach as they are to learn. In no place is this more evident than in the garden, for there Nature specially presides.

But there are many people, particularly amateur gardeners, who give the professed gardener credit for a large amount of knowledge he never possessed, and for keeping secrets which never existed. That severe discipline and perfect submission to certain natural laws are necessary to the successful cultivation of plants never enters the head of the inquirer. He attributes success to some artificial process or peculiar handling. The latter may have had something to do with the result, yet such art is but a secondary consideration; and those who fall into such mistakes would do well to consider that all plants and trees that the gardener has to deal with, being possessed of vitality, will not bear to be tampered with—that any deviation from the laws which govern vegetable growth will soon show its unwhished-for results—and that whatever is implied by those laws can be no secret, and belongs to every one, whether gardener or not.

It is some years since I was asked the secret of growing Ferns. The questioner said both herself and others had tried to grow hardy Ferns without success. What could be the reason of it? There must be some secret in the matter, otherwise how had I been so successful? I replied that I did not know that there was any secret in the matter; I planted the Ferns as I would any other kind of plants; probably the soil suited them, and certainly the shady spot they were in was an advantage; if anything more than that, and the abundant waterings they received, contributed to their well-doing, it was purely accidental, and I could claim no credit for anything beyond what I had done.

But, then, I was told by my questioners, that "they had planted their Ferns in loam and leaf mould, and both in shady and open places, and all fared alike. None did any good. What did I think was the cause?" Now, this was a question I could not answer; first, because I had not seen the Ferns or ferneries in question; and, secondly, because I had not given the matter a moment's thought, and so I told my anxious inquirer, who went away as wise as ever.

I cannot say that I have given the matter much consideration since; but I have seen many valuable collections of hardy Ferns in a dwindling, unhealthy state that must give their owners anything but satisfaction, and certainly there must be one or more causes for the failure. It is my object now to point out, if possible, what appears to me to be the cause of the frequent failure in the culture of hardy Ferns. By "failure," I mean where they do not make a free, healthy growth, for I consider that a plant merely existing and making no progress is not worth its room, and is no credit to the cultivator.

To look well Ferns ought to grow freely; and as their beauty consists in the delicate outline of the fronds, both individually and in the mass, their growth ought to be free and perfect, otherwise their beauty is lost, for the season at least.

In order to understand the reason why Ferns do not flourish, it is necessary to be acquainted with the requirements of this particular class of plants; and from what I know I am enabled to state that they differ in no very great

degree from ordinary herbaceous plants, and that they are not so nice as is sometimes supposed, for the more common sorts take readily to any kindly garden soil, and will stand almost any rough treatment.

I have found that equal portions of loamy soil and leaf mould, or loam and peat, make a suitable soil for almost every variety of Fern, more particularly hardy Ferns, and if certain essential points are attended to they will thrive as well in such a soil as in any combination of ingredients that could be brought together. What those points are I will endeavour to explain to the best of my ability. Cocoa-nut fibre refuse has been recommended by those who have had opportunities of testing its value as a useful material in the culture of Ferns. Having used it myself in a small way, I can confidently assert that it makes a sweet and wholesome addition to Fern soil, and may be used with safety, and it probably affords a gentle stimulus that repays its application. But beyond this I believe it is a mistake to expect any extraordinary results from it, since Ferns may be grown to perfection without it, and this by simply bearing in mind that they are often seen in a wild state in the most flourishing condition, and noting the particular soil and situation in which they are found.

It will be noticed that a Fern in a flourishing state has a great quantity of roots, and these are generally very thickly matted about the surface: consequently if we wish to establish a Fern we must give it ample space, and a soil free and open, yet retentive of moisture. It should never be cramped for room, as the roots extend much farther than the leaves. By this it will be seen that the common practice of inserting little bits of Ferns in small crevices, among stones or burrs, is not the way to insure their well-doing. In such places a mere handful of soil is thought to be sufficient, because it is supposed that the Ferns will establish themselves there as they do in crevices of the natural rock. This is a mistake, because the cases are very dissimilar. In the natural state the Fern springs from seed, and although the quantity of soil may be small, and formed of the crumbling stone, it is to a certain extent incorporated with that stone. In lifting the roots of the Fern it will be seen that they have taken a firm hold of the stone, and very likely extract a great deal of moisture, if they do not draw other nourishment from it.

To illustrate my meaning still further, let my readers imagine—if they have not the fact actually before their eyes, for such sights are common enough around London—an ordinary brick wall covered with *Antirrhinum*s. I have seen walls so covered, the plants growing out of the old mortar between the bricks looking as fresh and healthy as could be, seeming to thoroughly enjoy their elevated position, and presenting a gay appearance when in bloom, and a variety of colour. It may be that the remark that I heard years ago has been often made, Whence do these plants derive sufficient moisture to keep them in their flourishing condition? The most reasonable explanation I could give then, or can give now, is that the wall absorbs moisture from the air, and the plants extract it from the wall.

Now, it may be that some person, following a very common practice, after seeing and admiring such a sight as I have described on the garden wall of a neighbour, may have conceived the idea of decorating his own wall in a similar manner, and ordered a lot of young plants, and engaged some one who is supposed to understand such matters to plant them. He goes to work in the most approved method; he makes holes in the mortar, inserts the plants, fills up with good soil, gives a good watering, and leaves orders that this is to be repeated daily; but it is doubtful if any of the plants ever take root in the wall, at least I never knew this to happen. If he wants to grow *Antirrhinum*s on his garden wall he must wait some time. The seed must be scattered over the wall; it will lodge in little holes and crannies, and if the weather prove dry it will not hurt; but should moist weather set in, here and there a seed will germinate, the young plants will bind themselves tightly to the wall, pushing their spongioles and rootlets into every available cranny, although the top grows slowly, until the plant becomes, as it were, part of the wall itself. Those who examine this natural process may form some idea of the manner in which plants in a wild state establish themselves among rocks. Nor will it be difficult to the observer to understand why it

is that the Fern refuses to establish itself in the handful of loose soil thrown into the small crevice. It would take two or three weeks to do so under the most favourable circumstances, and what is to sustain the plant during that time? It can scarcely exist, and cannot grow, and very often it dies in a day or two.

If it is desired to grow Ferns on the steep side of a fernery or rockery, it will be necessary to have the stones or burrs firmly bedded together in a coarse kind of mortar, and places left so as to hold soil without the chance of its being washed out by the rain. If these holes go right through all the better, as the plants must be provided with some kind of drainage. The soil should be added while in a wet state, or be put in rather moist, and then washed into the small crevices with water. If some fronds of Fern with the seed ripe be shaken over the soil while wet, and the soil be afterwards kept moist, the seeds will in due time germinate, and then if kept moist there need be no fear of the Ferns not doing well. This, however, will be a slow process; but if plants are inserted they should be very young, the smaller they are the better, and they will want to be kept moist and shaded, for they very soon dry up past any hope of recovery.

Where Ferns grow and flourish, the air in the autumn is full of their seed, and this is carried about by the currents until it settles. I have known Ferns come up in the hollows of trees, or walls that happened to be damp through the leakage of a water-trough or other cause, on the walls of a cellar, or on the floor of a greenhouse, and where they once make a start in that way they thrive according to the amount of nourishment they receive. In some instances where this has been very limited, they live on for years without increasing in size. But this is not exactly what the cultivator wants, for they are grown for ornament, and that consists in the full development of the fronds.

The position and climate have an influence in a certain degree on the well-doing of the Ferns, as they do better in some parts of the country than in others; but, generally speaking, there are sorts adapted for almost every part, and there are few places where a fernery might not be established and the Ferns made to flourish. As far as I have seen, the cause of their failing to do so may be traced more to the management than to anything else. The cultivation of Ferns on an extensive scale is of comparatively recent introduction into gardens, and, like most novelties, is taken up by many who have not studied the necessary treatment in all its bearings. They are seen to flourish on rockeries and rooteries, and beginners take up the idea that they must be so grown, and in working out this project rather over-do the matter. Very often their only reason for putting Ferns in a particular place is because they would like to have them there, without consulting the requirements of the Ferns themselves. This very often leads to disappointment; and though I have known many instances of the same kind with regard to other plants besides Ferns, yet the establishment of a fernery is supposed to have something peculiar in it, and receives a more than common amount of attention.

Unless on a small scale, it is not advisable to attempt to grow Ferns alone, but to associate them with American, trailing, and alpine plants; and, although the Ferns may form the principal feature, yet, the addition of other plants will give the fernery a more interesting character. Where it is desired to make a small fernery, it would be as well to exclude the larger and coarser varieties, as the Male Fern (*Lastrea Filix-mas*), the Lady Fern (*Athyrium Filix-remina*), although there are more diminutive varieties of both that may be introduced advantageously. *Lastrea cristata* and *dilatata*, and *Polystichum aculeatum*, it would be as well to leave out, although the latter forms a noble-looking plant; but *Polystichum angulare* and *lobatum*, with their varieties, look as well and do not grow so large. Any of the varieties of Hart's-tongue (*Scolopendrium*), may be well introduced, also several varieties of *Polypodium*, as *dryopteris*, *plegopteris*, *calcareum*, *cambriacum*, and *vulgaris*, the two latter being evergreen, the others dying down in the autumn. The Sealy Hart's-tongue, *Ceterach officinarum*, makes a very pretty Fern when it does well, which it will do if it is not interfered with by other plants and is planted in sandy peat and has plenty of room. *Asplenium trichomanes*, *viridis*, *ruta-murina*, *septentrionale*, *alternifolium*, and *tontanum*,

are all of very diminutive habit, but make pretty little tufts when they thrive, which is not always the case, as I have known them fail to do so very frequently. They should have a good depth of sandy peat and loam, be well drained, and have plenty of room, so as not to be overgrown by other plants. They ought to be in a rather shady spot, but not under the drip of trees, and, if a bell-glass be put over them in the winter they will be all the better. *Asplenium marinum* and *lanceolatum* grow rather larger and sometimes do well, they may be more elevated but sheltered. *Allosorus crispus*, the Parsley-Fern, makes a beautiful little tuft, but it is sometimes apt to die off most unaccountably, and will be better of a little shelter in winter to protect the crown from excessive wet. *Blechnum spicant* and varieties are very hardy and will stand any rough weather, and they sometimes make fine patches. They require a good depth of soil and may be planted low down. The Maiden-hair Fern, *Adiantum capillus-Veneris*, is hardy in some parts of England, but I have never seen it do well out of doors, although I believe in the warmer parts of the country it succeeds tolerably well. *Adiantum pedatum* is also hardy to a certain extent, and is a beautiful Fern, but it dies down in winter. *Asplenium adiantum-nigrum* makes a very pretty plant, always retaining a certain freshness, and is very hardy. *Woodsia hyperborea* is a pretty little Fern, but requires a little protection from rain in winter. All these Ferns, and several others of similar character which I cannot call to mind just now, may be grown successfully in a small out-door fernery, but let there be no stint of good porous soil; let each plant have plenty of room, be shaded but not covered, and have plenty of moisture in spring and summer, but good drainage. The crowns of most of them, as the smaller ones, will be the better if a little elevated, but not too much, as some persons are in the habit of carrying this point to the extreme.

There are several hardy Ferns which are well worth a place if room can be spared. What I have named may be grown in a very small space; but on a rather larger scale such as the following may be introduced, being larger in habit than most of the above, but less so than the Male or Female Ferns. The Ostrich Fern, *Struthiopteris germanica*, and *pennsylvanica*, are handsome species, coming up rather earlier than more strictly native Ferns, and dying down earlier. *Onoclea sensibilis* has creeping roots, which render it difficult to keep it in its proper place, but it may be surrounded with slates which will have that effect; the same may be said of *Lastrea thelypteris*: these both require extra moisture, and may be planted near the ground line. *Lastrea rigida* makes a very handsome Fern, but if it grows too freely it becomes too large for a small fernery. The same may be said of *Osmunda regalis*, although the roots may be kept within certain limits, which will prevent the plant growing too large. They require plenty of moisture. *Cystopteris alpina*, *fragilis*, *montana*, &c., are suitable for a small fernery, and should have been mentioned in connection with *Polypodiums*, &c. *Hymenophyllum tumbridgeense* and *Wilsoni* may sometimes be seen doing very well out of doors when protected with a bell-glass, but I cannot say that I ever saw them in such a satisfactory state as I should like; however, I once saw a mass of the former in splendid condition in a small greenhouse, where no fire heat was ever applied, it having stood all the frost that ever entered there. I have grown both these and the Filmy-Fern, *Trichomanes brevisetum*, very fine under a bell-glass in a greenhouse. The bell-glass seems necessary for the latter, and for both when grown out of doors. They grow well in silver sand and peat, equal portions, with plenty of pieces of sandstone broken up and intermixed. I hope to return to this subject and say a word or two on the construction and arrangement of ferneries.—
F. CHITTY.

(To be continued.)

MATERIALS USED IN FORMING COMPOSTS.

(Concluded from page 511.)

TUFTS OF GRASS AND OTHER HERBAGE.—Like moss, this substance is one that has taken years to mature before it has become fit for use. Decaying turf or vegetable matter having long been thought to possess the qualities necessary to support a growing plant, turfy mould has been invariably

stated to be one of the indispensable requirements of the potting-bench; and in many cases the quality of the ground was to indicate the kind of turf advised, that from a rich pasture being preferred. Doubtless, this article is one of the best that can possibly be employed for many purposes, and it is not my intention to detract from the merits of one of the most valuable materials which we possess; but the tufty sod from an ordinary pasture field of good land, and regularly grazed, is not the only thing of its kind that is valuable, a very inferior soil sometimes produces what is of equal, if not of greater worth to the plant or fruit grower. The tops of comparatively barren mountains furnish small tufty pieces of herbage, with a little of the scanty soil attached, which is not of less value in many respects than the more enriched tillage ground of the plain below. The herbage itself being of slow growth is more wiry or fibrous, and contains less water than the more luxuriant growth of the land below. It does not decay so soon, and, therefore, affords a longer-continued storehouse of food to the plants it is intended to support; and attached to the little turfy bits of herbage is often a soil consisting of the decomposed rock or other strata of the place the plant occupied, a soil which has taken centuries to bring to the condition it exists in. Now, there are many plants which delight in an open, porous soil possessing less density than that of the drifted sandy composts of the valley or river side. Such plants relish the open and slow-decaying material here spoken of, and with very little admixture of foreign matters; in fact, some of our best growers of plants and fruits mix a very small amount of these with this and similar matters, and they are quite right, as it is often to be feared our mixtures of materials opposed to each other lead to the neutralisation of their peculiar properties. Thus, lime destroys all vegetation, and the rooty or fibry portions of peat fall a prey to it when the two substances are unadvisedly mixed together; and I have on more than one occasion seen sand mixed with lime for mortar, that evidently contained some mineral ingredient diametrically opposed to the lime, as the latter almost disappeared in the compound, and, of course, the mortar, if we might call it such, was worthless. Now, though turfy peat and lime are rarely if ever used by the gardener, there is no doubt that very often mixtures are compounded of substances much opposed to each other, and, of course, a loss is the consequence. They will not always be as bad as the mortar mentioned above; but as mixtures they will be unsuitable. As this, however, may be treated of hereafter, we will return to the subject of small turfy or benty tufts, with the little scraps of sandy materials attached to them, and see in what way they can be applied to the purposes of plant or fruit culture. In the first place we will consider them as an agent in the growth of fruits, and of the Pine Apple in particular.

It is many years since Mr. Barnes, of Bicton, astonished the Pine-growing world with some exceedingly well-grown Queens, fruited by a process at once simple, and, as the sequel proved, highly successful. Mr. Barnes, instead of skimming the best part of the park or pasture field for rich, fine, mellow earth to grow his plants in, betook himself to a waste common of very indifferent land, and collected the turfy pieces of coarse grass, with now and then small, stunted growths of shrubby or woody matter intermixed, and with no more of the surface mould than was sufficient to make the other hang together. A heap of this used some six months afterwards formed the principal part of his Pine compost, which was aided afterwards by judicious applications of liquid manures. Here, then, was the secret of using a material which did not so speedily decay: the wiry nature of the hard grass or bent, resisted the perishing influences which a more watery herbage would have fallen a prey to, and receiving and satisfactorily giving forth the repeated draught of liquid manure without becoming soddened, it proved the best possible medium to maintain a healthy vegetation. Now, this mode of using the small, tufty bits of turfy mould is by no means new or uncommon. A friend of mine, and an excellent Pine-grower in the west of England, collects all his materials for that purpose from the rocky cliffs of the south-west coast, and he thinks the saline matter such herbage must imbibe from the atmosphere, when the whole surface is covered with spray, tends to the well-doing of the Pines. Be this as it may, his plants

and fruit are invariably good; and as the small, knotty lumps of coarse herbage rooting into the fissures of rocks necessarily partake of the *débris* of that rock, their residue, when decay has reduced all their fibry matter, is free from the compactness of a similar matter taken from the clayey land of other districts; and as I have attempted to show that substances running quickly into decay do not in themselves contain so many of the requisites necessary to promote a healthy and vigorous vegetation, such materials as moss, and the coarse but wiry turf above alluded to, cannot be too highly prized. Though I have only alluded to its usefulness for the growth of the Pine, it may, doubtless, be employed with equal advantage for growing many other plants, and I am far from certain but that the Vine may be coaxed into attaining as high a degree of perfection in this substance as in a richer compound. Enough, however, having been said on this head to call the attention of the general cultivator to its claims on his notice, I will now pass on to another substance, the utility of which as an agent in cultivation is based on the same principle as that just treated of.

COCOA-NUT FIBRE.—I confess mentioning this without any personal experience of its value as a material to grow plants in; but our late valued coadjutor, Mr. Beaton, spoke highly of it, and his opinion seemed confirmed by that of others who had tried it, and a year or more ago it was much spoken of. Very satisfactory results followed its use, Orchids being said to grow well in it, and many other plants requiring an open soil were said to succeed in a mixture in which cocoa fibre formed an important item, and I am not sure if some plants did not do well in it alone; but not having tried it myself I cannot vouch for its good qualities further than that the credibility of those who have spoken well of it is undeniable. Its merits no doubt consist in its being capable of absorbing a large quantity of liquid, which it can part with to the plant whose roots interlace it in various directions, and its powers of resisting decay enable it to continue those functions longer than other substances which so quickly turn into the mould of the neighbourhood, and when they do so no longer retain that quality of supplying the plants with any liquid that may be poured upon them, but supply that liquid altered by its chemical action upon the soil itself. In other words, the soil, if it is an ordinary garden one, to a certain extent filters the manure water that is poured upon it, supplying the roots of the plant with a liquid differing widely from that which was poured on at top, and if this process is often repeated, the soil becomes soured and unfit for healthy vegetation: whereas if the same thing were done on a bed of moss or cocoa-nut fibre, these substances being more inert, part with the liquid they are charged with in much the same condition as they received it. To gross-feeding plants this is a boon, as the roots having ample scope to ramify, are, nevertheless, excluded from air, and are so circumstanced as to benefit by the artificial treatment they receive. Cocoa-nut fibre I therefore presume to be of this kind, and as such is unquestionably a useful agent in the growth of many plants.

Having extended these papers to a greater length than originally intended, I need add no more to the list of articles the cultivator of potted plants requires to have at hand. Soils of various kinds are every one's wants, and leaf mould and dung need not be mentioned further than that they, too, are indispensable. My object has been more especially to call attention to the articles less known, and sometimes less used, and even this list might, perhaps, be extended, by naming crushed bones, and similar substances, not by any means forgetting stones, which, playing an important part on the surface of the earth, are also useful to the potted plant. The amount of drainage given to a plant necessarily obviates in a great measure the use of stones among the compost; but their utility as a necessary ingredient in many soils is not sufficiently recognised, and we every day see the evil effects of removing too many from tillage lands. Even in places where there seems a superabundance, removing too many impoverishes the ground; but as this is foreign to the present subject, it is only necessary to again urge the claims of a spare piece of poor ground, as affording a substance of great use in the cultivation of some of the most delicate plants which the hothouse contains. Though other substances may be added to those above given,

sufficient has been said to call attention to the matter, and hereafter it is possible the rich meadow land, so much courted by the ardent plant-grower, to supply him with mixtures for his pets, may be less run upon when the value of an enduring vegetable substance as a medium for roots to occupy is more fully known and appreciated, and I expect the day is not far distant when such will be the case.—
J. ROBSON.

OBSERVATIONS ON THE ASPECTS OF FRUIT WALLS.

THE most eligible aspects for garden fruit-tree walls is a subject which, I think, may be with some advantage made the basis of a few useful considerations, which, although probably most applicable to the future, may yet on some points call up fresh ideas at the present time. It has long been my opinion—and as further experience has made me more acquainted with the quantity and continued supply required by most families of taste in the present day I am confirmed in that opinion—that, for the general purposes of early and late supply, the walls ought to consist almost wholly of north and south aspects. On one or the other of these may be brought to perfection every hardy fruit cultivated in this country; and what is of more consequence, the season of most of them may be greatly extended. Indeed, in cases where families are not accustomed to retire to their country-seats until the breaking-up of Parliament, or the approach of the shooting season, it is quite indispensable to have a good stretch of north walls, in order to be able to retard the ripening of some of the kinds; and it will effect this to a greater extent than many would suppose. I have observed that the difference in the time of ripening the same kinds on south and north aspects is often as much as three weeks; and the length of time which fruit will hang on, and keep fresh and plump, is greatly in favour of the latter. To enter more into practical detail, let us take Cherries as an example, and I have no hesitation in stating that every kind of Cherry may be brought to great perfection on a north wall. They will crop there with more certainty, because the expansion of the bloom is retarded, and ripen as well, with as good a flavour as ever came from the sunny south; and, therefore, bearing in mind the utility of a late supply, I would only plant—say three, or at most four trees, on a south aspect, and all the rest on the north. I should thus have a certainty of prolonging the general season of these fruits greatly beyond the usual period. Again: the advantage of a north aspect for Red and White Currants is well known; but it may not be so generally known that the

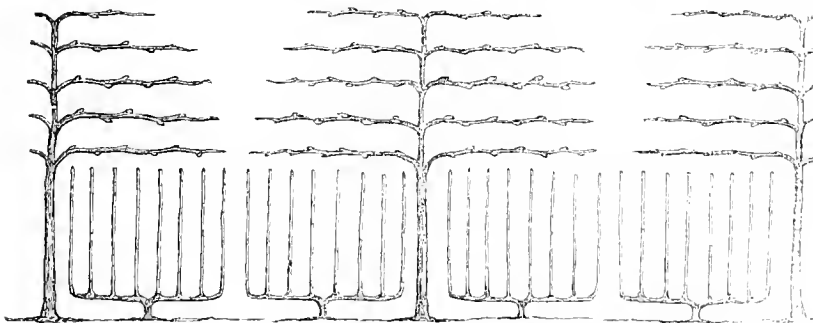

old Warrington Gooseberry may be had in perfection from a north wall long after those in the open quarters are all gone. And this leads me to a still more practical illustration. I would recommend the adoption of the following plan for furnishing some portion of the north walls:—Plant Cherries with a clear stem of at least 6 feet, at the distance of 16 feet apart; these are to fill the top part of a wall 14 feet high (and no garden walls should ever be less). Next, at a distance of 4 feet from each Cherry (and on each side of it), plant Gooseberry or Currant trees. The Cherries should be trained in the horizontal manner, under which system they will flourish and crop as well as any other, and it affords the readiest means of quite filling the wall. The

first year after planting, the Gooseberries should be devoted to obtaining shoots, diverging each way horizontally along the bottom, at 1 foot from the ground; afterwards, train up from these a number of branches perpendicularly, at 6 or 8 inches apart—a reference to the accompanying figure will show my meaning better than I can describe it. The Gooseberries will be found to fill their allotted space sooner than the Currants, because the latter will require closer pruning and heading back to get a good stock of fruit-spurs. The breastwood should be kept well shortened in the summer, as leaving it on until the winter pruning would soon ruin the trees. As the wood gets old and unfruitful, cut it out and train up young wood. Let me observe that this is not a new plan. From a wall so arranged my father and I, twenty years ago, gathered Morello Cherries and Red and White Currants, on the 25th December. I mention this to show what may be done under favourable circumstances; but of course it is longer than such fruits need be kept, because it is done at the sacrifice of flavour.

But to return to the subject of aspects. Who that knows the wants of a large establishment can have too much south wall or south borders for early crops? or north wall and north borders for summer crops? And let me add, that the other two aspects are of little comparative advantage with regard to the summer consumption, because they fill up no gap in the season which will not be filled to greater advantage by those which I recommend to predominate. Their proper tenants, therefore, will be Pears, which being principally autumn and winter fruits, do not affect the general consumption, and these aspects suit them well.

These considerations would seem to point to the great advantage to be derived from laying out our kitchen gardens in parallelograms rather than square shapes, so that, if a given space is to be enclosed, it will be better to have it in two or three long compartments running from east to west, so as to give nearly all north and south walls. I think I could show how the spaces between these walls would be easier worked, and to much greater profit than large open squares; but that ought to have a plan to elucidate it, and deserves more consideration than I can now bestow upon it.

I have said that the flavour of fruit from a north aspect is equal to that from the south; and, as many will be disposed to doubt this, I will just state why I think so; not, however, that I can here enter into the merits and demerits of all that bears upon the subject, for it is one that will bear an extensive examination, and involves more than would at first glance strike a casual observer or thinker. The influence of direct sunlight is held to be of paramount importance to the perfect maturation of both fruit and wood; and in the case of the tenderer kinds, as Peaches and Vines, it is undoubtedly so. But it is not so to the hardier sorts; nor would it be to the others, if we had higher and more equal temperature in spring and autumn. To me, the perfect maturation of wood appears to depend more on a fine warm autumn than ever so hot a summer; and on a long-continued equal temperature, rather than a great amount of direct sun heat.

The temperature of a north aspect is, on the year's average, far more equal than any other, and less liable to the extremes of heat and cold; this, then, is one reason why fruit trees may be supposed to crop and flourish well in the absence of the direct rays of the sun. And as for the flavour, provided the trees are not over-cropped, it is quite as good without the sun as with—nay, it is sometimes preferable; for I have often seen Apricots and Green Gage Plums on south aspects quite ripe on the side exposed to the sun, and green and hard on the opposite side, whereas, at the same time, I have found many fruits covered with leaves, and on which the sun's rays have never shone directly, perfectly and equally ripe—with a rather paler colour, it is true, but flavour quite equal to the tit-bits of the sunny ones. Does not even this show that direct sunlight is not absolutely necessary to ripening and flavour? In the case of Cherries

from the May Duke to the most exquisite-flavoured Bigarreau, the flavour is perfectly on an equality with any other aspect, if they are allowed to hang long enough on the trees.—J. Cox, Gardener to William Wells, Esq., Redleaf.—(Gardeners' Magazine of Botany.)

THE HEATING OF HORTICULTURAL BUILDINGS.

As regards economy, and the complete abstraction of heat from the fuel, the common flue, when properly constructed, is the most effective instrument; and we think that if the same amount of philosophy and hard cash had been expended in improving the common flue as was wasted in Polnaise experiments, a much more profitable and creditable end would have been attained. Every-day experience proves to us that much of the best fruit, and many of the forced flowers and vegetables in Covent Garden and other markets, are produced by the common flue, and that likewise in structures so rude and apparently unsuitable, that, but for the fact of the productions being before them, some of our philosophical brethren would say it would be impossible to grow them to such perfection in such places; and it must be confessed that the improvement in the quality of the fruit has not been at all commensurate with the improvement in the construction and character of the erections in which it is produced. What have we gained by sheet glass and its supposed and theoretically-established superiority? The large Pines at Gunnersbury—the magnificent Grapes at Bishop Stortford—the immense Peaches of Burleigh and Currahmore—all originated beneath common glass. Has hot water achieved any decided superiorities? Speak, ye market gardeners, whose early Grapes are celebrated for splendid colour, thinness of skin, and exquisite flavour, and possibly we shall find that neither construction, nor glass, nor hot water, nor superior acquirements, have attained any superior advantages; but that common, plodding, and

ignorant men, in unfavourable situations with ordinary means, have produced, and continue to produce, fruit as good, and flowers as sweet, as those who have houses upon which expenditure was never more lavish, or situations better calculated to produce perfection. Thus do extremes meet; and thus do we see that persons of limited means, with a small outlay, backed by good broad common sense, may have fruit and flowers as fine as the man who spends thousands in the formation of a garden, and hundreds annually in the maintenance of the same.

In Germany, and also in other parts of the Continent, the common flues are used in preference to hot-water pipes; indeed, with their intensely severe weather, unless an immense surface of pipe is used it is found impossible to exclude the frost; and we believe it is no unusual occurrence to see these flues heated to a red heat, and that for weeks together, without any material injury being done. It may be urged as an argument against the flues that plants and fruits are not so well grown on the Continent as at home. This we grant; but at the same time we may state that both plants and fruits are as well grown in this country by the common flue as by the best-constructed hot-water apparatus; and it is not many years since Mr. S. Barnes, one of the best forcing gardeners in England, stated that he would rather have a good flue than a badly-constructed hot-water apparatus, and we doubt not almost every intelligent gardener in the country would say the same. Mr. Crawshaw—than whom no person ever produced finer Grapes—always preferred flues for heating his vineries, facetiously remarking in relation to the waste by hot-water heating, "That he could not afford to cook a leg of mutton at the top of the chimney," meaning that the heat wasted by hot water was sufficient for that purpose. He was not far wrong, for whoever will take the trouble to examine a properly-constructed flue will find the further extremity nearly cold; but test the chimney of a hot-water apparatus, and you will in many cases find it exceedingly hot, and we believe it will be found impossible so to construct or fix a boiler as to enable it to appropriate and carry off all the heat or caloric generated by the fuel. Boilers differ in this respect; but we have never yet met with one so constructed as to be free from loss, or which could, under the best management, absorb all the heat generated for its use.

It is not our wish to underrate hot water—its safety, neatness, adaptability, and, when properly constructed and managed, certainty of action, will always insure its use with those who can afford it; but it is the million for whom

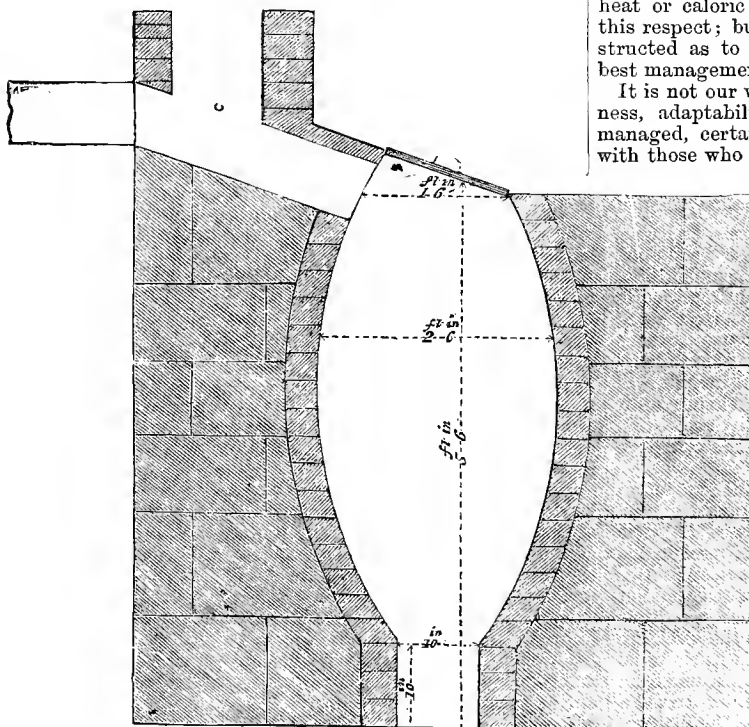

The forcing-kiln.

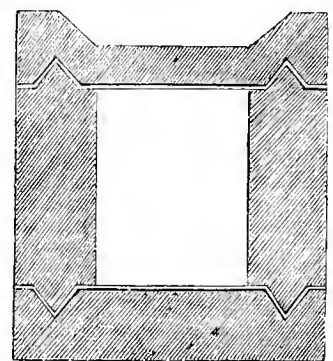

Flue tiles.

we write, and it is right that they should know that flues when properly constructed, will do all that can be attained by the best-constructed hot-water apparatus. Subjoined is a plan of heating flues by a very economical process—viz., the burning of limestone, so that where fuel is scarce and

limestone plentiful a twofold object may be attained—viz., forcing-houses heated and lime for the use of the garden manufactured.* For this plan we are indebted to Mr. M.

* Some interesting details respecting a similar mode of heating, in operation at Lyon, the seat of Lord Cloncurry, will be found in Vol. IV., p. 278.

Kelly, gardener to T. Conolly, Esq., M.P., of Castletown, Ireland; and when we say that, without any other means of heating, Mr. Kelly has for more than twenty years cut Grapes, and good Grapes too, in April, we need say no more as to the value of the plan. The following is Mr. Kelly's description of the kiln:—

"The preceding is a section and elevation of the lime-kilns at Castletown, the seat of Thomas Conolly, Esq., M.P., for heating the hothouses. One kiln is used to each house, which is 30 feet long by 11 wide, and the kilns are close to the back wall, and covered over by sheds. The exterior walls of the kiln are built of stone 2 feet thick, and the interior is lined with hard or fire bricks, and round the mouth at the bottom there must be a fire-stove. The bottom of the kiln is 10 inches square for a height of 10 inches, one side being left open for drawing off the lime. There is no grating or fire-bars, but about 3 feet from the bottom in the front side of the wall, a round hole about 3 inches in diameter is left to admit air to assist or promote combustion. These kilns only differ from ordinary lime-kilns in being smaller, and they require about two bushels of broken stones and half a bushel of small coal in alternate layers each time they are dressed or charged; but the quantity varies much as the kilns work well or ill, and, of course, much of their working depends upon their being managed by a person who thoroughly understands them. The flue, which is of the usual form, must start immediately under the cover of the kiln, and must rise towards and into the house—that is, the mouth of the flue must be from 6 to 12 inches above the top of the kiln, and a damper must be placed near the entrance of the flue to check the draught in case of need. The kilns are drawn and dressed twice in twenty-four hours, taking care to clear the mouth of the flue each time they are dressed, or the flues are likely to get choked. In lighting a kiln a quantity of firewood is placed in the bottom and nearly halfway up the kiln, and the fire is put to it at the bottom."

Flues are liable to accidents, but these more frequently arise from imperfect construction and the bad management of those who attend the fire than from any other cause. A flue to be effective and certain should at the starting-point or mouth be at least 18 inches above the fireplace, and should rise gradually from the mouth to the chimney; the turnings of the flues should be as obtuse as possible, and wherever there is a turn it should, to insure a good draught, rise considerably at that point. As regards size, that is immaterial; but a rather deep and narrow flue will, other things being equal, generally have a better draught than a broad shallow one. Some of the market gardeners about London make it a rule to build new flues every fourth or fifth year, using the old bricks for other purposes, and this, where common bricks are used, is, no doubt, a good plan, more especially where hard-firing is practised; but if flues are properly constructed they ought to stand from ten to fifteen years, and indeed we know some that have stood longer. A few years back it was customary to use Gowen's flue-bricks, figures of which may be seen in the "Encyclopedia of Gardening." The object of the inventor of these bricks was to insure the quick transmission of heat, forgetting that they would be cooled as quickly as heated, and, consequently, what was gained at one time would be lost at another.

Few bricklayers know how to build a flue properly; generally they use mortar in much too great a quantity, and not in a sufficiently fine state. Flue mortar should always be well ground—should be of the best kind, and used in the least possible quantity. In building the mason's practice of consolidating his work by striking the brick with a mallet should be observed, as it is impossible to use too little mortar, so long as there is sufficient between the bricks to hold them together. The brickwork of flues is liable to be deranged from the accumulation of explosive gases, and from external injuries; but to prevent these we have contrived a flue, represented by the annexed diagram. The bottom and cover tiles are made with grooves or chasings, into which fit corresponding projections on the side tiles, and hence the flue becomes almost a solid body, secure from everything but wild injury externally, and from being so strong at the joints, much less liable to be deranged by internal explosions. In manufacturing these tiles the under

and cover tiles, in addition to the grooves represented, have a groove at one end and corresponding projection at the other, and the side tiles have one grooved and three projecting sides, and thus fitting all together it is almost impossible to disturb them, and the flue is consequently not only very strong, but very safe. Flues constructed as here directed would answer every purpose for horticultural heating; and after the first construction would be found very economical, as they would consume any kind of fuel, and give off a great amount of heat.—(A. in *Gardener's Magazine of Botany*.)

GARDENING IN ENGLAND A CENTURY SINCE.

THE regular symmetry introduced into this science is at present totally neglected by the English, and no longer to be seen, even at the royal palaces, except at that of Hampton Court, where the Stuarts resided. The kings of the Hanover family have come nearer to London: George II. lived at Kensington; the present king, who was brought up at Richmond, chooses to reside near that village, in a lodge situated in the midst of a fine garden which formerly belonged to the Duke of Ormond, and is only surrounded with palisades. Charles II. had planted the gardens of Hampton Court, and King William those of Kensington, according to the plans of the famous Le Nôtre. The last of these princes had added a grass plot planted all over with Yews and Cypress trees, and surrounded with arbours of the same sort, the whole cut with the utmost regularity, but dismal as a churchyard. This grass plot is still to be seen under the very windows of the palace, and is called King William's citadel.

This taste is no longer fashionable in England. In all the gardens that I have seen I observed but one walk with rows of trees on each side, cut and laid out in the French manner. It is preserved only as a specimen of the ill taste which now prevails in France.

The English taste is no less averse to our modern rows of Lime trees, whose tops, cut exactly level with shears, form one long portico, which, to the eye, appears like joiner's work painted green.

It is from wild and uncultivated woods—that is, from pure nature, that the present English have borrowed their models in gardening. The great avenues of their parks kept in the best order, are roads cut through forests of trees of all sorts and sizes. The footways imitate the little paths of woods by their sinuosities, and their manner of intersecting and communicating with each other.

Art scarce displays itself at all in the different plantations which separate and conceal these walks. It lies in the choice of the trees and shrubs. Daisies and Violets, irregularly scattered, form the borders of them. These flowers are succeeded by low trees—such as Rose-buds, Myrtle, Spanish Broom, &c. The next rows are filled by Cedars, Pines from different parts of America, and other trees which rise only to a certain height, or whose growth is very slow. The last stage consists of trees capable of forming the highest and best-furnished stems. By means of this arrangement these plantations exhibit the trees in their several ages, in the pyramidal form—that is to say, the form most pleasing to the eye.

The paths which they separate, and by which they are bordered, are little winding alleys, that never run the space of two fathoms upon the same line, or the same plan. In laying out these gardens, the object of the first labour is the inequality of the ground, which is gained even on the levellest surface by digging into and removing the earth.

In this manner the gardens belonging to Lord Burlington's house at Chiswick are laid out. A ground very flat by nature turned up by the spade, has produced terraces and hills, each of which is crowned by a little temple in the antique taste. Finally, a river of an extraordinary breadth, whose winding course, either cutting or skirting the sides of the principal parts of the garden, multiplies the prospects from the house. The grand walk which forms the first point of view being planted with Cypress trees, intermixed with urns and funeral monuments in the antique taste, has the appearance of a burying-ground. It seems to form an avenue leading to the temple of Melancholy. I have since

seen in France a fountain which appeared to be made for this avenue, it is newly-built in what they call the Greek taste, and occupies the centre of a spacious grove. Its octagon plan, divided into storeys, has for an ornament at each corner a vase, very heavy of itself, and loaded with crowns, or festoons of Cypress, which present to the view nothing more than the decoration of a funeral pomp of the first distinction.

The gardens which the Princess Dowager of Wales has lately laid out at Kew, in the neighbourhood of Richmond, unite all that the English taste has been capable of producing, most magnificent and most variegated.

These gardens consist chiefly in thickets of a considerable extent, laid out in such a manner, that each forms a whole, from which we pass to another unknown to ourselves, and without so much as suspecting that there was anything farther.

In one of these thickets is a Gothic chapel, and which forms a saloon as spacious as it is singular. In another, on the summit of a hill made by art, rises a temple in the form of a rotunda, in the most pure taste of Grecian architecture. This temple, which is consecrated to Victory, was erected in 1741. A grove of communication has an antique portal as an ornament, supported by the remains of an old building. The whole appears the more natural, as the juncture of the blocks, and the crevices of the building, are loaded with those plants and trees with which Nature delights to overspread real ruins.

The principal of these thickets has a tower in the form of an octagon, built entirely in the Chinese taste, 300 feet high, and divided into nine storeys, which are distinguished by projecting roofs, adorned with bells, dragons, and other Chinese ornaments.

The middle of the garden round which these thickets are ranged, forms a very large platform, the ground of which, unequally intersected, is watered by an artificial river. Beyond this river we meet with a great wooden bridge, built in the middle of the meadow, for no other reason but to vary the prospect. This variety can result only from those foreign objects, and the artificial inequality of the ground, which presents to the view an extensive lawn of grass. The middle, which is in the nature of pasture ground, is left to cows and sheep, whose plumpness and good order, whilst they show what house they belong to, add greatly to the beauty of the landscape. The borders of this pasture ground form likewise grass-walks, but the grass is rolled and cut. The labour which this requires constitutes the chief employment of English gardeners, whose time is amply paid for. In the months of May and June it is repeated every week; at other seasons fifteen days of rest intervene. Their method of working is this—about sunset the gardeners roll the grass with enormous cylinders of cast iron, which are hollow, and 4 or 5 feet long, with about a foot diameter. The moving these cylinders, whilst it levels the ground, flattens the blades of grass, which the weight of the dew keeps in that situation. The new day, before the sun dispels the dew, and has put the grass into a condition to raise itself again, they cut it down, taking it in a direction contrary to that which it received from the cylinders passing over it. Before the scythe has mowed the broadest walks which the cylinder has been rolled over, they appear to the eye like large pieces of white and green mohair. Their verdure is the most beautiful in nature. At my departure from Paris the celebrated La Tour, a great connoisseur in colours, strongly advised me to give attention to the vivid hue of this verdure, which is not so much owing to the operation I have been describing, as to the goodness of the soil, and the abundance of the dews.

How agreeable soever these fine lawns of grass may be to the eye, they are inconvenient and troublesome to the feet. This we found by experience in walking through Windsor Park at eleven in the morning in the month of May; finding no path where we could tread without moistening our feet, we came away as wet as if we had passed the whole morning in some marshy ground. Even in the afternoon these fine lawns are scarce ever free from moisture.

The little alleys or paths, which are the proper places to walk in, are secured from this inconvenience by the fine gravel already taken notice of; being rolled over and smoothed by the cylinder it has the level and consistence of an excellent cement.

Amongst the curiosities to be seen at Kew Gardens, we should not forget a considerable collection of foreign plants of all sorts. A quarter is assigned to it in the neighbourhood of the Palace, which unites all the conveniences necessary in a botanical garden.

Many of these plants or shrubs that cannot bear the open air in France, and even in Italy, flourish in the English gardens, which owe this happy temperature to the sea surrounding the island. The garden belonging to the Princess Dowager, that of the Duke of Cumberland, Richmond Park, and many others which resemble them in the manner they are laid out, and in their plantations, have no buildings answerable to their magnificence. The gardens have swallowed up all the expense and attention of the proprietors.

Kew is almost joining to Richmond, where the king resides in summer, and it has a communication with Brentford by means of a wood bridge over the Thames.

Brentford is situated in a delightful country. The Duke of Northumberland has there a palace and gardens. It was originally a nunnery, which went by the name of Sion. The nuns being banished from England, went over to Portugal, there they built a monastery, where they still keep the key of Sion, which they had carried over with them at the time of their exile. The Earl of Holderness, who joins to English solidity all the politeness of French behaviour; and some other noblemen have their country seats in this neighbourhood, where art can scarce make any addition to nature.

Lord Temple completed the demonstrations of kindness by which he honoured me during my stay in England, by giving me an invitation to pass the month of July with him at his seat at Stowe. This house, which was begun by Lord Arlington, is, at present, the most magnificent and complete piece of architecture of the sort in England. The greatest elegance is displayed, as well in the outside as in the spacious departments of this fine house, round which you see a multitude of saloons, pavilions, grottos, temples, and other buildings, all in different tastes, and enriched with every ornament suited to each. Amongst these the most remarkable is the temple consecrated to the British worthies.

Many English parks owe their principal beauty to the extent and grandeur of their prospects.

Next to those of Greenwich, Richmond, and Windsor, which unite all that a landscape can offer, most spacious, most gay, and most varied, we should place that of the present Duke of Newcastle's seat near Weybridge.

Seated upon a considerable eminence, it commands the prospect of an extensive and beautiful plain on the banks of the river Thames. In the last century this eminence was very steep, and bordered with a terrace which had cost a prodigious sum of money. The present proprietor began to fancy that a gentle declivity would make the nearest approach to nature. In consequence of this notion the terrace was demolished, and turned into a slope, which is covered with perpetual verdure. The destruction of the terrace, the digging and removing the earth, must have been attended with infinite labour and expense.

By these expenses, which may be compared to those with which Horace reproached the Romans of his time, all the country adjacent to London.

Sentit amorem
Festinantis heri.

Nothing, however, shows more than these expenses the wealth and splendour of a nation, especially when the several classes of the people have an equal right to such fancies.

The meadow commanded by the Duke of Newcastle's seat is laid out on the same plan as the slope leading to it. It is bordered by different sorts of trees scattered irregularly without either order or symmetry. The bottom is planted with trees of unequal sizes and of different ages, without the least appearance of art, and which lead the eye to a forest of high trees terminating the prospect. The whole and the parts of this beautiful scene seem to represent in large, upon a ground of the extent of the Tuilleries, the original of the Elysian fields in the opera of "Castor and Pollux" which I have seen at Paris just before my departure for London. Besides the advantage of size, the prospect

of Weybridge was heightened by that of a sun, whose rays piercing through a sky somewhat overcast afforded a mild and gentle gleam of light, which seemed to partecipate of the freshness of the dew that was spread like varnish over every part of this gaudy landscape.

This taste, which at present prevails amongst the English in the manner of laying out their parks and gardens, is that of the Chinese—that is to say, the taste which, like all those of that eastern nation, has been established amongst them from the most remote antiquity. It appeared ridiculous, however, to the French Jesuits, whose eyes were used to the symmetry and regular plans of the gardens belonging to the royal palaces of France. The Chinese, said Father Le Comte, neither lay out their gardens with accuracy, nor embellish them with proper ornaments; they, notwithstanding, take pleasure in those places, and spend vast sums of money upon them. They form grottoes, raise little artificial hills, and transport rocks by piecemeal, which they heap upon each other; and all with no other view but that of imitating nature.

The French would have been beforehand with the English in adopting the Chinese taste, if they had followed the plan laid down to them by the celebrated Du Fresnoi.

“Du Fresnoi,” says the author of his life, “had a predominant taste for the art of gardening, but the ideas which he had formed to himself concerning that art had nothing in common with those of the great men whom we formerly had and still have in this way. He never worked with pleasure, and, if I may be allowed the expression, at his ease, except upon an unequal and irregular ground. He required obstacles to surmount, and when Nature offered him none such, he procured them himself—that is to say, of a spot of ground which was regular and flat he made one full of risings, in order, as he said, to vary objects in multiplying them; and to prevent the effects of neighbouring prospects, he opposed them with eminences, which at the same time formed delightful vistas.” They add that he arranged in this manner the gardens of Mignaux near Poissy, two gardens which belonged to him in the suburb of St. Anthony, one of which goes by the name of The Mill, the other by that of The Hollow Road; finally those of the Abbé Pajot near Vincennes. Upon this account, Louis XIV. had granted him a brevet of comptroller of his garden. He had presented this prince with a plan for the gardens of Versailles; and this plan, in which he consulted only his own fancy, was not approved of, on account of the enormous expense requisite to carry it into execution.

Even upon a smooth and level surface, the English are fond of imitating the variety of nature. Such is the garden of Sir Richard Glynn at Chelsea, confined within a very narrow compass. The square area or parterre, on one side of the bowling-green, which forms the prospect of the house, presents to the eye a long gravel walk 6 feet wide, with two parallel alleys of 3 feet in breadth, covered over with short grass. Separated by shrubs and trees of various sizes, they either skirt or intersect each other at random. The great walk, of a serpentine form, is terminated by a Myrtle bush, which you must turn round to see the alley in front. This beautiful garden, which occupies but two acres of ground, might be a model for planting groves of the same extent in our gardens in France.

The dearness of the ground occupied by the parks, by the fields and gardens, where the inhabitants of London go to spend their Sundays, adds greatly to the astonishment arising from the great number of these pleasurable resorts. I shall here give the reader what I have been able to collect concerning the high price of land.

The best grounds which I had seen in my journey from Dover to London are laid out in Hop gardens, and let for four guineas per acre.

An acre of the marshy grounds which supply London garden stuff is said to be let at fifteen guineas a-year, and with the rent will increase in proportion as London is enlarged.

At Chiswick, a village about six miles from London, as we sail up the Thames, half an acre, occupied in part by a small ruinous house, was let for fifteen guineas. This extreme dearness of land must have increased, and has in fact increased, the encroachments of the proprietors upon the roads, whether public or private. If part of the road is unpassable

to foot passengers, either on account of its narrowness or for want of being kept in repair, the public has a right to pierce through the hedge of the adjoining estate, and to open a footway through it. This footpath, which passengers are barely permitted to walk in by the proprietors, becomes public as soon as ever a funeral has been obliged to pass that way. This is an overt act of taking possession on the part of the public; the proprietor can no longer forbid it, and if he should afterwards have a desire to wall his estate round, he cannot do it otherwise than by placing the wall 3 feet from the road.

The wages of gardeners are in the like proportion. At the same village of Chiswick, General Elliot laid out a park in the English taste, which is now possessed by his widow. It contains three hundred acres, forming an oblong square, at the front of which is a convenient house without magnificence; on the right is a very extensive terrace, close to which the Thames rolls its silver stream.* On the left is an aviary, as remarkable for the beauty as variety of the birds (I never saw any Chinese cocks elsewhere); a park filled with deer; and a spacious field in which twenty cows find excellent pasture, and whose good case commends their owner: this whole ground is irregularly planted with trees of all sorts and sizes. The middle presents to the view a spacious lawn, laid out in the English manner, and terminated by a pond of an irregular form, with island rocks and a grotto. The salary of the gardener for taking care of the garden and the cows, &c., is three hundred guineas per annum.

Wages are proportionately dear for gardens of less extent. I have myself seen a spot of ground, not exceeding an acre, occupied partly by a small house, partly by gravel walks, with two beds of flowers, where the gardener, who was lodged in the house, had a salary of twelve guineas a-year.—(By a French Gentleman Resident here in 1770.)

A NOTE FROM BEYOND JOHN O'GROAT'S.

In this remote corner of Her Majesty's dominions, lying about fourteen Scotch miles north-west of John O'Groat's, we have at present in full flower the *Arbutus unedo* and *Garrya elliptica*, and some six weeks ago we also had the South American Pampas Grass. In our neighbourhood the *Hedera helix*, or Ivy, is climbing on the face of precipitous rocks about 100 feet above the level of the sea. This plant has been long introduced into most gardens to clothe old ruins, old stumps of trees, and I read of its being much used for decorations. It has leave to ramble to a great extent, and it was only when it became an intruder that the artist's hand was called into operation to check it. Whilst the greater part of the plants that have been introduced into our gardens have undergone a change by artificial arrangements, the *Araliaceæ* have been made but little use of. Winter gardens in the geometrical and Italian styles have had their due share of attention from gardeners; but there is still something wanted to make the scene complete. What with coloured gravels, earths, broken bricks, &c., the winter garden has a charming effect from a distance; but the mind is not so much gratified when a deception is used as when Nature adorns, and man plants and dresses. When the ground is disposed of in an artistic style, why not adorn the walled geometrical garden in the same way? The Ivy tribe is capable of being trained in a thousand ways on walls, if the training is begun when the plants are young—as in festoons, scrolls, pillars, panels, circles, &c., that would correspond to the ground plan of the geometric figures. All that is required when the Ivy is trained to the design is to cut it annually with a stone chisel to the precise shape. It might be carried further to make pillars and arches standing at a distance from the wall so as to form a complete labyrinth; and why not in these days of fashion sprinkle the leaves with plaster of Paris to give them a whiteness, and make rosettes in the middle of circles, &c.?—J. F. SINCLAIR, *Stangueill, Thurso, N.B.*

* Both above and below London Bridge this river affords the country its waters a constant and most delightful view of barges, wherries, and little boats. The prospect is not silent, little vessels adorned with elegance and taste have frequently musicians aboard them. It is a received custom upon the water to attack each other with scolds and scurrilous language, and he that is obliged to give over is looked upon as vanquished.

A RIBBON-BORDER.

SHOULD I do right in planting next season a bed 20 feet long by 6 or 8 feet wide, first row with Variegated Balm; second row, Tom Thumb Nasturtium; third row, yellow Calceolarias; fourth row, Atriplex hortensis; fifth row, Geraniums (variegated or Scarlet?); sixth row, Perilla nankinensis; and when should I sow them?—A YOUNG GARDENER.

[You will require strong-growing Geraniums for No. 5, such as Punch or Trentham Rose. We should rather have Perilla for 4 instead of 6, but it will not much matter. Sow the Perilla in a slight hotbed during March. You might sow the Atriplex at the same time out of doors.]

SOME GARDENS WORTH SEEING.

NORTHAMPTONSHIRE.

Name.	Proprietor.	Gardener.	Station.
Fawsley Park.....	Sir C. Knightley, Bart.....	Mr. J. Brown.....	Weedon
Brockhall	T. R. Thornton, Esq.....	Mr. Kerridge.....	Weedon
Floore House.....	General Cartwright.....	Unknown	Weedon
Althorp Park.....	Earl Spencer	Mr. Smith.....	Northampton
Courteen Hall.....	Sir C. Wake	Mr. Gardiner.....	Northampton
Wakefield Lawn.....	Duke of Grafton.....	Mr. McPherson.....	Northampton
Overstone Park...	Lord Overstone.....	Mr. Thomas.....	Northampton
Castle Ashby.....	Marquis of Northampton	Mr. Beech	Castle Ashby
Easton Neston.....	Earl of Pomfret.....	Mr. Booth	Northampton
Welton Place.....	Major R. Trevor Clarke.	Unknown	Crick
Delapre Abbey ...	General Boaverie.....	Mr. Mackie.....	Northampton

BUCKINGHAMSHIRE.

Tyringham Park...	W. B. Tyringham, Esq.	Mr. Mobbs	Wolverton
Whaddon Hall....	W. S. Lowndes, Esq. ...	Mr. Newman ...	Wolverton

—S. ROGERS.

CARTER'S "FLORAL ILLUSTRATIONS."

A TRULY beautiful group is this No. 14, of "Floral Illustrations." There is *Godetia roseo-alba*, in the centre like a blushing bride; with *Tropæolum majus purpureum* like an Ethiopian guard of the zenana on one side, and *Mimulus tigridioides*, like bright attendant damsels around; *Clarkia pulcherrima integripetala*, as a brilliant and brave bridegroom as her support; the blue *Gilia laciniata*, and *Kaulfussia atroviolacea* as emblems of constancy; surmounted by the standards of *Lupinus albo-coccineus*, and *Swainsonia splendens* as ensigns of prosperity. The whole is brilliant, excellently balanced, and artistically arranged, creditable alike to Mr. Andrews, the artist, and to the proprietors, Messrs. Carter & Co., the florists.

WORK FOR THE WEEK.

KITCHEN GARDEN.

It is hoped that, in accordance with repeated instructions to that effect, the operations of wheeling manure and trenching-up vacant quarters in this department have been regularly and systematically followed up in all favourable weather; let this be continued as often as opportunity offers. All green refuse and decaying matter when trenched in to be strewed over with lime to hasten decomposition and to destroy insects; choose, also, dry frosty mornings to fork-up ground previously trenched, so as to get the surface in good working order. *Beans*, embrace the first favourable opportunity for sowing in well-prepared ground the second crop of these, and also the second crop of *Peas*; a few of the latter should also be sown in boxes, pans, or flower-pots, to be in readiness in case of any failure from such causes as frost or vermin. Be careful to keep a good supply of figure-4-traps constantly set, as there are none better for keeping down mice. *Peas* and *Beans* appearing above ground to be watched for the destruction of slugs by dusting with quicklime. *Carrots*, a warm border to be chosen for sowing Early Horn, with Short-top *Radishes* in neat drills alternately, to be covered with light sandy soil and protected with mats, straw, or fern. *Cauliflowers*, the plants under hand-lights require frequent attention, keep the surface stirred, dust with lime or charcoal-dust. A good plan to catch slugs among these is to split large Carrots, and to lay them between the plants. By picking them off on mild mornings the number may be considerably reduced. *Endive*, see that the hardy varieties of this and of *Lettuce* on sloping banks or borders are properly protected and looked over in favour-

able weather, removing decayed matter, and covering up for blanching when dry. Fill-up all vacancies in Cabbage and Colewort plantations, and keep the surface about them constantly hoed or stirred with the fork.

FLOWER GARDEN.

The absence of frost from the ground has permitted, and possibly will continue to permit, a variety of works incidental to this department. Borders not cleaned and dressed should at once be finished. Fuchsias and recently moved plants should be protected. In the pinetum a little protection may be afforded to Pinuses of doubtful hardihood. We repeat these instructions, assuming that the weather has beguiled some of us into forgetfulness of winter, the approach of which is unusually delayed. Dahlia roots to be occasionally examined in order to counteract the effects of damp.

FRUIT GARDEN.

Continue the operations of pruning and nailing the hardier kinds of fruit trees at every available opportunity. Prune espalier Apples and Pears, and fork-up the ground about them in frosty weather to destroy insects. In the orchard thin-out cross and crowded branches from Apples, Pears, and Quinces; scrape off moss and lichen from the stems, and dress both these and the espalier trees with a mixture of quicklime and clay brought to the consistence of thick paint. If frost prevail stir up also the soil well with the hoe or fork close under the walls and fences; such places afford a ready refuge for slugs and other vermin to hide in in security. It is not a bad plan to shake a little quicklime over the earth thus disturbed.

GREENHOUSE AND CONSERVATORY.

The nature of the weather at this season of the year demands particular caution to avoid the ill effects of the excess of artificial heat and the cold of the external atmosphere, and to preserve in this department that happy medium of heat suited to the habits of the plants. The continuance of weather which may be termed mild still allows the admission of abundance of air. The plants, when the opportunities afforded by the late and present favourable weather have been and are freely used, will exhibit in the deep healthy green of the leaves and their frequent demand for water the favourable effects of such treatment. Keep the conservatory at a temperature of about 45° by night, raising it to 55° in the day, with plenty of air at every favourable opportunity, and the house may have 60° or 65° by sun heat without injury. Keep the atmosphere moderately moist, as much for the preservation of the flowers as for the comfort of the visitors. Stove plants will take no injury for a few days in this temperature; but hardwooded greenhouse plants, such as Heaths, should not be allowed to remain for more than a few days at a time in such a temperature. The greenhouse in the generality of places is a mixed affair, where hardwooded and softwooded plants are obliged to be together. In such places a compromise must be made in the treatment by keeping them a few degrees warmer than Heaths and other Cape plants require, and yet sufficiently warm for Pelargoniums, herbaceous Calceolarias, &c. Arrange the plants in groups, so that air may be admitted to the Heaths and other hardwooded plants at times when it would be injurious to the softwooded plants.

STOVE.

The season is not yet advanced sufficiently to allow an increase of temperature. A steady heat, ranging between 60° and 65°, may be sustained if the weather continues open. The occurrence of frost will demand a reduction of temperature, and if it falls to 50° in severe weather no harm will be done. Recollect always that stove plants as well as others require fresh air in favourable weather. Some few Orchids will now be in active growth, these must be fed with moisture supplied as opportunities allow.

PITS AND FRAMES.

These must be well protected in severe weather, and abundance of air to be given to Intermediate Stocks, Mignonne, and Violets when the weather is favourable. Early-potted Tulips and Hyacinths under ashes, tan, or leaf mould will begin to draw, therefore remove them to the cold pit.

W. KEANE.

DOINGS OF THE LAST WEEK.

KITCHEN GARDEN.

WHEELED, trenched, and dug as opportunity offered, and saved pinings for charring and burning lots of weeds, rubbish, and soil too old to be of farther use. Trenched up in ridges the ground from which Asparagus had been taken for forcing, and are sorry to say that we took up too much, as we expected more company to use it than we have had. No doubt the Asparagus will be useful, and be used, but in small gardens and establishments it is something like waste to have Asparagus too often, and this is one instance among many, that for a house to be well and regularly supplied from the garden, and extras at the right time, the gardener should have intelligence of what is contemplated, as soon, if not sooner, than either the managers of the farm, or the kitchen. Much unpleasantness is often the result of the gardener being obliged to guess in these matters, and often thus judging wrong. For want of this information we have known scores of cases in which there has been abundance of forced vegetables in the garden a week or a fortnight earlier or later than was desirable. This would make no difference in establishments where little change is made in the requirements, company or no company; but it is unpleasant in all cases, and those seem to be the naturally right ones, in which we would testify our attention to our friends, by placing before them things not in season.

ASPARAGUS is not only one of the best winter-forced vegetables, but it is also one of the most expensive, when it is raised from the ground, and forced in pits and frames, as the roots are then useless when done with, except as forming part of the compost or charring-heap. These roots require to be three or four years old before forcing, we mean from the time of sowing or planting-out one-year seedlings. We have had it pretty fair the second year, but that is not general. The only consolation for such waste is the benefit arising from rotation of crops, as we have tried no crop that did not rejoice to come after an Asparagus-bed when the ground was well trenched-up and mellowed. To escape this waste, however, and in cases where much Asparagus is required, it is better to have permanent beds to be forced by dung or hot water, the tops being encouraged to grow early, so as to ripen early in the autumn. Had we a great supply to produce we would take up a piece of an old bed to force on the top of a mild hotbed in the usual way, so as to have it in use about the beginning of November, and for future crops would depend principally on permanent beds, if we could have them, and could induce an employer to go to the expense of making them.

Then, to heat such permanent beds with dung and tree leaves, we would clear out a space for a single bed—say 30 feet long, 8 feet wide, and 3 feet deep—saving the best surface soil, and removing the under soil. We would build a four-inch wall round this opening, or at least on the sides, making this wall not perpendicular but sloping a little to the ground. We would then make a pit in the centre, also with four-inch work, so as to have 18 inches for linings; the walls of the pit would be 3 feet in height, and the lower half should be pigeon-holed. Then inside the pit to the height of the pigeon-holes we would fill in boulders, clinkers, brickbats, &c., placed as openly as possible, and finish with rough gravel, and then a thin layer of fine gravel to prevent the earth going down. We would then fill up with 15 inches of fine, rich, light soil, plant all over with nice young plants about 7 inches apart, cover 3 inches, and encourage vigorous growth. The linings to be filled with hot dung and leaves when the plants are to be excited, filling only the lower part of the lining at first. The top of the pit to be covered with a flat span roof, made of glass, or even one of boards or asphalt. In the latter case the Asparagus would require to stand in the sun before it is used several days after being cut. If the one wall be a little higher than the other, common sashes of the requisite width may be laid on from back to front. For a bed to be so heated by linings the width should not be more than from 3 feet 8 inches to 4 feet. We have supposed that the pit should not be above the surface of the ground; but if such a pit were 1 foot or 18 inches above the surface the plants would thrive equally well, and all the labour of moving the subsoil be avoided or nearly so. The

rough stones in the bottom of such a pit permits the heat to excite the roots gently before it is necessary to bank up the linings to the top of the bed.

For succession early crops in the open ground, where manure is plentiful, it is a good plan to have a raised bed or two, with a pathway of from 2 feet in width, and sunk 2 feet at the sides; the sides supported by stakes and any rough slabs left open, and an edging-board or rail along each side some 8 inches higher than the bed. These trenches may also be filled with fermenting material, and be cleared out early in summer, to prevent the roots running into it, as they must be confined to the bed. As soon as the shoots begin to move the earth above them, some spare sashes may be laid across the beds, or a temporary rail or pole may be placed down the middle, and a piece of calico stretched over it, to keep out the frost. Additional covering can be given in severe weather. We have not such a bed at present, as we are so short of fermenting material, but we have found such beds most useful and economical. Sea-kale and Rhubarb may be forwarded out of doors by either of these modes.

When early Asparagus, &c., is grown in permanent beds and pits, with the assistance of hot water, the beds need not be so deep, and they may be of any width up to 6 feet, so as to be managed by two pipes for bottom heat. Glass would be the best covering, and the same sashes would do for other things in summer. Linings, of course, would be unnecessary, 2½ feet would be quite deep enough, and half of that might be above the surface level, if straw were tied on the exposed outside wall. On the bottom we would place 2 inches of concrete, so sloped as to secure drainage; on this two four-inch pipes, so as to divide the space equally, and between them, and over them for 4 inches, pack loosely with clinkers, stones, &c., and over these 1 inch of clean pebbled gravel, and then the soil. Every 10 feet or so along the sides we would have a narrow round drain-pipe of the smallest size standing up, so that we could send air and moisture into this chamber of stones at pleasure, and stop the holes when we liked, and by this means also regulate the atmospheric heat.

To meet some other inquiries, we will advert to two modes of managing Asparagus out of doors. First, in stiff clay soils where the surface soil is very thin, the following plan has answered very well. A space is marked off—say, 5 feet in width, during the winter, all the good surface soil is laid aside in a ridge, a foot of the clay or nearly so is also taken out and laid in a ridge, a lot of grass, prunings of hedges, trees, &c., is placed in the trench, set fire to, and covered with the clay, and when that is well shattered at least, if not thoroughly burned, it is thrown out as a ridge on the other side, and then until the spring all the prunings and rubbish are thrown into this trench, making a sort of rubbish-heap for everything that has a little hardness in it. Then about April this is covered over with long litter and some dung, and the two ridges with a little leaf mould mixed together, are then thrown over the litter, making a first-rate bed for ridge Cucumbers and Vegetable Marrows. In winter the bed is ridged-up, the sticks and prunings below keeping it light and securing drainage. The Asparagus is planted when from 1 to 2 inches in height, watered, and covered with rich leaf mould and dung, and thus a bed or two are made every year to supply the place of the plants taken up for forcing.

The other mode is more applicable where circumstances are more favourable. Trench moderately deep in winter, adding a fair portion of manure, loosening the subsoil and allowing it to remain level. Mark out into two-foot ridges in spring, spread the roots of the plants out on the ridges, cover with rich light soil, and mulch and water when convenient in summer. We rather prefer these two or two-and-a-half-foot ridges to beds. Plant one row on each. They soon spread. In planting after the plants are growing, do not let the roots get dry. From what cause we know not, but in planting Asparagus the plantation succeeds better when the plants are grown 2 inches or so, than when they are not started. Some prefer sowing, but the seedlings must be thinned considerably, or the plants will be so close together as to injure each other. On the whole we prefer sowing in nursery-beds and then transplanting. One-year-old seedlings are rather the best, though two or more years

old do very well if extra care is given to them. Had a lot of seed washed out and dried to be ready for sowing. Some mice are very fond of it, and so they are of Sea-kale seed; and fly and slugs will soon make inquiries after the seed-leaves.

BOTTOM HEAT.

We find we have little room, and, perhaps, as little occasion to mention particulars in other departments, as last week's work was so similar to this. A word or two on bottom heat by hot water, as suggested by the above subject, and the interesting article by "W. W." at page 314, may be quite as much in place, though we draw rather on our general experience instead of the practice of the week. We quite agree with "W. W." that it is very easy to have the heating-pipes too far from the material to be heated. When we called at Crewe Hall, the very intelligent gardener, Mr. Whittaker, was having the pipes beneath his Pine-bed elevated so that only a few inches of rough stone should intervene between them and the plunging medium, or the earth in which the Pines were planted. In other respects we do not agree with "W. W." Of the plans given, we prefer A and C, and C will be most economical. In A, there is no reason why the pipes should not be nearer the top of the chamber. We like his plan D worst, not merely for the reasons he hints at about the roots, but chiefly because the earth round the pipes, just as it becomes dry and more porous, will cease to be a good conductor. It will then act much the same as dry litter, dry moss, or dry cocoa-nut refuse round a warm pipe. It might seem out of place to enter at length into this subject, and we hope that others will meet "W. W.'s" views. We will just allude to two ideas, the first, instanced above, that moist heat will rise more easily than dry heat; and secondly, confined air is a bad conductor of the heat given off. A slight modification of the chambers of Mr. Lane would prevent the confinement of air in chamber A, and by means of a few small open pipes between the earth and wall to be stopped at pleasure, we could prevent stagnation of air and extreme dryness round the pipes in C. That to us seems the best of the four modes represented, but there is no necessity for having the pit more than half the depth. All the brickwork and the mass of rubble below the pipes are so much work and expense for nothing. We would place the pipes nearer the sides, so as to equalise the distances, fix them half an inch above a smooth bed of concrete, fill the space between with rough rubble, and cover with four or five inches of the same, finishing with small pebbles of gravel. Heat will be absorbed in such circumstances according to the density of the material. The stones and clinkers are dense and good conductors, air is light, and when confined and dry a bad conductor; make it movable and moist and it will carry heat through every opening. Any simpler mode of doing so than is referred to above we consider to be of importance. We have known many cases in which by such a simple mode failures have been made successes.—R. F.

COVENT GARDEN MARKET.—JAN. 2.

The market is still well supplied with vegetables; but if the frost which has just set in continue, a falling off may be looked for, more especially as the less hardy kinds of vegetables are, from the unusual mildness of the season, in a growing state, full of juices, and consequently more liable to injury from frost. Peas are sufficient for the demand; but house Grapes may still be had in good condition; and Apples and Pears are of the same kinds as named in previous reports, the latter growing daily more scarce, particularly the finer samples. Cobs are now bringing from 90s. to 100s. per 100 lbs., and for those of very superior quality prices rule still higher. Fresh importations have come in of French Salads, Endive, and Lettuce; and some green Peas from Algeria are also to be had. Cut flowers principally consist of Orchids, Camellias, Ericas, Roses, Acacias, Pelargoniums, a few Azuleas, Christmas Roses, Violet, Early Tulips, and Narcissus.

FRUIT.

	s.	d.	s.	d.		s.	d.	s.	d.			
Apples.....	1	6	to	4	0	Mulberries.....	quart	0	0	to	0	0
Apricots.....	doz.	0	0	0	0	Nectarines.....	doz.	0	0	0	0	0
Figs.....	doz.	0	0	0	0	Oranges.....	100	4	0	10	0	0
Filberts & Nuts 100 lbs.	60	0	90	0	0	Peaches.....	doz.	0	0	0	0	0
Grapes, Hot-house.....	rib.	5	0	8	0	Pears.....	bush.	8	0	12	0	0
Foreign.....	1	0	2	0	0	desert.....	1/2 sieve	2	6	6	0	0
Muscats.....	6	10	0	0	0	Pine Apples.....	lb.	3	6	0	0	0
Lemons.....	103	6	0	10	0	Pomegranates.....	each	0	3	0	0	0
Melons.....	each	3	0	5	0	Walnuts.....	bush.	14	6	20	0	0

VEGETABLES.

	s.	d.	s.	d.		s.	d.	s.	d.		
Asparagus.....	bundle	6	0	to	10	0	0	0	0		
Beans, Broad.....	bush.	0	0	0	0	Letuce.....	score	1	0	2	0
Kidney.....	100	3	6	5	0	Mushrooms.....	potte	1	0	1	0
Beet, Red.....	doz.	1	0	1	6	Must. & Cress, punnet	9	2	0	0	0
Brussels.....	bundle	0	2	2	0	Onions.....	bushel	2	0	4	0
Brussels Sprouts.....	sieve	1	6	2	6	pickling.....	quart	0	6	0	8
Cabbage.....	doz.	0	9	1	3	Parsley.....	bunch	0	3	0	4
Capiscums.....	100	0	0	0	0	Parsnips.....	doz.	0	6	0	9
Carrots.....	bunch	0	6	0	8	Peas.....	bush.	0	0	0	0
Cauliflower.....	doz.	2	0	6	0	Potatoes.....	sack	5	0	8	0
Celery.....	bundle	1	6	2	0	Radi-shes doz.	bunches	1	6	2	6
Cucumbers.....	each	1	0	3	0	Rhubarb.....	bundle	1	0	0	0
Endive.....	score	1	3	2	6	Savoy's.....	per doz.	0	9	1	6
Fennel.....	bunch	0	3	0	0	Sea-kale.....	basket	1	6	2	6
Garlic and Shallots, lb.	0	8	0	0	0	Spinach.....	sieve	2	6	4	0
Herbs.....	bunch	0	3	0	0	Tomatoes.....	sieve	0	0	0	0
Horseradish.....	bundle	1	6	4	0	Turnips.....	bunch	0	4	0	0

TO CORRESPONDENTS.

PRIMULAS—GERANIUM (Constant Reader, F. H.).—The Primula flowers are evidently very large, but we can say no more, for they were flattened and bruised by the postage punches. The Geranium with the leaves rayed with yellow and green would be useful as a border plant if of dwarf habit.

HOT-WATER APPARATUS.—A. S. S. wishes to know where "Bishop's hot-water apparatus," described in our Vol. XXV., p. 131, can be obtained.

GARDENERS' UNION (W. B. G. A.).—Combinations, whether among employers or those they employ, are erroneous in principle and always have for their result more misery than benefit. The reason for this is obvious—wages, like all other prices, are regulated by the relative amounts of the supply and the demand. If there are more gardeners than employers, wages will be low in defiance of any union among the gardeners. If gardeners were few and employers many, wages would be high in defiance of any union among the employers.

VINES FOR A GREENHOUSE (Subscriber).—Seven Vines in a house only 24 feet long are too many. We should plant two Black Hamburgs, two Black Champions, and one Royal Ma-cadine, which is a White Grape.

PEARS (G. K.).—The gentleman who we mention is no authority on such subjects. His information is all obtained second hand, and is not judiciously selected or applied. We shall next week give an article on all Mr. Huxley's Pears, in which you will get every information respecting the same. The two Pears you mention are not varieties of any merit, and they have never been tried in this country.

BOTANICAL TERMS (—).—Henslow's "Dictionary of Botanical Terms" and Loudon's "Hortus Britannicus" together will furnish you with all the explanations and translations you require.

DRIED PLUMS FROM SPAIN (Ironical).—They are most probably either the St. Catherine or the D'Agon, both well-known varieties as good for preserving and drying. We doubt very much whether the kernels will germinate, and if they do it is still more doubtful whether the seedlings would at all resemble the parents. You may sow the stones now about an inch below the surface in pots, and keep them plunged in a greenhouse.

WORK ON GARDENING (F. R. D.).—For twenty postage stamps you can have "The Garden Manual" from our office free by post. You will find an answer to your question in that. The Watercress Broccoli may be obtained for sale throughout the year.

SAND FOR CUTTINGS (C.).—The sand, of which you enclosed a sample, will do very well for the purpose.

TWELVE SHOW CHRYSANTHEMUMS (Jas. Whitehead).—Jardin des Plantes, yellow; Beverley, white; Her Majesty, bluish; Antonelli, salmon orange; Duchess of Buckingham, white, with sulphur centre; Sparkler, bright orange; Cleopatra, bluish, with rosy shade; Aimée Ferrière, beautifully tipped; Little Harry, orange; Lord Palmerston, rose anaranth; Queen of England, bluish; and General Slade, Indian red.

HEATING A VINERY (M. D. E.).—We would advise the sinking of the furnace low enough and have a back flue of bricks for 6 or 8 feet, and then use earthenware pipes, but not less than 9 inches in diameter. If you go round the ends as well as the front, there should be a square cesspool-like place at each turning for the pipes to end on, and that being covered with a tile, you can take it off and send a brush through the pipes at any time. We think a small flue of bricks would be as cheap unless you can obtain pipes handy. For merely keeping frost out a brick Ainoth's stove would be the simplest.

PEACH AND NECTARINE BUDS FALLING (A Constant Reader).—Your wood is very weak and a little green, and if the soil was at all dry the buds would be apt to fall independently of the washing with Gishurst compound. The washing is always apt to unsettle the buds. However, we would syringe the trees with clear water, and give a little water at the roots. We cut through most of the fruit-buds which you sent, and found them all perfect. You should have tried the washing at half the strength if you had any doubt. However, we think you will have more good buds than you imagine.

ACORNS FOR PLANTING (W. H. B.).—In some cases that we know of the children of foresters or others who have the privilege of picking up acorns in woods, &c., sell them at so much per bushel to neighbouring nurserymen or others who either want them themselves or dispose of them to those who do want them. We have known them gathered and stored away for the use of game in winter, and in rural districts where they were plentiful have had scores of bushels picked up for a shilling a-bushel. It is now too late to obtain any except from collectors, whom probably some nurseryman will put you in the way of finding out.

CUTTING BACK CAMELLIAS (A. C.).—Camellias bear cutting back as well as any plant that could be named, provided they are healthy. The best time to do it is immediately after they have done flowering. If cut back to the old wood you cannot hope for many flowers next year. If you can place them in a gentle bottom heat, and syringe them frequently, it will greatly facilitate their bursting into growth.

CREEPERS TO COVER A SUMMER-HOUSE THAT IS SHADED AND SUB-ROUNDED WITH TREES (H. H. B.).—In your case there is nothing to equal Ivy, as it can be trained to any shape, and its appearance is always good. You might try some Clematis, as *C. vitalba* or *C. montana*, or a Honeysuckle or hardy Jasmine; but these plants would only endeavour to reach the boughs of the neighbouring trees, and from them push on to the light. By planting some of the Variegated Ivy along with the green, so as to make stripes or panels where there was space, a very good effect would be produced. You might, however, try a Rose or two, an evergreen Honeysuckle, or a Cotoneaster; but, with the exception of the last-named, we have little hope of their succeeding well. *Cotoneaster microphylla* is, however, a useful plant, and may, perhaps, work in.

MAKING A HEDGE OUT OF NAKED YEW TREES (A Subscriber).—We fear it is hopeless to make a good compact hedge out of trees 12 feet high that are naked at the bottom; but if the trees have never been pruned at all, it is possible that some of the upper boughs may be bent down and secured to their place firmly, and a tolerable face obtained with a little good management and patience. If, however, the tops have been cut into form and the bottoms are naked for 5 or 6 feet, the above plan will hardly do; and it would be as well to remove much of the earth near the collar of the present plants and replace it with fresh soil, which, if possible, ought also to be raised something like a ridge, so as to increase the quantity, and on this plant some more dwarf Yew trees. A careful attention to mulching and watering in early summer will enable them to start, though their progress will be slow, and it will be better than depending on the old plants breaking out at bottom. We are always unwilling to recommend the destruction of a Yew hedge, otherwise its removal and the replanting of young plants in fresh soil would accomplish the formation of a nice hedge of some 4 feet high or so to the last time, and appearance would be all in favour of the latter mode. Yew trees may be most successfully planted in September, but any time from that month till May will do. They may also be cut almost at any time; but it is often done in August, as the growth is finished then.

STARTING A VINEY, &c. (A Young Gardener).—To have your Grapes by the first week in June you must shut up your viney and begin forcing the first week of January. Both the Vines and Peaches should be syringed till the former burst into leaf, and the latter are opening their blooms. After that you should discontinue the use of the syringe altogether, unless red spider makes its appearance. While the Peaches are in bloom you must see that the atmosphere is dry till the pollen takes effect. We do not approve of syringing Vines after they have formed leaves; but keep up the moisture by sprinklings of the floor, and gentle evaporation from the pipes or flues. To ripen Black Hamburgs in September in your greenhouse very little fire heat is necessary. The Vines should be allowed to start of their own accord in a greenhouse temperature; and presuming that you can clear out the plants by the end of May, and the summer be a fine one, you need not use fire except when the Vines are in bloom, and in dull cold weather, and as soon as the Grapes begin to change colour, when fire heat is necessary to prevent a cold stagnant atmosphere, which is not favourable to the Vine in any stage of growth, but particularly when in bloom and colouring. To enter fully into all that your questions embrace would require a lengthened treatise, and we would recommend you to get a work on the Vine. Figs require protection from severe frost, and it may be effected in many ways by mats, or fern or straw, either of which materials will do.

SEEDLING APPLE (T. G. H.).—Your seedling Apple is most excellent. Let us know all about it, and tell us what is to be the name of it.

WIRE FOR ESPALIERES (D. M. P.).—Yes, wire will suit admirably, and look much neater than wood, and, of course, last much longer. But why have stone pillars? Iron uprights and strainers, the same as for a wire fence, would be much lighter in appearance, and be less in the way than stone pillars. We should have the wires 10 inches apart. There is nothing gained by having the shoots of the fruit trees any closer together.

WORK ON COLLECTING, &c., NATURAL HISTORY SPECIMENS (W. C. C.).—There is no work known to us embracing the preservation of all kinds of zoological and botanical specimens. Mr. Swainson's volume, in Lardner's Cyclopaedia, includes the preserving of birds, insects, &c. The fourth volume of Kirby and Spence's "Entomology" gives very full directions for collecting, rearing, and preserving specimens of insects. The paper you enclosed will do for drying plants, but we prefer a much thicker kind of bibulous paper. Nothing is required for preserving plants but to arrange the specimens in a natural position, without one part overlapping another part, to give them gentle pressure, and to dry them quickly. The quicker they are dried the better are the colours preserved.

NAMES OF FRUITS (A Constant Subscriber, Bavtry).—Your Pear is the *Passe Colmar*. (*T. G. H.*)—1, American Fall Pippin; 2, Toker's Incomparable; 3, Gloria Mundi; 4, Beauty of Kent.

NAMES OF PLANTS (Penelope).—1, *Polystichum angulare*; 2, *Asplenium adnatum nigrum*; 3, *Lastrea Filix-mas*.

POULTRY, BEE, and HOUSEHOLD CHRONICLE.

REVIEW OF 1863.

The unwearied foot has again performed its journey. Days, weeks, and months have fulfilled their appointed time, and our yearly task is before us. We would begin, as is our custom, by expressing our gratitude that we have been spared. We are always thankful that our task is comparatively trifling, that no weighty interests can suffer by a weak advocacy at our hands, and that our readers and contributors are all friends. We can sport with such terms as the "Holy Alliance," we can dilate on the *entente cordiale*, and "Unhappy Poland" suggests to us only a top-knotted fowl. We have nothing we can compare to the "Congress" except the "Poultry Club," which seems to be a sort of "Poultry Trinity House," laying down rules and granting certificates of competency to the pilots of poultry shows. May it prosper according to its desserts. We wish well to any

that can forward a favourite pursuit. There never was time when less steering was required. The whole pursuit has sailed peaceably during the year; it has been a halcyon time, and when now and then a piratical craft—generally sailing from Manchester or theabouts—has pounced on some good sleek and prosperous exhibitor, cheating him of two or three valuable pens of poultry, although we have been unable to get the birds back, we have mostly given such publicity to the proceedings, and so described the ports from which the pirate hailed, that his occupation was soon gone. If the victim has ever read "Little Pedlington"—if he has not we advise him to do so—he will recollect, at the soirée given by Rummis, the antiquarian, that Miss Enaj Sbbures (to the initiated, Jane Scrabbs) let fall the cup and saucer on the entrance of the stranger, and exclaimed, "'Tis gone, 'tis lost; the fairy spell is broken!" "So are my cup and saucer," said the indignant antiquarian, and "So are my pens;" will the victim say.

Our review of the different classes will be a laudatory one. Many have improved greatly. The least favoured have held their own as compared with last year. Certain breeds would appear always to be in favour, like some useful colours in dress, as black, some shades of brown, and slate; while others reign for a time and then suffer eclipse, like mauve, magenta, cuir, &c.

Dorkings are always looking up. They increase in size, entries, and popularity. They contribute more than any other breed to the amounts at the sale office. They are, more than any others, an epitome of poultry shows. The bird that won easily ten years ago, and was unquestionably rosy at the end of two days, has disappeared to make room for the hardier, handsomer, and heavier bird that now wins with difficulty.

Some breeds are intimately associated with names, and when their support is withdrawn the classes suffer. Spanish first leant on Capt. Hornby. They attained their apogee at the hands of Mr. Davies; they maintained it with Mr. Bake, but since he has given up they have not been so good. We look for their revival.

The good old Cochins "keep on the even tenor of their way." Through good and bad repute they have held their own, and good birds make good prices. They are still favourites, and they deserve to be so. The Buff and the Partridge are decidedly better than the White.

Brahma Pootras are established, and maintain their right as a distinct and very valuable breed. They fill good classes, and are attractive. Our own opinion remains unchanged—they are among the best fowls ever introduced.

Malays were never better than they are now; but their entries hardly justify the amount given to them in a prize list.

We have been everywhere disappointed in the entries of Crève Cœur. There is no doubt they are a valuable importation; but the Various class must be their home until they can show in greater numbers.

Among the Pencilled Hamburgs the Golden are far in advance of the Silver. The latter want the care and knowledge of Mr. Archer. The Spangled have been very good, and the Black a great success at Birmingham.

All the Polands have exhibited pens of undiminished merit during the year. Mr. Adkins' Silvers are perfect, Mrs. Pettat's Golden and Mr. Edwards' Black deserve the same praise; but they are not sufficiently numerous.

It is only necessary to say of the Game that they are perfect.

Bantams are still great favourites, especially the Game. Their numbers throw the Sibrighs into the shade. All that can be said of Aylesbury Ducks is, they have held their own. The year shows no progress. Rouens have beaten them in numbers, and they tread on their heels in weight. The Black Ducks have throughout the year been numerous, excellent, and attractive.

The average of Geese and Turkeys has been about the same as former years; but individual pens have not been so heavy as they are sometimes. We have far more pleasure in chronicling a large average than a few very heavy exceptions.

Poultry shows have remained popular through the year. Some die annually, some start afresh, and others spring from the ashes of their predecessors; but it is become a pursuit. Poultry sales have much increased all over the kingdom. There is everywhere a steady and good demand for average poultry. On one point we are stationary: the quality of the poultry at country markets has increased, but the quantity is still small—not sufficient for the demand in many places.

We believe some of the millions of eggs that are every year imported might be produced at home by keeping the proper breeds, and we anticipate good from the introduction of the Crève Cœur and La Flèche. We have tried both, and they are

wonderful layers of large eggs. Since the beginning of that which was called a mania, fowls have increased 1½ lb., Ducks 2 lbs., Geese 4 lbs. each. If the numbers that have been consumed were multiplied by these figures, the result would be startling.

We have thus to be the historians of a year of peace, and we hope to be the harbingers of another. We have no disposition to be partisans of those who like broils. We are not averse to open our columns to a friendly joust with blunted weapons, but when the shield is touched with the sharp end of the lance we are sorry. For these reasons year after year we congratulate ourselves on the reflection that an address to "Our Friends" includes all our readers. It is a satisfaction to all on our staff to reflect that when this Journal is on the Tuesday morning's breakfast table, it has the smile and reception due to an old friend. Its advent is looked for and wished for.

Our position in this Number is peculiar. Like birthdays, it "comes only once a-year." Then, as now, we seem to be face to face with our subscribers. Closing our eyes and giving the reins to imagination, our office becomes filled with figures all pressing forward to us, many well-known faces, tried friends, but all full of kindness, all anxious for our welfare. We thank them for their kindness. We do not hesitate to tell them that things have gone smoothly with us, and that our circulation increases.

We try to go farther into explanation, but it involves too much. We try to shake each and every one by the hand, but it would take too long. We, therefore, leaning on the experience of the past, gratefully and warmly thank our friends; and, looking with confirmed hope to the future, wish them heartily, and will strive faithfully to render it,

A HAPPY AND PROSPEROUS NEW YEAR.

IRREGULAR ADMISSION TO THE BIRMINGHAM POULTRY SHOW, 1863.

WITH reference to a paragraph which appeared in our Journal of last week, we are requested by the Secretary to state that, in consequence of the reporters having to prepare for Monday's papers, it was necessary to open the poultry bay for a short time after the Judges had completed their awards, and that any person who had paid 10s. to view the cattle-judging was at liberty to enter, and that Captain Heaton did not enjoy any special privilege.

Not any of the prize cards were put up on the Saturday evening.

THE BIRMINGHAM DIFFICULTY.

CAPTAIN HEATON'S explanation in your last paper is quite satisfactory; and whilst it frees him from any suspicion of unfairness, it closes the correspondence as it regards himself.

Captain Heaton must, however, pardon me for quoting the following words from his explanation, and dealing with them as they regard the Birmingham Show. He says, "I was one of those who paid 10s. to see the cattle judged. About six o'clock—the Judges having completed their awards—whilst I was talking to one of the Committee, I heard him give an order to the policeman in charge of the entrance to the poultry department to admit all who wished to look at the fowls." What right had any Committeeman to give an order of this kind? If he had the authority of the Committee generally, or a majority of them, what right had they to give a privilege to those who had the 10s. admission to the cattle show, when in the programme of the meeting it is distinctly stated that this admission was not to apply to the poultry show?

According to the statement made by you on the authority of the Birmingham Committee, persons were not admitted to the poultry bay "until some time after the Judges had given in their awards in the Cochin classes." Is this a vagueness of expression, or is it true that persons were admitted during the award of the prizes to the poultry before all the awards were finished, but after those of the Cochin classes had been given in? This requires an explanation.

I am sorry the communication signed "GAME COCK" is anonymous, but it is nevertheless deserving of notice. Taken with Mr. Hindson's own statement, it must not be overlooked. In that gentleman's first communication on this subject of the last Birmingham Show he says, "I discovered from *peculiar marks*, but not until after the prizes had been awarded, that the birds in question exhibited by Mr. Williams were my own property." The italics are my own. If the marks on the

nostrils, in all the three pens mentioned by "GAME COCK," and observed, I will say, by very many others, were by a like accident to be found in any other pens in the Exhibition, then I will ask, Were these the *peculiar marks* mentioned by Mr. Hindson? If so, surely his critical observation of these pens, and his familiarity with the *peculiar marks* of his own birds, must have struck him before he awarded the prizes.

Mr. Smith, Mr. Hindson's colleague, sends you a generous defence of his fellow Judge, but his assertions are general and not particular. He speaks throughout of what he believes and not of what he knows. Mr. Smith, however, arrives at the gist of the question as regards Mr. Hindson in these words, "Were these fowls sent to Birmingham with Mr. Hindson's knowledge or consent?" That they were there, that they had *peculiar marks*, yet that Mr. Hindson had awarded prizes to them, is admitted by Mr. Hindson himself. It, therefore, rests with him to show that the birds in question were not there with his knowledge and consent, and he must show how these *peculiar marks*, by which he knew his own birds, escaped his notice until after the awards had been given in and the prizes publicly declared. I do not wish to doubt Mr. Hindson's word, I will not attempt to press even a suspicion of dishonesty upon him; but as I have taken this matter out of the hands of anonymous accusers, I am entitled to require an explanation.

Mr. Lythall, the Secretary to the Birmingham Cattle and Poultry Show, tells us that Mr. J. H. Williams, in whose name Mr. Hindson's Game fowls were exhibited, is the Mayor of Welshpool. This last gentleman has not yet afforded us any explanation. He must, therefore, accept all the disgrace to which he may or may not be entitled.

I shall await the answers to these remarks with some interest. I am sorry that they are needed; but as they are, I do not flinch from them. I do not wish to do anything more than to secure care and fairness both in shows and exhibitors.—GEORGE MANNING.

CAPTAIN HEATON'S CUP COCHINS,

MR. HINDSON'S SLIP BETWIXT THE CUP AND THE LIP,
AND MR. FREDERICK HARDY'S COCK O' WAX.

I FORETOLD a difficulty concerning the Birmingham Show. I said that probably you would hear from me again on the matter. I withheld this communication that I might see how the abuses which occurred there would be received by others. I was not wrong in the prediction. I am, to a certain extent, satisfied with the way in which the fulfilment has already been attacked.

The Birmingham ten-shilling day has borne the fruit that was to be expected. The golden key has been used. Concessions have been made to the wishes of the few, and advantages have, of course, been taken to the prejudice of the many. Suspicions have been aroused, and confidence shaken. A war of words has arisen which necessarily weakens that friendly feeling which should exist between rivals in a fair field. One act of irregularity and unfairness—the Birmingham ten-shilling day—a pandering to the wishes of a few, has caused all the annoyance. The principle on which it was founded was unsound and the application of it has been necessarily mischievous.

Mr. Hindson, endorsed by Mr. Smith, shifts the charge against himself to the shoulders of J. H. Williams, Esq., of Spring Bank, near Welshpool. Then arises the question, Who is this J. H. Williams, Esq.? This is a query which must be answered. Is he another "Josh. Goddard," or a man of straw? At present he keeps out of sight. This will not do. It is only fair that a chance should be given for setting this right. If it is not done soon by himself or the persons most interested in his existence, some one else may be found to do it. Who is J. H. Williams, Esq., of Spring Bank, near Welshpool? is a question which must not be put aside.

With regard to that pitiful "cock o' wax," to use a vulgar, but, in this case, singularly applicable expression, Mr. Frederick Hardy, of Quarry Gap, Bradford (who by the way had nothing to do with the Birmingham Show), were it not that the principle of honesty and fair dealing must be upheld by the exposure of offenders, he would be passed over with a sneer. I am glad my suggestion that exhibitors should ventilate all cases of dishonesty and unfairness seems to be well taken up. I shall never fail to contribute my mite in the cause of honesty.

I am, as I have said before, an exhibitor in a small way. It is my intention to exhibit largely if I can, in the course of time. I mean to spare neither pains nor expense in the production of first-rate birds, the qualities and descriptions of which shall be above suspicion. Of course, with some of your correspondents I shall be deterred from entering at exhibitions where unfairness is practised, but I am determined to do battle for the right. Neither Council, nor Judges, nor exhibitors, will smother my determination; and if Shows and exhibitors are not straightforward they may find that they can be made so, or branded with a mark which all honest men will avoid. I am willing to expend time and trouble in the attempt.—EGGERT.

RELATIVE ENTRIES.

DARLINGTON SHOW.

THOSE who have at all examined the schedule of this Show must have observed a peculiarity in its construction. The entries vary according to the prizes offered. This I have on a former occasion noticed in your pages as a desirable plan. At least, it is but fair that where a small prize is offered there should be a smaller entrance fee required. I am not at all prepared to say that the Darlington schedule is perfection, it will bear much improvement, but chiefly in the way of increasing the value of the prizes. Look at the value of the prizes offered for Bantams; for a show of the Darlington calibre, 30s. and 15s. are not of sufficient value to induce breeders to send birds a long distance. We find this even where larger sums are offered. Where are the Bristol Spanish-breeders? Mr. Rodbard exhibits one solitary pen, but Messrs. Lane and Parsley are absent. In White Dorkings we miss well-known names. In Brahmas I notice the absence of Messrs. Priest, Wright, &c. I do not mean to say positively that with larger prizes this would have been otherwise, but it is worth the trial; and the entries this year at Darlington—more than 800 pens, give, I should imagine, a liberal margin to the compilers of future schedules.

The analysis of this Show as to relative entries, brings out some curious results. In the first place, the north-country breeders fancy certain breeds—to wit, Game and Hamburgs. Both these classes enter well, especially the former; but I was not prepared to find that the diminutive Bantam would be by far the most profitable to the Darlington Committee. The prizes offered were piteously small, but the carriage of these pignics is so light, that it compensates for small prizes. As to certain classes where silver cups were offered, I have in my calculations added the cup in lieu of the prize that would have been obtained. It is very probable that these additions, which every exhibitor, of course, hopes he may be fortunate enough to obtain, have influenced in the right direction the entries at this Show.

Let us turn to the figures, which are as follows:—

Order of Merit.	Breed.	No. of Entries.	Prizes offered.		Returns as per Entries.	
			£ s. d.	£ s. d.		
1	Bantams	83	8	0	12	9
2	Game	140	28	0	32	18
3	Hamburgs	171	20	0	17	6
4	Dorkings	186	22	5	18	8
5	Spanish	127	9	10	6	15
6	Brahmas	22	6	0	4	4
7	Cochins	61	19	15	12	17
8	Polish	6	3	0	1	10

Plainly, then, at Darlington, the little Bantam had not justice; Dorkings and Hamburgs run very close for third place—indeed, they for all practical purposes may be considered equal; and as much may be said for the Spanish and Brahmas for fifth place, the latter, however, having prizes of less value. Cochins are not so numerous as we might have anticipated.

Taking the adult classes generally, the entries are scanty, the Brahmas treading closely on the Spanish, and outstripping Buff Cochins, Any other variety of Cochins, White Dorkings, Pencilled Hamburgs, and the Polish and Laced Bantams, even when "any age" was allowed.

Although, then, the analysis of Darlington entries does not turn out so good a case for the Brahma as the other notes I have laid before your readers, yet it distinctly proves that no show, arrogating to itself the title of "grand,"

ought to ignore them; yet, I have lately seen the prize schedule of the Fendal "Grand" Show. I looked in vain for the Brahma classes. I presume the printer or some of the officials have made a mistake.

There is one very curious point at Darlington. Although the Show was so large—nearly 600 pens of poultry, exclusive of the "selling class," there was no class for Malays. This splendid, long-established breed was absolutely unrepresented!—T. B. A. Z.

HECKMONDWIKE POULTRY SHOW.

The second annual Exhibition of Single Cocks took place on December 26th in a large new warehouse kindly lent for the occasion by Mr. Joshua Walker. The building is very well adapted for the purpose, and was well lighted and warmed by means of lamps and fires placed in different parts of the room.

The Show was a decided improvement on that of last year, both as regards the quantity and quality of the birds exhibited, and the attendance of visitors was very good; the proceedings of the afternoon being enlivened by the excellent music performed by the far-famed Heckmondwike old brass band.

A large number of sales were effected during the day. We saw 45 received for a Black Bantam cock, and five guineas refused for a Japanese Silky cock, a good specimen, to which the Judges awarded the second prize.

The Game classes were well filled, and some really excellent birds were shown, as the names of the different exhibitors will testify. The Spanish, Hamburg, and Brahmas were equally meritorious, and the Bantams first-rate.

GAME COCKS (Black-breasted Red).—First, W. Whiteley, Liversedge. Second, J. & T. Sunderland, Coley Hill, near Halifax. Commended, B. Naylor.

GAME (Brown Red).—First, H. C. Mason. Second, A. Hodgson, Ilkington. Commended, J. & T. Sunderland, Coley Hill.

GAME (Duckwings and Greys and Blues).—First, A. Hodgson, Ilkington. Second, W. Whiteley, Liversedge. Commended, J. Alderson, Halifax.

GAME (White and Piles).—First, W. Whiteley, Liversedge. Second, D. C. Mason, Dighton. Commended, S. Lightowler, Northwram.

GAME (Black and Brassy-winged).—First, J. Brook, Gomersal. Second, G. Robertshaw, Hartshead.

GAME BANTAMS (Red).—First, Beaumont & Ineson, Heckmondwike. Second, W. Gregson, Dewsbury Moor.

GAME BANTAMS (Duckwing).—First, C. Lister, Mirfield. Second, Wallis and Oldroyd, Dewsbury.

BANTAMS (Black).—First, T. P. Preston, Heckmondwike. Second, S. Schofield, Heckmondwike.

BANTAMS (White).—First, S. Schofield, Heckmondwike. Second, J. Brook, Gomersal.

SPANISH (Black).—First, T. Greenwood, Dewsbury. Second, Wallis and Oldroyd, Dewsbury.

TOULAND (Any variety).—First, W. Gregson, Dewsbury Moor. Second, J. Wilson, Dewsbury Moor.

HAMBURGH (Spangled).—Prize, H. Hemingway, Heckmondwike.

HAMBURGH (Pencilled).—First, J. Ineson, Heckmondwike. Second, C. Lister, Mirfield.

HAMBURGH (Black).—Prize, C. Lister, Mirfield.

BRADRA POOTRA.—First, C. Lister, Mirfield. Second, J. T. Jackson, Bolton.

ANY OTHER DISTINCT VARIETY.—First, C. H. Wilson, Kendal (Japanese Silk). Second, C. Lister, Mirfield (Japanese Silk).

Mr. Wm. Marriott, of Dewsbury, and Mr. J. W. Thompson, of Southwram, officiated as Judges.

PLUMAGE OF EXHIBITION POULTRY MUTILATED.

I REGRET to have to complain of a practice which I fear is being adopted by some person or persons frequenters of poultry shows. I allude to the mutilation of the plumage of birds sent to exhibitions.

I am induced to write in consequence of my cockerel in the second-prize pen of Silver-pencilled Hamburgs at the last Newport Show, being deprived of his streamers, and thus effectually prevented from being exhibited again this season. I am also informed by a friend, that one of the streamers of his cockerel in the Silver-pencilled Hamburg chicken class, at the last Islington Show, was nearly severed in two, apparently by scissors.

If these practices are allowed to continue there will soon be an end to poultry shows, as no exhibitor who cannot afford to send his feeder with his birds will expose them to

the risk of the injury now complained of. I trust that your giving publicity to this fact, may be the means of preventing a repetition of such dishonourable proceedings.—JOHN HOLLAND, *Worcester*.

[We insert this as suggesting to the Committees of poultry shows to be on the alert, but, at the same time, we must express our conviction that such injuries are rarely caused whilst the birds are in the custody of the Committees. The form and structure of the baskets the birds travel in, and want of care by railway officials, are the usual sources of injury. We have seen the sickle feathers of a Dorking cock, projecting and broken through an opening in the canvas which enveloped the basket the bird was journeying in.]

THE CHRISTMAS POULTRY MARKET.

THERE was this year the usual supply of poultry, but hardly equal in quality to the ordinary provision for Christmas. There was a good but vacillating trade, and the railways do not appear to have had sufficient strength to carry on the increased trade. Tons of goods were delivered too late for any but the fag end of the market, and the senders will suffer in consequence. Prime goods sold readily at large prices, but ordinary qualities met a hanging market. It is impossible to give any quotation of Turkeys. Assuming all to be the same quality the heaviest are worth most; but one pound over nineteen is more valuable than four under sixteen. They sold for all prices, from 6s. to £2 each. It is impossible to give any detailed quotations of such a market.

GAME FOWL PRIZES AT MANCHESTER.

I SEE from the prize list of the Manchester Poultry Show, that one of the Judges of the Game classes was Mr. Challoner, of Chesterfield. I observe also that a Mr. Challoner, of Steely Farm, Whitwell, Chesterfield, takes the first prizes in Classes 82 and 86 at that Show. I hope these gentlemen are not identical or related.—P.

[We believe that the prizetaker and the Judge alluded to are brothers. This had better be avoided, but we have the assurance of a very competent and perfectly unbiassed judge that the best birds won.

Such communications as this, others which we have recently published, and some we shall not publish unless needed, are warnings to all concerned with poultry exhibitions, that more than one "chief's among them takin notes," and that they must not have even a thin place in "a' their coats."]

FOUL BROOD.

In every discussion it is of the utmost importance, nay, an essential requisite, that we should not only know what the subject really is regarding which we are to give our opinions, but also that the terms employed to define its nature or character be unambiguous and clearly understood. This is the more necessary in regard to the question before us, inasmuch as there is an evident want of concord betwixt my opponents and myself as to what foul brood actually is. Hence, if I were to argue the subject without clearly defining my position, I might in the end be accused, as I have elsewhere been, of raising up a mere man of straw in order to provide myself with the exquisite pleasure of knocking him down again—in other words, my premises being considered false, my conclusions would necessarily follow as worthless.

The primary question, then, in this controversy is—What is foul brood?

Foul brood I define to be brood which has become decomposed and putrescent in the cells. It originates by the young larvæ and other embryos being in the first instance exposed to chill and neglect or other adverse extraneous influences, whereby they become abortive and die, and ultimately through the operation of natural laws, decay and degenerate into putrescent, decomposed matter called foul brood. These corrupt embryos assume a variety of appearances according to age and condition. Those in the larvæ

state exhibit during the first stages of decomposition a pale, pulpy appearance, which gradually changes afterwards into a dark brown slimy matter emitting a most offensive odour, whilst those in the pupæ condition exhibit various appearances according to age, the nearly matured embryo by reason of its greater solidity being least affected; and interspersed throughout are a number of cells, which, though sealed over, are found on examination to contain nothing but a little dried up particle which apparently had once been an egg or newly hatched grub.

This is my definition of foul brood, which I have pretty fully stated in order to render it as intelligible as possible to all.

Now let us see what is the definition of foul brood given by my opponents, of whom I reckon Mr. Woodbury the chief. "Foul brood (he says, No. 124, page 118) is, as its name implies, a disease which attacks the young larvæ in their various stages of development. At first only a few die, but as these putrefy in their cells the infection spreads, until very few bees arrive at maturity, and the stock dwindles and ultimately perishes."

Now so far as these definitions are concerned, it does not appear that there is much difference of opinion as to the thing described, indeed we seem to be at one on this point. The want of concord consists chiefly in the different views assigned for its origin. In the former definition I have assigned the origin of foul brood simply to the absence of those conditions which Nature has provided as necessary for the development and maturation of the embryo insect; whereas in the latter the origin is assigned by Mr. Woodbury to a disease which attacks the young larvæ in their various stages of development.

But here let me observe that it will not do for Mr. Woodbury to interpose at the very outset of the argument and say—"This foul brood which you describe is not the same as I have written about. It may simulate some of the evils and not a little of the appearance of actual foul brood," but it is not the "true disease"—and hint as he did at page 342, that I have not yet had the misfortune to meet with it in my apiary. For, if I can put into his hands a piece of comb full of foul brood originating in the way I have stated, and which he could not distinguish from that which he found in his own apiary, but which he asserts to be the result of disease, then, surely, it rests upon his shoulders to show wherein the difference consists.

Assuming, therefore, as I am entitled to do, that we are at one as to the thing described—as to the identity of foul brood—our concord I admit here ceases, and we immediately diverge into separate paths when we seek a solution of its origin.

It would appear, however, that certain revelations have recently been communicated to Mr. Woodbury from some valued correspondent in the north, so as to shake somewhat his former convictions on this point—revelations, "which (as he says) countenance the suspicion that an overwhelming quantity of chilled brood may, under exceptional circumstances, degenerate into actual foul brood, just as an ordinary cold in the human subject may occasionally, although rarely, be developed into malignant fever." This I take so far as a concession, notwithstanding the subjoined caveat that it may be a "mere coincidence;" and I have no doubt whatever that still farther inquiries and renewed personal researches on his part, will show that not only exceptionally, but always, the like results may be traced to like causes.

But there is one impediment to my opponents accepting the views which I have propounded as to the origin of foul brood, which, unless removed, I shall have little hope of entirely convincing them by any process of reasoning whatever. This has reference to what I designated in my last paper the subsidiary question raised in this controversy—viz., "Do bees remove decayed and abortive brood in all stages from a hive in which it finds a place?" To this question, therefore, I shall now apply myself, for if I can show that they do not, be the cause what it may, it matters little, then I am hopeful that others will come to "see things as I see them," and believe that foul brood is originated in the way I have stated.

On referring to one of my articles entitled "Weak and Unhealthy Hives," No. 125, and at page 99, when pointing

out the great evils sure to be entailed upon a hive of which the brood-combs are allowed to get chilled and lifeless by too long exposure to the cold air, I say, "Then is laid the foundation of future evils, which it is scarcely possible to overestimate. The unhatched larvæ get corrupted in their cells—the bees do not remove them if they can—the eggs laid in contiguous cells are affected by coming into contact with these cold putrid bodies, and remain also unhatched. The evils increase, and eventually, if these are not timely rectified, the hive will become a complete wreck." Again in my paper "An Experimental Apiary," No. 134, and at page 323, I have repeated the substance of the words which I have quoted above in italics, and to which particular exception has been taken, when, in referring to the light manner in which the presence of chilled or dead larvæ in a hive is viewed by some parties, and the assertion that such are always removed by the bees, I say "No! Decayed and abortive brood in all stages are not removed by the bees, and consequently must remain a permanent evil in whichever hive they are unfortunately found."

Now no experienced apiarian, I should imagine, could fail to understand the meaning and import of these words, and accept them as true. Nevertheless, these averments are met by Mr. Woodbury, "B. & W.," and Mr. Edwards by a direct contradiction. That I am "mistaken with regard to the general indisposition of bees to remove chilled, and therefore abortive brood," in Mr. Woodbury's paper, p. 342, "my dictum," as he calls it, on this point is classed among many other "singularly erroneous assertions" which he says he has refuted. Mr. Edwards also meets my assertion with a direct negative. He says in No. 137, page 380, "Mr. Lowe charges us not to repeat that bees will carry out of their hives chilled and abortive brood. Nevertheless I must and do repeat it." So likewise "B. & W." in No. 136, page 364, meets my assertion in language of unmistakable significance. In suggesting to me the necessity of reflecting on the "error of my ways," he says—"A notable instance will be found in this very question of foul brood. Very positively he asserts that 'decayed and abortive brood in all stages are not removed by the bees.'" As positively I assert, "from my own experience that they are removed by bees."

Now as my views of the origin and nature of foul brood are based upon the facts contained in this question, it is of the utmost importance to examine into it minutely, and see how matters really stand. The question now to be considered then is, "Whether bees do remove decayed and abortive brood in all stages from a hive in which it has found a place?" My assertion is that they do not, and I will now endeavour to vindicate that statement by proofs from my own experience and observation. This, no doubt, is a question of experience, and I court the fullest examination.

The Rev. W. C. Ellis said, in his article on foul brood, No. 126, page 158, that Mr. Woodbury's experimental system gave him a great advantage over me in discovering facts. He will be surprised, perhaps, now to know that it was this very experimental system which at first unfolded to me the evil effects of allowing decayed and abortive brood to find a place in any hive, and thus to discover the nature and origin of what is called foul brood.

During several years I was in the practice of preventing as much as possible natural swarming in my apiary, by having recourse, among other experiments, to the process of artificialising. This practice was in a manner forced upon me from considerations of convenience, if not of necessity, and may be reckoned as one of the penalties imposed upon those who, like myself, keep bees in town localities. In my efforts to discover the best mode of accomplishing this object, I was consequently led into a little experimenting. Two important facts were disclosed in these experiments to which I have referred elsewhere—but both, strange to say, have been equally unfortunate in securing in the pages of this Journal a favourable reception. The first and most important fact is, that foul brood is frequently introduced into hives so operated upon unless due care and precaution be taken to prevent it. And second, that artificial swarm-making, unless performed in strict accordance with the natural instincts and habits of the bee, and a due regard to time, circumstances, and condition, the results will always be

unsatisfactory and frequently productive of much evil. And here, by the way, I would direct Mr. Edwards's particular attention to this last statement, inasmuch as I was pleased to think that he appreciated its soundness, as he apparently did in his remarks on "Experimental Bee Management," in No. 125, page 137; but I was disappointed afterwards in observing, by a subsequent remark made by him on "Forced Swarms," No. 137, page 381, that he had not after all realised its full meaning and significance. In my remarks on inexperienced operators in one of my papers, I said, "Ready or not ready he drives his swarm." With reference to this Mr. Edwards exclaims, "Who, in the name of common sense, would ever think of driving his bees ready or not ready? When the honey season has fairly set in, when the population is overflowing, and drones have been reared, they are always ready." From this it is evident that the idea never crossed Mr. Edwards's mind that a hive though full to overflowing with bees and manifesting all the exterior symptoms of general readiness, may, nevertheless, not only be unprepared to swarm naturally, but also unfit, and not in a condition to be operated upon artificially; and this latter unfitness, not simply because it may not have any royal cells formed or in course of formation, but because of the absence of other essential conditions well known to the scientific apiarian who is conversant with the mode in which the queen conducts the business of oviposition. Herein lies one of the great secrets of success in artificial-swarm-making, a want of the knowledge of which is productive of so many failures in the hands of the novice.

But to return. In conducting the experiments before referred to, and in working out the various details necessary as to driving, apportioning the number and kind of bees requisite for each colony, and above all as to the arrangement of sites, I noticed that when the old hive was removed a short distance to a new site with a much-reduced population, and when every comb was literally filled with young brood in all stages, and when the new swarm was placed in the old hive's stance, that the former would frequently lose a considerable number of its bees, more or less according to circumstances, by what I would call involuntary desertion—that too few bees would remain, in these circumstances, to preserve the necessary degree of heat in the hive for hatching and maturing, and also for nursing and attending to the immense quantity of brood in all stages in such a hive. The consequence of all this was that portions of the brood-combs were left uncovered and neglected by the bees, the uncaared-for tender larvæ died, and not being removed by the bees they decayed and corrupted in their cells, and thus gave rise to those evils which no future action on the part of the bees was sufficient to remedy.

Now the plain questions to be put here are, What else could we look for or expect in the case of a hive in such circumstances? and what are these decayed and abortive forms in all stages to turn to?—What but decomposed and putrescent matter, which we call foul brood?

But why did the bees not prevent this state of matters by immediately setting to work and extruding every chilled larva and affected pupa? Mr. Woodbury would answer the question by saying that the "energies of the bees are hereby entirely crushed under an overpowering mass of chilled brood, and they sink despairingly under the incubus." But while Mr. Woodbury replies in this way, let me recall to his mind that according to the definition he has given of foul brood, when the disease commences a few only of the young larvæ die at first. Now suppose (and I wish this to be particularly noted), we are here dealing with a healthy populous hive attacked for the first time by this so-called disease, how happens it, let me ask, that the bees do not themselves arrest its progress at the very outset by pulling out from their cells every dead and diseased larva? Why is it, I ask? Because if it is only when "these putrefy in their cells" that the "infection spreads," why do not the bees remove the dying and dead brood before the infection spreads, as they are said to remove "decayed and abortive brood" in other circumstances, and thus arrest the evil at once? No plea can here be urged that the bees are crushed under an overwhelming quantity of dead brood. They have here only to deal with a few, for "a few at first only die." Then why do the bees not remove them?

But to return to the consideration of the operations above

referred to, which gave rise often to such evil results, but to which Mr. Woodbury would probably urge the objections before stated. Well, by-and-by the hive in question becomes pretty populous. The bees are numerous enough to hatch a goodly number of the young brood, and these now spread themselves over the combs and fill, it may be, every opening. Do the bees now remove the decayed and abortive brood in all stages from the combs formerly neglected? No, certainly not. But this hive might still be reckoned a weak hive; and it is but fair that I should here state that "B. & W." admits at page 364, No. 136, that with respect to weak hives, decayed and abortive brood "must remain a permanent evil if not removed by the bee-master's hand." This I think, however, seems irreconcilable with his former assertion that decayed and abortive brood in all stages "are removed by the bees," and certainly requires an explanation; for if it is contended that in this case bees do not remove such by reason of the weak condition of the population, then it follows that if those unfavourable conditions were altered, and the weak hive were converted into a strong one, then it is to be presumed that according to "B. & W.'s" theory the decayed and abortive brood would, as a matter of course, be speedily removed by the bees. Now is this the case? Let us see. Suppose I were to add to this not-very-populous hive a whole swarm of bees, as I have done, what now are the results as regards the decayed and abortive brood which have become putrescent in the cells? Do the bees remove them from the hive? The answer must still be the same—No. They still remain, and will continue to remain a permanent evil in this hive, which nothing that I know of can eradicate but a complete excision and removal of the whole of the affected parts.

Now if experience shows, as I have again and again found it does in such circumstances, that decayed and abortive brood in all stages are not removed from a hive in which it has found a place, even though that hive's population be afterwards doubled or quadrupled, then it follows that "B. & W.'s" admission is not only applicable to the case of weak hives, but also to very strong ones; and consequently nullifies the strong disclaimer he made to my statement that "bees do not remove decayed and abortive brood in all stages from the hive."

But suppose "B. & W." takes exception to these cases, and falls back on another statement he made in that article—viz., "But in strong hives the bees are fully up to the requirements of the case, and remove all impurities as they occur." Suppose he does this—what then? If bees do really remove all impurities as they occur, then I say it is impossible that such a thing as foul brood, as understood by "B. & W.," could find a place in a hive at all, for the manifest reason that the very first symptoms of it would be checked, as I have before said, by the removal of the diseased and dead larvæ by the bees as they occurred before the infection spreads, and which only takes place, it is said, when these become putrescent in their cells.

I will now give an instance of a recent case in which foul brood has been generated in my apiary.

In a very populous octagon frame-hive I reared a young queen which emerged from her cell on the 30th of July last. On August 28th she still remained in a sterile condition, and with the view of improving the declining strength of this hive, I put the brood-combs of a hive which I had broken up for another purpose into a suitable-sized top, and placed them above the octagon. These combs were full of brood in all stages. Though the bees were not very numerous, yet considering that they had no brood of their own to attend to, I anticipated that they would have taken possession of these immediately. I was not disappointed in this expectation, though on examining the hive in a day or two afterwards, I was surprised to find that the great majority of the bees had again descended. From this it was evident that the queen had remained below. Such a state of matters informed me what the result would probably be. The more matured pupæ would most likely hatch, but I had but little hopes of the neglected larvæ. I was glad to observe, however, after examining the brood-combs about a week afterwards, that a considerable number of young bees appeared, while my attention was drawn to the fact that many of the bees escaped from their cells were somewhat deformed and imperfect. On the 11th of September I removed the top with

the intention of dislodging all the bees from it, and I now found it, strange to say, well filled. On examining the combs before doing so, I found fresh eggs and grubs interspersed throughout, clearly indicating that the queen had now taken possession and had, moreover, at last become fertile. I also observed that the greater portion of the former brood had become abortive in their cells. I allowed these combs, therefore, to remain in this state as an experiment till the 25th September, when again examining them the peculiarly disagreeable effluvia which was emitted from these but too plainly informed me that foul brood in its worst form had manifested itself. I drove out, therefore, all the bees and replaced them in the hive below, the queen among the rest, who appeared much swollen, and she had now apparently become very prolific. On examining the combs a most singular spectacle presented itself. Every unsealed cell was occupied either with eggs, with fresh grubs, or with foul, the greater portion, however, were sealed over. Of these, I found a few containing live pupæ, but the great majority were dead. The putrescent larvæ, also, were mostly sealed over, also a number of seemingly empty cells as in most cases of foul brood. Here, again, we are enabled to trace like results following like causes—namely, chilled and neglected larvæ degenerated into actual foul brood. I need scarcely here repeat the question already so often put as to the facts here elicited—Why was this state of things not prevented by the bees by the removal of the decayed and abortive brood from the hive, if such be their practice?

I will relate two other instances of foul brood originating from chilled and neglected brood, which though not occurring in my own apiary I was partly an eye-witness of.

In the autumn of this year I sojourned for a short time with a near relative in Perthshire, whose knowledge of the bee dates with my own—from boyhood. During my residence with him I assisted in uniting the population of a weak hive to a young swarm of this year, domiciled in a Huber-hive of pretty large dimensions, two leaves of which were yet unfilled with combs. The brood of the broken-up hive we fixed in these leaves. The Huber-hive being large and its population not particularly numerous, we found on examination afterwards that the bees had but very sparsely covered the combs, the outer one indeed was left nearly neglected. They were nevertheless allowed to remain in this position as an experiment, and what has been the result? Exactly similar in character to the case last described by me—the manifestation of foul brood. A specimen of the combs was afterwards sent me which corresponded exactly with that produced in my own apiary. I have had both subjected to microscopical examination, to which I will afterwards allude.

The other case also occurred in the same apiary. In July last I sent to the gentleman above referred to one of the most prolific queens in my possession for his use. In his apiary stood a most powerful hive, weighing upwards of 50 lbs., full to overflowing with bees. This hive he determined to artificialise, and accordingly drove an enormous swarm from it along with the old queen. The young swarm he removed to the distance of about a mile and a half, and to the bees retained in the old hive he introduced the queen I had sent him. In consequence of the large capacity of the domicile, and the enormous quantity of sealed and other brood, he discovered that he should have retained a larger number of bees than are necessary in ordinary circumstances; and though this was rectified a day or two afterwards by a fresh accession of bees, yet, as will be seen from what follows, that accession was too late to prevent the evil influences of chill and neglect. He writes to me with reference to this operation:—"I find on looking narrowly into the glass hive which I had driven this season there is a mass of foul brood in the centre comb. Now though a strong hive, it has not been attempted to clear it out."—J. Lowe.

(To be continued.)

BEE-KEEPING IN THE OLDEN STYLE.

It is now several months since I ventured into print in your impartial Journal, and felt proud of the honour of being thought worthy to be a contributor. I had a desire

to put on record my humble ideas on the subject of bee-keeping, and cannot say I was much surprised that my homely statements did not meet with approbation from scientific apiarists, who look down upon plain people having the old-fashioned notion that the use of bees is to gather honey. It is true that in our cottage straw hives they often work the combs rams'-horn fashion; but we care little to pull these about to see whether they are straight or crooked, so long as they are well filled with the needful in season. Notwithstanding the censures passed on me as an enemy to improvement by one correspondent, and the fears lest I should have no honey by another, I am happy to assure them both that they are wrong, for my harvest was good, and my prospects for the future are encouraging.

I must give my peace-loving wife credit for the gentle hints she threw out that I would get myself into trouble, for, said she, "Those experimental gentlemen are never particular about calling one another ugly names, and think one side of an argument is all that should be heard." "Moreover," she continued, "what if we should spend more money and time, and be rewarded by nothing better than a sight of those queer-looking microscopic tadpoles lately exhibited, I suppose as a warning, in THE JOURNAL OF HORTICULTURE?" Further, I was told to remember that the difference between two shillings and two guineas for a hive left a balance of two sovereigns—needful for new frocks and boots for the bairns at Christmas.

Really there seems to us plain folks to be a kind of connection between science, as intermeddling is called, and stinking combs, the more suspicious when, as we are informed in your pages, the great German model apiarist loses hundreds of hives by disease, and the contagion seems to be spreading in our own country amongst his followers. Let us hope it will not extend north of the Thames, where we are not indisposed to such inexpensive methods as conducive to the health of the bees, and increased store of honey to their owners.—AN OLD-FASHIONED BEE-KEEPER, *Finchley*.

YEW POISONOUS TO DEER.

We have had much correspondence lately on the question whether yew be injurious to cattle or not. I consider it my duty to state the following fact:—An old yew tree was blown down in my garden; misled by Nicoll's statement in his "Planter's Calendar," I had its branches thrown into my deer park immediately after being cut from the tree. The next day seven does were found dead.—N.

[We have now two unimpeachable witnesses that yew is poisonous to deer. We shall be greatly obliged by communications stating from actual observation the results to animals from browsing on this tree.]

CATTLE AMONGST YEW TREES.

IF your correspondent "P.," at page 491, has not had his views confirmed by others having experience in like manner to himself, I beg leave to say, that on the bare hilly districts of Kent, where herbage of all kinds is very scant, sheep and cattle, more especially the former, have unlimited access to the yew and juniper, which the chalky hill is often dotted over with, and they do not appear to take any harm, while there is evident token of both having been nibbled at.

On first being made acquainted with this, I confess feeling surprise, but the facts of the case led me to reflect on the different conditions the animals are sometimes placed in. Nature, ever kind and attentive to the wants of all her creatures, never sends a poison without its antidote, and it is quite possible the scanty picking the sheep and cattle obtain on these bare pastures, contains some antidote to the ill effects of the yew, or, which amounts to the same, the acquired taste the animals possess by living on such herbage, may induce them to reject any more of the yew than is useful to them; or, perhaps, the term instinct may be applied to their knowledge of discerning good and evil. Be this as it may, certainly cattle and sheep graze amongst yew trees without harm in such situations, while, on the other hand, I have known lamentable cases of poisoning, when cattle grazing on richer pastures accidentally found

their way to some yew trees in a cultivated condition. In the latter case the love of mischief, doubtless, induces them to eat more than they would do if they had access to it continually, and the consequent fatal result.

I am, however, not sorry to see the subject introduced to your pages, as the matter is far from being well understood, even amongst practical men; for I have heard it affirmed that the yew is only poisonous when its boughs have been partaken of after being cut and partly withered. This I hardly agree with, but I should like to hear all sides of the question, both as to the yew and rhododendron, the latter being as dangerous as the former.—A HILL-SIDE MAN.

WINSFORD POULTRY AND PIGEON SHOW.

THIS annual Show was held in the spacious Market Hall on Friday, the 18th ult., and some beautiful specimens of each class were exhibited in both poultry and Pigeons.

The following is the list of awards:—

- SPANISH.—First and Second, W. Woolley, Banbury, Cheshire. Third, R. Hulse, Over. Highly Commended, G. Dean, Over. Commended, J. Gibson, Over.
- COCHIN-CHINA.—First, G. Williamson, Nantwich. Second, J. Dodd, Minshall Vernon. Highly Commended, J. Sheen, Tilston.
- DOCKINGS (Grey).—Prize, W. R. Court, Newton Moor. Highly Commended, — Wallice, Newton.
- DOCKING (White).—Prize, — Platt, Darnhale.
- HAMBURGH (Gold or Silver-spangled).—First and Third, T. Dale, Middlewich. Second, J. Sheen, Tilston.
- HAMBURGH (Gold or Silver-pencilled).—Prize, T. Dale, Middlewich. Highly Commended, G. Williamson, Nantwich.
- POLAND.—First, T. Sproson, Middlewich. Second, — Platt, Darnhale.
- BANTAMS (Game).—Prize, — Groucott, Winsford.
- BANTAMS (Any variety).—Prize, T. Butler, Middlewich.
- BANTAM COCKS.—First, T. Butler, Middlewich. Second, W. Griffiths, Nantwich.
- GAME (Black-breasted Red).—Prize, A. Heath, Winsford. *Chickens*.—First, W. Hodgkinson. Second, J. Willet Nantwich. Third, J. Hodshead, jun. Fourth, — Platt, Darnhale. Highly Commended, Mrs. Ferrin, Oaklands, Wharborough.
- GAME (Any colour).—Prize, A. Heath, Winsford. *Chickens*.—Prize, J. Crimes.
- ANY VARIETY NOT BEFORE NAMED.—First, J. Foister, Hartford. Second, Mrs. Cook, Northwich.
- GAME COCK (Any colour).—First, G. Eavon, Marton. Second, C. Hope, Nantwich. Third, T. Johnson, Winsford. Commended, A. Phillips, Winsford; E. Warburton, Winsford.
- GAME COCKEREL (Any colour).—First, J. Willet, Nantwich. Second, — Platt, Darnhale. Third, J. L. mb, Winsford.
- COCKEREL (Any breed).—First, T. Groucott, Winsford. Second, — Platt, Darnhale.
- DUCK (Aylesbury).—Prize, — Platt, Darnhale.
- DUCKS (Any breed).—Prize, S. F. Hignett, Ouston.
- PIGEONS.
- CARRIERS.—First, Second, Third, and Highly Commended, W. Woolley, Bubbury.
- TUMBLERS (Any variety).—Prize, T. Barrett, Winsford.
- DRAGONS.—First and Second, W. Woolley, Banbury. Third, S. Astbury, Over. Fourth, J. W. Wilding, Nantwich.
- OWLS.—First, J. Hoole, Crewes. Second and Third, J. W. Wilding, Nantwich. Fourth, J. Withenshaw, Nantwich.
- TURBITS.—First, J. Hoole, Crewes. Second, J. Withenshaw, Nantwich.
- JACOBS.—Prize, W. B. Lea, Sproston.
- FANTAILS.—First, E. Burston, Over. Second, C. B. Davies, Eardswick Hill.
- BARBS.—Prize, J. Hoole, Crewes.
- ANY VARIETY.—First and Second, J. J. Sumner, Lea Green.

OUR LETTER BOX.

SUPERVISION OF POULTRY AT THE BIRMINGHAM SHOW.—Mr. J. Douglas informs us that Mr. Fowke never was steward and bailiff to the Hon. W. Vernon. The error is not ours; but it does not diminish the credit due to Mr. Fowke for the great care he had bestowed upon the poultry.

CHANGE OF COLOUR IN MOUTING (*Country Poultry-Fancier*).—It is not uncommon for a Spanish cock to turn partially white; nor need it cause much wonder, as the chickens are pied when hatched. We do not advise you to breed from him if you have another. If you have not, we think you run little risk in using him. We have had them throw many white feathers, and moult quite black again.

FATTENING POULTRY (*Subscriber in Connaught*).—If you wish to make your fowls very fat while young, it can only be done by slanting them up. The coop should be made entirely of bars, allowing merely room for the birds to stand up, none for exercise, but just enough to move from front to back. There is a drawing of such a coop in the new edition of Baily's "Book on Fowls," and full instruction for feeding. The best food is ground oats.

BANTAMS AT DARLINGTON (*A Constant Subscriber*).—We cannot undertake to say more than our reporter wrote, and we have published—"The Bantams were mostly." Of course, those which took the prizes may be considered the best.

JUDGING AT BIRMINGHAM (*J. Bates*).—We differ so much from the opinions you express, and considering that the decisions of the Judges were not only for the far greater part perfectly satisfactory at Birmingham, but that no set of Judges should be thus assailed, we must decline publishing your communication.

WEEKLY CALENDAR.

Day of M th Week.	Day of Week.	JANUARY 12-18, 1864.	Average Temperature near London.			Rain in last 37 years.	Sun Lies.	Sun Sets.	Moon Lies.	Moon Sets.	Moon's Age.	Clock before Sun.	Day of Year.
			Day.	Night.	Mean.	Days.	m. h.	m. h.	m. h.	m. h.	m. s.		
12	Tu	Blackbird sings.	42.3	30.6	36.5	15	5 af 8	12 af 4	23 9	4 9	3	8 27	12
13	W	Mezereon flowers.	42.6	32.0	37.3	17	4 8	14 4	48 9	24 10	4	8 50	13
14	Th	Purze flowers.	42.0	32.2	37.1	16	3 8	15 4	12 10	42 11	5	9 12	14
15	F	Crocus flowers.	41.4	29.0	35.1	12	2 8	17 4	37 10	inorn.	7	9 34	15
16	S	Thames frozen, 1814.	41.7	30.6	36.2	19	1 8	18 4	4 11	53 0	7	9 55	16
17	SUN	2 SUNDAY AFTER EPIPHANY.	42.4	30.4	36.4	12	1 8	20 4	35 11	9 2	8	10 16	17
18	M	Hedge Accentor sings.	41.1	31.1	36.1	15	0 8	21 4	after.	14 3	9	10 35	18

From observations taken near London during the last thirty-seven years, the average day temperature of the week is 41.9°, and its night temperature 30.8°. The greatest heat was 56°, on the 14th, 1849; and 15th, 1834 and 1852; and the lowest cold, 4°, on the 14th, 1833. The greatest fall of rain was 0.80 inch.

ROYAL HORTICULTURAL SOCIETY.

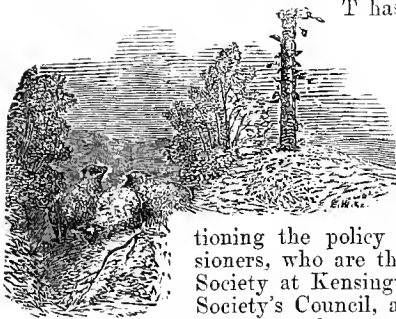

It has been announced that Mr. Henry Cole has been chosen on the Council of the Royal Horticultural Society in the room of Earl Ducie, resigned.

Without questioning the policy of Royal Commissioners, who are the landlords of the Society at Kensington, sitting on the Society's Council, and taking part in discussions that must arise between the interests of the Commissioners and those of the Society, we are of opinion that there has been some irregularity in the appointment of Mr. Cole. It is expressly stated in the Charter that in the event of *death* or *incapacity* of any of the office-bearers "the Council shall and may nominate or appoint some other discreet person or persons, being a Fellow or Fellows of the Society, to supply the place or places of the member or members of Council, &c., until the annual meeting next following such nomination or appointment." But in the case of *resignations* there is a special clause to the effect that they are to be accepted and filled by the annual meeting of the Fellows, and not by the Council: "And it is Our will and pleasure that any such annual meeting as aforesaid may accept the resignation of, or for incapacity remove, any one or more of the members of the Council for the time being, and elect in manner aforesaid any person or persons from among the Fellows in the place or places of the members so retiring or being removed, in addition to the member or members which the Fellows present at such meeting are hereinbefore authorised to elect." So it is quite plain that, although Lord Ducie may have given notice of his resignation to the Council, the Council had no power to accept it, and his lordship was bound to remain (nominally at least), on the Council till the annual meeting in February, when the Fellows might or might not accept his resignation. There is not a doubt, therefore, that Mr. Cole has not been legally appointed. It is well known that Mr. Veitch sent in his resignation last July: Mr. Veitch has very properly remained on the Council, and doubtless will remain, till the annual meeting, when his resignation will be submitted to the meeting, and another will be elected in his stead if it should be accepted. So that, in addition to the three members who go out by rotation at the next general meeting on the 9th of February, there will be these two resignations to fill up.

STRAWBERRIES EVERY MONTH.

That the first dish of forced Strawberries is hailed with delight by the aristocracy no one can deny; and the gardener who can produce a dish of this luscious

fruit before his neighbours (means, &c., being equal), is looked upon as one that has accomplished a great feat. Friendly rivalry has caused efforts to be made to go beyond what we have already attained.

The forcing of Asparagus, Sea-kale, Mushrooms, Rhubarb, Salads, &c., is carried on extensively in many gardens from September to April; indeed, in the absence of such forced supplies the chief of the kitchen would give dark looks to the purveyor of vegetables. New Potatoes are perhaps the least cared for in the autumn months. I remember my late friend and neighbour, Mr. Beaton, speaking about sending some young Potatoes to his employer's table at Shrubland in the autumn, when Sir William Middleton remarked that they were excellent late Potatoes. Mr. Beaton drily replied that he would be more early in future with his Potatoes by keeping them until New Year's-day.

Now, I would venture to say that no one would despise a dish of Strawberries in the autumn be they "ever so late;" and I think that this fruit has not had the attention bestowed upon it which it deserves. How many there are that have been confined to a sick-room, who have been revived at the sight of even a few Strawberries sent to them by some kind friend. If only for the above purpose, then, it behoves us to have this delicious fruit in readiness at any time of the year.

Strawberries may be had with tolerable ease from March until August; but to secure them from September and onward through the winter has, I think, as yet been but little thought of. In order, then, to have Strawberries in the autumn and winter months we must fall back upon a very much neglected variety—the Alpine. If plants of this kind are potted in March, April, May, and June, if the usual attention is given them which the large kinds receive when in pots, they will amply reward us with both pretty fruit and flowers. Pots well filled with roots, a light situation near the glass, plenty of air, and a temperature ranging between 50° and 70°, are the chief requirements in order to have Alpines in fruit in winter.

I have long thought that the Black Prince (Cuthill's), would conform to our wishes by fruiting more in winter if runners could be secured sufficiently early for potting. For instance: If runners are taken from plants that are being forced in March, they will make nice plants for forcing in the following autumn if the usual attention is given them which Strawberry plants receive in the summer months in pots. Some runners were potted here rather early during the past season, and they are now in full bloom; indeed, fruit has been picked from some of them already. All honour to the raiser of this most useful kind, which is with us very early, the best cropper, fine in colour, and many housekeepers can testify as to its good properties for preserving purposes. The leaves, too, of this variety are better than all the others for packing Strawberries, being very soft and of a suitable size.

Small pots of the Alpine Strawberry when well grown are pretty objects for the breakfast-table; the ripe and green

fruit intermixed with the flowers, which stand well up above the foliage, offer a natural and very graceful appearance. A few pots of this kind in fruit placed amongst flowering plants in the conservatory will give a spring-like perfume, and add much to the enjoyment of visitors to that structure. The kind grown here was kindly sent some years ago to my employer by the Duchess of St. Alban's, and is much prized both as a good cropper and interesting variety.—J. PEKINS, *Thornham, Suffolk.*

THE DESIRABLE VARIETIES OF GRAPES.

As a supplement to what has recently been advanced on the question of Grape-growing in answer to several correspondents, I have thought that a few remarks regarding the most desirable varieties of Grapes for planting might be useful and interesting to the inexperienced who may be about to plant Vines in this coming spring. In doing as is proposed I have no intention of attempting to mystify my readers with a long array of names, nor to deal with Grapes of questionable merit, but I will confine myself to those only which may safely come within the province of the amateur and others who may be owners of one or at most two Vines.

Of late years there has been such an unprecedented amount of interest manifested in the different varieties of Grapes, and such a scrutinising and sifting of them, as has never been the case in the memory of the present generation of gardeners, and many new varieties have been raised from seed and otherwise introduced, giving rise to an amount of criticism and controversy which neither the raisers nor anybody else could have possibly looked forward to. The undeserving and worthless varieties will soon be consigned to that position which they deserve, and nothing that has been said in their favour can save them from a true verdict. The good varieties, on the other hand, will creep into extensive growth without any exaggerated recommendations. As an instance of the rapidity with which a Grape of desirable qualities comes into extensive cultivation, the Lady Downes' is a very striking one. Till about six years ago it was a Grape comparatively little known, and in that short time it has worked its way and holds its place in almost every collection, however limited.

In what are known as the old varieties, a first place among Blacks must be assigned to the Black Hamburg. Taking it altogether, and as an everybody's Grape, there is nothing yet that can approach, far less supersede it, more particularly as an amateur's Grape. It is of vigorous growth, a free fruiter, and the most free of all in setting, and is large in both bunch and berry. When presented at table it is very handsome, fine in flavour, and more palatable to some epicures than even the Muscat, on account of its being more juicy and vinous. For a supply the whole year round, if put in competition against any one variety, it is probably the best. It can be forced to produce ripe fruit in January, and late crops of it will hang till far on in February. It is, moreover, a Grape which can be ripened in England in the orchard-house without fire heat, and it will bear the heat of the tropics. As a Vine for fruiting in pots it is not surpassed, if equalled. All these points considered, the amateur should always plant half his vinery or greenhouse vinery with the good old Hamburg. There are several forms of it, all are good. We have found the Champion Hamburg inferior in flavour, though very showy. The Mill Hill variety is undoubtedly the best keeper after being ripe, and, though not so large in bunch, makes very large berries.

Doubtless a few of the more recently-introduced varieties of Black Grapes are worthy of cultivation, but it is no disparagement to their character to say that in point of general usefulness they rank only second to the Black Hamburg. The Muscat Hamburg is unquestionably a Grape of superior flavour, and when so well grown as it has been at Castle Kennedy and Dalkeith Park, it is a very showy Grape. But whatever position it may yet take, the uncertainty that has hitherto attached to it has not been sufficiently dispelled to make it of such importance to gardeners or amateurs with one or two vinerias as to warrant their planting more than one Vine of it. Barbarossa has nothing but size to recommend it. Certainly it hangs well, but in this latter quality it is surpassed by Lady Downes', which is larger in

berry, more certain in colouring, and superior in flavour; and berry and flavour in a Grape give a worth to it which no other qualities, without these two, can make up for. Lady Downes' is a vigorous grower, and ranks amongst the most free fruiters. It is not so free a setter as the Hamburgs, but sufficiently safe in this respect, with ordinary care, to make sure of a crop. In bunch and berry it is all that could be wished in both size and appearance, and it is one of the best, if not the very best, of all known Grapes for keeping after it is ripe: therefore, wherever a long season of Grapes is required from one or two vinerias, Lady Downes' should be planted. But wherever Grapes are not wished for any later than the end of the year, or even on through January, there is no Black Grape without Muscat flavour that can up to that time touch the Black Hamburg for flavour, although there is less difficulty in keeping Lady Downes' with the least possible loss from damp than is attached to the Hamburg. A great desideratum among Grapes is a late-keeping variety with a flavour superior to any of the late Blacks yet in cultivation. We have almost every other point that could be desired—such as size of bunch and berry; but both the Barbarossa and Lady Downes' are coarse as compared with what could be desired after finishing the different varieties of Hamburgs. The same objection applies to the Alicante, and the extra heat which it requires does not bring it within the range of the amateur with one cool vinery.

The Black Hamburg is what we recommend to be the most extensively planted by those for whom these remarks are intended. And where a long succession is required from the same house, a Vine or two of Lady Downes' we consider the most desirable of the late Blacks.

Turning to White Grapes, and looking among those which are suitable for a cool vinery, there is the old Chasselas Musqué, a very fruitful and early Grape of the most exquisite flavour, which forces well, and ripens before the Black Hamburg. It has, however, one drawback—namely, its tendency to crack just as it takes its ripening swelling. This, however, can be overcome by having the roots confined to the inside of the house, and keeping the border dry. This fault can also be counteracted by cutting the stalk of the bunch half through when it begins to take the last swelling. This is just one of those Grapes which make one halt between recommending and not recommending a Vine to be planted. In a cool vinery there is no White Grape that can be ripened with anything like so good a flavour; but, on the other hand, the tendency to crack when its roots are in an outside border and not under control is against it. The safest course will probably be to say to those who can have it with its roots inside, Plant a Vine of it, it is so well worthy of a trial. The Early Saumur Muscat I believe to be an excellent White Grape for a cool house, although I cannot speak from experience. Mr. Hill, of Keele Hall, who is no doubtful authority, recommends it as a good early Grape, and for planting in outside borders it may take the place of Chasselas Musqué. Buckland Sweetwater is a new variety of sterling merit for cool vinerias. It is large in bunch and berry, moderate in flavour, but fully better than the old Sweetwater. Royal Muscadine is a Grape that we are very partial to for cool work. It is a remarkably free fruiter, moderate in bunch and berry, and hangs better than any of the Sweetwaters after being ripe; and when just at the shrivelling point is very rich in flavour. In ordinary cases, the Early Saumur Muscat, Buckland Sweetwater, and Royal Muscadine are the best for cool houses; and where the Chasselas Musqué can have its roots under control it should not be omitted.

For a late White there is no Grape likely to succeed so well as Calabrian Raisin. It ripens well with Black Hamburgs and Lady Downes', is a very free fruiter, very large in bunch, and medium in berry. In flavour it is equal, if not superior, to Trebbiano, which latter requires Muscat heat to ripen it. One Vine of Calabrian Raisin should be planted to match Lady Downes' as a White for late-hanging. We understand there is something very fine in the hands of one of the large London firms, as a White Lady Downes' in point of hanging, but much larger in berry, and better in flavour, of a golden colour, and that will ripen in a cool house. Then there is the splendid Muscat Champion, which was raised by Mr. Melville, Dalmeny Park, which, it is to be hoped, will ripen at any rate in the

warmest corner of the cool vinery; and from its parentage there is every reason to think that it will so ripen. The Canon Hall, one of its parents, does well in Hamburg temperature with its roots inside; and the other parent being Champion Hamburg, there is nothing in its parentage that could hinder it from ripening along with Hamburgs. In flavour, bunch, and berry it is a noble Grape, and any little dinginess attaching to its colour may well be passed over with such good qualities to make up for it. Among the other new ones also raised north of the Tweed, there is the Duchess of Buccleuch, a cross between Muscat of Alexandria and Chasselas Musqué. What good qualities would be too much to hope for from such a parentage, both of Muscat flavour? This is a variety which fruits with wonderful freedom, always showing three bunches, and sometimes four to a shoot, a free setter, never cracks, and is of the richest Muscat flavour. It took the prize offered specially for flavour at the great Kelso Show against all comers, Muscat and Chasselas Musqué included. It ripens from a month to six weeks earlier than the Muscat, and it is to be hoped it will do well in a cool house. This will be proved, no doubt, before it is let out. It is to be hoped that Scotland will have reason to be proud of these two coming Grapes.

To enumerate the Vines that are most suitable for cool vineries, and that are at present available, we would recommend where there is room for twelve Vines—six Black Hamburgs, two Lady Downes', one Calabrian Raisin, one Buckland Sweetwater, one Royal Muscadine, one Early Saumur Muscat. With the exception of Lady Downes', these are all adapted for early forcing where such is desired.

While speaking of early forcing, it may prove interesting and encouraging to relate what has been done by an amateur close by here in the way of early-forced Grapes. A few years ago he put up a small place with the view of growing Melons, and succeeding so well with them, he swelled his little place into a good-sized vinery, made a very ordinary border, and heated the inside part of it by a flue, which he carried through from the boiler under the path, and from the flue ran drains under the border, which gave a good supply of bottom heat. The atmosphere was heated by hot water. The Vines he planted were Black Hamburgs principally, and a few Chasselas Musqué. Since 1858 I had the pleasure of frequently looking in upon these Vines, and in 1859 the crop was ripe early in April. In 1860 they were fit for sale in February, and realised high prices, and, I believe, graced the tables of the Tuileries and Buckingham Palace. The next crop was ripened in December of the same year, 1860, and another crop was quite ripe in October, 1861. Now this was not effected by any premature breaking of the Vines, but was accomplished on the ordinary system, and with the regular routine of pruning and forcing. The last crop referred to was the best of the four. The house was 36 feet long, with 15 feet of a rafter. In this space there were 380 bunches, some of which, as near as I could judge, would weigh about 2 lbs., and, taking the average, they would weigh 1 lb. each, some more and some less. This was accomplished by an amateur who never had the care of Vines before, and these he planted, pruned, thinned, and fired with his own hands. Such an example of success may be considered an encouragement to beginners to persevere, and proves that by close attention and observation much can be accomplished in the way of Grape-growing by any one who can afford the time.

In the case of those who may have a warm as well as a cool vinery, it may be safely affirmed that, taking all points into consideration, there is no White Grape equal to the Muscat of Alexandria; and after growing a good many of its varieties in the same house, I unhesitatingly recommend those varieties known as the Bowood and Tynninghame Muscats as the most desirable. These two set much better than the old Muscat, and are larger in berry, and quite equal to it in flavour. True, some affirm that these three are identical. Here, however, the Tynninghame Muscat from the Tynninghame stock, and the Bowood from the Bowood stock, are not only quite distinct from each other, but also quite distinct from the old Muscat when grown in the same house and soil. So distinct are the two sorts from the old Muscat, that any one on entering the house can pick them out. The Tynninghame and Bowood Muscats are

very much alike when ripe; but in some of their stages they are very distinct, and all who have watched them here side by side are well aware of this. This, however, does not matter much. They are both excellent, and far less precarious in the hands of beginners than the old Muscat, which variety has been largely sold for Bowood Muscat at least, and hence the reason why some say that the two are not distinct. Every berry of the Bowood and Tynninghame sets like a Hamburg. In a moderate temperature they make compact bunches and very large berries, and seldom fail to colour exceedingly well; and, therefore, as a White Grape for a hot vinery, these two Muscats we consider the most desirable.

For Blacks there are Burchardt's Prince and Alicante, both excellent Grapes for hanging to match the Muscats for a Black dish. Where a large bunch is esteemed, a Vine of Barbarossa might be planted. Trebbiano has been omitted among the Whites because it is not now presumed that Grapes are required to hang after February, and till then no Grape has a chance with Muscats; and if size of bunch should be a fancy with some, why then plant the Syrian at once. It is a monstrous buncher, and when well ripened superior to Trebbiano in flavour; but it requires extraordinary heat to ripen and colour it, and without this its flavour is not good. For late Grapes requiring heat, a good arrangement is to plant six Muscats, two Burchardt's Prince, two Alicantes, and presuming that a fancy exists for large bunches, one Syrian, and one Barbarossa.

D. THOMSON.

CULTIVATION OF FERNS.

CONSTRUCTION OF A HARDY FERNERY.

(Continued from page 12.)

THE arrangement of a fernery differs from that of a flower garden, inasmuch as in the latter order and neatness ought to prevail, and the outline of beds and borders should be clearly marked and defined. In a fernery, however, we naturally look for a certain amount of irregularity and a pleasant air of negligence, combined with a tasteful disposition of the parts. Looking at Ferns generally, we find that some are admired for the symmetry of the fronds taken individually, others for the elegance of the plants themselves, others again for the dense masses of foliage they exhibit when growing thickly together, while not a few unite these points of attraction. For instance: the Lady Fern (*Athyrium Filix-femina*) makes a splendid mass when grown thickly, and a most elegant plant when young, while each frond is in itself a most graceful object. *Polystichum angulare*, *lobatum*, and *aculeatum* are beautiful both in the frond and in the plant, although they do not mass well; probably this is the character of by far the larger portion of hardy Ferns, and this circumstance should have its full weight in determining their arrangement, those which are adapted for the purpose being permitted to run together into compact masses, the rest being only allowed sufficient room to be distinctly observed.

Although in arrangement a fernery differs widely in many points from a flower garden, still I do not think that a fernery need be, or, indeed, ought to be, devoid of flowering plants. Where Ferns grow naturally on shady banks, &c., we find many wild flowers growing with them, so that when cultivated in the garden it adds to instead of detracting from the character of a fernery to intermix various herbaceous, trailing, or alpine plants and hardy bulbs, especially such as flower early in the spring before the Ferns send up their new fronds; and as this does not generally take place before May, some bright masses of Snowdrops, Scillas, Anemones, &c., enliven the appearance of a fernery in the spring, and I have had these doing remarkably well in a fernery.

In constructing a fernery the chief point is, I believe, to give it sufficient area. In most instances where I have known Ferns fail to do well it has been found that the ferneries have been cramped into very limited spaces. The endeavour being to compensate in height what was wanted in breadth, stones and burrs are built up nearly and sometimes quite perpendicular, the smallest possible niches being left here and there into which the Ferns are squeezed, and in which they starve and die. However this rustic fancy work

may answer to the designation of rockery or grotto work it will never be a fernery, since it seldom happens that any Ferns thrive there. What is mainly wanted is length and breadth, height I consider of but secondary importance. Certainly various pieces of rustic workmanship may sometimes be advantageously introduced—as the imitation of a ruined tower, mountain peak, or rustic arches, projecting or lofty cliffs, supposing any such imitations may be introduced without being at variance with good taste. These may be connected with but cannot form part of a fernery. The same may be said of an out-door aquarium, which, in my opinion, forms a most useful adjunct to a fernery, and would be in keeping with it. Such adjuncts, however, may be dispensed with, and the fernery may consist of a number of beds at various elevations—some may be sunk below the ground level, although it would be better to have the greater part above it; but much will depend on the nature of the soil and situation. In many cases where the soil is light and the situation is exposed, it would be as well, both for the sake of moisture and shelter, to have the Fern-beds below or on the ground level. If it is desired to have rocks and ruins of any considerable height, and these are covered with Ivy, they will form a very effective background, or become a good addition; but they should not be attempted unless sufficient space is given. However interesting any such fancy work may appear when crowded into an out-of-the-way corner, which may be considered useless for anything better, it is worth while to remember that it will not stand the test of good judgment. Let it be observed that a small fernery may be constructed in any shady corner where flowering plants would not succeed. If neatly done it may be in every way consistent with good taste and judgment. What I should object to is to endeavour to crowd imitations of ruins or natural scenery into insufficient spaces; and as few suburban gardens can command a suitable site or position for such, it would be as well to confine an artificial rockery or fernery to its true character, which may be apparent and yet be in keeping with good gardening, and, more than that, with good taste.

Merely constructing a rockery or rootery in which to grow Ferns is a very simple matter, especially where the space is very limited. A mass of good loamy soil to which a goodly proportion of peat or leaf mould has been added is put into the desired form; the stones, roots, or burrs are firmly bedded into it in such positions as the taste or skill of the designer may dictate, leaving proper spaces in which to plant the Ferns, not the small niches formed by two or three stones or blocks of wood meeting at angles with each other, but good open spaces in which the Ferns will find room to develop themselves. In arranging the Ferns it is generally advisable to plant those which make large compact masses in the most elevated and exposed parts, the smaller-growing sorts in the most sheltered spot, and such as *Osmunda regalis*, *Onoclea sensibilis*, and *Struthiopteris germanica* in the dampest position. This last should have the collar standing up considerably above the soil. In other respects I consider that the operator ought to draw upon his own judgment; for I do not think that any rules can be laid down for the work, so much depending upon the aspect or whatever may be in connection with it, let it be buildings or trees. Those who undertake work of this description and do not take into account such matters are entirely unfitted for its execution. If a pool of water is contiguous to the spot it may be advantageously worked in with the rest, and may be used to grow hardy aquatic plants, or marsh plants may be planted round it, and if well managed it will make a great addition to the place. Where a small rill of water can be taken advantage of, in addition to the pool, it will afford facilities for making a musical waterfall or fountain on which the taste of the owner may be exercised. I have known instances in which this taste has exhibited itself in causing a stream of water to gush out of a shell over stones, flints, burrs, or broken pieces of sculpture placed promiscuously together, showing, in my opinion, a want of anything like sound judgment in arranging such an adjunct to a fernery.

Where it is designed to make a fernery on a larger scale, the situation and its surroundings being suitable, the first thing is to form a plan; if a model so much the better, since it is of as much importance to know the various eleva-

tions as it is to understand the ground plan. Having well combed the matter over, procure sufficient soil of a good loamy nature, and if to this were added a third of peat or leaf mould it would be better; but if either of these should be scarce, a small quantity may be mixed with the surface where it will come into immediate contact with the roots of the Ferns, or, at least, of such of them as do better in a mixture of the above materials than without it. I make this observation because I have often planted some sorts in nothing but a stiff loamy soil, and they have grown vigorously; and as I have had them growing equally well in light soil, I consider that soil is only a secondary consideration with most of the stronger-growing Ferns. The next proceeding should be to procure a quantity of stones, burrs, or scoria, the refuse from the iron and glass works. In my opinion nothing comes in better than rough gnarled roots and blocks of ancient trees. I have myself used rough logs of willow, and found that moss grows freely on them, besides a peculiar sort of fungus of a tough leathery nature, something of the form of various kinds of seaweed, and which, in my opinion, is far from unsightly. Whatever material is used the plan of operation must in some measure be influenced by it; where sandstone or any kind of stratified rock is used, it should be arranged in the manner in which it is found in a natural state; while if burrs or scoria become the material they have to be formed into irregular masses after the manner of unstratified rocks. Roots and logs may be laid more formally together, for the only instance in which a natural accumulation of these can be conceived is where they have been washed together by the stream or flood, and it will scarcely be advisable to attempt to form a counterpart of what appearance they might present. I have seen more than one fernery in which roots and logs have been freely used, and the Ferns have thriven admirably, but the area has been extensive and planted rather largely with American shrubs and coniferous trees. Some of these grew most admirably, particularly several *Deodars*, which seemed to like their elevated site. In such a spot any one might spend hours most agreeably, admiring at intervals large patches of *Ceterach officinarum*, *Allosorus crispus*, *Polypodium dryopteris*, or *plegopteris*, or a fine plant of the *Regal Fern*—among a group of wild plants, as *Woodroof*, *Enchanter's Nightshade*, or *Fumitory*—here a collection of *Saxifrages*, there masses of such dwarf plants as *Campanula punilla*, *blue Arabis*, or scarlet and yellow *Helianthus*; and it would be but necessary to lift the eyes to see and admire the fine specimens of *Conifers*, masses of *Rhododendrons*, &c.

The arrangement or planting of a fernery must be a matter of judgment, and beyond taking a few useful hints the operator had better depend upon his own good sense rather than be guided by others. As a matter of course, where American shrubs and plants, such as *Rhododendrons*, *Azaleas*, *Ledums*, *Heaths*, *Kalmias*, &c., are used, it will be necessary to plant them in peat. Coniferous and other trees will require good sound loam. Ferns generally do well in loam, but most of them do better if they have a little peat or leaf mould; and many of those of very dwarf habit are improved by having a little broken sandstone incorporated with the above. Most kinds may be planted level with the collar or crown of the plant. Some few may be planted so that the collar stands a little above the soil, but not so much as to prevent them throwing out new roots, which they mostly do from the crown, while deep planting should be avoided. Elevating them above the soil applies chiefly to Ferns which are planted in moist places, as the *Royal Fern*, the *Crested Fern*, and the *Ostrich Fern*. Some recommend planting smaller sorts, as *Asplenium fontanum*, *A. trichomanes*, *A. viridis*, and others that ought to grow in rather dry situations in like manner; but I think it advisable to make a little mound of soil for each, as that would keep them up, and at the same time induce them to throw out fresh roots, which some sorts are very tardy in doing.

It is only in favourable situations that some of the so-called hardy Ferns can be made to do well unless some kind of shelter is afforded them. The best way of doing this is to cover with bell-glasses from October till May. *Adiantum capillus-Veneris*, *Asplenium fontanum*, *A. ruta-muraria*, *Allosorus crispus*, *Asplenium marinum*, *Cystopteris fragilis*, *C. montana*, and a few others, ought to be so protected during the winter.

The best time for making and planting a fernery is in September, as then the Ferns are likely to root into the soil and prepare to start freely in the following season. If they make roots the same season and no fronds they will grow strong, but if they make fronds as well they become weakened; so that it is as well not to plant till towards the end of the month. Where any of the strong-growing kinds can be planted in large masses planting may be done at any period of the year, taking care to water freely if the weather prove dry. With regard to watering, I consider it a matter of the first importance to a fernery; for to maintain that fresh and verdant appearance which Ferns ought to exhibit it is necessary to have a copious supply of water, which can be abundantly applied in dry weather. If a cistern were elevated to a considerable height, and the water conducted to different parts of the fernery through pipes, so that a strong jet could be used when and where it is desired, the operation of watering would be both easy and agreeable. The next best plan is, I consider, to have a good garden engine. If watering is done with watering-pots the labour will be considerable; for it should be known that Ferns make a great deal of roots, and absorb moisture very freely and rapidly; and if the supply is not maintained, the effect is seen, first in the drooping of the foliage, then in the spotted rusted appearance they acquire, and also in the abundance of thrips that attack them. But in applying water overhead it often happens, from the nature of the soil or the sloping position, that sufficient moisture does not reach the roots, so that the plants derive no real benefit from it. To remedy this it is a good plan to sink ten-inch pots into the soil in convenient places; these pots, being inverted and filled occasionally with water, will keep the roots moist as they ought to be.—F. CHITTY.

ROSE CATALOGUES FOR 1863-64.

There are few things that more strikingly illustrate the progress of floriculture and the taste for its pursuit than the elaborate and well-got-up catalogues annually issued by the great nursery firms. Many of them are not merely trade lists, but display a great amount of scientific arrangement and knowledge and a considerable degree of literary merit, leaving little information to be desired upon the specific subjects on which they treat.

In this paper, however, I purpose merely to notice those relating to the Rose, and to point out such of them as in my humble opinion present the most distinctive features of interest and information. I shall take them in the order they came to hand, beginning with the catalogue of Messrs. Wood & Son, Maresfield, which is usually the pioneer of Rose-information for the season, being published in September, and immediately distributed to customers and others. One important feature in this list is that the number of the nursery tally is prefixed to the description of each variety. Others are that the best kinds for exhibition or for pillars are indicated; and this season the Messrs. Wood have added, for the use of amateurs, the letter T to such as are best suited for cultivation in the neighbourhood of towns. It may here be remarked that to all the catalogues noticed there are valuable introductory observations, and cultural directions affixed to every section.

As might be expected from so accomplished a proficient in Rose lore, Mr. W. Paul's catalogue is a valuable and interesting work. He has adopted an improved system of classification by the introduction of a section characterised as Bourbon Perpetuals, and another for the kinds partaking of the characteristics of Gloire de Rosemène. The collection is extensive and rich in the best old varieties as well as the latest introductions, including Mr. W. Paul's own seedlings, which are likely to take a high place among the favourites of the day. Here also are found pointed out those sorts most suitable for specimens, pillars, pot-cultivation, and for growing in town localities.

Mr. J. Cranston has a most excellent catalogue, printed in a fine type. The Hybrid Perpetuals are divided into two sections according to merit, as also are the Bourbons. The collection is very numerous, the descriptions copious and accurate, leaving nothing to be desired on that point; and the names of the raisers are specified, in which it is

alone, and recent introductions are marked as not proved where they have not been grown and bloomed under Mr. Cranston's own observation. The kinds, however, adapted for suburban cultivation are not indicated, which is a pity. Mr. Cranston's list of such in his own capital little work on Rose-culture not being brought up to the knowledge of the day.

Messrs. Fraser's (Lea Bridge Road), list of Roses is included in the general catalogue, though of sufficient extent and importance to form of itself a separate list. This arrangement, however, affords amateurs an opportunity of becoming acquainted with other objects of interest as well as with the Rose. For instance: There is a choice collection of Phloxes, with a new introductory article upon their cultivation, and a list of orchard-house trees, besides copious selections of the best subjects for garden, stove, and greenhouse decoration. The Messrs. Fraser have improved their Rose list this year by indicating certain beautiful kinds likely to succeed in the vicinity of towns. The selection consists only of the best, and space is so valuable near the metropolis that only the most choice varieties are grown in these grounds. Such, however, are cultivated in large numbers; and from the fine soil, joined with every appliance that skill and enterprise can command, none but superior plants are sent out.

Few other improvements, perhaps, could be suggested upon the various features displayed in these catalogues, unless an accomplished rosarian like Mr. William Paul or Mr. Rivers were to divide the list of varieties really worth cultivating into sections, placing at the head of each the parent or type of the group, furnishing by that means a key to peculiarities and characteristics which would indicate adaptability to special circumstances and conditions. It would require, however, an M.A. in Rose-learning to do this. Few amateurs could command sufficiently remote experience or a wide-enough field for observation to execute the task exhaustively.

With the assistance given by these valuable works, what amateur with a few yards of garden at his disposal ought to be deterred from becoming a rosarian? There is a further encouragement for all who desire to become cultivators or to replenish their stocks—viz., that a considerable reduction in the prices of most kinds has taken place this season.—W. D. PRIOR, *Homerton*.

THE SEASON IN DEVONSHIRE.

The following were in blossom in the open ground of my garden at Marychurch, Devon, on New Year's day, 1864:—

Laurestinus	Valeriana rubra
Salvia Grahami	Oxalis floribunda
fulgens	Tussilago fragrans
Violet	Guzana splendens
Reseda luteola	Jasminum nudiflorum
odorata	Acanthus mollis
Lobelia erinus	Alyssum saxatile
Primrose, yellow	white
double lilac	Verbena Defiance
hose-in-hose	Aubrietia deltoidea
Polyanthus	Escalonia macrantha
Gentiana acaulis	Hepatica (double pink)
Pentstemon	Pumpas Grass
Coronilla emerus	Statice macrocephala
Helleborus viridis	Spirea Elpenaule
Fuchsia coralina	Papaver bracteatum
elegans	Oenothera longifolia
another variety	Lamarckiana
Rose Gloire de Dijon	Snowdrop (in bud)
Géant des Batailles	Veronica Andersoni
other varieties	Anchusa italica
Campanula rotundifolia (?)	Berberis Darwinii
pyramidalis	Soeck, double Intermediate
persicifolia	Corchorus japonicus
Vinca major	Linaria cymbalaria
Wallflowers (several varieties)	Hydrangea foliis variegatis
Scarlet Geraniums (many)	Godetia subnuda
Double Daisy	Corydalis lutea
Sedum cœruleum	Iberis (purple)
Chrysanthemum, Pompones (several varieties)	Strawberry May Queen
Potentilla (sp. yellow)	Carolina (?)
	Black Prince.

—P. H. GOSSE.

ROYAL HORTICULTURAL SOCIETY'S EXHIBITIONS IN 1864.
—It is proposed to have a *Hyacinth* Show on the 9th of March; a *Camellia* Show on the 30th of March; an *Azalea*

and *Early Rose Show* on the 20th of April; the first *Great Show* on the 1st and 2nd of June; a *Great Rose Show* on the 29th and 30th of June; a second *Great Show* on the 6th and 7th of July; a *Strawberry fête* on the 13th of July; an *International Fruit and Vegetable Show* during the third week of October. The following extra prizes are also offered:—By the Duke of Buccleuch, the President, a prize of £25 for the best collection of twelve fine-foliaged and flowering plants in equal proportions, the Council giving £15 among the unsuccessful competitors. By Mr. Bateman, a gold challenge medal, or, at the option of the winner, its value, £20, in money, for the largest number of marks obtained for Orchids during two consecutive years at the Floral Committee meetings. By Lady Dorothy Nevill, £10 for Sarracenias and other Pitcher-plants. By Sir C. Wentworth Dilke, three prizes for dinner-table decorations, consisting of natural flowers, fruit, and foliage. By J. J. Blandy, Esq., a prize of £10 for Strawberries. By W. Wilson Saunders, Esq., £13 for Tea-scented and Noisette Roses, and for hanging-baskets. By J. W. Kelk, Esq., £5 for an Azalea, and £5 for a Rose, grown in a small-enough pot for dinner-table decoration. By the Society, one silver and two bronze medals for the three best collections of wild plants from each separate county in the United Kingdom. Also three gold medals for the three best collections of the separate county collections; and further, a gold medal to every exhibitor of a new species of plant growing wild in the United Kingdom. An exhibition of ancient and modern bouquet-holders is to take place on July 13th, at which the Society will award a gold, a silver, and a bronze medal for the most effective and artistic bouquet-holder made since June 1861. For the various conditions under which the above prizes are to be competed for, we must refer intending exhibitors to the Society's schedule. A show of Messrs. Waterer and Godfrey's gorgeous American plants will commence on a day hereafter to be fixed, in the end of May or in June; and it is to be hoped that it will be more securely protected from weather than the last.

HARDINESS OF GREENHOUSE PLANTS.

HEDYCHIMUM GARDNERIANUM—VERONICA SPECIOSA.

It may not be uninteresting to note, that two plants of the *Hedychium Gardnerianum*, each of which stood out the whole of last winter in this cold damp situation without any shelter, made during the last summer some strong and vigorous growths, and continued to grow the whole of the summer, pushing up fresh shoots in succession, and giving ample proof that no injury had befallen them. They were, however, cut down to the ground by the first frost of last autumn; but the roots, or crowns, are perfectly firm and sound. We shall, therefore, give them a similar trial during the present winter to see if they will stand a still more severe frost.

The test of the past summer shows how much better these plants, even when at rest, are able to withstand cold and damp combined, than cold alone. The *Hedychium* should at all times when in its season of activity be treated as a semi-aquatic, though even thus it is only with excessive heat that you can obtain from it massive garlands of flowers. It flowers moderately, however, upon the latest shoots of a summer's growth, when kept fully exposed to the sun, with abundance of air, and the roots cramped for want of space. At times, also, the lateral shoots of a season's growth will flower if the plant be turned out in a sunny situation in a conservatory, though both growth and flower in this case also give a very faint idea of the real size and beauty these flowers attain.

Veronica speciosa is a plant which is now generally discarded, at least so far as our greenhouses are concerned. It does exceedingly well when planted out of doors against a wall in a sheltered situation, with occasional protection in very severe weather. Wherever it does succeed in such situations, it certainly is not to be surpassed, I think, by any other plant in use for this purpose. Whether its many beautiful and by no means common coloured spikes, or the decided and constant green of its foliage be considered, it is really a beautiful wall plant. We have against a wall in a not very favourable situation as regards warmth or full

sun, a plant of this *Veronica* about 5 feet high and 4 wide. It has stood there about two years, and has been from long before midsummer until late in autumn beautifully in flower.

At this late season of the year, or even in ordinary seasons it would be useful, as being the best of all plants or flowers to assist in enlivening a vase or bouquet of *Chrysanthemums*—say, an admixture of *Aimée Ferrière*, *Julie Lagravère*, *Jardin des Plantes*, and *Hermine*, with a truss of *Scarlet Geranium* for the centre, the *Veronica* being used as an edging, and the whole edged again with *Pteris tremula* and *Adiantum formosum*, the best of all *Adiantums* to stand. I say by all means try this plant in a sheltered corner. It is one of the most lively of our telling-foliaged plants, and the combination of its flowers is beautiful.—WILLIAM EAILEY.

METEOROLOGICAL NOTES ON THE YEAR 1863,

AND ITS EFFECT ON CERTAIN PLANTS IN THE PAST AUTUMN.

Month.	Rain.		Thermometer.				Frost. No. of days.
	Inches.	No. of rainy days.	Highest.		Lowest.		
			°	Date.	°	Date.	
January.....	2.12	26	55	31	27	28	12
February.....	.92	15	58	28	26	21	16
March.....	.77	11	68	25	25	18	11
April.....	.72	10	72	20	28	2	8
May.....	1.62	10	80	29	31	1	1
June.....	4.51	19	84	3	41	2	...
July.....	.73	3	85	15	39	19	...
August.....	2.42	14	87	9	44	21	...
September.....	3.28	13	74	19	32	29	1
October.....	2.10	20	68	8	32	27	1
November.....	1.85	15	59	25	27	10	6
December.....	1.62	13	54	16	27	23	8
Total for 1863.....	22.66	169	64
Total in 1862.....	26.91	195					67
„ 1861.....	24.01	138					25
„ 1860.....	33.66	216					93
„ 1859.....	29.55	151					93
„ 1858.....	16.33	116					93
„ 1857.....	24.33	137					...

By the above table it will be seen that February, March, April, July, and December have been dry months, the first four especially being much drier than usual. May and November have also had less than the average rainfall for these months. October is likewise a little under the average, while January and August are a little above it. June and September, especially the former, are much above the average. Taken as a whole, the rainfall of the year is about 3 inches below the average of the last ten years; but the fall has been so well spread over the season in which it was most required, that the effects of drought have been little felt. The greatest rainfall in any one day has only on one occasion exceeded three-quarters of an inch, and that fell in August when the thirsty ground was ready to absorb any reasonable quantity. We have never had anything like a high flood in our rivers; and only once, and that in the beginning of the past month, a moderate one filled our streams for a short time.

With regard to temperature, the past year may be regarded as more remarkable for a mild winter than a warm summer, the frosty days being both fewer and less severe in intensity—in fact, 7° of frost is all that was registered here, and at places in the neighbourhood it was much the same, perhaps 1° more in certain positions. The dry condition of the ground in the months of March and April rendered the frosts of these months less hurtful to vegetation than they otherwise would have been. It ought, however, to be remarked, that the thermometer on the night between the 18th and 19th of July descended so low as to indicate freezing in some places not far from here, but it never sunk so low with us. A slight frost on May 1st, and one on the 29th of September, may be regarded as being as late and as early as we are generally visited with it, while the mildness of the autumn months has been only equalled by that of a few seasons during the last twenty years. July was a particularly fine month, as likewise was a great part

of August. June was dull, cold, and wet; and the absence of sunshine in that month retarded vegetation, so that instead of having what is called an early season, of which there was every promise from the advance made by the 1st of April, the hay and corn harvest was not earlier, but, perhaps, later than usual. Fruit, however, especially Apples and Pears, ripened sooner than usual, and the consequence is they have kept badly.

The mildness of the autumn has not been without showing some of its effects on the vegetable kingdom. Many tender plants which are usually cut off by the middle or end of October are still in a flourishing state. Even Geraniums, where a little sheltered, look tolerably well, while Verbenas and Calceolarias seem in more robust health than at any period of the growing season. The mildness of the weather has, however, not been without its evils, as some plants from temperate climates have never yet ceased growing; and the probability of winter overtaking them leads one to expect that they will receive a check more hurtful now than it would have been in October. On the other hand, there never was a more favourable time for transplanting evergreens and performing all kinds of out-door work. In the kitchen garden, all the Cabbage and Green tribe have made much progress, which has also been the case with Turnips, Celery, Lettuce, and other vegetables. In the shrubbery, however, premature advancement has placed some of the choicest evergreens in a perilous condition. A few remarks taken casually on some of the species at this place will, perhaps, interest the reader.

Yucca.—Few plants, even amongst the tropical inhabitants of the stove, present a more noble appearance than this when in flower. Its own rigid uniform outline is well represented by the huge spikes of flower it sends up when it is in a healthy and vigorous state, and the season favourable for its doing so; but, like some other plants from distant latitudes, it has not yet attempted to flower at any of the stated periods native and kindred species of plants have been accustomed to do; but sometimes it has the ill luck to burst into a flower-spike just on the eve of severe weather, and the result is, the flower is nipped in the bud and is useless. Such has been the case in the past autumn; in a border of plants of the various species of *Y. gloriosa*, *aloiifolia*, *recurva*, &c., about twenty spikes in the various stages of unexpanded bloom may be now seen at the present season. This is much to be regretted, as many of the spikes must be abortive; and even if the mild weather continue they will not grow to the same height and expand as they would have done in summer, and the same heads do not flower again for two or three years. The flowering of *Yuccas* in a capricious way is in some instances an advantage rather than otherwise, as there is more succession; but the probability is, that there will be few to flower in early summer, as so many have done so now. If we had been visited with some severe frosts in October and wintry weather since, it is likely most, if not all, of those which have since that time run into flower would not have done so till spring, and spikes 10 feet high and upwards would have been the result; now they will be killed, or be at best only indifferent objects.

Ceanothus aureus.—In very fine summers this beautiful shrub, trained against a terrace wall, flowers twice; in 1859 both times abundantly. Since then it has only occasionally presented us with a few of its lovely racemes of a beautiful blue; and during the past autumn successional flowers have expanded, and at the present time, the 30th of December, as good flowers as at any part of the season may be had. There are, however, only a few expanded, but the plant is fast swelling its bloom-buds into the condition of bursting, and unless checked speedily it will advance too far to endure any severe weather that may follow. As a plant to cover a wall I know of none better than this, especially in favoured situations, for I am not certain that it will endure everywhere. The winter of 1860-61 proved fatal to many plants in different parts of England, while here it was scarcely injured, although *C. papillosus* was killed, and some plants of *C. divaricatus* or *dentatus* suffered also.

Veronica.—Fine autumns are invariably favourable to plants of the New Zealand species flowering well, and, therefore, it need not be wondered at that its flowers are abundant at the present time; in fact, so long as the thermometer does not sink lower than 27°, and the plant occupies

a sheltered position, it is likely that it will flower all the winter.

Berberis Darwinii.—This is not generally in so advanced a condition as it is this season, as some fully expanded blossoms are on a plant against a wall. As a fit accompaniment to the *Ceanothus* above alluded to, this plant deserves a place everywhere, for, apart from the myriads of orange-coloured blooms with which it presents us early in spring, the foliage is at all times beautiful, and the habit of the plant all that can be desired.

Cassia corymbosa.—Two plants of this growing against a wall are in full bloom, and one in a more exposed place was in bloom also until some frosts in the early part of the month injured it. This plant, however, is more tender than any I have named—in fact, it may be said to bear no more frost than a Scarlet Geranium; but if protected from frost its foliage as well as its flowers present as handsome an appearance as anything well can have. Last winter is the only one I have ever known a plant endure out of doors, and mild as it was, those we had suffered as much as the Scarlet Geraniums did under the same circumstances.

Passiflora carulea.—Flowers of this pretty creeper continue to be supplied, and the plant is almost as interesting as at any other season by the great numbers of flower-buds with which it is studded over. Its hardiness, however, is well known, and its free-flowering habit is, perhaps, better exemplified out of doors than when under shelter. Every season, however, does not furnish us with expanded blossoms at Christmas from an out-door unprotected plant, which has been the case this year.

Heaths.—Early in summer some small Heaths that were not wanted, being, in fact, superfluous stock, were planted in a bed of leaf mould in which Indian Azaleas, Japan Lilies, and some other things were grown. Not being attended to immediately afterwards, many of them succumbed to the dry weather that followed; but of those which survived, were two or three plants of *E. hyemalis* which have flowered beautifully, or rather they are now in full flower. One of the beds where they are grown has an edging of *E. carnea*, which is also rapidly coming into flower—in fact, it is partly out now; but it is not so early as the popular greenhouse sort mentioned above. *E. Wilmoreana* is more backward. Some plants of both kinds planted in the open spaces of a bed of peat in which *Rhododendrons* are grown have not done so well, but this, no doubt, owing to the bed being previously occupied and partly shaded.

Coronilla glauca.—Of late years I have not planted this out much, but some time ago I noticed a plant growing in a cottage garden which was densely covered with bloom. I should think where plants are favourably placed they must have flowered well the past autumn. This plant is more hardy than many are aware of, for although it may occasionally be killed down to the ground, it sends up suckers all around, becoming, as it were, a weed on dry stony soils.

Jasminum nudiflorum.—This creeper, which flowers every autumn under ordinary circumstances, is only remarkable this season for being more profuse than before, and at the present time it forms a highly ornamental object in some positions.

Clianthus puniceus.—It would be difficult to conceive anything more really beautiful than was a plant of this during the past spring. Growing against a south wall, but fully exposed, its front was an almost entire mass of coral-coloured blossoms. The summer's growth having also been favourable, the plant is now covered with innumerable flower-buds hanging from the shoots like an extraordinarily heavy crop of Currants in the same condition, only much larger; every shoot is laden with these embryo flowers, and some of them in the interior of the plant are fully expanded, the red claw-shaped blooms contrasting well with the profuse and healthy delicate green foliage, which in point of form is also beautiful, being pinnated. Those who have only met with this plant growing under glass, rarely see it in such vigorous health as it enjoys out of doors, its liability to be attacked with red spider rendering the foliage a sickly yellow and impairing its beauty very much; while outside it is all but entirely exempt from this, and in many cases is entirely so. So great a liking has the red spider for the foliage of this plant, that I can even find traces of it now on the oldest leaves of a plant about 10 feet high, which is out of doors. Some younger ones are exempt, but all are

thickly clothed with flower-buds, which are quite as far advanced as I wish to see them. The plant, I need hardly say, requires protection in severe weather, its hardness being about the same as that of some of the Acacias, certainly not more so; and as its growth is prolonged later in the season it is more susceptible of injury from cold.

Garrya elliptica.—There is nothing particular in this plant being in full flower now—in fact, its long, beautiful drooping catkins only expand and show themselves more to advantage in mild than in severe winters, for the most severe one does not prevent their being produced. With us blooms of this fine evergreen are much less plentiful this season than last: this, however, may be owing to some injudicious pruning.

Chimonanthus fragrans.—This, too, is a plant that flowers almost in spite of the weather, though the bloom is then neither so abundant nor so fragrant: but its ordinary season of flowering being in winter, there is no particular interest attached to it beyond the flowers being more fragrant than in colder weather.

Roses.—Many of the Hybrid Perpetuals have continued to furnish buds up to the present time, while some of the Tea and China section against walls may be said to be almost in full flower, or rather have been so, for they have in a great measure been cut for decorative purposes. It is rare indeed, that such a quantity of Roses can be obtained at Christmas as the present year has favoured us with, for with the exception of the Moss and Gallica, most of the other sections contributed specimen flowers of more or less merit, and some that would have been regarded respectable-looking even in June, made their appearance in December. What will the poet and novelist say to this?

Rhododendron.—The occasional flowering of some of the varieties of Rhododendrons in autumn is not by any means an unusual occurrence; and I only mention it here to correct an error made elsewhere—that it is rare to see an expanded bloom on this plant at the present season. This place is not by any means suited to the Rhododendron; nevertheless, a month or more ago I noticed one or more blooms on the point of expanding on some plants in a very exposed position.

Primroses.—I believe that flowers of the wild one might have been gathered every month of the past year. I certainly saw some plants in a half-cultivated condition that were in flower in August, and have bloomed continuously since. The wild plants in the woods and hedgerows are also in flower in many places, and the garden varieties have been flowering some time also; but as this is not at all remarkable it is only mentioned here in consequence of others reporting it as a singular occurrence.

In recording the above, the reader whose taste is searching after things extraordinary will feel disappointed, as I confess we have no Gooseberries fit to gather, Apple Trees in bloom, nor any of the other marvellous things I have read of as being seen elsewhere. A mild autumn simply continues the growth of all annual and other plants as have not a decided period of rest, and even amongst the latter, long-continued mild weather induces a partial advancement of the buds, but nothing to the extent we hear of as taking place in some cases where, perhaps, the dealers in the marvellous are glad of an opportunity to create a sensation. Some few days ago I read in a newspaper of a Thorn tree being in full blossom in the open air. I confess having seldom seen any expanded blooms on this tree before the 1st of May, and sometimes not even then. I certainly have known Mushrooms to be gathered at Christmas, but of late years they do not seem to have been so plentiful as they used to be. In the best of the season this district is by no means a favoured one for them, and I do not hear of their having been found anywhere very late in the autumn. It would be ungrateful to allow the memory of the past year to fade away without recording its merits, which certainly have neither been few nor unimportant. A very favourable spring was followed by a growing period in June, and this was succeeded by fine weather for the hay and corn harvest, and subsequently as fine an autumn as any nurseryman or those having extensive plantations of shrubs to make could wish for. Let, therefore, due honour be paid to the memory of 1863, for, taking him in all his parts, "we may not look upon his like again."

J. ROBSON.

ROOTS AND LEAVES.

(Continued from page 8.)

TRANSPLANTATION in its third sense—that is, having for its object the mere removal of the subject, is understood by all, but I must not pass it over without a few remarks. Nurserymen and gardeners practise it almost daily, but more especially in the spring and autumn. The nurseryman transplants most of his plants annually, and he does this to keep the roots near the stem to increase the number of mouths and fibres, and thus make his stock stiff and sturdy and insure their safe removal with a bunch of roots, and so make sure of their rooting on replanting. Great praise is due to our nurserymen for the pains they take to transplant their stock; but I would wish them to transplant their large trees a little oftener. I have occasionally had trees 10 feet and even 20 feet high sent from a first-class nursery, with less fibre at the root than the same trees had when but 4 feet in height. On making complaint, I have been told that such large trees are only kept to oblige particular parties, and that it would not do to keep transplanting large trees, for they are not in general request. Any person wanting large trees will find it to his interest to intimate his want to the nurseryman a year beforehand, when the latter would dig round the trees and so promote the emission of fibres, and insure removal with a better root in the following autumn. Such trees would be a trifle higher in price, but who would begrudge that when there was a greater certainty of their growing?

All trees are best removed with a ball, but deciduous trees can be moved readily without a ball, providing they are not stubbed up. Trees cannot have too many fibres preserved at the time of transplantation, though it is not necessary to retain the extremities of these. The more roots left the greater is the absorbing power. Roots absorb moisture in proportion to the surface exposed: therefore, the more root a tree has the better will the head be kept from shrivelling in a dry spring, for it is certain that deciduous trees lose all or greater part of their spongioles in transplantation, and have to rely on the moisture absorbed by the roots and young wood for the moisture that sustains vitality from the time of transplantation to the emission of spongioles. Deep planting is inimical to the formation of new roots, consequently shallow planting is preferable.

In addition to the customary watering of newly planted trees, in spring and early summer a sprinkling of the head is preferable to too much watering at the root. It materially assists the swelling of the buds and the formation of leaves, on the presence of which the protrusion of roots in a great measure depends. Such trees as have stems covered with bark of many years' growth cannot, however, derive much benefit from sprinkling the head with water; but if the stem be covered with moss and kept moist it vastly promotes the formation of roots and the development of the head, besides accelerating the flow and descent of the sap. I have shifted standard Roses as late as the beginning of May, and by wrapping a hayband round all the available stem, moistening it morning and evening, have not had a failure, though the foliage was in many cases far advanced in growth, but that did not prevent their flowering and doing well. The foliage, I may add, was syringed morning and evening, and a shading of tiffany employed during bright sun. I well remember the time when I had this "wrinkle" put in my head. I was but a lad scarcely in the teens when my mistress placed a Standard of Marengo Rose in the gardener's hands. It was 7 feet high, and had a head more than 2 feet in diameter, with new foliage 3 inches in length, and, worse than that, it had the characteristic root of the Dog Rose bad enough for anything. Extra care was taken in planting and watering, but despite all efforts the Standard of Marengo appeared destined to live in memory only. One day, however, I espied the coachman bandaging a sprained horse leg with a wet bandage. "Why?" inquired I. "To cool and strengthen it," was the answer. Just the thing for our Rose tree, thought I. Well, the gardener favoured the young idea; we covered the stem with moss, and tied matting loosely round to keep the moss in its place. Water was poured on this ligament twice daily, and shortly afterwards the stem shot forth a branch of its kind, and the head began to flourish.

In removing large deciduous trees when only a small root

can be preserved, it is a good practice to reduce the size of the head in proportion to the reduction of the roots. The old and useless ramifications will suggest the application of the pruning-hook, but few think that the straight and long-jointed parts are less tenacious of life than the crooked and twiggy. The parts that have been fed slowly are more likely to stand drought than those formed rapidly.

Puddling trees at the time of planting serves no purpose beyond producing a soddened soil for roots to form in. Mulching the surface round the stem is a far better practice, providing it be done after a thorough soaking with water.

Trees of all kinds when of large size, should be prepared for removal by digging round them in the previous autumn. About half the diameter of the head is the proper distance from the stem at which to open a trench, and all the roots having been cut the trench should be filled in again. This process encourages the fibres near the stem, and furthers the emission of fibres where the roots were cut. Evergreen trees and shrubs should be removed with a certain amount of ball in all instances, especially such as have fibrous roots as Rhododendrons, &c.; and the whole tribe of Coniferae ought to be transplanted with balls fully one-third of the diameter of the head, and as deep as the roots themselves determine.

A little fine earth put under, around, and on the roots at the time of planting, materially facilitates the emission of roots, and a top-dressing of manure increases the vigour of the trees after root-action has commenced. Manure, however, is said to poison some coniferous trees. Too much is no doubt injurious to any plant, but used in moderation and in accordance with the constitution of the individual, I am persuaded that it is highly beneficial. High feeding the roots of plants causes extreme luxuriance, renders the parts more susceptible of injury from wet, dryness, cold, and heat, and consequently more liable to prevailing diseases than when living in a less rich medium. Poor soil is equally productive of disease, and then insects make their attacks and suck out the juices. The business of the cultivator is to increase or diminish growth by the exercise of his discrimination. He would never think of giving an extra supply of food to a plant that did well without such assistance, nor would he deprive a plant of nourishment because it was weak. Manure may kill a plant in one locality, whereas it would invigorate the same species in another spot. It is the judgment and experience of the cultivator that ought to guide him in augmenting or diminishing the supply of food necessary to secure the well-being of the plants under his care. Rich soil or manure placed on or around the roots at the time of transplantation is detrimental to the formation of roots, but a soil moderately rich nourishes the plant and encourages the formation of fibres. Bedewing the head of evergreen trees serves to keep the parts fresh, and furnishes at once that which has been evaporated during the day; the watering of the head should, therefore, be done in the evening and early in the morning.

Evergreens must, as already stated, be removed with a ball, for the head of an evergreen is more or less dependant on the roots at all periods of the year for its nutriment; consequently, a ball having a quantity of undisturbed fibres is more likely to keep the head fresh, on which depends the formation of new roots.

Deciduous trees are best shifted in the autumn, and fruit trees are none the worse for being lifted whilst they have a few leaves upon them; but the leaves should be falling off pretty generally before any attempt at removing or lifting takes place. Evergreen trees and shrubs are best transplanted early in autumn, for the demands on the roots are then less than in spring, and the leaves have an opportunity of collecting more moisture from the atmosphere at that time than in the dry spring and summer months. Besides, there is the probability of the newly planted trees forming new roots if the autumn prove mild and showery, and this enables the plants to withstand the changes of a fickle climate. The difference between autumn and spring planting rests on a free use of the watering-pot. Plants moved in autumn require nothing beyond a good watering at the time of planting, whilst those planted in spring require an almost daily application of water.

Some people have a notion that all a tree wants on transplantation is the digging out of a hole and filling it in again.

The soil, however, should be loosened around the hole so that the roots can run freely into it, and the head should be well staked to prevent its moving to and fro with the wind. Firmly treading the soil secures this as much as anything, but in some cases staking is absolutely necessary. A hay-band or some such material should be placed between the stake and the tree, and the rope should be prevented from chafing the bark of the tree. Some people also have a barbarous system of cutting the roots of trees at the time of planting. Bruised parts may be removed with advantage, but the wholesale reduction of the roots of a tree serves no good purpose, but robs it of a quantity of root-forming surface, destroys its absorbing power, and limits (for it is certain that it cannot further) the production of roots. Reduction of the head is a far better practice, and even advisable where free growth is desirable. We frequently cut back wall trees to a few eyes, but if we left them their full length we know that the tree would become stunted, and make no growth beyond forming spurs, which is undesirable, as we want growth so as to cover the allotted space in a short time. This I can very well comprehend, but how any one can think that cutting off the roots can conduce to the wellbeing of a plant I cannot understand. It is easy to make out why nurserymen strive to keep the root small or near the stem, but not so easy to tell why a root considerably reduced by lifting can be improved by being reduced still more by the pruning-knife. It may do to check vigour, promote the profusion of fibres, and thus increase fertility, but as for insuring success in transplantation I do not believe in the proceeding.

Having discussed the subject of roots at such length, I must for the present defer saying anything about leaves, but I hope ere long to offer some remarks on their combined action.—GEORGE ABBEY.

(To be continued.)

PEACHES UNDER GLASS v. PEACHES ON OPEN WALLS.

Nothing has surprised me so much in reading the discussion on fruit culture, which has appeared in your pages of late, as the assumption that Peaches grown under glass are less highly flavoured than those grown on open walls. If those who hold this opinion mean forced Peaches I could agree with them; but if they mean to say that the protection of a glass roof prevents the full development of flavour in Peaches, I must beg very decidedly to differ from them. Not only is the Peach crop on the open walls in this neighbourhood a most uncertain one, but in a cool summer the fruit is hardly worth having, whilst in no season have I ever eaten a Peach from a wall equal to those I can grow every year in an orchard-house. As bad fruit may be grown under glass as out of doors if the trees are unhealthy, covered with red spider, shaded by Vines, over-cropped, overcrowded, or syringed up to the day the fruit is ripe; but the glass is not in fault. Of course I take it for granted the glass is of good quality, the panes of large size, and the house properly constructed. It is possible to find houses with small panes and heavy rafters, the plants in which are constantly shaded—no one ought to expect good fruit of any kind in such a house.

Is it not strange that men who hold English house Grapes to be the best in the world, believe house Peaches must be inferior to the same kind of fruit grown without protection? Is it not equally strange that they should think it essential to crucify a Peach tree to have good fruit? Is it copying nature so to distort a poor tree, that the fruit can only be ripened on one side? I would advise those who hold these opinions to tie up their bunches of Grapes, so that these may be above the foliage, and take off the sashes to ripen them. When they do this I shall think them consistent. Whether Peach trees are in pots or planted out, let them be healthy and not over-cropped and I will guarantee you may gather fruit within 2 or 3 feet from the ground of first-rate quality in every respect. There will always be a great difference in the colour of Peaches grown under glass from those grown on walls, the latter being much darker; but in this respect I think there is nothing to regret. I once took twelve Royal George Peaches from a standard

orchard-house tree, which for size and beauty were all that could be wished, to show to a gardener who grew the best wall Peaches I ever saw. The garden he cultivated was on the oolite, a thorough Peach soil; the fruit was very large and very dark-coloured. He gathered three kinds—Royal George, Violette Hâtive, and French Galande—and a number of friends were asked to say which were the best. In size there was little or no difference, though mine were taken from one tree, and his were picked from a large garden; but he insisted his were so much higher coloured. The answer he received was, "A ruddy milkmaid may be very pretty, but a refined lady's complexion may be more beautiful. We prefer the beautiful light red of the orchard-house Peaches to the colour of yours, which is almost black." "After all," I said, "we grow Peaches to eat, let us taste them." I shall never forget his face when the whole company said that his, in comparison to mine, were mere Turnips in flavour.

The time will soon come when to build a wall uncovered with glass for the production of Peaches will be considered an absurdity. I have always recommended orchard-houses to be built in preference to covering walls, because they make much more agreeable places to walk in, and can be built to cost quite as little per foot square covered, as a lean-to house, even when the wall is already in existence. It appears a pity, then, to spoil a wall which could be made to produce other good fruit in place of having a handsome detached house. We are most of us convinced that the proper way to grow Grapes is to have only one stem, and yet Pears are trained in such a way that it takes years to cover a high wall. Whenever Pears on quince stocks are planted 18 inches apart, and trained and stopped like a Vine, the highest wall may be covered in two or three years, and he who tries the plan will not be inclined to waste an open wall with Peach trees to obtain one or two crops of second-rate fruit in four or five years. I think I hear some one saying, "Plant Pears 18 inches apart! A pretty lot of trees it would take to fill a wall!" But if one-year-old plants with a single shoot be purchased, they ought to be had for say 50s. per 100, and considering the time saved in covering a wall and the trees coming into bearing, this would be no very serious matter. But this is a digression. I could not help comparing a wall covered with a full collection of Pears, which could hardly all fail in the worst of seasons, with Peach walls as we generally see them, or rather did see them, for the trees in this neighbourhood were all injured, and many of them killed in 1860.—J. R. PEARSON, *Chilwell*.

DO LEAVES ABSORB MOISTURE?

I HAVE to thank Mr. Abbey for his very full and able reply to my request for further information as to the power which leaves are said to have of absorbing moisture. I think his arguments are convincing, and yet I hope he will not think me too sceptical if there be still one or two points on which I am not quite satisfied. As long as the spongioles can derive any moisture from the earth, whatever checks evaporation must have the same apparent effect on them as if they had actually absorbed moisture from the atmosphere. Is it possible to deprive the earth of all moisture chemically, without, at the same time, depriving the plant of all power to revive its drooping leaves, even when syringed in a damp house? They might revive temporarily under such circumstances without absorbing moisture, for evaporation being to a great extent prevented, the juices still stored up in the stem and leaves might possibly enable the latter to perform their functions for a little while until quite exhausted. Assuming, as I suppose we may, that evaporation is influenced by the humidity of the atmosphere, as well as by light, syringing a plant which has drooped for one day and a night on the second morning may check evaporation sufficiently to restore the balance between the parched roots and leaves for a while; but how long would it be before they would droop again, the balance being once more and finally destroyed?

The experiments with the Gloxinia leaf and Calceolaria cuttings are far more satisfactory; indeed I can see nothing wanting except the test of weight. Mr. Abbey proposes that the leaf should be deprived of one-fourth of its weight

of moisture before trying the experiment. Has it recovered its original weight after reviving under the bell-glass? If this could be shown I think the power of absorption would be proved; but this evidence is still wanting.

I sent "Mr. Frond" some ripe spores of the *Osmunda*. If he intends sowing them I should like to know how he succeeds. It is abundant in my neighbourhood.—S. L. J., *Cornwall*.

[Admitting that a drooping plant prevented from absorbing moisture by the spongioles, may possibly recover the freshness of its leaves when evaporation from them is prevented by syringing, or otherwise making the surrounding atmosphere moist, and that the stored-up juices of the stem are sufficient to enable the leaves to restore the waste of the previous forty-eight hours, I am at a loss to tell what takes the place of the crude sap then impelled into the leaves. Presuming, further, that the same plant was exposed to light, the air becoming drier, the leaves would presently droop. If syringed and kept moist the leaves would recover their freshness at night. The plant would not endure this treatment long, and growth would no longer take place; but the leaves might absorb sufficient moisture at night to enable the plant to assimilate its carbon, and perfect the growths already made. Trees growing on walls in dry weather absorb moisture at night, which is evaporated in the day, and this goes on until the growths are perfected, when the leaves are thrown off.

If we cause the leaves of a plant to droop from want of moisture in the soil, and whilst drooping coat both surfaces of the leaves with gum, which will partially hinder evaporation and prevent absorption, and place the plant in a moist atmosphere, it will not recover the freshness of its leaves. When the moisture in the soil is not sufficient to meet the demands of the leaves they must inevitably perish if they are prevented from absorbing moisture through their stomata.

Independently of this, further take a plant in a pot, or rather place it in one holding 7 lbs. of soil in a dry state, and make it weigh 8 lbs. by watering the soil, the pot and plant increasing the weight to 12 lbs. We have now to cause the loss of a pound of water, but we cannot do this without killing the plant. We will, therefore, reduce the weight three-quarters of a pound, and syringe the drooping leaves, preventing water reaching the roots, and we have a fresh-leaved plant in the morning, and some trifle heavier than it was when the leaves were drooping.

Deprive a leaf of one-fourth of its weight by evaporation, and then place it in water with the footstalk in oil, and it will weigh as much after it has absorbed sufficient water to fill its cells as it did when detached from the plant in its fresh condition. Were the leaf not placed in water, but simply syringed, and put in the dark in a moist atmosphere, it would recover its freshness all the same, but would not weigh so much, because when in water it absorbs carbonic acid, whilst in the atmosphere it inhales oxygen and a slight portion of carbonic acid only, for the leaf cannot inhale more than the air contains, which, as respects carbonic acid, is not more than one part in a hundred by weight. Carbonic acid is the heaviest of all gases; therefore the difference in the weights of the leaf in water, and when absorbing moisture from the air. I have not the least doubt that leaves in an ordinary condition absorb moisture from the atmosphere at night in dull weather, and especially in dry weather, when the roots do not afford sufficient moisture for the process of assimilation, for this cannot take place without moisture, and thus plants are enabled to withstand drought without perishing.—G. ABBEY.]

SPRING AND WINTER FLOWER GARDENING.

Containing the System of Floral Decoration as Practised at Cliveden, the Seat of Her Grace Harriet Duchess of Sutherland. By JOHN FLEMING, Gardener to Her Grace. London: Journal of Horticulture and Cottage Gardener Office, 162, Fleet Street.

ONE great element of success for any book is its timely issue. Without this advantage the ablest compositions may remain to weigh down the shelves of the publisher.

With merit and appropriateness as to time, there must be a rapid sale, and on both accounts we feel confident this will be the case with the present treatise of Mr. Fleming.

There are two growing feelings as respects flower gardening of the present day:—First, that the throwing the whole strength of ornament into the summer and autumn months has been robbing the other months of their due attention; and, secondly, a yearning desire to see more

made of the old herbaceous plants that were huddled out of sight to make way for their, perhaps, gayer but not more beautiful rivals. This book tells how the simplest of these old plants can be made to render the garden as gay in March and April as any lady can have her parterre in July and August. The fine coloured print of the large garden at Cliveden, given in July, 1862, must have been regarded in wondering pleasure by thousands.

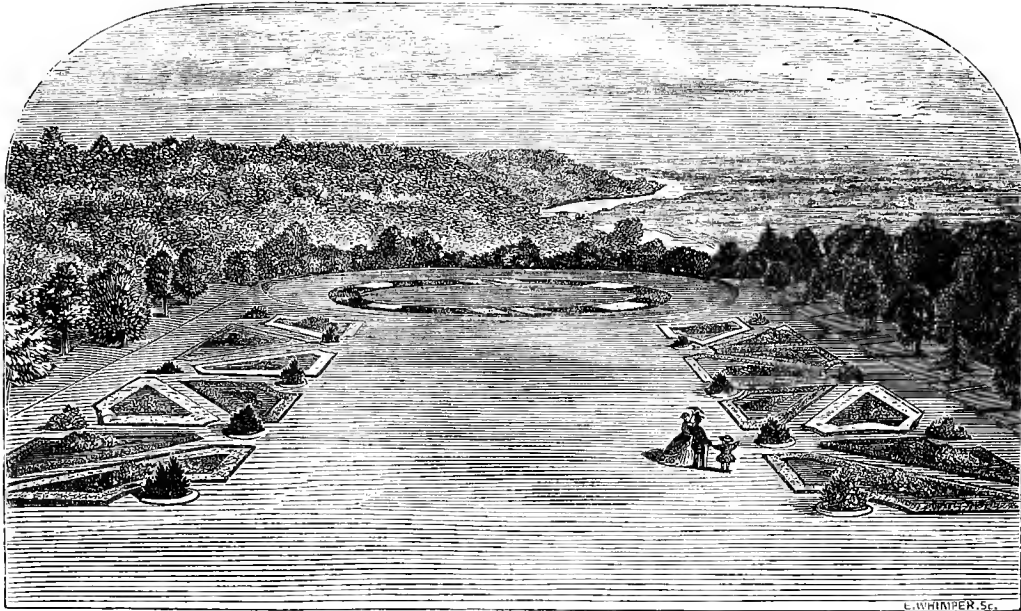

The frontispiece of Mr. Fleming's book we here republish. It is a view of this garden and surrounding scenery. There are eight large beds on each side, each surrounded with evergreen edgings 8 inches high and 9 broad. Each bed is over 80 yards round. The centre of each is filled with early Rhododendrons or Azaleas, then 3 yards of grass, and then next the outside 3 yards for flowers. These outside nine-foot borders, as it were, make the cream of the beautiful picture; and yet how simply was the fine effect accomplished! We use the word "simply" in no depreciatory, but in the highest commendatory, form possible. Genius is generally severe in its simplicity. Everything that is either great and grand is simple. For these sixteen huge beds we find after Anemones, Jonquils, Yellow Tulip, Tournesol ditto, Rex Rubrorum ditto, La Candeur ditto, Rose ditto, and mixed Tulips, the whole effect was produced by a happy combination and contrast of such plants as *Silene pendula*, white and pink *Silene*, blue and white *Forget-me-not*, and *Limnanthes Douglasii*—plants that will thrive by the side of every cottage home, as well as in the domain of a noble duchess.

of the Tulips, and thus takes away all stiffness. Simplicity, elegance of style, and the using chiefly of easily obtainable plants, that are easily increased, and may be had by any one, are the great characteristics of the winter and spring gardening at Cliveden. As an example to our readers, we present them with the parterre, No. 10, copied from Mr. Fleming's book.

Mr. Fleming gives three modes of planting it. The following is the third:—

No. 1, beginning at grass edging:—

- One row of Crocus.
- One row of white Daisy.
- One row of Cliveden Blue Pansy.
- One row of yellow *Alyssum argenteum* or saxatile, pegged.
- One row of white *Silene*, and the remainder single yellow Wallflower, with three plants of *Honesty*, pink or white, in the centre.
- 2 and 3, *Anemone*, mixed single, and single *Jonquil*.
- 4, pink *Silene pendula*, and a few crimson and white Tulips; edging, yellow Pansy and Crocus.
- 5, *Iberis sempervirens*; edging, *Scilla arvensis*
- 6, mixed single coloured *Primulas*; edging, *Eranthis hyemalis* and red Daisy.
- 7, *Alyssum argenteum* or saxatile; edging, Pansy Magpie and blue Crocus.
- 8, white *Silene* and a few *Imperator Tulips*; edging, Dog's-tooth Violet and light blue Crocus or *Scilla bifolia*.
- 9, blue *Myosotis* and a few white *La Candeur Tulips*; edging, white Crocus and *Bulbocodium vernum*.
- 10, white *Iberis sempervirens*; and edging, blue Pansy.
- 11, mixed Oxlip or double *Primula*; edging, *Antirrhinum purpureum*.
- 12, red *Anemone hortensis*; edging, mixed Fancy Pansies.
- 13, white *Myosotis* and a few *Gloria Solis Tulip*: with edging, Cliveden Dark Pansy and yellow Crocus.

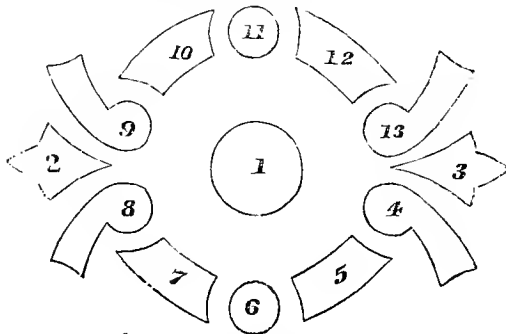

The Tulips in general are used thinly, the ground being carpeted beneath with some appropriate bright-flowering annual or herbaceous plant, which conceals so far the stems

Besides several plans for winter gardens, lists of fine-foliaged or fine-berried shrubs suitable for ornamenting them, there are full directions given for all the plants so used, moving them from the beds when these beds are wanted for summer ornament, the summer treatment necessary, propagation, culture, time to sow annuals for spring-blooming, &c., for which the little work must be consulted; and we will only observe that all these details are marked by great clearness and brevity. No doubt the moving and double planting and preparation of the soil will involve a great amount of labour, but in cases where labour power cannot be increased, it becomes a very proper question whether a much greater amount of gratification would not be yielded

by a smaller garden and rendered presentable at all times with the labour which the larger garden now receives, and which is next to a blank until June, except what may be done in the way of edgings. We hope we shall be gratified at some future time by having a first look of Cliveden in April, and a second one in July. We might then be more confident that the extreme of beauty could be attained on the same beds in spring and summer; and a look along Mr. Fleming's back borders would give us a good idea of the labour. The manner is sufficiently detailed in the book.

SOME GARDENS WORTH SEEING.

IN the list of gardens worth seeing in Northamptonshire, which appears in your publication of the 5th inst., I am surprised to see no mention of a place, which for refinement of taste and originality of design, is, although not on an extensive scale, one of the prettiest gardens in England. I mean Moulton Grange, the home of H. O. Nethercote, Esq.

Nor should your correspondent have omitted the gardens of Sir Charles Isham, at Lamport Hall, which contain among other attractions, a complete collection of alpine plants, admirably placed on a most picturesque rockery by the baronet.—S. R. H.

[We are much obliged by this communication, and the more so because it enables us once more to explain that we do not, and cannot, enumerate *all* the gardens worth seeing in any county. We publish the lists sent to us by correspondents of the gardens they know to be worthy of a visit; but they cannot know *all* the gardens deserving inspection, and we shall be obliged by any one supplying the omissions. But if "S. R. H." will refer to pages 293 and 333 of our last volume he will find that the places which he mentions have *not* been omitted.]

BRIDGE HILL, BELPER.

THIS magnificent residence of George H. Strutt, Esq., is on the slope of a lofty hill, and commands a pleasing view of the beautiful town and neighbourhood of Belper. Happening to be in the vicinity on the 16th of November, having about an hour to spare before leaving the town by an early train, and being aware of the good keeping of these gardens, I thought a hasty run through the grounds would be the most profitable way of spending the time.

On approaching the grounds from the town we pass over a neat and pretty bridge, which spans the river Derwent, and the water scenery from the bridge, on a fine and sunny day, is truly beautiful; indeed I do not know of any cascades among the romantic hills of Derbyshire, or in any other county, which can compete with the water scenery at this particular place. I entered from the Ashbourne Road, about 200 yards from the foot of the bridge; and no sooner is the visitor within the precincts of the place than he is at once struck with its sublimity. In the ornamental grounds, as I walked along the footroad which leads to the kitchen gardens, I could not help admiring the beauty and luxuriance of many of the trees and shrubs. The first object which meets the eye, after passing through the entrance gate, is a lofty Cedar of Lebanon, which no doubt has maintained its position for generations past, and undoubtedly will remain there for generations yet to come. Here, also, there are some remarkably large Yews and Portugal Laurels. We pursued this narrow walk, leaving the mansion a little to the left; while to the right, at the extremity of the dressed grounds, was the park, well studded with representatives of the various families of forest trees, venerable in their old age. The mansion stands on the slope of the hill, nearly a quarter of a mile from the entrance into the grounds; and the kitchen gardens are about a quarter of a mile higher up.

The mansion is a large, massive, square building, with a very pleasing exterior, partially covered with Ivy, nestled amidst masses of luxuriant green foliage; while the inside possesses all the advantages of domestic comfort. The principal entrance is on the south front, through a large conservatory, with solid marble floor and steps, among vases of flowers and sculpture. The carriage drive enters the park from the Winksworth Road, by a commodious lodge, in an easterly direction; and another drive from the west

end of the grounds also terminates at the same place. On the west side of the mansion is another, and the principal conservatory, always kept gay with flowers. On the east side are large and convenient offices, stables, and coach-houses, the latter well shut out by large trees. Behind the stables are the farm buildings and all the necessary appendages to so large an establishment. The principal road for pedestrians is by the east side of the mansion; and, as I continued my pleasant walk through the upper part of the grounds, I came to the kitchen gardens.

These gardens cover a space of about five acres, and the ornamental grounds about seventeen acres. On entering the enclosure I found myself in what is called the Melon ground, amidst ranges of pits and frames, devoted during early spring and summer to the growth of Melons, Cucumbers, early Potatoes, &c., but at the time of my visit they were filled with bedding plants, Roses in pots, &c. On the east side they are well sheltered from the cold winds by a high Yew hedge, and from the west by a stone wall covered with Ivy. In addition to the above ranges of pits is a large span-roofed house, with a partition in the centre, dividing it into two compartments. The first was used for growing greenhouse plants, and the second for stove plants, to supply the conservatories. It was here I met with Mr. Burton, the respected head gardener, and from whom I received a friendly greeting. We at once entered this span-roofed house; and in the greenhouse department I found the various tribes of hardwooded plants well represented in good and well-grown specimens of *Ericas*, *Euparises*, *Pimeleas*, *Chorozemas*, *Aphelaxis*, *Phanocoma proflifera Barnesii*, *Azaleas*, &c. On the shelves near the glass were immense quantities of herbaceous *Calecolarias* in fine healthy plants. The collection of *Azaleas* was large, and the plants handsomely grown, many of them quite equal to what we generally see at exhibitions, the pyramidal or conical shape being chiefly adopted. Some of the more choice varieties were *Advancer*, *Duchesse Adelaide de Nassau*, *Flower of the Day*, *Gem*, *Louise*, *Marie*, *Perfection*, *Rosy Circle*, *Sir Charles Napier*, *Sir H. Havelock*, *Sir James Outram*, *Perfecta elegans*, *The Bride*, *Stanleyana*, *Optima*, *Louis Napoleon*, *Glory of Sunninghill*, *Due de Brabant*, *Admiration*, and *Criterion*. Any one wishing to possess a collection of good *Azaleas* would find it difficult to improve on the above first-class varieties. In the stove I noticed some good *Begonias*, *Marantas*, and *Gesneras*. *Cissus discolor* was very fine. There were also a fine healthy plant of the fine-foliaged *Cyanophyllum magnificum*; for decorative purposes *Colus Verschaffeltii*, *Ardisia crenulata*, covered with red berries, and *Dracena terminalis*. I also observed some well-grown Ferns; but what I considered the chief attraction of the stove was a collection of *Selaginellas*.

Leaving these places, and passing out of the Melon ground, we found our way to two large vineries, full to overflowing with late Grapes. The houses are about 80 feet long, and 20 wide, and are heated by hot water. The borders are all on the outside, and the floors are paved with large flagstones. The crops of Grapes are all that could be desired, and certainly reflect great credit on the skill and ability of Mr. Burton. The *Muscat of Alexandria*, and the *Canon Hall Muscat*, were each in good condition, likewise the *Black Hamburg* and the old *White Tokay*, which is one of the best late Grapes grown; and I have no doubt these will hang until the end of February or the beginning of March. On the back part of the house was a stone stage, running the whole length of the range; and this was filled with large Orange trees in tubs, *Indiarubber-plants* (*Ficus elastica*), *Daphnes*, *Camellias* of various sizes, &c. Some of the *Camellias* were extremely fine, and among others were *Camellia Marchioness of Exeter*, *General Drouot*, *Colvilli*, *Chanfieri*, *The Bride*, *Princess Frederick William of Prussia*, *Lady Mary Lambouche*, and others. On the wall at the west end of the houses there are some excellent trees of *Peaches* and *Pears*, which, during the last season, have carried heavy crops. As we left these houses, at the east end I saw on the walls some large old *Apricot* trees, which, notwithstanding their advanced age, Mr. Burton informed me still did well.

We now pass out of this garden and enter another range of houses, about 300 feet long. The first house we entered was a late *Peach-house*, 100 feet long, the trees all trained to the back wall, which is 11 or 12 feet high. Every brick

from bottom to top was covered with well-ripened short-jointed wood; the buds, well swelled, covered the trees like small Peas. The front benches were filled with *Chrysanthemums* and *Cinerarias* of the best named sorts, in countless numbers, *Primulas*, &c. The second house was a plant-house, the hardwooded plants being chiefly such as before enumerated. The back wall was covered with *Cobœa scandens*. We then came into a lobby, through which there is a passage into what is called the fruit garden—a large square surrounded by walls, and devoted principally to the growth of the smaller fruits, such as Gooseberries, Currants, Raspberries, Strawberries, &c. The wall with a north aspect is covered with Cherries of the Morello section, and the east and west aspect principally with Pears and Plums. Resuming our journey through this range of houses, the third is an early viney, the Vines trained up both back and front. The fruit had long been gathered, and the wood was firm and short-jointed, nearly as hard as mahogany. Here, again, every available spot was filled with greenhouse plants. The last house in the range was the early Peach-house, 100 feet long. This has been recently planted with young trees, dwarfs and riders alternately. About fifty dozen of fruit had been taken from it during the last season; and Mr. Burton believed that 100 dozen might have been taken without injury to the trees. They are in excellent condition, with stiff short-jointed wood, the buds being very prominent. The front of this house is also filled with plants to supply the conservatories.

Passing out of these houses we came along the western boundary, the walls being covered with Plums and Pears. Turning round to the left we reached the south front of the garden. The wall here, 300 feet long, was covered with young Apricot trees, all coming to a good bearing condition. The walls with an east aspect were covered with young Pear trees, of such varieties as *Beurré Diel*, *Beurré de Rance*, *Louise Bonne de Jersey*, *Easter Beurré*, *Beurré d'Arenberg*, *Ne Plus Meuris*, &c. Proceeding to the right we pass across a shrubbery beneath the shade of lofty Elms and stately Oaks, and enter the kitchen garden. Here the same order and regularity were maintained as displayed over the whole domain. The walks round the various plots were edged with Strawberries. There were large breadths of fine Broccoli, Kale, Asparagus, Brussels Sprouts, Savoys, and Celery in various stages of growth.

Leaving this department we came to the pleasure grounds, the kitchen garden being to the right, but entirely shut out from view by a broad belt of evergreen shrubs. On the left I noticed large clumps of *Rhododendrons* of the most recent introductions, *Kalmias*, *Laurustinus*, and other shrubs. Pursuing our course we came to a spot where two walks branch off. That to the right, on the west side of the grounds, commands pleasant views of the surrounding country, with its undulating scenery, while in the valley below is the crystal stream of the river Derwent. This walk comes down to the lodge at the west entrance to the grounds, and thence on to the broad terrace walk leading to the mansion. The other walk, down which we passed, branches to the left, the earth on each side being thrown up a considerable height; and at a moderate distance from each other were beds of Roses, clumps of American shrubs, and single specimens of coniferous plants. There were fine specimens of *Cedrus deodara*, *Taxodium sempervirens*, *Pinuses*, *Golden Yews*, and some *Wellingtonias*, though rather small. There were also some fine old deciduous trees, which have witnessed the so-called good old times gone by, and stand dignified in their old age. The walks were many of them asphalted; and it undoubtedly saves a vast amount of time and trouble in weeding and rolling, besides the ease and comfort of travelling upon them.

From this walk we enter the conservatory at the west end of the mansion; and here, notwithstanding that it was the middle of dull November, a dazzling blaze of floral splendour at once met the eye. In the centre was a fountain, around which was a raised bed of ragged rockwork, in the interstices of which were planted some of the different species of *Selaginella*, creeping over the stones, and producing a very cheerful and natural effect. Of the plants in bloom there were *Camellias* of sorts, the old double white being completely covered with its pure white flowers; *Epiphyllum truncatum*, *Chrysanthemums*, *Fuchsias*, &c. The pillars

were covered with climbers, and part of the roof, from which they dangled with luxuriant ease and gracefulness. On the back wall were trained *Passifloras* of sorts; fine-foliaged *Acacias*, such as *affinis* and *dealbata*; *Habrothamnus elegans*, in full bloom; and a large *Heliotrope*, covered with its light blue flowers, filled the house with its delicious fragrance. This conservatory is kept gay at all times by fresh plants being introduced in bloom as others decline in beauty. I think, for such a lovely situation, that one of the *Passifloras* or *Acacias* should be removed, and its place supplied with the beautiful *Lapageria rosea*, which is the most splendid of all climbers when in a blooming condition.

In front of the conservatory was a geometric flower garden. The bedding plants being all removed, the beds were filled with dwarf coniferous plants and evergreen shrubs, such as dwarf *Aucubas*, *Berberis Darwinii*, &c. Round the flower garden was a broad terrace walk; and that was again encircled with a row of standard *Rhododendrons*, giving the flower garden an elegant finish, and they must be truly magnificent when in full bloom. Among the most prominent of the standard *Rhododendrons* were *Lady Eleanor Cathcart*, beautiful rose; *Grand Arab*, crimson; *Catawbiense Album*, waxy white; *Geranioides*, rosy crimson; *Atro-sanguineum*, blood red; *John Waterer*, glowing crimson; *Brayanum*, vivid rosy scarlet; *Celebrandrum*, dark purplish-crimson; *Duc de Brabant*, yellowish-white; *Blandyanum*, reddish crimson; and *Reediamum*, cherry red.

On leaving the flower garden we passed by the end of the conservatory, up a number of grass steps, to a walk that commands many pleasing views. A little to the left was the worthy proprietor's observatory, where he makes his astronomical observations; but this I shall leave to those who are better acquainted with astronomy than the writer. Retracing our steps a little we pass by the back of the mansion into the walk by which I entered the kitchen gardens; and here I must take leave of my guide. But it would betray a want of gratitude were I to close these remarks without acknowledging the exceeding courtesy and attention paid me by Mr. Burton, and the pleasure I felt at finding every part of the demesne in such excellent keeping.

The owner of this ample domain sustains the character of the true "old English gentleman" in the strictest sense; for he not only devotes a portion of his immense wealth to the progress of horticulture, but looks after the homes and habitations of the working classes; for there is no town, I should suppose, better supplied with good and commodious dwellings, at such extremely low rents, as the town of Belper; and, in conjunction with his amiable wife, he daily distributes alms and clothing in every known case of need in the adjoining town, and the sick and destitute are ferreted out and their wants at once supplied—affording another among the many instances happily prevailing in these times of kindly feeling towards our poorer brethren.—*QUINTIN READ, Bidduhph.*

THE SEASON.—It may be interesting to the dwellers in the south of England to know that in this (by many supposed to be) frozen north, within seven miles of Alhwick, my gardener has just called my attention to three Gooseberry bushes in flower, and which he tells me he observed about ten days before Christmas. Violets, Primroses, the Hepatica, Wallflowers, and other spring favourites have been blooming for some time past here; but a Gooseberry bush in flower is, I fancy, a novelty anywhere at this early date. I may add that 10° of frost, which set in on the 3rd and now continues, has nipped them in the bud.—*R. O., Eglington, Northumberland.*

WORK FOR THE WEEK.

KITCHEN GARDEN.

ANTICIPATING the approach of winter, cautions have been given and directions repeated for the protection of vegetables liable to be affected by frost. The exercise of forethought is a duty that our climate renders imperative in order to avert, by precautionary measures, the ill consequences that accrue from unfavourable circumstances of climate. *Asparagus*, if the soil in the production-bed should become dry give

a liberal supply of water so that it may reach the roots. The neglect of attending to this particular is one of the causes of unproductiveness, the soil at the roots being excessively dry, while the top is kept moist by gentle watering. *Carrots*, where young ones are wanted early, prepare a slight hobbed for the purpose, cover it with leaf mould to the depth of 6 or 8 inches, in which sow the seed. A little Radish seed may be scattered on the bed at the same time, but the Radishes must be drawn in a young state. *Lettuce*, if there should be a scarcity of the autumn-sown after the severe frost, sow on a slight hotbed, or in boxes in a forcing-house, to be afterwards pricked into a frame.

FLOWER GARDEN.

Should the present severe weather continue, the chief operations will consist in giving additional protection, and also in covering those plants which in ordinary seasons it is not necessary to protect. Where a little attention will secure from risk the plants which have been the objects of care and expense, how censurable must be the results of forgetfulness! As it is probable that many returns of the lowest temperatures of the present frost will be sent in by correspondents, it would render reports much more valuable if the statements be given merely in terms of the scale, as it sometimes happens when the thermometer indicates 10° of Fahrenheit's scale, that one calls that 10° of frost, another sets it down as 22° of frost, and a third as 10° below zero. By giving the numbers of the scale it is easy to understand that the numbers are considered above zero, except those having the minus sign (—) prefixed, as it should be to distinguish degrees below zero where such occur. Now is an opportune period to make and colour the plan of the flower garden, if not already done; by so doing an estimate of the quantity and quality of the plants required may be made, and then with all diligence endeavour to carry it out, and a surprising amount of success is certain to follow.

FRUIT GARDEN.

During severe frost when the wood is frozen internally pruning is injurious; the wounds afterwards exhibit a number of small fissures, in consequence of which the branch or shoot dies back farther than when cut when the sap is in a fluid state. In moderate weather, when the frost is not so severe as to produce the above effect, the Apple, Pear, Plum, Cherry, Apricot, and Peach, may be pruned any time between the fall of the leaf and the beginning of February. If the branch of a Plum or Cherry tree has to be taken off from the stem, it should be considerably reduced by summer-pruning, and cut close to the stem in winter.

GREENHOUSE AND CONSERVATORY.

A day temperature of 55° will be just sufficient for the conservatory at present. If this cannot be maintained without strong fires, be content with 45° and moderate fires, remembering that with this low temperature a very small circulation or motion in the air will suffice. A higher degree of heat would both hurry the beautiful *Camellias* and other choice flowers past their blooming period, and create a necessity for the application of more atmospheric moisture, which, unless a warm roof is secured by covering, must end in drip to the great injury of the delicate flowers. Those who possess only one small greenhouse and are desirous of a variety of early flowers, may now introduce from the cold frame, or pit a few of the early Dutch bulbs, provided their pots are full of roots, without which the application of heat is vain. A plentiful supply of healthy heath soil and fibrous loam should be prepared for the coming season; also, abundance of charcoal, charred sods of earth, and other articles, such as crocks of all sizes, and clear, gritty sharp sand. The pots out of use should all be well washed, tallies made; also, all sizes of flower-stakes, and these should be neatly pointed. Matting-ties should be bunched in convenient lengths. All such plants as require staking, re-staking and tying, or to have their pots or tubs washed, should at once be attended to. The surfacing of many plants that are not likely to require shifting can also be performed, for the season is fast approaching when the mind must be busily engaged in attending to a multiplicity of operations: therefore, every possible preparation that can now be made for the future should be carried on during the continuance of the present inclement weather out of doors.

STOVE.

Little or no advance of temperature may be permitted

here at present. Wait for the increase of light. Let 60° without sun be the maximum, sinking 4° or 5° in the night. Some of the *Lulias* and *Cattleyas* will commence rooting, let them have attention and encouragement. Examine the various tubers and bulbs that are dormant, and see that they are in a proper condition, neither suffering from wet or mouldiness. *Achimenes* and such plants will soon require to be excited.

FORCING-PIT.

Keep the temperature, with a moderate supply of moisture, at 60° by night, let the maximum be 65°. Get in Moss and other *Roses* to keep up a supply. *Anne Boleyn* and other *Pinks* may now be successfully forced. These and many other things for forcing purposes must, of course, have all been properly prepared, for it is vexation of spirit to force unless due preparation has been made by having them previously well established in pots.

W. KEANE.

DOINGS OF THE LAST WEEK.

"WHAT a summer of a winter! what April and May weather!" seemed the remark of every one with whom you met. But the 2nd gave us a foretaste of the sharp frost that was coming, and which settled all our out-door work, except wheeling, banking-up, and protecting, and taking in a good store of ice. We were just a day too late with many things for which we had made storage room on the floor, &c., of a vinery; but not being finished in time, we have had to protect them in cold frames where they stood, and thus incur all the extra labour.

The ice-carts were kept going for three days to fill our ice-house, as we have to scour the ponds in the neighbourhood for a supply, and dare not go to the same place a second time, as even now there is some dread of the drought experienced last summer, when water was a luxury. Our house is a well of the old-fashioned egg-shape, built at first, we believe, with double walls, but the inner wall was removed before we had anything to do with it. We have our own predilections about different constructions—houses above ground, ice-stacks, and all the rest of it, but we judge it bad policy to turn our back on an old servant of any kind who performs the duty assigned to him. We have used the utmost simplicity in the filling of our ice-house for years. We do not pound and smash half as much as some good friends recommend, and which is no doubt essential for small houses. The little places are, we believe, the chief mistake. A place that will not hold from fifty to eighty good cartloads is almost sure to turn out a failure. If we had smashed our ice to dust we should scarcely have been able to find enough within some miles' circuit; we therefore contented ourselves if we had enough small to mix up with the larger pieces, so as to form a firmish mass when beaten down. We use no salt, no straw, but just let the ice look after itself. We obtained no ice in 1862 or 1863, and the ice of 1861—and the place not filled wholly—kept us going to October, 1863, and then we had a block of Wenham Lake ice from London. After October we began to breathe more freely; and the chief regret we felt was from inability to fill a little vessel or two for people who were dangerously ill. Could we only obtain such blocks as those from Wenham Lake, almost any one might keep ice in a dry place, wrapped round with woollen cloth and covered with a mound of sawdust, the outside of the mound being always kept dry.

PROTECTION.

There is little difficulty in keeping out frost if the protecting material is abundant; but where there is much to do in the way of Radishes, Lettuces, Potatoes, bedding plants, and not a great deal of material to go to, the best plan is to change and turn the surface of the covering often to break the lines of radiation and conduction. One matter to be chiefly guarded against in cold pits, is to protect the walls. The neatest and best mode is to tie 2 or 3 inches of straw against them in November. This will keep out a great amount of frost, and will only require a little litter thrown against it when very severe. A little litter should also be placed on the ground for a foot at least all round the pit, otherwise in severe weather the frost will penetrate the walls and thus get inside. We recollect a case in point, a brick pit, the earth outside raised to the

front wall-plate, all was well protected, but the plants inside were frozen, and on close examination it was found to have come through the front wall, banked up as it was. The gravel in front was frozen, and then the frost found its way through the wall. A few inches of litter for a width of from 12 to 18 inches in front of the pit would have averted the mischief.

Where there is heat below, or fire heat is used, the protection should be moved at all favourable opportunities, though only for a few hours at a time. Where the inside temperature is sufficiently low to arrest all growth, darkness will do the plants no harm. Our Calceolarias have seen no light since Monday. It would only be waste of time covering and uncovering in such weather.

In houses great care was taken not to give too much heat, as it would have added still more towards making the air parched, and to water only when needed, and not to spill a drop. Of course where high temperatures are used the moisture must be in proportion.

STOVES.

For a great portion of our readers who have their little gardens that they wish to make the most of, we would say, instead of having so much outside covering for your plants, try and have a little structure into which you can throw a little dry heat, by an iron or brick stove, if nothing better. Than the stove there is no mode so simple and economical for small places. We have already detailed some of our makeshifts with an iron stove we found standing about here, and how it served us in 1860 and 1861. Well, it is at present in a sort of orchard-house 75 feet long, 11½ feet wide, 11 feet high at back, and 3½ feet in front. We had a great many bedding plants in this house, which were not removed in time. Without any protection whatever, this stove, 2½ feet in height, nearly 1½ foot wide—fire-box about 10 inches square—has kept the frost out of this large space. As a precaution the plants were moved from each end, but this does not seem to have been necessary. We need not say that a mere trifle of fuel was used—less than a trifle compared to what would have been needed for a flue or hot water.—R. F.

COVENT GARDEN MARKET.—JAN. 9.

In consequence of the severity of the weather there has been a considerable advance in prices, particularly as regards out-door produce; but the condition of this is much better than could have been expected. Filberts are not now to be had, and Cobs are bringing 90s. to 110s. per 100 lbs. Good dessert Pears are extremely scarce, and soon will be not to be had at any price. Hothouse Grapes have advanced in price, and are in good condition for the season. Pines are sufficient for the demand. Savoy and Brussels Sprouts are in great demand, and the former are now in fine order for the cook. Of Potatoes there is a full supply, and prices remain unaltered. Cut flowers are the same as last week, Chinese Primulas and Early Tulips being more plentiful.

FRUIT.

	s.	d.	s.	d.		s.	d.	s.	d.			
Apples.....	½	6	to	4	0	Mulberries.....	quart	0	6	to	0	0
Apricots.....	doz.	0	0	0	0	Nectarines.....		0	0	0	0	0
Figs.....	doz.	0	0	0	0	Oranges.....	100	4	0	10	0	0
Filberts & Nuts	100 lbs.	0	0	0	0	Peaches.....		0	0	0	0	0
Grapes, Hothouse.....	lb.	6	0	10	0	Pears.....	bush.	8	0	12	0	0
Foreign.....		1	0	2	0	dessert.....	½	sieve	6	0	10	0
Muscats.....		6	0	10	6	Pine Apples.....	lb.	5	0	3	0	0
Lemons.....	100	6	0	10	0	Pomegranates.....	each	0	3	0	0	0
Melons.....	each	3	0	5	0	Walnuts.....	bush.	14	6	20	0	0

VEGETABLES.

	s.	d.	s.	d.		s.	d.	s.	d.				
Asparagus.....	bundle	6	0	to	10	0	Leeks.....	bunch	0	4	to	0	0
Beans, Broad.....	bush.	0	0	0	0	Lettuce.....	score	1	0	2	0	0	
Kidney.....	100	3	6	5	0	Mushrooms.....	pottle	1	0	1	6	0	
Beet, Red.....	doz.	1	0	1	6	Must. & Cress, punnet		0	2	0	0	0	
Broccoli.....	hundle	0	2	2	0	Onions.....	bushel	2	0	4	0	0	
Brussels Sprouts	½ sieve	1	6	2	6	pickling.....	quart	0	6	0	8	0	
Cabbage.....	doz.	0	0	0	0	Parsley.....	bunch	0	6	0	8	0	
Capsicums.....	100	0	0	0	0	Parsnips.....	doz.	0	9	1	6	0	
Carrots.....	bunch	0	6	0	0	Peas.....	bush.	0	0	0	0	0	
Cauliflower.....	doz.	3	0	6	0	Potatoes.....	sack	5	0	8	0	0	
Celery.....	hundle	1	6	2	0	Radishes doz.	bunches	1	6	2	6	0	
Cucumbers.....	each	1	0	3	0	Rhubarb.....	bundle	1	0	0	0	0	
Endive.....	score	1	3	2	6	Savoy.....	per doz.	1	6	3	0	0	
Fennel.....	score	0	3	0	0	Sea-kale.....	basket	1	6	2	6	0	
Garlic and Shallots, lb.		0	3	0	0	Spinach.....	sieve	4	0	6	0	0	
Herbs.....	bunch	0	3	0	0	Tomatoes.....	½ sieve	0	0	0	0	0	
Horseradish.....	bundle	1	6	4	0	Turnips.....	bunch	0	4	0	0	0	

TRADE CATALOGUE RECEIVED.

London Seed Company, 68, Welbeck Street, Cavendish Square, W.—General Price Current of Kitchen Garden, Flower, and Farm Seeds, 1864.

TO CORRESPONDENTS.

HOYA CARNOVA DECATINO — MOVING WELLINGTONIA BIANTRA (*Dumbartonshire*).—We think the plant died from the decay of the roots, and the insects now upon them are only feeding on the decaying vegetable matter. We are not quite sure what insect it is; but, from your description, we think they are young woodlice. They are of a reddish colour whilst young, and as lively as red spider. The roots of the plant have been destroyed by a sour soil, imperfect drainage, or too much water with too low a temperature; but this we cannot determine without further particulars. If the ground be very heavy and wet, it is advisable to plant the Wellingtonia on a mound, but on the level if it be light and dry. The Pampas Grass is best planted on the level, and it likes a strong soil. It does well on light soil with a good dressing of manure, and copious waterings with liquid manure whilst growing.

VALLOTA PERPUNEA CULTURE (*W. T. C.*).—This beautiful free-flowering bulb is an evergreen, and should be kept in the light at all seasons. Little water is needed in winter to keep the leaves fresh, and only enough should be given at that season to prevent them from flagging. Keep the plants dry in a well-ventilated greenhouse, and near the glass, until vegetation commences in spring, when abundance of water must be given until growth is completed. After the growth is made, gradually harden or ripen the bulbs by withholding water, which it is necessary to do to insure bloom. Water moderately whilst in bloom, abundantly when growing, and give no more water when at rest than is necessary to keep the leaves from flagging. It should be kept in the pot at all seasons, and at no time can it or any of the family have too much light. It is best to pot it when the strongest growth is attained, and nothing is better for the purpose than rather strong fibry loam, with a little sharp sand intermixed. The heat of an ordinaryinery from March until October is admirably suited to its requirements, and it will take no harm there in winter if the temperature does not fall below 35°. We have had bulbs exposed to 8° of frost (24°), and they were none the worse. They were very dry. We should like to know if this bulb has been found hardy in any part of the British Isles.

PROTECTING BUDDED ROSES (*Q. Q.*).—Should severe weather ensue—say between January and March—it is probable that the buds which are breaking may be injured. A little long coarse hay wrapped loosely over the buds in severe weather will protect them sufficiently. It should be removed in mild weather, but replaced when there is a likelihood of severe frost. Charles Lawson and Comte de Nanteuil are the reverse of shy bloomers. The plants are probably too vigorous, or have been made gross by a rich soil or manure. We advise you to prune moderately, each shoot to, say, four eyes; and if the plants do not bloom profusely in the following season, take them up in November and plant them again. Taking up would check their vigour, and it generally causes vigorous plants to bloom.

STARTING DAHLIAS (*Idem*).—The beginning of March is a good time to place the roots in heat to propagate stock. The cuttings should be taken when the shoots are about 3 inches in length, taking a little of the crown along with them.

STOKESIA CYANEA CULTURE (*Idem*).—It is a fine composite flower of the most lovely blue colour, something in the way of the English Bluebottle (*Centaurea cyanus*), but more resembling that of Chicory (*Cichorium intybus*). It is an evergreen perennial, growing 2 feet high, and is from Carolina. Loam, with a little leaf mould and sand, will grow it to perfection. Its usual time of flowering is August. We are unable to account for your plant not blooming. The cause might be want of water, and too much heat and dryness when the flower-heads appeared. We advise you to plant it out next June in the open border, where, if it flowers, and it should do so in August, not one of the vaunted beauties of the flower garden is more ornamental in its season. It should be taken up in October and wintered like any other half-hardy bedding plant. It is increased by seed sown in March and division of the root, which is best done in spring. We can confidently recommend this plant as being worthy of more general cultivation.

EVERGREENS UNDER CHESTNUT TREES (*G. B.*).—If it were possible to dig the holes for the shrubs amongst or between the Chestnuts, we should prefer that to putting 1 foot of soil upon the border in which to plant the shrubs, and then placing a few inches of fresh soil on the border after the trees are planted. A foot of soil laid on the border would not materially affect the well-being of the Chestnuts nor Thorn hedge, and you may safely follow that plan if it be impossible to adopt the former. It is not, however, an advisable method. We have seen *Berberis aquifolium*, Holly, and tree Box under Chestnuts, but the shrubs most likely to thrive are such as Fly Honey-suckle, Viburnums, Syringa (Lilacs) Cornelian Cherry, and Ribes. Chestnuts have such umbrageous heads that few shrubs can live under them in summer on account of the drought. This may be obviated to a great extent by taking off the lowest branches of the Chestnuts, thus admitting light, air, and rain to the shrubs beneath.

LABELS (*Ashfield*).—It is too much a matter of taste for us to say which are "the best labels for plants." In conservatories and similar structures for plants we have seen white porcelain labels used effectively, but in general the labels had better be less observable. We always employ strips of zinc about three-fourths of an inch wide, writing upon them with the ink which is purposely prepared and indelible.

GRAPES AND CUCUMBERS (*W.*).—The Flame-coloured Tokay is usually called the Lombardy, and is quite different from the White Tokay. The skin of the fruit is pale red, the bunches very large, but it requires for ripening a high temperature. We do not know where Cure's and Hort's Cucumbers can now be obtained. Cuthill's Black Spine and Sion House are the varieties which will suit you. They are of the useful size, about 9 inches long.

DUBLIN (*E. A. P.*).—This Journal can be had at Dublin, either at the railway stations or of Mr. Robertson, bookseller, 32, Sackville Street.

EARLY POTATOES (*Mrs. C., Sidmouth*).—There is no better variety for the earliest crop than the Walnut-leaved Kidney. You may plant during the end of the present month if open weather.

CURRENT FROM MALTA (*W. H.*).—We have little doubt that the Currant sent to you from Malta is really the Black Corinth or Zante Grape, the fruit of which, when dried, are the currants of the grocers' shops. If so, the bunches will not be more than about half the length you mention. That Vine may be grown either in a greenhouse or against a south wall. It has been cultivated in this country many years, but is of little worth as a dessert fruit.

PAMPAS AND ELEPHANT GRASS (*A Subscriber*).—Any London seedsman advertising in our columns can supply you with Pampas Grass seed, and, we think, could obtain for you the Elephant Grass seed.

SEOLINO CINERARIA (*J. P.*).—The colour is very bright, but there are many varieties superior in the points required by florists.

NAMES OF FRUITS (*Marquis*).—Your Apple is a very fine specimen of *Gloria Mundi*. (*Subscriber*).—You have put no numbers on the fruit, and we therefore cannot distinguish one from the other.

NAMES OF PLANTS (*J. P., Eversfield Place*).—*Abutilon striatum*.

POULTRY, BEE, and HOUSEHOLD CHRONICLE.

IRREGULAR ADMISSION TO THE BIRMINGHAM POULTRY SHOW, 1863.

UNDER this heading and at the request of the Secretary of the Birmingham Show, you published, last Tuesday, a statement which is not satisfactory.

If it were, as it is stated there, necessary to admit the reporters for the press on Saturday evening, it was not necessary and it was in every way wrong to admit others. A special ticket would have served this purpose, as it did in the case of the Judges.

The programme of the Meeting distinctly states that the ten-shilling tickets were *not* to admit to the poultry Show during the judging, and the same programme also states that the private view would be on Monday. Saturday evening after the Judges had completed their awards was neither the one time nor the other. It is against consistency and common sense to attempt a justification of what was done.

It would be better that the Committee, through their Secretary, should at once acknowledge an act of unfairness, if the order for admission came from themselves; or if it was the act of an officious committeeman in his individual capacity, they should let the censure fall where it is due.

If it was not an intended accommodation to those who, having had their private view, did not care to remain in Birmingham until Monday, I wish this to be noted—it was a slipshod method of carrying out rules unworthy of any body of men assembled for business.

Either an act of dishonesty on the part of a Judge, or an act of dishonesty on the part of an exhibitor casting suspicion on the Judge, coupled with, to say the least of it, a slipshod act on the part of officials, or an official, involving another exhibitor in a suspicion from which he has been cleared, will make the Birmingham Show of 1863 remembered.

In my last communication I find a sentence in the second and third lines of the second column, where for "were by a like accident to be found," read "were not to be found."—**GEORGE MANNING.**

BUYER AND SELLER.

THIS matter, I think, can be easily settled. Let the buyer turn to the back of a post-office order, and a space will be seen for his name, which, when written, the money cannot be paid for ten days. During the interval the seller sends his goods, and the buyer examines; if not found to his mind, let him return the goods before the order is due, and at the same time protest payment of the order, when the money will be refunded at any office the buyer wishes, less the usual charges.—**THOS. SHORT, Glasgow.**

THE BIRMINGHAM DISQUALIFICATIONS AND MARKING POULTRY.

ON the discussion which has been taking place since the Birmingham Show in the poultry press I had not intended to enter, but several little points have occurred which appear to me absolutely requiring notice. I cannot presume to determine who Mr. Williams, of Welslpool, may be, nor do I know Mr. Hindson; but if these birds are Mr. Hindson's, how comes it that Mr. Williams advertises them for sale as the "disqualified Game birds at Birmingham." Are they his or Mr. Hindson's?

It appears from your last week's paper that these fowls had a mark in the nostril, visible even to persons who were strangers to them, and, as "GAME COCK" remarks, Mr.

Hindson ought to explain how it is that he did not notice it when judging the birds, especially as I always fancied the head of a Game bird is a noticeable point in awarding prizes. Neither were these birds in a single class, and, therefore, somewhat more likely to escape notice.

The question, however, I wish prominently to bring before my brother amateurs is this—*Whether birds marked in this or any other way ought not at once to have been disqualified, because marked?*

Birds marked with string or tape on the legs have frequently been disqualified, although it might have been accidental. Now, it appears to me that a small mark, as this must have been, is a very dangerous, and, to say the least, very disagreeable matter. One of our poultry Judges may visit a friend's yard, and may notice certain artificial marks on the inhabitants. He recognises these marks at the next show where he judges, and, consequently, he knows their owner. True, it is quite possible they may have changed hands. I have in previous notes on shows expressed my belief that judges, as a rule, judge honestly; but I consider that this system of private marking is open to serious objections and ought to be discontinued by all honest exhibitors. It has no advantages that I can see; for all of us who care for our pets learn to recognise them: why, then, these marks? This Birmingham Exhibition has, I trust, sounded the knell of all private marks.—**Y. B. A. Z.**

PAISLEY COMPETITION OF POULTRY, PIGEONS, CANARY BIRDS, ETC.

THE tenth annual exhibition and competition of the Paisley Ornithological Association was held on the 8th, in a large and commodious building to the west of the town at Woodside.

The following are the awards:—

- SPANISH.**—First and Third, J. C. Wakefield, Eastwood Park. Second, J. Crawford, Beth. Commended, W. McIntyre, Ayrshire. **CHICKENS.**—First, J. B. Kennards, Helensburgh. Second, H. Beldon, Yorkshire. Third, W. McIntyre, Ayrshire. Highly Commended, J. Elseworth, Campsie Junction.
- DORKING (Coloured).**—First and Third, R. Logan, Netherton, Renfrew. Second, J. B. Wakefield. The whole of this class Highly Commended. **CHICKENS.**—First, J. Linnings, Glasgow. Second, J. Elseworth, Campsie Junction. Third, A. Cunningham, Craigends. Highly Commended, T. Barrowman, Cumnock. Commended, H. Heys, Barrhead.
- DOUGALS (White).**—First, A. Russell, Paisley. Second, J. Walker, Paisley. Third, H. Young, Bishopston.
- CHINESE, OR BRAHMA POULTRY.**—First, J. C. Wakefield, Eastwood Park. Second, A. Mitchell, Paisley. Third, T. Barrowman, Cumnock.
- OLD SCOTCH BRED.**—First, S. Young, Neilston. Second, J. Paul, Glasgow. Third, J. Burner, Paisley.
- HAMBURGERS (Golden-spangled).**—First, J. Green, Cross Arthurlie, Barrhead. Second, J. Reid, jun., Kilwinning. Third and Highly Commended, R. Cunningham, Stewarton.
- HAMBURGERS (Golden-pencilled).**—First, J. McInnes, Paisley. Second, J. Lindsay, Stewarton. Highly Commended, J. McInnes. Commended, T. Neilson, Stewarton.
- HAMBURGERS (Silver-spangled).**—First, A. Rennie, Paisley. Second, J. McInnes, Paisley. Third, H. Heys, Springfield, Barrhead. Highly Commended, A. Yuill, Airdrie. Commended, A. Glen, Eskdale.
- HAMBURGERS (Silver-pencilled).**—First, R. Cunningham, Stewarton. Second, A. Yuill, Airdrie. Third, H. Beldon, Yorkshire.
- TOFFED POLANDS (Any colour).**—First, A. Yuill, Airdrie. Second, R. Murdoch, Kilsyth.
- GAME (Black-breasted, and other Reds).**—First, T. Clark, Glasgow. Second, W. Martin, Barrhead. Highly Commended, J. H. McNab, Barrhead. Commended, H. Beldon, Yorkshire.
- GAME (Any other colour).**—First, T. Clark, Glasgow. Second, J. Kiog, Paisley. Third, J. H. McNab, Barrhead. Highly Commended, J. Green, Barrhead. Commended, J. Dunlop, Ayr.
- GAME BANTAMS (Any colour).**—First, J. Green, Cross Arthurlie, Barrhead. Second, W. Martin, Barrhead. Third, J. Green, Barrhead.
- BANTAMS (Golden or Silver).**—First, J. Taylor, Barrhead. Second, J. Green, Barrhead. Third, J. Reid, Paisley.
- BANTAMS (Any other kind).**—First, A. Grant, Kilbarchon. Second, P. Allan, Kilburnie. Third, A. Anderson, Paisley. Commended, J. Gilmour, Fulbar; J. Green.
- CROSS BRED (Or any other not included in the above).**—First, W. White, Paisley. Second, J. Lindsay, Stewarton. Third, J. C. Wakefield.
- DUCKS (Aylesbury).**—First, J. C. Wakefield. Second and Third, H. Heys, Springfield, Barrhead. Highly Commended, J. Stevenson.
- DUCKS (Any other kind).**—First, A. Cunningham, Craigends. Second, and Commended, A. Grant, Craigends.
- SINGLE COCKS.**
- SPANISH.**—Silver Medal and Prize, J. B. Kennards, Helensburgh. Highly Commended, H. Beldon, Yorkshire.
- DORKING.**—Silver Medal and Prize, J. Linnings, Glasgow. Highly Commended, W. Bowley, Gloucestershire.
- HAMBURGH (Spangled).**—Silver Medal and First, A. Rennie, Paisley. Second, J. Green, Cross Arthurlie, Barrhead.
- SCOTCH GREY.**—Silver Medal and First, S. Young, Neilston. Second, W. Thompson, Glasgow.

HAMOTRON (Pencilled).—Silver Medal and Prize, J. M'Innes, Paisley. Highly Commended, J. Lindsay, Stewarton.
GAME (Any colour).—Silver Medal and Prize, W. Martin, Barrhead. Highly Commended, T. Clark, Glasgow.

PIGEONS.

POWTERS (Any colour).—First, Second, and Third, J. Miller, Glasgow.
CARRIERS (Any colour).—First and Second, J. Miller. Third, J. Sharp, Johnstone.
FANTAILES (Any colour).—First, J. Miller. Second, J. Taylor, Johnstone. Third, J. Grey, Kibbarchan.
BUFFS (Any colour).—First, J. B. Rennards, Helensburgh. Second, A. Mitchell, Paisley. Third, W. Neilson, Johnstone.
TUMBLERS (Short-faced).—First and Second, M. Stewart, Glasgow. Third, H. Beldon, Yorkshire.
TUMBLERS (Any other kind).—First, J. B. Rennards. Second and Third, J. Sharp, Johnstone.
ANY OTHER DISTINCT BREED.—First, J. Miller. Second, J. Sharp. Third, W. Neilson, Johnstone.
COMMON PIGEONS.—First, R. Stirrat, Paisley. Second, J. Wilson, Paisley. Third, M. McDonald, Johnstone.
 Silver Medal given for the best three pairs of Fancy Pigeons, the first five classes excluded.—Prize, J. Miller, Glasgow. Commended, H. Beldon, Yorkshire.

CANARIES.

YELLOW COCK.—First, T. Buchanan, Glasgow. Second, W. Paterson, Glasgow. Third, R. S. Wylie, Paisley. Fourth, J. Sieverwright. *Hen*.—First, J. Adam, Paisley. Second, R. M'Millan, Stevenston. Third, P. Horsburgh, Kilmarnock. Fourth, G. M'Alpine, Rentview.
BUFF COCK.—First, A. Mitchell, Paisley. Second, J. Kelly, Johnstone. Third, A. M'Gulvray. Fourth, A. Brown, Stewarton. *Hen*.—First, J. Taylor, Glasgow. Second, T. Buchanan, Glasgow. Third, R. S. Wylie, Paisley. Fourth, J. Wilson, Galston.
PIEBALD YELLOW COCK.—First, J. Watson, Paisley. Second, H. Fisher, Glasgow. Third, R. S. Wylie, Paisley. Fourth, A. Reid, Paisley. *Hen*.—First, P. Allan, Kibbarchie. Second, J. Fulton, Beith. Fourth, J. Kirkland, Beith.
PIEBALD BUFF COCK.—First, J. Slater, Paisley. Second, G. Hamilton, Beith. Third, J. Brown, Paisley. Fourth, H. Webster, Kibbarchan. *Hen*.—First, R. White, Paisley. Second, P. Allan, Kibbarchie. Third, P. Horsburgh, Kilmarnock. Fourth, J. Kirkland, Beith.
YELLOW GOLDEN PENE COCK.—Prize, H. Cunningham, Stewarton. *Goldfinch*.—A. Hunter, Paisley. *Bullfinch*.—S. Mason.
 A Silver Medal, for the Best Pair of Canary Birds, the same to be Yellow Cuck and Buff Hen, or Buff Cuck and Yellow Hen.—First, J. Taylor, Glasgow. Second, R. S. Wylie, Paisley.
 A Fancy Cage, for the Best Pair of Piebald Canaries, the same to be Yellow Cuck and Buff Hen, or Buff Cuck and Yellow Hen.—First, R. S. Wylie, Paisley. Second, J. Fulton, Beith.

EXHIBITION OF THE ABERDEENSHIRE ASSOCIATION

FOR IMPROVEMENT OF DOMESTIC POULTRY.

This Association's third Annual Show was held on the 31st of December and following day. Tested by either numbers or quality, it is a very excellent one. The entries of poultry are 250, which is an advance of 100 upon the entries in the same department for last year. And if we compare the merits of the birds shown with those brought forward three years ago at the first show, the advance made by the Association is seen to be very marked indeed. Then in many of the classes, birds that had little to recommend them but mere bulk of carcase, were thought worthy of being brought into competition. Such matters as matching of pairs, and the "points" that really decide a fowl's position in the judgment of the connoisseur, were but little attended to. Now ill-matched birds are the exception.

We do not by any means say, however, that the amateur breeders in this locality have reached the point even yet at which they ought to aim; a glance at the prize list will show that southern exhibitors have proved rather heavy opponents for them. Of course the disadvantages in climate are greater here, but we have no doubt that such breeders as Messrs. Taylor, Hay, Pope, and others, will, as they have done hitherto, in future years take equally prominent places against all comers.

With respect to the different classes, *Dorkings* were considered the best show; this useful variety making really a capital appearance. *Spanish* were a very good show, and the silver cup was taken by Mr. Beldon, Yorkshire, with a very fine pen—the broad white face of the cock, and his strong, erect, and serrated comb giving a good sample of what should be aimed at; the only local exhibitor successful in this class was Mr. Taylor, who stood third with a very good pen. The *Cochins* were a decided improvement upon former shows; the defect in the show to critical eyes was the prevalence of twisted combs upon the male birds; the comb in this variety should be small and perfectly straight. *Game* birds were a good show comparatively; as were also the *Han-*

burghs; and *Polands* were very good. The *Brahma Pootras* were a fair show.

Geese were capital, especially the three prize pens; and the *Aylesbury Ducks* were first-class—up even to the Yorkshire standard, which is perhaps the highest in the kingdom.

The prize *Turkeys* were also magnificent birds.

The collection of *Pigeons* and *Canaries* is a very fine one—considerably in advance of last year, and includes some valuable birds, if we may speak by the catalogue, where we find the modest price of £100 attached to each pair shown by Mr. Jobling.

The arrangements of Mr. S. Pope, the courteous and active Secretary, and the other gentlemen of the Committee, were every way excellent.

SPANISH.—First, Miss B. Redpath, Edinburgh. Second, W. Bruce, Perth. Third, G. Taylor, Inverury. Highly Commended, Mrs. L. Carnegie, Redhall. *Chickens*.—First and silver cup, H. Beldon, Bradford. Second, W. Meff, Aberdeen. Third, Miss B. Redpath. Very Highly Commended, W. Hay. Highly Commended, Mrs. Blair, Kepplestone; Mrs. J. Wallace; G. Taylor.

DORKINGS.—First, and winner of ease of birds as the best pen of Fowls in the Exhibition, Lord Kinnaird, Inchtute. Second, J. Gordon, Ruthrieston. Third, Mrs. L. Carnegie, Fordoun. Very Highly Commended, L. Chalmers, Frasersburgh. Highly Commended, A. F. Williamson, Blackburn; J. Anderson, Meigle. *Chickens*.—First, J. Anderson, Meigle. Second, A. F. Williamson. Third, Mrs. Black. Very Highly Commended, J. Anderson. Highly Commended, G. Taylor; R. Walker. Commended, Lord Kinnaird, Inchtute; J. Wilson, M.D., Oldmeldrum; Mrs. Ironside, Keith Hall.

COCHIN-CHINA.—First, G. Murray, Aberdeen. Second and Third, Mrs. Pyper, Belhelvie Village. *Chickens*.—First, Third, and Highly Commended, G. Murray, Aberdeen. Second, S. Pope.

GAME.—First and Third, J. Anderson, Meigle. Second, H. Beldon, Bradford. Very Highly Commended, W. Hay, Aberdeen. Highly Commended, W. Hay; J. Morrison, jun., Perth. *Chickens*.—First, J. Anderson, Meigle. Second, H. Beldon, Bradford. Third, W. T. Hay, jun. Highly Commended, Mrs. Beane, Aberdeen; W. Cruickshank, Woodside. Commended, Mr. Rennet.

HAMBURG (Silver or Golden-pencilled).—First, W. Meff, Aberdeen. Second, Miss E. E. Wallace. Third, Miss E. Wallace. Highly Commended, Miss E. E. Wallace.

HAMBURG (Gold-spangled).—First, H. Beldon, Bradford. Second, W. Hay, Aberdeen. Third, J. Thom, Culsh. Commended, A. Smith, Belhavie.

HAMBURG (Silver-spangled).—First, H. Beldon. Second, J. Milne, Port-Elphinstone. Third, W. Meff.

POLANDS (Any variety).—First, Second, and Third, H. Beldon. Highly Commended, Mrs. W. Pyper.

BANTAMS (Any variety).—First, W. J. Routledge, Aberdeen. Second, H. Beldon, Bradford. Third, Mrs. Forbes, Strathdon. Highly Commended, J. Anderson, Meigle; J. M. Hay, Aberdeen.

BRAMA POOTRAS.—First, Lord Ross, Inchtute. Second, Mrs. J. H. Barclay, Kinross. Third, Mrs. L. Carnegie, Fordoun. Highly Commended, Mrs. Forbes, Strathdon. Commended, Mrs. J. H. Barclay.

ANY OTHER BREED.—First, H. Beldon, Bradford. Second and Third, Mrs. L. Carnegie. Highly Commended, Mrs. L. Carnegie.

GESE.—First and Second, Lord Kinnaird, Inchtute. Third, A. Paterson. **DUCKS** (Aylesbury).—First and Third, Lord Kinnaird, Inchtute. Second, W. Forbes, Pitcairnie. Highly Commended, Mrs. L. Carnegie; Mrs. J. Wagstaff, Huntly; Miss J. W. Ogilvy, Meigle; F. W. Gray, Aberdeen. Commended, Mrs. J. Wagstaff.

DUCKS (Any other variety).—First, H. Beldon, Bradford. Second, J. Anderson, Meigle. Third, G. D. Crab. Highly Commended, J. Anderson.

TURKEYS (Any variety).—First, Lord Kinnaird, Inchtute. Second, Mrs. M. Stronach, Sunnybank. Third, Mrs. L. Carnegie. Highly Commended, Mrs. L. Carnegie; Mrs. J. Wagstaff.

SPANISH COCK.—First, A. Smith, Belhavie. Second, J. Reid, Fyvie. Third, G. Taylor, Inverury.

DORKING COCK.—First, W. Meff, Aberdeen. Second, Mrs. J. H. Barclay, Kinross. Third, A. F. Williamson, Blackburn. Highly Commended, R. Walker, Portiethen; J. Gordon, Ruthrieston.

GAME COCK.—First and Third, Mrs. Rennet, Aberdeen. Second, M. Seton, Uddry.

BRAMA POOTRA COCK.—First, L. Chalmers, Frasersburgh. Second, A. B. Milne. Third, W. Forbes, Pitcairnie.

HAMBURG COCK.—First, W. Meff, Aberdeen. Second, J. Thom, Culsh. Third, Mrs. Rennet.

SELLING CLASS (Any breed).—First, W. Bruce, Perth. Second, Mrs. Barclay. Third, J. Kiach. Commended, Mrs. Rennet; J. Anderson; W. Meff, Aberdeen.

PIGEONS.

TUMBLERS.—First, H. Beldon, Bradford. Second, M. E. Jobling, Newcastle. Third, J. Tocher, jun. Very Highly Commended, J. Gabb, Willowbank.

FANTAILES.—First and Second, M. E. Jobling, Newcastle. Third, J. Simpson, Duffris. Very Highly Commended, J. Simpson.

POWTERS.—First and Second, J. Hay, Guestraw. Third, J. M'Donald, Aberdeen. Very Highly Commended, J. Hay. Commended, F. M'Crac.

CARRIERS.—First and Second, F. M'Crac. Third, J. M'Donald, Aberdeen. Very Highly Commended, J. Tocher, jun.

BUFFS.—First, J. Hay, Guestraw. Second, M. E. Jobling, Newcastle. Third, J. M'Donald, Aberdeen. Commended, J. Blacklaw.

ANY OTHER VARIETY.—First and Commended, W. Kezin.

CANARIES.

YELLOW BELGIAN COCK.—First, T. M'Avish, Aberdeen. Second, W. Donald, Manohfield. Third, A. Donald, Manohfield. Very Highly Commended, S. Wilson, Aberdeen. Highly Commended, J. Hunter, Belverne, Harrogate. Commended, G. Clark. *Hen*.—First and Second, W. Donald, Manohfield. Third, A. Donald, Manohfield. Very Highly Commended, W. J. Routledge, Aberdeen. Highly Commended, W. Wilson, Aberdeen. Commended, J. M'Andrew, Aberdeen.

YELLOW COCK (Bird of 1863).—First and Winner of Silver Medal as

the best Yellow Canary in the Exhibition, W. Garden, Aberdeen. Second, J. J. Garsen, Aberdeen. Third, W. Jamieson, Aberdeen. Very Highly Commended, W. Wilson, Aberdeen. Highly Commended, W. Donald, Mannofield. Commended, J. Hunter, Hardgate. *Hen.*—First, S. Wilson, Short Loanings. Second, W. Ogilvie, Cato Square. Third, J. Hunter, Hardgate. Very Highly Commended, J. McDonald, Lodge Walk. Highly Commended, J. M'Andrew, College Street. Commended, W. Wilson, Causewayend.

BUFF BELGIAN COCK.—First, W. Donald, Mannofield. Second, K. Campbell, Chapel Street. Third, W. J. Routledge, Gallowgate. Very Highly Commended, W. Garden, John Street. Highly Commended, J. M'Andrew, College Street. Commended, A. M. Mackie, City Hotel. *Hen.*—First, T. M'Tavish, Gilcomston. Second, W. Jamieson, Catto Square. Third, W. Wilson, Causewayend. Very Highly Commended, K. Campbell, Chapel Street.

BUFF BELGIAN COCK (Bird of 1863).—First and Winner of the Silver Medal as the best Buff Canary in the Exhibition, Second, and Third, J. J. Garden, John Street. Very Highly Commended, W. Donald, Mannofield. Highly Commended, W. Routledge, Gallowgate. Commended, W. J. Routledge. *Hen.*—First, S. Wilson, Short Loanings. Second, A. Wilson, Crooked Lane. Third, W. Wilson, Causewayend. Very Highly Commended, A. Donald, Mannofield. Highly Commended, A. Donald.

FLECKED BELGIAN COCK.—First, M. Skinner, Canal Road. Second, J. Falconer, North Broadford. Third, J. Edwards, Union Place. Very Highly Commended, J. Milne, Aberdeen. Highly Commended, J. Guthrie, Canal Road; J. Leeds, Rosemont Place. *Hen.*—Very Highly Commended, A. Middleton, Causewayend. Highly Commended, A. Wilson, Crooked Lane.

FLECKED BELGIAN COCK (Bird of 1863).—Very Highly Commended, J. Falconer, North Broadford. Highly Commended, M. Skinner, Canal Road; A. Wilson, Crooked Lane. *Hen.*—First and Winner of Silver Medal as the best Flecked Canary in the Exhibition, A. Middleton, Causewayend. Second, R. Buist, Albion Street. Third, K. Campbell, Chapel Street. Very Highly Commended, A. Wilson, Crooked Lane.

MULE.—First, A. M. Mackie, Aberdeen. Second, W. Garden, John Street. Third, J. Hunter, Hardgate. Very Highly Commended, W. Srell, Hanover Street. Highly Commended, A. Middleton, Causewayend. Commended, J. J. Garden, John Street.

FOREIGN BIRDS.—Prize, D. Baillie, Chapel Street.

The sole Judge for the poultry was Richard Teebay, Esq., Fulwood, Preston, Lancashire. Mr. Teebay's awards, so far as we have heard, have given general satisfaction; and we have based our remarks on his expressed opinion of the Show. The Judges for Pigeons and Canaries were Messrs. A. Gloag, Dundee; R. Sim, sen., Woodside; and A. Barnett, Aberdeen.—(*Aberdeen Free Press.*)

THE NATIVE HONEY BEE OF AUSTRALIA.

I AM indebted to Mr. F. Smith, President of the Entomological Society, for the following description of the native Australian honey bee, a nest of which reached me through the kind offices of Messrs. Veitch, of Chelsea. Although the bees were alive when shipped from Brisbane, in Queensland, but had evidently perished long before the termination of their voyage. This fatal result is the less to be regretted, since it is perfectly evident that their powers of honey-gathering are perfectly infinitesimal as compared with those of either the English or Italian races.—A DEVONSHIRE BEE-KEEPER.

“NOTES ON THE ECONOMY OF TRIGONA CARBONARIA, A STINGLESS HONEY BEE OF AUSTRALIA, WITH A DESCRIPTION OF THE INSECT AND ALSO OF ITS NEST.

“The beautiful example of insect architecture received from Brisbane, in Queensland, Eastern Australia, is specially interesting. Judging from its structure, it apparently indicates the economy of a genus of bees intermediate between the live bee and the well-known humble bees.

“Hitherto we have possessed very little information respecting the economy of the genus *Trigona*. The females are unknown; the other sexes—male and worker—have been received from Brazil. The closely-allied genus *Melipona* includes, in the opinion of some authors, the species that I separate and retain in the genus *Trigona*. Of the former genus we possess a knowledge of all the sexes, and have ascertained that each community contains a number of females, in which part of their economy they agree with the humble bee. We may, therefore, expect to find the economy of *Trigona* similar in that respect; such, I have little doubt, will prove to be the case. On examining the nest from Brisbane we observe another particular in which the economy of the species agrees with the genus *Bombus*. Numbers of semiglobular receptacles for honey are found, some placed side by side, others over each other, and some suspended in the ramifications of the coral-like-shaped branchings constructed over and above the proper nest, that which contains the combs of the hive. These receptacles may appropriately

be called honey-pots, and serve, I have little doubt, to contain all the honey collected for the requirements of the hive, no honey, as far as I can ascertain, being stored in the cells of the combs, these being apparently appropriated solely to the rearing of brood.

“On making an opening at the back of the box that contained the nest, and against which it was built, a sight of the combs was obtained. They proved to be arranged horizontally, with the mouth of the cells downwards, as in the combs of wasps. The arrangement of the combs, however, cannot be compared in regularity and beauty with that of the wasp, some being oblique, and the spaces between the combs are irregular in width. In fact, the nest is a rude and imperfect imitation of the symmetrical beauty of the nest of the wasp.

“No sign of honey in, or of there having been any in, the cells could be traced. All appeared to be appropriated to the rearing of brood. Such I also found to be the case in a large mass of comb from Panama. Much still remains to be learnt respecting the economy of these bees. The nest from Brisbane has thrown much additional light upon the subject, and will, I trust, stimulate entomologists who visit countries where the genus *Trigona* is found to investigate thoroughly the economy of these bees. All that is at present known amounts to little that is satisfactory, being principally founded upon conjecture.

“The nest of the *Trigona* from Brisbane cannot be looked upon as a perfect example of the structure usually built by that species. It was constructed in a situation forced upon the bees; consequently, they had to contend with the difficulties of the situation.

“The form of that part of the nest which contains the combs is that of half a fir-cone, the flat side being placed against the back of the box. The external surface is very irregular, and consists of a multitude of flat overlapping layers, some of the larger ones being upheld in their position by upright supports or columns. Branching off in various directions from the external plates is an intricate ramification closely resembling the roots of shrubs or plants; or perhaps most like the beautiful branching of some corals. As the nest is increased in bulk in the process of building, the flat layers described serve as the foundation whereupon to construct cells. Some of the honey-pots previously mentioned are suspended on the branches above the nest, but the majority are constructed in heaps, frequently over each other, at the base and outside of the proper nest; others in more regular order side by side. An orifice is always to be found on one side, enabling the bees to obtain the honey stored in each. The general colour of the nest is a reddish-brown. A portion of the old nest, taken with the bees and placed in the box, is nearly black.

“The *Trigona carbonaria* is a small bee, smaller than the house fly. It is coal-black and shining; it has on its face, on the thorax beneath and at its sides, a covering of very fine short down or pile. The tips of its jaws are obscurely reddish, the wings are clear and transparent, and the abdomen is glossy black.—F. SMITH.”

FOUL BROOD.

(Concluded from page 27.)

As it is very desirable to have the opinions of apiarists so experienced as the gentleman before referred to, I hope I shall be excused for the following quotation I make from a communication lately received from him on the foul-brood controversy. He writes me, “I know quite well the meaning you attach to foul brood, and I am at one with you in almost all the doctrines you hold on the subject. I should like to know in what way, or on what ground, Mr. Woodbury characterises this as a disease among bees. When it begins to manifest itself are the bees so paralysed as to do nothing to arrest its progress? It is said bees can remove foul brood, how then does it spread so as to destroy the hive? Foul brood, in my opinion, is caused very often in hives that have little or no honey in this way:—There is a favourable spring, the queen is a prolific one, the bees are numerous. The combs begin to be well filled with brood in all stages. A change of weather takes place,—rain, damp, and cold. The bees are confined, it may be for a month. They have no

honey, and no food can they get for the young, and besides they give up all attention to them. The young larvae die for want of food, and the sealed maggots die from the reduced temperature of the hive. In this way a hive perishes." I have alluded to weather influences of this kind in a variety of instances, in No. 125, page 139. I make one more quotation "Foul brood," he writes "is often produced by driving. I can speak authoritatively on this point, and I believe, or rather I know from experience, you may give such a hive a change of queen or supplement them in any way you choose, the bees will never prosper nor clear out the abortive brood created in such a case. Some of my hives that died abandoned in masses of foul brood, and I am decidedly of opinion that this was the cause of their ruin."

I have dwelt thus particularly on those cases in which foul brood is originated from experimenting, because it was in reference to such circumstances that I at first alluded to it; but that it arises from kindred influences being brought to bear upon the young brood from purely natural causes I have also pointed out, as I said before, at page 139; but inasmuch as my own experience and observations go to warrant the expression which I used, that "after all foul brood will be found to manifest itself generally in the hands of the experimentalist," which expression is being considered by some to mean more than was intended, or the words under the circumstances warrant, I am, nevertheless, still inclined to believe that this great evil will be apt to manifest itself more frequently, other circumstances being alike, in such hands than in others.

Mr. Woodbury at the conclusion of his article, No. 141, page 464, taxes me with the habit of carefully ignoring all evidence and facts which militate against my own theories and opinions, and he recalls a few of my fallacies, and the evidence by which they have "been demolished." The indictment preferred against me is composed of three counts, and I have to deal with some half dozen witnesses who have given adverse evidence on each. I have already explained the meaning I attach to the three statements alluded to, but I must not allow the form in which I used them to be in the least degree altered. No. 3 count, "Chilled brood is not removed by bees," is incorrect. I said that "decayed and abortive brood in all stages are not removed by the bees." Perhaps Mr. Woodbury does not mean what may be implied in this curtailment of the expression; at all events I must insist that it remain intact to prevent any doubt as to my meaning. "Chilled brood" is susceptible of more than one interpretation, "decayed and abortive brood" is not. Even "decayed and abortive brood" when not connected with the important adjunct "in all stages" would fail to indicate the views I meant to convey in the statement made.

I have already been represented by some as treating foul brood as a disease, notwithstanding the plainest language, and now I am called upon to alter the terms of my proposition as to the removal of brood. We must not now either alter the terms or change the meaning of words regarding which we have had a common understanding. My statement is, "Decayed and abortive brood in all stages are not removed by the bees."

Now, with regard to some of the gentlemen named as evidence against me, we have only their simple assertion to the contrary, supported by no evidence and based upon no facts. I should like much to have "B. & W.'s" opinion, and the results of his experience fully stated on this matter. The two instances brought forward by Mr. Woodbury and Mr. Edwards are not exactly the kind of evidence I should desiderate, the whole circumstances attending these are different from the cases in reference to which I made the statement. Besides, it will be seen by referring to No. 125, page 139, that I, at the outset, admitted that "the more advanced pupæ can remain for a considerable time uninjured in such circumstances," but took exception to the tender larvæ and the newly sealed grubs. I know well what bees can do sometimes in the way of removing half-chilled or simply injured brood of a certain kind, as well as the comb altogether when necessary. Indeed, in the former case, they are assisted by a wonderful instinct on the part of the injured or neglected pupa impelling it in such circumstances to its utmost exertions to quit the cell and make towards the outlet of the hive. I speak of the nearly-matured pupa which cuts through the cover of its cell and escapes in such

circumstances. All this is in strict accordance with that wise arrangement in nature which provides that deformed, injured, or physically imperfect bees, being of no use in a hive, are by universal custom expelled from the colony. In the removal of drone brood also the same principle is generally observed. At the very time when adult drones are being starved and massacred, I have observed the young grubs liberally fed; but when they reached the advanced pupæ state and were ready to emerge from the cells, then the bees by the simple process of withholding nutriment as the cells were opened, induced the bees to voluntarily escape. It is only when very unfavourable outward circumstances of scarcity press hard upon the bees that any of the younger pupæ even are disturbed. Certainly they prefer to have the assistance of natural instinct to force. But the circumstances under which these and similar ejections are made, are totally different from the circumstances of a hive in which decayed and abortive brood in all stages find a place as explained by me. The removal of decayed and abortive brood is quite another thing from that of live or fresh brood.

If I am asked to account for other gentlemen's experiments because they appear to be different in results from my own, I must beg to be excused. All I can do is to give my own experience in the matter and leave others to judge according to their knowledge. As I said before, this is a question of experience alone, and I wish it to be tested by experience; but inasmuch as a universal negative is always more difficult to prove than a particular affirmative, the various proofs I have given of my assertion that bees do not remove decayed and abortive brood in all stages in the circumstances detailed, must not be set aside by one or two opposing and isolated cases of an abnormal and different character.

But let us examine the cases cited by Mr. Woodbury and Mr. Edwards at pages 342 and 382, to show that bees do remove decayed and abortive brood. Though these are somewhat similar to each other in respect that the brood-combs are represented as being all chilled, yet they show a great dissimilarity in results. This circumstance throws some little doubt upon the accuracy of the observations. In Mr. Woodbury's case, the comb inserted in one of his hives was "crammed" with "chilled and abortive brood in all stages (principally sealed)." From this comb, he says, the bees "dragged out every defunct embryo," and then adds, "A few of the younger ones, were, I believe, even hatched after all this neglect." Hatched! after the larvæ had become chilled and abortive? Can this be? In Mr. Edwards's case, also, it was "a whole hive of chilled brood," and yet the reverse of all this took place, "only the most advanced of the brood came to maturity, as did also the eggs. The rest, by far the greater part, perished and were carried out by the bees very gradually. Some remained in the cells till shrivelled up to a mere skin, but were ultimately removed when the colony got stronger." Now, in answer to all this, I must simply refer to the results of my own experience in the cases already detailed by me, and count the opinions and judgment of all practical apiarians who may have tested this matter themselves, and say how far they coincide with me in the general accuracy and truth of my statement that "decayed and abortive brood in all stages are not removed by the bees."

We all know the instinctive disposition which impels bees to remove everything of an obstructive or noxious character from the hive when they possibly can, and when not able to extrude any decayed putrescent body—as in the well-known case of the dead snail—they have recourse to the only alternative left them—to lessen as much as possible all evil results, which also they adopt in the case of foul brood of a certain kind, they cover up or seal over what they cannot remove.

But I have to deal with other evidence in this controversy, which Mr. Woodbury has again and again reminded me of having ignored, and I am necessarily constrained to advert to it. Foremost among the witnesses arraigned against me who have spoken out is Mr. Shearer, whom Mr. Woodbury looks upon as his strongest ally, as he has produced him as a witness in every count of the libel already referred to in page 464, to which my particular attention is accordingly directed. Now, as Mr. Shearer, I find, has actually written his article (No. 127, page 182) in some measure for the especial benefit and "information of Jonas Jackson and Mr.

Lowe," it is but very natural that I, as a party interested, and as Mr. Woodbury suggests, should see what this witness has got to say. When I read that article, I must confess I could not help feeling that it looked altogether very much like a romance, written in the light of certain experiments made by Mr. Woodbury as to foul brood; while Jonas Jackson himself is almost eclipsed by the wonders narrated in it. Mr. Shearer says—"I had a bar-comb of brood lately, in all stages, which fell out while handling it. I put the comb into a vinery on a shelf, where the temperature would be as low as 50° at night, with full air on night and day." Regarding this comb he tells us that, "I used to amuse myself by feeding the young grub with a little honey and bee bread mixed, putting it into the cells on the point of a piece of straw. These grubs lived for two weeks, and at last came out of the cells altogether, crawling about on the shelf till they died*"; and numbers of the young bees which were newly sealed-up when put into the vinery, eighteen days afterwards, ate themselves out of the cells." Now, there must be a mistake here; Mr. Shearer must, I think, have been misunderstood by the printers. Then as to the "five cases" which are given as "undoubted facts" and as tending to show that foul brood is a disease, I do not consider that, if rightly understood, they would prove anything of the kind.

It will be observed that the whole details occurred not in his own apiary but in that of his neighbour, who was dubbed the "Professor," on account of "his knowledge of bees and their habits." "I am compelled, therefore (says Mr. Shearer), to give his experience (the Professor's) on foul brood, as it bears much against Mr. Lowe and his theory, and may be useful to bee-keepers." This being premised, Mr. Shearer, apparently as the Professor's amanuensis, proceeds to narrate the five cases above referred to, all tending, "along with Mr. Woodbury's experience," to prove that foul brood is a disease. Now, I have little faith in observations of this kind which come to me at second hand. I would infinitely prefer five minutes conversation with the Professor himself as to his views and doings, than the most lengthened exposition of these by the hands of another. I should like to know what this said Professor's course of proceeding really was with respect to his bees. He was an experimentalist too in his own way. He adopted various processes of driving, cutting combs, uniting swarms, lodging his bees in old hives, sometimes full of comb, sometimes not. I should desiderate more particulars as to all this. Moreover, I should like to know the Professor's own candid opinion during these ten long years, as to what he attributed these evils which so afflicted his bees. No doubt he had his own views, though "he read few if any books on the subject." The only glimpse we have of the Professor's views from Mr. Shearer in detailing the five cases (with the exception of a remark made in case 4th as to "robbing"), occurs at page 181, in these words, "I believed it to be caused by chill (says Mr. Shearer) to the young brood. My neighbour, however, would never admit it, having tried plan after plan to get clear of it, and all had failed." We are told the Professor "would not admit it," then why not tell us what he did admit? Towards the close of his article Mr. Shearer proceeds to say, "I had a bar-comb of brood lately in all stages, which fell out whilst handling it. I might have fixed it again, but my neighbour (the Professor) being with me at the time, urged me not to do so (why?) as the brood might get chilled, and so propagate the disease among mine." And so, Mr. Shearer, in deference to the Professor's views, put the said comb containing brood in all stages on the vinery-shelf instead. Is this the evidence Mr. Woodbury accuses me of "ignoring?" Why, this witness has evidently been put in the "wrong box!" He is most assuredly mine. It is clear he renounces Mr. Woodbury's theory. He says to Mr. Shearer, nay, he urges him, showing the intensity of his convictions, not to put the bar-comb in question into his hive, "as the brood might get chilled and so propagate the disease." Well done the Professor! I must claim this witness.

Mr. Shearer must not feel offended because I have thus dealt with evidence which Mr. Woodbury has taxed me with ignoring. The value of an experiment must always depend upon the accuracy of the observations and the knowledge of the operator. All second-hand information of this kind,

therefore, must be received according to what it is worth. If Mr. Shearer would confine himself, as he promises in his last paper, No. 143, page 503, to his own experience, which he has now an opportunity of doing in regard to foul brood (it having at last appeared in his own apiary), his evidence would be useful and satisfactory.

Another instance is furnished by Mr. Shearer in the paper above alluded to, of the evil of receiving second-hand information of this kind. I refer to the hive which had been supplied with the bees of three separate stocks, and with 23 lbs. of honey and sugar during some ten days about the beginning of October, and which had, after two or three weeks interval as I read it, "increased 7 lbs. more than the weight of honey and sugar he (his neighbour) gave them, owing to the young brood which she is now rearing." It is evident from the simple perusal of this narrative, that an error has crept in somehow or other. An increase of 7 lbs. of young brood (which in the circumstances may be safely laid down at 10 lbs.), produced in October by a queen which had ceased laying seven weeks before, is certainly most marvellous. I repeat, there must be an error somewhere. At a future time, perhaps, Mr. Shearer will enlighten us on this matter, and explain it more satisfactorily.

I fear little benefit can be derived from microscopic examination of foul brood. No additional light, as it appears to me, has been thrown upon the subject by Mr. Edward Parfitt's report, inserted in No. 138, page 403. The results are such as might be predicted in the circumstances—namely, the discovery of animalcules in the decomposed animal matter called foul brood. The discovery of these animalcules in the honey submitted to him might also be accounted for, though I am inclined to think this may have been a mere accidental circumstance; but in either case I do not see that any light has been thrown upon the general question by these revelations.

I have also had several portions of foul brood in all stages of decomposition subjected to microscopic examination, as also a portion of the honey by which these were surrounded; but the results were different from those of Mr. Parfitt's, showing that animalcules may or may not be found in decomposed young brood.

An eminent professional gentleman did me the favour of undertaking this examination at my request; and after a patient investigation of upwards of an hour, during which we tried and tested a variety of specimens of the decomposed larvæ and other brood from several combs, not the vestige of an animalcule could be discovered in any. The honey and farina also were tried with the same results; but observing some honey in the combs in a state of fermentation, we discovered, on submitting a portion of it to the microscope, innumerable fungi, usually found in all fermented liquors—even the beer we use at table—beautifully dispersed throughout. These dotted the whole area of vision with numberless little globular-looking particles, but the professional gentleman above referred to, did not think that the fungus could have anything to do with foul brood, which, so far as he could understand, was simply decomposed animal matter.—
J. LOWE.

CAPTAIN HEATON'S BUFF COCHINS.—Admirers of this valuable and fashionable breed of fowls will have an excellent opportunity of acquiring birds from this celebrated yard, as we observe from an advertisement that Captain Heaton has decided to send a selection of sixty for sale by auction at Bingley Hall, Birmingham, on Tuesday next. We understand that Mr. R. Adams's entire stock of Partridge Cochins will also be disposed of on the same day.

OUR LETTER BOX.

CREAM (*A Subscriber*).—Your cream needs no test. It is either an artificial compound or the cows from whence it is derived are diseased. The first supposition is probably the truth.

BUTTER NOT FORMING (*J. Simmons*).—We cannot tell what causes your failure. We should churn at from 65° to 70° during this cold weather, keep the dairy at little below 60°, and we should cut the hay and cut-straw into chaff, mixing it with mangold wurtzel sliced.

TOULOUSE GEESSE (*G. A.*).—State fully in an advertisement what you require; or write to some of the owners of this variety who are prize-takers, and ask if they can supply you.

* Surely Mr. Shearer does not mean to say that the larvæ actually underwent the metamorphosis into pupæ without being sealed?

WEEKLY CALENDAR.

Day of M th	Day of Week.	JANUARY 19—25, 1864.	Average Temperature near London.			Rain in last 37 years.	Sun Rises.	Sun Sets.	Moon Rises.	Moon Sets.	Moon's Age.	Clock before Sun.	Day of Year.
			Day.	Night.	Mean.	Days.	m. h.	m. h.	m. h.	m. h.	m. .	m. .	
19	Tu	Skylark sings.	42.7	30.1	36.4	16	58 af 7	23 af 4	52	0	15	4	19
20	W	Robert Sweet died, 1835.	42.3	31.9	37.1	14	58 7	25 4	42	1	9	5	20
21	Th	Sun's declin. 20° 0' S.	43.6	32.3	37.9	16	57 7	27 4	36	2	55	5	21
22	F	Honeysuckle in leaf.	43.5	32.7	38.1	16	55 7	28 4	35	3	34	6	22
23	S	Hazel catkins appear.	44.5	32.9	38.7	16	54 7	30 4	40	4	7	7	23
24	Sun	SEPTUAGESIMA SUNDAY.	44.1	32.6	38.4	18	53 7	32 4	43	5	33	7	24
25	M	PRINCESS ROYAL MAR., 1858. Conversion of St. Paul.	44.4	32.3	38.4	20	52 7	33 4	46	6	37	7	25

From observations taken near London during the last thirty-seven years, the average day temperature of the week is 43.6°, and its night temperature 32.1°. The greatest heat was 60°, on the 19th, 1823; and the lowest cold, 4½° below zero, on the 19th, 1838. The greatest fall of rain was 0.90 inch.

AMARYLLIS CULTURE.

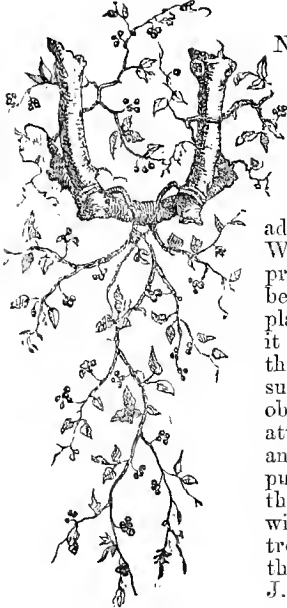

UNDER a gardener of the old school who had grown very many of this beautiful family for ten years of the past, and more than fifty years of the present century, and who had the benefit of the advice of the Hon. and Rev. W. Herbert, I obtained a pretty fair knowledge of this beautiful family of bulbous plants, and I hope to transmit it in an intelligible manner to the many inquirers on the subject in this Journal. My object is not so much to direct attention to the extreme beauty and usefulness for decorative purposes of these plants, for their merits in these respects will be found far more ably treated on in past volumes by the late Mr. Beaton and Mr. J. Anderson, but to give an account of their cultivation.

In the first place, however, I will offer a few hints to intending hybridisers.

The first thing to be done is to throw away all of the "Staghorn" *Hippeastrum aulicum* hybrids, which nobody dare name for fear of being laughed at by a now-almost-past generation of gardeners, and consign the in-and-in lop-eared breed from *H. equestre* to the rubbish-heap. None of these are equal to the species, either in form, substance, or colouring, and the sooner they are discarded the better. The next point is to procure the species, and thus commencing at the right end, we may raise seedlings from the first cross that would beat any seedling at present in cultivation. The Royal Horticultural Society's collector has lately sent home several species from the Brazils, which, aided by private enterprise, cannot fail to call attention to these charming plants, and be the means of their occupying once more the place they formerly held in our stoves and greenhouses, and which they still so justly merit.

Hippeasters are, with a few exceptions, natives of the tropics, but owing to the different elevations at which they are found, some are greenhouse and others stove plants. In their native habitats they are inured to a period of almost continual wet, and undergo a corresponding period of dryness. The heat is most intense when the plants are ripening their bulbs or at rest, and least when making their growth or developing. Under cultivation, they require abundant moisture and nourishment when growing, but after the foliage has attained its full size they require no more water than just suffi-

cient to prevent the leaves flagging. Perfect drainage must be secured. Strong hazel or yellow loam free from iron, with a little sharp sand, is all they need in the way of soil. Leaf mould and other vegetable matter, because it slowly decomposes, is to be avoided. Too much heat when growing is injurious, as it creates drawn foliage and weakens the bulbs. They require as much if not more heat when at rest as when growing; and though this may seem the reverse of good management, it is only what they receive in their native habitats. The roots remain on the bulbs throughout the year; taking them out of the pots when at rest, therefore, robs the bulbs of that which Nature has provided to collect food for the support of the scape of flowers. A practice has lately come into vogue of taking the bulbs out of the pots and storing them away under shelves when at rest, and near to fires, in order to ripen them and economise space. This system renders it necessary to plunge the bulbs in spring, after they have been potted, into bottom heat, so that new roots may quickly be formed to support the bloom-stem, otherwise the scape just peeps from the bulb and causes great disappointment by the number of "blind." Deep, narrow pots, 3 inches in depth, and double the diameter of the bulb, are the best description to grow them in. Frequent potting and plenty of pot room is their bane, and potting a plant of this kind because the pot is full of roots will prevent its flowering. The pot never can be too full of roots, as the bulbs flower all the better for being cramped; and so long as the drainage is perfect and the soil sweet it is immaterial how long the plants are kept in the same soil and pots, if only the offsets are removed and potted, thus preventing their sucking the parent to death.

Having made these general observations, with a view to be better understood, I will now apply them; but to have a starting-point, I will take the bulbs as they now are, at rest, and presume that they have been on a dry shelf in the stove, or in a warm vinery where Grapes are kept until this time, and that they have been kept very dry for the last three months. In January examine the pots and see that the drainage is all right. Having made it perfect replace the ball in the pot, adding a little soil upon the drainage if the plant or bulb be too low, and gently stir the surface of the soil around the bulb, and if any fresh soil be added it should be dry, and the bulb will be none the worse if it be covered to the neck. Some of the tender kinds rot unless the bulb be covered to the neck, as it happens that when the base of the bulb just rests on the soil that very part is at times very wet and then dry, which alternate wetness and dryness rots the base of the bulb, just in the same way as a stake driven into the earth decays more quickly at the surface than at any other part. In looking to the drainage and stirring the surface care should be taken not to injure a single root nor break the ball, for that is robbing the plant of so much absorbent surface, and is a direct way of weakening the bulbs.

The next step is to place the pots on a shelf about 1 foot or from that to 18 inches from the glass, and if the

temperature range from 55° to 60° it could not be better. The situation should be light and free from drip. No water must be given until the leaves appear, for the concentrated juices of the bulb are sufficient without the aid of water, when they must be slightly watered, gradually increasing the quantity as the leaves and scapes elongate. When the scape has risen 6 inches give a plentiful supply of water, and let every alternate watering be weak liquid manure, or, what is safer for an amateur, 1 oz. of Peruvian guano dissolved in a gallon of rain water, and with this water the plant every other day, and the intervening day with pure water. All waterings to be applied a few degrees over rather than a few below the temperature of the house; enough to be given to run through the pot, and if it does not do this without having to stand on the surface, or is a long time in doing so, the soil is either dust dry or sodden, or the drainage is choked. Examination being made, the defect, whatever it be, must be remedied at once. The leaves should not under any circumstances be suffered to flag at this stage, and the atmosphere must be kept moist by syringing night and morning every available evaporating surface with water of the same temperature as the house. Air should be given on all favourable opportunities, but cold currents must be studiously avoided.

When the plants come into flower we have another point to consider. Is the plant wanted for conservatory decoration, or to produce seed? If the first no matter, but if seed be the object it must not move an inch. Remove the anthers of the parent, and keep insects from its stigma. As soon as the stigma becomes viscid choose pollen that has been well aired and from a species or variety likely to give a desirable result, and on a fine sunny morning touch the stigma with the pollen, and something good or bad will be the consequence. The air of the house should be kept rather drier than usual for a few days prior to artificial fecundation, as doing so is very conducive to its success.

The plants must be duly and copiously supplied with water in whatever situation they may be in, and the temperature should never be allowed to fall below 50°, or the check will be such as to injure the growths now making, on which depends the future flowering. Defective seed-pods are often the result of sudden changes of temperature. By June the leaves will have attained their full size, but that depends on circumstances, and cannot be determined with certainty without actual observation. I mean no set time can be given, for the bulbs do not all start into growth at one time, nor do they all grow equally—some are late, others early in making their growth; but when the leaves cease to grow or elongate, everything being conducive to their development, nothing is more certain than that the growth has been made. Having settled this point the next consideration is, Do the plants need potting? If the drainage be perfect and the soil anything but sodden, the best plan is to let well alone. Never mind how full the pot may be with roots, the plants flower all the better, and the bulbs ripen more perfectly. If, however, the soil be sodden they must be potted, and the following precautions must be attended to:—Break the ball as little as can be helped; taking away about 2 inches of the surface soil, clear the principal roots carefully and adjust them, and place a layer of soil at the bottom of the pot. The pots best suited for the plants now under consideration are bulb-pots, 8 inches in depth and 5 inches in width inside measurement. Not less than 1 inch of the depth should be broken pots, a large piece over the hole, and some smaller upon it, and 1 inch of the rougher part of the compost over it. The soil should be composed of hazel loam, and if it be turfy and not less than three years old so much the better. It should not be sifted but chopped with the spade, for the roots run more readily through it when it is porous, and a more ready passage for water is thus prepared, and this is a point of great importance. About one-sixth of sharp sand should be thoroughly incorporated with the soil, and in this mixture pot the bulbs, and if it be done well not a single root need be injured by the operation. The neck of the bulb should be level with the top of the pot, and the soil carefully put round the sides and pressed gently down, leaving a hollow of half an inch for watering purposes at the top of the pot, the bulb being covered to the neck with soil. Finish with a copious watering, and gently syringe the leaves.

It is not advisable to repot plants producing seed, but they should remain in the quarters which they previously occupied, and receive only sufficient water after the leaves attain their full size to prevent their flagging. The production of seed never injures the bulbs if the foregoing directions are attended to.

After potting, presuming that has been done when they attain their strongest growth, and whether or not the leaves are at their strongest, it will be advisable to keep the plants in a shady place for a few days until the check likely to result from the potting is got over, and which the plants will experience if placed in the position previously occupied. When the danger of a check is over they may be removed to a shelf in the full sun and near to the glass, and the supply of water should be gradually diminished, but frequent syringing overhead must be given daily for a month longer, and the supply of water but little diminished for that period. A month after the strongest growth or full development no more or but few syringings are needed, and not a drop more water than enough to prevent the leaves flagging. Take no notice of yellow leaves, only be careful that whilst green the foliage does not flag from want of water. Continue this treatment until October when most of the leaves will have turned yellow; but if they be green do not become uneasy about it if the soil in the pots is dry. The plants at this time, October, should be placed on a shelf in the stove, and not a drop of water given them until the scape and leaves appear in the January or February following. Any bulbs that appear disposed to remain evergreen should not be forced to rest by withholding water so that the leaves flag, but a little (and it is astonishing how little will do it), should be given in winter to prevent their flagging.

The temperature from January to June should range from 55° to 60°, and it may rise to 75° or 80° with sun and abundance of air. From June to October from 60° to 65°, and 80° to 90° with sun, will do them no harm. From October to February a dry atmosphere never below 50°, nor exceeding 60° with fire heat, suits them. It not unfrequently happens when the growth is made early—say, by May, and water gradually withheld after that time, that the plants will rest at midsummer, lose a number of their leaves, and give a fine bloom in autumn in addition to flowering in spring. This the old gardeners termed good management, but not all their bulbs even did this. It was only the strongest, for weak bulbs are late in making their growth, and consequently do not ripen rapidly. Should any grower, therefore, have bulbs that seem disposed to rest at midsummer, encourage them to do so by withholding water instead of promoting a second growth by giving more water than is really necessary to prevent the leaves flagging just because a leaf or two turns yellow. Plants flowering twice will make a second growth, which must be well supported by liquid manure and copious watering until the growth is made, when they are to be dried off as after the first flowering.—G. ABBEY.

(To be continued.)

FLOWERS OF THE PAST SEASON.

PELARGONIUMS.

Who is there that takes any interest in this beautiful summer flower, and who assists at those gorgeous displays and banks of bloom that gladden the eyes and excite the enthusiasm even of those "outer barbarians" who are not initiated into the mysteries of shape, size, substance, margin, blotches, spots, texture, &c., on which the genuine florist delights to descant? Who does not recollect that wonderful bank of seedlings, which, in June, 1862, puzzled the brains and dazzled the eyes of the Judges who then had the light and easy task (?) of, in little more than an hour, deciding on a century of seedlings, and to do so according to the usual happy arrangements of the Kensington folks, with the Fellows, their wives, and daughters, pressing round them, and freely commenting on everything on which they were called to decide? It would not be wonderful, then, that mistakes were made, and that the showers of first and second-class certificates which descended then in no sparing manner upon the subjects brought forward were in some instances undeserved. It seems, I must own to it, a cruel thing to

have these poor innocents brought up for trial after having been so highly praised, coaxed, and flattered; but still justice must be done; and although the hangman's office is not a very pleasant one, and one feels rather like those wretches, Forrest and Dighton, when they murdered the little princes in the Tower, yet the thing must be done, and none the less so because the stamp of authority has been placed upon them; for thus the evil is increased, and that which people will hardly buy on the mere recommendation of the raisers themselves, they are more willing to do when it comes winged with a first or second-class certificate.

It is then of these, sent out in the autumn of 1862 and spring of 1863, that I intend to speak. Through the kindness of those who sent them out I have been enabled to grow them under my own eye, and as I have watched them from day to day, have formed my opinions concerning them. These may be wrong, and in some instances may prove to be so, but they are none the less conscientious.

1. **ARDENS** (Beck's).—This flower seems to me to have been over-rated; for although showy and brilliant in colour, it has not that size and substance which is necessary for a first-class flower.

2. **AGAMEMNON** (Beck's).—A showy purple variety, somewhat too long in the flower. Its habit is good.

3. **BEACON** (Hoyle's).—This cannot lay any claim to being a show flower. Its shape is indifferent; but it is very valuable for effect, being quite as fine as many of the French varieties.

4. **BELLETRIX** (Beck's).—A very bright flower, but I am not quite satisfied with its performance this year; it may possibly improve.

5. **CENSOR** (Foster's).—A fine bold flower, excellent for the stage, but questionable as to its claim to being a first-class flower, which I do not think it is likely to be.

6. **COLOSSUS** (Hoyle's).—A very fine, full, rich rose-coloured flower, of large size, with light centre. Very striking.

7. **ESPERANCE** (Beck's).—A very pretty light flower, the white not pure, but still of very nice substance, and altogether pleasing.

8. **ILLUMINATOR** (Foster's).—A very brilliant flower, opening well, very smooth in substance, shape good, ground scarlet, with intense deep blotch. Altogether an excellent flower.

9. **IMPROVEMENT** (Foster's).—A very fine purple flower of good substance, the top petals deep maroon. An excellent flower.

10. **INEZ** (Hoyle's).—A sort of painted orange flower, with white centre. There is something very novel in its appearance.

11. **LORD PALMERSTON** (Hoyle's).—I am somewhat disappointed in this flower. Its appearance universally excited admiration from the novelty of its colouring, and for that it must be retained; but the substance and shape do not seem to be what they ought, and these are just the points in which mistakes may be made. A flower is shown off to its best advantage; just as an anxious mamma will see to the appearance of her daughter when she first "comes out," so do these anxious raisers "titivate" their flowers very often, so that they are sometimes thought to be better than they really are.

12. **MERRIMAC** (Foster's).—A fine large flower, opening well, and displaying a white centre. The truss is large, and the plant altogether showy.

13. **ORIANA** (Beck's).—A large and fine flower. The form is excellent, and the colouring very bold. It is altogether remarkably fine.

14. **OTTAVIA** (Hoyle's).—Light flowers, white not pure, but pleasing as a greenhouse flower.

15. **PERICLES** (Hoyle's).—White flowers, but not superior to many out.

16. **ROYALTY** (Foster's).—One of the best flowers of the season. Good form, colour, and substance; lower petals painted purple, top petals nearly black; white centre. Altogether a very excellent flower.

17. **ROYAL ALBERT** (Hoyle's).—A very fine large flower. Apt to crumple, I fancy, on the top petals; but its size will make it coveted by all growers.

18. **REGINA FORMOSA** (Beck's).—A very good flower, fine form, dark maroon spot. A very fine plant for exhibition, and I fully expect to see it largely used for that purpose.

19. **ROSY BLOOMER**.—A showy flower for the stage, and somewhat novel in colour, but not an exhibition plant.

20. **SOUVENIR** (Foster's).—A painted flower of large size, and very attractive.

21. **TYCOON** (Hoyle's).—Dark rich-looking flowers, and very good shape. One of the best dark flowers out.

22. **VESUVIUS**.—A bright scarlet flower, but not very first-rate in character.

23. **QUEEN OF WHITES** (Dobson's).—The best light flower of the season. Ground colour the purest white, with a beautiful spot. An excellent flower.

24. **BUTTERFLY** (Beck's).—An effective flower, though somewhat inclined to be loose and open. Spots on the three lower petals; top petals nearly covered with black blotch.

25. **CALIBAN** (Beck's).—Very free-blooming, with fine spots. A very striking flower.

26. **EDITH** (Hoyle's).—White flowers, with lake spots. Curious.

27. **FEU DE JOIE** (Turner's).—Orange scarlet flowers, with spots on all the petals, which some people call quiquevulnerous! save the mark!

28. **LANDSEER** (Foster's).—A very fine rich flower. Spots on the lower petals, top petals nearly black. Very free-blooming.

29. **MONITOR** (Foster's).—Fine dark variety. Spots on all the petals; free-blooming and large. Excellent.

Of Fancy Pelargoniums I can say nothing, having had no opportunity of proving them; but of the above I should be inclined to select as the best Colossus, Illuminator, Improvement, Royalty, Royal Albert, Regina Formosa, Queen of Whites, Caliban, Landseer, and Monitor. And if some of our correspondents, who very frequently ask for the names of the best new varieties, would bear them in mind, they might save themselves the trouble of writing.

Again do the raisers of seedlings, Messrs. Hoyle, Foster, and Beck, come forth to claim our attention. The flowers of the two former are in the hands of Mr. Charles Turner, of Slough; and Mr. Beck's in those of Mr. Williams, of Paradise Nursery, Holloway. I have not seen many of them, but think I am not far wrong in saying that two of the finest flowers ever seen are in Mr. Hoyle's lot this year—I mean Artist and Achilles.

The interest which attaches to this flower is by no means diminished, its readiness of cultivation, freedom of flowering, and hardiness of constitution making it a favourite everywhere. Wherever the labourer's wife can put a flower in the window it is pretty sure to be a Geranium; and I think that those who cultivate them could not do better than distribute cuttings of good sorts, which they would otherwise throw away, amongst their neighbours, for it is desirable that they, too, should have their eye formed to see what is truly beautiful and good. I think, that as with children so with others—it is even well to accustom their eyes to good forms and colouring. It seems to me to have no slight bearing on the proverbial good taste of the Parisians, that their eye is from earliest childhood educated to these things, especially in the ready and free access that they have to works of art of all kinds.

I have not entered on the subject of Zonale or bedding Pelargoniums, but reserve them for a separate notice, and here, as in Verbenas, a good deal of execution must be done.—D., Deal.

NEATNESS EVEN IN MIDDENS.

"THEY manage these things better abroad," is a phrase one hears frequently from travelled people, and in some instances they are right. I have noticed that the manure-heaps on the Continent are almost invariably more neatly kept than those in English farmyards and gardens. Passing along the Taunus range one is struck with the peculiar tidiness of these somewhat offensive adjuncts to the garden; the servants seem to take a pride in making the heaps as ornamental as possible. A sketch would, perhaps, be the simplest plan to give your readers a correct idea of the way in which it is done, but failing that, I will try to make it as comprehensible as I can.

The men first throw all the short stuff in a heap, and then mark a line all round in which to place the long litter; this latter, having brought the ends some way over the proposed

edge of the heap, they double back neatly over the fork-hand'e, in the same manner as our grooms do when they mak: up the horses' beds. The straw, being folded back, must be kept in its place by some weight, either a plank or a few bricks, until the next layer is placed upon it. The whole may be made more or less artistic according to the fancy and capabilities of the person who arranges it. In the summer a little earth is thrown on the top, and Melons, Gourds, or Pumpkins planted, which look well, and are besides very useful.

Without at all wishing to "put down" our English gardeners, I must say I never yet saw a compost or manure-heap that was either ornamental or even neat here at home, and I see no reason why they should be otherwise.—PATELIN.

LIFTING AND INARCHING VINES.

PEACH TREES IN POTS AND IN RAINY DISTRICTS.

A CORRESPONDENT ("W. E. M., Lancashire"), will find the first question discussed in the Journal of November 10th, 1863, page 365, to which he is referred, in preference to going fully into the matter again. With regard to the instructions given in the two works to which "W. E. M." refers, he must bear in mind that there is a great difference between simply shifting a Vine, or any other fruit-bearing plant from one pot to another, or in planting a young Vine with the object of getting the finest possible growth the same season, from lifting old Vines and renewing the border with the double object of both improving the Vines and not losing a year's crop. To simply shift any blossom or fruit-bearing plant late in autumn with the view of favouring its fruitfulness, or to get it to set its fruit either more certainly or strongly would be opposed to the experience of pot-culture in general, as well as to sound principles; and it is, no doubt, because Mr. Rivers has found this out that he recommends the discontinuance of autumn potting, and in the case of growing fruit trees in pots he is well entitled to a hearing. To obtain a fine, healthy growth from a young Vine the same year it is planted, there is no better time than May to plant, particularly if the roots are to be all outside. To plant and force on sooner would not be productive of so fine a Vine that same year, and can only be recommended in cases where it is desirable to work the Vines quickly round into early forcing, and then the roots should be partially, at least, inside. Hence it is, that, in a general way, May is to be recommended in preference to March or April, because by waiting there is more natural warmth in the soil, and a greater disposition in the Vine to growth without being forced by a greater amount of artificial heat. But where the object is to make Vines bear fruit the summer after they are lifted, the case is very different. To take the case of young Vines, even if they are entirely shaken out, ten chances to one but every bunch will "wire," or run to claspers instead of coming into bloom. The same Vines, on the other hand, if planted the previous autumn, would establish themselves and bear fruit to a certainty the next summer. Therefore, it is, that when the securing of a crop is an object we have recommended early autumn, before the leaves and roots cease their functions, as the best time for lifting old Vines and renewing the border. If left till spring there are ten chances to one against a crop, as compared to autumn-lifting. Moreover, when lifted in autumn the Vines will be in much finer condition in the autumn of the following year, than if the operation were delayed till spring. Of course, there are cases where autumn-lifting cannot be carried out, and then spring is the next best time, so that now our correspondent must be guided by his desires as to the loss of a crop. In the spring the chances are against a crop. In autumn he may succeed in obtaining a fair crop the following season, as many have done before now.

The top eye of your pot Vine will, undoubtedly, give you the finest shoot for inarching; but if the fruit of the pot Vine is considered of importance, we would rather let one of the lower eyes grow away without stopping it, and take it for the inarch. The top eye, if allowed to grow away vigorously, will considerably rob the fruit-bearing growths below. To do the inarch the greatest justice the top eye would be best; to do the crop on the pot Vine the like

justice, it would be best to take a shoot from an eye lower down, and stop the top bud after it has grown three or four joints. There is no reason why you should not succeed in getting a good inarch and a good crop from the same Vine, and we would recommend you, with that object in view, not to inarch the top shoot, but to keep it stopped close in to a few joints.

To force your Peaches and Nectarines successfully, remember that you are more likely to succeed in setting a crop by forcing gently than by a high temperature. Do not exceed 40° to 45° till the buds are showing the colour of the flower; then if the weather is not very cold raise to 50° at night, with from 5° to 8° more by day. Do not use the syringe so freely as you propose, rather sprinkle the path than apply much water to your trees, and when opening into bloom they must have a circulation of dry air about them, without any application of moisture, till they have set and are swelling their fruit.

It is difficult to give definite rules as to how often they should be watered. Give it just often enough to prevent the soil from becoming dry on the one hand, and not to keep it too wet on the other. Either extreme must be carefully avoided. For the production of early crops of Peaches and Nectarines we consider the pot system a precarious one, and no gardener who has an early and continuous large supply of the finest fruit to furnish with the least possible expense, and the greatest certainty, ever attempts to do so from trees in pots. Pot fruit trees are well enough in their own niche, but they have been far too much made of. We would advise you, if you wish for good early Peaches with the greatest certainty and least expense, to plant your trees out, and train them near the light or glass.

With regard to the culture of the Peach in rainy districts, it is our opinion that well-ripened wood will carry a crop through more severe spring frosts than wood that is badly ripened. We have had striking proofs of this several times. In the autumn of 1858, we transplanted a large tree from one of our Peach-houses on to the open walls. It had well-ripened wood and fine prominent buds, and it was the only tree on the same wall that carried through a crop the following spring. Finely-ripened trees from the neighbourhood of London have frequently set their fruit with greater freedom the spring after they were planted than others that made their wood in a colder climate. To a certain extent, if this be correct, the gardeners are right, inasmuch as your trees are not in so good a condition to bear with spring frosts as others are in localities where the wood ripens better, and where they have equal visitations of spring frosts. The frost does its work all the easier on account of your blooms being weaker, and more likely to be cut off.

To remedy the evil you should avoid rich borders, as being productive of strong wood, which is less likely to be ripened in autumn. Well-drained, shallow borders would give less vigorous wood, which requires less sun to ripen it. This in such localities, in conjunction with protection at night in spring, would be the condition most likely to insure success. We are, however, of opinion that there are but few localities in Britain where coverings of glass would not in the course of years be the cheapest in the end, and there can be no doubt such are the most effectual remedy that can be applied to the evil. Unless when subject to the grossest mismanagement, Peaches are sure to bear well and regularly under glass, and from our own experience and observation it matters very little about the soil they are then planted in, provided it is not grossly enriched. The finest crops of Peaches that we have ever seen have been from trees under a glass screen, growing in a poor, hungry, gravelly soil, occasionally watered with liquid manure. Your best panacea for Lancashire, and all other cold, dull, wet districts—is glass, glass.—D. THOMSON.

MILTON HOUSE.

Among gardens worth seeing in Northamptonshire, it would be unjust to omit that at Milton House, near Peterborough, the seat of the late Earl Fitzwilliam and now of the Hon. George Fitzwilliam. The visitor will find the gardener, Mr. W. Worraker, a most obliging eicerone and a true lover of his profession. There is a grand old-fashioned

stove with a collection of Orchids and Ferns in the highest cultivation; *Dendrobium nobile* covering a piece of wall at least 6 feet square, and *Laelia anceps* in so large a pot that the next shift will take it into a tub. *Alocasia metallica* has grown and flowered well here during the last summer. Perhaps the most striking object is an immense and perfectly symmetrical specimen of *Dicksonia antarctica*, the size of which may be gathered from the fact that it takes six men to lift it. Though one or two of the tree Ferns at Kew slightly exceed this in size, they will bear no comparison with it in regularity of form; a drawing alone could do justice to it. There is also a good collection of hardy Ferns: among which are prominent large quantities of *Adiantum pedatum*, *Onclea sensibilis*, and *Struthiopteris germanica*. Milton was one of the first places at which Orchids were grown in England, and it is not now in the background, although its means and appliances are not in any degree modernised.—W. T. GATES, *Peterborough*.

LATE MELONS.

WE have our early and late-keeping Grapes, the same of Peaches, Apples, Pears, and many other fruits, why not our early and late-keeping Melons?

A good-flavoured Melon at Christmas would not be otherwise than appreciated, and it is a subject worthy of the attention of raisers and importers of new varieties to secure one of good keeping properties.

That the Melon season can be considerably prolonged I had ample proof last year. We have three span-roofed pits at this place of good-sized dimensions, from which pits I succeeded in furnishing my employer's table more or less for seven months, commencing cutting in June, late in comparison to some growers, and sending up the last fruit on January 12th, 1864.

I think it quite possible to have Melons nine months out of the twelve with properly constructed pits, well heated for the earliest crops.

I find a great difference in the good keeping properties of Melons. Gen., a scarlet flesh, proved the worst keeper I grew, splitting open, and speedily decaying. The Green-fleshed section were far the best keepers grown by me.

Some argue that a Melon is comparatively flavourless except in summer and early autumn. In contradiction of such an opinion I can state that the fruits furnished by me in November and December were of good flavour, as my employer did not fail to acknowledge.

He who succeeds in raising a really good-flavoured Melon possessing the desideratum of hanging plump until Christmas would justly be entitled to as much praise as he who gave us Lady Downes' Grape.—JOHN EDLINGTON, *Crom Castle*.

WHICH IS THE BEST WAY OF HEATING BEDS BY HOT-WATER PIPES?

THE above is the title given to some remarks at page 514 by "W. W." Having had some experience in heating beds, &c., I may at once state that it has been the reverse of what "W. W." anticipates, and with your permission I will give it in as few words as possible.

Thirteen years ago there were built here four pits, each 32 feet long and 4 wide, for growing Asparagus, Sea-kale, and Rhubarb. They were situated two on each side of a stove, and, together with other pits, they are heated from the boiler which heats the stove. There are two-inch flow and return pipes in each on the same plan as "W. W.'s" section A (which he condemns), with the addition of wooden shutters 4 feet high, hinged at the bottom, and opening back from the top. The pits are partly sunk below the level of the surrounding ground. The chamber where the pipes are is 15 inches deep, being formed of Caithness pavement 2 inches thick, and supported along the centre with brick piers. On the top of the pavement are placed broken bricks to the thickness of 3 inches for drainage, and above this, soil to the depth of 2 feet 8 inches.

The Asparagus plants which were, perhaps, twenty years old, I lifted when in full foliage in the end of June, taking care to preserve good balls, and I planted them in the pits,

giving a good watering and carefully tying up the stems to a stake. These plants did so well that, whenever I had occasion to make new plantations of Asparagus in the garden, I have always lifted the plants when in full foliage, and I have never failed; but whenever I lifted plants in winter or spring I never was successful, almost every plant dying. I would strongly recommend this plan to any one who finds a difficulty in renewing beds of Asparagus.

The Asparagus was forced to come in during the first week in March in the first year, and at the same time every year since. From each stool we cut five shoots, strong, and of fine flavour and colour, as they are exposed to the air on all favourable occasions, by folding back the shutters.

The water is only allowed to circulate in the pipes for two weeks, and this is all the heat which is required to bring the Asparagus in at that season. There would be no difficulty in forcing it earlier, but it would be at the sacrifice of the plants every year. The shoots, which are left to grow to form roots and stems for the following year, have been on two or three occasions injured by frost in May, when they were 18 inches high, notwithstanding that the shutters were on.

The Rhubarb and Sea-kale were planted in the pits in the autumn, and both did well; but the Asparagus far exceeding our expectations, the Rhubarb was taken up and the pit filled with Asparagus, and I found I could grow more Sea-kale in the same space by taking up the roots from the garden, and forcing them in the pit, placing them so closely together as to allow just enough room for the blanched stem to come to maturity. When Sea-kale forcing is finished the pit is filled with bedding stuff; and when this is planted out the pit is used for growing Mushrooms during the summer, and a better place for doing so I could not desire, as we have complete command over the Mushrooms; for if the heat caused by the natural decomposition of the dung should fail before the spawn has fully run, the hot water if allowed to circulate for a short time soon puts all right.

Although the pipes in these pits are placed within 2 inches of each other along the centre of the pit, there is no perceptible difference in the earliness of the Asparagus in the centre of the pit, right above the pipes, as compared with that at the sides, and I imagine that it is only at times that the Sea-kale and Mushrooms are affected by the pipes below them, and the reason is that the pipes are not in contact with the pavement. In the chamber the temperature is the same in every part, except in close proximity to the pipes. I have no doubt whatever that these two-inch pipes would heat a space double the size with ease.

On this plan, then, of having the pipes in a chamber, and in no way in contact with the material to be heated, the whole width of the beds can be heated to the same temperature, with the exception of about 2 inches at each side of the bed, where the soil comes in contact with the side walls; while the plan represented by "W. W.'s" section B would only heat the soil right above the chamber, but would be better than either section C or D, as I have proved by experience. Wherever the soil, clinkers, gravel, or any other material comes in contact with the pipes, the heat is carried upwards, and only extends horizontally to a very short distance on each side of the pipe.

I have a border inside a span-roofed house planted with Vines, which was at first chambered for the purpose of growing Vines in pots; but as the Vines were to be planted out, and not having depth enough for soil above the pipes, I removed the pavement, and covered the pipes with drain-tiles to prevent the roots from being burned, making the drainage with broken drain-tiles in the same way as shown in "W. W.'s" section C. I find that the heat does not extend more than 6 inches on each side of the pipes; while the roots in the centre would be burned if I were to attempt to heat all the soil to the sides. And I can assure "W. W." from experience that the roots of the Vines do get into danger, and are destroyed, while when chambered they are in no danger whatever.

As to section D, numbers of gardeners will have experienced that when a hot pipe passes through soil and a thermometer is placed a foot away from the pipe, it will not indicate that it derives much heat from the pipe.

If "W. W." turns to THE JOURNAL OF HORTICULTURE, Vol. III., page 216, he will there find a section showing how

the vinery-borders are heated at this place. The piping passes from the boiler 32 feet out to the front wall of the chamber, passing along within 2 feet of it to the further end, and along the front of the outside wall of the vinery, 16 feet from the back wall, and then to the boiler, heating a chamber with upwards of 1000 square feet of surface. Over the whole of that surface there is not one degree of difference in the temperature even if it is tried just above where the pipe enters from the boiler, because the pipes are not in contact with the pavement, and the whole air is heated alike, and parts with its heat equally under all the soil; while, if on any of the plans of "W. W.," with the exception of A, a space extending, perhaps a foot on each side of the pipe would only be heated, and all the rest of the soil would not be affected in the least by the pipes.

I might enlarge on this subject at considerable length were I disposed to enter into the theory, but I think I have said enough to convince any one of the impropriety of attempting to heat large surfaces of soil by any other means than chambering. I am not surprised at the views held by "W. W." and Mr. Fish, as I had the same myself at one time, and many more equally erroneous. When those chambers were made I had pipes inserted down through the soil where I could pour water down and so wet the pavement, especially above the pipes; but I find this unnecessary, the pavement being at all times kept moist enough from the moisture within the chamber. — ALEX. SHEARER, *Yester Gardens*.

DRYING PLUMS.

THERE are some species of Plums appropriate for this process, and a correspondent in Tasmania has selected the best, and planted three hundred of them. He has in his orchard Quetsche d'Italie, Quetsche de St. Martin, Knight's Late Green Drying, Coe's Golden Drop, Angelina Burdett, French Prune, Black German Prune, Red German Prune, and Prune d'Agen. Our correspondent's family can make fancy boxes; and he thinks, and we agree in so thinking, that he can carry on a trade in dried Plums if he can succeed in the process of drying them. The following is all the information we can give on the subject:—

"The Plums, gathered when ready to drop from the tree, are laid separately on frames, or sieves made of wickerwork or laths, and exposed for several days to the sun, till they become as soft as ripe Medlars. When this is the case, they are put into a spent oven, shut up quite close, and left there for twenty-four hours; they are then taken out, and the oven having been slightly reheated, are again put in when it is slightly warmer than it was before. The next day they are again taken out, and turned by slightly shaking the sieves. The oven is heated again; they are put in a third time, the oven being considerably hotter than it was the second time. After remaining twenty-four hours, they are taken out, and left till they get quite cold. They are then rounded, an operation which is performed by turning the stone, without breaking the skin, and pressing the two ends together between the thumb and finger. They are next put upon sieves, which are then placed in an oven from which the bread has just been drawn, and the door having been closed, the crevices are cemented round with clay. An hour afterwards, the Plums are taken out, and the oven is shut up with a cup of water in it for about two hours. When the water is so warm as just to bear the finger in it, the Prunes are again placed in the oven, and left there for twenty-four hours, when the operation is finished; and they are put loosely into small, long, and rather deep boxes for sale."—(*Thompson's Gardener's Assistant*.)

In addition to the above, we translate the following from M. P. Tourris' "Notice sur Prune d'Agen":

"The fruit begins to ripen in the end of July; that which is first ready being generally the most imperfect. Reed or lath hurdles are prepared beforehand, and placed beneath the trees at 2 or 3 feet above the ground, those made of laths being covered with straw. As the fruits fall from the trees they are carried away, and allowed to sweat for two or three days, after which they are placed in an oven, the heat of which is only one-fourth of that which is required in baking bread. This baking having been repeated three separate times, the Prunes will be dried sufficiently for sale. Those

for home consumption should be stored in a rather dry and well-ventilated place; and those intended for sale are placed in cardboard boxes lined with tissue-paper. A few laurel leaves put in the boxes will give the fruit an agreeable perfume."

THE WHITE PINE (PINUS STROBUS), FOR SANDY OR POOR SOILS.

We clip the following from the *Massachusetts Plowman*, and think it deserves a wide circulation. That the tree does splendidly as an ornamental tree in the poor sandy soil on the shores of Lake Michigan, there is abundant evidence. When it is young and has plenty of room to expand its lower branches, it also forms a handsome tree, and will grow finely where the Norway Spruce will scarcely exist.

The true way to obtain good thrifty trees on poor soils is to plant them quite small. Especially is this true of those taken from the wood, or where they have not been recently transplanted.—E. S.

"In a recent journey through some parts of Plymouth County, in this State, we observed numerous lots of thrifty White Pines, of recent growth, which have 'come' in upon pastures that were old and worn out by neglect and overstocking twenty or thirty years ago. Too poor to pay for keeping the fences in repair as a range for cattle, their owners have ceased to use them for that purpose, and Nature has resumed her primeval sway to good purpose. In a few years these lands will be of great value for the wood and timber which can be taken from them, and they are paying now, by the rapid growth which they make annually, a profit to the farmer, if not as great as his best lands, at least one that is far greater than when he half starved his cattle by pasturing them, or wasted his manure by attempts to raise corn, Rye, and Potatoes.

"Nature is a good schoolmaster, and if those whose life brings them into daily communion with her would pay more heed to her suggestions and teachings, there would be many a barren spot made beautiful and productive, which now yields nothing of any value, and is only a blemish to the landscape. The lesson taught by these growing Pines upon the sandy plains of the old colony is full of instruction, and contains a hint by which all the possessors of such lands may realise rich returns of pleasure and profit. Occasional bare spots indicate, that though able and willing to work, Nature is sometimes, like other good husbandmen, short of seed, and it becomes those who can appreciate the advantages of a growing plantation of good timber, upon lands that are now utterly useless for ordinary farming purposes, to furnish a supply. The present is a suitable time for planting the seeds of all the coniferous family of the forest trees; but as the White Pine ripens in August, they can only be obtained now at the seed-stores. A very slight preparation of the soil with the plough, or even with the barrow alone, will reward the husbandman most abundantly for his labour.

"Some of the enterprising farmers in that vicinity have already tried the experiment of giving Nature a lift, by sowing plantations of Pines, and have met with most gratifying success; and we hope there are more who will be encouraged by their example, to co-operate with her in clothing the waste places of the earth with beauty and abundance."—(*Prairie Farmer*.)

DEATH OF MR. CHARLES McINTOSH.—We regret having to announce the loss of another distinguished gardener. Mr. McIntosh died at his residence near Edinburgh, on the 9th instant. He was born in 1794, at Abercainey, in Perthshire. After serving as head gardener to the Marquis of Breadalbane, Sir T. Baring, Prince Leopold, and finally the Duke of Buccleuch, Mr. McIntosh became a professional landscape gardener. He has been long and favourably known as a writer on horticultural subjects, his first work, "The Practical Gardener and Modern Horticulturist," being published in 1828, and his last and longest work, "The Book of the Garden," in 1863; but as far back as 1825 he communicated to the "Gardeners' Magazine," drawings and descriptions of a new verge-cutter, and a tub suitable for the growth of Oranges or other large shrubs.

tree have been very seriously affected? Another evil which Peach trees sometimes suffer from about the same period of the season, is that the young wood, though it has grown well and is to all appearance healthy, will suddenly become covered, more or less, with a white woolly substance which adheres firmly to the bark. Often, as in the former case, this mildewed appearance will be accompanied by a partial falling-off of the leaves. How do such evils arise? Are they due to imperfect root-action, or to atmospheric causes? Upon these questions I have no doubt a great variety of opinions are held: and without attempting to anticipate what others may bring forward, I will state that my observations and experience lead me to the conviction, that in the successful cultivation of the Peach we have to contend with more evils arising from atmospheric influences than from imperfect root-action. In all the Peach trees which have with me become unproductive and unsightly, I invariably found the roots in very fair condition, so vigorous in many cases that they could not well be kept from throwing up shoots from the collar of the stock.

For the reasons which I have stated, I am an advocate for Peach-houses, not upon any makeshift principle, but with ample room, where the trees can be attended to satisfactorily.—G. DAWSON.

BOILERS FOR GARDEN STRUCTURES.

At the risk of appearing to contradict so good an authority as "W. W." on the question of boilers, I beg to make a few remarks on the subject. The boiler figured at page 410 of last volume may, for aught I know, be the most efficient as well as economical one extant; but judging from its appearance, and as far as I can understand the description given, I should be very far from accepting it as such. Besides, there is no statement made of the amount of fuel consumed, or the length of piping, or quantity of water which such a boiler would maintain at a given temperature. Too much is left for mere conjecture for any satisfactory conclusion to be arrived at. I have no doubt that as regards the ease with which the soot may be scraped off it has an advantage, but then the surface presented to the fire is small, and the less surface to clean the less to heat. Tubular boilers present a comparatively large surface of water to the action of the fire; and if from the construction or arrangement of the boiler facilities are presented for readily cleaning off the accumulated soot, they must naturally heat more rapidly and keep up a more active circulation than boilers presenting merely a plain surface. If by any means a wire brush—that is, a brush made of iron wire, not the handle merely, but the brush itself—can be made to work freely on every part of the heating surface, so as to scratch off the soot, a daily application of it for two or three minutes would keep the boiler clean and in good working order, nor would this be by any means a very formidable task.

Although the saddle boiler may possess qualities which induce many intelligent gardeners, even now when boilers are pointed out to them as being vastly superior both in efficiency and economy, to give it the preference: it is certain that something possessing all its good qualities and many others added to them, is expected to turn up some day, and it cannot for a moment be supposed that it is to lay claim to the title of best in every sense, and drive all others out of the field. In the ordinary form it has the very serious defect of only intercepting a moderate part of the heat, and allowing the main body of it to pass off; and this defect, I should think, is shared by the one figured at page 410, judging from its appearance. That some great improvement is to be made in some modification of the saddle boiler I have no doubt—that of Mr. Messenger is one; but this leaves the impression of something being wanting, and so do all that I have seen; so do the cannon, the conical, and the cylindrical boiler. Yet these are all good in their way; each has many advocates, but these are chiefly men who have used them in a small way, and who take little note of the quantity or value of the fuel consumed. This, however, is not what thoroughly practical men want, especially those to whom the consumption of fuel, amounting in cost to, perhaps, a little fortune in the course of a few years, is an object of consideration in relation to the results obtained. With the

practical man it is a matter of profit and loss, and he it is who looks for and is able to give an impartial judgment, but in order to do so he must enter into the minor details and think nothing too insignificant to be noticed.

"W. W." says, that tubular boilers when new perform their task in a most gratifying manner, but after a time, when coated with soot, the consumption of fuel is increased, and the result is less satisfactory; but this is a property shared in common by all boilers of whatever make, only the effect is slower and becomes less apparent on those presenting a plain surface to the fire. A boiler, to be perfect, ought to unite simplicity and efficiency with economy in the consumption of fuel. In tubular boilers simplicity is wanting, but if this want is more than counterbalanced by the two latter qualities, they will yet hold their ground. This, however, will admit of some doubt; and I have no hesitation in asserting as I have asserted before, that a thoroughly good boiler has yet to be produced, and that it will eventually appear in the form of a conical water-jacket, containing within itself some means of breaking and dispersing, for the purpose of intercepting, the heat that would otherwise pass off into the flue. A plain water-jacket is in itself incapable of doing this, although it naturally receives all the heat that is given out laterally, and it is a great advantage to let no direct heat from the fire come in contact with brickwork. An apt illustration of my meaning is seen in the flame of a lighted candle. When burning steadily its form is somewhat conical; surround this with a piece of tin or sheet iron turned to the same shape, and it will give an idea of a conical boiler; if the top is open or a tube leads from it to carry off the smoke, it will be seen that by far the strongest heat escapes the same way. Now, to appropriate this heat it must be broken and dispersed. In the suggestions given some time ago by Mr. Abbey, this is to be done by means of horizontal coils of pipes; in those given by myself, by means of perforated hollow plates, or it might be done by means of horizontal hollow bars; but whatever means are employed in accomplishing this purpose, and perhaps the more simple the better, it must be remembered that a sufficient draught for the fire should be left, and that a ready means of clearing off the soot should exist.

The kind of fuel employed must in a measure depend on the locality. Where coke is cheaper than coal it would be best in every case to use the former, since it makes little smoke, and will not allow even tubular boilers to become clogged with soot if a good fire is kept going; but coke, although better, is seldom cheaper than coal in the long run, as it burns away more quickly. I have used four bushels of coke per diem, simply to keep the frost out of a house of about 300 superficial feet: this, at 6*d.* per bushel, would be 1*s.* 4*d.* per week; a year's consumption at the same rate would amount to something like £36, a considerable outlay for so small a place. I have also used coal, which, at £1 5*s.* per ton, I find on calculating the rate of consumption would amount to about the same value; this was by means of a saddle boiler, which most probably for heating a small place is as economical as a tubular one, and perhaps much better from its simplicity. In coal districts, where good coal can be bought for less than half the price that it costs about London, coal is generally used; but even in such places the cost of fuel is no trifle, and this test of a good boiler is as much an object of interest there as anywhere else. To the amateur who cultivates fruits, flowers, &c., under glass, the exact quantity of fuel which is required to heat a given space may be of small moment, but with nurserymen and others it is of considerable importance. I feel assured that a few statistics with regard to these various points would be highly instructive, for although glass structures are now cheap, the culture of the Pine and most tropical fruits and plants still involves considerable outlay, and whatever may tend to reduce that outlay is well worth inquiring into.—F. CHITTY.

PORTRAITS OF PLANTS, FLOWERS, AND FRUITS.

ARISTOLOCHIA LEUCONEURA (Pale-veined Tree-Aristolochia).—*Nat. ord.*, Aristolochiaceæ. *Limn.*, Gynandria Hexandria. Native of New Grenada. The flowers are produced

in clusters on the lower part of the trunk; limb of the flower purple, beautifully netted with yellow lines. Blooms in the stove during September.—(*Bot. Mag.*, t. 5420.)

PELARGONIUM BOWKERI (Mr. Bowker's Pelargonium).—*Nat. ord.*, Geraniaceæ. *Linn.*, Monadelphia Decandria. Native of the Trans-Kei country in South Africa. Graceful in foliage and flowers, but the latter are devoid of striking colour; they are tinted partially flesh-colour and partly yellowish green.—(*Ibid.*, t. 5421.)

SCHIZOSTYLIS COCCINEA (Crimson Schizostylis).—*Nat. ord.*, Iridaceæ. *Linn.*, Triandria Monogynia. Native of watery places in British Caffraria. Flowers crimson, blooming late in autumn.—(*Ibid.*, t. 5422.)

MIMULUS REPENS (Creeping Monkey-Flower).—*Nat. ord.*, Scrophulariaceæ. *Linn.*, Didynamia Gymnospermia. Native of extra-tropical Australia, and as far as Victoria, and then in Tasmania. It is also common "in saline situations, and muddy banks of rivers in New Zealand." It will probably require the protection of a cold frame in winter. Its flowers are lilac, partially dotted with yellow.—(*Ibid.*, t. 5423.)

SOLANUM ANTHROPOPHAGORUM (Cannibals' Solanum).—This is one of the condiments eaten with human flesh by the cannibals of the Feejee Islands. Such flesh they all acknowledge is most indigestible; and the fruit of this plant, called by them *Boro dina*, somewhat resembles the Tomato, but having an aromatic smell, is employed to assist digestion, and its leaves are wrapped round the flesh previously to its being baked.—(*Ibid.*, t. 5424.)

RHOIODENDRON, Princess of Wales. Prevailing colour, dark mauve, shading off to a white throat. Its truss is large, and altogether the variety is superior. Raised by Mr. Young, Milford Nurseries, near Godalming.—(*Floral Mag.*, pl. 177.)

ROSE, Baron de Rothschild. Brilliant crimson, very large, and very double.—(*Ibid.*, pl. 178.)

GLOXINIAS.—*Lady Emily Villiers*, pink ground, darker towards the throat, which is white; centre of lower segments have a band of white spots. *Lady Victoria Howard*, mauve, towards the throat brownish crimson, throat white; centre of lower segments have an irregular band of white lines. *Mademoiselle Suzanne de la Bouvillerie*, segments of corolla dark lilac, throat white. They were raised by Mr. Breeze, and are now in the possession of Messrs. E. G. Henderson & Son.—(*Ibid.*, pl. 179.)

ACHIMENES.—*Purpurea elegans*, claret colour, throat orange. *Leopard*, pale crimson, throat orange, spotted with crimson. Raised by Mr. Parsons, of Welwyn, and now possessed by Mr. B. S. Williams, Paradise Nursery, Holloway.—(*Ibid.*, pl. 180.)

CAMELLIA, Sarah Frost. Said to be of American origin, but now in the possession of Mr. Standish, of Ascot Nurseries. Remarkable for the perfect regularity of the arrangements of the petals, and the accurate circularity of its entire form. Colour pale carmine, substance good, and retaining both form and colour for a long time.—(*Florist and Pomologist*, iii., 1.)

SOME GARDENS WORTH SEEING.

LINCOLNSHIRE.

Name.	Proprietor.	Gardener.	Station.
Belton Hall	Earl Brownlow	Mr. Ingram	Grantham 3 miles
Syston Hall	Sir John Thorold, Bart.	Mr. Burr	Grantham 4
Stoke Rochford Hall	Christopher Turner, Esq.	Mr. Dell	Gt. Ponton 3
Easton Hall	Sir M. Cholmeley, Bart.	Mr. McDonald	Gt. Ponton 3
Denton Hall	Sir G. F. Welby-Gregory	Mr. Brown	Grantham 3½
Harlaxton Hall	Sherwen Gregory, Esq.	Mr. Wade	Grantham 3
Caythorpe Hall	Colonel Peske, M.P.	Mr. Brown	Hougham 4
Arncliffe House	Miss Southwell	Mr. North	Hougham 1
Arnoldfield House	William Oster, Esq.	Unknown	Grantham 1
Stoneybridge House	John Hardy, Esq.	Mr. Bowman	Grantham 9½
Willoughby Hall	Charles Allen, Esq.	Unknown	Ancaster 2
Newton House	Brook Turner, Esq.	Unknown	Grantham 7
Boothby Hall	Whitley Bowman, Esq.	Unknown	Grantham 5

NEW HAMBURGH GRAPES. — It will be seen from our advertising columns that an opportunity will be offered to competitors this season to show what they can do in the way of producing early Black Hamburgs, by an Exhibition which will be held at the meeting of the Fruit Committee on the 29th inst. It will be remembered that a similar

Exhibition last year excited a considerable amount of interest; but as the competition was confined to two exhibitors only, disappointment was felt by several who had come with the prospect of competing. On this occasion, however, the competition will be open to all comers.

GARDEN ARBOURS, SEATS, AND RUSTIC VASES.

A CORRESPONDENT, some time since, made some inquiries about rustic seats and vases for a garden; and as no one has given him the desired information, I will make a few remarks on the subject, and also send you a photographic view or two kindly furnished to me by my friend, Mr. Middlebrook, manager of the Public Park at Macclesfield. He is an artist in such subjects, and has designed and put up with his own hand the arbours and vases from which the photographs were taken. I trust the views and my observations will be acceptable and useful to many of your readers as well as to your correspondent.

I shall divide my subject under four heads—viz.:

- 1st, Garden seats: their object or use.
- 2nd, The position they ought to occupy.
- 3rd, Their form.
- 4th, Rustic vases: their use, position, and form.

1st, *Garden Seats: their Object or Use.*—They should answer two requirements—namely, a place to rest and a place to find shelter in. In walking around and in a large garden or pleasure ground the pedestrian may become weary, or wish to prolong the pleasure of being in the open air amongst the beautiful objects with which such a place abounds: how pleasant, then, it is to find a seat placed conveniently on which the pedestrian may sit down either to rest or to view more leisurely the scenery. If the seat takes the form of an arbour it is delightful in fine weather there to entertain a friend or two.

Then, again, in our variable climate, the wanderer out of doors may often gladly find in a covered arbour a doubly-welcome shelter from the shower or storm much to be preferred to the Oak or Elm, because it is not only a sure shelter from the rain, but also not so liable to be struck by lightning as these trees. For myself I say I would rather be thoroughly drenched in a thunder shower on a wide moor than seek shelter under even a Beech tree, which some say is not liable to be struck.

2nd, *Their Position.*—Such a place of rest or shelter should not be too near the dwelling. It should be placed at a moderate distance from it even in small gardens, and if of a rustic character should be in a retired corner, rather concealed than full in view from the windows of the house or from the public road. Quietness and seclusion should characterise its position. More elaborate structures of the temple or alcove character may be more exposed, but should not be near the house. The garden arbour should not look to the south, unless it is used as a seat in winter; then on a sunny day the seat will be enjoyed. It may, indeed, have the floor of a solid piece, and be made to turn on a pivot; it would then be useful for every season of the year, as it could be turned to face any desired aspect. In a large place the positions for seats will be more numerous: one at the head of a piece of water, with the boathouse underneath, another placed where there is an American garden, another where there is a ruin, whether real or artificial, a fourth in a place commanding a fine view of the surrounding country, and so on. On the side of a rocky hill a place might be excavated; and a cool seat, formed in the grotto style, would be in a good position and in perfectly good taste. The landscape gardener would find it an easy task to select positions for seats of various kinds for repose and shelter, if the owner of such a place were disposed to have seats so placed.

3rd, *The Forms and Material of Garden Seats.*—These are very numerous. The most primitive, perhaps, is the mossy bank or raised turf seat, useful, however, only in very dry weather; next, trunks of trees, laid in convenient resting-places; also the stumps of trees sawn off level; next, rustic stools, chairs, and long benches with backs made of crooked Oak branches. Then come chairs and seats made of cast

Iron, most of which are clever imitations of rustic seats made of wood, and have the advantage of being more lasting than are many ornamental forms of seats made of wood, particularly some which I have noticed with backs cast in imitation of large Fern fronds. Folding seats are made of planed deal with the backs hinged, which fold down upon the seat in rainy weather, and lift up in fair weather when required. Lastly, there is the Chinese barrel seat, made of earthenware, polished, and painted with Chinese figures and scenes. All these moveable seats, when cold weather sets in, may be placed in a dry shed or room to preserve them, and whilst there they may, if they require it, be repainted or varnished.

The next garden seats I notice are of a threefold character—namely, the alcove, the ornamental, and the rustic. These are covered seats, and generally permanent.

The alcove is now seldom seen. By the term "alcove" I mean a half-circular recess in a wall, the roof slated and under-drawn, and the floor paved either with smooth flags or glazed tiles. In my younger days I have, in old-fashioned places, met with many examples of this kind of seat. In some instances it was placed at one end of a walled-in Dutch geometrical garden, and in others in the centre of the fruit walls of a kitchen garden, where a view could be obtained of the well-ordered garden.

Ornamental seats are formed of stout timbers and lattice-work sides, the roof being made of shingles, or even slates, the lattice-work covered with creepers, and the seats made of polished deal, rounded at the edges, and painted. These seats are very handsome, and should be placed in highly-kept grounds.

The workers in wire make seats now of a highly ornamental character, and I shall have occasion to notice them more fully shortly.

I have now come to

the kind of garden seat which is,

I think, more valued and more mean rustic covered seats.

The making of them is quite a business, employing throughout Great Britain a considerable number of men. I have often been inquired of who make these seats, but not knowing their address I could not give the desired information. I have no doubt their business would be increased if they would advertise in gardening publications.

It was seeing rustic covered seats of this kind in the People's Park at Macclesfield that reminded me of the inquiries about them; and, as already stated, it was the Superintendent of this highly interesting and well-managed park-garden who presented me with the photographic views.

No. 1 is the more elaborate of the two. It is eight-sided, 10 feet in diameter and 10 feet high in the centre. The seat is formed of boards first, and upon them peled larch shoots of uniform thickness are fastened. The walls are of boards also: and upon the boards, covering them entirely, are nailed panels of fir branches with the bark on, divided by lines of the cones of the Stone Pine. The roof is formed by rafters meeting in the centre and resting upon each supporting pillar, is in the ridge-and-furrow style, and is also covered with Stone Pine cones. The outside is thatched with Ling or wild Heath. The floor is made of deal, cross-barred diamond-fashion. All the panels, seats, and cones are highly varnished, giving them a clean and tidy appearance, as well as preserving them from decay. When the sun shines inside on a summer's eve the effect is very fine. The seat is placed at one corner of the bowling-green, and is backed by a young rising plantation.

No. 2 is a much larger seat, open on five sides. It is 15 feet in diameter, and 15 feet high in the centre, and is, consequently, capable of holding a large party. It is placed

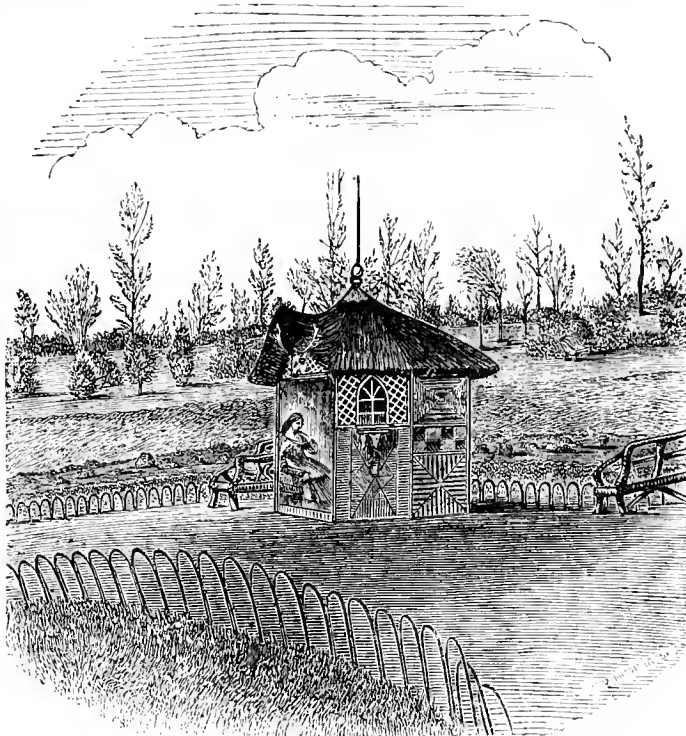

Fig. 1.

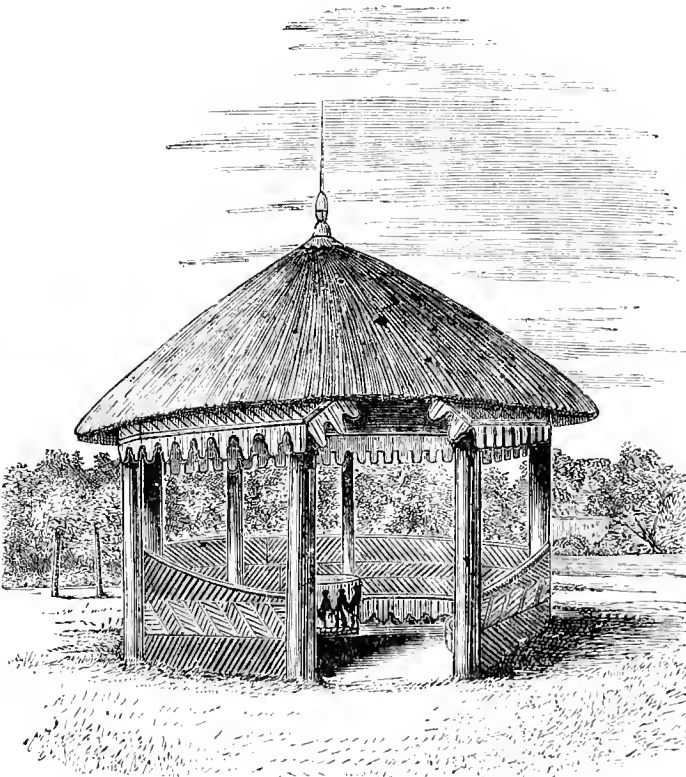

Fig. 2.

on a platform on the side of the bowling-green, and is evidently meant for the company to sit and watch the bowlers when at play. I need not describe it minutely, for the photograph shows its form and character sufficiently. I may, however, state that the roof was first boarded with shingles, and then covered with Heath shoots fastened on with laths and nails to the board, the laths being hid by the overhanging Heath.

T. APPELET.

(To be continued.)

PIERCE'S SYSTEM OF HEATING.

AMONG the many different modes of heating garden structures and buildings, the system which has just been introduced by Mr. G. H. Pierce, of Taunton Castle, is one which commends itself both for its originality and its efficiency. The object Mr. Pierce had mainly in view in contriving this method was to economise to a much greater extent than had ever been attempted the heat which in all other systems to a greater or less extent passes off by the flue and is thereby wasted. We conceive that in this respect he has been eminently successful, and that by his system all the heat that can be serviceable in keeping up the temperature of the water is economised.

The plan may be seen in full operation in the nurseries of Mr. Edward Pierce, of Yeovil, Somersetshire, where there is a propagating-house 40 feet long and 12 feet wide, heated on this principle, and another of larger dimensions is now in the course of erection.

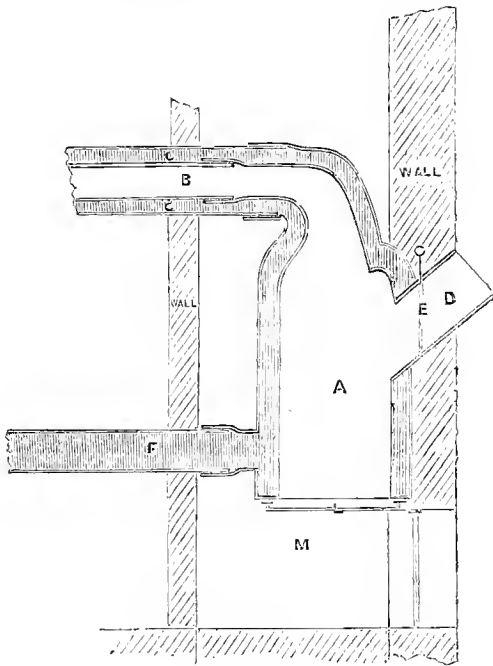

Fig. 1.

The principle will be understood by a reference to our engravings. A, is a conical boiler placed inside the house, and left quite exposed, so that all the heat radiating from it is distributed in the house. It is fed from the outside at n, and the door, e, is in the form of a damper which is raised or lowered at pleasure. The clearing by the ash-pit, m, is also done from the outside; so that while the entire surface of the boiler is inside the house there is no possibility of dust or sulphurous vapour entering to affect the health of the plants. The furnace-bars are represented at l. Issuing from the apex of the boiler, which is in the form of a huge retort, is a combination apparatus of flue and hot-water pipe; b, being the flue or core communicating with the furnace in the centre of the boiler, and c being the hot-water pipe surrounding the flue and communicating with the boiler surrounding the furnace. It is evident, therefore, that the heat which must necessarily pass through the flue,

B, during the whole of its length must be absorbed by the hot water, and given off in its turn from the surface of the hot-water pipe into the house.

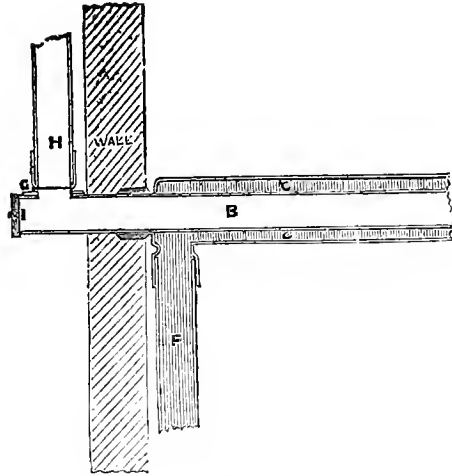

Fig. 2.

It will be seen by reference to fig. 2, that the flue, b, is not continued round the whole length of the house but is confined merely to one side, when it reaches the end of which it penetrates the wall and is then carried up an ordinary chimney-pipe, h, which is furnished with a damper, g, to regulate the draught. F, represents the return-pipe which flows in the ordinary way to the lower part of the boiler.

We have seen this system in operation, and we can state that it is most effective; the heat generated in the house is such as to make the water boil with violence, and that from fuel of the most common waste—such as refuse from the fires of the household, cinders, and dust. When we saw it the fire was then quite bright at nine o'clock in the morning, and had not been supplied since six o'clock the previous evening. The flue, b, is cleaned out by an opening at g, where a brush attached to a set of rods joined together is introduced and passed from one end to the other. Any further information as to the original cost can, we have no doubt, be furnished by Mr. Pierce, of the Nurseries, Yeovil; but as regards its efficiency and economy of fuel we have ourselves been eye-witnesses.

WORK FOR THE WEEK.

KITCHEN GARDEN.

THE manuring and trenching of vacant ground to be proceeded with in favourable weather, at which time the formation of new borders should be attended to, and all descriptions of work requiring the removal of earth. Beans (Broad), where the soil is dry enough to admit of it, make a second sowing of these, and also of Peas. The Early Mazagan and Marshall's Early Prolific Beans are good early sorts. Prince Albert Pea, although an early sort, is more susceptible of injury from frost than the other early kinds, but it does well when grown in pots and turned out early in March. Cauliflower, sow seed of this, as also of Lettuce and of Cabbage, in boxes, to be forwarded in a gentle heat and pricked out in a protected situation. They will succeed winter plants better than those sown in the open ground, and should the severe weather have destroyed those sown in the autumn, they will prove valuable as substitutes. Stir the soil amongst all growing crops, and earth-up young Cabbage to prevent injury from wind. Horseradish, make plantations in deeply trenched and well-manured soil if you would have it fine. Onions, select for planting the small ones of last year's growth, placing them a few inches apart on the surface of the soil and covering them with earth; they will be found useful to draw early in a green state, while others will bulb early for kitchen use. Now is a good time to sow a patch of the Two-bladed Onion in a warm sheltered situation. Sow very thickly, and protect with a mat or long litter only in very severe weather. Shallots, a well-prepared situation

to be chosen for these, some charred refuse applied, and the roots placed on the surface of the soil. By such treatment this useful bulb will increase most abundantly, no frost will injure them, and if worms are found troublesome at first, by displacing them, nothing more is required than a slight sprinkling of slaked lime; the roots soon push into the soil and become firmly fixed. I would again advise every one to try to carry on all his garden operations in a regular systematic manner, by correctly naming all his crops and keeping a memorandum of the time of sowing, planting, coming into bloom, and when fit for use.

FLOWER GARDEN.

Make the most of favourable weather, to push forward, while it lasts, new work and all out-door operations. Where the turf is at all unlevel, time should be spared in the course of this or next month to repair it, as if left later than February it might require some attention to make it take quickly. Unlevel turf is an eyesore all the season, and it makes mowing more tedious and difficult: hence it is worth an effort to make whatever little repairs may be necessary. Sweep lawns occasionally to clear them of fallen bits of branches, &c., and frequently use the roller here and on gravel to secure a firm smooth surface.

FRUIT GARDEN.

Cut the dead wood out of Raspberries. Prune Currants, and, where the birds are not destructive to the buds, Gooseberries also. If any fruit trees remain to be planted they should be looked after very soon. If it is worth while to occupy the ground with fruit trees and incur the expense of planting them, it certainly is worthy of serious consideration whether the ground is in the best state of preparation for being planted with fruit trees, and to incur any expense and trouble which may be requisite in order to render the ground as suitable as can be made for the kind of tree with which it is to be planted. To do this is seldom a work involving much direct outlay, for if the ground is well drained there is little else required except labour, rough materials—such as brickbats, rubbish, &c., for the bottom, and a supply of good loamy soil, all of which can generally be obtained about most places. It will prove a great disappointment to plant trees when there is not a fair prospect of their doing well; and the necessary preparations for securing their well-doing can be more conveniently, cheaply, and efficaciously made before planting than afterwards.

GREENHOUSE AND CONSERVATORY.

As the present weather is not inviting for out-door operations, advantage should be taken of it to regulate the greenhouse and frame plants previously to their commencing their spring growth. That the health of plants is materially influenced by cleanliness, is evident from the difference between the growth of the same species in the country and in the smoky atmosphere of cities and large towns. There is no doubt that the want of light and the dirty state of the foliage are the principal reasons why plants do not thrive in cities, &c.; but the success that has attended their cultivation in Ward's and other cases, proves that they can be grown in such situations provided they are kept clean, have all the light that can be procured, and are not parched up by an arid atmosphere, for it is to keeping plants free from dirt, and to supplying them with an atmosphere containing moisture proportionate with the temperature of their habitations, that we may attribute their successful cultivation in glazed cases. From the above observations, the amateur gardener who possesses a frame or a greenhouse, will perceive the necessity of keeping the plants clean, and washing the glass frequently, especially in dull weather. In regulating the plants it will be well to wash the foliage of Oranges, Camellias, and other smooth-leaved plants with a sponge and clean water, and the dust may be removed from Pelargoniums and other woolly-leaved plants by brushing them lightly with a soft brush. After the plants are cleaned the pots should be washed and the surface in each replaced with fresh soil, and, if they require it, the shoots should be tied to fresh stakes. A stick as thick as a man's finger is sometimes to be seen supporting the delicate stem of an herbaceous Calceolaria, or forming part of a trellis for a *Tropeolum tricolorum*, or some other fragile and elegant climber. This is bad taste, and it should be recollected that the more slender the sticks are the better, provided

they are strong enough to sustain the plant. Stout green thread and painted twine are good substitutes for matting. Plants in rooms should only receive water when in actual need of it—that is, when they begin to flag, and then only in sufficient quantity to recruit their strength, but they must be kept as near the glass as possible. Pelargoniums that are not so bushy as may be desired must have the point of each shoot pinched out, and the same may be done with other plants of loose habit.

PITS AND FRAMES.

Give air at all times when the exterior temperature is a few degrees above the freezing-point, and remove the sashes entirely on mild dry days. W. KEANS.

DOINGS OF THE LAST WEEK.

KITCHEN GARDEN.

HERE little was done except in the way of gradually removing protection, and giving a little more to such plants as Globe Artichokes and Celery. As respects the latter, the mild weather will call for its removal as soon as the leaves and the ground are sufficiently thawed. The same as respects Cauliflowers under glasses. The litter has been removed from the top and packed close to the side ready for another emergency. The ground inside was stirred-up a little with a pointed stick as soon as sufficiently thawed. In such frosts as we have had we like the leaves of Cauliflowers and Lettuce to be slightly frozen, and the ground just crusted a little, before covering them up; and then if the frost lasted six weeks instead of six days, the covering might remain on all the time, and for a day or two after the commencement of the thaw, and the plants would look as well as if they had been shut up for a night only. Where the temperature is low and the atmosphere dry, plants suffer little or nothing from continued darkness. This continued darkness will not do where artificial heat is used. The plants will then lengthen; but there will be no appropriation of carbon to give them strength.

We do not perceive that we have suffered in anything, except as respects some Radishes that were sown over Carrots on a slight hotbed. They have become much drawn, and, if we let them stand, will be sure to have long necks, which the gardener so much dislikes to see. The bed ought to have been uncovered or air given, so as to bring the atmosphere close on the freezing-point. A fine bed of Asparagus is also just a shade too white, but is fast turning green. A little less covering might have done for it, but then there was an anxiety to make all secure. We had thrown a nice heap of dung together to ferment for beds, but every bit of it, and all comestible material was used; and with the wind still full north and a rising barometer, we must allow it to remain in heaps, in case it should be wanted again.

Even as respects this litter there is a little matter worth attending to, and which most men want a little looking after to make them to do it: and that is to keep all such litter as dry as possible, as the drier it is the greater its nonconducting power. Ten to one the person who uncovers will bring it all down from frames and pits, and leave it in a ridge in front of them as close as well can be. Every drop of rain not only wets it, but all that runs from the glass will soak into it and rise through it by capillary attraction, and very likely when you want it you have nothing to go to but litter frozen into hard unwieldy masses. The remedy is to move it from the frost, and clap it together in little cocks ready for use at any time. Of course where there is nothing more required than to go to a farmyard for a load or two of litter as needed, such nicety is not required, as the more wet the litter receives the easier will it be to convert it into a good fermenting heap; but where litter must be husbanded and made the most of this simple hint may be of use.

For all such things as early Cucumbers and Melons in frames and pits, where the heat has chiefly to be sustained by fermenting material, the mode of covering in severe weather must ever be a matter of importance. We have found nothing better than a clean mat or cloth next the glass, some clean dry hay or straw over it, and then a

wooden cover or a waterproof cloth to keep all dry. Care must be taken that no part of the covering extend beyond the glass frame if linings are used for giving heat, as, by mats or other material hanging over, the steam from the linings is apt to be drawn inside, to the injury or destruction of the plants. Such heated places must be exposed to light every day, unless indeed there were a dense fog or a heavy snowfall. In all such forcing, and if dull weather sets in, dryness inside is best maintained by banking up the sides of the frame or pit with fermenting material, as the greater the heat from it the more will the boards of the frame or the walls of the pit be dried. This plan will also insure a sweet suitable atmospheric temperature without the risk of having too much bottom heat, which is often more ruinous than is generally imagined.

Found plenty of stumpy Sea-kale, Asparagus, and Mushroom-beds, very useful in such weather. Swept over the Mushroom-beds, and covered them afresh. A fresh piece with a good many droppings in it, now forming, helps to keep the house warm enough, and a slight covering of hay and straw prevents any dripping, condensed from the moist dung, from falling upon and disfiguring the Mushrooms. Kept some Horseradish in sand, in case the frost should again get severe, and as soon as the ridged-up ground is sufficiently thawed will turn it over, and leave it in ridges again, as frost is one of our best ameliorators of soil. We never saw so much agricultural ground ploughed up early as this season, and, no doubt, the frost would shatter it well.

FRUIT GARDEN.

Kept bringing on Vines in pots slowly. Moved a lot in pots into a narrow pit, where they can have bottom and top heat. Potted-off Cucumbers. Gave all the air possible to a Peach-house stuffed with bedding plants, as the little heat given to keep out the frost is swelling the buds sooner than we want them. The air will keep them back, and also keep the bedding plants from damping, which had begun to show itself in a few placed on the floor of the house. Moved a lot of Strawberry plants from frame into first vinery, which is also filled with plants, temperature about 50°. When it rises towards 60° other plants will be introduced. Took the opportunity in the dripping weather to fill another two-light box with Strawberries, chiefly Keens', with a few leaves below them, sufficient to yield a gentle heat. Went over all the rest of the Strawberry-pots now under cover, and examined them all, turning out plants that showed signs of worms, picking the worms out and placing them in a pot of lime, replacing the ball, after seeing that the drainage was all right, removing a few withered leaves, scratching off a little of the surface soil, and replacing with a little fresh loam and crowding firmly pressed. If such pots had been out of doors we would have moved no withered leaves as yet. Stuck a few short evergreen twigs among tender Strawberries in the open ground. We notice a discussion that has been going on as to the merits of mowing and not touching the leaves of Strawberry plants after the fruit is gathered. There seems, however, to be no principle left to guide us. Some years ago that principle was clearly and fully alluded to in this work. In strong, heavy soils, so suitable to the Strawberry, we should never think of cutting off leaves. In light soils where the fruit comes early to maturity, and the foliage comes long and slender, independently of manuring and firm pressure of the ground, as recommended in such circumstances the other week, the cutting-over is often attended with beneficial results. The man of general intelligence, though he advocates one system for general use, will be the first to acknowledge that circumstances so alter cases, that quite a different system may at times be advisable. For instance: the Strawberry will stand a great amount of manure, and look for more; but we think we detailed an instance of a barren plantation last year, the plants in the highest health and vigour, but no flowers—the result of heavy manuring and rich manure-waterings until late in autumn.

As the weather permitted went on with pruning the hardier fruit trees, and especially Raspberries. The modes of training Raspberries are endless—so many stems to a stake a yard apart, these stems brought to meet in the form of an arch, or the plants placed equally along rows 4 feet apart, and the stems laid 3 or 4 inches apart to a rough fence of slight bars of wood, or to an elegant fence of

strained wire. On the whole, we rather prefer the last mode but it is of little consequence how the plants are trained if the stems are not left too thick. It is as well not to shorten the canes until the weather is more settled, especially if the canes stand upright, as the wet is apt to get into the centre of the cane when shortened, and the frost will then frequently split the cane. When the points are arched over the cutting now is of less consequence. The Raspberry dearly likes cool manure, and applied chiefly as top-dressings, as digging to any depth is sure to destroy great numbers of the best fibres.

ORNAMENTAL DEPARTMENT.

After seeing that houses were warm enough to be safe, our chief care has been securing comparatively hardy and half-hardy plants from damp and frost. Our Calceolarias were covered up for a week, and look as nice as the afternoon they were first shut up. They have had air back and front in these mild days, but we have not yet taken away the protecting material from the neighbourhood of the pit. Many plants in frames we have managed to remove to empty vineries. Some Golden Chain Geraniums had lost a number of their leaves from damp; though in a drier atmosphere, we have no doubt, the plants will break well again. A lot of Chinese Primulas in small pots must have a larger size to succeed those now in bloom; and the same may be said of Cinerarias. Had soil nicely aired ready for repotting the earliest Pelargoniums, and also for starting Gloxinias, Achimenes, &c., and made preparations for commencing propagating for the flower garden what we are scarce of, and of which we want a large supply. Auriculas, Polyanthus, Carnations, and Pinks in cold frames, if much frosted, should have been allowed to thaw very gradually. A mat on the glass after the thaw commences is often of as much importance as in the time of frost, and no sunlight should beat at all strong upon them until all trace of the freezing has gone. A sudden exposure to light even of bedding plants, if frost has at all penetrated, will do more harm than even the frost has done. When plants have, therefore, been shut up for several days, it is bad policy to uncover them wholly on a very sunny day. If that must be done a little shade should be given during the brightest hours. Even bulbs and low shrubs coming on in hotbeds without fire heat must have similar care. They must not be left long uncovered after the tops are growing, or they will become sickly and drawn; and in moving bulbs, such as Hyacinths, from a frame to a house with abundance of light, a little shade should be afforded at first, that no check may be given from the extra abundance of light. At this season, when Hyacinths well rooted are moved to a light warm place from one more shady, the flower-stems will be benefited by having placed over each a paper funnel some 8 inches long, with a small hole at the upper small end. The funnel will sufficiently shade the bulb; and the stem rising freely to the light through the hole in the top, there will be room given for the little bells to expand themselves. Neapolitan Violets must be kept from frost by covering; but in all favourable weather there must be plenty of air, or damp on the one hand, and red spider on the other, will be apt to show themselves. All such plants as Stocks, double Wallflowers, &c., will want plenty of air in this muggy weather. The best way to give it is to elevate the sashes back and front, and that will prevent any rain reaching the plants.

One word more as to protection. One correspondent says, "I cannot make out how the frost could be kept out by merely turning and knocking about a limited quantity of litter. Would it not be better to pitch on the litter a foot or two thick at once?" That depends much on whether the litter is to be had. Some years ago we endeavoured to explain the whole theory of protection from the phenomena of dew, and the striking fact that dew is never seen until the material on which it appears is rendered colder than the surrounding air. The shade or protection that would prevent a body being covered with dew would also to a certain extent prevent the entrance of frost, or in other words arrest the free radiation of heat in straight lines. Thus a mere covering of glass will save the plants beneath it from frost until, from continued radiation from the glass, the air within becomes assimilated to that without. Place a mat over the glass, and the mat must be frozen before

the glass is affected; but if the frost is intense the whole heat enclosed will soon be radiated through the glass and the mat. Place some dry litter over the mat; and the drier and the more porous the material—the more air shut in, in fact, with it—the more difficult will it be for heat to pass off or radiate in straight lines. We have often been surprised to see what a keen frost would be thoroughly excluded by a thin covering of dry hay. Of course the frost would penetrate in time. In every case that penetration of frost, or, more properly speaking, the radiation of heat in straight lines, will commence at the surface. Break and turn the surface often, and the frost must just begin its work afresh; so that actually that fresh turning of the outside litter is the next best thing to throwing on a layer of fresh litter. In both cases radiation must commence anew in order to cool the interior.—R. F.

COVENT GARDEN MARKET.—JAN. 16.

The fruit market remains in nearly the same condition as in last week. Hot-house Grapes and Pears are becoming more scarce. The principal outdoor vegetables now to be obtained are Savoys and Brussels Sprouts, which are tolerably plentiful. Large quantities of Cornish Broccoli packed in crates are now coming in. Excellent Endive and Lettuce are also brought from abroad. Cut flowers principally consist of Camellias, Pelargoniums, Acacias, Early Tulips, Hyacinth, Violets, Roses, and Mignonette.

FRUIT.

	s.	d.	s.	d.		a.	d.	s.	d.
Apples.....	½	0	1	0	Mulberries.....	quart	0	0	0
Apricots.....	doz.	0	0	0	Nectarines.....	doz.	0	0	0
Figs.....	doz.	0	0	0	Oranges.....	100	4	0	10
Filberts & Nuts 100 lbs.	0	0	0	0	Peaches.....	doz.	0	0	0
Grapes, Hot-house.....	lb.	6	0	10	Pears.....	bush.	8	0	12
Foreign.....	doz.	1	0	2	dessert.....	½ sieve	6	0	10
Muscats.....	doz.	6	0	10	Pine Apples.....	lb.	5	0	8
Lemons.....	100	6	0	10	Pomegranates.....	each	0	3	0
Melons.....	each	3	0	5	Walnuts.....	bush.	14	6	20

VEGETABLES.

	s.	d.	a.	d.		s.	d.	s.	d.	
Asparagus.....	bundle	6	0	10	0	Leeks.....	buach	0	4	0
Beans, Broad.....	bush.	0	0	0	0	Lettuce.....	score	1	0	2
Kidney.....	100	3	3	5	0	Mushrooms.....	pottle	1	0	1
Beet, Red.....	doz.	1	0	1	6	Must. & Cress, punnet	0	2	0	0
Broccoli.....	bundle	0	2	2	0	Onions.....	doz.	2	0	4
Brussels Sprouts.....	½ sieve	1	6	2	0	pickling.....	quart	0	6	0
Cabbage.....	doz.	0	0	0	0	Parsley.....	buach	0	4	0
Capsicums.....	100	0	0	0	0	Parsnips.....	doz.	0	9	1
Carrots.....	buach	0	6	0	0	Peas.....	bush.	0	0	0
Canflower.....	doz.	3	0	6	0	Potatoes.....	sack	5	0	8
Celery.....	bundle	1	6	2	0	Radishes doz. bunches	1	6	2	0
Cucumbers.....	each	1	0	3	0	Rhubarb.....	bundle	1	0	0
Endive.....	score	1	3	2	6	Savoys.....	per doz.	1	6	3
Fennel.....	bunch	0	3	0	0	Sea-kale.....	basket	1	6	2
Garlic and Shallots, lb.	0	8	0	0	0	Spinach.....	½ sieve	4	0	6
Herbs.....	bunch	0	3	0	0	Tomatoes.....	doz.	0	0	0
Horseradish.....	bundle	1	6	4	0	Turnips.....	buach	0	4	0

TRADE CATALOGUES RECEIVED.

Lucombe, Pince, & Co., Exeter Nursery.—*Select Catalogue of Vegetable, Agricultural, and Flower Seeds, &c.* 1864.
 B. S. Williams, Paradise and Victoria Nurseries, Holloway.—*Descriptive Catalogue of Flower and Vegetable Seeds for 1864, with Supplementary List of Bulbous and other Roots.*
 W. Cutbush & Son, Highgate.—*Catalogue of Select Vegetable, Flower, and Farm Seeds for 1864.*
 Charles Turner, Royal Nurseries, Slough.—*Catalogue of Seeds for the Kitchen Garden, Flower Garden, and Farm, 1864.*
 William Paul, Paul's Nurseries and Seed Warehouse, Waltham Cross.—*Select List of Vegetable, Flower, and Agricultural Seeds; and Descriptive List of Strawberries and Grape Vines.*

TO CORRESPONDENTS.

CACTUS CULTURE (*An Admirer of the Cactus Tribe*).—We will publish some very full notes upon this subject next week.
VINES BREAKING (*G. N.*).—Yes, it is a good plan to let the Vine branches hang down till the buds are broken—that is, expanding into leaves. The Vines will under such circumstances not be so likely to burst their buds at the top, from the fact that the top, being let down to a lower level than the bottom, is in a lower temperature than if tied up in their permanent position. We think that this is more the cause than the check which the slow of sap receives.
WORK ON COLLECTING, &c., NATURAL HISTORY SPECIMENS.—A correspondent, "E. M. J.," obligingly writes—"The Taxidermist's Manual, by Capt. T. Brown, will possibly give 'W. C. C.' the information he needs. It enters more fully into the subject of collecting specimens and preserving them than does either Swainson, or Kirby and Spence."

PEACH BLOOM-BUDS FALLING (*A New Beginner*).—We are not certain about the dryness of the soil causing the buds to drop. If the soil was excessively dry that certainly would cause the buds to lose their vitality, and when the sap rises the buds are thrown off. Peaches cast their buds more generally through defective buds being formed, either from lack of support whilst maturing when the leaves are on the trees, or from a deficiency of light caused by the shade of trees in front, consequently trees on the back wall of Peach-houses form defective buds which are thrown off with the flow of the sap into them. Keeping the roots very dry whilst the fruit is ripening, and allowing red spider to suck out the juices of the leaves prevent the thorough maturation of the buds, and they fall in the spring. The soil in which the trees are growing should be kept moderately moist in winter, and a moderate watering after the leaves fall will mostly serve to keep the stems fresh through the winter until the buds begin to swell in spring. If one watering is not sufficient two or more must be given to keep the soil moderately moist. As you are a three-years subscriber you will find many general hints on their cultivation, for the subject was never better discussed than it has been lately in our columns. If you will reduce your general hints to specific queries we shall be ready to answer them, but we are requested to enter too wide a field when general hints are asked for.

PROPAGATING-PIT WITH FLUE (*J. H. G., A Constant Reader*).—If you were to divide your pit and make a four-foot bed with the flue running up the centre of it, and cover it with tanner's bark, as you propose, it would for propagating purposes be equal to (and certainly handier than) a three-light-frame, heated by fermenting materials we presume. It would be necessary to cover the bed with glass a few inches above the cuttings. This is necessary to insure uniform temperature, and humidity or moisture. We do not think a flue would heat a bed 6½ feet wide sufficiently for propagation, and how the heat of the house is to be kept up we do not see clearly, nor how the air is to be kept humid. Such a pit, however, would do well enough for propagating the ordinary description of bedding-out plants, but they would be longer in rooting than where there is less space above the plants. If you could maintain a bottom heat of 75°, and an atmospheric temperature of 70° to 75°, we think your pit would answer very well, but we fear it would not secure that.

VERBENAS PLANTED OUT (*Idem*).—We should leave the Verbenas in the frame and transplant them in March, planting again in the frame, unless it be wanted for other purposes, which transplanting will bring the roots nearer the stems, and enable you to move them to their final quarters in May with good balls. If the frame be wanted you will pot them. The book you name cannot be had in Numbers. The bits of plants enclosed were too small for identification, and smashed in coming through the post.

CYCLAMEN SEEDLINGS, &c. (*A Subscriber since 1856*).—The seedling are to remain in the seed-pans the first season. They should be duly supplied with water until the leaves turn yellow, when water must be gradually withheld. It is advisable to keep them in a frame the first season, and not plant them out like established plants. Next August they should be potted singly into pots double the diameter of the corns, and afterwards treated like old plants. The best time for shifting large plants is when taking them up for the winter. Cyclamens are occasionally increased by offsets. They are to be removed from the parent when taken up for the winter, and potted like old plants.

CAMELLIA BLOOMS NOT EXPANDING (*Idem*).—We know of nothing that could possibly hinder the buds expanding except a deficiency of moisture at the root and too low a temperature. Try placing the plant in a temperature of 50°, and keep the soil healthfully moist about the roots. We are of opinion that the buds are too highly developed early in the season, and that the buds are kept too long in a dormant state, so that the new growths take what should be spent on the flowers. When the buds are too fully formed, appearing large for a long time before expanding, they very often fall when half expanded, and if the flower be examined it will be found to be dead where it joined the stem.

BACK NUMBERS OF 1863 (*J. F. Dawson*).—We have a few remaining of each of the year's back Numbers.

EXOTIC FERNS (*M. P.*).—"The Fern Manual" can be had free by post from our office, for *ss. 2d.* in postage stamps. It contains a description of the best exotic Ferns, with directions for their cultivation.

PEACH TREES IN POTS OUT OF DOORS (*M. E. M.*).—Whilst your orchard-house is repairing, you had better move the pots to a colder place than the sunny border, and protect the trees either with branches or canvas, as, if the trees are exposed to severe frost, being so forward, the wood might be injured as well as the blossom-buds, and in that case the trees would suffer in the following year. We think that by keeping the trees back you need not lose a season.

PROPAGATING POINSETTIA PULCHERRIMA (*A Subscriber*).—You cannot succeed with this Poinsettia in a cool conservatory. In a warm one, kept at from 50° to 65°, you will succeed in blooming it. We presume you mean to raise plants from cuttings. Well, when the plant has done flowering, set it in a place where it can be kept rather dry, and in a medium temperature of 50°. This will cause the leaves to fall and the juices to thicken. When the stems are dried a little then cut them down, and make them into cuttings of 3 or 6 inches long in the usual way, much as you would do a Currant cutting. Stick the lower end into dry sand for a few days, then fasten each firmly in a small pot in sandy soil, and place them where they can have a heat of from 60° to 70°, and give little water until the buds are broken. Keep shifting them on during the season, giving the plants all the light possible, and all the heat up to 80° or so. Grow in peat, loam, and a little lime rubbish and crowding. About September give all the light possible, and begin to curtail watering. After June there must be no stopping of the plants, or rather after May, as the flowers and floral leaves are produced at the points of strong well-tipped shoots.

JOINTS OF IRON PIPES LEAKING (*Idem*).—You do not give us any data from which to judge whether your tank will do what you want or not. See "Doings of the Last Week" a fortnight ago. If you give more particulars, we will be glad to oblige.

FUNGUS ON TAN-PLUNGED POTS (*M. A. M.*).—If you do not shift the tan and give fresh pots, dash freshly slacked lime over the fungus, and stir it through the tan. We never found anything of the fungus tribe that would withstand quicklime. We suspect it is a Lycopodium, and if left alone would soon render a house hideous, but the specimen you sent was completely smashed.

EARLY CUCUMBERS (*An Amateur Gardener*).—There are no better Cucumbers for early forcing than Lord Kenyon's, or Sion House, and for a large size the Volunteer. These are smooth-skinned, and white-spined if they have any. We have heard Ward's Great Western spoken of, but have not grown it. For a Black Spine, few will equal Cuthill's Early Black Spine. We have seen the Snake Cucumber some yards long. It is very poisonous, and is grown merely for ornament. We do not understand about the leaking, but it strikes us that the leakage is not from the pipes but from the tank. We have never found concrete, or red or white lead fail. We think 4 inches of water is deep enough in the tank.

HEATING (*C. J. Langley*).—We have carefully read over your letter; and though our impression is that you could carry out any of the plans you propose, either by a boiler at c, or an Arnett's stove and a boiler at n, still we think all these plans are a departure from the simplicity of heating your two houses separately, by just placing another furnace by the side of A for heating the larger house; and the extra expense of that furnace, and a flue in the large house across to e, would be trifling in comparison to the trouble of pulling your present furnace to pieces to fix a boiler, or the building of an Arnett's stove inside, close to the chimney n. By that separate furnace you would heat each house independently of the other, and more especially as in either case you will require a chimney at f. If disposed, the flue in the large house, after reaching e, might be formed of strong draught-pipes, 8 or 9 inches in diameter. On the principle of simplicity, and letting well alone, the above is the plan we would recommend. Most likely, however, you will prefer your own idea; and people generally make that plan succeed the best on which their minds are most favourably set. We will therefore add a few remarks which may be useful. 1. A small fireplace will scarcely be sufficient to heat, by means of a flue, two houses 56 feet by 14, and 34 feet by 14. To accomplish it at all, there must be a careful management of slides and dampers at n and e, so as to give the desired heat to any of the two houses. A little carelessness as respects these slides might be productive of serious results, which would not be so likely to happen if each house had its own furnace. 2. The mere placing a boiler over a furnace, so as to form as it were the top of the flue, will not give the best position for a boiler absorbing heat, as the most of the heat from the fuel will pass along the flue. If the boiler is fixed over and in the fireplace in the usual way, so as to obtain the greatest amount of heat, then, in proportion to the heat thus absorbed, the less will be left to pass along the flue. 3. If there is an absolute necessity for having only one fireplace, then a small saddle-back, placed well in the furnace—not on the top of it—or a Rivers' small saddle-back suspended in it, which you may procure from Mr. Hughs, of Bishop Stortford, for from 30s. to 40s., would enable you to heat the smaller house by tank or pipes, provided you could draw the slide at n, and get the flue heat also, in cold weather, for the benefit of your Muscats. It will generally be found that a little regulating of the slides will be necessary when both flues are to be worked at once. We think Mr. Rivers' boiler would suit you best, as, being so shallow, you would need to elevate your tank very little. Three or four inches of water would be enough in your tank. Recollect that if securely covered with slate the heat from it will be almost as dry as from a flue; but it will be sweet and free from unwholesome vapours, &c. The above would be the simplest, and you would need no more furnaces; and your proposed plan of a stove close to the chimney at n would necessitate the lighting the fire in the house, and the stove would require to be sunk a little, or else your tank might be inconveniently high; but so far as the heating by hot water merely, without thinking of the heat from a flue, that mode, as respects fuel, would be the most economical, as the heat from the stove would strike at once on the boiler, and the block against the smoke-pipe would prevent much conduction of heat into the chimney, though what went there would be chiefly lost to the house. On the whole, then, according to your own plan, we would fix such a boiler over your present furnace, and still retain the use of the flue when necessary; but as, according to your own showing, the present heating answers well in the smaller house, we would advise another furnace and a separate flue for the larger house. Were it not for the expense, we would advise a 30-inch saddle-back boiler, take the flue as now, and heat the large house by hot water, with a couple of pipes in the smaller one. If, with your contemplated arrangements, you wish to have moist heat from the tank, you must leave moveable spaces in the covering to let out the vapour. In your late house, if you wish the Peaches to continue fruitful, the Vine-stems should not be nearer than 5 feet to each other.

THE SMALL GARDEN AT TRENTHAM (*F. E. M.*).—You will obtain no satisfaction from such a figure in 5½ feet on grass, which you are to sow. Gravel would be much better. With grass you could only succeed by reducing the size of the beds, and increasing the width of the paths, so as to have none under 3 or 3½ feet. Then we would use turf at once, and a great deal would not be needed, as you would only want it between the beds. A simpler figure would also suit you—thus: Make a circle in the centre of 10 feet in diameter, 5 feet from centre; then another circle 9 feet from centre, which will give 4 feet for grass; then another circle 18 feet from centre. Between these two circles of 9 and 18 feet lay down eight clumps as previously advised, four heart-shaped with the points to the outer circle, and four triangular-shaped with their broad ends on the outer circle, and the points on the inner circle, and so managed that there shall be a regular 3 feet between each and all of these beds. Then run another circle of 3½ feet of grass all round these beds, and then you will have the outside border of 5½ feet, which you may cut up into two, four, or eight divisions. Nothing could be simpler, and no combination will set off colours better. If we would make a change, it would be to make the outside path round the eight beds 4 feet as well. Nothing can tell worse or be more difficult to manage than narrow strips of grass between beds. With gravel you may have the paths narrower, but the beds will appear too much thrown together.

FOREIGN SEEDS (*J. A.*).—Moon Creeper is probably Menispermum planifolium or M. amarissimum, both of which have yellow flowers, being evergreen stove climbers, growing 10 feet high, and may be grown in loam and peat. Eucalyptus obliqua is a timber tree in Van Diemen's Land, growing 100 feet high; the flowers are white, produced in July or August; it also may be grown in loam and peat, and is a cool greenhouse tree. Prostanthera lasiantha, an evergreen New Holland plant, grows about 3 feet high, and has purplish white flowers in June; it is a greenhouse plant, and requires a sandy peat soil. Panax dendroides we do not know. Eurybia corymbosa, we presume, is meant by E. ramulosa—a hardy herbaceous plant of the Aster tribe, growing 2 feet high, and has white flowers in August. Dracæna (Cordylina) australis is distinct from C. indivisa; it is a greenhouse plant, and grows well in loam and peat.

IVY FAILING (*J. S.*).—As the Ivy succeeds on three of the four walls round your enclosed court, the cause of its failure on the fourth side must arise either from the soil or the aspect. If the failure occurs on the wall facing the south, and the soil is very dry, this may be the cause.

HEATING VINERIES (*W. T. B.*).—To heat two vineries, each 21 feet long 17 feet wide, and 11 feet high at the back, a saddle boiler from 26 to 30 inches long would be sufficient. To have Grapes about August, you would require for each house about 112 feet of piping. To have Grapes ripe in May, you would require double that quantity. Good piping used to be had for about 3s. per yard, elbows, &c., extra.

OUR JOURNAL (*W. W.*).—Our first volume appeared in 1849. There are twenty-five volumes of the first series, and five volumes of the second series. They can all be had except Vols. I., XV., and XXI. of the first series, and Vol. II. of the second, at 8s. 6d. per vol.; Vol. III. of the second is 12s. The sentence you name alludes to some public societies connected with our objects.

FRUIT-ROOM (*F. A. C.*).—Fruit does not keep well this year. Exclude both air and light, and keep the room as cold as possible—35° is quite as high as the temperature ought to be. When you wish to hasten the ripening of any of the fruit, bring the desired quantity into a warmer room.

CHRISTINE GERANIUM LEAVES SPOTTED (*E. W.*).—We think the leaves sent are infested with mildew; but we are not quite sure about it, for the spots appear regularly dotted all over the leaves, and are nearly of an uniform size. We do not remember seeing leaves in the same condition before. They have the appearance as if dotted and blotched with silver, and must appear very beautiful, we should think, on the plant. We do not observe any symptom of decay in the parts affected, and are, therefore, inclined to attribute the spots to some freak of nature. We would recommend the leaves to be dusted with sulphur, and the plant to be placed in a light airy situation in the greenhouse. If it be mildew the sulphur will kill it, and the leaves will afterwards come green unless the dots are natural, when they may remain, or they may come all right as growth progresses. We should like to know whether the leaves decay or remain in the same condition as those enclosed, and if all the leaves are similarly affected.

ROSES (*Quæro*).—The whole of your Roses will do very well in the orchard-house if the pots are plunged; and if in extra severe weather a little fern or dry straw is stuck in among the tops, and removed as the weather gets mild.

GARDEN PLAN (*W. O. G.*).—We think the plan will look very well, but the four heart-shaped corners will look bare without evergreens; and we think the ovals in the central figures for flowers are scarcely artistic enough for the other groups or figures.

NAMES OF FRUIT (*Subscriber*).—What became of the four Apples we cannot now say. They were cleared out of our office with other fruit we had done with. Pray number any others you send, it saves trouble.

NAMES OF PLANTS (*A Four-years Subscriber*).—It is Centaurea candidissima.

POULTRY, BEE, and HOUSEHOLD CHRONICLE.

MR. WILLIAMS'S GAME FOWLS AT THE BIRMINGHAM POULTRY SHOW.

I MUST plead guilty to the fact of never having seen a copy of your paper until a day or two ago, when, by the kindness of a friend, my attention was drawn to the correspondence which has for some weeks been going on in your columns relative to the Game fowls exhibited by me at Birmingham, and disqualified by Mr. Hindson, one of the Judges, on the ground that they were his property.

I make no remarks as to the rather uncourteous way in which some of your correspondents treat me. I refer them to the *Field* newspaper of the 2nd inst. for my statement as to my position in this matter.*

* The following is the communication to our sporting contemporary referred to by Mr. Williams: "It is not my intention to discuss the 'good name' Mr. Hindson has established as a Judge at various exhibitions, any more than it is to question the fact of his having been not only the first but the only person to assert (not discover) 'that the birds exhibited were his property,' but I do mean to affirm that his endeavour to make the question at issue, being the first person to claim the birds exhibited the question at issue, shows a sensitiveness upon and a desire to avoid the real question—whether the birds were or were not his property. Now, as to this question, I most emphatically deny that any of the birds belonged to Mr. Hindson, and I challenge him to enforce his claim to them. Of the whole number exhibited he had never seen but one before the Show; and his having borrowed it for exhibition some ten months ago at Liverpool gives him no reason for alleging it to be his own. In your advertising columns last week I offered the whole of the birds exhibited for sale; and here tell Mr. Hindson that if he believes they or any of them are his property, he will vindicate his claim before some tribunal competent to decide the question. He may have had Game fowls at walk in the neighbourhood of Welshpool, and may have still, but he has not been applied to by 'the person in charge' of them to lend any of them to me, or I am greatly misinformed.

"The man alluded to above as 'the person in charge' received a letter from Mr. Hindson, dated the 7th ult., of which the following is a copy:—

"Liverpool, Dec. 7, 1863.

"Mr. Evan Pugh—Sir, I have no reply from you about the pen Black Reds for Leeds. Do you again prefer sacrificing the entrance-fee and paying the fine, or have you found another dunc and entered some in his name? I should think Williams feels grateful to you for figuring in the London papers in the way he has done. Yours, &c., 'JOSEPH HINDSON.'

"Mr. Hindson will doubtless read this in print, and, passing over the tone adopted towards myself, will doubtless consider it necessary to satisfy

I may affirm that the birds are not, nor were they ever, the property of Mr. Hindson.

The private mark so much spoken of is not Mr. Hindson's. There were other fowls at Birmingham similarly marked, one a winner.

Your correspondent "EGOMET" may satisfy his pardonable curiosity as to me, my position or residence; and he may at the same time see some fowls that have never been exhibited as good as anything I had at Birmingham, and I can show him probably as many in number and as good a selection of Black Reds and Duckwings as any amateur breeder in England. If he be the man he assumes to be I should like to see him at my place.—J. H. WILLIAMS, *Spring Bank, near Welshpool.*

THE KENDAL EXHIBITION OF POULTRY AND PIGEONS.

FROM the very institution of this Show, now dating so far as nine years back, Kendal has always stood well in the lists of our annual poultry exhibitions. Year by year there have been marked improvements both as to the number of entries and also the high quality of the birds competing, but undoubtedly the Show just closed has far surpassed those preceding it. Under the guidance of so energetic a Committee as that at Kendal such a result may always be depended upon, and we confidently believe that the failure of certain other exhibitions of like character during the year 1863, has rather to be attributed to the supineness of their local Committees than to any apathy on the part of either the public or exhibitors. This year the Show was held in the same building as last season, and for the purpose it presents every necessary feature that could be desired, whilst its close contiguity to the Kendal Railway Station is a great boon to visitors from a distance. The first day of opening was most unfortunately exceedingly wet until about midday, when the fog became so dense as to necessitate the immediate lighting of the gas, which, however, at the best is but a very poor substitute for daylight, and one that when critically examining poultry, particularly the strictly fancy varieties, can scarcely be depended upon. This unexpected drawback naturally prolonged the arbitrations for some couple of hours beyond the time required in former years, but was in itself an exigence for which under all the circumstances no amount of foresight could provide. It is well known to most of our readers also, that no description of poultry can be shown to advantage under the influences of tremendous fogs, for at such times poultry invariably assume a sullen listless disposition from which it is more than difficult to arouse them even temporarily.

In the *Spanish* classes were to be found birds from the yards of almost all of our principal breeders. Mr. Cannon, of Bradford, took the silver cup with chickens; Mr. Rodbard's excellent pen of adults standing first in the class for old birds. The condition of the cup Spanish chickens was nearly faultless. In *Grey Dorkings* the cup award fell to the old birds from Mr. Evans, of Prescott, but justice compels us to add that the Grey Dorking chickens were far below our expectations throughout the class. We must come to *Cochins*, and again the old birds had it all their own way, for the chickens were a defective class throughout. A silver cup, value five guineas, the gift of the executors of the late G. A. Geldard, Esq., of Acrigg End, near Kendal, for the best pen of Cochins-China fowls proved a much-coveted prize,

the Show Committee and the public that, notwithstanding such letter, in disqualifying the birds I exhibited he was making a *bona fide* claim, and not actuated by a desire to punish the "person in charge" for not sending fowls to Mr. Hindson himself, and so causing him "to sacrifice an entrance fee and pay a fine." He cannot in the face of that letter assert that the man was his servant, and I cannot detect in it the language of an owner of the fowls asked for. My only complaint against the poultry Committee is on account of their not having given me some intimation of Mr. Hindson's claim before announcing that the birds were disqualified. As a large breeder of Game fowls and a subscriber to the Show, and having a "position" equal at all events to Mr. Hindson's, and one which I would not "jeopardise" by an act so disreputable as that of exhibiting any birds without the consent of the owner, the doing so to me would not have been considered as an excess of courtesy to myself or as light to Mr. Hindson. The Committee are anxious that I should contest my right to the prizes with Mr. Hindson, and the public will doubtless expect him to relieve the Committee of responsibility; and if he will establish his claims to the fowls I will cheerfully exonerate the Committee from any claims I may have against them.—J. H. WILLIAMS, *Spring Bank, Welshpool, Dec. 23.*

simply on account of the very peculiar circumstances under which it was offered. It will be remembered that the deceased gentleman for many years was one of the most notable, and at that time the most successful of Cochins-exhibitors, and, as he stated to ourselves, when at the meridian of his success, "he had travelled again and again many a long day's railway journey in the hope to obtain better fowls than his own, but always hitherto unsuccessfully; still he would try again if he heard of any likely to be so." From declining health, for some years past Mr. Geldard ceased to exhibit; yet the love of Cochins never wore out, and so great was it, that even after death we find a silver cup as the reward offered for the improvement of this favoured breed. It will not be a matter of surprise to our readers to find that this cup will now belong to Capt. Heaton, of Manchester. This gentleman's best pen of adult Buifs obtained their triumph without difficulty. Such long-continued success will doubtless add much to the interest of the disposal of Capt. Heaton's surplus stock of Cochins, which auction takes place at Birmingham next week. The White Cochins were few in number but good, and so were the White Dorkings. In *Game* fowls the Kendal Show stood well. Mr. Robinson, of Ulverston, exhibited a pair of Brown Reds that left little to wish for as improvement, and to them the Game silver cup was awarded. Their condition was unexceptionable. Mr. Fletcher, of Manchester, showed some closely-competing Black-breasted Reds, and Mr. Chune, of Coalbrookdale, some very capital Duckwings. Although we are now advanced to about the middle of the first month of 1864, we confess the two hens shown by the latter gentleman looked uncommonly like pullets of 1863, and we think the time would have been lost to look for them either as chickens or even eggs in 1862. Be that as it may, they were, either as adults or chickens, a most capital pen, and such as are only rarely to be met with—the only impression being the two old ladies looked very much younger than their reputed age justified, for length of days certainly had left no footprints behind. The Red Pile Game fowls were better than common. It is evident of late this breed of Game fowls is greatly improving. Mr. Billings, of Gravelly Hill, near Birmingham, showed some remarkably good Game fowls. As before hinted, on account of the intense fog, the *Hamburghs* showed to the worst advantage, for they proved almost indistinguishable, still, on very close inspection so good a collection was rarely to be seen. Perhaps the Golden-spangled were the best variety as a class, though the Silver-spangled pen won the *Hamburgh* cup. In the *Game Bantams* there was not so high an amount of condition as is indispensable for their successful exhibition, but the *Se-brights* were far better than in general, whether Gold or Silver-faced. They seem to be stay-at-home pets in this quarter, as they were entered at very high prices—even so high as £600 a-pen of three. Black and also White Bantams were in force, and very good throughout, but separate classes should be appointed for them.

It is quite an "old song" to say Mrs. Seamons won the prize for *Aylesbury Ducks*; but Mr. Henry Werrall, of Liverpool, took the Duck cup with such a pen of *Rouens* as are only very rarely to be seen. The *Single Cock* classes were well filled.

In *Pigeons* the Show was excellent; but the pens that were allotted to them were sadly too small, and must be enlarged before another meeting—an alteration, we believe, which will be joyfully acceded to on the part of the Committee.

We cannot allow a practice of late gaining ground to go unmentioned—the cutting away of *Almond Trumblers'* bills, with the view to make them shorter and more perfect. It is a most cruel practice, and entails an amount of torture that few would credit; the bill of a bird when bereft of a portion of its horny covering is of the most sensitive character, closely resembling a toe or finger nail cut into the quick; the agony of even a touch when thus cruelly operated on, makes the birds wholly or even at best partially incapable of feeding, and annually many excellent birds are lost by absolute starvation from this unnecessary practice. It is impossible to reprehend such cruelties beyond their deserts, and if those in power will withhold their sanction, it will no doubt be speedily abandoned. The *Carriers*, whether Black or Duns, were the best ever yet exhibited at Kendal. The *Pantails* were also very good. The *Powters* were prevented from showing favourably by the undue

smallness of the pens. White ones were numerous and very good. The Barbs were good, more particularly the Yellows. The Any variety of Pigeon class was well filled, Satinettes, Icelanders, Brunswicks, Swallows, Magpies, Nuns, and several others being well shown.

The Committee were very attentive to every requirement of the birds under their care.

SPANISH (Black).—First, J. K. Rodbard, Wrington, Bristol. Second, R. Teabay, Fulwood, Preston. Third, S. Robson, Brotherton, South Milford, Yorkshire. Highly Commended, R. Teabay; J. Shorthose, Shieldfield Green, Newcastle-on-Tyne. **Chickens.**—First and Cup, W. Cannon, Bradford. Second, H. L. ne, Bristol. Third, R. Teabay. Highly Commended, R. W. Boyle, Lundrum, Dublin; J. K. Fowler, Aylesbury. Commended, S. Robson, Brotherton, Yorkshire.

DORKINGS (Coloured).—First and Cup, W. Evans, Prescott. Second, J. Robinson, Garstang. Third, R. Sergecson, Liverpool. Highly Commended, J. White, Warlaby, Northallerton; Right Hon. Viscount Templetown, Milnforth; J. Robinson; J. K. Fowler, Aylesbury. **Chickens.**—First, W. Evans. Second, R. Sergecson. Third, J. K. Fowler. Highly Commended, Right Hon. Viscount Templetown; D. Parsons, Cuerden, Preston.

DORKINGS (White).—First and Second, J. Robinson, Garstang. Third, D. Parsons, Preston.

COCHIN-CHINA (Cinnamon and Buff, or Brown and Partridge-feathered).—First and Cup, Captain Heaton, Lower Broughton, Manchester. Second, R. White, Broomhall Park, Sheffield. Third, Miss E. A. Agnionby, Grasmere, Westmorland. Highly Commended, T. Stretch, Ormskirk; Captain Heaton; Miss E. A. Agnionby. Commended, F. M. Handle, Haslingden, Lancashire. **Chickens.**—First, R. White. Second, Captain Heaton. Third, C. T. Bishop, Lepton.

COCHIN-CHINA (White).—First, S. Taylor, Ibbotsholme, Windermere. Second, G. C. Whitwell, Kendal. **Chickens.**—First, Rev. F. Taylor, Kirkby Lonsdale. Second, F. W. Zorhorst, Bellville, Donnybrook. Highly Commended, G. C. Whitwell.

GAME (White and Piles).—First, T. West, St. Ann's, Eccleston, Lancashire. Second, J. Fletcher, Stoneclough, Manchester. Third, R. Wilson, Stramongate, Kendal. **Chickens.**—First, F. C. Elmsen, Kendal. Second, J. Clark, Levens, Milnforth.

GAME (Black-breasted and other Reds).—First and Cup, T. Robinson, Ulverston. Second, W. Whitwell, Stockton. Third, M. Billing, jun., Gravelly Hill, Birmingham. Highly Commended, J. Fletcher, Stoneclough, Manchester; H. M. Julian, Beverley, Yorkshire; T. West, Eccleston, Lancashire. Commended, J. Fletcher. **Chickens.**—First, J. Fletcher. Second, M. Billing, jun. Third, W. Whitwell, Stockton.

GAME (Any other variety).—First, J. B. Chune, Coalbrookdale, Salop. Second, H. Beldon, Bingley. Third, H. Worrall, West Deroy, Liverpool. **Chickens.**—First, J. Fletcher, Stoneclough. Third, J. Hodgson, Bradford. **Hens.**—First, J. Fletcher. Second, G. C. Whitwell, Kendal. Third, J. Geldard, Kendal. Highly Commended, G. W. Binns, Darlington.

HAMBURG (Golden-pencilled).—First, H. Beldon, Bingley, Yorkshire. Second, S. Smith, Nantawram, Third, J. Robinson, Garstang. Highly Commended, J. B. Chune, Salop. Commended, J. Garris, Bradford.

HAMBURG (Golden-spangled).—First, L. Davies, Harborne, near Birmingham. Second, T. Burca, Sheffield. Third, J. Newton, Silsden, near Leeds. Highly Commended, G. Whittaker, Horwich, near Bolton; R. Farrer, Bolton-le-Moors; N. Marlor, Denton, near Manchester.

HAMBURG (Silver-pencilled).—First, J. Robinson, Garstang. Second, W. Clayton, Kedgeley. Third, C. Moore, Poulton-le-Flyde. Highly Commended, H. Beldon, Bingley. Commended, T. R. Beetham, Kendal.

HAMBURG (Silver-spangled).—First and Silver Cup, H. Beldon, Bingley. Second, T. Davies, Newport, Mon. Third, J. Newton, Silsden. Highly Commended, G. E. Hardman, Kawtensal, near Manchester; J. Robinson, Garstang; J. B. Chune, Coalbrookdale, Salop. Commended, R. Teabay, Fulwood; J. Fielding, Newchurch, near Manchester; J. Robinson.

HAMBURG (Any variety).—First, T. Stuart, Savelley, near Kendal. Second, T. H. Ashton, Tamworth. Third, R. H. Nicholas, Newport, Mon.

ANY NEW OR DISTINCT VARIETY.—First, R. Teabay, Fulwood. Second, H. Beldon, Bingley. Third, R. H. Nicholas, Newport, Mon. Highly Commended, W. A. G. James, Kirkby Lonsdale; R. Thompson, Kendal; H. Lucy, Hebdon Bridge, Yorkshire; H. & G. Newton, Gartforth. Commended, R. H. Nicholas; C. W. Wilson, Kendal.

SINGLE COCKS.

SPANISH.—First, J. R. Rodbard, Wrington. Second, H. Lane, Bristol. Highly Commended, J. Siddal, Halifax; E. Smull, Middleton, near Manchester; J. K. Fowler, Aylesbury.

DORKING.—First, J. Robinson, Garstang. Second, J. Rowlandson, Windermere. Highly Commended, W. W. Rutthage, Kendal; R. D. Holt, Windermere.

COCHIN-CHINA.—First, E. Smith, Middleton, near Manchester. Second, J. Shorthose, Newcastle-on-Tyne. Highly Commended, Miss E. Agnionby, Grasmere, Westmorland.

GAME.—First, M. Billing, jun., Birmingham. Second, G. C. Whitwell, Kendal. Third, J. Fletcher, Stoneclough. Fourth, J. Hodgson, Whittington, near Burton. Highly Commended, T. Statter, Watefield, near Manchester; A. B. Dyas, Mawley, Shropshire; K. Parkinson, Poulton-le-Flyde. Commended, T. Statter; W. Boyes, Beverley.

GAME COCKEREL.—First, G. W. Binns, Darlington. Second, M. Billing, jun., Birmingham. Third, E. Bowers, Nantwich. Highly Commended, W. J. Cope, Barnsley.

GAME BANTAM.—First, J. Shorthose, Newcastle-on-Tyne. Second, J. W. Morris, Rochdale. Third, T. Wilson, Kendal. Commended, J. Munn, Newchurch, near Manchester; Miss E. A. Crawford, Southwell, Notts.

BANTAMS (Game).—First, R. M. Stark, Hull. Second, G. Maples, jun., Waverley. Third, R. Hawkesley, jun., Southwell. Highly Commended, Capt. Wetherell, Loddington; J. Crosland, jun., Wakefield; J. Munn, Newchurch, Manchester; J. P. Gardner, Kugeley; Miss E. A. Crawford, Southwell, Notts. Commended, C. Martin, Fairfield; M. Leno, jun., Dunstable.

BANTAMS (Any other variety).—First and Cup, M. Leno, jun., Dunstable. Second, F. L. Roy, jun., Berwickshire. Third, W. J. Cope, Barnsley.

Highly Commended, Capt. Wetherell, Loddington; W. T. Addison, Sunderland; R. M. Stark, Hull; J. P. Gardner, Kugeley; G. Maples, jun., Waverley; W. F. Entwistle, Otley, Yorkshire; T. Davies, Newport, Mon.; M. Leno, jun. Commended, J. W. Morris, Rochdale; O. E. Creswell, Hanworth, Middlesex.

DUCKS (Aylesbury).—First, Mrs. M. Seamons, Aylesbury. Second and Third, withheld.

DUCKS (Rouen).—First and Cup, H. Worrall, Liverpool. Second, T. Robinson, Ulverston. Third, T. Statter, Whitefield, Manchester. Highly Commended, R. Sergecson, Liverpool; S. Shaw, Stainland. Commended, J. Munn, Shawclough.

DUCKS (Any other variety).—First, D. Parsons, Cuerden. Second, J. R. Jessop, Hull. Third, R. M. Stark, Hull. Highly Commended, W. Bowley, Cirencester; F. W. Earle, Edenhurst; S. Shaw, Stainland; C. W. Wilson, Kendal.

DUCKLINGS (Aylesbury or Rouen).—First and Third, Mrs. M. Seamons, Aylesbury. Second, J. K. Fowler, Aylesbury. Highly Commended, R. M. Stark, Hull; F. M. Hindie, Haslingden; P. Longton, Liverpool; T. Shaw, Kirkham.

PIGEONS.

CARRIERS.—First, W. Towerson, Egremont. Second, J. Thompson, Bingley. Highly Commended, R. Thompson, Kendal; J. Reeder, Preston; H. Yardley, Birmingham; J. W. Edge, Birmingham; E. Horner, Leeds. Commended, T. Bateson, Kendal; J. K. Robinson, Sunderland; J. Firth, Dewsbury; H. Yardley.

ALMOND TUMBLERS.—First, F. Key, Beverley. Second, G. R. Potts, Sunderland. Highly Commended, F. Else, Bayswater, London; J. Reeder, Preston.

TUMBLERS.—First, H. Beldon, Bingley. Second, R. Thompson, Kendal. Highly Commended, W. Towerson, Egremont; F. Else, Bayswater, London; J. W. Edge, Birmingham. Commended, H. Yardley, Birmingham.

OWLS.—First, H. Yardley, Birmingham. Second, F. Else, Bayswater, London. Highly Commended, R. Pickering, Carlisle; W. Towerson, Egremont; H. Snowden, Horton, Bradford. Commended, R. Thompson, Kendal; M. E. Jobling, Newcastle-on-Tyne; J. Reeder, Preston.

POWERS AND CROPPERS.—First, G. R. Potts, Sunderland. Second, H. Beldon. Highly Commended, S. Robson, South Milford, Yorkshire; E. Brown, Sheffield; J. W. Edge, Birmingham; E. Horner, Leeds. Commended, F. Else, Bayswater, London.

BARBS.—First, H. Yardley, Birmingham. Second, R. Thompson, Kendal. Highly Commended, J. Reeder, Preston.

FANTAILS.—First, H. Beldon, Bingley. Second, H. Yardley, Birmingham. Highly Commended, F. Else, Bayswater, London. Commended, J. R. Jessop, Hull.

TURKENS.—First, S. Shaw, Stainland. Second, W. Jackson, Bolton-le-Sands. Highly Commended, J. Robinson, Sunderland; F. Key, Beverley; W. Towerson, Egremont; J. R. Jessop, Hull; J. W. Edge, Birmingham. Commended, M. E. Jobling, Newcastle-on-Tyne; F. Else, Bayswater, London.

TRUMPETERS.—First, S. Shaw, Stainland. Second, F. Key, Beverley. Highly Commended, F. Else, Bayswater, London; H. Yardley, Birmingham; J. J. Wilson, Darlington. Commended, F. Key; R. Thompson, Kendal; J. R. Jessop, Hull; H. Beldon, Bingley.

JACOBS.—First, R. Pickering, Carlisle. Second, F. Else, Bayswater, London. Highly Commended, R. Thompson, Kendal; H. Beldon, Bingley; H. Yardley, Birmingham.

ANY OTHER VARIETY.—First and Second, H. Yardley, Birmingham (Icelanders and Satinettes). Highly Commended, M. Irwin, Whitehaven; H. Beldon, Bingley (Swallows). Commended, R. Thompson, Kendal (Nuns); M. E. Jobling, Newcastle-on-Tyne (Swallows and Brunawicks); J. W. Edge, Birmingham.

The Judges were Edward Hewitt, Esq., of Eden Cottage, Sparkbrook, Birmingham; and J. H. Smith, Esq., of Skelton Grange, York.

KIRKCALDY ORNITHOLOGICAL SOCIETY'S SHOW.

This was held on the 4th and 5th inst. The following were the awards:—

DORKINGS.—First, J. Stocks, West Bridge. Second, T. Y. Craig, Galloway. Third, G. Spalding, Drumsturdie. **Chickens.**—First and Third, J. Stocks. Second, Countess Flahault, Tullypallan Castle.

SPANISH.—First, Miss B. Ridpath, Edinburgh. Second, R. Dixon. Third, G. Spalding, Drumsturdie. **Chickens.**—First, Miss B. Ridpath, Edinburgh. Second, W. Hay, Aberdeen. Third, J. Stewart, Perth.

HAMBURG (Gold or Silver-spangled).—First and Second, W. Kiddie, Cowdenbeath. Third, G. Spalding, Drumsturdie. Highly Commended, S. Young, Abbotsball.

HAMBURG (Gold and Silver-pencilled).—First, G. Paul, Kirkcaldy. Second, A. Pratt. Third, J. Ness, Pathhead.

COCHIN-CHINA.—First, Lord Loughborough. Second, R. B. Heggie, Kirkcaldy. Third, C. A. Lockhart, West Bridge. **Chickens.**—First and Third, Lord Loughborough. Second, C. A. Lockhart. Highly Commended, Mrs. Oswald, Dunnikier.

GAME.—First, J. L. Anderson, Chapel House. Second, G. Spalding, Drumsturdie. Third, W. Bonthron, jun., Kirkcaldy. **Chickens.**—First, J. Anderson, Links. Second, A. Chalmers, Woodside. Third, T. Williamson, Kirkcaldy. Highly Commended, A. Spalding, Kirkcaldy.

BANTAMS (Any variety).—First, Second, and Third, G. Spalding (Golden Schright, Silver Schright, Game).

DUCKS (White Aylesbury).—First and Third, Col. Ferguson, M.P., Raith. Second, Mrs. Normand, Dysart.

DUCKS (Any other breed).—First and Second, Countess de Flahault. Third, Mrs. Oswald, Dunnikier.

TURKEYS.—First, T. A. Ronald, Kirkcaldy. Second and Third, J. L. Gaw, Southerton.

GESE.—First, Col. Ferguson, M.P., Raith. Second and Third, D. Miln, Bankhead.

SINGLE COCKS.

GAME (Any variety).—First, W. Hay, Aberdeen. Second, W. Bonthron, jun., Kirkcaldy. Third, J. L. Anderson, Chapel House.

DORKING.—First, J. Menzies, Kincardine-on-Forth. Second and Third, J. Stocks, West Bridge.
SPANISH.—First, Miss B. Ridpath, Edinburgh. Second and Third, R. Somerville, Edinburgh.

CANARIES.

YELLOW COCK (Scotch).—First, J. Forrest, Edinburgh. Second, A. Welsh, Edinburgh. Third, J. Robertson, Kirkcaldy. Highly Commended, J. J. Wilson, Kirkcaldy. *Hens.*—First, D. Duncan, Carron. Second, G. Greig, Edinburgh. Third, R. Smith, Dundee.
BUFF COCK (Scotch).—First, A. Hope, Kirkcaldy. Second, J. Mitchell, Perth. Third, J. Kerr, Perth. *Hens.*—First, D. Duncan, Carron. Second, J. Kerr. Third, W. Poyett, Edinburgh.
YELLOW COCKS (Belgian).—First, W. Forest, Edinburgh. Second, W. M'Inlay, Loches. Third, G. Spence, Dysart. *Hens.*—First and Third, A. Hope, Kirkcaldy. Second, J. Robertson, Kirkcaldy.
LOECHE COCKS (Belgian).—First, D. Talbot, Dundee. Second, W. M'Inlay, Loches. Third, A. Hope, Kirkcaldy. *Hens.*—First, W. Forest, Edinburgh. Second, W. Bonthron, Kirkcaldy. Third, P. Wilson, Kirkcaldy.
YELLOW COCKS (Fleeced).—First, G. Greig, Edinburgh. Second, A. Hope, Kirkcaldy. Third, J. Millar, Dundee. *Hens.*—First, J. Smith, Dundee. Second, V. Duncan, Loches. Third, R. Hunter, Oakley.
BUFF COCKS (Fleeced Speckled).—First and Third, J. Herdman, Kirkcaldy. Second, J. Clark, Kirkcaldy. *Hens.*—First, J. M'Lennan, Perth. Second, S. Carruthers, Dundee. Third, J. Smith, Dundee.
GOLDFINCH MULE (Fleeced Male).—First, J. Swanson, Wemyss. Second, J. Roberson, Aberdeen. Third, W. Bonthron, Kirkcaldy.

JUDGES.—*Poultry*, Mr. W. Hardie, Carron; Mr. D. Stratton, Midcalder. *Canaries*, Mr. D. Stewart, Perth; Mr. M. Bell, Glasgow.

PROPOSED EXTRA PRIZES FOR PARTRIDGE-COLOURED COCHIN-CHINAS.

ALLOW me, as an amateur breeder of Partridge Cochins, to make a suggestion respecting the proposed subscription of one guinea each, subject to trifling reductions, necessary to raise a sum to award to subscribers' birds who shall exhibit at the next Birmingham Show—namely, one prize only, in a cup or in money, for the best pen of Partridge Cochin-China chickens. I think a great number of breeders of this variety will subscribe, and thus a large fund will be raised. If so, I would suggest that there be more than one prize, still having the first a handsome one, which I have no doubt the first-prize birds will well deserve, but let there be a second and third prize if the funds will allow; if not, then have only one prize.

I think that a second and third prize will help to stimulate amateurs in trying their best; but should there be only one prize, I think many amateurs will not and dare not show their birds against first-rate breeders. This matter touched my own feelings, and from my making it public there may be many others who may fall in with my remarks, and if so, I should be glad to hear a better suggestion from them.—J. WRIGHT, Woodbridge, Suffolk.

CORK POULTRY, PIGEON, AND CAGE-BIRD SOCIETY.

THE fourth annual Show of this Society took place in the Athenaeum on the 13th, and was, both in point of number and quality of the birds exhibited, by far the best that has been held in Cork.

In the poultry department *Dorkings* were by far the most numerous and of extraordinary merit. *Cochins*, though not so numerous as the *Dorkings*, were very good. In *Hamburghs* a great improvement was also apparent, some very beautiful birds of different varieties being exhibited. The extra variety of fowls included some remarkably good specimens of *Crève Cœur*, which are an excellent table bird, and lay singularly large eggs. There was an extraordinarily fine collection of *Turkeys*, both old and young birds; and coloured *Ducks* were exceedingly good and heavy. Mr. Corbett, of Castleconnell, was the exhibitor of a large number of cage birds, for which he obtained the Society's gold medal. A most attractive feature in the Show was a number (12) of Peregrine Falcons (hooded), which were exhibited by the same gentleman, and were much admired—in fact, they were, in themselves, considered sufficient to recompense a visit. *Pigeons* made a grand appearance, the Rotunda being entirely occupied by them.

The following is the list of awards:—

SPANISH.—First, Miss De Courcy Drevar. Second, J. C. Perry. *Chickens.*—First, J. C. Perry. Second, W. R. Kourke.
DORKINGS (Coloured).—First, J. C. Perry. Second, Mrs. Dring.

DORKINGS (Silver Grey).—First, A. E. Ussher. Second, R. P. Williams.
Chickens.—First and Second, T. O'Grady.
DORKINGS (White).—First, J. C. Perry. Second, Hon. Mrs. H. B. Bernard.
DORKINGS (Coloured or White).—First, F. Hodder. Second, Miss De Courcy Drevar.
COCHIN-CHINA (Buff or Lemon).—First, R. P. Williams. Second, Dr. P. Williams.
COCHIN-CHINA (Partridge or Grouse).—First, Mrs. Dring. Second, G. Langtry.
COCHIN-CHINA (White).—First and Second, F. W. Zurhorst.
BRAMA POOTRAS—First, J. C. Perry (Dark). Second, J. Bruce (Grey).
GAME (Black and Brown Red).—First, G. Langtry. Second, J. C. Perry.
Chickens.—First, A. E. Ussher. Second, J. T. Richardson.
GAME (Duckwing or Piles).—First, J. M. Roche. Second, R. Creech.
Chickens.—First, J. C. Perry. Second, W. W. Roche.
POLANDS (Golden-crested).—Prize, R. P. Williams.
POLANDS (Silver-crested).—First, R. P. Williams. Second, Mrs. Dring.
POLANDS (White-crested).—First and Second, Miss De Courcy Drevar.
HAMBURGERS (Rose Comb, Golden).—First, Miss C. Purell (Penicilled).
 Second, Mrs. Dring.
HAMBURGERS (Rose Comb, Silver).—First, R. P. Williams (Spangled Pheasant). Second, F. Hodder.
BANTAMS (S-bright).—First, W. Corbett. Second, A. E. Ussher.
BANTAMS (SIKY).—First, F. Hodder. Second, W. Bowly.
BANTAMS (Game).—First and Second, F. Hodder (Black-breasted).
ANY OTHER VARIETY NOT CLASSED.—First, J. C. Perry (Crève Cœur).
 Second, P. W. Zurhorst (Crève Cœur).
TURKEYS.—First, R. Bruce. Second, A. E. Ussher. *Poults.*—First, R. Bruce. Second, J. Bruce.
GESE.—First, A. E. Ussher (Toulouse). Second, J. Bruce (White Embden). *Goatings.*—First, G. Langtry (Toulouse). Second, A. E. Ussher (Toulouse).
DUCKS (Ayle-bury).—Prize, J. C. Perry. *Ducklings.*—First, Hon. Mrs. H. B. Bernard. Second, J. C. Perry.
DUCKS (Rouen).—First, Dr. Parker. Second, T. Richardson. *Ducklings.*—First and Second, R. P. Williams.
ANY OTHER VARIETY OF MERIT NOT CLASSED.—First and Second, P. Ducrow.

MRS. USSHER'S CHALLENGE MEDAL.—For best Silver-Grey Dorking Cockerel, Medal, F. Hodder.

MRS. LYONS'S CUP.—For best pair of Silver-Grey Dorking Pullets, R. P. Williams.

MR. FRANCIS HODDER'S MEDAL.—For best Buff or Partridge Cochin Cockerel and Pullet, R. P. Palmer.

MR. W. B. TEGHEIMER'S GOLD MEDAL.—For best pair of Game Bantams, R. J. Harvey.

MR. THOMAS M'CONNICK'S CUP.—For best pair of Turkeys, P. Ducrow.

SOCIETY'S GOLD MEDAL.—For the best collection of Cage Birds, W. Corbett, collection of Cage Birds nearly all foreign.

SWEETSTAKES FOR DORKING PULLETS.—First, J. C. Perry. Second, F. Hodder.

PIGEONS.

POWTERS (Yellow Pied).—First, Dr. Harvey. Second, A. E. Ussher. (Red or Mealy Pied).—First and Second, Dr. Harvey (Red). (Blue or Silver Pied).—First, A. E. Ussher. Second, Dr. Harvey. (Black or Chequered Pied).—First and Second, J. Perrot. (White, or others).—First, Dr. Harvey. Second, J. Perrot.
CARRIERS (Black).—First, G. A. Wherland. Second, T. A. Hare. (Dun).—First, A. E. Ussher. Second, G. A. Wherland. (Blue, or other colour).—First and Second, G. A. Wherland (Blue).
TUMBLERS (Short-faced Almonds).—First, Dr. Harvey. Second, J. Perrot. (Short-faced Kites).—First, T. Hare. Second, Dr. Harvey. (Short-faced Nuts).—First, T. Hare. Second, L. M. Ewart. (Short-faced Buds or Beards).—First and Second, Dr. Harvey (Blue and Yellow Buds). (Common Buds or Beards).—First, J. Pike. Second, N. Daly. (Any other colour).—Prize, Dr. Skinkwin (Yellow).
BARDS (Black or Dun).—First, G. A. Wherland (Black). Second, A. E. Ussher. (Any other colour).—First, G. A. Wherland (Red). Second, J. Perrot (Red).
JACONINS (Red or Yellow).—First, L. M. Ewart (Yellow). Second, J. Lloyd (Yellow). (Any other colour).—First, J. Perry. Second, R. Lane.
FANTAILS (White).—First, J. Perrot. Second, J. Pike. (Any other colour).—First, Dr. Skinkwin (Black). Second, W. Parker (Blue and White).
OWLS (Blue or Silver).—First, J. Lloyd (Blue). Second, J. Perrot (Blue). (Any other colour).—First and Second, J. Pike (White and Black).
TRUMPETERS (Mottled).—First, L. M. Ewart. Second, J. Perrot. (Any other colour).—First, J. H. Hutchinson (Yellow). Second, L. M. Ewart (White).
TURBOTS.—First, A. E. Ussher (Blue). Second, M. E. Jobling.
NENS.—First and Second, J. Perry.
MAGPIES.—First and Second, P. Goulding (Black and Yellow).
ANY OTHER VARIETY.—First and Second, Dr. Harvey (White).

SPECIAL PRIZES.

MRS. PIKE'S CUP.—For the best pair of Carriers, J. Perrott.
MR. HAWKINS'S SILVER MEDAL.—For the best pair of Barbs, P. H. Jones.
MR. JOHN PERROTT'S SILVER MEDAL.—For the best pair of Fantails (Any colour), M. E. Jobling.

SWEETSTAKES.

POWTER (Any colour).—Prize, Dr. Harvey.
CARRIER (Black).—Prize, P. Goulding.
CARRIERS (Dun).—Prize, P. Goulding.
CAGE BIRDS.—*Canary* (Yellow).—First and Second, Mrs. Hodder.
Canaries (Green).—First, J. R. Bushby. Second, Mrs. Hodder. *Goldfinch* (Mauve, or any other colour).—First and Second, Mrs. Hodder. *Goldfinch* Mule.—Prize, J. Coreotan. *Linnet Mule.*—First, J. Coreotan. Second, W. Corbett. *Thrush.*—Prize, W. Waters. *Skytark.*—First, J. Lemie. Second, S. Lemie. *Bullfinch.*—Prize, J. Lloyd. *Goldfinch.*—First, D. Carbery. Second, J. Coreotan. *Linnet.*—Prize, J. Coreotan.

—(Cork Daily Herald.)

NEW BOOK.

Fowls; a Plain and Familiar Treatise on the Principal Breeds.
By JOHN BAILY. Fourth Edition.

"I HAVE endeavoured in this sixth edition of 'The Dorking Fowl,' and the fourth of 'Fowls' in general, to add the experience of the three years that have passed since the last was published. That which I have printed is all practical." Such are the author's opening sentences, and they contain nothing but truth; yet not all the truth, for we can attest that the additions are considerable, and that all the "practical" details are sound and trustworthy. Directions are given for the construction of the poultry-house; for the general management and feeding; descriptions of each variety; the characteristics required for each specimen to be exhibited; mode of fattening, &c.

It is a good little book, and such as might be expected from one so well practised and so capable of imparting his knowledge as Mr. Baily.

FOUL BROOD.

I SHALL be as brief as possible in my notice of Mr. Lowe's articles in Nos. 145 and 146, confining myself as far as I can to those points on which he has shifted his ground in the vain endeavour to escape the complete refutation which some of his fallacies have already received.

Let me repeat at the outset that Mr. Lowe's theory was the first that presented itself to my own mind, and it was not discarded by me without due consideration. It is also by no means so novel as he appears to imagine, having been promulgated years ago in America, where, after being very ably advocated, it has been finally discarded by the best transatlantic authorities. It is also scarcely possible that so very obvious an hypothesis should have escaped those keen observers the Germans; and the absence of any reference to it in their notices of this disease, is to my mind conclusive as to its having been long ago exploded by them.

If Mr. Lowe were to put into my hands a piece of comb containing what he denominates foul brood, and which I found myself unable to distinguish from that which occurred in my own apiary, I should immediately inquire if it were contagious; and if he assured me that it was non-contagious, and that simple excision of the affected parts was sufficient to effect a radical cure, then I should at once know that it was not true foul brood which he had set before me.

I have never stated that foul brood is removed by bees—in fact, I know full well that only a single cell would continue in its foul state even in the strongest stock, and if permitted to remain would, I believe, certainly destroy it in the long run. This, therefore, is my answer to the string of questions which have been addressed to me on this head. I could frame a neat little theory as to why bees do not remove foul brood although so prompt in their expulsion of chilled brood, but I prefer confining myself to plain facts.

I note the taunt in page 47, but fail in appreciating its point. Mr. Lowe asserted that twelve hours' delay in a warm kitchen during July, would convert healthy into foul brood—I demonstrated by actual experiment that four days' exposure in a fireless apartment and at a colder season was insufficient to produce this effect. I believe a few larvæ—probably not one per cent., and these all "tender little grubs," which, according to Mr. Lowe, should have been the first to suffer—hatched out after all this neglect; thus contradicting him even more emphatically than I had expected. But notwithstanding this, I still conceive myself perfectly justified in designating the experimental comb with its thousands of defunct larvæ as a "mass of chilled and abortive brood in all stages." I cannot, therefore, allow Mr. Lowe to ride off at a tangent on the hobby of his favourite phrase, "decayed and abortive brood," &c., but take leave to recall him to the real question at issue between us on this point. He commenced by stating that when once "chilled brood occurs in any hive, then farewell prosperity," &c. Next followed the most-unsparring reprobation of my proceedings in allowing brood to remain twelve hours in a warm kitchen during the month of July, coupled with the assertion that under such circumstances foul brood would follow as a necessary consequence. On my stating that the actual mischief

done in this case would be very trifling owing to the few chilled larvæ being speedily removed by the bees, he called on all the apiarians of this the nineteenth century, to say if it really were so, and wound up by himself replying emphatically in the negative, with the addition of the formula which he has since so often repeated. If this do not amount to asserting that chilled brood is not removed by bees, then is the English language entirely without meaning. The evasion of afterwards endeavouring to shift the question to the possible interpretation of a semi-oracular phrase, when severed from its context, is too transparent to merit serious notice.

So also with regard to his assertion that "it is only in the hands of the experimentalist that we find its presence [*i. e.*, that of foul brood] generally manifested." Finding this position untenable, Mr. Lowe quietly slips out of it by misquoting himself, and declaring that he said that "foul brood will be found to manifest itself generally in the hands of the experimentalist," thus altering his own language and giving to it an entirely different meaning.

Some may deem these evasions exceedingly clever. Mr. Lowe evidently thinks them allowable, or he would not have resorted to them. I will not trouble him with my own opinion on the point.—A DEVONSHIRE BEE-KEEPER.

BEES AS REGICIDES.

WHILST it may not be uninteresting to your apiarian readers to know the after-history of the imprisoned queen, of which an account is given at page 263 of this Journal, it is proper and due to Mr. Woodbury, as a trustworthy and accurate observer, to state that his predictions as to a fatal termination were too soon accomplished.

That gentleman intimated that a succession of attacks might be expected, and that the "mature and prolific" queen would at last be destroyed, even at the expense of the whole hive.

This result has literally been brought about; for, although the imprisoned queen regained her liberty on Sept. 23 and all went on peaceably for a time, yet a second assault was made on October 6, when, in cold blood and without any apparent cause, the rightful sovereign was dethroned, and either put to death or expelled.

Previous to the first attack the queen had been very fertile and laid eggs daily; but from the moment her subjects rose up against her she ceased to deposit eggs, whilst those that were unhatched were removed by the worker bees and food substituted in their room.

During the second attack there was one bee very conspicuous amongst the rebels. Once in particular, when the queen regained her freedom, this determined persecutor maintained its ground alone. Whilst the queen fled in perturbation over the comb and backs of the other bees, it was seen following in her wake, and, on overtaking her, to seize her by the leg and hold by it alone for the space of a minute.

What struck me as somewhat remarkable was the fact that—a week after the disappearance of the queen, and when there were no eggs or larvæ in the hive from which to raise a new queen—the bees continued to carry home pollen and store up food as formerly. Perhaps the presence of brood in the pupa or imago state may explain this.

But from the instance here given, which just adds another to the many cases of regicidal attacks which Mr. Woodbury mentions he has related in THE JOURNAL OF HORTICULTURE, we need no longer be surprised at finding hives in spring without a single bee in them, though well stored with honey and properly secured against the ravages of that most destructive enemy in winter—the field mouse.

Will Mr. Woodbury say whether he has ever had any reason to suppose that regicidal attacks might be first commenced by stranger bees entering the hive unperceived?—R. S.

[I have never had any reason to believe that regicidal attacks originated with strange bees that entered the hive unperceived; but nevertheless I deem this suggestion of my esteemed correspondent well worth attention. I can bear witness to the exceeding accuracy with which he has described a regicidal pursuit and attack. Often have I seen

the single bee following, like an avenging Nemesis, in the wake of the unfortunate sovereign; but although I have on more than one occasion secured and put to death the remorseless pursuer, the respite to persecuted royalty has been but temporary, since, like a Corsican vendetta, one or more of her sisters have presently taken up the pursuit which has ended in the imprisonment and ultimate death of the hapless queen.—A DEVONSHIRE BEE-KEEPER.]

BEE FLOWERS AND BEE PASTURE.

ONE or two writers in THE JOURNAL OF HORTICULTURE some weeks ago were comparing the virtues of borage and *Melilotus leucantha*. Mr. Keys, an apiarian of the old school, very properly designates the borage as the "king of bee garden flowers." There is no flower which the hive bees seem to revel more in, and for a longer period, than the latter, and it has the property of lasting in a succession of blossoms for several months, and it is a much greater favourite than the melilotus.

TRIFOLIUM REPENS (Dutch Clover).—It may be well to mention a mode adopted by me on a piece of very bare pasture land some years ago. The ground had been fed by sheep and young cattle in the winter, and a good deal trodden down. The whole piece in April was sown, at the rate of about 1½ lb. per acre, with Dutch clover by my own hand, and produced a beautiful sprinkling of bee pasture next summer. A neighbour met me who went by the foot-path through this field, and when he saw me he mentioned the appearance of the white clover as a remarkable occurrence. I then mentioned that I had sown the clover seed in the spring myself, and he was surprised to think it had succeeded, as he had never heard of such a course being taken before. Take one-half of Great Britain, there is no doubt that the white Dutch clover (creeping clover as the Latin name gives it), is, after all, the mainstay of the hive bees.

SALVIA NEMOROSA (Wood Sage).—This flower is also an immense favourite with the bees; but it seems a scarce one. I procured some roots from Mr. Baskerville, a nurseryman at Bristol. The flowers appear in June, and last a couple of months. Although there are several large nurseries at Cheltenham well stocked with flowers, I have searched and never found a specimen of it. I can most strongly recommend this pretty, spiry, puce-coloured flower to all bee-keepers who cultivate garden bee flowers.—H. W. NEWMAN, *Hillside, Cheltenham.*

YEW—ARE THEY POISONOUS?

I SEE there is great difference of opinion among your correspondents, as to whether the yew is poisonous or not. I should have thought there could have been no doubt on the subject.

Some years ago, at the request of several persons interested in the subject, I collected a mass of evidence on this question, and it resulted in a verdict of "poison." I am glad to say that I have no direct personal evidence to give, but I have not the slightest doubt on the matter, from the indisputable cases that were brought to my notice. There is no rule, however, without an exception, and I think, also, that under certain circumstances yew leaves may have been eaten with impunity.

I have often eaten the berries. They are the favourite food of the missel thrush and blackbird, and I have noticed this week that my tame pheasants eat them with great avidity. The remark that a yew tree which bears berries is deadly, and that a barren tree is harmless, is absurd—one, of course, being the male, and the other the female plant; and a person who would make such a statement in earnest, would argue that a buck rabbit was poisonous, and the doe not, or *vice versa*.

That there are different cases in point tending to prove the yew poisonous and not poisonous I freely admit. I have known the whole of a lot of milk cows killed by eating the clippings of a yew fence, and yet I have seen young horses nibbling away at a yew tree without any bad effect. This being so, may I offer the following remarks?

My opinion is, that it is the quantity at one time that

does the mischief—an overdose of a powerful medicine, in fact. Eminent and accurate naturalists inform us that goats feed on several plants which are deadly poison to sheep and other animals. I am a very close observer, and am firmly of opinion that animals in a state of nature eat poisonous plants, when occasion requires, as medicine. I knew an old horse that was fairly eaten up with worms, and was a most miserable object. That horse broke into an old orchard where there were bushes of both savin and juniper, and having eaten of them voided an enormous quantity of worms, and recovered in the most rapid and marvellous manner. The clippings of the damaged branches were given to some of the other stock, which were in a healthy state, and those clippings poisoned them.

I am no homeopathist, but I believe animals are, and practise it. There is no doubt about arsenic and aconite being deadly poisons; yet what large quantities are administered with benefit in certain cases! The common broom is acrid and poisonous to a considerable extent, yet a decoction of it is used as a wash for cattle to prevent or cure scab and vermin, and is as effectual as stavesacre, which is the veterinary's specific.

There cannot be any dispute about the poisonous qualities of the laburnum and mezereon, both plant and berry. A few years ago I had a great quantity of broom, laburnum, and some mezereon, growing in my woods. During the two severe winters a few seasons back, I had a very great number of hares which had no wholesome natural food for many weeks, and during that time they ate and destroyed every broom bush and laburnum on the estate. Where the drifts of snow gave them any advantage, they got into the forks of the larger laburnums, and peeled every branch. The gamekeeper and I, who often saw them in the act, thought they would all be poisoned, but strange to say, I never saw hares winter better. I believe that they were forced to eat all sorts of indigestible stuff, and took this as a corrective. It is not possible they could like it. I have now no quantity of the said plants, and during the last two open winters the hares have died of rot, just like sheep. They are now all diseased, and I cannot get one fit for the table. During the same hard weather I used to take them yew and ivy clippings, and these were all eaten up before the morning. In open weather nothing will tempt them to eat any such bitter fare. Finally, my advice to people intending to give their cattle yew clippings, is—Don't.—JACKSON GILLBANKS, *Whitefield House, Cumberland.*

OUR LETTER BOX.

DORKING COCKS' COMBS BLISTERED (*E. Leech*).—There is little doubt but the cocks are suffering from frost. The Malays and Hamburgs are double, and consequently flat-combed birds. They do not suffer like the upright single comb of the Dorking. The best treatment is to rub the parts affected, and the whole comb, with strong camphor ointment. As Pens are very prone to eat the cock's comb where it has begun to bleed, or where the skin is broken, they should be watched, and the cock removed in such a case till the comb is entirely healed.

DORKING COCK WITH A TUFT (*Subscriber, Royston*).—The tuft as it exists is unquestionably a great defect; but we have seen it often, and it has not been hereditary. We are bound in truth to state that in other instances it has been so, though seldom. This tuft was originally called a "lark-crest." It is sometimes produced by plucking the feathers from the poll, which seems to cause the skin to contract, and thereby raise the feathers. This is easily detected, because in that case the feathers are few, but are numerous in the regular tuft. It is always well to have perfection in a stock bird; but we should not hesitate to breed from a good bird, although slightly lark-crested.

BREEDING GAME BANTAMS AND BARR PIGEONS (*W. Massay*).—Your questions as to Pigeons and Bantams require the same answer. If your birds are good and pure, they will require no mixture of any other breed; they will only want fresh blood of another strain. If they are the result of a cross, they will require the constant use of the same ingredients that produced them in the first instance. In Duckwings of uncertain origin, the breast is apt to become speckled; the pure black is then restored by having recourse to the Black Reds.

BREEDING SILVER-SPANGLED HAMBURGERS (*A Young Subscriber*).—It is held to be impossible to breed winning cocks and hens from parents of the same strain. We should never breed from a hen with light huckle. It is a great defect in exhibition, and therefore a point which we should not seek to perpetuate. It is difficult to have a bird too dark if the spots are regular in size and position. If they are in patches it is a fatal fault—in fact a disqualification. Holding this opinion, we advise the Lancashire breed, as the Yorkshires have black breasts. Breed from a cock with a well spangled (not spotted) breast, well barred and lined wing, and clear tail. The hen should have sharp distinct marking, good deep colour, rounded neck, and clear tail. You will seldom breed a chicken worth keeping from a light-coloured hen.

WEEKLY CALENDAR.

Day of M th	Day of Week.	JAN. 26—FEB. 1, 1864.	Average Temperature near London.			Rain in last 37 years.	Sun Rises.	Sun Sets.	Moon Rises.	Moon Sets.	Moon's Age.	Clock before Sun.	Day of Year.
			Day.	Night.	Mean.	Davs.	m. h.	m. h.	m. h.	m. h.	m. s.	m. s.	
26	Tu	Missel Thrush sings.	45.2	32.4	38.8	16	50 af 7	35 af 4	51 7	17 8	17	12 45	26
27	W	Stinking Hell-hore flowers.	44.1	31.0	37.5	17	49 7	37 4	56 8	38 8	18	12 48	27
28	Th	Daisy and Winter Aconite flower.	45.3	30.7	38.0	20	48 7	39 4	1 10	58 8	19	13 10	28
29	F	Bees come abroad.	45.4	31.6	38.5	17	46 7	41 4	8 11	19 9	20	13 21	29
30	S	Snowdrop flowers.	44.2	32.1	38.2	18	45 7	42 4	morn.	40 9	21	13 31	30
31	SUN	SEXAGESIMA SUNDAY.	44.3	30.5	37.4	16	43 7	44 4	15 0	6 10	22	13 41	31
1	M	Pied Wagtail seen.	43.2	30.8	37.0	12	41 7	47 4	26 1	38 10	(13 49	32

From observations taken near London during the last thirty-seven years, the average day temperature of the week is 44.5°, and its night temperature 31.3°. The greatest heat was 57°, on the 1st, 1852; and the lowest cold, 8°, on the 31st, 1857. The greatest fall of rain was 0.52 inch.

CACTACEÆ CULTURE.



LITTLE attention of late years has been directed to these singular-looking but attractive, grotesque yet beautiful, plants. They have but few admirers at the present day, but they were formerly in great repute; and justly so, for what plants have more gorgeous flowers than some of the *Cereus* and *Epiphyllum* tribes? What plant can we select out of our largest collections that can vie with *Epiphyllum Russellianum* or a *Pereskia* with a stem 18 inches high, the head 2 feet through, drooping gracefully, and producing 200 or more of its beautiful, waxlike, rose-coloured flowers, hanging like dewdrops from the tips of the leaves or stems? Or what plant can equal *Cereus speciosissimus*, with scores of brilliant crimson blossoms,

suspended from the roof of a greenhouse or conservatory? Not one of the new introductions which have driven these rare old plants into corners, where they remain uncared for and unseen, has more beauty of outline and gorgeousness of flower than the neglected Cacti.

Like Ferns, Cactaceæ are interesting at all seasons. Some are grotesque, others singular and curious—qualities which recommend them to the lover of nature, while those who see no beauty except in gaudiness could not possibly wish for more than is afforded by these curiosities of the vegetable kingdom. Nothing can equal the splendour of the *Epiphyllums* in winter, their rich satiny blossoms forming a fitting contrast to the dazzling whiteness of the snow. Nor are the *Cereuses* less ornamental, for in their ranks do we not find some that produce the most splendid flowers of our stoves? Where is there a plant worth sitting up at night to see its flowers and inhale its rich perfume? Certainly nowhere but in this neglected family. What is there so splendid as the Night-blooming *Cereus*, of which the flowers perfume the air? When fully expanded at midnight they are quite a foot in diameter. Inside they are of a bright yellow, resembling the rays of a star, and outside of a dark brown, the petals being of the purest white. Then we have another most curious representative in the Old Man's Head (*Cereus senilis*), covered all over with long, hair-like grey bristles, hanging down like the grey hair of an old man. We have some armed for defence with numerous spines, set porcupine fashion in the *Mammillarias*; others are good to eat, the Prickly Pear (*Opuntia vulgaris*), being no mean dish in some countries; and last of all, the useful and valuable *Nopal*, or *Opuntia*

cochinillifera, is the plant on which the cochineal insect feeds and breeds. Having now made out what I consider to be a sufficient case, I will address myself to my task of replying to queries submitted by "AN ADMIRER OF THE CACTUS TRIBE."

Cacti are for the most part natives of Tropical America, and are found on the mountains of Brazil, often at a great elevation, exposed to the cold breezes of the lofty regions, and grow in a poor, dry, stony soil. *Mammillarias* and the *Echinocacti* grow in the valleys of the tropics, mostly in a loamy soil, and amongst thick short grass, and exist one-half of the year in almost continual rain. *Opuntias* are generally found on almost barren hills, growing in narrow chinks or crevices of rocks. *Rhipsalises* grow only in the hottest parts of the tropics, and are more curious than ornamental. *Pereskias* are the only plants of this order which have leaves distinct from the stems; and though distinct in habit, and their fruit distinguished as the Barbadoes Gooseberry, yet they are chiefly valuable for making stocks for *Epiphyllums*. They are, however, by no means despicable objects, for their appearance is grotesque and their flowers singular.

To grow these neglected plants successfully is no difficult matter; but to obtain plants, and place them on out-of-the-way shelves where they receive but little air and light, and no more water than is sufficient to maintain vitality, or given in quantity irrespective of their requirements, is the readiest way of bringing them to the rubbish-heap. When properly treated they are neither shy bloomers nor bad growers, but just in proportion as they receive good or bad treatment are they splendid or miserable-looking.

To do them full justice they require a house to themselves; and I cannot imagine a house calculated to afford greater pleasure than a Cactus-house with the plants in pots, or distributed like Ferns in rockwork. The creeping habit of *Cereus* and the flat stems of the *Opuntias* peculiarly fit them for growing over rocks, and the *Rhipsalises* with their cordlike stems would be charming if suspended in baskets, or planted high on the rockwork, so that their branches might hang down. The erect-growing *Mammillarias* could be planted in nooks and corners; and if a few of the tenderer *Mesembryanthemums* were added there would be no lack of bloom and interest in a house of this kind at all seasons. The description of house need not differ materially from the ordinary span or lean-to houses. All that is necessary is a light, airy, and moderately heated structure, with shelves for small plants and such as droop or hang down. If they are planted out on rockwork good drainage must first be provided, and a light turfy loam is the most suitable compost. It is not necessary where they can be planted out to grow them in pots; but they are handier when so grown, and their individual wants can be better attended to.

If I intended to devote a house specially to the growth of these plants I would have it a span roof, glass in front and ends, with the back wall of brick or stone, about

8 feet high, and this I would cover from end to end with creeping Cereuses; and about 2 feet from the top of the back wall I would have flagstones 6 inches wide and 1 foot 6 inches long, laid in the wall in building at a foot asunder, and projecting into the house 1 foot. A foot above these I would have another tier of stone shelves, but alternately with the lower row of shelves. These shelves would each hold a plant, and, unlike an ordinary shelf, the plants would have three sides to spread their stems downwards, and in such positions the drooping kinds should be placed to be seen to advantage. I would also have a table 3 feet wide all round the house, and 2 feet 6 inches from the floor. Near the glass in front a shelf would be useful for small plants. Next to this table there should be a pathway a yard wide, and in the centre a bed 6 feet wide, and walled round to the height of 3 feet from the floor. Two four-inch pipes all round would be necessary to maintain the proper temperature; and two more placed in the bed and covered with tan would make a mild hotbed of it, and render it a first-class place for plunging newly-potted or sickly plants to recover or gain strength—in fact, the tender kinds would be no worse of being kept plunged in a mild bottom heat at all seasons. I may be told that this is an extravagant mode of cultivation, for any cottager can grow them in his window with very little trouble; but nine-tenths of the Cacti at present in this country are not grown at all—they are barely supplied with enough heat and moisture to enable them to live, and any out-of-the-way place is considered good enough for them. There are no plants that will bear more rough usage, endure a greater range of temperature, and live longer without attendance than these; but to grow them they require as much care and skill as any other description of plant. Like all tropical plants, they require a season of growth and one of rest, moisture being the agent in the one case and dryness in the other. Their habits are nearly like those of Orchids—in fact, some of the Epiphyllums are occasionally found growing as epiphytes. *E. speciosum* is found as an epiphyte in Demerara, but is said to be of stunted growth.

The most suitable soil is light turfy loam; and if from turves 3 inches thick laid in a ridge, with one-third of sheep's-dung, for twelve months, and occasionally turned over, a better compost could not be desired for the tall Cacti, which are the varieties usually found in greenhouses, and which are proverbial for blooming badly. After this has lain a year it will be fit for potting purposes, but it is materially improved by adding about one-third of sandy peat, which should be well mixed with the loam. A sprinkling of sand may be added if the loam is deficient in that substance. The soil should be in a moderately dry state when used for potting.

The plants should be potted in April, unless they are in flower at that time, when the operation must be delayed until the flowering is over. After carefully turning them out of the pots remove the drainage, and such portions of the soil as come away easily, and clear out all decayed roots and soil as far as can be done without injuring the roots. If the soil is full of healthy roots the ball must not be broken but transferred entire to a larger pot. The pots should be clean inside as well as outside, and if the hole is small it should be made larger. The drainage should be perfect, and occupy about one-third of the depth of the pot, which should be small in proportion to the size of the plant. Large shifts are to be avoided; for a mass of soil at the roots only tends to cause them to rot. The plants are always the healthiest when the roots are matted round the inside of the pots, or when potted so that the roots have an opportunity of soon reaching the sides. Large shifts prevent the roots reaching the sides of the pot for a long time, and the soil retains too much moisture when the plant is watered, and this is inimical to free growth and maturation afterwards. Having the pot ready, proceed with potting, and to prevent the drainage becoming choked place a thin layer of moss or cocoa-nut fibre over it. This done, put a little soil at the bottom, but before doing so take a handful, squeeze it tightly, and, holding it above the potting-bench, let it fall, and if it does not fall like so much flour, it is too wet, and must be drier before it is used. The plants ought never to be potted when the soil about the roots, or that in which they are to be potted, is wet. All being in the right condition, the plant should

be put a trifle deeper in the pot than it was before, and if nothing be employed but the hand it is not possible to consolidate the soil too firmly. When the potting is finished the soil should be about half an inch below the rim of the pot, so as to hold water. After potting, place in a house with a temperature ranging from 55° to 60° with fire heat, with a rise of 10° to 15° with sun and air. Water sparingly until the plants begin to grow, when they require copious waterings so as to keep the soil moist; occasional syringing overhead and a moist atmosphere will be found highly conducive to the health and vigour of the plants. By July the growth will be made; the plants are then to be removed to a light, dry, airy situation in the greenhouse, where they are to be watered but seldom, and then only to prevent the leaves or stems shrivelling. An occasional syringing of the stems will be found advantageous in freeing them from dust and enabling them to acquire fullness in their parts.

(To be continued.)

G. ABBEY.

THE FLOWER GARDEN.

How swiftly speeds the circle of the seasons, bringing with them their respective pleasures, cares, and duties! From the near approach of spring we are reminded that if a respectable appearance is to be made in the fashionable way of flower gardening, which has so strong a hold on the public mind at present, the next three months must be a time of considerable activity in preparing the many plants that are to produce those masses of bloom which our present style necessitates. Certainly, if extent and brilliancy of bloom have anything to do with the designation "flower" garden, it never was more appropriate than now. And there never was a time when it could more exultingly be asked with Boursault, "Who does not love flowers?" They are the most cherished and conspicuous of our garden embellishments. They make more lustrous our feasts and festivals. They are now, perhaps, more than ever considered necessary to add pomp to some of our religious ceremonies. They interpret our affections. They cheer and soothe the sick and invalid. They are showered on the bride, and strewn on the graves of relatives. The rich can secure them in profusion every day in the year; but the masses, particularly of our city population, must be content with seeing and enjoying them but for a limited portion of the year, and the enjoyment which they derive from beds gay with flowers is chiefly dependant on our parks and public gardens, and many of our private gardens, which with commendable generosity and kindness are occasionally, and, in some cases, regularly, thrown open to public inspection, and few are those by whom so pleasing a privilege is abused. And it may safely be questioned if any previous system of flower gardening will bear any comparison with the present for impressing the minds of the masses with the exceeding loveliness of flowers.

Whatever may be urged against the massing, blending, and contrasting of colours as practised now, I think a great many of the comparisons made and arguments urged against it are very ridiculous and one-sided, and not likely to lessen the hold which the massing of flowers has acquired on the public mind. I have no wish to try and hide the fact that the system has been abused and misapplied. In some cases the area devoted to masses of flowers must be allowed to be out of all proportion to its surroundings, and as a consequence, when frost has put an end to the flowers, there is a preponderating gap which if not otherwise filled up is anything but pleasing. But this only shows the abuse of what, in due proportion, is most pleasing.

In other instances lawns have been cut and frittered up into beds which should never have had a flower on them, and King Croquet may well be praised for putting an end, as he can, to flowers on many a green sward. On the other hand, if we are to have beds on the lawns, what other sections of flowering plants or manner of arranging them would be more tolerable than those now in vogue? Certainly not the mixed style of herbaceous plants.

The comparatively short-lived character of the display produced is one of the most powerful of the arguments urged against the massing of tender plants. It would be much less objectionable could the season be greatly pro-

longed. So much labour for four short months' bloom, a good many say, is paying too much for the pleasure. It is, however, just questionable whether this be a well-founded or philosophical objection. What would the gay picture become to us if it were before us all the year round? Would it not lose its charm, and cease to produce those pleasurable emotions with which it is attended for a shorter period of the year? Besides, why should the same objection not be urged against all other styles of gardening in which flowering plants play their part. Each season as it passes on brings its own peculiar change over the face of Nature; and were it not so, and if instead we had one continuous year of leafy woodland and flowery meadow, the year would become a dull monotony, and be divested of many a charm. True, a vacant, bare bed which is left after the flowers are gone, may be pointed to as an eyesore for half the year. Such an objection need not of necessity exist, although to a certain extent it results from the massing system. The beds can be relieved or entirely filled up with other materials; and where families are resident in the winter, this is now practised very generally, and, thereby, a pleasing change is effected. Undoubtedly the extent of flower-beds in some instances is out of all proportion to the means at command for producing good plants for filling them up properly. On account of this the season of bloom is shorter than it would otherwise be, and an enormous amount of labour is charged to the system proper, which ought to be laid to the abuse of it, in conjunction with the want of proper means for preparing plants. If the question were, How much can be done well and with comfort? instead of How much can be accomplished by hook or by crook after a fashion? it would do much to raise the standard of flower gardens, and relieve them from the complaints which are made against them. There can be nothing more erroneous than to estimate the merits of a flower garden more by its extent than by its arrangement, or to dream that real pleasure is not more dependant on the arrangement of colour and symmetry of beds than on any amount of extent.

While I have no wish to shield the bedding system from any, or all of the faults that can be legitimately found with it, I at the same time think that those who have so totally condemned it, and recommend in its stead the old mixed herbaceous style, have done so without sufficient thought. No one can deny that there is ample scope in an herbaceous border, with a few annuals and tender plants mixed in, to gratify the keenest sensibility to that which is interesting and beautiful; but to say that such plants and such an arrangement would be tolerable in an Italian or any geometrical cluster of beds in front of the drawing-room windows would be simply ridiculous. For such a position we have yet to learn that there are any other plants by which so pleasing a picture could be produced, and for so long a period, as with the plants now used. It would be just as reasonable to deny that there is not material in a well-arranged herbaceous border to afford an almost boundless amount of interesting observation, as to say that a group of beds well planted is not highly calculated to have a most pleasing and healthful influence on the mind. And who will say that each of those departments of flower gardening has not its desirable lull like a pause in music?

Some of our hardy herbaceous plants and annuals are among the most glorious of all our flowers, and they have the additional recommendation that they are available alike beside the humble cot and kingly palace. But that does not prove that for every purpose they are the best. Why, it may be asked, have the managers of our botanic gardens awakened to the fact, that if they are to meet the public taste and make their grounds interesting to those who visit them, they must patronise the massing of colours by using our popular bedding plants? Just because the latter are infinitely better adapted for making up a lovely picture on a closely-shaven sward, and being judiciously introduced among Coniferae and evergreen shrubs.

Let any of those who have so ruthlessly assailed the bedding system step round into the herbaceous ground, and just consider what sort of a figure he would cut with the best materials he could get there from July till the end of October. These are very well in their proper places, but not adapted for producing a high artistic effect. Let this rule be applied to the Crystal Palace for instance, and I

fancy we would soon hear the cry of "Give us back our flowers."

I have wandered far from the original object of this paper, which was merely to make a few remarks preparatory to the busy season of propagation, which is now close at hand. The first thing that I would advise the inexperienced to do is to arrange without delay the way in which their beds are to be planted, and then make a calculation of the number of the various plants that will be required to carry out their designs. Unless this be done there must be a great deal of uncertainty as to the respective numbers that should be prepared, and changing of plans and delay at planting time follow as a consequence. Old hands at this work have generally by them a large store of notes made in former years when the beds were in their prime. Every combination and its effects have been carefully noted, and long practice and study in the contrasting and harmonising of colours make the planting of a garden a matter of comparative ease and certainty to them. A few simple observations may, however, be of service to those of younger experience who have not given much thought to the science of colours.

M. Buffon a good many years ago made a very interesting discovery in the science of colour, the consideration of which cannot fail to aid the flower gardener in the disposition of the materials with which he has to deal, and will at all events make it less likely that any great mistake will be committed. He discovered that if a wafer is placed on a white sheet of paper and steadily gazed on for a few seconds and the eye then removed to another part of the paper, a spectrum of the same size as the wafer and of its contrasting colour is seen on the paper. The spectra are, however, rendered more distinct when the wafers are looked at on a dark ground, and the eye then removed to a white ground.

This is probably the simplest and surest way of determining what colour will most nearly contrast with another. This simple fact is just the reason why black type is more comfortably and more easily read on a white ground than would red type, for red would have a contrasting green spectrum floating before the eye on the white ground. White being the contrast to black, the spectrum is prevented in such a combination. By this simple process any one can find out contrasting colours when it is desired to plant according to the law of contrast.

When the *harmony* of colours is the object, the harmonising colours can be determined by printing on a card the prismatic colours in the order in which they are produced by the prism. The colour that harmonises with any of these colours is always that next to itself, and between it and that which contrasts with it. These simple rules any person can apply, and although they may not meet all the wants of the flower garden, they will be found of very great service.

It would be useless to attempt to give rules as to when or where the laws of harmonising and contrasting should be applied. Neither system can be applied with its original rigidity, perhaps, but at the same time the arrangement of flowers either way cannot be done effectively without consulting these laws. Modification is forced upon us from the colours and characters of the plants with which we have to deal, consequently much must always depend on good taste and long and careful observation in combining them in the most pleasing way. The contrasting of colours is certainly very effective in certain positions and designs. It is to my mind, however, not at all pleasing when carried out on a wide extent close to the eye. It forms too gaudy a picture to be agreeable, and it is doubtful whether the craving for severe distinctness can be considered good taste. In some cases contrasting becomes necessary—when, for instance, the garden is most viewed from a distance, or in a long stretch of border where anything approaching to a mixture would in the distance lead to the neutralisation of colour. When it is necessary that the eye should take in and appreciate the design throughout the whole length, there must be distinctness. For a design of this sort, there is, perhaps, nothing better than the three primary colours, yellow, blue, and red, as represented by yellow *Calceolarias*, blue *Lobelia*, and Scarlet *Geraniums* or *Verbenas*—the *Calceolaria* in the centre, *Lobelia* next, and on the outside the *Geranium* or *Verbena*. With no other material that I know can a better and more distinct effect be produced in a very long

border than with these three colours; and were I called on to produce the finest possible effect with these, I would not have the border nibbled up into little beds with small gravel walks, but would plant the whole surface.

For planting a geometric design in a position where it has mostly to be looked at close to the eye, more of the harmonising principle may be applied. In such a position I am very partial to a softer and more mellow arrangement, the beauty of which becomes more apparent the more it is looked at, and which is not so tiring to the eye. In such cases I would avoid as much as possible the gaudy picture produced by severe contrast, striking enough at first, but greatly devoid of that pleasing interest to a mind better trained to colour than the quiet beauty of softer combinations. I would apply the same rule to a group of beds in any quiet sequestered spot which is not seen till close to the eye. Anything harsh and grating in such a position would be quite out of place. In small designs particularly, the warmest colours should be kept to the outside of the picture, and in match-bed-planting different tints of the same colour should, if possible, be avoided. The key or centre bed should in all cases be soft and quiet, unless it can be broadly surrounded with a harmonising tint, and even then it is not so good as to start with a quiet colour.

Of mixed beds I am not generally an advocate, especially in planting groups of beds, although some mixtures are exceedingly lovely. What, for instance, can excel a bed of blue Lobelia mixed with Gazania, and edged with Cerastium? Or, still more exquisite, if you extend this mixture of blue and orange into a groundwork for a panelled border, and dot along its centre at intervals of 10 feet single specimens of Centaurea ragusina, and belt the groundwork of orange and blue with scarlet—say Little David Geranium, you have a picture which I would just like the objectors to the bedding system to see before they condemned it. The quiet loveliness of such a combination must be seen to be appreciated, and is something like the “Banks and Braes o’ Bonny Doon” well played on the flute. The Centaurea and the Gazania being harmonic colours, as also the scarlet belt and the Lobelia, the eye is agreeably conducted from the one to the other, while the Lobelia adds a polished lustre to the whole. But to enter into details is not the object at present. I hope these few hints may be of service to some who have not given much attention to the matter, for the successful planting of even a single bed, where two or three colours are to be used, will be found dependant on the principles here so faintly indicated.

D. THOMSON.

For the last two years I have grown Cucumbers in pots 11 inches over, plunged in a bed of old tan bark, with pipes beneath for bottom heat, and also top-heated by pipes.

The plants, very small ones, were put in about the middle of February, and I commenced cutting on the 21st of April, but could have done so a few days earlier if fruit had been required. The produce for each month till the last plant was pulled up was for April, 9 fruits; May, 51; June, 54; July, 41; August, 40; September, 30; October, 32; November, 13; December, up to the 10th, 6; in all, 276 fruits from 12 to 24 inches in length, including ten for seed, some of which weighed over 3½ lbs. each. There were also very many small ones. The advantages to me of growing Cucumbers in pots are,—saving room elsewhere; getting shade during summer for a house that cannot be conveniently shaded in any other way, being surrounded by other houses; and a sufficient supply of Cucumbers for a small family and a few to spare for a neighbour occasionally.—J. T. CREED, *Gardener to F. Swanwick, Esq.*

[We hope to publish soon Mr. Creed’s mode of cultivating the Cucumber in pots.]

LEAVES AND FLOWERS OF GREENHOUSE PLANTS SHRIVELLED.

I HAVE lately erected a greenhouse and had it efficiently heated by hot-water pipes in the usual way. The plants were moved in in November.

My gardener and self are much puzzled to find the leaves of the plants, Geraniums especially, shrivel and drop off. Many of them get a sort of polish on the leaf, and the blooms of Camellias become tainted on the edges.

The only cause that we can divine is the supposition that the liquid with which the hot-water pipes are covered is gas tar, and that the more they are heated the more poisonous does the air in the greenhouse become. Can you enlighten me in the matter or suggest a remedy?—A BLACKHEATH SUBSCRIBER.

[You had better ascertain if your pipes are painted with gas tar, for if so, you will have no relief until it is all scraped off. The best thing to paint pipes with is blue-black and oil, with enough of white lead to give it substance, and enough of driers to make it dry hard and quick. Even in that case, however, it is advisable to paint so that the paint shall be thoroughly dried and the fumes given off before much heat is used. When much heat is given at once, we have seen plants suffer as you describe, unless plenty of air was also given. If such paint was used, a little more air now will make all safe. We painted the pipes of a vinery the other day in which there were a number of Geraniums, but we moved the Geraniums out for four days until the fumes were gone. Make sure you have no tar, for if you have you must remove it.]

AMARYLLIS CULTURE.

(Concluded from page 50.)

THERE is more than one way of doing a thing, and a case of this kind is before us. After the bulbs are potted or the strongest growth attained, they may be placed in a frame on coal ashes, lightly syringed, and kept close for a few days, but giving them the benefit of gentle showers. The lights may remain off in mild weather, replacing them during boisterous or very dry weather, and when heavy rains fall. This treatment may be followed until August, when the lights must be kept on, and neither water nor shade given unless it be a little of the former to prevent the leaves flagging. Air should be given until noon, when the frame must be closed; and if the sun raise the thermometer to 90° the more certain is ripening to take place, and a handsome scape of bloom to be produced the following season. By the end of September the pots should be removed to a dry shelf in a late vinery, stove, or warm greenhouse, and kept dry during the winter.

It not unfrequently happens that this class of bulbs becomes unhealthy, and for the recovery of such the old gardeners had a specific. They never thought of forcing Vines

METEOROLOGICAL NOTES ON THE YEAR 1863, TAKEN AT HASLEWOOD, SLIGO, IRELAND.

1863.	RAIN.			THERMOMETER.				ANEMOMETER †			
	Inches.	Degrees †.	No. of rainy days.	Highest.	Date.	Lowest.	Date.	No. of windy days.	Miles.	Furlongs.	Date.
January	5	...	25	56	22nd	25	6th	7	40	4	20th
February	24	15	16	52	27th	30	13th	8
March	37	15	21	58	22nd	28	8th	11	32	1	26th
April	24	16	18	60	24th	31	7th	4	22	4	28th
May	37	16	19	62	23rd	34	6th
June	33	...	24	68	18th	38	11th
July	4	18	7	73	28th	42	21st
August	4	7	25	72	8th	46	30th	...	18	...	15th
September	6	4	27	64	14th	36	25th
October	3	4	22	58	14th	31	6th	3	41	3	28th
November	3	2	23	54	19th	30	5th	5
December	4	16	24	51	6th	30	2th	8
Total	45	13	253	46

H. GEDDES, *Gardener to the Right Hon. J. Wyndham.*

CUCUMBERS IN POTS.

I HOPE that the following remarks may be of service to some of your numerous readers, who, like myself, may have to make one house answer a variety of purposes.

* Each degree the 100th of an inch.
† Velocity of the wind according to Dr. Robinson.

without making a hotbed under them, and this after it had been turned several times (for they took a pride in turning it over on sharp frosty mornings), and all danger of overheating past, was a mild hotbed. In this mild hotbed they plunged the weak bulbs, first of all making the drainage act like a sieve, and removing every morsel of sodden or sour soil. The bulbs, as might be expected, soon recruited their injured constitutions with such a gentle stimulant, and the kindest of treatment, as gentle waterings. These old gardeners were too wise to give a sickly plant as much strong food and water as a healthy one, and it is not surprising that they brought this tribe of plants to a degree of perfection which has not been equalled since their day. Any one that has seen but one of their seedlings will not wonder at the seedlings of our day being called degenerate representatives of a former floral world. Now this treatment is just what is specially adapted for the recovery of weak or sickly bulbs. Any that are so should be carefully potted, and plunged in a bottom heat of 75°, and but sparingly watered until growth has fairly commenced. When abundant roots are made more water should be given, and after the strongest growth water and every other encouragement, as a moist atmosphere and a gentle heat, should be continued longer than for healthy bulbs. Little water ought to be given after the middle of August, by which plan weak bulbs become so much strengthened as to be almost evergreen, and a quantity of roots remain on the plants during the winter, and this is always a sign of vigorous growth in the ensuing season. If this be the case it is not necessary to plunge them in heat in the following season; but if any are still weak they should be plunged in a brisk bottom heat (75°), and continued in it until August again, when they are to be dried off as before. A good practice is to plunge the bulbs in the pots in a hotbed, and keep them there at all seasons till they attain sufficient strength to bloom. Old cultivators not infrequently planted their bulbs out in narrow, shallow beds, over flues or a closed hot-water tank, and subjected them to the same treatment as those placed on shelves—that is, abundance of nourishment whilst growing, but no more after the growth was made than to keep the leaves from flagging. From October to March the beds were suffered to become dry. But this plan did not answer so well as plunging the bulbs in pots, for some would commence growing early, and as these could not be watered without wetting the dormant bulbs many of the latter perished. Where, however, there is convenience it is advisable to keep the pots plunged at all seasons, and to maintain an almost uniform temperature at the roots throughout the year, or from January to June 60° to 65°, with abundant moisture both in the atmosphere and at the root after growth commences; and 65° from June to January. Gradually reduce the moisture so as to dispense with it altogether after September, when the cultivator should be as careful about admitting a plant needing water, or wetting the floor, as if Muscat of Alexandria Grapes hung from the roof and were expected to hang until the new year. Contrary as this may seem to good management, I am persuaded that it is the best course to pursue, for within the tropics moisture is the grand stimulus to vitality as increase of heat is in our climate, and want of moisture the cause of rest, just the same as cold is with us.

Having now disposed of the treatment of these plants where every convenience is at hand for their cultivation, I will treat of their cultivation where perhaps only a greenhouse and a pit or two are at command. I will not say that amateurs with these limited means can grow all the species and varieties to perfection, for that would be leading them into error; but a great many of them can be successfully grown, and such kinds will, in the list to follow, be marked with an asterisk. The treatment about to be described is admirably adapted for bulbs on their being received either from the seedsman or in importations from abroad.

Now is a good time to purchase stock, as the bulbs are at rest, and those in hand will likewise be dormant. They should be potted as soon as received, just in the same way as a Hyacinth, in the pots and compost already named, and be placed in a hotbed at once, under a flue, or in any dry place where the temperature is seldom below 45° (the nearer to 50° the better). Here they may remain till the middle of February or beginning of March, and receive no water after

potting until the leaves appear. By that time a hotbed of tan, dung, or any fermenting material, should be ready to receive them, and in it they should be plunged. The temperature of the bed should not exceed 75°, 70° being more suitable. The bulbs will soon show the scape and leaves, when they must be slightly watered, gradually increasing the quantity as growth is made. In a few weeks the plants will be in flower, when they may be removed to the sitting-room window, greenhouse, or conservatory, to bloom. After the bloom is over place them in the greenhouse, and keep duly supplied with water and liquid manure until the strongest growth is attained—say July, then place on a shelf near the glass in the full sun, and gradually diminish the supply of water, so as to have them at rest by the beginning of October. They may then be stored away in pots, as near to the flue as not to roast them, and no more water given during the winter.

Some of them need no hotbed treatment, for example, *Amaryllis formosissima* (Jacobæa Lily), and *Hippeastrum vittatum*; these do well in the ordinary temperature of a greenhouse, and are two of the handsomest of the family. All growers of this beautiful tribe of plants will do well to bear in mind never to water the bulbs until they show signs of growth, unless they be plunged in bottom heat, but to allow them a natural period of rest. They will commence growing when they are ready; and watering before the leaves appear helps to cause the decay of the bulbs, and to destroy every root they have.

Raising from Seed.—Seed should be sown as soon as ripe, which may be done in the following manner. Drain a 48-sized pot extra well, and fill it three parts full of loam and leaf mould in equal proportions, and in a more than half-dry condition. If the seed be ripe in the autumn, the soil in which it is sown should be dry, and it will be none the worse if dry at any season of sowing. The pots being prepared, place a seed in the centre of each, and just cover the seed with sand. If sowing is done in spring or before June, place in a hotbed with a moist heat of 70°, and keep the soil moderately moist. After the seedlings appear above the soil, water more abundantly, and keep them growing as long as they seem disposed. It is immaterial whether they are kept evergreen for a couple of years, only allow them a season of rest by giving less water when they seem least disposed to grow.

After the second season they should be treated as for established or old plants in order to bring them into a blooming state. Under good management they usually flower in the third season. If the seed is received in the autumn it is a good plan to sow it as before described, but to keep the pots on a dry shelf, and not place them in heat until spring. The best of all plans for quickly bringing seedlings into flower is to plant them with the ball entire, and as close together as a 48-sized pot will allow, in good hazel or yellow loam 6 inches thick, with 3 inches of drainage below it, and to place the pots over a hot-water tank capable of heating the soil to 70°. This planting is to take place after a season's growth in pots. Here the bulbs may be kept well supplied with water in winter as well as summer, and this will make them evergreen. Two years of this treatment will give them strength, and in the third season they will have much the appearance of Shallots, each bulb striving to squeeze its neighbour out of the earth and make way for itself. They should be allowed to become dry after the third season's growth has been made; and the strongest flowering in the ensuing season, they can be marked if worth anything, and potted after the growth has been completed.

Insects.—White scale frequently fastens on the bulbs of sickly plants, and lodges between the scales. A soft brush with a narrow blade-like yet pointed handle should be provided, and the insects dislodged with the handle, and finally brushed out from between the scales. This, repeated from time to time as occasion may require, is the safest mode of keeping the bulbs clear of these pests.

Mealy bug likes to creep in beneath the scales, where it lurks while the bulbs are at rest, but when the leaves appear it leaves its hiding-place and evidently enjoys the change. A certain cure is to use a brush dipped in soft soap and water, and to brush well into the scales or beneath them, but too much soap should not be used; half a pound in a gallon of water is the proper strength. On the leaves the insects may be quickly dispatched by using a wet sponge.

In drying or ripening the bulbs thrips is sometimes very troublesome. The best remedy is to make a solution of soft soap, 8 ozs. to a gallon of water, and having two pieces of sponge to dip both in the solution, and with one in each hand commence at the bottom of a leaf and pass the sponges up both sides of the leaf at once. All the leaves of a plant may thus be gone over in a minute or two, and this is better and more effectual than fumigating, in addition to saving so many pounds of tobacco. Brown scale is readily removed by following the means recommended for destroying mealy bug.

List of Sorts.—The following list includes most of those in and out of cultivation. The first twenty-five are species and varieties, and can be had by importing them direct from their native habitats, as but few of them are at present in cultivation. Those marked * are hardy stove plants (except *H. psittacinum*, *H. vittatum*, and its variety, which are greenhouse perennials), and succeed with hotbed treatment; † tender stove plants and must be kept rather warmer than those not distinguished by a mark, which are ordinary stove plants. The varieties enumerated are hardy stove bulbs and do well under hotbed treatment.

* <i>Hippeastrum anticum</i> . Green and scarlet. Brazil.	<i>Hippeastrum crocatum</i> . Saffron. Brazil.
* <i>aulicum platypetalum</i> . Orange. Brazil.	* <i>equestre</i> . Scarlet. West Indies.
* <i>aulicum glaucophyllum</i> . Crimson and green. Brazil.	* <i>equestre major</i> . Scarlet. West Indies.
* <i>psittacinum</i> . Green and red. Brazil.	* <i>equestre plenum</i> . Scarlet. West Indies.
* <i>solandraeforum</i> . White, &c. Guiana.	<i>fulgidum</i> . Orange scarlet. Brazil.
* <i>solandraeforum rubro-striatum</i> . White and red.	<i>ignescens</i> . Bright orange.
* <i>solandraeforum purpurascens</i> . White and purple.	<i>rutillum</i> . Scarlet.
* <i>calyptratum</i> . Green and red. Brazil.	* <i>vittatum</i> . White and red striped. Cape of Good Hope.
* <i>stylolum</i> . Coppery orange. Maranham.	* <i>vittatum majus</i> . White and red striped. Cape of Good Hope. (The last two are almost hardy).
* <i>reginae</i> . Scarlet and green. Spanish Main.	* <i>ambiguum longiflorum</i> . White and red. Lima.
* <i>reticulatum</i> . Purplish red. Brazil.	* <i>anomulum</i> . Crimson and green.
* <i>reticulatum striatifolium</i> . Purple. Brazil.	* <i>organesc.</i> Crimson and white. Brazil.
	<i>pulverulentum</i> . Orange. Brazil.
	<i>princeps</i> . Scarlet. Brazil.

Varieties or Hybrids of the Above.—For the parents of the best raised by enthusiastic growers when Amaryllids were the fashion, see Vol. III., New Series, p. 99; and Vol IV., New Series, p. 371, for a descriptive list of some handsome varieties for the most part unpurchaseable. I shall confine myself to those purchaseable, and only name a dozen of the best.

- Ackermanni, crimson, two flowers in a scape, large flowers, but indifferent in form.
- Ackermanni pulcherrima, deep crimson, form good, four blooms in a scape.
- Johnsoni, scarlet and white; an old but good variety.
- Johnsoni striata, differs but little from the last; the stripes, however, are more conspicuous.
- Brilliant, scarlet; a fine showy flower.
- Delicata, a stripe down the middle of the leaf, flowers scarlet and white; a fine flower.
- Baron von Heckeren, striped, good in shape, deficient in substance.
- Cleopatra, very showy, and of good substance; dark red, margined with white.
- Marginata conspicua, white, with crimson stripes, of good form and substance, and a free bloomer.
- Prince of Orange, large and showy; colour bright orange.
- Ignca, brilliant scarlet, showy.
- Crocea grandiflora, orange scarlet dashed with white, good substance, and very showy.

Probably the best collection in Europe at the present is at M. L. Van Houtte's, Ghent, Belgium. Mr. Williams, Paradise Nursery, Holloway, has a good collection, and he is the only one that has shown a seedling of note lately. Messrs. Cutbush, of Highgate, have a fair collection, and most nursery and seedsmen can supply bulbs enough for a beginning. Only create a demand, and we shall soon be inundated with numerous varieties, and there is no flower that is worthy of more extended cultivation.—G. ABBEY.

HYACINTHS AND CINERARIAS NOT BLOOMING.

I SECURED a lot of what seemed to me to be fine Hyacinth bulbs last October. The moment I had them I potted in the ordinary soil used for Hyacinths—viz., good rich loam, a little leaf mould, and some well-rotted dung

with some sand, and gave them the same treatment I used always to give the bulbs previously, when I used to have fine spikes. I took some into heat about the beginning of December with every promise of a fine bloom on them, the young growth, or shoots, being fine and plump and about 1½ inch long; but to my great disappointment they are not throwing up their spikes at all, but flowering just as the spike is seen when the leaves expand. The leaves are now 4 inches long, and the spike is so diminutive that it cannot be seen. I examined them before taking them into heat, and found that they had their pots nearly filled with fine strong roots. I am quite at a loss to know what to do with them. Any suggestion you will be good enough to offer will much oblige.

I have also a lot of Cinerarias, some in six-inch, some in nine-inch pots. These I cannot manage to get to flower to my wishes: they have always more leaves than flowers. I may mention, that to try and prevent this I have grown the Cinerarias in poorer stuff than usual—viz., loam and a small sprinkling of leaf mould. The plants made fine growth and looked promising, but to my disappointment they are not better than in last and previous seasons.—A CONSTANT READER, Ireland.

[Perhaps the Hyacinths were scarcely sufficiently rooted, and, perhaps, the roots had been placed in rather too much heat and too suddenly, whilst the top of the bulb was rather cold. To counteract this latter evil, place some small 60-pots reversed over the bulb, daubing up part of the hole in the top, so as just to let a little light in, or what, perhaps, is better, make little paper funnels with a very little hole at the top and place these over the bulbs to help to draw the stems up, as described in "Doings of the Week," last week. "R. F." used to be similarly troubled with early Hyacinths, the flower-stems not rising sufficiently to allow the flowers to expand, until he tried the pot-and-funnel method, and after that he was rarely troubled with a stumpy flower-stalk. Cinerarias to bloom freely in winter should rarely be in pots larger than from 5 to 6 inches, and these should stand on a cool moist bottom. Whenever pots are crammed with roots the flower-stems will rise. Poor soil is also best for winter. To delay flowering give plenty of pot room.]

LETTER FROM JAPAN.

Kanagawa, Japan, Sept. 8, 1863.

THE exclusion of foreigners from the great cities of this country, where, as in other countries, the art of horticulture, as well as other arts of civilisation, is to be found carried on most successfully, and in the greatest perfection, renders the means of observation and comparison very limited. Those who pursue the business here are not cultivators to any extent, having but small premises for the sale of plants, all of which are brought from Yedo. The demand is very considerable for ornamenting the grounds belonging to foreign residents, and must be a source of much profit—estimated at the value of things among themselves—to the dealers. A large quantity are taken away in Wardian cases by officers of vessels and visitors returning home, few of which probably survive. In consequence of this demand, and its natural result, to bring into the market a greater variety, I have the impression that we are pretty well informed of what they chiefly cultivate.

As I mentioned before, it is remarkable, considering their isolated condition and past exclusiveness, the number of introduced plants that are cultivated. *Gardenia florida*, *G. radicans*, *Manettia cordata*, *Vinca rosea*, *Lagerstroemias*, *Pomegranates*, *Hoyas*, *Oleanders*, &c., are common.

Among the chief novelties I have met with the past spring and summer are the Primroses, of which there are two species (?) or very distinct varieties; one having flowers about the size of a well-grown Chinese Primrose, and in colour of various shades of purple, plain, and mottled with lighter shades. The other species sends up a strong foot-stalk, with a crown of flowers on the top, after the manner of a Polyanthus. This footstalk still continues its growth, producing another crown of flowers before the first fades, and so continuing until a third and a fourth are produced in succession. The flowers are also of a purple colour, but not so large in size as the first. The leaves of both species are

more nearly alike to the Polyanthus than to the Chinese Primrose, and probably the plants require the same treatment. They will doubtless prove decided acquisitions to the list of early spring flowers.

Another novelty I have met with is a real *Deutzia sanguinea*. This plant, you know, although long enumerated in nurserymen's catalogues, has hitherto proved a horticultural myth; at least, after frequent endeavours to procure it, I found it so. You may imagine my delight at finding it, and with double flowers, at last. It is a double garden variety of *D. scabra*, the back of the outer petals being a decided pink colour. As an addition to the shrubbery, or for early forcing for bouquets, it will prove invaluable.

While these and others in their turn excited my admiration, the greatest of all was *Lilium auratum*, which I notice has already been introduced into the States. Never having read any description of it, I was surprised, when I first saw it, that so conspicuous a plant, and so easy of introduction, had been passed over so long; and expressing myself so to a friend who is much interested in horticultural matters, he showed me a figure of it in Curtis's "Botanical Magazine." It is a superb Lily, and deserves all that has been said in its praise. It is plentiful among the hills a short distance from here. *L. lancifolium* I have not seen growing wild; and on inquiry of an intelligent Japanese gardener, was informed that it is only cultivated. That it is only a variety of *L. auratum*, as is suggested, has an appearance of probability, only that seedlings from it retain all its marked characters.

The many different varieties of *Ardisia*, unknown with you, are very attractive, not only for their peculiar variegations, but also for their various forms of foliage. They are considered rarities, and consequently are highly valued. I anticipated finding some new and distinct varieties of *Azaleas* in the season of their bloom. In this I was disappointed, seeing few or none equal to those cultivated in the greenhouses at home. Those chiefly grown are of the *Azalea lateritia* and *A. punctata* style.

One of the neatest variegated-leaved plants I have seen is a small, low-growing *Rose*, the leaves of which, in the spring and early summer, are distinctly and beautifully margined with white, with occasional pink stripes. A low-growing *Euphorbia*, with leaves mottled with red, white, and green, is also a very neat plant; and if, as I am informed, it is a perennial, it will be an addition to the cold frame, if it is not hardy enough for the herbaceous border.

The past spring and summer have afforded me an excellent opportunity of tasting the fruits in their season. The first that makes its appearance is the fruit of a species of *Rubus*, apparently more nearly allied to the Blackberry than to the Raspberry. It is of a light yellow colour, small in size, with rather soft flesh. The flavour is peculiar, and somewhat insipid, but, eaten with sugar, it becomes tolerable enough, and quite equal to some berries at home with high-sounding names that require plenty of the same material to render them palatable.

In the month of June, Apricots come in, and for two or three weeks are very abundant and cheap. There are several varieties, but all small, and about as deficient in flavour as early Apricots are apt to be elsewhere.

Before Apricots are entirely gone the fruit of the *Mespilus japonica* is brought into market. It is a favourite fruit with the Japanese, and large quantities are brought in daily. When ripe, they are very juicy, and have a pleasant sub-acid flavour, that may be compared to a fine ripe Harvest Apple. Their size, when in perfection, is about that of a medium-sized Gooseberry. Towards the latter end of their season they become smaller, owing, probably, to the overbearing of the trees.

Following these come Plums, which remain in abundance several weeks. Of these, the variety is greater than of Apricots, and some of them equal in size and flavour to those brought into the markets of New York. None, perhaps, equal the Green Gages, or Golden Drops, and other first-rate sorts, but are quite so to some classed as desirable second-rate Plums.

Somewhat reverse to the order with you, Peaches succeed Plums. Although of fair size and appearance, they are inferior in flavour. This may be partly attributed to the practice of picking all their fruits in a very green state. No

fruit suffers more from this treatment than the Peach; yet it would hardly be possible, owing to the tenderness of their flesh, to bring them to market as they should be eaten, ripe from the tree. They are now nearly gone, and have become almost worthless from the injury done them by an insect of the *Curculio* (?) kind, that stings the fruit and deposits its larva as does the *Curculio*.

Musk Melons and Water Melons have also been abundant. The former are very inferior, and would not be tolerated on your table; the latter are fair, and would be better, only for premature picking.

Grapes and Persimmons are now making their appearance. The latter, next to the Grapes, are, in my opinion, the best fruit we have; they certainly are the peculiar fruit of the country, and take the place of Apples in our own. Whether they would answer to make pies I do not know; but as the Japanese do not indulge in that home luxury, it does not enter into the estimate of their value.

I had almost forgotten to include Apples in the list of fruits brought to market for sale. Not many are brought in, and their season is soon over. They are a very small, early variety, and when eaten just at the right time are very passable. Pears, too, are now coming in; those hard, granular, indigestible things you have seen, called the Chinese Sand Pear. As an ornamental tree it has its uses, but as a fruit it cannot be recommended. Large quantities of them are consumed by the people. Different sorts are cultivated, one of which keeps all through the winter and spring following.

Until the present season, nothing has been done by foreigners for the introduction of finer fruits (except the Strawberry) into the country.

Last spring, Frank Hall, Esq., and Col. George S. Fisher, U.S. Consul, both made importations of trees from California. Between them quite an assortment of the best varieties of Cherries, Plums, and Pears has been introduced, and they are now growing finely in their gardens. Their Peach trees, Grape Vines and a few minor fruits, unfortunately did not do so well. Others, no doubt, will be induced by their success to follow their example, and the best results, by means of private enterprises like these, may be fairly expected, and the introduction of choice fruits create new desires, and lend their aid in civilising a barbarous people.—T. Hogg (*in the American Horticulturist*).

THE BEDDING CALCEOLARIA.

SOME four or five years ago the utility of the *Calceolaria* as a bedding plant appeared to be drawing to a close. In some districts it had previously been one of the gayest ornaments of the parterre, but a disease seemed to carry off the plants suddenly, making many awkward gaps in the beds they had been destined to occupy. This misfortune was, I believe, most prevalent in the midland counties, and fears were entertained that the last days of the *Calceolaria* had come, especially as a few years before the *Petunia* had ceased to be depended on as a good and certain bedding plant, on account of its dying off at various times and leaving a scanty and irregularly filled bed. Some years before the *Petunia* retired from active service, the *Anagallis* had done so in a like manner; and though both the *Anagallis* and *Petunia* are occasionally met with, neither is regarded as the useful good bedder which it was held to be some twenty years ago.

Now, those who remembered these two plants doing good service at that time, and subsequently becoming uncertain from some cause akin to constitutional debility, had their misgivings that the *Calceolaria* was destined to follow them at some early date, which the diseased plants, met with in 1858 and 1859, seemed to indicate was not far distant. Fortunately, however, this anticipation has not been realised, and the *Calceolaria* seems to have recovered its wonted vigour, and it fulfils its duties in a more effective way than before, in consequence of the improvement in some of the kinds now cultivated.

It is, however, proper to state that the disease which threatened to decimate the bedding *Calceolaria* at the time mentioned was not by any means universal in its attacks. At Linton we never lost a plant from the causes assigned else-

where. The only evil to be complained of last year was the lack of growth arising from the dryness of the weather, and the consequent absence of flower in the latter part of summer. This evil has been a constant one in dry seasons; still there must have been some other agent at work than dry weather in the districts where the plants succumbed, but what, it is difficult to say. It is, however, pleasing to know that the evil has disappeared, and that the *Calceolaria* remains one of the most useful and most popular flowers we have. It forms an important bedder in every garden, and few ribbon-borders are complete without it; and when we take into account its easy culture and adaptability to almost all situations, we need not wonder at its general popularity: hence, there is little likelihood so long as the plant shall remain healthy of its falling into disrepute, especially when we consider that one of the colours it represents is not met with in like abundance in any other plant.

As the plant may be now said to have recovered from the disease which in some districts threatened its existence, and is again fully employed in the decorative department, it would be worth while inquiring how much further its services can be made available. Although the easy mode by which it is propagated has been repeatedly explained in the pages of this Journal, a further illustration of the ready adaptation of this plant to its situation may not be out of place; and in giving this, I may observe that the accommodation which the young plants require in winter is within the reach of many cottagers. I am not certain that glass in any shape is absolutely indispensable; for though with me glass is often used, yet there have been cases where several hundred plants have been struck and carried through the winter without the aid of that important sheltering medium. In the garden here we have a cold pit bricked at the sides, and about 260 feet long by 6 feet wide. In this pit cuttings are put in about the middle or end of October. About 3 inches by 2 is the distance they are apart, and generally not more than one in a hundred fails to grow. When glass lights are not to be had wooden shutters are used as coverings in cold weather, and very rarely indeed is anything else needed. Certainly glass is better for the more delicate kinds, as those partaking more or less of the herbaceous class—as Sultan, Gem, Lady Havelock, and others; and even Prince of Orange is far from being a hardy kind. *C. amplexicaulis* ought in general to have another place, as it will not endure the same amount of frost the other varieties will do. Very little attention is given until March, when the cuttings will want thinning, which is done by taking up alternate rows and planting them out on some warm sheltered border, to be protected by mats or anything that comes to hand. Those remaining are benefited by the additional room, and the whole are ready to plant out in April.

The time of planting out *Calceolarias* will, of course, depend on the condition of the plants and the amount of cold air they have been previously subjected to. I have for many years planted some out in April with more or less success, and last spring some of the best plants I had were planted out in the places they were to occupy in the last week in March, a few laurel boughs being laid over them for a time, and for early flowering they never did better. It must be borne in mind, that the plants were duly hardened-off before that time; a total exposure night and day had inured them in a certain degree to the cold they would be exposed to from side currents and other causes, and to which, from growing thickly in the pit, they were not used. Fortunately, however, the weather which followed their planting out was mild, and they scarcely received a check—much less than I have known them sustain in other years when planted later. The showers in May and June induced both growth and flowering, while the dry weather in July favoured the latter only; so that by the beginning of August every shoot-end was furnished with flowers. But the growth of the plants being stopped by dry weather, there was no after-crop of flowers to succeed the first; and the consequence was, that at the end of the month the beds of *Calceolarias* that had been so gay previously were nearly destitute of flowers. I need hardly say that artificial watering might have done much towards saving the flowers and furnishing more; but water is often scarce in dry hot seasons, and could not well be spared for the purpose. When this is the case the *Calceolaria* as an object of ornament is

nearly over for the season. The beds of yellow *Calceolaria* had to depend in a great measure for their colouring on *C. amplexicaulis*. This, though not better than its neighbour in withstanding heat and drought (in fact, it shows greater distress under such circumstances than the shrubby class), is of such utility for late flowering as to be often favoured with a drop of water to prolong its growing powers, and when rain sets in it rewards all previous care by its abundant blooming.

To the general hardness of the *Calceolaria* every one will bear witness. Twice or thrice during the last dozen years beds of the yellow shrubby varieties have withstood the winter here and flowered beautifully. But the first show of blooms on such beds is the best; for the ground being fully occupied by the roots of the plants, there is very little or no after-growth, and consequently but little succession; so that I have generally found it advisable to destroy the plants in autumn, and put in young ones in spring. Isolated plants in a mixed border, however, frequently do better, as they have more room, and grow and flower accordingly; and in the winter of 1862 a row that had formed part of a ribbon-border was left in its place, and flowered admirably last summer, not a plant failing throughout the season. I will not discard the *Calceolaria* in consequence of its ceasing to be ornamental so early in the summer, until some other plant of equal merit is presented to us that will endure the dry weather we are now and then subjected to. When the *Calceolaria* seemed likely to fall a prey to the disease which carried off so many plants some four or five years ago, I suggested the *Tropeolum* as the best substitute, and, perhaps, with a little further improvement it will be so; but it yet lacks so many of the good properties of the *Calceolaria* that we cannot well spare this favourite from the parterre; the poor cottager has enlisted it into his service, and yellow *Calceolarias* are as common as Stocks once were, and it is a question if the one is not as hardy as the other. The practice of neighbouring gardeners who propagate and shelter their *Calceolarias* in a homely and easy way has taught the cottager to do so likewise; and at turning-out time he, too, at times, has plants to ornament the garden of a less careful neighbour, or, perhaps, to dispose of to some one able to recompense him for his trouble in propagating and saving them through the winter.

It is not necessary here to go into the particulars of varieties adapted to bedding purposes, as each district possesses its own favourites, and now and then new kinds are introduced, which only find their way into a very limited district. There is no lack of useful kinds of the yellow section, but hitherto we have not been favoured with a good white, those we have had being either bad in habit or defective in some other way. I will not regard the *Calceolaria* as perfect until we have a white variety as good in its way as *C. Aurea floribunda*, and I hope to see a nearer approach to a scarlet than has yet been attained. Assuming we had a scarlet, white, and yellow all alike good, it might then be time to inquire after the other colours; but it will probably be considered that I have already asked enough; and I will merely express my hope, that I shall hear of the skill that has hitherto been bestowed on the improvement of the yellow and dark varieties being directed to that of the white, as we are far from being well supplied with flowering plants of that colour. Although the abundance of white-leaved and white-edged plants renders white flowers less necessary for distant display than they used to be, yet I hope that the improvers of the *Calceolaria* will not be discouraged at this, but will persevere in their endeavours; and the object aimed at will, I have no doubt, be attained in time.

J. ROBSON.

NOTES ON THE TUBEROSE.

LINNÆUS instituted the name "*Polyanthes*." He writes it so in all the editions of the "*Genera Plantarum*;" but it is curious to see that in the index of the second edition it is entered as *Polyanthes*, perhaps by some pupil who fancied he was correcting an erroneous orthography. It should be mentioned, however, that in one of the very earliest of Linnæus's works, the "*Hortus Cliffortianus*," the orthography is *Polyanthes*. Very likely this may have been the work of a proof-reader, correcting what he took for a typographical

error. At any rate, Linnaeus ever after carefully wrote "Polianthes." Although he never explained the etymology of the word, so far as we can learn; yet, in the words of the "Botanical Magazine," it is generally understood that it was composed of *Polis*, a city, and *anthos*, a flower: the flower for city cultivation, perhaps.

I notice that Link, in 1832, reverted to the name *Polyanthes*, and that Kunth, in 1850, followed him. But no reasons are assigned.

This, the traditional explanation (which by no means originated with Sweet), may be "laboured and far-fetched;" but it seems to me much less so than that which derives the initial word from *Polios*, and connects it with the plant called *Potion* by Hesiod and Theophrastus, and *Polium* by Pliny. For, in the first place, the normal meaning of that Greek adjective is *hoary*; and, in the second, Linnaeus implicitly follows the old herbalist in identifying the *Polium* with a hoary-leaved species of *Teucrium*, *T. Polium*, *L.*

In Dr. Pickering's volume I find (on page 144) nothing which implies that the *Tuberose* has been cultivated in Egypt "for a long series of years," and before it was common in Europe; nor does he discredit the opinion of its American origin. The evidence in this respect, as adduced by Salisbury, is somewhat strengthened by the later discovery of *P. gracilis*, which Link conjectures to be, perhaps, the wild state of the *Tuberose*, in Brazil, and of a supposed third species, *P. mexicana*, in Mexico.—PROF. ASA GRAY, Cambridge, Mass.—(*American Gardener's Monthly*.)

ENTOMOLOGICAL SOCIETY'S MEETING.

THE January meeting of the Entomological Society was held on the 4th inst., the President being in the chair.

A number of coloured drawings representing the caterpillars of several species of Moths of the genus *Anticlea*, both of the natural size and magnified, executed by Mr. Buckler, were exhibited by Mr. Newman. A large collection of drawings of the transformations of British Lepidoptera, executed by Mrs. C. Cox, were also exhibited by Captain Cox. The investigation, description, and delineation of the preparatory stages of our native Moths has, indeed, become a marked feature in the entomologists' labours at the present time. Captain Cox also read some notes containing practical hints for the collection, discrimination, and identification of these larvæ.

A communication was read from the Lords Commissioners of the Admiralty, enclosing a circular letter from the Governor of St. Helena, respecting the ravages committed in that island by the White Ants, which, as was supposed, were introduced into the island accidentally about twenty years since, from the coast of Guinea, and that now almost every dwelling, store, and shed in James' Town, containing nearly 4000 inhabitants, has been seriously injured by them, involving in many instances complete ruin and abandonment, and imperilling the lives of large numbers of the poorer classes who are living in houses of doubtful security. The Governor was especially anxious for detailed information as to the most successful mode of finding the Ants' nests, and effectually destroying these receptacles, as well as to the description of timber which has proved to be the least susceptible of injury from the insect, and the average market price of such timber at per cubic foot.

General Sir J. B. Hearsey gave an account of his own experiences in India in connection with the White Ants, which were exceedingly injurious in that country. He had known a lady who had been killed by the falling of a beam, the ends of which had been attacked and reduced to powder by the White Ants; and in another case the flooring of an apartment had given way, the inhabitants falling with it into the cellar beneath. Ordinarily their nests were to be sought for in the plains, but if they obtained a lodgment in the walls of a house the walls themselves must be taken down. He had found that placing timber into a trough filled with quicklime, and water poured on it so as completely to saturate the timber, was an effectual remedy against their attacks, having himself built a house worth £3000 with timber thus prepared, which was in as sound a condition when he left India as when first built. Store-boxes, furniture, &c., should, however, be painted over with a solution of corrosive sublimate.

Mr. E. W. Robinson stated that in India the sleepers of the railroads were formed of kyanised timber, but it was necessary that the blocks of wood should be thoroughly saturated with the creosote by hydraulic pressure, and not merely coated over the surface.

Mr. H. W. Bates stated that on the banks of the Amazon, the houses in towns were not much infested by the White Ants, being generally built with *Acapu*, a very hard kind of timber. Chests, &c., were also placed upon sleepers or blocks of the same wood, which proved effectual. If the Ants effected a lodgment in the walls of houses (generally only composed of upright posts with cross laths filled-in with mud and covered with lime and cement), he had always found it effectual to fill up the holes in the walls with arsenical soap. At Para he had used the oxide of arsenic, but this was a dangerous process; but arsenical soap being cheap and easily used when diluted with water, the bottoms of chests, &c., might be washed over with it with great benefit.

Professor Westwood exhibited a small selection from a collection of Coleoptera and Lepidoptera recently forwarded to the Oxford Museum, from the Zambesi, by the Rev. H. Rowley, one of the clergymen attached to the Oxford and Cambridge Mission, containing many new and interesting species, although many of them were identical with the insects inhabiting Mozambique, described and figured in "Peter's Voyage" to that country by Messrs. Klug, Gerstaecker, &c. He also read descriptions of three new species of the singular Beetles of the family *Pausisidæ*, from India and South Africa, as well as descriptions of several new and interesting exotic species of *Lucanidæ*.

SALT A USEFUL ADDITION TO GUANO.

VARIOUS substances when added to liquid manure exercise a preservative influence upon that article. Liquid manure contains a rather large proportion of nitrogen, which is gradually transformed into ammonia; and a portion of this valuable compound is usually lost by exposure to the air. Sulphate of lime (gypsum), sulphate of iron (green vitriol), sulphuric acid, and such like substances, when added to liquid manure, prevent the escape of the ammonia; or if quicklime be employed when the manure is fresh, its nitrogen will be converted into nitric acid, and no loss will be sustained.

Common salt affects guano in a manner somewhat similar to the effect which gypsum exerts on liquid manure. It prevents the escape of its most valuable (if it be Peruvian guano) ingredient, ammonia. Some years ago M. Barral, the well-known editor of the French agricultural paper, the *Journal d'Agriculture Pratique*, performed an experiment relative to this point, the results of which proved the great advantage of mixing guano with salt. He left in the open air, on plates, equal weights of guano: one sample was pure; the other mixed with half its weight of salt. At the expiration of fifteen days the two samples were submitted to analysis, when it was found that the pure guano had lost 11.6 per cent. of its nitrogen (ammonia), whilst but 5 per cent. of that element had escaped from the guano which was in admixture with the salt.

Barral's experiments go to prove that highly ammoniacal guano loses a portion of its nitrogen when exposed to the air: when the farmer purchases his stock of this article he should, therefore, be careful not to expose it in open sheds. If it be at all possible, the best plan would be to mix it thoroughly with its own weight of salt, and keep the compound carefully covered up until the time for its application arrives. Gypsum, and even fine turf mould, may be employed as substitutes for salt; but the latter is, we believe, the most desirable adjunct. It will also be found to subserve other purposes than a mere fixer of ammonia; it acts as a solvent of the phosphate of lime of the guano, and of the fertilising matter contained in the soil. It is a useful manure for all kind of crops. Finally, it is valuable as an absorbent of moisture from the air; and as it requires water to bring out the full action of guano, the addition of salt to it will be found particularly beneficial in seasons of drought.

The kind of salt which is best adapted for mixing with guano is the refuse article from the fish and bacon curers.

This is coarse-grained and will keep the guano moist. It may be purchased at from 6s. to 10s. per ton.—(*Dublin Weekly Agricultural Review.*)

GOOSEBERRY-TREE TRAINING ON WALLS.

"A THREE-YEARS SUBSCRIBER" has applied for directions on this subject; but as it will interest others, we reply more fully.

Select for this purpose clean, healthy, and strong plants, with a clear stem a foot in height, and having chosen two shoots of uniform strength, the one diverging to the right and the other to the left, cut away all the remaining shoots; and having planted the requisite number of trees 4 feet from stem to stem, nail them. If the space to be covered is more than 6 feet in height the plants should not be so wide apart; 3 feet for an eight-foot and 2 feet for a ten-foot wall. The following summer all the shoots on the horizontals are to be rubbed off, except one to the right and one to the left of the stem, and 4 inches on either side of it; and as many more as the horizontals will hold should be left at 8 inches apart from these two shoots and the same distance from each other. The horizontal branches are to be pruned to about half their length if weak, one-third if moderately strong, and left their full length if very strong. The shoots from the extremity of the horizontal branches are suffered to grow at their freedom, and, to throw more vigour into them, the perpendicular shoots, if any, are stopped to three leaves; but when the horizontal shoots have grown 1 foot 8 inches on each side of the stem they are brought down to the horizontal line, and all eyes and shoots rubbed off, except, as before stated, those along them at 8 inches apart. At each of those distances a shoot is to be encouraged and trained upright. Sufficient should be left in pruning or disbudding at the places desired, in order to be prepared for emergencies.

At planting the tree will appear thus—
No. 1. In the autumn following the tree will be pruned and trained so as to appear like No. 2, if the shoots are trained 8 inches apart, or like No. 3, if left 6 inches distant.

In the second season the shoots are trained upright, and allowed to grow at their free will, only nailing them up so as to prevent their being broken by winds; and if any side shoots appear they are stopped to three eyes in July, but the leaders must not be stopped. They should, however, each be cut in the autumn to a foot in length (No. 4), and so on year after year until the space is covered.

All foreright or breast-wood shoots should be removed as fast as they appear in after years, retaining the short spurs only; for if the shoots be allowed to grow they will appropriate in the formation of useless parts the sap which ought to be expended on the fruit, and for the formation of fruit-spurs. It is too late to remove shoots in autumn, for they have then done all the harm they can, and thus ought not to remain on the trees longer than for two or three leaves to form, when they should be stopped. This encourages the formation of fruit-spurs, and admits light and air to the fruit and leaves.

When the old branches are worn out a young shoot should be encouraged near the bottom; and when the fruit is gathered the old branch may be cut out, and the fresh one trained in its place. Six shoots 8 inches apart are ample to leave on trees planted 4 feet apart, or at most eight; but when the shoots are only 6 inches apart the leaves on the spurs shade their neighbours too much, and the fruit is,

consequently, indifferent in flavour. Three, or at the most four, shoots from one tree are ample to train up a wall more than 6 feet high, and even then the trees are apt to become deficient of wood at the bottom. Six feet is quite high enough to train Gooseberries; and although I have grown them as standards to from 4 to 6 feet high, I found that they are but bushes, and are not suited for growing as wall trees, nor to be put on stilts to look at their neighbours over the hedge.—G. ABBEY.

WORK FOR THE WEEK.

KITCHEN GARDEN.

If any part of the garden is wet, drain it effectually. Make drains 3 feet deep and 20 feet apart; use tiles and soles, and place 6 inches of brickbats, stones, or clinkers over the tiles, and before filling in the soil shake a small quantity of litter over the stones or other material, which will render the drainage more perfect. *Artichokes* (Globe), sow seed in heat, and transplant when fit into boxes, to be finally planted out in April on ground previously trenched and manured; by this means a supply of this vegetable may be had two months later than can be obtained from the old plants. *Basil*, sow a small quantity of this, and *Marjoram*, in heat if they are required green. *Brussels Sprouts*, make a first sowing of this useful vegetable. *Cauliflower*, give all the air possible to the plants in frames, and under hand-lights. Watch the mice, and see that they do not injure the hearts of these plants. *Cress*, keep up a regular succession of this, and also of *Mustard*, and of *Rape* when the latter is required for salading. *Potatoes*, where the ground is light and dry a few Ash-leaf or other early sorts may be planted. *Sea-kale*, keep up a succession of this, and also of *Rhubarb*, either by covering with pots and fermenting materials, or by planting in pots and placing them under stages in the greenhouse or stove. The latter has the advantage of being much the less trouble, a great consideration in the busy time which is approaching. *Radishes* sown on banks and borders will require strict attention, the covering to be removed every fine day, and dry sand, soil, or charred refuse, strewn amongst them, for the prevention of damp, mildew, and shanking.

FLOWER GARDEN.

Proceed as rapidly as the weather will permit with the removal and planting of large shrubs. Layering may now be successfully performed where the shrubs have become bare and unsightly at the bottom. Finish the planting of *Box-edgings*, and fill up all gaps in the old ones. In the absence of frost prune hardy *Roses*, reduce the wood according to the luxuriance of the tree, the late-planted to receive that attention later in the season. Finish planting the hardy sorts, and protect their roots. Preparations should be made in the pinetum to receive any proposed addition to the collection. *Ranunculuses* and *Anemones* may be planted if the ground is in a dry state, and the weather mild. If the soil in the bed be in a poor condition throw it out to the depth of 1 foot, place a layer 6 inches thick of well-rotted hotbed and cowdung, and fill up the bed with fresh maiden loam from a pasture. *Carnations* and *Pinks* in pots to be attended to, remove all damp, and protect them from heavy rains. Keep *Auriculas* and *Polyanthuses* tolerably dry at this season, prepare a rich compost for top-dressing by frequent turnings. *Hyacinths* may still be planted; to have them in perfection, apply plenty of rotten cowdung to the beds; the beds that were planted in the autumn to be slightly stirred on the surface with a fork, and top-dressed with the same material. Prepare beds for *Pinks*, *Carnations*, and *Pansies*. Look over the *Dahlias*, and remove all damp and rotten portions from the stems and roots.

FRUIT GARDEN.

Continue pruning and nailing wall trees. Weed *Strawberry-beds*, and fork up the soil between the rows, but not more than 2 inches deep. Destroy all suckers that may have made their appearance in *Gooseberry* plantations, and finish making new plantations. Where *Filberts* are grown dwarf, which is the best method of cultivating them, let all suckers be effectually removed, and some manure forked in about the trees. Shorten all the strong shoots of last year's growth, and do not interfere with the small ones.

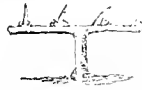

No. 1.

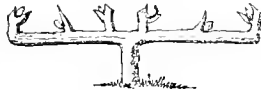

No. 2.



No. 3.

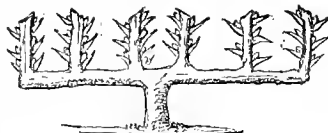

No. 4.

GREENHOUSE AND CONSERVATORY.

Heaths have a beautiful habit of growth, and where a tolerable collection is kept, some are in bloom every day of the year. If any free-growing variety requires a larger pot, repot it by all means, water with care, air freely night and day if the weather is at all favourable, stop the strong shoots of the free-growing varieties, and always keep the dead flowers cleared off. There are also some of the New Holland tribe of plants always in bloom. Even at this season many species of Epacris, Pimelea, Correa, Polygala, Boronia, Leschenaultia, &c., are in beauty; water with care and moderation, air freely, and be particularly cautious with fire for them and Heaths at all seasons, even when frost occurs fires must be very moderate indeed. While the Camellias are in bloom keep the house free from damp, but do not let the plants suffer from drought. Thin out the small spurious shoots of Pelargoniums, and never allow a decayed leaf to be seen.

STOVE.

Select a few Gloxinias and Achimenes in variety, shake them out, and pot the former in open turfy loam, heath soil, coarse charcoal, and sharp sand, well incorporated, and do not pot too firmly; equal portions of the soil, and a fourth part of charcoal, are what these plants delight in. The Achimenes tubers to be first placed in pans thickly, and potted singly as they appear in leaf mould and light loam, in a very coarse open state, with a fourth of charcoal added. These two tribes of plants delight in a moderate bottom heat, and to be started in bottom heat.

PITS AND FRAMES.

Give plenty of light and air to these structures in fine weather, inspect the plants at every opportunity, and pick off all decaying leaves. Fumigate with tobacco if the plants be infested with aphids. This ought to be attended to prior to taking off cuttings, as the insect soon increases in number when brought into a higher temperature. Pot off the autumn-struck cuttings of Scarlet and other Geraniums, Fuchsias, Verbenas, shrubby Calceolarias, &c., that are still in the cutting-pans, place them in a little heat until they are well rooted in the small pots. Prepare to make a hot-bed for cuttings and seeds by frequently turning over some stable-dung until it gets well sweetened for that purpose.

W. KEANE.

DOINGS OF THE LAST WEEK.

KITCHEN GARDEN.

A WEEK of dull, foggy, dripping weather has considerably retarded out-door work. When at all dry removed the decaying leaves from old quarters of Cabbage, Brussels Sprouts, Scotch Kale, &c., as what was decaying made the atmosphere unpleasant. Cabbages and Broccoli seem to have stood the severe frost well. When sufficiently dry, trenched and dug up ground, and turned over the ridges of what was previously done, that the soil may have the advantage of the air, and of being again well frozen if a second sharp frost should come. Potted some dwarf Tom Thumb Peas for early work, and sowed others in boxes. Transplanted Dwarf Kidney Beans into pots. Looked after Mushroom-beds. Potted Cucumbers. Sowed Chilis and Capsicums. Gave abundance of air to Potato-beds, Asparagus fit for use, &c. Took up a little more Sea-kale and Rhubarb to place in the Mushroom-house. Gave abundance of air, by tilting the sashes back and front, to Radishes, Lettuces, Endive, Cauliflower, &c.; and prepared ground for sowing out of doors Sangster's No. 1 Pea and Mazagan Beans; also prepared ground for transplanting autumn-sown Onions, planting Shallots and Garlic, and sowing a little of the Two-bladed Onion. Sowed also a pinch of the Silver-skinned in rather large pots in a frame, for drawing early for salads.

Threw a lot of horsedung together, most of it litter with a little horse-droppings, and mixed a few hot tree leaves with it to make it heat faster. This is not our general practice, as, if many leaves are used, they become too much exhausted before the manure is sweet. Generally, therefore, we throw the dung together until it is half made, and then we turn it over and mix with the leaves if we wish the bed to be uniformly made of dung and leaves. As we are always short of fermenting material we often only half-work the

dung—that is, throw it into a mass, and, as most of it is straw, water if necessary, keeping a little dry litter to throw over all. Then in ten days we turn it once, the sides to the middle and the middle to the outsides, and cover again. This will cause it to heat strongly; and long before it is so exhausted as to be sweet we make the bottom of the bed with it, and then cover with a foot or 18 inches of leaves, which if raked at all damp will be sure to be warm, and the heat from the dung will be sweet enough before it passes through the leaves.

FRUIT GARDEN.

Did a little pruning and nailing out of doors, but the weather was rather clammy for that work. Syringed with hot water the trees in orchard-house. Gave all the air possible to Peach-house to keep the buds back, giving it to front as well as back; and putting a slight fire on during the day to get the damp off, as every inch, shelves for Strawberries, &c., and every other available space is covered with plants. Our house has trees on the back wall, and on a low trellis in front, and the heating-pipes pass too near the trellis and go beneath it near the front; and did we not give abundance of front air, the little fire heat required to keep out frost and damp from the plants would excite the buds over the pipes, and we should have them in bloom before those towards the top of the trellis were little more than started. If such should be the case many of the top buds would be apt to drop, and therefore plenty of front air is necessary to keep the front trees in something like an equal condition all over. When once the fruit on the front trees is set all over we give less front air and more top air, and then the front trees come in considerably earlier than those against the back wall, and thus prolong the season of gathering.

In such dull weather all forcing should proceed slowly; and for early Vines, Peaches, Strawberries, &c., less fire heat, and more air will be required than in sunny weather. The most fire heat should in fact be used during the day, that an extra amount of pure air may be given, and the temperature at night should be no higher than just to be safe. Strawberries in bloom and swelling will soon feel the effects of a high temperature in such weather. Plants that would flourish in a bright sunny day in a temperature, with a little air, of from 75° to 85°, and a night temperature averaging 55°, in such dull weather as the last week, will require more air during the day. If the temperature should not range above from 55° to 60°, very cold air should not be admitted by great openings, and especially if the air is frosty. Giving a little early prevents the necessity of ever giving large amounts at this season, when there is a very great difference between the internal and the external atmosphere.

In all forcing where the buds are swelling, as Vines, Peaches, Figs, &c., much less syringing or moisture will be required in the low temperature and the foggy weather, than would be necessary in bright weather and in a higher temperature. When once the sun is looked upon as the best and cheapest forcing agent, more care will be taken to economise its heat, which is ever associated with the counteracting agency of light. Provided care is taken by early air-giving to prevent scorching and burning, plants will not suffer from a good rise from sun heat alone. Of course, if plants have been long shaded, or grown in a gloomy confined atmosphere, they will not be able to bear the full force of the sun's rays at once, and a little shading or syringing may be necessary to prevent too rapid perspiration, &c. But with such attention the more sun heat we get the better will plants succeed as a general rule. Early shutting up in the afternoon so as to confine the sun heat is, therefore, desirable, and the economical forcer will so contrive that the heat from his furnace acts just as the sun heat escapes by radiation. Mere heat acts on the tissues of plants by expanding and lengthening them, much as heat acts on other ductile bodies. Solid additions are chiefly made under the counteracting agency of light: hence the rapidity with which plants become weak and drawn in close, warm, shady atmospheres, and the necessity of light and air to make them sturdy and strong. We have found great differences in different tribes of plants, but as a general rule it will be found that fast-growing shoots that by careful measurement will have lengthened an inch or more during the night in a

moist warm atmosphere of from 65° to 70°, will not lengthen more than from one-eighth to one-fourth of an inch in a sunny day with a temperature of from 80° to 90°. By deficient air you may scald or scorch such shoots in bright sunshine; but unless your heat goes beyond all bounds, you will be unable to make such shoots drawn, weak, or lanky. The great rule, then, for the forcer is, to proportion heat to light, and, hence, to give much less heat at night than during the day. For instance: if we had had a Peach-house in bloom during this last foggy week, we should have given a little air and a temperature of 60° during the day, and an average of 45° at night, which would keep the blooms more robust than if we had also kept a night temperature of 60°. If a sunny day occurred, we would, of course, regulate the air according as the atmosphere was mild or frosty; but we would let the temperature rise gradually from 70° to 85°, or even more, and shut up the house early to retain as much as possible of the sunbeams. In such a case, to prevent a sudden check we would raise the night temperature to an average of 50°. We believe that the want of setting in early Peaches and Strawberries is frequently owing to the weakness produced by a high night temperature, or even a very high temperature in dull foggy days.

ORNAMENTAL DEPARTMENT.

The same principles as to heating apply to stove, conservatory, greenhouse, and bedding plants. The less excitement from heat during dull weather the better it will be for them. Less water will thus be required in all departments, and, of course, there will be less vapour to rise and be condensed against the glass, and so fall upon the plants. Little artificial moisture will be required so as to affect the atmosphere, unless what comes from the plants, so long as the weather is mild and muggy. In sharp frosts, as more artificial heat is required, more moisture from evaporating-pans or otherwise must be thrown into the atmosphere, and more especially as the outside air in such cases is generally drier than the warm air of summer. In giving air to pits and greenhouses it should be given freely in mild days. When very foggy only a little should be afforded, and a small fire may be used during the day to prevent the fog appearing inside the glass. In keen frosty weather the air should be given in small quantities, and almost entirely at the top of the house, that the fresh, dry, cold air may be moistened and warmed before reaching the plants, by passing through the moist warm air that is going out. Of course, front air may be also given if there are modes of heating it before admitting it; if not, confine it to the top. Very small openings at the top of a house will soon change the atmosphere over the whole enclosed space.

We have examined a lot of Caladiums and find them all right, and most of them beginning to move. They are apt to suffer when at rest from too much cold, and either too much dryness or too much moisture. Our pots were placed on the ground beneath the heating-pipes of a cool stove, the pots being set in and slightly covered with moss, and the top moss was sprinkled now and then with the syringe. This seems to have suited them well. All such plants, and Gloxinias, Gesneras, Achimenes, &c., that can be placed out of sight when at rest, are very useful for small glass houses.

Cleanliness in such dull weather is very important for securing a sweet atmosphere. Not only should the surface of the pots be stirred and freshened, all decaying leaves removed, pots washed, &c., but the glass, shelves, and stages kept scrupulously clean. In such circumstances, however, little water should be spilt or stopped about. Even stages should be washed and dried as the work goes on. Thus use water as hot as it can be borne, for the hotter it is it will dry the quicker. Put a very little bit of soap in it, use a flannel cloth, and damp and wash a piece of the stage without spilling the water. Collect the dirt in the cloth, pass it through the pail, wring it hard, and then dry-rub that portion previously wetted. Some young lads will soon learn to do this, so as not to require a lesson from the best housemaids. Even when the floors of plant-houses and conservatories, when extra ornamental, have to be kept very clean, it is often better to have handy lads for the purpose than to introduce females to do such work.

Having a few lights in a pit at liberty, we have com-

menced propagating Lobelias, Ageratums, and variegated Geraniums, taking some cuttings from those we stuck like faggots in large pots in the autumn, and which were in a vinery where a little dry heat was used. These we put in a cold pit in soil as thickly as they could be packed. A few of them seem to have damped at the points left, but are breaking nicely farther down, some of the most forward having leaves about half the size of a silver threepenny-bit. We would have liked as well if they had hardly begun to break for a month to come. The pit we are using for the cuttings has the present bottom from 24 to 30 inches from the glass—rather far off, but no shading will be needed, even in a sunny day; and if we find the cuttings length-upwards too much, we must elevate them nearer to the glass. As for vessels for cuttings, we have found nothing better than small 60-pots, well drained; and for anything rare that we wish to root quickly we would merely place a row of cuttings round the outside of the pot and the head of the cuttings pointing inwards, and if very anxious we would place a thumb-pot also in the centre of the 60-pot. We do not place cuttings near the sides of the pot because we think there is any peculiar virtue in burnt or baked clay, but because we believe that a hard resisting substance coming in contact with the swelling tissue (cambium) at the base of the cutting will cause roots to be sooner emitted. For general common bedding purposes we fill pots and other vessels all over. It matters little to us what these vessels are—wood boxes, semicircular drain-tiles with pieces of clay in the ends, old zinc evaporating-pans too worn to hold water, old spouting of houses too much worn out. Of all such vessels zinc is best. We never met with a plant that refused to grow in zinc, and therefore nothing can answer better for going inside vases or ornamental suspended baskets. These vessels not only enable us to spare pots, but also to save much time in moving. We have used old spouting from 2½ to 6 inches wide, and the first comes in well for very small things. If there are a few holes in the bottom all the better.

We obtained a good quantity of old spouting the other day, partly tin and partly zinc. We knew a lot had been replaced by new, and thought the tradesman must have removed it, but found it at length placed out of the way as useless among some high Laurels. Most of it was 5 or 6 inches across, and when setting about cutting it into lengths we found it had originally been soldered in 2½ feet lengths, just a handy size for moving about. A Larch pole was looked out of the suitable diameter, and cut across in little circles about three-quarters of an inch thick, and one of these split in the middle, did for filling the two ends of these pieces of spouting, two tacks through the spouting at each end keeping the pieces secure enough in their place. The semicircles of wood were not placed too near the bottom of the spout, so as to give plenty of room for drainage. Rough stuff was strewn along the bottom of the spout-box, a layer above not so rough, and then light sandy soil to within half an inch of the top. A little sand was scattered over this and the cuttings inserted. We shall thus have vessels for many thousands of cuttings from materials which otherwise would have oxidised into thorough decay, without doing good to anybody. Such wrecks from plate iron, galvanised iron, tin, &c., answer well enough for temporary purposes, but, as stated above, every plant likes zinc. We are unable to say how long zinc vases, pots, or propagating-vessels would last if constantly used, as we have never used them continuously; but if those who have used them long would give us the results of their experience, zinc in pretty shapes might be more employed as vessels for growing plants.

As soon as the weather moderated we were engaged when at all dry, in pruning and shortening Laurel bushes, boundaries, &c., as on this ground they are apt to become bare below, and to get stunted at the top, when not so treated. The shoots cut off will come in for many useful purposes: the smaller for protection-sticks, &c., and the larger when the leaves have fallen from them, for pea-sticks, as anything is better than nothing. The large cuts were all smeared over with a paint of clay and cowdung. This is a good time for planting, layering, turf, &c., if that was not done in the autumn.

Crocus, Tulips, &c., in some cases may want fastening in the ground, and mice must be looked after. All things in-

tended to be forced should be inured to extra heat gradually. For instance: we have seen Roses brought from being plunged out of doors, and at once placed in a hotbed of 80° to 90°, with a top heat of 60°. If the plants had first been moved to a temperature of 50°, then in ten days, if well rooted, plunged in a bed of from 70° to 75°, and the top temperature gradually raised to 55° and 60°, there would have been more chance of good success.

On a border out of doors, as soon as the frost went, we did what we should have done in November—forked it slightly over, levelled the surface, beat it down, covered it with half an inch of sand, beat that slightly, and then dibbed in about 1½ inch apart some thousand pieces (without any attempt to make cuttings) of *Cerastium tomentosum* and *Biebersteini*. These we think will yet root nicely before they are wanted, and fresh-planted edgings always look best. They will also fill up vacancies.

We intended ending with some words to window gardeners, but beyond urging cleanliness in pots, leaves, and shelves, we find we must defer until another opportunity.—R. F.

On Thursday, January 14th, Thos. Dean, a gardener out of place, was taken before Mr. D'Eyncourt, at the Clerkenwell Police Court, charged with stealing Camellias, Daphnes, and other flowers, from Mr. Bird's nursery at Stoke Newington, and was sentenced to two months hard labour in the House of Correction.

COVENT GARDEN MARKET.—JAN. 23.

In consequence of the unusual mildness of the weather the supply of out-door vegetables is very good. Broccoli from Cornwall, Savoys, Brussels Sprouts, and Coleworts are plentiful and good; and there is an ample supply of Endive, Lettuce, and Turnip Radishes from France. The Potato market is still heavy, and there are many inferior samples. Of Pines there is still a regular supply. Hothouse Grapes, though becoming more scarce, are sufficient for the demand. Pears are yet to be had, those in best condition being *Easter Beurré* and *Beurré Rance*. Of Apples there are some very good Newtown Pippins, Nonpareils, and Blenheim Pippins. Cut flowers chiefly consist of Orchids, Camellias, Pelargoniums, Roses, Chinese Primulas, Violets, Mignonette, Early Tulips, and Azaleas.

FRUIT.

	s.	d.	s.	d.		s.	d.	s.	d.
Apples..... ½ sieve	2	0	4	0	Mulberries..... quart	0	0	0	0
Apricots..... doz.	0	0	0	0	Nectarines.....	0	0	0	0
Figs..... doz.	0	0	0	0	Oranges..... 100	4	0	10	0
Filberts & Nuts 100 lbs.	0	0	0	0	Peaches.....	0	0	0	0
Grapes, Hothouse... lb.	6	0	10	0	Pears..... bush.	8	0	12	0
Foreign.....	1	0	2	0	dessert..... ½ sieve	6	0	10	0
Muscats.....	6	0	10	0	Pine Apples..... lb.	5	0	8	0
Lemons..... 100	6	0	10	0	Pomegranates..... each	0	0	0	0
Melons..... each	3	0	5	0	Walnuts..... bush.	14	6	20	0

VEGETABLES.

	s.	d.	s.	d.		s.	d.	s.	d.
Asparagus..... bundle	6	0	10	0	Leeks..... bunch	0	4	0	0
Beans, Broad..... bush.	0	0	0	0	Lettuce..... score	1	0	2	0
Kidney..... 100	3	6	5	0	Mushrooms..... pottle	1	0	1	6
Beet, Red..... doz.	1	0	1	6	Must. & Cress, punnet	0	2	0	0
Broccoli..... bundle	0	9	2	0	Onions..... bushel	2	0	4	0
Brussels Sprouts ½ sieve	1	6	2	6	pickling..... quart	0	6	0	8
Cabbage..... doz.	0	0	0	0	Parsley..... bunch	0	4	0	6
Capsicums..... 100	0	0	0	0	Parsnips..... doz.	0	9	1	6
Carrots..... bunch	0	6	0	8	Peas..... bush.	0	0	0	0
Caulliflower..... doz.	3	0	6	0	Potatoes..... sack	5	0	8	0
Celery..... bundle	1	6	2	0	Radishes doz. bunches	1	6	2	0
Cucumbers..... each	1	0	3	0	Rhubarb..... bundle	1	0	0	0
Endive..... score	1	3	2	6	Savoys..... per doz.	1	6	2	0
Fennel..... bunch	0	3	0	0	Sea-Kale..... basket	1	6	2	6
Garlic and Shallots, lb.	0	8	0	0	Spinach..... sieve	2	6	4	0
Herbs..... bunch	0	3	0	0	Tomatoes..... ½ sieve	0	0	0	0
Horseradish... bundle	1	6	4	0	Turnips..... bunch	0	4	0	0

TRADE CATALOGUES RECEIVED.

Chivas & Weaver, Chester.—*Catalogue of Vegetable and Flower Seeds, 1864.*

Bunyard & Sons, Maidstone and Ashford.—*List of Vegetable, Flower, and Agricultural Seeds.*

Barr & Sugden, 12, King Street, Covent Garden.—*Select List of Flower, Tree, Shrub, Ornamental Fruit and Foliage Plant Seeds.*

TO CORRESPONDENTS.

BRIDGE HILL (*Anti-Bosh*).—You have very much obliged us by your communication.

ASPHALT WALKS (*W. Jordan*).—You can easily calculate the cost; the process is as follows:—“Take two parts of very dry lime-rubbish, and one part coal ashes, also very dry, and both sifted fine. In a dry place, on a dry day, mix them, and leave a hole in the middle of the heap, as bricklayers do when making mortar. Put in this pour boiling-hot coal-tar; mix, and, when as stiff as mortar, but it 3 inches thick where the walk is to be. The ground should be dry, and beaten smooth. Sprinkle over it coarse sand; when cold, pass a light roller over it, and in a few days the walk will be solid and waterproof.”

PLANNING AND PLANTING (*Lunatics*).—We make it a rule not to give plans for gardens and not to plant them, but we will criticise liberally any proposed plan submitted to us. Your own case is just an example of the impossibility of doing this, however anxious we are to oblige. You tell us that you have a gravel walk 6 feet wide and 130 feet long, with a grass border on each side of the walk 12 feet wide, and that you wish to turn these grass borders into ribbon-borders, and wish to know how to do it; but you leave us quite in the dark as to what is beyond these present grass borders—in other words, we know nothing as to whether these ribbons should be level or slope for all their width on each side of the walk, or whether one half of the ribbon should slope to the walk and the other half slope the other way. Again; you wish to know the breadth of flower-beds and the breadth of grass between them. But if you wish to make a ribbon-border we do not see what you want with grass between or beds at all. Your simplest plan would be to leave 18 inches wide of grass next the walk; the same at the other side if a verge is wanted, which would leave you 9 feet for a dug border. If you wanted a pathway of grass at the back of your present grass border, and must take it off it, that must not be less than from 3 to 4 feet wide. This would still leave you a dug border of from 7½ to 6½ feet wide; but knowing nothing of the circumstances we cannot say whether your border will be 10½, 9, 7½, 6½, or any other number of feet in width; but whatever the width, your simplest plan would be to plant it in rows parallel with the walk, and just straight or curved as the walk may be. If the walk is straight plant or sow in straight lines. We notice Mr. Fleming, of Chiveden, prefers curved lines. For years we have used curved lines in such borders, and in some cases exactly as he has represented in his book noticed last week; but we confess we begin to think with the many that straight lines in such circumstances are best. But, whatever the arrangement—straight lines or curved, lined borders or spotted ribbon-borders—you can make all these arrangements in the planting without any grass divisions whatever. Then, once more. You tell us that you must use annuals; but you say not a word when you want them in bloom, or what means you have for raising them. Now, by sowing in autumn you can have annuals in bloom in spring; by sowing in spring you can have them in summer; and by sowing early in summer you can have a fine bloom in autumn, but few annuals will bloom all the season through. When you tell us more of your plans and resources we may be able to oblige you.

PLANTING FLOWER GARDEN (*New Forest*).—We presume your parterre is on gravel, with Box edgings. We think you have made a mistake in showing your second circle in the centre all round, as there is no way of reaching the centre plot of grass without stepping over the Box. Also, the same remark will apply to the outside lines of the four semicircles, which would break up the continuity of the outside walk. To make that regular the outside lines of the curved triangles might be carried a little farther on each side. These matters remedied, the parterre would look very nicely. Being placed in a panel, the plants in the beds should be as level as possible. If the tazza in the middle is much elevated, then it would be as well if the four circles were just a little higher than the outside beds. As you edge the tazza with blue Lobelia, we would not repeat Lobelia in these inner circles. The simplest way with them would be to centre them with four shades of Scarlet Geranium, or two shades—thus: two of Village Maid and two of Stella crossed, and a broad edging to two of Bijou and the same of the other two with Alma. This would lighten up your centre and contrast nicely with the plot of grass. Then your outside triangles might be two crossed of dwarf Tom Thumb edged with *Cineraria maritima*, and two of Christine Pink edged with *Cerastium*, or the whole might be Pink Geranium or pink *Verbenas* edged with mauve or crimson *Verbenas*, as *Charlwoodii*. The two wings—11, 12, 13, 14, 15, 16—will do admirably; 5, 6, 7 will also come in well, but then 8, 9, 10 should balance with them in colour. Just fancy a pretty rosy-cheeked lady with three ornaments hanging from her right ear, one in the centre, a long white pendant and a smaller blue one on each side of it, and then in the left ear a long pink pendant in the centre and a smaller lilac one on each side of it. If you approve of that style, then you will keep to your proposed plan of planting; and we have no right to find fault with it. Every man should carry out his own taste. It may become the fashion for ladies to wear an ornament only in one ear, just as it was once the fashion for them to show their political leanings by placing a black patch on either the right or the left cheek, but only on one cheek. If, supposing a lady should wear ear ornaments at all, you would prefer both ears to be decorated alike, then we think you should on the same principle balance your planting in a regular flower garden.—F.

PEARS ON QUINCE STOCK (*W. H., Tenterden*).—Do not cut off the young shoots. Bud during August and the first week in September.

INARCHING VINES—REPOTTING FIGS (*An Anxious Inquirer*).—The Muscat Hamburg is greatly improved by being inarched on the Black Hamburg, and you cannot do better than as you propose. The process is so very simple and certain that you cannot fail. As soon as both stock and young vines have made about 2 feet of a young growth, unite them, green wood to green, by taking a clean slice from the side of each about 2 or 2½ inches long and deep enough to reach nearly half through the growth; then fit them nicely together and tie them moderately tight with a band of soft matting. Continue to supply the young plants with water till the union forms, and then dry it off by degrees. About twenty days will form the union. We do not think the Golden Hamburg a good stock to work the Chavouah or any other vine on to—it is tender itself, and the Chavouah will do much better on its own roots. You can report figs just as they are starting into growth.

INARCHING THE BARRADOSSA VINE ON WILMOT'S HAMBURG (*W. J. L.*).—It may be inarched, and be more likely to be fruitful than on its own roots.

TREE ONION (*A Young Subscriber*).—It is to be found in many old-fashioned gardens, and might be obtained from some London seedsman. Country seedsman and nurserymen are not likely to keep it in stock, as it is more curious than useful.

ABUTILON STRIATUM AND BEGONIA FLORIBUNDA (*A Constant Reader*).—The plant of which you send flower and leaf is *Abutilon striatum*. You may thin it out and tie it closely in as you propose, in order to let in more light to the plants below it. Your *Begoniae* will be all the better of a rest for two months. Then, to do them justice, they ought to have stove heat.

BOILER FOR GARDEN STRUCTURES (*A Constant Reader*).—When we have seen your boiler we shall be able to form an opinion as to whether the prices are deserved.

CALADIUM ROOTS DECAYING (*P. P.*).—We have not the least doubt that the roots had been kept too dry before you received them. This is certain to cause them to become farinaceous, and the roots decay as soon as placed in contact with moisture, for moisture is necessary to vegetable decomposition. There is nothing singular in your case. The roots were dead when you received them, but being dry they appeared fresh; but their vital energies were gone, and you only hastened decomposition by placing them in soil. *Caladiums*, *Gloxinias*, *Cyclamens*, and many others not properly true bulbs ought never to become dust dry at the root, not even when at rest; but the pots containing them ought to be placed on a damp floor at that period. Under no circumstances is it wise to take them out of the pots and store them away on shelves. The keeping *Caladiums* in too low a temperature will also cause their decay, and, like death from dryness, it does not show itself until the bulbs are placed in a moister and warmer atmosphere.

CAMELLIA BUDS FALLING (*Amateur*).—Something must be very wrong with the roots of your plants. The soil may be sour for want of perfect drainage, which will undoubtedly destroy the roots, and the buds consequently fall for want of support. See to the drainage and make it perfect, and if the soil is sodden remove it and replace it with fresh. Have the plants sufficient light in your large conservatory? for, if they are made to form buds in a comparatively dark house, these are imperfect and drop off because incapable of expanding through the imperfection of their parts.

FERNS FOR SUNNY ASPECT (*Amateur*).—We know of few Ferns that will bear exposure to the powerful rays of the sun. Those most likely are *Polystichum vestitum proliferum* and *P. angulare proliferum*, *Laetrea glabella* and *L. acuminata*, *Doodia* (*Woodwardia*) *aspera*, *Blechnum occidentale*, *Lomaria alpina*, *Pteris serrulata*, and *Asplenium bulbiferum*.

FERN MANDAL (*Idem*).—"The Reader," the most impartial weekly critical journal, says that this Manual is the best and cheapest yet published.

CULTURAL DIRECTIONS (*W. F. C. K.*).—Those who require instructions in the whole routine of gardening must buy some cheap work of reference on the subject, such as "The Cottage Gardeners' Dictionary." If in that there are directions not clearly explained, or if difficulties occur, we are always ready to answer questions.

HEATING A GREENHOUSE (*W. Brooke*).—We are sorry for your disappointment, and more especially as with your furnace and tank and flue you have gone to nearly as much expense for your house 18 feet long and 6 wide as would have done for one six times the size. Now as to the difficulties about the tank. The running over of the water is owing to your tank being so small, and too much water in it so as not to permit of the expansion. If 4 inches deep we would advise you not having more than from $\frac{1}{2}$ to 3 inches of water, and that will allow room for expansion. We suspect that now, after running over and steaming, the water when cool stands low in the tank. As to the steaming, you cannot prevent that, more or less, if you make the water very hot, unless you have a fixed top. You speak of iron plate, and either that or slate three-eighths of an inch thick would answer very well. We see no necessity for your laths. Merely cover the top of your tank sides with red or white lead, and the sides of the iron or slate in the same way, and then screw them firmly together. You could leave a piece—say a foot—at the end, moveable for examining the water and taking a little hot when wanted—in general 3 inches will be enough. If you put 4 inches, however, secure the sides. Your tank is so small that with a good fire the pressure must throw up the top. After you reduce the water and make mild fires, you might try your present slates with a little fibre on them, and then 4 inches of sand. For cuttings it would be best to have moveable boxes, with glass tops, to set over this sand. If you wish more top heat you must have more of the slate covering free, and then, to prevent vapour, it would be as well if the top were water and vapour proof. If you still wanted more top heat you could increase the size of your tank. We think that a small flue brought from the other end along the front, and as now into the chimney, would have been ample for all you wanted; but as the boiler is there, it will be best to use it. We think that by the means referred to, you will have abundance of top heat; but if you wanted a great deal without altering the size of the tank, you might take the flue along the back of the house and return it to the chimney, and drain-tiles 6 or 8 inches in diameter would do for it. Let us know how you get on and if there is anything we can advise you on.

BACK NUMBER (*J. F. W.*).—No. 96 of our new series can be had by any one. Why not send four postage stamps direct to our office, for which you can have it postage free?

CAMELLIA LEAVES DISCOLOURED (*Jubilee Camellia*).—The leaves enclosed appear to us to have been destroyed by an unhealthy atmosphere. The evil may be caused by a very damp, cold, and close atmosphere, or by water standing on the leaves, or the same dripping from the roof upon them. An escape of foul air from the heating apparatus would also produce the same result, and a sour condition of the soil will, more or less, show itself in the foliage. Without further particulars we are unable to speak decidedly, and at the best can only say, see that the drainage is perfect, the soil neither too wet nor too dry, but thoroughly moist, and the atmosphere sweet by abundant ventilation in mild weather. Keep the foliage dry at this season, and let the temperature range from 40° to 45°.

HOLLYHOCKS NOT BLOOMING (*A. G. H.*).—From the height to which your Hollyhocks grow it is evident that they are planted in a very rich soil. They ought to be stopped long before they reach 12 and 15 feet in height. Stop them at 8 feet. The soil best suited for them is a deep, dry, rich soil. Their being left in the ground all winter should not prevent them flowering. Your plants evidently do not require any guano or liquid manure. Try how stopping them will succeed in making the flowers open.

NATIVE PRIMULAS.—Can any of our readers supply a few fine and healthy plants of *Primula farinosa*, *scotica*, *nivalis*, and *marginata*? If they can, let them communicate with *H. Harpur Crewe, Esq., Mickleover, Derby*.

HEATING A PROPAGATING-PIT (*J. W. Y.*).—We presume you have satisfied yourself as to the heating of the water. We would advise you being satisfied with 3 or 4 inches of water instead of 6. You will heat it more efficiently if an inch pipe from the gas-burner is carried through it. Your simplest plan, after your proposed wooden supports for the top, would be to place securely on them a plate or covering of galvanised iron, and on that put 4 or 5 inches of sand for placing the pots in, or plunging them shallow or deep, according as you want or obtain much or little bottom heat. Perhaps the best thing, after all, would be small charcoal, either by itself or mixed with the sand. The dry or moist state of the plunging medium would give you dry or moist heat as wanted, and you might divide your frame into separate pieces to secure that object. No doubt you will find a frame out of doors very useful for the purpose contemplated; but such a box, if of a suitable size, placed near a window in a room not much occupied, and with a good aspect, would be found more useful still and yield a greater amount of pleasure, as you could examine your cuttings, &c., at all times.

VARIOUS (*Darford Reader*).—The *Sphaerostema* will do well in peat and loam in equal proportions, with a little sand, and well-drained pots. It requires stove heat. We cannot make out which *Puya* you mean. *Payas* are chiefly from South America, and therefore require a warm stove. You may introduce British Queen Strawberries now, but do not force them much. If you have any more easily forcing sort, leave out the Queens for a month yet.

GERANIUM ARGENTUM IN A POT (*A Constant Reader*).—It will flower very well in a large pot or tubs, well fed as you propose. Pot it in March. Large plants in full flower can be lifted in autumn, and are very picturesque objects in a conservatory, where it lasts in flower all winter.

PLANTING VINES IN A GREENHOUSE (*Alpha*).—It is not too late to plant the Vines—quite the reverse: April or early in May will be time enough. Your arrangement will answer perfectly well, and the inside border, though narrow, is sufficient to grow strong Vines this year; and by letting them out through the brickwork next year to fresh soil they will do well. Keep the outside border lower than the inside one; roots have, especially in so small a space, always a tendency downwards; and it insures the roots against growing out too deep when the outside border is lower than the inside one. Keep it a foot lower. For the warm corner plant a Vine of Tynninghame Muscat; but be sure you get that sort true. You could easily have Grapes this year by getting strong fruiting Vines, and planting them without shaking the roots out of the soil; but, looking at the Vines as permanent objects, we strongly advise you against fruiting them this year. Shake them entirely out at planting time, and they will grow much better than if planted with a matted ball; and, in such an arrangement, you need not buy expensive fruiting plants. Your arrangement will do very well.

ANNUALS WITH SAPONARIA CALABRICA (*Igoramus*).—There is hardly any plant of the same habit as *S. calabrica*, and you say nothing about how you wish to arrange them. The following we consider suitable:—*Saponaria calabrica alba*, *Lobelia speciosa*, or *Paxtoniana*, *Saxifraga procumbens*, *Silene pendula*, *Fenzlia dianthiflora*, *Myosotis palustris* or *azonica*.

AMMONIACAL WATER FOR KILLING WORMS ON LAWNS (*A Subscriber*).—One gallon of the water as it generally comes from the gasworks to three gallons of water will be as strong as your grass will stand it. There is nothing that we know of so safe and effective for the destruction of green fly as tobacco-smoking, in the way in which it is usually done. For such a purpose we cannot advise you to resort to ammonia instead of tobacco. The latter, if repeatedly applied, keeps thrips in check and destroys it too. That ammonia is not only favourable to vegetation and destructive to insect life is certain; but its application requires great care, especially when the foliage and shoots of plants are tender. Ammonia is so exceedingly volatile that it is not necessary to be at much trouble to disengage it. The difficulty is all the other way—to fix it. You have only to apply heat to it, or strew a little guano on the border or floor of a lathouse and you will soon discover ammonia in the air. No doubt corrosive sublimate will kill worms or anything else; but we would never recommend its use while so much safer and certain an application as clear lime water will equally effect the same end. In all cases we would advise against the use of strong poisons while the end can be gained by simpler means. Corrosive sublimate is too violent a poison to bring much into use among tender plants where lime answers the same end without the slightest danger.

CAROLINA SUPERBA STRAWBERRY CULTURE (*J. W. F. K.*).—The clayey soil you name is very suitable for the growth of the strawberry, but the *Carolina superba* is rather a delicate variety, and requires careful cultivation to have it in perfection. Regarding the imperfect ripening of the fruit, that is not uncommon in this variety, for, under ordinary circumstances, the fruit generally comes green at the point. We should advise a deeply-trenched piece of rich soil that had been well manured the previous season. Plant in beds 4 feet wide, and allow the runners to fill the beds moderately thick. Do not disturb the beds afterwards while they remain in a good condition, but merely clean the plants in the spring, and top-dress them with cow-manure. Tie-up the fruit-stems to small sticks as soon as the fruit is set, which will greatly promote the colouring and ripening of the fruit.

NAMES OF FRUITS (*T. G. H.*).—1, *ReINETTE du Canada*; 2, *Winter Greening* or *French Crab*; 3, *Norfolk Bocking*; 4, *Cox's Orange Pippin*.

POULTRY, BEE, and HOUSEHOLD CHRONICLE.

POULTRY AND REFINEMENT;

OR, A VISIT TO A LADY POULTRY-FANCIER.

POULTRY and refinement! I fancy I hear some stray reader of this part of the Journal (perhaps one who takes it in for the flower intelligence only) exclaim—"What possible connection can these two words, 'Poultry and Refinement,' have with each other? Flowers and refinement I can understand, but poultry and refinement! Well, indeed, I wonder what next!"

Or, suppose a mere chance eye (eye to be caught and held, good friend), glances at these pages, and sees the two words at the head of this article, the eye of one who knows nothing of the love of poultry—one of the uninitiated, who only regards fowls as mere cocks and hens, or, perhaps, an absolute hater of poultry—such a one, not very good in his orthography, I heard exclaim, "Ah! fowl, a nasty bird that will eat any dirt. I believe the word 'fowl' was given because it is such a foul creature." Now, such persons would, doubtless, laugh the laugh of incredulity at the words "Poultry and Refinement."

Wait awhile, please, until I have proved my case. But, first, I am free to confess that a very great number of persons in the world (so much the worse for them and it) do consider poultry a mere affair of cocks and hens, with some comfortable palatable thoughts of poached eggs and roast chickens. As to the keepers of poultry, such people imagine to themselves stout farmers' wives, themselves stout, shouting with provincial accent to equally stout maids-of-all-work, "Now, gals, have you sarved they troop of chickens?" and, then they see, in thought, a motley lot of long-legged fowls running and flying to the words "Chick, chick, chick," or here, in Wiltshire, "Coop, coop, coop."

These, I am aware, are barbarous ideas, which may well send a quiver of horror through the Bingley Hall enthusiasts; and, indeed, I apologise most humbly to my poultry peers for unnerving them, but I believe they are true nevertheless. However, let us hasten to something better.

One glorious day last summer I found myself, by special invitation, on the road to a lady poultry-fancier's residence a few miles from "the Queen of the West"—the fair city of Bath. Every one who has once been in Bath can never forget its beauties; no city or town in England, I venture to say, can be compared to it. But it has another advantage, in my eyes at least—viz., that the villages around it are for the most part thoroughly primitive villages, not, as is too often the case with villages lying near a large town, mere inferior imitators of their great neighbour, abounding often with shabby terraces, and, like humble people who ape their betters, only succeeding in making themselves look ridiculous. Give me the thorough English village untownised (to coin a word), and, if possible, owned by large proprietors, who are not so hard-up or destitute of taste as to cut off all the lower branches, ay! and sometimes the higher-up branches, too, of the trees, leaving mere long poles with a wisp of leaves at the top. These wretched trees look like nothing so much as huge besoms stuck on end for the first giant that passes by to take in hand and march off with on his shoulder. Indeed, I would venture, by the appearance of the trees, to decide at a glance in passing through it whether a country belongs to large proprietors, or small and poor ones. I was led to these thoughts by the pleasure it gave me to see as I neared this village just the contrary to all this. A noble park stretched to the right, another to the left, while elder and oak branches crossed the road I was travelling by, forming Nature's gothic arches. A tug up this hill, a quick trot on, and I am in the village, with its true village (not town) street, with cottages here and there lying farther back still and peeping at us through their "nooks of leaves." There, before me, stood a true ivy-mantled church tower; there, to the left of me, the village school—yes, and a troop of noisy girls and boys (God bless them every one), just burst out of school (it was twelve o'clock), for a good game of play. The house I sought, itself rose-and-evergreen-covered, lay near. I knew it was the right house; for, as the carriage entered the great gates, I caught a glimpse of a large pigeon-dwelling occupying half the courtyard, wood-roofed, and galvanised-iron-wired at the sides, and I beheld a Dorking cock and his ladies heavily walking about, as prize Dorkings are wont, an exhibition in themselves.

But now, before you enter the house with me, good, I also hope, in many cases, fair reader, let me tell the especial reason which formed the attraction in my visit. The lady owner, a well-known poultry-fancier and successful exhibitor, had, I understood, been many years an invalid. One chief cause of this was a want of constant employment—of a daily object in life. "Every one needs an occupation," said Sir Charles Napier, the conqueror of Scinde; "a garden will do, but better still if it has a hayfield next to it. I was never

so happy, no, not when a great man in India, as I was that summer in England when getting in my hay." Man, ay, and woman too, does needs an occupation. As a shrewd doctor said to an idle man, full of imaginary complaints, "Go home, sir, and earn a shilling a-day, and live on it." And here was a lady, who, lacking constant occupation, was an invalid; but twelve years ago she became a poultry-fancier, and, of course, became also absorbed in the pursuit, making a business of it, and she has now perfectly recovered her health. Let no cynic say, "Were there no poor to visit? no children to take an interest in?" There were, and they were visited, and more, entertained summer and winter at pretty out-door and in-door *fêtes* according to the season. But an active lady, let her be ever so active among the poor, if living in a small village, cannot have her time fully occupied. But a truce to argument, let us enter the hospitable door. On the drawing-room table lay, amidst photographic albums and pretty books, the last Number of THE JOURNAL OF HORTICULTURE. A talk on its contents broke the ice of strangership; then, "Had I seen such and such a work on poultry?" "No." Then "Would I like to have a look at it?" "Certainly." A little time alone, and the cooing in the courtyard was too attractive to let an old Pigeon-fancier sit still, so I followed the sound, and was busy deciding, to my own satisfaction at least, the respective merits of a group of Fantails, when the dinner-bell rang. The welcome meal dispatched, and then a stroll through the garden, on a wide long lawn sloping away from the house and village, with a view of the well-wooded park on the opposite hill, while a river and railway ran along the dividing valley. "What! Dorking chicks in a flower garden! My dear friend, how do you manage?" "But, WILTSHIRE RECTOR," do you not see that my beds are few and large? and see the galvanised wire surrounding them." "True, and you have similarly fenced-in your borders too." "Yes, and so no harm to my flowers; and the standard roses are high, so that the flowers may be gathered readily." I must say the garden looked little the worse for its live stock or its wire-enclosing. "Oh! so you have Black Ducks in the garden too!" "Yes, and I was so vexed lately; for, having parted with my regular poultry woman, I left those Ducks, which I wished to be very small, in charge of a new woman, and I told her not to overfeed them. She, mistaking my order, fed them constantly; and when I returned home met me with a smiling face and 'Please, ma'am, I have fed the Ducks up well, and they are grown uncommon, and will be just fit for the pens.' Fancy my vexation!"

A turn to the left brought us into the afore-twice-mentioned courtyard and to the Pigeons. The building containing these birds was divided into compartments each with its door, and afar, near the wall, its warm nest-boxes; then a space in each for exercise, with perches, round centre stone table, and bath. One department contained Turbits, another Nuns, another some of the best Fantails in Somersetshire, thriving little Dorsetshire into the bargain; another Jacobins, and so on.

In a vacant space in the courtyard stood a glazed little building, or rather a large-sized chicken-coop, for rearing very early chickens on, I believe, Mrs. Fergusson Blair's plan. Then, it being now late in the afternoon, some Cochins were parading for their half-day's exercise, the Dorkings having been shut up. We next crossed a road, came to another garden, poultry-yard, and paddock. Here we found a large flock of prize Turkeys, monstrous fellows; I should not like to be the servant to carry such to table. Here, also, were some Game Bantams. I had not seen all, but was conducted up the village, then down a little lane, which brought us to a pet of an old cottage, with its garden in front and backyard, half-yard half-pasture. This was the walk for the Dorking and Cochin pullets. By-the-by, was not this a nice way of putting a little money into the hands of a thrifty, careful, trusty cottage wife? Surely it was. Back again through the village, taking a peep into the church, recently and handsomely restored; then a stroll round the churchyard, in which were the monuments of the deceased members of the family who had owned the manor for many generations, and whose present head sits in Parliament, and back again to the house of my hostess. On our way we met the tidy little maiden, who is on the trot all day with food for the different birds—these fed (for Miss — breeds for

weight rather than feather) at one time, those at another, and so on. Here was an occupation for a deserving girl out of a large and poor family.

The evening came on, a cup of tea, and then, as the best pleasures are seemingly most shortlived, away Bath-wards. But not away until warm thanks for kind hospitality received, and another invitation were given; then, indeed, farewell to my good entertainer and her pets, and her pretty village. And I said to myself, "Is there no other lady in England, now an invalid, who might not profit in body and mind by becoming a poultry-fancier?" and on I went, repeating the words of Rogers—

"This day
Shall hence be called a *white* day in my life."

Now, stray reader, chance peruser, I ask in triumph after reading this true narrative, Can you not understand the connection between POULTRY AND REFINEMENT?—WILTSHIRE RECTOR.

JUDGING POULTRY.

THERE has been much said and written of late on judging in private or public. Of course, we are interested in that as on all poultry matters. Placed in whatever light it may be, we object to the presence of any of the public, or of any one not necessarily present in discharging duty while the Judges are performing theirs. It was said years ago, that the halcyon time for Judges would be when every man was capable of filling that office, and of necessity would, when an exhibitor, acquiesce in decisions that were plain to him. But reasonable as that may seem, it is expecting too much of human nature. The spectator and the defeated exhibitor standing side by side and looking at the same pen are very different men. One views it calmly, and looking at the class approves the decision, qualifying his opinion by saying he is not a judge. The other says, "*He is a judge,*" and proceeds to canvass and impugn the decision that has been unfavourable to him. It is unquestionable that disappointment is at the bottom of the dissatisfaction. Ownership is as blind as love. It sees faults thirty leagues off, it views merits through a microscope. "If you are weak in evidence, abuse the plaintiff," were the instructions given to the defendant's counsel. "If my birds are not perfect," says an exhibitor, "all the others are worse." Judges are not perfect. We never impugn their honesty; and unless proof can be brought to justify an open accusation, an innuendo is an unmanly slander. Nothing that is criminal or dishonest should be concealed or sheltered for any reason or under any pretence. But the best-intentioned Judges are not always competent, and the most competent will sometimes make a mistake. Both these occasions much unkind comment. The birds that were so highly spoken of, and won so easily at Fudley-cum-Pipes, were not even commended at Eatanswill; yet the same Judge, or Judges, officiated at both. The competition is not, however, spoken of. Very often the previous triumph has much to do with the subsequent defeat. The freshness and bright condition are strong points in favour of the new antagonists. Many of our readers will be familiar with a quotation,

"Here lies Bombastes, stout of heart and limb,
Who conquered all but Fushos; Fushos him."

And so even with the best birds. There will be a time when they must succumb to younger ones; and there will be periods of fatigue in their career when they will be beaten from sheer exhaustion. Judging is not easy under the circumstances, nor is the office sought after or coveted by those most competent to exercise it. How much, however, would its difficulties be increased if its duties were to be discharged in the presence of the public! If now at places where every possible precaution is taken, some exhibitors spare neither time nor trouble to find a peg to hang a charge upon, what would be done when the presence of the public in the immediate neighbourhood of the Judges enabled people to say they saw the successful exhibitor speaking to or making signs to one of the Judges? We agree with Puff, it is a feature where a man like Lord Burleigh comes forward and shakes his head, and it is impossible to estimate the importance of a nod or a wink to a Judge at the critical moment. It may mean "How d'ye do?" or it may be an answer to a look of inquiry as to the ownership of a pen.

The long discussion there has been as to the admittance of the public at Birmingham has led us to make inquiry of the strictest nature into the fact. We are enabled to state positively:—*There was no admission to the poultry while the Judges were on the premises, and they did not leave till all their duties were over.*

This does not alter our opinion that the admission of the public under any circumstances is a mistake.

PRIVATE MARKINGS OF EXHIBITION GAME FOWLS.

WHEN public attention has recently been so strongly directed to the markings of Game fowls, kept expressly for exhibition, a few observations on the subject may not, at least by a portion of your poultry readers, be deemed ill-timed.

I am fully aware, by my own experience, that to object at all to this practice causes very irksome feelings to those persons who make it an invariable rule to mark all their Game fowls, and that this objection, from one who like myself has so frequently officiated as a poultry Judge, only makes any such remonstrances even the more unpalatable.

When, several years back, I publicly advised the discontinuance of this practice, as laying the foundation of continuous disputes so far as poultry exhibitions alone were concerned, I at once received a large number of letters from various breeders, stating their private marks on Game cocks it was impossible to dispense with, and assigning as the reason, "when Game cocks' feathers had been trimmed for fighting, if two such birds, after a long battle, happened to be both of the same variety, the "cockers" who fought them, would—if the slightest possibility of such a chance arose—each lay claim to the living cock, and deny the identity and consequently the ownership of "the dead one." I do not dispute the cogency of this argument, or want of honour as to the "pit;" but I withhold any concurrence whatever of my own, when applied exclusively to the exhibition of Game cocks. In the latter case, "private" marks, as they are sometimes called, soon become sufficiently public to arrest attention; and to invoke the strongest after-remarks in too many cases, among those exhibitors whose misfortune it then is to be disappointed of obtaining prizes. It certainly is not my desire to inveigh at all against marking Game cocks for the cock-pit; but I cannot, therefore, concede that the more peaceable recreation of simply exhibiting such fowls, is to be laid open to the most unjust suspicions in support of practices the law itself declares illegal and punishable, and which, however fondly looked for, is not, as yet, nearly suppressed.

Again: if marked only, as some say, to prevent theft, or to aid the recovery of such birds if stolen; surely it will not be denied, as out-of-the-way, in fairness to all amateurs, that Dorkings, Spanish, in fact, every variety, should possess a similar advantage. I well know the public feeling of our poultry exhibitors is, almost invariably, strongly opposed to such an interference as to marking other breeds of fowls, so as to render them recognisable when in the show-pen. Why, then, this exclusive privilege to the Game cock?

By a timely provision, just now, it could be easily so arranged, that Game cocks at a future fixed time should not be available for competition as show birds, when openly marked, as we so frequently see them at exhibitions. This would be no infraction of the rules of those persons whose tastes incline to cock-fighting; and I am assured it would render our poultry shows, in reference to the Game classes, of an infinitely more satisfactory character than now appears to be the order of the day.

My own opinions thus openly expressed, with all due deference to those of others, have been more forcibly than ever urged upon me by a paragraph in your valued Journal of the 19th inst., from the pen of an entire stranger to myself, a Mr. Williams; and although determined not to enter into the disagreements of the Messrs. Hindson and Williams, I feel I cannot let it justly pass unnoticed. Mr. Williams writes, "The private mark so much spoken of is not Mr. Hindson's." The matter to be regretted, both for the sake of the best interests of the Birmingham Show and also the parties themselves, appears to me rather that these

fowls were marked at all. Mr. Williams proceeds to say, "There were other fowls at Birmingham similarly "marked, and one a winner." This is a mistake, if the rather vague expression "similarly marked" really is intended to convey the meaning commonly supposed. At the request of a large number of exhibitors long prior to the cards of "disqualification" being put up, I rigidly examined every Game cock throughout the Exhibition, and a second time by gaslight. The fact was this: Many, very many, were "similarly marked," so far as marking the nostril only, but none with the same formed cuts as those in the three disqualified pens; but those three cocks were marked all alike.

No amateur regrets more sincerely than myself that any break of good feeling to the injury of poultry shows should arise; and it is quite foreign to my purpose to enter into any discussion of whose marks those alluded to might be. I only maintain what I feel to be the error—that such marks should have been in a show-pen at all; and I trust the day is not far distant when visibly marked Game cocks will be discarded from competition altogether.—EDWARD HEWITT, *Eden Cottage, Sparkbrook, Birmingham.*

JEDBURGH EXHIBITION OF POULTRY.

THE Jedburgh Exhibition of poultry ranks among the oldest of the Scottish shows. This year the entries of poultry alone amounted to 398 pens; of Pigeons there were 119 entries; and of Canaries and other small birds, about 70 pens. This extensive entry was of course a great element in the making up of a very good show; and we need scarcely add, the competition was far greater in the classes generally, than has ever been met with in Scotland at any previous show held within that portion of the United Kingdom.

The Show was well managed, and the fowls were carefully attended to; but if the awards could be entered upon at an earlier hour of the day it would be a decided improvement. We are told, however, that the arrival of the trains prohibits so doing. The Jedburgh Corn Exchange is a building very well fitted for the reception of some five or six hundred pens, and the plans of the Committee proved they had carefully arranged their Exhibition so as to make the best display possible.

Spanish were good, and the silver cup was obtained by Mr. Rodbard, with a pen of birds fully upholding the world-wide credit of that gentleman's strain. In Spanish chickens the second prize fell to the lot of the same yard. Mr. Cannan's first-prize Spanish chickens were a very superior lot, and even the third-prizes in these classes were far better than ordinary. In the *Dorking* classes, somewhat unexpectedly, the Silver Greys were most numerous and of especial excellence, so much so as far to exceed the late shows of even Manchester in this particular breed, although at the latter exhibition a special set of prizes were given the Silver Greys, in classes exclusively devoted to them. It is open to serious question whether so many really first-rate Silver Grey Dorkings were ever before present at any single poultry exhibition. Besides being able to maintain their position in mixed classes (for colour), these birds both in size and purity of feather obtained a rather extensive mastery on the prize list. They appear to be general favourites in this locality, and most deservedly so. In *Cochins*, Mr. Shorthose, of Newcastle-on-Tyne, held the sway, so far as to secure not less than three first prizes for birds of this variety. Some very good birds belonging to local amateurs were also prizetakers. In *Game* the competition was necessarily most severe, when we state the fact that Messrs. Adams, Billing, Boys, Fletcher, Julian, and several others of our most noted Game-breeders were the rivals. Strange to say, Mr. Smith, the well-known Turkey-breeder, of Breder Hills, Grantham, took the silver cup for Game fowls with an admirable pen of Brown Reds, amidst the hottest competition. Each of the other named individuals were also winners; wonderfully good pens could alone take even a remote chance of winning. The Game fowls were quite a leading feature of the Show, whilst not a few Scottish amateurs were evidently puzzled at the marvellous condition of most of the English specimens, and the perfection in which the Game fowls were placed before the public. In this always-important respect we do not doubt our Scotch friends will, in

a few years hence, strive to enter the lists evenhanded. The Spangled varieties of *Hamburghs* were decidedly superior to the Pencilled ones, the former breeds of either colours being unusually first-rate. The *Game Bantams* were a good class, but all three prizes were secured by Black Reds, the other varieties of feather being badly shown. In the Bantams for "Any other variety except Game," the Blacks stood highest, though a better collection of Silver-laced Sebrights are very rarely seen than those exhibited. This leads to a brief mention of a "Sweepstakes for single Bantam cocks," bringing out more than forty entries. Here a splendid Silver Grey Game Bantam of Mr. Shorthose's, of Newcastle-on-Tyne, easily won first place, while second and third prizes were both taken by Silver Sebrights. We can scarcely call to mind so good an entry in a Bantam cock sweepstakes at any previous show we have yet visited.

Both the *Turkeys*, *Geese*, and *Ducks*, were of a highly superior character to those seen at most local shows. Mr. Smith's Cambridge Turkeys were admirable, and were universally noticed. The Geese were not less praiseworthy, and here Lord Binning exhibited a pen of Toulouse Geese, the first prize weighing upwards of 50 lbs. the couple. By a strange coincidence, all six pens that composed the class for Geese were Grey ones; and not a pen otherwise than superior could be selected. The White Aylesbury Ducks, and the Rouens, were both very capital classes.

We must briefly draw attention to Mr. Harry Adams' Black Red Game cock, that was winner in competition with a host of Brown Reds in the single Game cock class. Such a bird is only very rarely seen; and the other two prizes fell to particularly good specimens of Brown Reds.

The *Pigeons* formed a good feature of the Show.

Among the *Canaries* were exhibited two male Linnets, entirely white. In both these birds was a strange peculiarity, when it is remembered they were perfect Albinos. Though the bills, feet, and legs, were wholly white, as we anticipated they would be—and not the slightest admixture of colour sullied the purity of their feathers—the eyes were entirely black. In every other entire sports to whiteness we have yet met with, the eyes were either red or pink.

The Committee carried out their rules of exclusion of all intruders altogether regardless of personality in every instance—a plan that always gives confidence, and increases public favour. This rule cannot become too general.

SPANISH.—Silver Cup, J. R. Rodbard, Aldwick Court, Wrington, near Bristol. Second, W. Bruce, St. Leonard's Bank, Perth. Third, J. Shorthose, Shieldfield Green, Newcastle-on-Tyne. Commended, Sir J. Don Wauchope, Bart., Edmonstone. Dalkeith; Mrs. Fraser, Hartree, Jedburgh. *Chickens*.—First, W. Cannan, Bradford. Second, J. R. Rodbard. Third, W. Meff. New Market, Aberdeen. Highly Commended, W. Sime, Orchard, Cambus; Miss B. Riepath, Causewayside, Edinburgh. Commended, T. Ogilvie, Jedburgh.

DORKING.—First, J. Curror, Comieston, Edinburgh (Silver). Second, Lord Binning, Mellerstain, Kelso. Third, J. Anderson, Ruthven House, Meikle (Silver Grey). Highly Commended, J. Dalrymple, Wester Langlee, Galashiels; Sir D. Baird, Bart., Newbyth, Prestonkirke; Sir J. Don Wauchope, Edmonstone; J. Macaulay, Edinburgh (Silver). Commended, W. Sime, Orchard, Cambus. *Chickens*.—First, Miss Milne, Otterburn, Kelso (Silver Grey). Second, J. Anderson (Silver Grey). Third, J. Jardine, Arkleton, Ewes, Dumfriesshire. Highly Commended, J. Steel, Kelso; J. Jardine, Commended, W. Sime; Sir D. Baird, Bart.; Sir J. Don Wauchope, Bart.; R. Kerss, Monteviot, Jedburgh; Lord Binning. *Pullets*.—First, J. Anderson (Silver). Second, W. Sime. Third, C. Peave, Darlington. Highly Commended, J. Jardine. Commended, T. L. Jackson, Bush of Ewes, Dumfriesshire; Miss Milne (Coloured).

COCHIN-CHINA.—First, J. Shorthose, Newcastle-on-Tyne. Second, C. A. Leckhart, West Bridge, Kirkcaldy. Third, E. Smith, Middleton, Manchester. Highly Commended and Commended, Miss E. A. Aglionby, Grasmere. *Chickens*.—First, J. Shorthose. Second, F. W. Earle, Edenhurst, Prescot. Third, Mrs. Kemp, Midcaldy, Edinburgh. Highly Commended, E. Smith; Commended, Mrs. Kemp.

BRAHMA POOTRA.—First, Miss Purves, Castlegate, Jedburgh. Second, R. Story, Jedburgh. Third, Mrs. H. Barclay, Kinross. Highly Commended, Mrs. H. Barclay; W. M. Painter, Jedburgh; J. Grey, jun., Greenlaw, Berwickshire. Commended, W. Murdoch, Bonnyrigg; Mrs. Pardon, Easter Woodon, Roxburghshire.

GAME (Black or Brown Reds).—First and Cup, J. Smith, Breder Hills, Grantham. Second, H. Adams, Beverley, Yorkshire. Third, J. Fletcher, Stoneclough, near Manchester. Highly Commended, H. M. Julian, Beverley, Yorkshire; A. Perkins, Darlington; H. Adams; M. Billing, jun., Gravelly Hill, Birmingham. Commended, J. Brough, Carlisle; J. Wood, Moat House, near Wigan; Miss J. A. Akroyd, Bradford; Lord Bincioy, Mellerstain; W. Boyes, Beverley, Yorkshire.

GAME (Duckwing).—First, M. Billing, jun., Gravelly Hill, Birmingham. Second, T. J. Charlton, Mananingham, Bradford. Third, H. Snowden, Great Horton, Bradford.

GAME (Any other variety).—First, M. Billing, jun., Birmingham. Second, H. Adams, Beverley (Pie). Third, J. Brough, Carlisle (Black). *Chickens*. First, M. J. A. Akroyd, Bradford. Second, H. Adams (Red). Third, J. Anderson, Meikle. Highly Commended, J. Clemens, Darlington (Brown Red). Commended, H. Welsh, Edinburgh (Black Red); J. Wood, Moat

House, near Wigan; H. Snowden, Great Horton, Bradford; H. M. Julian, Beverley (Red); A. Perkins, Darlington (Brunn Red); M. Billing, jun.

HAMBURGH (Silver-spangled).—Silver Cup, H. Beldon, Gilstead, Bingley, Yorkshire. Second, F. L. Roy, Nenthorn. Third, Mrs. Fraser, Hartrigg, Jedburgh. Commended, Miss Purves, Castlegate, Jedburgh.

HAMBURGH (Silver-pencilled).—First, H. Beldon, Gilstead, Bingley. Second, Miss E. A. Aglionby, Grassmere. Third, Miss H. Scott, Ancrum House.

HAMBURGH (Golden-spangled).—First, W. Cheyne, Selkirk. Second, H. Beldon, Gilstead, Bingley. Third, C. Anderson, Nenthorn, Kelso.

HAMBURGH (Golden-pencilled).—First, W. Mcff, New Market, Aberdeen. Second, S. Smith, Northoram, Halifax. Third, Miss E. E. Wallace, Aberdeen. Commended, J. M'Innes, Paisley.

BANTAMS (Game).—First, R. M. Stark, Hull. Second, Messrs. G. T. Allan and J. Johnston, Deptford, Sunderland. Third, W. J. Routledge, Aberdeen. Highly Commended, E. Brown, Sheffield. Commended, J. Stainsby, Sunderland; J. Anderson, Meikle; W. Mabon, jun., Castlegate, Jedburgh; C. W. Brierley, Middleton, Manchester.

BANTAMS (Any variety).—First, R. M. Stark, Hull (Black). Second, J. Anderson, Meikle (Silver-laced). Third, F. L. Roy, Nenthorn, Kelso (Silver-laced). Highly Commended, K. M. Stark (Silver-laced); C. A. Lockhart, Kirkcaldy (Sebrights). Commended, F. L. Roy (Gold-laced).

GEES (Grey and Mottled or White).—First, Lord Binning, Mellerstain. Second, T. E. Boog, Tythehouse, Roxburghshire. Third, Mrs. Bell, Marcheleugh, Roxburghshire. Highly Commended, S. Swan, Bush, Roxburghshire; C. Pease, Darlington.

DUCKS (White Aylesbury).—First, Miss W. Ogilvy, Meikle. Second, R. M. Stark, Hull. Third, S. Swan, Bush. Highly Commended, Miss H. Scott, Ancrum House; J. A. S. E. Fair, Gilliestongue, Lord Binning, Mellerstain. Commended, A. O. Swan, Bush; J. James, Samieston.

DUCKS (Rouen).—First and Third, Mrs. Elliot, Hynhope. Second, Miss Purves, Jedburgh. Highly Commended, J. Anderson, Meikle; J. S. Dudgeon, Spylaw. Commended, T. E. Boog, Tythehouse; G. Douglas, Hynhope; C. Pease, Darlington.

DUCKS (Any other variety).—First, W. Sime, Orchard, Camhus. Second, Miss Purves, Jedburgh (Mallards). Third, R. M. Stark, Hull. Commended, F. W. Earle, Prescott (Black East Indian); J. R. Jessop, Hull (East Indian).

TURKEYS.—First and Second, J. Smith, Breeder Hills, Grantburn. Third, J. James, Samieston. *Poults*.—First, J. Smith. Third, C. Pease, Darlington. Second withheld.

ANY OTHER VARIETY OF POULTRY.—First and Third, J. A. S. E. Fair, Gilliestongue (White Dorking). Second, R. M. Stark, Hull (Black Poland). Commended, H. Beldon, Gilstead, Bingley (Polands).

SINGLE COCKS.

SPANISH.—First, H. Beldon, Gilstead, Bingley. Second, T. Ogilvie, Jedburgh. Third, S. Corner, Fulwell, Monkwearmouth. Commended, J. Shorthose, Newcastle-on-Tyne.

DORKING.—First, Countess de Flahault, Tullyellan Castle. Second, Mrs. Elliot, Hynhope. Third, Miss H. Scott, Ancrum House. Highly Commended, J. A. S. E. Fair, Gilliestongue.

COCHIN-CHINA.—First, J. Shorthose, Newcastle-on-Tyne. Second, Miss Milne, Oterburn, Kelso. Third, R. Charters, Kalemouth. Highly Commended, Mrs. Dickens, Kelso; J. Shorthose. Commended, E. Smith.

GAME.—First, H. Adams, Beverley. Second, W. Boyes, Beverley. Third, J. Anderson, Meikle. Highly Commended, W. Eiston, Jedburgh; G. W. Binns, Darlington; G. C. Whitwell, Kendal; H. Adams, Commended, W. Eiston; A. Perkins, Darlington; M. Billing, jun., Gravelly Hill, Birmingham; J. A. S. E. Fair, Gilliestongue.

HAMBURGH.—First, Miss Purves, Jedburgh. Second, H. Beldon, Gilstead, Bingley. Third, J. U. Somner, Jedburgh.

TURKEY.—First, C. Pease, Darlington. Second, J. James, Samieston. Third, Lord Binning, Mellerstain.

SWEETSTAKES FOR BANTAMS.—First, J. Shorthose, Newcastle-on-Tyne. Second, C. W. Brierley, Middleton. Third, J. Anderson, Meikle. Highly Commended, W. Oliver, Jedburgh; F. L. Roy, Nenthorn. Commended, A. Hunter, Burnwynd, Jedburgh; R. Cleaver, Melrose.

SELLING CLASS.

ANY AGE OR VARIETY.—First, J. Shorthose, Newcastle-on-Tyne (Spanish). Second, J. Barton, jun., Jedburgh (Black Red Game). Third, F. L. Roy, Nenthorn, Kelso (Silver-spangled). Highly Commended, J. A. S. E. Fair, Gilliestongue, Roxburghshire (Aylesbury Duck); H. M. Julian, Beverley, Yorkshire (Game); Mrs. H. Barclay, Kinross (Dorkings); J. S. Dudgeon, Spylaw, Kelso (Dorkings); W. Gray, Darlington (Partridge Cochinchina); E. Smith, Middleton (Cochin-China); J. Henry, Mountviot, Jedburgh (Spanish). Commended, G. J. Harvey, Jedburgh (Black Red Game Bantams); Miss J. A. Aykrold, Bradford, Yorkshire (Game); G. Ritchie, Selkirk (Silver-spangled Hamburgs); R. R. Tulip, Monkwearmouth (Golden-pencilled Hamburgs).

COTTAGERS' PRIZES.

ANY AGE.—First, R. Charters, Kalemouth (Cochin-China). Second, J. Scott, Ancrum (Manorkies). Third, D. Young, Canongate, Jedburgh (Brown Red). Highly Commended, A. Henderson, Dunlop, Jedburgh (Dorkings). Commended, W. Laidlaw, Sharplaw, Jedburgh (Black Red Game Bantams); J. Bell, Williescrook, Jedburgh (Spanish).

PIGEONS.

TUMBLERS (Almond).—Highly Commended, H. Yardley, Market Place, Birmingham.

TUMBLERS (Any other variety).—First, J. Bell, Newcastle-on-Tyne (Kites). Second, J. R. Jessop, Hull. Third, H. Yardley, Birmingham. Highly Commended, R. Pickering, Carlisle. Commended, H. Beldon, Gilstead, Bingley, Yorkshire.

FANTAILS.—First, Lord Binning, Mellerstain (White). Second, T. C. Taylor, Middleborough, Yorkshire. Third, H. Beldon, Yorkshire. Highly Commended, T. C. Taylor. Commended, J. R. Jessop; M. E. Jobling, Barras Bridge, Newcastle-on-Tyne.

POWTENS.—First and Third, M. Sanderson, Edinburgh (Blue and White). Second, E. Brown, Sheffield. Highly Commended, J. Luis, Edinburgh (Blue). Commended, H. Beldon.

NUCS.—First, F. Key, Beverley. Second, H. Beldon. Third, Lord Binning, Highly Commended, J. U. Somner, Jedburgh. Commended, A. Goodfellow, jun., Wildcatgate.

OWLS.—First, M. E. Jobling. Second, H. Yardley, Birmingham. Third, J. Bell, Newcastle-on-Tyne. Commended, M. E. Jobling.

TURBITS.—First and second, W. Veitch, jun., Jedburgh (Red and Blue).

Third, T. C. Taylor (Blue). Highly Commended, F. Key, Beverley. Commended, H. Beldon; J. Luis, Edinburgh (Red). (A splendid class).

JACOBS.—First and Third, T. Ellington, Woodmansey, Beverley. Second, W. Veitch, jun. Highly Commended, Lord Binning (White). Commended, J. R. Jessop, Hull.

ANY OTHER VARIETY.—First, R. Pickering, Carlisle (Carriers). Second, Miss Purves, 48, Castlegate (Black Barbs). Third, W. Veitch, jun., Jedburgh (Trumpeters). Highly Commended, Lord Binning (Blue Priests). Commended, H. Beldon; M. E. Jooling (Swallows and Magpies). (Extra fine class).

SELLING CLASS FOR PIGEONS.

ANY VARIETY.—First, F. Key, Beverley (Turbits). Second, J. Riddell, Kelso (Barbs). Third, J. R. Robinson, Sunderland (Yellow Turbits). Highly Commended, M. E. Jobling (Helmits). Commended, J. R. Jessop, Hull; Miss Collier, Jedburgh (Yellow Owls); J. Gray, jun., Greenlaw, Berwickshire (White Dragons).

CANARIES.

SCOTCH FANCY.—*Yellow Cock*.—First and Second, R. Ballantine, Hawick. Highly Commended, T. Hope, Jedburgh. Commended, M. Gray, Jedburgh. *Hen*.—First, W. Lewis, Selkirk. Second, J. Kemp, Galashiels. Highly Commended, R. Swanton, Jedburgh. *Buff Cock*.—First, R. Ballantine. Second, T. Stoddart, Selkirk. Highly Commended, G. Hollands, Jedburgh. Commended, J. Kemp, Galashiels. *Hen*.—First, W. Lewis, Selkirk. Second, R. Ballantine. Highly Commended, J. S. Smith, Galashiels. Commended, W. Eiston, Jedburgh; T. Hope, Jedburgh.

BELGIAN FANCY.—*Yellow Cock*.—First, J. Barton, jun., Jedburgh. Second, W. Miller, Selkirk. Highly Commended, J. Barton, jun. *Hen*.—First and Second, J. Barton, jun. Commended, J. Kemp, Galashiels. *Buff Cock*.—First, W. Miller. Second, G. Hollands, Jedburgh. Highly Commended, J. Kemp, Muddersfield, W. Miller. *Hen*.—First, J. Barton, jun. Second, J. Hardie, Huddersfield, Galashiels. Commended, J. Hall, Jedburgh.

FLECKED CANARIES.—*Yellow Cock*.—First, W. Cheyne, Selkirk. Second, Miss Collier, Jedburgh. Highly Commended, J. Kemp. Commended, W. Cheyne. *Hen*.—First, J. Kemp. Second, J. Hardie. Highly Commended, T. Stoddart, Selkirk. Commended, Miss Collier. *Buff Cock*.—First, J. W. A. Collier, Jedburgh. Second, J. Bannister, Galashiels. Highly Commended, T. Stoddart. Commended, J. Hardie, and W. Cheyne. *Hen*.—First, J. Hardie. Second, J. Cleghern, Galashiels. Commended, T. Hope, Jedburgh.

JUDGES.—For *Poultry*: Edward Hewitt, Esq., of Birmingham. For *Pigeons*: G. J. Maclean, Esq., of Edinburgh. For *Canaries*: Joseph Broomfield, Esq., of Edinburgh.

MR. WILLIAMS AND THE DISQUALIFIED GAME BIRDS AT BIRMINGHAM.

MR. WILLIAMS has made a statement which we are bound not to disbelieve, unless anything can be alleged against its truth. He does not, however, do himself justice. It is possible to tell the truth ambiguously. In his letter in your columns, and in his statement quoted from *The Field* sporting journal, Mr. Williams emphatically denies that the birds are, or ever were, Mr. Hindson's property; but he does not say they are his own. He says that Mr. Hindson had only seen one of the birds before they were exhibited at Birmingham, and that this bird was borrowed at Liverpool for exhibition some ten months since. Mr. Williams does not say from whom this bird was borrowed, nor that the bird was then, or at the time of the last Birmingham Show, his own. He says again, "The private mark so much spoken of is not Mr. Hindson's." He does not say that it is his own or whose it is. He says, further—"there were other fowls at Birmingham similarly marked, one a winner." He does not tell us whose fowls they were—to which pen, or to whom this winner belonged. Finally, he says, "EGOMET" may satisfy his pardonable curiosity as to me, my position, or residence; and he may at the same time, see some fowls that have never been exhibited, as good as anything I had at Birmingham, and I can show him, &c., &c. If he be the man he assumes to be, I should like to see him at my place."

I admire Mr. Williams for his pardonable pride in his birds, and I thank him for his friendly wish to show them to me; but his last sentences sound rather as a flourish of trumpets, which has nothing to do with the question before the public.

There is nothing to show that the birds disqualified at Birmingham were *bona fide* the property of Mr. Williams at that time.

There is nothing to show that the marks in question were not the private marks of Mr. Evan Pugh, who is described as of the neighbourhood of Welshpool.

There is nothing to show—as Mr. Evan Pugh did not exhibit, at all events in his own name—that the "other fowls at Birmingham, similarly marked, one a winner," were not hired or borrowed of Mr. Evan Pugh, by some unprincipled exhibitor.

I know nothing of Mr. Evan Pugh, except from Mr.

Hindson's letter, quoted by Mr. Williams. Doubtless he can clear himself from the former gentleman's insinuations.

Without doubt the obscure sentences and important omissions in Mr. Williams's statements are oversights of haste, and he will be glad to have the opportunity of making the one clear by supplying the other.—EGOMET.

MIDLAND COUNTIES EXHIBITION OF CANARIES

AND BRITISH AND FOREIGN CAGE BIRDS.

AN Exhibition of rare excellence took place at the Mechanics Hall, Derby, on the 15th and 16th inst.

The following are the awards:—

NORWICH (Clear Yellow).—First and Second, Mr. Walter. Highly Commended, Mr. Mackley. Commended, W. Williams.
NORWICH (Clear Buff).—First, Mr. Mackley. Second, Mr. Walter. Highly Commended, Mr. Walter. Commended, Mr. Williams.
NORWICH (Variegated or Marked).—First, Mr. Walter. Second, Mr. Williams. Highly Commended, Mr. Walter. Commended, Mr. Bishop.
BELGIAN (Clear Yellow).—First, Mr. Williams. Second, O. Nicholson. Highly Commended, G. Tuckwood. Commended, G. Corbett.
BELGIAN (Clear Buff).—First, Mr. Brown. Second, Mr. Williams. Highly Commended and Commended, J. Palmer.
BELGIAN (Variegated Yellow).—First, Mr. Williams. Second, G. Corbett. Highly Commended, J. Pool. Commended, J. Martin.
BELGIAN (Variegated Buff).—First, Mr. Williams. Second, W. Phillips. Highly Commended, J. Palmer. Commended, G. H. Goodwin.
CRESTED BELGIAN.—First, Mr. Williams. Second, Mr. Lingard. Highly Commended, Mr. Wilson. Commended, Mr. Wilson.
TICKED BELGIAN.—First, G. Corbett. Second, Mr. Widdowson. Highly Commended, J. Palmer. Commended, G. Corbett.
LIZARDS (Gold-spangled).—First, Mr. Williams. Second, Mr. Duxton. Highly Commended, B. Pointon. Commended, Mr. Williams.
LIZARDS (Silver-spangled).—First, Mr. Duxton. Second, Mr. Williams. Highly Commended, Mr. Phillips. Commended, Mr. Pointon.
GOLDFINCH MULES (Mealy).—First, J. T. Wilson. Second, W. Phillips. Highly Commended, G. J. Barnesby. Commended, E. Coke.
GOLDFINCH MULES (Jonque).—First, G. Crocker. Second, G. J. Barnesby. Highly Commended, Mr. Mackley. Commended, Mr. Walter.
MULES (Any other variety).—Prize, J. Lingard. Commended, T. Carrington.
BULLFINCH.—Prize, Mr. Mackley.
GOLDFINCH.—Prize, G. H. Goodwin. Highly Commended, Mr. Knibb, Mr. Walter.
LINNETH.—Prize, Mr. Walter. Highly Commended, Mr. Cockayne. Commended, Mr. Keys.
SKYLARK.—Prize, Mr. Walter. Highly Commended, Mr. Holmes.
BLACKBIRD.—Prize, H. Nicholson. Highly Commended, Mr. Williams. Commended, Mr. Holmes.
TURKISH.—Prize, W. Holmes. Highly Commended, E. Coke. Commended, J. Evans.
PARROTS (Grey).—Prize, Mrs. Orme. Highly Commended, Mrs. Williams.
STOVED BIRDS AND ANIMALS.—Prize, Sir J. H. Crewe. Commended, W. Bishop; J. Peach.
JUDGES.—Rev. H. Harpur Crewe, Drayton Rectory, near Tring; Mr. R. Pearson, Durham; Mr. Stapleton, Nottingham; Mr. J. Lord, Oldham.

PRIZES FOR BANTAMS.

I AM glad to see in your Journal of January 5th an article treating on the injustice done to the breeders of Bantams, and that in proof special attention is called to the last Show at Darlington. Such has long been the impression on my own mind, especially in reference to Game Bantams, of which I am a breeder in a small way. "Y. B. A. Z.," in giving the figures in the article alluded to, states that the number of entries for Bantams was 183, and that the prize money offered for the same was £8. Now, of the 83 entries 63 were Game Bantams, and all the inducement offered to exhibitors in those classes was two first prizes of 20s., and two second prizes of 10s. True, there was a silver cup, but any of the exhibitors of Black, White, or any coloured Bantams stood his chance of winning it. I think there should be a reformation in this apportionment, which I see prevails in many exhibitions; and that if the same rules which are applied to the larger classes cannot be applied to Bantams, so far as the showing according to age is concerned, some attention should at least be paid to the colour of the birds; and that there be separate prizes awarded to Black Reds and to Duckwings—a change which I see has been accomplished at the last Show at Heckmondwike. I am persuaded that almost any one would prefer to compete for a smaller prize, if such were necessary, or be willing to pay an increased entry, so that the number of prizes might be increased.—FAIR PLAY.

FOUL BROOD.

AFTER months of writing, at last we have Mr. Lowe's views on "Foul Brood," and his accusations against me are so serious, that I am compelled to ask for a small space in which to reply to him.

He says, "when he first read my article it seemed to him like a romance"—that is, a fiction, or, in plain English, it is all falsehood—"written in the light of certain experiments made by Mr. Woodbury as to foul brood." This is the first time to my knowledge in which I have ever been accused of stating untruths for the sake of advancing the opinion of any one, and I think those who know me will have a different opinion of my veracity than Mr. Lowe has, and I here again repeat that every word I wrote is truth. I saw the grubs, I might have said the larvæ; but they, the grubs, lived for two weeks, and at last came out of the cells, crawling about on the shelf till they died. I said nothing about the grub changing into the pupa, but that the grub or larva itself crawled out of the cells, at that stage, I suppose, when the bees would have sealed them up.

Mr. Lowe admits that, "the advanced pupa by a wonderful instinct, makes wonderful exertion to quit the cells and make towards the outside of the hive." In the case alluded to I saw them doing so—that is, the pupæ, and at the same time I saw the grubs or larvæ coming out of the cells. Let Mr. Lowe accuse me of romance, fiction, or falsehood, as he pleases, it will only be taken for what it is worth. I cannot help believing what I saw. Is he to ignore what others may have seen with their own eyes, when it is against his opinions, merely because he might not have had the opportunity of observing the same fact? It was by mere accident that I observed it; had the comb not been laid in theinery, but thrown away, I never should have seen it, but having seen it I assert it to be true.

Mr. Lowe then says (see page 48), that the five cases which I gave as "undoubted facts," "and as tending to show that foul brood is a disease, he does not consider, if rightly understood, would prove anything of the kind." In other words, Mr. Lowe considers that he is the only one who understands the subject.

He then objects to my having narrated what did not take place in my own apiary, but in that of a neighbour, "and that he has little faith in observations of this kind coming secondhand, and would infinitely prefer five minutes conversation with the Professor himself, as to his views and doings, to the most lengthened exposition by the hands of another."

While it was my neighbour's case I gave the details of, if it is any satisfaction to Mr. Lowe, I may inform him that I was an eye witness of nearly all that my neighbour did, or has done. I see his apiary almost every day in summer; I am as conversant with all he does to his bees as I am with my own; we do very little to any of the hives of either apiary without consulting each other; so that my evidence must be equal with Mr. Lowe's in so far as he gives that of his friend in Perthshire; and I am surprised that while he has "little faith" in secondhand evidence, he quotes that from a letter from a friend. Might not Mr. Lowe justly complain if I said that that letter was got up for the occasion, to help Mr. Lowe out of his difficulty, and, if possible strengthen his case?

I have no doubt Mr. Lowe is aware whom I mean by my neighbour the Professor; if not, he is the person who was introduced to Mr. Lowe, when he called at Yester to see the Ligurian bees which I had from Mr. Woodbury, when I was from home. He will remember, too, that the Professor showed him his own apiary, and at that time asked Mr. Lowe if he had seen or experienced anything of what he called "rotten hatch." Mr. Lowe at that time did not seem to have seen much of it, or else treated it very lightly, at the same time "he thought it was caused by a chill."

Now, I ask Mr. Lowe, if he considered either my apiary or that of my neighbour what he would call an experimental one? He would see that there was only one stock, the Ligurians, in my apiary, which was in a Woodbury-hive, and one in a Neighbour's hive; all the rest were in the common cottage straw hive, as were those of my neighbour also.

Since that time I may be called an experimentalist, if making artificial hives causes me to be so; but I deny that my neighbour is one. All that he has done has been to keep up a stock of six or eight hives, by cutting foul brood out of one, and adding bees to others, and such-like operations;

and during the period of ten years he has had two hives from me, and purchased four from others, to keep up a stock, otherwise he would have lost all; so that all his operations were to keep up his stock.

Mr. Lowe wishes to know the "Professor's own learned opinion during these ten long years, as to what he attributed these evils which so afflicted his bees." If Mr. Lowe would at any time pay us a visit, I am certain both my neighbour and myself would tell him all we know, much more than what I have written, to "his amanuensis," although it is secondhand; and I have little hope of Mr. Lowe believing me, when I tell him that my neighbour cannot account for the disease. He has no positive proof in any one case that it had been caused by chill; but he has overwhelming proof to the contrary. Had it taken place in one hive or two, and had it appeared one year and not the following, then he might have attributed it to chill; but when it took place in all his hives, less or more, and these two last seasons in young hives, swarms of the same year, he cannot imagine that they could all be chilled, when mine were free from the disease, though having the same treatment in every respect, and he does not hesitate to assert that mere excision of the affected parts will not make a cure. He has done so in numbers of cases, but the "foul brood" always reappeared.

The Professor's opinion about Mr. Lowe's experience of foul brood, has all along been that Mr. Lowe really never had experienced what it is, although his description of it is correct, and he often wanted me to send on a hive of his to Mr. Lowe, that he might see it, and try to cure it, for which he would be really thankful. Mr. Lowe is welcome to this witness whenever he wants him.

The case which Mr. Lowe seems to chuckle over, where my neighbour advised me not to put in the broken comb, as the brood might get "chilled," and so propagate the disease, was just this. Neither of us can say what is the cause, and when we saw such an authority as Mr. Lowe asserting so positively that chill was the cause, it would have been foolish to have run any risk with a hive we were particularly wishing to keep right, when it could be prevented by such simple means. It was really out of deference to Mr. Lowe's strong assertion, and giving him credit for more than we knew ourselves, that we acted as we did.

Mr. Lowe may rest assured that I am not "offended" at the observations he has made on my communication, seeing the contempt he has shown to others, who were entitled to more respect from the courteous manner they treat every inquirer in THE JOURNAL OF HORTICULTURE.

I hope I am as well aware as Mr. Lowe is of the importance of the "accuracy and knowledge of the observer, and that all secondhand information must be received for what it is worth." At the same time I must admit, that there are many who are as capable of observing in matters such as the present as either Mr. Lowe or I, and were we to object to all information but what had come by our own observation, how deficient we would be of knowledge on any subject whatever: in fact, knowledge would be at a standstill; and I have no right to doubt the veracity of my fellow man when he narrates, without seeming contradiction, his observations, merely because I had never noticed the same.

My neighbour still adheres to the statement made as to the weight of the hive which he was feeding; it was weighed when the bees were put in, and weighed again when they got 23 lbs. of honey and sugar. As the queen had deposited an egg in every cell in the eke which she was removed from, and the hive being full of empty comb, we could not come to any other conclusion than that it was brood. At the same time, the weather being fine, it is possible that she might have helped herself from some of her neighbours', although it was not observed.

Allow me to tell Mr. Lowe that his "witness," the "Professor," and I have been anxiously waiting to hear what experience he had with foul brood; and we are now rather surprised that after all the writing about what it is and what it is not, that he has only described one case of his own, and that occurring, strange to say, nearly at the end of the season. From his writings we were led to understand that he had abundance of experience on foul brood; but it now seems he had to wait till this case occurred, and, moreover, had to "sojourn in Perthshire" for his second.

After all, his own case to us is not quite clear. There is a possibility that disease may have been in the top before he put it on, and that Mr. Lowe may not observed it; and the circumstance of the bees not taking to it is some evidence towards the supposition. Moreover, we would like very well to hear what has taken place with the bottom part of the same hive. My neighbour asserts, from his experience, that if the under part remained unaffected with the disease it was not the disease at all that Mr. Lowe saw, and that he has still to learn what it is. Such is the evidence of the witness he claims, who is now beside me while I write his own words.—ALEX. SHEARER.

GREEN YEW NOT POISONOUS TO DEER.

In the severe winter of 1860 and 1861, some deer managed to get into the shrubbery here nearly every night, and cropped principally the yew bushes. Owing to some alterations going on in the shrubbery, it was fenced round with some high hurdles; but there was no keeping some old bucks out, for they jumped over the hurdles at night, and this went on for two or three weeks. These deer were marked by the park-keeper, who expected to see them poisoned, but there were no deaths amongst them, although he thought they looked thinner than the others that had not eaten the green yew branches. There is no doubt whatever, but that yew branches in a brown and withered state are a deadly poison to horses and cows that eat them. One farmer in this neighbourhood lately lost nine young cows from their eating some dried clippings of yew trees placed incautiously in their way. I likewise knew a case where some valuable carriage horses were poisoned in the same way. Whether the yew would poison cattle and horses when eaten in the green and growing state I am unable to say, but it certainly does not deer.—WILLIAM TILLERY, *Welbeck*.

Two three-year-old bullocks were killed by eating yew that had been cut down at Blair Castle, the seat of the Duke of Atholl, about forty-three years since. I send my address as a guarantee for the truth of the above.—A. S.

OUR LETTER BOX.

TRAINING GAME COCKS (*Cocker*).—Johnson's Sportsman's Dictionary will afford the information you require, but we do not know the price.

BREEDING DUCKS PROFITABLY (*J. N. R.*).—A large tub sunk in the ground is all that is necessary for Ducks in the way of water, but it should be at least 18 inches deep. We doubt whether they can be profitably kept where all the food has to be bought. Much that a Duck eats, and that helps in the formation of flesh, is absolute refuse, and found in the neighbourhood of ponds, ditches, &c., which do not exist in an amateur's poultry-yard. The Aylesbury Ducks are fed on very stimulating food, and in their early days those intended for 'great size are largely supplied with horseflesh, kept in-doors, and out of water.

HENS NOT LAYING IN WINTER (*A Constant Subscriber*).—The reason why your hens do not lay in the winter is because they are *hens*. Only pullets lay in the winter, and those only on condition that they attain a certain age during that season. Unless they are very old they should lay before April. We have never seen white Brahma Pouteras, and with all deference we do not wish to. We should be sorry to lose the pleasing contrast of the black hackle, flight, and tail on the white plumage. When these markings are correct they are, we think, amongst the prettiest fowls we have.

TURKEYS, &c. (*Miss Longbourne*).—Write to Mr. J. K. Fowler, Prebendal Farm, Aylesbury, for the information. Have a male bird from one yard and the hens from another yard. You will never have fine birds of any kind by breeding from closely-related birds.

JOHNSON'S MODERN DAIRY AND COW-KEEPING (*G. D., of H.*).—The publisher is Ridgway, Piccadilly. We do not know whether it is out of print.

FARROT PLUCKING OUT ITS FEATHERS (*A Three-years Subscriber*).—Do not give it meat or bones, or hempseed. Bread and milk, nuts, and other fruits are less inflammatory food, and do not cause that irritation which induces the bird to pluck out its feathers. Let it every day have a bath of tepid water—a soup plate makes a good one. If the bird will not go into it voluntarily, pour the water over the bird through the fine rose of a watering-pot.

LONDON MARKETS.—JANUARY 25.

POULTRY.

Unfavourable weather is not without its effect on the market. It makes trade dull, as buyers only purchase from hand to mouth.

	s.	d.	s.	d.		s.	d.	s.	d.
Large Fowls	3	0	3	6	Partridges	1	9	2	0
Smaller do.	2	3	2	6	Hares	2	6	3	0
Cheekens	1	6	1	9	Rabbits	1	4	1	5
Geese	6	0	6	6	Wild do.	0	8	0	9
Pheasants	3	0	3	6	Pigeons	1	0	1	1

WEEKLY CALENDAR.

Day of M th	Day of Week	FEBRUARY 2-8, 1864.	Average Temperature near London.			Rain in last 37 years.	Sun Rises.	Sun Sets.	Moon Rises.	Moon Sets.	Moon's Age.	Clock before Sun.	Day of Year.
			Day.	Night.	Mean.	Days.	m. h.	m. h.	m. h.	m. h.		m. s.	
2	TU	PURIFICATION, CANDEMAS DAY.	43.5	30.0	37.1	12	41 af 7	48 af 4	33 2	18 11	24	13 57	33
3	W	Chaffinch sings.	44.2	31.0	37.1	16	39 7	49 4	49 3	after.	25	14 4	34
4	TH	Field Speedwell flowers.	44.7	32.0	38.8	17	37 7	51 4	40 4	9 1	26	14 10	35
5	F	Spurge Laurel flowers.	45.7	33.6	39.6	17	36 7	53 4	31 5	22 2	27	14 16	36
6	S	Butcher's Broom flowers.	46.2	32.5	39.3	19	34 7	55 4	15 6	43 3	28	14 21	37
7	SUN	SHROVE SUNDAY.	46.5	32.8	39.7	19	32 7	57 4	52 6	7 5	●	14 24	38
8	M	Water Eit seen.	45.4	32.9	39.1	20	30 7	59 4	22 7	33 6	1	14 28	39

From observations taken near London during the last thirty-seven years, the average day temperature of the week is 45.2°, and its night temperature 32.1°. The greatest heat was 57°, on the 3rd, 1860; and the lowest cold, 8°, on the 5th, 1847. The greatest fall of rain was 0.75 inch.

THE FLOWER GARDEN.

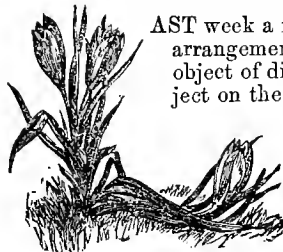

AST week a few hints were offered on the arrangement of colours, chiefly with the object of directing attention to the subject on the part of those who have not hitherto made the principles which ought to guide the combination of colours their study, and for want of which many glaring errors are committed. The object of this paper is to call attention

to one of the most prominent and prevailing causes of many miserable abortions in the way of flower-beds. If any one had the power of wandering like a fairy from garden to garden all over the country in early autumn, and could plants but speak, he would have, in by far too many cases, to listen to the mournful complaint of many a bedful of weary and forlorn-looking plants. "Oh! sir, we are in a sad plight. Once we were fresh-looking and comfortable, we were raised on liberal fare; the fat of the compost-yard, loam, and rotten dung, were our daily fare. We were watered, and tended, and sheltered with unceasing care till we became quite fat and handsome; but, at last, a ruthless master, or a mistress that does not seem to understand our wants, has stunk us out into this miserable bed, where we are starved for want of food, and battered about by those horrid winds, from which there is no hope of shelter. Our bed is so sour, cold, and badly drained, that we are chilled and almost caked to death. Oh! we are burned up in this miserably hungry soil, which has not been mauured for years. And, oh! sir, it is so hard just beneath our roots, that we do believe it has never been dug over a few inches deep since ever it has been denominated a flower-bed. We are parched up so in dry weather that it is as much as we can do to exist, far less grow or bloom. To attempt to send our roots down to escape harm from droughts is impossible, for that jobbing gardener merely pointed the bed over and made it look fresh in spring. We have so little hold of the soil, that we do think the next storm will blow us all to we do not know where; and yet we are expected to grow and cover all the soil, and bloom for a long time. How can we, sir? We are starved and most cruelly used, and worse than all, abused by those who don't seem to know what is the matter with us. Oh, that we could get into the squire's garden over the way, where the beds are trenched, and mauured, and drained, and surface-stirred; we would then shine like the stars, and show that it is not our fault that we have looked so miserable and bloomed so scantily."

We want a Jethro Tull among our flower-beds. Depend upon it he was not so far off the mark after all, when he propounded that deep draining and deep cultivation were nearly all that was needed for good cultivation. Certainly such conditions lie at the foundation of all good cultivation, and are nowhere more particu-

larly applicable than in the flower garden. An accumulation of water about a bed of flowers is productive of evils that will thwart the efforts of good management in all other respects. It will keep down the temperature of the soil, prevent the natural action of the atmosphere, and lessen the chances of getting the soil thoroughly pulverised and sweetened. At the present day it may seem almost superfluous to press the necessity for thorough drainage; but like most important matters connected with the social and moral well-being of mankind, it is, and will be for a long time, it is to be feared, necessary to keep its importance ever and anon before the mind of those whom it concerns. The same may be said of deep cultivation.

The benefits derivable from deep trenching are so many, that it would be difficult to enumerate them all, or tell their importance. It gives a greater degree of openness to the soil, so that roots can penetrate it more easily, and in dry seasons go down where the soil is more moist, and escape to a greater extent the evils of drought; the more perfect access of the air is secured, by which the soil imbibes ammonia and carbonic acid; and a greater supply of soluble matter becomes available for the use of plants.

These are points strongly applicable to successful flower gardening, according to the fashion of the present time. However frequently they are neglected in the cultivation of vegetables, it is to be feared that they are still less attended to in the cultivation of flowers; and this is undoubtedly one of the chief reasons why so many failures are met with in the shape of miserably starved-looking beds of Verbenas, Calceolarias, &c. Often has wonder been expressed to me why such have not grown better, or why they have ceased so suddenly to yield bloom, although at the same time the beds are either cold, wet, and soured, or the soil has neither been properly worked nor mauured for years.

It is a settled point with the experienced gardener, that the majority of the plants now used for flower garden decoration are as exhausting to the soil, and require to have as good a foundation laid for their culture, as many, or most of our vegetables. If this fact were more appreciated as lying at the very foundation of a brilliant and lasting array of bloom, the nurserymen and the plants they supply would not be so often made the scapegoat for the failures of many a disappointed lover of flowers. There are good reasons for fearing that the miserable appearance of many a villa and cottage flower-plot owes its origin to the idea that our present flower-garden plants do not require liberal treatment and careful cultivation, such as would be expected to produce good crops of vegetables; consequently my present object is to press home the fact, that in order to produce a fine bed of Verbenas, Calceolarias, variegated Geraniums, and, in fact, the great majority of such plants it is indispensably necessary that the beds be free from stagnant water, deeply worked, and well mauured. To this rule there are, of course, exceptions, such as in the case of the stronger-growing Geraniums, which are

at all times prone to run to leaf instead of flowers, Tropæolums, and a few other things, which only bloom profusely in poor soil; but to the great majority of flower-garden plants the rule applies, and there are comparatively few which do not fulfil the end required of them in rich and deeply-worked soil. Few crops can be more exhausting to ground than the tangled masses of Verbenas, Heliotropes, Petunias, Calceolarias, &c., and the shabby appearance which these often present in beds arises from the want of more liberal treatment. Much of the abuse which has been heaped on *Gazania splendens* has, in my opinion, arisen from its not being more liberally treated in this respect. There is no comparison between the appearance of this plant in well-worked and manured ground, and on poor soil that has merely had its surface scratched. The same may be said of some of our very best Verbenas. They are first starved, and then abused; but in spite of that they are splendid when cultivated, and, instead of yielding a puff of bloom as when not cultivated, they are the most continuous Bloomers. Let any one look at Golden Chain Geranium properly treated in this respect, and compare it with the same variety in a wretched bed of soil which may not have seen the light of day to the depth of a foot for years. Why, it has often to my knowledge been declared to be a different variety altogether. But it would be endless to multiply instances of this sort. The experienced flower gardener knows that he must trench his beds biennially at the least, and that he must thoroughly pulverise and manure them, if he has to produce a bold and lasting display of bloom. Where this operation has not already been attended to, no time should now be lost in having it done. The top of the beds should be left rough, so that a greater surface may be exposed to the action of the weather. This is more especially desirable if these beds have not been trenched for years.

Where the soil is of a light sandy nature, it would be greatly improved by having a quantity of stronger soil mixed in. The best manure for hot soils is cowdung which has been in a heap for twelve months, and has lost its rankness; the next best is old hotbed manure—that is, stable-dung and leaves well decayed—and for heavy soils I prefer well-decayed leaf mould. Where the staple is shallow it would be most desirable to deepen it by entirely removing some of the subsoil and replacing it with fresh soil; care must, however, be taken in doing this on subsoils of clay that a drain runs from the bottom of the bed, or it will become a mere receptacle for water to an injurious extent. Where fresh soil cannot be had the next best plan is to throw up an inch or two of the bad subsoil to the surface every time the bed is trenched. The action of the weather will pulverise it, and by mixing it with the surface soil and manure the soil will be much improved as to depth in a few years.

The flower gardener, who has a fine, deep, loamy, and dry soil that he can trench two and three spits deep, has a great advantage over others who have either a hungry, gravelly, or a wet tenacious soil to deal with. I have had to do with all three, and it is scarcely credible how gorgeously most things do in a deep, dry, loamy soil, such as the Vine would be expected to succeed well in.

Owners of small gardens have a great disadvantage to contend with where their soil is naturally bad. Generally they have great difficulty in getting their few beds either entirely remade or ameliorated. I am satisfied that their pleasure would be much greater if they were to restrict their operations to a less extent, and make an effort to form half a dozen good beds of soil instead of having double or treble that number in a bad state. This is, of course, presuming that they cannot overcome the difficulties of having all they would desire properly supplied with soil.

Clay soil is, perhaps, more effectually improved by burning than by any other means. Road grit, or any light sandy soil added to the beds, is also a good way of improving them; and, as has already been remarked, poor gravelly soil can be improved by the addition of a heavier staple, such as the parings and scourings of ditches, or even clay spread over the surface of the beds in winter. The rains break it up and work it into the light soil, where it will be of great benefit.

I hope these hasty remarks will prove useful by turning the attention of some to one of the most important points

connected with flower gardening, and that they will see that their beds are well worked, and that, at planting time, the plants are not carelessly put into them. When beds are hard, and hungry, and poor, bedding plants cannot be expected to grow and flower well; but there is no class of plants more grateful for liberal culture, and few more calculated to give a larger share of enjoyment and pleasure.

D. THOMSON.

THE ROYAL HORTICULTURAL SOCIETY'S SCHEDULE FOR 1864.

HAS the Society a motto? for if not, might I suggest for it "*Varium et mutabile semper?*" for, though originally applied to the gentle sex, I think no fickle dame, not even Dame Fortune herself, ever deserved the charge of changeableness as this most shifty Society does. We all know what this would imply in commercial life if we saw Popkins, the great tea merchant, or Stiggins, the sugar-boiler, not only altering but curtailing their arrangements. If we saw the shelves, which were to be filled with the finest assortment of Cathay, still unfilled, that several of the assistants were dismissed, that the fine new brougham with which Popkins used to astonish the weak minds of the natives of Rus-in-urbe Terrace when he drove out of an evening to his country house was put down, and that he was to be seen mounted on a threepenny 'bus, the inevitable feeling would be, "Popkins is going down in the world. Depend upon it, there'll be a smash there before long. I always told you what would come of his lavish expenditure; and when a man opens his shop with borrowing money to pay off his debts, rely on it he is in a bad way." What other inference can we draw from the proceedings of a society? The arcades, which were to be filled with the treasures of art, both foreign and domestic, still remain unfinished, and in all their dreariness suggestive of rheumatism and other little matters of a similar nature. The finest opportunity that ever a society had has been thrown away, and now the curtailment of the schedule but too plainly shows that the brougham is being put down.

When that nice little plan, of which we heard something last year, of curtailing the amount to be given for the prizes, into which the endeavour was made to entrap the Royal Botanic Society and the Crystal Palace Company, fell through, owing to the wise and firm position of Mr. Marnock, I suppose the "ruling power" felt that something must be done in the way of economical housekeeping, as the "coals were burning too fast." And this is the result: No less than three Exhibitions are abandoned this year. And mark the wisdom that has actuated this movement: The first might, indeed, very well be done away with; for an Exhibition in February was a ridiculous notion at the very outset, so one has nothing to say on that score. But no great Exhibition takes place until the 1st of June; consequently the Botanic Society and the Crystal Palace folk will come in with their Shows, and so take the keen edge off the appetite of the flower-loving public before the Royal Horticultural Society commence.

The Rose Show (and in this instance the reasonings of some of the contributors to this Journal have been thought worthy of being listened to), is placed by itself as it deserves to be; but, then, imagine with what pleasure this will be hailed by country exhibitors. It is to be a two-days affair!—a rule which seems to run through the arrangements this year, and than which nothing can be worse as a rule, especially in the hot months of June and July; and what injustice, too, to the flower itself! We know what Roses are at the end of one day's exhibition; what they will be after two days can be easily divined.

But, then, there is to be a Strawberry feast! Is this to be a two-days affair like the others? If so, how very nice the fruit will be when the time comes for eating it; for among the attractions whereby to allure the public to become Fellows is that at the end they may be able to eat the fruit! Will a notice be put up, I wonder, as at the Zoological Gardens—"Feeding time at six o'clock?" And how will it be decided? Is the Dowager Duchess of Dumbleton to have twice as many as Mrs. Tomkins, the stockbroker's wife? Are the members of the Council to be in attendance to "wait on the ladies," and take away the dirty plates?

Will cream and sugar be served with them? Really the Exhibition Committee ought not to leave the matter uncertain. Who knows how many new Fellows they may have lost by this tantalising feast not being declared one of its inviting features?

Then the autumn Show is entirely done away with. This I conceive to be a great blunder. It is true it may not pay; but when a Rose Show pays so well, surely a Society established for the encouragement of horticulture ought to be willing to lose a little at another exhibition. Why it should not pay I know not. If ever the gardens are to look well they ought to do so at the early part of September; and if a shilling were charged instead of half-a-crown, the public might be induced to come. The Crystal Palace autumn Show pays well—and so used the Surrey Gardens.

There is one thing which, I am sure, is against the "shilling public" going there; and that is the inhospitable character of those regions. One might as well be on the borders of Lake Victoria Nyanza, as far as the matter of supplying the inner man is concerned. It was only last summer that, with a few other exhibitors, I wanted to get something more wholesome than ices and Bath buns; and, after considerable hunting about, managed to get into a smoky coffee-room, where, after half-an-hour's waiting, we were supplied with a scorched mutton chop.

Another notable scheme is, I see, set afloat. Nurserymen are invited to see what they can do to save the Society the expense of keeping up the gardens; for, however it may be smoothed over, this is really the meaning of the last advertisement—"serve the cause of horticulture!" Save the pockets of the Royal Horticultural Society! Why not be honest, and give the true reason? Now, let all nurserymen, before they venture to put in a tender, ask the Society to furnish them with a statement of the number of persons who visited the gardens last year in July and August, when the bedding plants look their best, and they will then determine whether it be worth their while to act on this suggestion, so amiably worded.

But stranger than all, we read in the morning papers that "A scheme is in contemplation by the Council of this Society, for a series of competitions among volunteer bands. It is proposed that prizes be offered during the ensuing season for the best performances by bands numbering not fewer than twenty-four players each. Five pieces are specified as a part of the required test—namely, Rossini's Overture to 'Tancredi,' Meyerbeer's March in the 'Prophète,' Selections from Gounod's 'Faust,' Mendelssohn's 'Wedding March,' and 'God Save the Queen.' In addition to these, any five pieces of quadrille or waltz music will be at the choice of every band. The first prize will be a silver-headed band staff, of the value of £20, with £20 in money; the second prize will be £20 and a certificate of honour; the third prize, £15 and a certificate of honour; the fourth prize, £10 and a certificate of honour; the fifth prize, £7 10s. and a certificate of honour; and the sixth prize, £5 and a certificate of honour. Besides the above-mentioned prizes, one of £5, and another of £2, will be awarded among the unsuccessful competitors for the two best performances of each of the above pieces." A grosser perversion of a society's funds never was attempted. What has a horticultural society to do with nursing volunteer bands? O horticulture! horticulture!

In conclusion, are not all these shifts and contrivances unworthy of a Society which ought to be the foremost one of its kind in the world?

There is one other question that exhibitors would be very glad to have an answer to—viz., Where are the Exhibitions to be held? Are all the wretched contrivances of last year to be repeated, and gusty arcades and dirty dining-rooms to be the receptacles of the noble productions of our best gardeners?

I have thus briefly touched upon some of the most salient objections to the general aspect of the schedule. I shall next week point out some of the absurd details, which evidence a sad ignorance of the state of matters in the horticultural world.—ARGUS.

CULTIVATION OF THE CUCUMBER IN POTS.

HAVING in a former note given the produce by the above mode of cultivation, and thinking that of little use without describing the means employed, I now proceed to do so.

Two years since, the small house in which our Cucumbers were grown was erected for quite a different purpose, but not having at that time a convenient place for growing Cucumbers in, pots were plunged in the front bed close to the pipes (two four-inch pipes, one above the other for top heat), the bed having also two four-inch pipes for bottom heat. The pots are about 16 inches above the pipes, and the temperature is generally about 80° to 85°.

The pots are plunged side by side, the rims touching each other, and occupy a space of about 9 feet in length by 14 inches in width, or little more than a square yard. They are 14 inches below the top of the pipes, but the plants do not appear to suffer from the heat. The pots are well drained, at least one-fifth being filled with drainage, and then filled about one-half or rather more, and allowed to get warm before planting. The plants being small, I use light soil at first, adding, as they increase in size, more soil of a different kind—about equal proportions of horse-droppings and fibry loam—till the pots are heaped up.

The plants are trained up without stopping till about half up the roof, they are then stopped, and I consider one of the means of success is not to stop much afterwards.

The way I proceeded last year was to let the shoots grow pretty much as they liked, till they were 3 or 4 feet long. I then tied them in and stopped them, cutting out other shoots that had done bearing. The result was, I cut exactly one hundred more Cucumbers than the year before, when the plants were stopped in the usual way a joint or two beyond the fruit.

The next point is, as often as the top soil is matted with roots, to dig it out with a trowel to the depth of 4 or 5 inches, and to add fresh soil, perhaps four or five times during the season. In a very few days the fresh soil is filled with a new batch of roots. The plants now want something stronger than plain water; for this purpose I use nothing but sheep's-dung, and give it in pretty strong doses, always warm, each pot having at least half a gallon per day when the plants are in full growth.

I syringe freely of an afternoon, and shut up closely for an hour or two, to keep red spider at a distance, leaving air on at night, the temperature then rarely being more than 65°.

The plants never required smoking but once during last summer, although the house was full of various plants.

The foliage of the Cucumber plant is never large, and I never shade in any way, but give air freely.

The house has a fixed roof, with a wall hollow at the top, and slides for ventilation. The front lights open outwards in the usual way, and are 3 feet 1 inch high, including frame.

—J. E. CREED, *Gardener to F. Sewardick, Esq.*

RELATIVE MERITS OF WOOD AND METALS FOR HORTICULTURAL STRUCTURES.

By the removal of the duty upon glass, and the admission of foreign glass into general use, its increased consumption, consequent on the reduction in price, is in no way more manifest than in the multiplied number of glass houses devoted to horticultural purposes.

Cheap glass no doubt has—in addition to the increased wealth of the country, coupled with the growing taste for gardening—produced this change; so that it is, perhaps, not too much to affirm that the number of glass structures in gardens is fourfold what it was twenty years ago. Besides, glass has been used in a variety of ways never before contemplated, and its adaptability to other purposes for which it has not yet been tried is unquestionable, but time will demonstrate its utility in these respects. It has also been used for purposes for which novelty, rather than utility, seem to be its only merit; and objects in glass seem to vie with those in metals as regards their colossal proportions, while in the decorative arts it plays an important part. My object, however, is not to call attention to its value in the latter point of view, nor even to the question of which description of glass is the best for general horticultural purposes (a subject which is well worthy of being further discussed, and which may with advantage be gone into on another occasion), but to inquire which is the best way to use the glass so plentifully supplied by our manufacturers, so as to combine beauty in design with economy and utility; or, in other words, to

endeavour to ascertain what substance in addition to glass it is most prudent to employ to insure the result here sought for.

Important as the subject is, I am far from certain that it has received the attention it deserves from the general public. Every one has, or is suspected to have, a bias more or less strong in favour of the substance he advises to be used in addition to glass, and it is only when the comparative merits of opposing elements are duly weighed that a just view of the matter can be arrived at; for, like the shoemaker of old who declared "there was nothing in the world like leather," we may all of us be more or less prejudiced in favour of one or the other of the materials made use of to give the glass structure the desired form and consistency. I, therefore, invite all interested in the matter to come forward and record their views on the subject; and if their opinions be backed by facts bearing on the question, of so much the more value will these be. I must confess that my own opinion on the matter is far from being a settled one, for I do not think that the material best suited for producing an ornamental effect has yet been sufficiently tried to allow of a fair conclusion being arrived at; but what I have seen and observed of the effects of the substances used to give form to glass structures, I will endeavour to state impartially. Taking, therefore, the matter in its more confined sense, all we want to know is, What is the best material to fix glass to, so as to form a useful, good structure, adapted to horticultural purposes? and our inquiries will be met by those who urge the various claims of timber, iron (plain and galvanised), zinc, and copper, with probably an occasional claim from some one advocating the superiority of something else.

TIMBER.—Commencing with this, I believe it is not too much to say, that at least nine-tenths of the glass houses now in use are framed of wood, and glazed in the same material; besides which, all the oldest structures of the kind are of wood, and I believe almost all of the cheaper class of houses are so constructed: some of course are of indifferent quality, and evidently not destined to last long, while others have done service for several generations. It is difficult to say how long a well-constructed wooden house ought to last, as so much depends on other circumstances than the mere build thereof. The oldest glass house that I ever recollect seeing was an ordinary lean-to vinery, differing but little in outline and in other respects from the generality of those erected at the present day, excepting, perhaps, in a greater liberality in the use of timber, and an almost total disregard of paint; yet this house was doing duty tolerably well at the time I saw it, and was said to have done so for a hundred and twelve years. The timbers appeared to be all oak, and promised to last for fifty years more, excepting, perhaps, at some of the mortices and other places where the water lodged instead of running off. This was the oldest house having a glass roof that I ever remember to have seen or had an authentic account of; but I have known older houses having only glass fronts. This, however, is not bearing on the subject any further than, as they also were glazed in wooden frames, the durability of timber for the purpose, when the work is properly done, is beyond doubt; but whether timber is really more durable than iron, zinc, or copper, remains to be seen. It will, however, be advisable in the first place to record some of the other merits of glazed timber houses, as well as some of their defects, more especially when placed in juxtaposition with iron, or houses of that class.

Taking, therefore, the qualifications of the best deal as a substance in which to fix glass for horticultural purposes, not the least of its merits is that such a house is cooler in summer and warmer in winter. The nonconducting properties of the timber, as well as its greater bulk, give it this advantage over metallic houses; besides which, there is certainly less breakage of glass from natural causes, and the necessity for annual painting is not so great as in the case of a wrought-iron structure. On the other hand, it may, perhaps, be said that a wooden house is never so ornamental as an iron one, the latter being more light and capable of assuming many shapes incompatible with wooden houses. But in this view I by no means entirely coincide, as straight lines in mechanical works seem to me as legitimate as curved ones, and a great variety in form and feature may be secured without departing from straight lines—witness the many

changes that may be effected by plain ordinary bricks; and a timber-glazed house may be so contrived in shape and other features, as to produce an object as beautiful as ever was formed of metallic substances. Although these have certain claims on our notice to be detailed hereafter, I must not dismiss wooden houses without pointing out the great advantages that timber possesses over metals in the way of affording easy and convenient ventilating contrivances, and the facility with which creepers and other plants can be fastened to it, while it will endure with less harm the neglect of paint which we often meet with, and which is certainly attended with much worse consequences to an iron house than to a wooden one.

WROUGHT IRON.—As a material to form the framework of a glass structure, this has certainly failed in giving the satisfaction it was expected to do. I mean wrought iron not galvanised. I cannot precisely state how long it is since it was first employed to any extent in hothouse-building, but it certainly was in higher repute from 1830 to 1835 than it has ever been since. In the curvilinear shape there was much to admire in its light appearance, but the tendency which it had to throw off the putty, and the consequent necessity for frequent painting, soon caused it to lose many of its best friends; and it fell into still greater disfavour when it became known that an ordinary wear of some fifteen years had completely destroyed, beyond the possibility of repair, a couple of the best-built houses of the kind in the neighbourhood. Those houses were at one time looked on as models in their way, being composed entirely of iron bars of moderate thickness, bent to the curve of a segment of a circle 60 or more feet in diameter, and presenting, I believe, a curved face of about 24 feet. There were no rafters, the bars being kept at proper distances apart by ordinary fence wire passing through them longitudinally, and at distances of 2 or 3 feet apart. The extreme lightness of this class of houses gained them many friends at the time, but, as above stated, the liability of the iron to corrode and throw off both putty and paint rendered it anything but an easy matter to keep all in good repair, and neglect for a time led to the total destruction of the houses in question. This rapid destruction of houses expected to last several generations, coupled with some other disadvantages attending iron hothouses, led in a great measure to their abandonment, until the process of galvanising that metal in greater quantity than before again brought iron hothouses before the public. Very great improvements in the construction of such buildings have taken place, and it is not too much to assert that still further improvement may be made. However, as the past and present rather than the future is the subject, let us inquire how far iron houses have superseded those made of wood, and in what particular points the one article has claims on our notice greater than the other.

As stated in the early part of this article, iron is seldom used except in curves, domes, arches, and other forms to which timber cannot well be worked; and, in fact, there are several ornamental forms in which this metal can be used when the more common material would not answer; but it is occasionally employed straight, and sometimes even moveable lights are made of galvanised iron, but more generally the roofs of such houses are fixed and the ventilating contrivances adapted elsewhere. For sliding lights there are some advantages attending galvanised iron—it does not swell and contract with the changes of weather; but these advantages, are, perhaps, more than counterbalanced by the greater extremes of heat and cold which it presents in the summer and winter periods, and the difficulty which exists in repairing any part that may be accidentally broken is another drawback. I once knew a fine range of Grape and other forcing-houses formed of galvanised iron lights with wooden rafters, and in which the whole of the framework of the lights was iron galvanised before it was fitted together; the consequence was that the ends of each bar when cut presented the plain iron, which after being soldered to the head or end piece corroded, and in these lights which were made to slide up and down some of the heads were actually pulled off. Such a misfortune could not have happened to a wooden light except when in the last stage of decay, and even then the difficulty in finding a person to repair it would not be so great as in the other case. I believe, however, that a better class of lights are occasionally formed and subjected

to the galvanising process after having been made: this secures them from corrosion if the process has been well done. There are some very good examples of houses made in this way, and in appearance they are certainly lighter than those made of wood.

J. ROBSON.

(To be continued.)

THE ORCHARD-HOUSE CONTROVERSY.

THE onward progress of every controversy (such is human nature), inevitably draws with it some little bitterness and hard words; the friendly games of the "Heelanders" often resulted in hard blows, and the conjugal questioning of Mr. and Mrs. Naggleton resulted in open and undisguised warfare. So it has been in this matter of orchard-houses; and yet ought not each side to have better thoughts of their opponents than they seem to have? Surely I may question whether my neighbour Brown, who has run up a "gagabo" on the top of his house, which looks like an overgrown mustard-pot, is really the first architect in Europe; or whether Tomkins, who has sent to the Exhibition a pre-Raphaelite drawing of a mouse-whisker, is equal to Millais or Holman Hunt, without being myself considered a fool, or without my considering the said Brown or Tomkins as knaves. Therefore I hope that one may throw in a word or two on the subject without exposing oneself to being considered such a character, or without laying any imputation on those who differ from my views.

In all points of controversy it is ever desirable to fix the meaning of terms. The old story of the two shields is often enacted; and after days and months of dispute it is found that we are disputing about totally different things. What, then, is meant by an orchard-house? It seems strange that we should have need to come to so simple a question as this; but that there is a necessity for it I am quite sure.

If I recollect aright, when they were first started the idea was that hedges were to form the back or sides, or both; and indeed I have seen them so constructed. This was afterwards modified, and rough boarding or brickwork substituted; but the idea was never, I think, entertained that heating was to be used; and I mention this the rather because I have seen that where the greatest praise has been given and the greatest success obtained has been where heating is used. Thus I saw a paper the other day by Mr. Quintin Read, and I at once concluded we should hear something upon the subject that might perhaps overthrow one's opinion; but when I came to the directions as to the amount of heat, of course one saw that it was not an orchard-house at all about which he was writing. Finding the garden of a brother clergyman all at sixes and sevens some months ago: "Ah, C——! are you building there?" "Oh, an orchard-house." "Well, you have got it tolerably high, and I should think that it would hold a good deal of cold air, and your blossoms will catch an early frost perhaps." "Ah, but I am going to have some sort of heat in it." "And so you call that an orchard-house?" And so I generally find it.

Then, I think, the original notion was that the trees were to be grown in pots; but this I find to be frequently abandoned and the trees planted out. So it was at Lady Dorothy Nevill's. There the orchard-house was originally filled with plants in pots; but they were not found to answer, and so Mr. Vair has altered it, and planted the trees out. "And now," was my question to him, "what is your opinion concerning it? Would you obtain better fruit if your trees were trained, and it were made more like a Peach-house?" "Unquestionably."

When, then, the success of orchard-houses is so much spoken of, I think it well that the question should be asked, What do you mean by that term? Is it one *pur et simple*? or is it a make-believe? Do you put heat into it or not? Because if you do, I venture to submit it does not merit the term; and if this be so, then a great many instances of their success may be quietly shelved.

Then comes the question, "Do they pay?" This, I think, has been very satisfactorily disposed of in your columns. We have to recollect that there is not only the first cost (no inconsiderable matter where so large a number of trees is required), but the continued care, the watering, the

pinching, the mulching, &c., that must take place, and the fumigating, I presume, for the trees are very subject to the attacks of aphides and other "monsters." Where it forms no inconsiderable portion of one's business to sell trees, of course the orchard-house will well repay any amount of trouble that you may bestow; but where the amateur undertakes its care, he must regard it, I think, as a toy, and a very expensive toy too.

We have seen during the past summer orchard-house trees brought to our various exhibitions, and I do not think that their appearance was likely to make one single convert to the system of culture. The fruit was small, and looked stony, skinny, and uninviting; and after all, "the proof of the pudding is in the eating."

I was the other day at a nurseryman's, one of the best fruit-growers in England—one who has enriched our gardens with many new varieties of fruits; and I said to him, "What think you about these orchard-houses?" "I will tell you," he replied; "I have had no less than three collections of trees grown by amateurs of large means to dispose of, because the thing is a complete failure." I know myself two other cases in which the "notion" has been abandoned. "At one time," was Mr. ——'s observation, "I was strongly tempted to go into their growth, and am very glad now that I did not; but the thing is dying out. You may be sure that —— at Chiswick was right when he said in the beginning of the attempt, 'It won't do! it won't do!' I was amused," he said, "on saying to F—— at C——, regarding some Apricots in one of these houses, 'Why, mine on the wall are all over!' 'Oh' was the reply, 'it is so much colder under glass, and ours are later.' This may be an advantage, but it does not seem to me to be one."

When I say orchard-houses are dying out, I dare say I may be met by the reply, "Oh! but how many persons are building them?" Yes, doubtless, especially my very dear brother, to whom the notion is a tempting one; but how long will these new ones last in their present condition? for how many years will the same persons continue their orchard-house-growing? or will they not find it necessary to abandon them one by one? I think this is the point, and no strong assertions, no hard names, will mend the matter. I have never ventured to give an opinion from personal experience, for I cannot afford an orchard-house; but having an opportunity from time to time of seeing various gardens, and of hearing the comments of practical men upon the subject, one is surely serving the cause of horticulture by letting these opinions be known, and perhaps by so doing will save the pocket of many an ardent amateur to whom the idea is very tempting, but who will find the reality very disappointing. A great authority has recently gone off into raptures on Orange-culture and prophecies of the days "when the Gardens of the Hesperides will be revived in England." Being somewhat more practical and less imaginative, I venture to doubt the success of even less difficult matters than Oranges, and am borne out in my view of the case by many who have large experience in most matters connected with horticulture.—D., Deal.

[Our correspondent is right in his definition of an orchard-house, and we always have defined it as "an unheated glazed structure for the growth of fruit trees as standards," whether in pots or planted out is immaterial. We entirely differ from him in considering such structures mere toys. We can refer him to amateurs who grow Grapes, and Peaches, and Nectarines in large quantities unfaithfully, whilst on the open walls the two last-named fruits are too uncertain to be cared about. We have ourselves grown Grapes and Apricots in a similar house unfaithfully, whereas on the open walls the Apricots rarely escaped the spring frosts.—Eds.]

PRESERVING THE BUDS OF GOOSEBERRY BUSHES.

As some of your readers may wish to preserve their crop of Gooseberries in the coming season, I send you a few hints which may enable them to do so.

To preserve Gooseberry bushes from the attacks of Bull-finches, scatter slacked lime on them freely during a drizzling rain, and should a heavy shower follow and wash off some of the lime, repeat the process.

I have tried cotton and threads of all sorts and colours, pieces of paper, and feathers, &c., all to no purpose, but always found the lime effectual, and I have never missed having a good crop of Gooseberries on about seven hundred bushes, except when they have suffered from late frosts.

Peas and Beans may be preserved from mice, and Radish and all kinds of Cabbage seed from birds, by being dipped in moist red lead before they are sown.

Bullfinches live on the buds of Currant and Gooseberry bushes, all kinds of Plums and Black Thorn buds, and on Larch buds during the autumn and winter. What do they live on in summer?—J. S. KENWAY, *Market Gardener, Bathaston.*

CACTACEÆ CULTURE.

(Concluded from page 70.)

If it be inconvenient to place the plants in July in a greenhouse they may be removed out-doors to a situation not exposed to wind, and perfectly open to the south, so that they may receive the sun's rays. They are best placed about a foot from a south wall. It is desirable to stand the pots on a bottom impervious to worms, and one may easily be made by placing an inch of lime-riddlings on the soil and beating them firm with a wooden rammer, and another layer of the same made firm will prevent worms effecting an entrance through the bottoms of the pots. If worms get in, the drainage is soon choked, the soil becomes sodden, the roots gradually disappear, the wood never ripens, flowers cannot be looked for, and often the plant dies. Any pot, therefore, in which the soil remains very wet for weeks without being watered must have the drainage examined, the soil, if sour, removed, and the plant carefully set in a fair way of recovery. The pots may be plunged in coal ashes, or a little moss may be put between them, for the sun not infrequently heats them and destroys the roots.

Whilst out of doors it is only necessary to keep the soil about the plants moderately moist, and if they are plunged they will not need much water, in fact none if the weather be at all showery. They must not be exposed to heavy dashing rains, otherwise they are sure to suffer: therefore they ought to be protected from these, for which purpose a boarded or felt roof will be found useful.

In September remove them into a greenhouse, and place in a light airy situation. They must not be huddled together in a corner, nor kept in the darkest and very worst situation the structure affords. Such positions can be more advantageously occupied with Begonias, and such plants as need but little light in winter; at all events, it is the worst place for Cacti conceivable. During winter they will not need watering more than once a-week, and not at all if they be on a moist floor. An ordinary greenhouse temperature suits them in winter, or 40° as a minimum and 50° as a maximum from fire heat. After New Year's-day the plants may be introduced, a few at intervals, into the forcing-house, or any house ranging from 50° to 60° with fire heat. Water must be given regularly twice a-week after the plants show for flower, and an occasional watering with liquid manure will materially increase the size of the flowers. When in bloom they may be removed to the sitting or drawing-room, where the grandeur of the flowers is highly appreciated, and more than compensates for the little trouble bestowed in their cultivation. Unfortunately the majority of the Cacti are not fragrant; but I know not whether that is not an advantage, for plants having strong scents are very unpleasant in rooms where the inmates are not of a strong constitution. Judging from their effects on myself, I am persuaded that powerfully-scented flowers are prejudicial to health when their odour is long inhaled.

After flowering, the plants should be placed in heat as before, and grown on until July, when they are to be removed to the greenhouse or out of doors, as circumstances may render advisable. Prior to placing them in heat they should be potted; but it is not necessary to repot them every year, unless large plants are desired, when an annual potting and copious waterings with manure water during the period of growth will insure fine annual growths. If, on the contrary, the object is to keep them small, prune after flowering, cutting out most of the old shoots, so that there may

be an annual supply of young shoots for flowering in the following season.

Plants not placed in the forcing-house will flower in the greenhouse in April or May. They will require to be kept in a vinery at work for a month or six weeks to complete their growth, after which they are to be put outside or transferred to a light airy situation in the greenhouse. This mode of treatment is only suited for the tall Cacti—*i. e.*, the flat-stemmed and the triangular, and of which the flowers vary in colour from crimson to rose, pink, creamy white, &c. These may be had in bloom at various periods. Plants which are required to flower in September are placed in a forcing-house, ranging from 55° to 60°, in the first week in December, and receive very little water the first fortnight, the quantity being gradually increased as they advance in growth. All the young shoots are stopped in the middle of February, and these soon become mature; for after stopping, the supply of water is gradually decreased until they become quite dry, which is done in order to bring the plants into a state of rest. In March they are placed in a cool but not shaded situation in the greenhouse, keeping them dry at the roots; and in the first week in August they are replaced in the stove, and duly watered as they come into flower.

For flowering in August the plants are placed in the stove in the first week in January, treating them the same as those for September bloom, only they are put a fortnight later in the greenhouse to rest, and again removed to the stove in the last week in July.

Those flowering in August have the shoots perfectly ripened, and are put to rest in the greenhouse in October. These flower again in the spring. Those flowering in September will also flower in spring, and may be had in bloom a month later by placing them in heat a month after the first batch, which, if introduced into the stove in the last week in January, will flower in March; the others, consequently, would flower in the end of April.

If plants with well-ripened shoots be placed in a house having the temperature above named in the middle of January they will come into bloom in the beginning of March. If these plants are removed to the sitting or drawing-room to bloom, they must be kept in heat for a month after flowering in order to ripen the young wood and dry up the moisture, the watering being gradually diminished until they are brought into a state of rest. They are then placed in the greenhouse, and will flower again in October if placed in heat five weeks prior to that period. If more plants be introduced in the middle of February they will flower in the end of April, and if then pruned, dried, and put to rest they may be seen blooming again in November. Plants thus treated are potted at all seasons just as they require it, always taking care to drain well, so that the manure water may pass rapidly off, for they should be supplied with weak manure water at every alternate watering after the flower-buds appear until the process of drying-off commences, when water only is employed.

The above mode of cultivation may by some be considered troublesome; but superior growth and abundance of bloom never yet were had without extra care, and plants are superior or indifferent flowering just as they receive good or bad treatment. I have had plants of *Epiphyllum speciosum* and *E. Jenkinsoni* producing one hundred blossoms each at two years old, and at three years they produced between two and three hundred. In 1852 I saw a plant of *E. Russellianum* on a *Pereskia* stem, three years from the graft, and it measured 2 feet 6 inches through, and had no less than three hundred blooms upon it, and a finer specimen for dinner-table decoration could not be wished for, nor, indeed, for any decorative purpose whatever. The plant, however, had been inarched and was a good plant to begin with. It received the ordinary heat of a vinery after flowering until the Grapes were ripe, when it was removed to the greenhouse and kept there near the glass and dry until March, when it was placed in the vinery and came into bloom in April. It was potted in sandy loam with pieces of charcoal intermixed.

This mode of treatment must not, however, be practised with the smaller-growing kinds, being, as already stated, only suited for the vigorous and free-blooming sorts. The smaller species of *Mammillarias*, *Echinocactus*, &c., require a freer soil, and, to do them full justice, more liberal treat-

ment even than the others; but as it is no more than is given to plants in general, no one need cavil at the trouble. They should be potted in April in the following compost:—Sandy peat, light turfy loam, and lime rubbish from old buildings in equal parts, with a liberal admixture of sharp sand. Perfect drainage is provided for, and the soil used in a moderately dry state, so that it will not bind with the hand in potting. The pots used should not be larger than are sufficient to contain the roots comfortably. After potting the plants should be placed in a hotbed, plunging them in tan, the heat being 85°. The temperature of the air should range from 65° with fire heat to 85° by day with sun heat. Little water should be given until they commence growing, and then copious supplies may be afforded and gentle syringings overhead every sunny afternoon. The atmosphere should at all times be kept moist. Air must be given early, and the house closed by 3 p.m. They should be shaded from bright sun, for strong sun at this stage tends to cause maturation, instead of which the object now sought for is growth. Continue this treatment until the middle of July; then gradually harden them so as to be dried off by the end of August, when they should be placed in a light airy situation in a warm greenhouse, where they must be carefully watered, giving no more than sufficient to keep them fresh. By this treatment they grow amazingly, making more progress in one season than they can do in a lifetime when starved on shelves in conservatories and cool greenhouses. The latter mode of treatment is merely keeping them alive, and shows the extraordinary powers these plants possess of fitting themselves to circumstances.

Now I wish it to be understood that nine-tenths of the order Cactaceæ are natives of the tropics, and so cannot be starved into growing and flowering. They may and do flower in a cottage window; but does it not take seven years for them to grow and to mature that growth before they will flower? It is possible to grow them in a greenhouse or conservatory; but you must not expect them to advance much, and if they flower once before the three score years and ten are past be satisfied. In such situations they should be potted in April, be carefully yet moderately supplied with water whilst growing, and very carefully indeed in winter, giving no more than is sufficient to maintain vitality. Abundant light and close proximity to the glass are essential at all seasons. The situation should also be free from drip, and there must be a fair amount of ventilation.

I will make some observations now on their treatment where there is a house specially devoted to them. The remarks as to potting and other details apply equally in this as in other cases. It will be borne in mind that the more tender kinds occupy the pit, the less tender the front, ends, and back stages, and the young or hardier kinds the shelves. Here they should be potted whenever they commence growing; but, as a general rule, in the beginning of April. Water will then be more copiously given; and when growth has

fairly commenced the soil is to be kept constantly moist, and in addition to syringing overhead on fine days, the atmosphere should be kept moist by syringing the walls, floors, &c., night and morning. A brisk heat should be maintained of 65° by night and 75° by day, with a rise of 10° to 20° with sun and abundance of air. By July the plants will have made considerable growth; the lights of the house may then be taken off. The plants will thus receive the benefit of dews and gentle showers of rain; but should heavy rains occur the lights must be put on. It would also be advisable to replace these in windy weather. By thus taking off the lights the plants receive more light, and the gentle rains and dews are absorbed by them, for Cactaceæ, I am persuaded, derive the greater part of their support from the atmosphere in their native country, or drink in at night the evening dew, and are thus enabled to bear the intense dryness to which they are subjected; but however this may be, plants exposed in summer attain a fullness of their parts which they never obtain without this exposure. In September when the nights are becoming frosty the lights are put on, and from that time onwards through the winter the plants are but sparingly supplied with water, the temperature being kept at from 50° to 60°, a few degrees more or less as the state of the weather may determine. Air should be given on all favourable occasions, and in no way must the roof be made opaque, or the light diminished by creepers up the rafters. The air of the house should be kept dry in winter. Such are my ideas of a Cactus-house. There may be readier means of growing them, of which I shall be glad to hear through the columns of this Journal.

Many of the family produce fruit easily by impregnation, and in this way some desirable varieties might be obtained. Towards spring when the fruit becomes shrivelled the seeds may be taken out and sown in a pan filled with sandy loam and peat, covering them lightly with sand, and then plunging the pan in a hotbed. If the soil be kept moist the plants will appear in a month. They may then be grown on in the stove, potted when large enough, and when they have taken good root treated as established plants.

Cuttings strike readily if taken off about 6 inches in length, placed on a shelf for a few days to heal over the wounds, and then potted singly. Be cautious not to overwater them. Mammillarias are best increased by offsets, with which the plants are studded. Opuntias are propagated by taking off the branches at a joint and placing the cuttings on a shelf before they are inserted in the soil, where they soon root. Pereskias strike readily from cuttings, and these are grown on for two or three years until they are strong enough for stocks on which to graft Epiphyllums. They are grafted in the spring, no operation being more easily performed; it is simply putting in a young branch of the desired kind by whip or tongue grafting, and coating the grafted part with clay to keep out the air.—G. ABBEY.

METEOROLOGY OF 1863.—WESTON-SUPER-MARE.

1863.	TEMPERATURE.					BAROMETER.			Mean amount of cloud.	Rain in inches.	Number of days on which rain fell.	Direction and relative frequency of the wind.								Mean maximum force of wind.
	Mean.	Mean max.	Mean min.	Extreme maximum.	Extreme minimum.	Mean.	Extreme maximum.	Extreme minimum.				S.W.	N.W.	W.	N.E.	S.E.	E.	N.	S.	
March	49.9	57.8	42.0	59	31	0.62	2		
April	50.4	59.0	41.8	65	31	1.70	8		
May	53.0	62.8	43.6	72	31	30.02	30.33	29.57	4.7	1.32	9	10	5	8	0	3	3	0		
June	59.7	67.1	52.3	76	46	30.01	30.22	29.42	3.9	4.39	13	16	11	13	4	2	4	3		
July	63.0	73.8	52.5	83	41	30.10	30.44	29.44	3.2	0.42	4	15	20	8	9	6	8	10		
August	62.4	73.0	54.7	78	46	29.80	30.15	29.20	5.7	3.54	19	23	11	1	0	4	2	3		
September	54.8	63.8	48.2	68	39	29.72	30.30	28.96	5.8	4.74	21	20	16	11	1	5	0	2		
October	51.5	58.2	44.8	65	32	29.78	30.34	29.16	6.9	5.90	20	11	5	12	4	13	13	3		
November	48.1	52.7	43.2	58	33	30.15	30.50	28.95	6.0	3.05	15	9	7	7	5	12	10	2		
December	45.2	49.4	40.9	54	33	30.23	30.62	28.95	6.6	1.66	19	20	9	15	2	1	2	2		

Cloud.—This column gives the mean amount of sky clouded during the day (twelve hours). Scale 0 to 9.

Force of Wind.—From the maximum force during twenty-four hours. Scale 0 to 12.

Direction of the Wind.—From three daily observations (twelve hours).

Thermometer.—In north aspect, 4 feet above the ground.

Barometer.—Observations at 8 a.m. and at 8 p.m. Instrument 10 feet above mean sea level.

Rain gauge 3 inches above the ground, and 8 feet above the mean level of the sea.—THE DOCTOR'S BOX.

FLOOR OF PROPAGATING-HOUSE—SETTING A SADDLE BOILER.

WHAT is the best material (economy and durability considered), for the floor of a propagating-house? If concrete, what proportions of lime and gravel, which are to be had near at hand?

In setting my saddle boiler is there any objection to the flame, &c., after passing under the boiler, returning over the top and sides, the chimney to be in front over the stoke-hole? I propose to have soot-doors at the back, and, if necessary, to create a proper draught on lighting the fires by burning a little straw in the soot-hole.—*De Foix*.

[We question very much whether concrete would suit your floor, unless you were to mix with the upper part of it

gypsum or plaster of Paris. All things considered, we think hard-burned flooring-tiles will be the best.

You cannot take the heat of the fire too much outside and over the top of your boiler, as well as underneath it. A man who can set a washhouse boiler in a proper manner will make no great mistake with one intended for heating houses. We do not think you will need your straw, &c., in the ash-pit, but you will need a damper near the bottom of the chimney, though much of this regulating may be done by means of a valve in the ash-pit door, of course keeping the furnace-door shut at all times, except when lighting the fire.]

DENDROBIUM FARMERII.

THE best evidence we can give "A LOVER OF ORCHIDS" that the club-shaped stem he sent is not one of *Dendrobium densiflorum* is by publishing the above outline engraving. He will see that the stem referred to resembles those in the engraving, which is of *D. Farmerii*. This species was obtained from the Calcutta Botanic Garden, as long since as 1847, by W. F. G. Farmer, Esq. Its specific characters are:—Stems elongated, club-shaped, jointed, swelling at the joints, becoming a pseudo-bulb at the base, pendulous, leafy near the top. Leaves leathery, oblong, pointed, nerved. Racemes lateral, many-flowered, longer than the leaves. Bracts at base of pedicels small, ovate, concave. Sepals spreading, ovate, blunt, delicate pale rose. Petals large, similar in colour, ciliated. Lip broad, inclining to square, clawed, ciliated, blunt, pale straw with deep yellow blotch. Column very short.

It flowers in the stove during May.

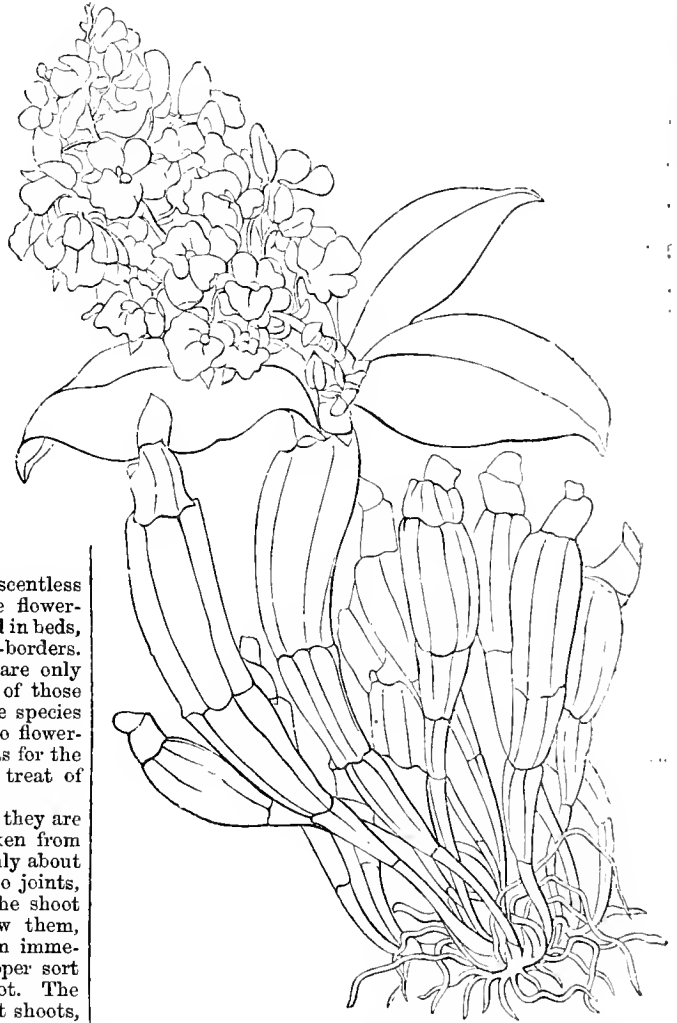

SHRUBBY CALCEOLARIAS.

CALCEOLARIAS are amongst the handsomest of scentless flowers, and the conspicuousness of their massive flower-heads renders them highly ornamental when planted in beds, ribbon-borders, or as single plants in mixed flower-borders. They are natives, for the most part, of Chili, and are only found on the South American continent. Many of those now in cultivation are hybrids, though some of the species are still grown. In addition to their contributing to flower-garden decoration, they form handsome pot plants for the greenhouse and conservatory. I will, therefore, treat of them in both ways.

1st, *For Out-door Decoration*.—For this purpose they are propagated from cuttings. These cuttings are taken from the growing points of the shoots, and are commonly about 3 inches in length. Providing the cutting has two joints, or a pair of leaves with the growing point of the shoot resting upon their axils, and another pair below them, which are to be removed, and the portion of stem immediately below them cut off, it is not only the proper sort of cutting, but ready for inserting to strike root. The cuttings should be taken from the least succulent shoots, (avoiding strong growths), and such as are moderately vigorous for the kind. Cuttings from gross succulent growths flag more, and are more liable to damp off than those taken from moderate but healthy-growing plants. They should be taken off before the frost kills the bloom; for it will do this before it kills the foliage. No particular time can be given for this operation. It may be done from the beginning of October to the middle of November.

The best place for the cuttings is a pit or frame, and if there be a hot-water pipe in it it will be of assistance in excluding frost and causing a circulation of air in close, wet, foggy weather. Provide good drainage at the bottom of the pit or frame, and on that place about 6 inches or so of rough ashes; then lay on 6 inches of soil consisting of rather

light loam, fresh, and by all means sweet, and leaf mould, two-thirds of the former to one-third of the latter. Cover the surface with about half an inch of silver sand. When thus prepared the surface of the soil should be about 1 foot 3 inches from the glass. The soil should be in a moderately moist condition when put in, and only a gentle watering is needed after the cuttings are inserted to settle the earth about them. Make holes with a dibber little thicker than the stem of the cutting 3 inches apart every way, and into these drop or put the cuttings, letting the lowest leaves rest on the sand. Having put in the whole, water gently through a fine rose; and we have a cutting resting with its base on sand and the stem surrounded by the same, the

whole in a condition to remain until near Christmas without roots. It is not necessary to close the earth to the cuttings after putting them in; the nervous cutting-strikers may do so to satisfy themselves, but the watering will fill the vacancy round them with sand, and cuttings resting on and surrounded by sand are not half so likely to damp off as those with soil close to the stem. Put on the lights, and keep them continually over the plants, but admitting air occasionally to prevent damp and stagnant air, yet not so as to dry the atmosphere and cause the cuttings to flag. The cuttings will need a covering of mats in cold weather, varying in thickness according to the severity of the frost. During the prevalence of frost the cuttings should not be uncovered so long as the external air remains below freezing, and when it is above that point they should not be suddenly exposed to the sun's rays or light, but be gradually inured to a change of temperature.

By Christmas the cuttings will have struck, after which admit air on all favourable opportunities; whenever the external air is above 32° let air be given, and even when it is not if a hot-water pipe running along the front can be worked so as to prevent the internal temperature from falling below 32°. In case of there being nothing but the bare frame and covering to rely upon in severe weather, the sides of the frame should be protected with straw to the thickness of at least 6 inches, driving stakes at that distance from the frame all round and filling in the intermediate space with dry litter quite up to the top of the frame. Litter of any kind, as fern fronds, &c., will answer as well for this purpose as the best straw. The glass will require to be covered with straw in addition to mats in severe weather to at least 6 inches in thickness, and this covering may remain on day and night in very frosty weather, only taking it off in mild intervals, and then doing so gradually that the plants may derive the full benefit of a gradual thaw without experiencing that parboiling which results from the sun suddenly thawing or striking plants inured to severe frost, and from which light has been long excluded. By March the plants will be commencing growth, when the points of each should be nipped out, and a little water given if they need any, applying it in the morning, so that they may be dry before night. Admit air on all favourable opportunities, and all the light practicable to insure stiff sturdy plants.

In April the plants will require more room, when a place should be looked out in the open garden in a sheltered situation. Take out the soil 9 inches deep and 3 feet wide, leaving 2 feet alleys between what I will term trenches. These trenches should point north and south, as they will then derive more benefit from sun heat. Place 6 inches of leaf mould at the bottom of the trenches, and fork this neatly into about 6 inches of the soil beneath. If the soil, however, be very strong and heavy, it would be advisable to add 3 inches of rather light loam to the leaf mould, and to well incorporate these two, mixing in about one-sixth of river sand. Take the plants out of the frame (for most likely it will be wanted for Melons or Cucumbers) with balls, cutting round each with a trowel; but a more expeditious plan is to cut between the rows with an edging-knife or spade, and then the trowel, thrust in crosswise, will bring each plant away with a ball 3 inches in diameter. Plant them in the trenches 6 inches apart every way, but in rows longitudinally. Press the soil rather firmly about the balls, not planting them more than half an inch deeper than they were before. Water freely and cover with mats, upheld by hazel or other sticks hooped over the beds, the hoops describing such a portion of a circle as to allow the mats to be placed lengthwise with the edges just reaching the soil, where they should be hooked, or pegged fast with wooden pegs, in order to prevent the wind blowing them off. In about ten days this covering may be removed by day, and at night too if the weather be mild, but it must be put on at night in frosty weather, augmenting the covering if the nights are very severe. After sharp frosts the covering should not be taken off until the plants are thawed, and if the frost continues all day leave the covering on, for they will take no harm from being kept in the cold and dark. Should the plants become frosted for want of sufficient covering, do not remove the covering and let the sun shine upon them to thaw them, for it will assuredly kill them, but increase the amount of protection, and seek to exclude light.

When the weather changes the frost will leave the plants uninjured.

The points of all the shoots are to be nipped off when May day arrives, and copious waterings given, but in the morning. By the middle of May the plants will be strong, setting an example to those grown in pots. Then, with a spade cut perpendicularly between the rows on every side, having previously trodden the earth firm with the foot. Supplement the operation with a thorough soaking of water. By this strange operation we seek to cause the roots to be formed nearer the stem, which enables us to lift the plants in about a fortnight with a ball permeated by a mass of roots, every point of which is a mouth, ready after transplantation to collect nutriment from the soil, and nourish the plant to which it belongs.—G. ABBEY.

(To be continued.)

STOVE-HEATING A FORCING-HOUSE.

At page 43, under the head of "Stoves," Mr. Fish says he keeps frost out of an orchard-house 75 by 11 feet. Will he explain whether he has any flue, and whether the house has brick walls? I have an orchard-house 25 by 14 feet, built from Mr. Rivers' own plan, and which that gentleman assured me would be perfectly secured by fixing an Arnott's brick stove of the dimensions given in his book. I have fixed one 4½ inches larger each way, and my experience is wofully contrary to his, for in the late frost the thermometer was at 26°; and in ordinary frosts, with the fire constantly in, the place is secure only 6 feet on each side of the stove. Will Mr. Fish say how he manages? Mine is a span-roofed house, and in a sheltered place.—A. R.

[My house is a lean-to, the wall at back about 10 feet above the level of the soil there, and the soil sloping about 15 inches to the front. The front of the house from 3½ feet high, consists of 1 foot of glass, and the rest of one-inch boards, part fixed, and part for ventilation. The stove, of the size described, is set in the middle of the house as respects its length, and nearer the front than the back as respects width. It is about half sunk in the ground, but with an open space all round it. A pipe 4 inches in diameter and 7 feet long goes from it, a little raised from the horizontal so as to pass out through a hole at the bottom of the back wall. Outside the wall, opposite this pipe, a brick cesspool-like place was made, say 10 or 12 inches square, and a small iron moveable plate was fixed into it opposite the pipe from the stove, so that a sweeping-brush might be run through it at any time. Above this cesspool foundation outside, the chimney, formed of hard-burned drain-pipes and an iron pipe, respectively about 4 inches in diameter inside, is taken up a foot above the height of the wall. It will be observed, that, besides the stove, there is only the seven-foot strong iron pipe inside the house. We could have had more heat if we had placed the chimney inside, but the hole at the bottom of the wall was ready for us, being, in fact, a small ventilator, the rest of which, round the pipe, we bricked up; and there were several reasons why we should make no more holes or trouble about the stove than we could avoid, and the more especially as this was only an experiment from which a criterion might be drawn as to what might be attempted in this house, and the success of which would depend on the keeping out of frost.

So far as known, the results were exactly as described at the time. Unfortunately, during the severest of the frosts, I could not examine for myself, but was told that the thermometer, 2 yards from the end, was never lower than 1° or 2° above freezing-point. The cursory look at the plants made me believe this, and most likely it was quite correct, as the thermometer stood about 3 feet from the roof, and from 6 to 7 feet from the back wall. On examining and moving the plants, however, it was found that some half a dozen boxes of young Geranium plants, and, perhaps, eight or ten 24-sized pots filled with cuttings, were injured that stood near the front of the house. This, no doubt, was partly owing to the open seams of the wood in front, and to the heat from the stove not telling so much on the front as the back. So far as I could observe, nothing was injured that was not farther than 7½ feet from the back wall. Decidedly that wall gave a great advantage when compared

with the span-roofed house of "A. R." Of course the stove required a considerable amount of care and trouble. I am perfectly satisfied, that without protecting the upright board and glass front, and at least a part of the roof, I could not, with such a stove, keep out such a frost as we had in 1860 and 1861, but that it could be done with two stoves. I need say nothing of what may be done by a small boiler placed on the top of it; because, though pretty well assured of what could be done, I am not in a position to try it.

I should like to know how the stove of "A. R." is placed. He says the air is heated only 6 feet on each side of it. Now, if I have a small fire on, you know it as soon as you open the door at either end, which is close to the back of the house. In walking along, you can discern but little difference in temperature, and when I suspended three thermometers, one near each end and one in the middle, they differed much less than could have been expected. I forget exactly how little. Perhaps the wall helps this. I recollect pouring a little water on the stove when hot, to convince a sceptic how hot air diffuses itself. The morning being calm, the heated vapour soon passed like a cloud along the upper part of the house to the extreme ends, and then returned along the lower part or front of the house.

Much dissatisfaction has been caused both by iron and brick stoves inside houses, by taking a pipe or a flue from them for any length in a horizontal position, if that horizontal pipe does not go into a high chimney. For stoves in general, 2 feet is long enough for a horizontal pipe, if the chimney is not more than 8 or 10 feet in height. They would all draw better if the pipe went perpendicular at once, but then the draught might be too strong for our purposes, though that could be regulated by the ash-pan or a damper. Our experimental stove once was honoured to stand in an entrance hall, and it had then some 15 feet of horizontal piping, but this entered into one of the lofty chimneys of the mansion, and there was no lack of draught. I find our 7 feet of horizontal piping is rather too much, and I purpose sinking the stove, so as to take the pipe more from the horizontal, as, if a fire is lighted for the first time after several weeks, the smoke is apt to come back on the fireman before the stove gets hot. We obviate all this disagreeableness by just moving the iron plate outside already referred to, and placing a handful of lighted shavings or straw in the cesspool-like place, which dries and warms the chimney, and there is no smoke then that comes back from the stove.

I mention this little matter more particularly, because I know of several cases where iron stoves and brick stoves, especially inside houses, could not be worked satisfactorily, because their owners with pardonable economy, wished to have a long pipe or flue nearly horizontal before rising perpendicularly, in order to give more heat to the house. These stoves require in this respect different treatment from a common furnace and flues with a rather high chimney at the end. And once more: when pipes are used for iron stoves, it is best to have them of cast iron at once.—R. F.]

ROYAL HORTICULTURAL SOCIETY'S COMMITTEE.—JANUARY 29TH.

FRUIT COMMITTEE.—A meeting of the Fruit Committee was held this day, Mr. Wrench in the chair. In the class for the best dish of Adams' Pearmain Apple, Mr. Spivey, of Hallingbury Place, was the only exhibitor; but the variety sent was Pearson's Plate, and not Adams' Pearmain. In Class B, for Margil, Mr. Spivey was the only exhibitor; but the fruit, though perfectly sound externally and of a beautiful colour, was on being cut found to be decayed at the core. In Class C, for Old Nonpareil, Mr. Snow, of Wrest Park, received the first prize, and Mr. Spivey the second. In Classes D and E there were no entries. In Class F Mr. Snow, of Wrest Park, exhibited fine large fruit of Bergamotte Esperen, which, however, was deficient in flavour, and it was awarded a second prize.

In Class G, for the best dish of new Black Hamburgh Grapes, Mr. R. Budd, gardener to the Earl of Darnley, Cobham Hall, Kent, received the first prize; and Mr. John Pearson, gardener to Lord Foley, Worksop Manor, received the second prize. Both were very excellent examples of

good cultivation; but the berries on Mr. Budd's bunches were much larger, and equally well coloured with those on Mr. Pearson's. As regarded flavour there was little difference between them. Mr. Tillery, of Welbeck, sent bunches of Black Alicante, Black Tripoli, and a seedling from Barbarossa to compare with the new Black Hamburghs. The Black Tripoli, which is the same as Frankenthal, had large berries, very fleshy, and much shrivelled; the flavour was sweet and delicious. The Black Alicante was a little but not much shrivelled, and the flavour was good. The Barbarossa seedling was decidedly better in flavour than the Alicante. It has a very close resemblance to the parent Barbarossa—so close, indeed, that the difference is not distinguishable, evidently showing how fixed a variety the Barbarossa is by reproducing itself from the seed in the same way as Chasselas Musqué, Muscat of Alexandria, and some others do. The Committee were of opinion that, notwithstanding the great richness and sugary flavour of the Black Tripoli, they did not possess the fresh "grapey" flavour of the new Hamburghs.

Mr. Fleming, of Cliveden, sent very nice bunches of Barbarossa, and of Oldaker's West's St. Peter's, both well coloured; but the flavour of Oldaker's West's St. Peter's was decidedly superior to that of Barbarossa. These, also, were sent for comparison, but all these long-hanging sorts certainly lack the fine fresh flavour which the new Grapes possess.

Mr. Sanders, gardener to Sir Henry Meux, at Theobald's Park, sent a splendid bunch of Lady Downes' Grape, perhaps one of the best we have ever seen exhibited. It was as large as a very large bunch of Muscat of Alexandria, long and tapering, with two very large shoulders. This was awarded a certificate of commendation.

Mr. B. S. Williams, of Paradise Nursery, Holloway, exhibited a fine bunch of the Royal Vineyard Grape, the flavour of which appears to develop itself the longer it hangs. On this occasion a decided Muscat flavour was apparent, and the sugary flavour was more developed than we have ever found it. This evidently appears to be a late-hanging Grape; the berries were quite plump, and showed no signs of shrivelling, and like Barbarossa and all the late varieties, its flavour appears not to be developed till late in the season.

Mr. Spivey, of Hallingbury Place, near Bishop Stortford, sent thirty-three dishes of as many varieties of Apples. They were all correctly named, except one called Winter Pearmain, a green Apple, which could not be identified. For this collection Mr. Spivey was awarded a certificate of commendation.

Mr. Rivers, of Sawbridgeworth, sent specimens of Red Baldwin, Ladies' Sweeting, Jonathan, and Melon Apples, all of which are American sorts, but grown in the open air at Sawbridgeworth. They were beautifully coloured, and highly ornamental. He also sent another called Allen's Everlasting, an Irish Apple of medium size, flat and angular, and with an excellent flavour. It is a very late keeper, and will prove a useful variety.

Dr. Sankey, of Hanwell, sent a seedling kitchen Apple, accompanied by some of the same in a cooked state; but the Committee were of opinion that though a good kitchen Apple, the fact of its cooking of a brownish colour detracted from its merit.

The Rev. Mr. Alleyne, of Rickmansworth, sent three sorts of seedling Apples, neither of which was considered to possess any merit superior to many others in cultivation. Mr. Turner, of Slough, exhibited a fine large seedling kitchen Apple raised by Mr. Joy, of Roundway Park, Devizes, and which has been called Roundway Magnum Bonum. It is roundish ovate, ribbed towards the eye, greenish yellow, with a few broken streaks of red on one side. It is remarkably solid and heavy; and the flavour, even as a dessert Apple, is not to be despised. It was awarded a first-class certificate.

Mr. Rivers, of Sawbridgeworth, sent specimens of Tangerine Oranges, which were well grown, highly ripened, and of which the flavour was very fine. He also sent some specimens of the Maltese Egg Orange, which, however, were not quite ripe.

Mr. John Forbes, gardener to J. C. Pickersgill, Esq., Hooley House, Coulsdon, Surrey, sent a fine dish of forced

Tomatoes, which were awarded a certificate of commendation.

Mr. Budd, gardener to Lord Darnley, Cobham, sent specimens of a fine variety of Beet, which has been grown at that place for upwards of forty years, and which never shows any disposition to degenerate or "sport." It is a very excellent Beet; but the Committee were of opinion that it is rather too like Castehaudary to be considered a distinct variety.

THE WEATHER OF 1863 IN LANCASHIRE.

JANUARY.—This was a very mild damp month. The mean temperature was 40.65°. The lowest temperature during the month was 23°, and on seven days only was it below freezing. The amount of rain was 3.83 inches, being 1.35 inch above the average; it fell on twenty days. This large amount of rain was a very great contrast to January 1861, when only 0.29 inch fell. This month and the previous December were so remarkably mild that all the spring flowers were in bloom. The prevailing winds were from the S.W.

FEBRUARY.—The temperature of this month was remarkably high, averaging no less than 41.14°, and it was only twice below freezing, on the 11th and 28th, and then only 2° of frost; vegetation, consequently, was very forward. This and the three following months were very dry. The amount of rain was only 1.01 inch, which fell on fourteen days. The prevailing winds were from the S.W.

MARCH.—The mean temperature was 42.82°, which is above the average. The amount of rain was only 0.94 inch, which fell on fourteen days, and was the least quantity of any month in the year, and a great contrast with the year before, when 3.11 inches fell in March. The ground having been so very favourable for the reception of seeds, vegetation was progressing very rapidly. The prevailing winds were from the N.W. and S.

APRIL.—This was a very dry warm month, the mean temperature being 49.8°, or nearly 4° above the average, and it was the warmest April we have had for many years. Vegetation showed the effects of the warmth, and was looking very luxuriant. The amount of rain was only 1.17 inch, or about half the average quantity; it fell on ten days. The prevailing winds were from the N.W. and S.W.

MAY.—This was the first month that the temperature was below the average, but it was a very dry month. The mean temperature was 52°, and the amount of rain was only 1.38 inch, which fell on ten days, and was a very great contrast with May, 1862, when there fell as much as during the last three months. The prevailing winds were from the S.W.

JUNE.—This was a very wet cold month, and vegetation received such a check that by the end of the month it was later than the average. Rain fell on every day, except two, from the 5th to the 22nd, when we were blessed with six fine days, which improved the gloomy prospects of the hay harvest. It rained on eighteen days, the amount being no less than 4.11 inches, or nearly as much as in the previous four months. The mean temperature was only 50.53°, or about 9° below the average, and it is many years since the temperature of June was so low. The prevailing winds were from the W.

JULY.—The temperature was again below the average, but it was the driest July we have had for a number of years. Rain fell on two days only before the 18th, and from the 5th to the 15th was the only hot summer weather we had during the year. The hay harvest was secured in splendid condition, but the crops generally were light. The mean temperature was 58.53°. The amount of rain was only 1.29 inch, and it fell on eight days, which was the least number of days on which rain fell in any month during the year. The prevailing point from which the wind blew was the N.W.

AUGUST.—The mean temperature was again below the average, being 59.48°. Rain fell on twenty-two days the amount being 3.77 inches, which is the greatest amount that has fallen in August since 1860, when it rained on twenty-five days, the amount being 5.33 inches. The prevailing winds were from the W. and S.W.

SEPTEMBER.—This was a very cold wet month, and the corn harvest was very indifferently secured in many of the northern counties. Rain fell on twenty-two days the amount being no less than 5.02 inches, which is the largest quantity collected in any month during the year or in September for a great number of years. The mean temperature was only 49.3°, or about 7° below the average. The prevailing winds were from the W.

OCTOBER.—This was also a cold wet month, the mean temperature being 46.13°, or about 4° below the average. It rained on twenty days, the amount being 4.31 inches. The prevailing winds were from the W. and S.E.

NOVEMBER.—This was a mild month and a great contrast to November 1862. The mean temperature was 41.57°. The amount of rain was 2.62 inches, which fell on fourteen days. The prevailing winds were from the S.W.

DECEMBER.—This was again a remarkably mild month, the mean temperature being 41.13°. We read of Strawberries being gathered and of quantities in bloom; and at Malvern a beautiful bouquet of flowers was gathered, composed of Verbenas, double Daisies, Roses of various kinds, Geraniums, common Marigold, Fuchsias, &c., all grown in the open air; and in Berwickshire, "Jasper Standstill" collected eighty-five species and varieties of flowers (all grown in the open air) on the last day of the year, amongst which were Polyanthus, Verbenas, Cowslips, Stocks, Violets, Marigolds, Anemones, Picotees, Mignonette, Candytuft, Virginian Stocks, Roses of various kinds, Daisies, Primroses, Fuchsias, Wallflowers, Scarlet Geraniums, &c. Honey bees were busy collecting farina; and a strange visitant at this season of the year—no other than a wasp fresh and vigorous, stung a woman that was employed in a warehouse. The amount of rain was 2.70 inches, which fell on fourteen days. The prevailing winds were from the W.—Wm. Carr, Clayton Vale, Newton Heath, near Manchester.

WORK FOR THE WEEK.

KITCHEN GARDEN.

We would impress upon the minds of all who cultivate the soil with the view of receiving an adequate return for the labour bestowed upon it, that a thoroughly efficient system of drainage is the basis of all successful cultivation. We allude, of course, to soils that do require draining, because some do not. *Cabbage*, fill up vacancies in the autumn plantations; also, make fresh plantations of the autumn sowing if necessary. *Carrots*, make another sowing of Early Horn. *Cauliflowers*, those under hand-glasses and in frames to be fully exposed during the present mild weather, or they will button-off in the spring. *Celery*, sow seed in boxes, and place them in heat to produce plants for an early crop. *Peas*, if the soil is in good working condition put in now the first principal crops of Dwarf Marrow, Victoria, and British Queen, in the open quarters, sowing Spinach between the rows. As this ground comes in well for Celery, the Peas should have the full width of 6 feet from row to row. The Spinach will come off in time for the trenches to be made for Celery. *Potatoes*, where there is not the convenience of frames or pits, plant in a south border for an early crop. Traps should be set in different parts of the garden to catch mice, they will now more readily take the baits than they will when there is other food for them.

FLOWER GARDEN.

In planting shrubberies, those trees and shrubs which are intended to remain permanently should be first planted, and at such a distance from the walks and from each other as not to interfere with either the one or the other for at least ten years; this would allow many of them to attain a large size, and to develop their proper characters. The intervening spaces may be filled up with more common sorts, and as they encroach upon those that are intended to remain permanently, they should be removed. Such trees and shrubs will not then require much pruning, and digging about their roots we consider to be the worst practice that can be adopted. The beauty of pleasure grounds is much enhanced by a close, velvety lawn. It often, however, requires much trouble to effect this object. On rich soils the grosser grasses prevail, and are difficult to eradicate or

keep under; while on soils naturally poor, and which have been for some time under the scythe, the different kinds of mosses are found to increase in a manner prejudicial to the better sort of lawn grasses. As the present is the season when the mosses attain their greatest perfection, it will be found the best time to eradicate them also. A sharp-toothed iron rake or light drag will be the best implement for this purpose, worked sufficiently to bring up the moss, which should be cleared off, and the lawn left for some time, when a second operation may, perhaps, be necessary. In March sow thickly Sheeps' Fescue Grass and Crested Dog's-tail, and apply a dressing of sifted lime rubbish and fresh soil, or the soil and fine bone dust, which with occasional rollings to keep the land firm, will soon produce a good sward. Sow hardy annuals in mild, dry weather in the open ground and in frames, for transplanting. Plant Anemones and Ranunculuses. Protect the choice autumn-planted bulbs, as Tulips, Hyacinths, &c.

FRUIT GARDEN.

The pruning and nailing of Peaches, Nectarines, and Apricots, may be followed up with vigour and perseverance whenever the weather is favourable. Wall trees of any kind that are getting crowded with wood near the top of the wall should have some of the larger branches headed back, and the shoots brought down lower. Do not crowd the centre of fan-trained trees with too much wood, that part will always fill up enough.

GREENHOUSE AND CONSERVATORY.

The advantage of increased solar light and heat will be rendered apparent by the increased brilliancy of colour in the flowers and depth of verdure in the leaves, provided a judicious admission of air and a just proportion of other essentials be continued. The display of flowering plants in the conservatory may receive additions from various quarters. The stove will afford the beautiful *Euphorbia jacquiniiflora*, which may be removed without injury. Fragrance is a quality always sought for in flowers; the most striking are too often deficient in that charming recommendation. In effecting an arrangement this must not be forgotten. However humble in appearance, the modest Violet and Mignonne will always be valued for their delicious fragrance. As the general potting season is approaching, have everything in readiness to commence operations whenever time and the state of the plants enable you to begin. As a matter of course, where valuable plants are kept, a stock of the various kinds of soil should always be in readiness; good sandy yellow loam, peat, sharp sand, rotten leaves, and dry well-rotted cowdung, are all necessary ingredients in one form of compost or other. As it is not good practice to water heavily immediately after potting, see that the roots are rather more moist than dry when turned out for the purpose. Plants should likewise never be potted and cut back at the same time, but the heading-back should precede potting by a sufficient length of time to enable the plant to begin a fresh growth.

PITS AND FRAMES.

Make a hotbed for cuttings and seeds with fermented dung, well sweetened. Those who do not possess great accommodation and yet are expected to have the flower garden very gay in the summer and autumn months, may do a great deal with a small supply of fermenting material, by making a hotbed in the following manner:—Mark off the size of a single-light-box on the ground; fix a strong stake at each corner, the stakes to be 3 feet high at the back, and 2 feet in front; upon these make a platform of strong slabs; place the box upon it; form a lining of well-fermented dung all round except in front; then fill up the chamber below the platform with hot dung, make up the lining in front, and fill up the box to within 6 inches of the glass with dry leaf soil or old tan. It will be ready in a couple of days for the cuttings and seed-pans; when the heat declines open the front lining, clear out the chamber, and fill it again as before. Make a sowing of Phlox Drummondii, and place it in the hotbed, also Ten-week Stocks, Asters, and other hardy annuals for early blooming. Put in cuttings of Fuchsias for planting-out in June. Shift Petunias and Verbenas into large pots; placed in the hotbed-frame they will produce a succession of cuttings for the next two months. Any new or scarce plants of which your stock may

be limited had better be placed in heat to produce cuttings for propagation. Keep the stock well ventilated whenever the weather will permit, and the surface soil of the pots frequently stirred. Dust with sulphur Verbenas and similar plants attacked with mildew. Endeavour to keep the interior of these structures as dry as possible.

W. KEANE.

DOINGS OF THE LAST WEEK.

KITCHEN GARDEN.

ALMOST entirely the same as last week. Turned over the ground as opportunity offered, gave abundance of air to Cauliflowers, Lettuces, Radishes, &c., and stirred the ground a little with a pointed stick. Poisoned and trapped mice which had shown their skill on Peas and in nipping out the centre of young Cauliflower plants. Trapped also two or three rats which have again begun to make their appearance. Those trapped, poor things! had been allowed to pine to death before being found, or we would have made one the scapegoat to frighten off the rest of the fraternity. A number of years ago the rats grievously perplexed us. They attacked the Grapes and pulled off hundreds of Peaches, when these were as hard almost as flints, just securely stoned. One was trapped by the leg at last and only slightly injured. He was singed with a little lighted straw and then daubed in several places with coal tar, and let off outside the gardens; and for a number of years, though near the farm, we never saw a trace of a rat in the garden.

Commenced collecting a lot of tree leaves now that shooting game is over. They come in for many purposes, from fermenting heaps on to leaf mould; but on the whole, if regarded only in the light of manure, they would be a very expensive material, if all the trouble of raking and carting were duly considered. When taken half-rotted to the kitchen garden, if they do not produce monstrous vegetables in size, they generally afford those that are sweet and well-tasted. When used for heating purposes, unless well fermented, they are almost sure to give you a harvest of small slugs. Even when used alone it is a good thing to have them previously heated, by placing them over and inside of a heap of hot fermenting dung.

Lately we have been rather troubled with large adder-like snails and slugs of various sizes on the Mushroom-beds. Some fine specimens, as large as the pretence for hats which our smart young ladies now wear, had the membranous part nicely scooped out, and others were half eaten, whilst even clusters of buttons did not escape being nibbled. We generally have less or more of them about this season every year. We hardly know how they come, whether in the earth for Rhubarb or Sea-kale, or in the soil used for later beds, or from the droppings of horses, which in winter are sometimes used for a top-casing after spawning, without being at all heated previously, which we think no bad plan for good Mushrooms, though we are rather doubtful if the enemy are not thus introduced. They might be either killed or driven off by a good heat, though that, too, would drive off some of the most nourishing properties of the manure. Come how they may, when there they must be got rid of by enticing them to congregate together by greased cabbage or lettuce leaves, or small heaps of brewers' grains, and then picking them up at night; or taking a lantern before bedtime and carefully examining the beds, walls, &c., and picking up all that can be seen, large and small. We know of no method of killing them in the beds that would not also hurt the Mushrooms. Not one will be seen during the day.

FRUIT GARDEN.

This slug pest has also annoyed us with some Black Prince Strawberries just as they begin to colour. The plants are at the back of a narrow pit, and there is a narrow deep path at the back; and thinking that they must have concealed themselves in the crevices of the path, we threw some salt along it, and have seen no marks since. The pots are set on a thin layer of moss, and we were a little doubtful of that, though we could find no traces of the enemy there. To make sure, however, when moss is thus used, or where layers of turf are employed, as alluded to last year, it would be well to place the moss or the turf in a barrel, and soak with lime water as hot as it could be used.

A friend of ours has suffered this season greatly from crickets. They have pretty well cleared off the young shoots of his Vines; and in some gardens they are becoming a perfect pest. Crickets on the hearth indeed! it would be well if they stayed there. Much as they like heat, keeping a house cold, or even exposed, will not send them away if there are other places to which they can betake themselves and be warm. We have noticed two modes successful for keeping them down, if not wholly extirpating them. The first is cutting bread into thin slices, spreading a little butter on one piece, powdering it with arsenic, putting the two slices together, and then breaking them into pieces, and placing these in the driest and warmest places. We have been assured that when examined by a light at night not only would the crickets be seen eating the baits, but the lively and active ones would also be seen, cannibal fashion, attacking and eating the sickly and the dying. The other mode was sinking a bell-glass level with the earth, &c., of the bed, and filling the glass nearly half full with treacle and water. Whenever the cricket got amongst the treacle he was done for. We also noticed an improvement on this: A small straw that went nearly half across the width of the glass was fastened by a pebble close to the outside. It was then bent repeatedly over the rim of the glass so as to form a sort of flexible hinge. A little treacle was stuck on the end of the stem. Whilst Mr. Cricket marches along to get at it, his weight brings down the straw and he is precipitated into the liquid, the straw rising again ready for another adventurer. It is only of late years that this new enemy has begun to be troublesome, and any better mode for destroying crickets or keeping them out of hothouses would be very acceptable to many.

Noticing in the orchard-house some of the black and brown beetles that gave us such annoyance last year, we chose a damp dull day, put a cloth along the top of the house, and, as we had been cutting plenty of Laurels, had a lot of leaves and shoots roughly bruised—pretty well a barrowload—and used them for smoking the houses, taking care, however, that no flame was seen. The engine was used at the same time outside over the glass, the water helping to fill up the laps of the open glazing. Next morning we could find none alive, though they seemed through a glass to be fat and plump. Unfortunately, next day was sunny, so we were obliged to give air; but the sun shrivelled all the insects we could see into seemingly as much powder. If tobacco, some two or three pounds, had cost as little as the prunings of Laurels, we would most likely have preferred it, as giving less trouble. We should like to give another smoking before washing and painting, as smoke penetrates everywhere, even the surface soil and holes in walls, &c., which the best and most careful washing might miss.

For Peaches in bloom, coming into bloom, Grapes breaking, &c., see last week. Went over the late Grapes, picking out a few berries. The heat necessary to keep out frost in the late severe weather has done them no good, the air being rather dry, which will prevent them keeping so long as they otherwise would.

ORNAMENTAL DEPARTMENT.

Proceeded with pruning, clearing, propagating, potting, &c., much the same as last week. Removed the last of the Chrysanthemums from the conservatory, fresh arranged it, bringing in Geraniums and Cinerarias showing flower-stems strongly from cold pit. These were kept in an earth pit with sashes merely laid across without rafters. A few plants close to the front were injured by the late frosts, but only a very few. The rest were all right. They were covered up about a week. Epacris and other hardwooded plants were placed in the conservatory, so as to have plenty of air and light, but so that the air should not beat on them at once in frosty weather. Tried the ring of pots frequently with the knuckles before watering them, as over-watering is every way bad at this season. In frosty nights it is better to keep the house merely safe instead of at a high temperature, as the more heat the more dry will the air become. When such artificial heat raises the enclosed atmosphere above from 40° to 45° in cold frosty weather, then moisture must be communicated to the atmosphere in proportion. When not more than the degrees above specified, the floor and the pots will generally yield enough of atmospheric moisture. When there is too much of invisible vapour it is

apt to be condensed against the glass, and drop upon and disfigure the blooms of Camellias, Rhododendrons, &c. Removed from the conservatory also a lot of young plants of *Cassia corymbosa* which were struck last summer, and hitherto have bloomed in the conservatory. Did we want a gorgeous large orange bed from August to November, we would keep these plants cool until May, and then plant them out. They are always very fine with us when so planted out. It would be difficult to get them early out of doors, except in sheltered places, as the wind would be apt to tear the young growths to pieces. We find the plants stand our exposed places best when kept as hardy as possible beforehand.

AIR-GIVING AND REMOVING.

Some readers wish for more definite particulars on this subject, but we would only repeat what has been largely treated upon in previous volumes. Perhaps it would be as well to give a few examples. Here is a cold pit full of *Calceolarias*, *Geraniums*, *Verbenas*, &c. It will hardly be safe to leave that pit uncovered any night in this changeable weather. In mild mornings take off the covering early, and if the outside temperature is near 40° give air before breakfast; and if it continues so, and there are no signs of frost, take away the air about three or four o'clock. If a frosty morning, give a little air at the back only after the sun tells upon the pit. If there are signs of a keen frosty night, take away the air early in the afternoon, and cover-up also earlier. If there is a likelihood of a continuous frost and dull black days, make sure that the inside temperature has fallen to from 35° to 38°, and then if you shut-up for several days no harm will ensue.

In a common greenhouse the same rules will hold in mild weather; but in frosty weather give air later, except a little at the top of the house to arrest dripping, and take away what air is on by two o'clock, so as, if possible, to shut in some sun heat. Provided the average heat of that house at night is 40° to 45°, the plants will take no harm if the heat should rise to 60° or 70° with sun heat. Fires should be put on to catch the falling temperature about 45°, and if the frost is severe the temperature had better fall to 40° or 37°, in preference to using very strong fires. The same rules will apply to forcing-houses. For instance: here is a Peach-house pretty well in bloom, average night temperature 45°. In dull days it would be well to have the heat up to 50° and 55°, with air on. In a bright day, with frosty air, provided a little air is given early, the temperature from sun heat may range from 70° to 85°. A bright sun on a house with a steep roof, and no air given, would soon settle all further trouble with the blossoms. The gradual rise with a little air does good rather than harm, and the high temperature is better every way, if from sun heat alone, than admitting great blasts of dry frosty air. We lay an emphasis on the above word alone, for the careful furnaceman will do little with fire heat in a morning when he expects the sun to come out. By the time the sun tells much on the house, the heating medium should be rather cool. Such a house if shut up at 70° at two o'clock in a clear, frosty day, will rise perhaps a few degrees, but it will gradually fall to 45°, by which time the heat from the furnace should begin to tell and meet the frost.

HEATING.

The other week, when speaking of an iron stove in an orchard-house, we stated then what we thought to be the fact—that the frost had been kept out. We have found that this was not quite correct, as a few boxes of cuttings, and some pots of cuttings, near the front of the house were injured. The front is about 3½ feet in height, and consists of glass and one-inch deal boards, and not very close together. All the *Geraniums*, 7½ feet from the back wall, were safe. This matter is alluded to more largely in reply to a correspondent.

Several inquiries have been sent us as to the most economical modes of heating by hot water, the best boilers, &c. Our reply to the last is, that almost all the boilers in use are best, if well set, and well worked. To save the heat that must escape from all boilers, the best plan is to have a fine through part of a house, and a damper to throw back the heat on the boiler as desired. There is no boiler that will absorb all the heat from the fire, much must pass away

through the smoke-shaft. Hence, in this respect, one boiler is more economical than several. Where there is not a flue, the getting the most heat to act on the boiler depends on the setting, and the careful attention of the stoker to his damper and his ashpit-door, as fully detailed some time ago.—R. F.

COVENT GARDEN MARKET.—JAN. 30.

The supply of all kinds of fruit and vegetables in season continues good. Pines and hothouse Grapes are sufficient for the demand, and though the latter are more limited in quantity, the advance in price has restricted purchases. Of Potatoes, better samples, especially of York Regents, have come in since our last report. Turnip-tops, Broccoli Sprouts, and all kinds of coarse Greens are plentiful. Cut flowers consist for the most part of Camellias, Pelargoniums, Chinese Primulas, Roses, Violets, Mignonette, Wallflowers, Van Thol Tulips, Snowdrops, and other bulbs.

FRUIT.

	s.	d.	s.	d.		s.	d.	s.	d.
Apples.....	1	0	4	0	Mulberries.....	0	10	0	0
Apricots.....	0	0	0	0	Nectarines.....	0	0	0	0
Figs.....	0	0	0	0	Oranges.....	1	0	10	0
Figs & Nuts 100 lbs.	0	0	0	0	Peaches.....	0	0	0	0
Grapes, Hothouse.....	8	0	12	0	Pears.....	8	0	12	0
Foreign.....	1	0	2	0	dessert.....	6	0	10	0
Muscats.....	6	0	10	0	Pine Apples.....	5	0	8	0
Lemons.....	6	0	10	0	Pomegranates.....	0	0	0	0
Melons.....	3	0	5	0	Walnuts.....	14	0	20	0

VEGETABLES.

	s.	d.	s.	d.		s.	d.	s.	d.
Asparagus.....	8	0	12	0	Leeks.....	9	4	10	0
Beans, Broad.....	0	0	0	0	Lettuce.....	1	0	2	0
Kidney.....	3	6	5	0	Mushrooms.....	1	0	1	6
Beet, Red.....	1	0	1	6	Mustd. & Cress, punnet	0	2	0	6
Broccoli.....	0	2	2	0	Onions.....	2	0	4	0
Brussels Sprouts, sieve	1	6	2	6	pickling.....	0	6	0	8
Cabbage.....	0	0	0	0	Parsley.....	4	9	6	0
Capsicums.....	1	0	0	0	Parsnips.....	0	2	1	6
Carrots.....	0	6	0	8	Peas.....	0	0	0	0
Cauliflower.....	3	0	6	0	Potatoes.....	5	0	8	0
Celery.....	1	6	2	0	sack.....	1	6	2	0
Cucumbers.....	2	0	5	0	Radishes doz. bunches	1	0	0	0
Endive.....	1	3	2	6	Rhubarb.....	1	0	0	0
Fennel.....	0	3	0	0	Savoy's.....	1	6	2	0
Garlic and Shallots, lb.	0	8	0	0	Sea-kale.....	1	0	2	0
Herbs.....	0	3	0	0	Spinach.....	2	0	4	0
Horseradish.....	1	6	4	0	Tomat'es.....	3	0	4	0
					Turnips.....	9	4	0	0

TRADE CATALOGUES RECEIVED.

R. Parker, Exotic Nursery, Tooting. *Catalogue of Agricultural, Flower, and Vegetable Seeds, Fruit Trees, &c.*
 Henry N. Bransby, Corn Market and High Street, Alton. *Spring Catalogue of Select Vegetable and Flower Seeds.*

TO CORRESPONDENTS.

** We request that no one will write privately to the departmental writers of the "Journal of Horticulture, Cottage Gardener, and Country Gentleman." By so doing they are subjected to unjustifiable trouble and expense. All communications should therefore be addressed solely to The Editors of the Journal of Horticulture, &c., 162, Fleet Street, London, E.C.

We also request that correspondents will not mix up on the same sheet questions relating to Gardening and those on Poultry and Bee subjects, if they expect to get them answered promptly and conveniently, but write them on separate communications. Also never to send more than two or three questions at once.

N.B.—Many questions must remain unanswered until next week.

PLANT FOR CENTRE OF PLANT CASE (Dublin).—We have not found any better plant for a plant case than a large *Draecena terminalis*. The *Schimmia japonica* has leaves as fine as an Orange when well grown, and is not more liable to become blotched than a Camellia. A confined atmosphere does not suit it, and wind and strong sun—the one heating the leaves and the other scorching them—very often give the plants the poor green and blotched appearance you complain of.

POTTING ROOTED CUTTINGS OF SCARLET AND VARIEGATED GERANIUMS (B. T. M.).—If you have had your plants in a growing heat of 50°, and after potting them have kept them some time in a stove, they will require hardening-off to the greenhouse temperature very gradually, and by all means avoid giving too much water. By continuing to grow them on in warmth you may obtain a batch of cuttings in March, which will increase your stock, and still have fine plants left. You can do no harm by keeping your plants warm and in a growing condition, provided that they receive no sudden check. Most people keep their Geraniums as cool as possible in winter more from necessity than choice, not having accommodation to grow them on.

CAMELLIA LEAVES FALLING (A Glasgow Subscriber).—Evergreen trees of all kinds cast their leaves annually, and of these the Camellia is one; but it is only the oldest that fall from the latter, for it will retain its leaves for several years in good health—very commonly for a period of six years. Pruning your plants have only thrown off the old leaves, and are making ample new growth, we see no cause for alarm. The temperature you placed them in is at least 15° too high, and this would cause the old leaves to fall, for the roots would send up more crude sap than they could digest, and they would consequently drop. A temperature of from 45° to 50° at night is quite high enough for the Camellia to form new wood perfectly, and if the wood is made slowly a profusion of buds is more certain than when the growths are formed hastily in a stove heat. Imperfect drainage and a consequently sour condition of the soil, because it destroys the roots, will cause the leaves to be cast prematurely. Watering a plant in a stove with water little above freezing will also produce the same result.

CUTTING BACK CAMELLIAS (J. M. G.).—There is no better time to cut back Camellias than just when they are going out of bloom, and before the growth of the season begins; but we would not advise you to cut them in severely. A Camellia generally requires no training, and merely cutting in any lanky growth is all that is advisable. You will be best able to ascertain if your plants want potting by examining the balls. If the roots be closely matted round the pot they are assuredly in want of more room, and it sometimes happens that the soil that is not so occupied becomes sour with repeated waterings, and consequently requires to be exchanged for fresh. We would only advise liquid manure in a weak and perfectly clear state for your Camellias when in a growing state, as hardwooded plants require less of this stimulant than herbaceous ones. The best soil we know of for Camellias is light sandy soil impregnated with iron. Where such exists naturally no artificial mixture can equal it for general utility.

DOUBLE GLOXINIAS (Rev. A. F.).—We know of no reason why Gloxinia flowers should not be obtained double, for other campanulid corollas are so transformed. The accompanying is the commencement of such a change, and is the portrait of one of several similar flowers exhibited before the Floral Committee of the Royal Horticultural Society. We agree with the Committee in thinking it no improvement to the flower.

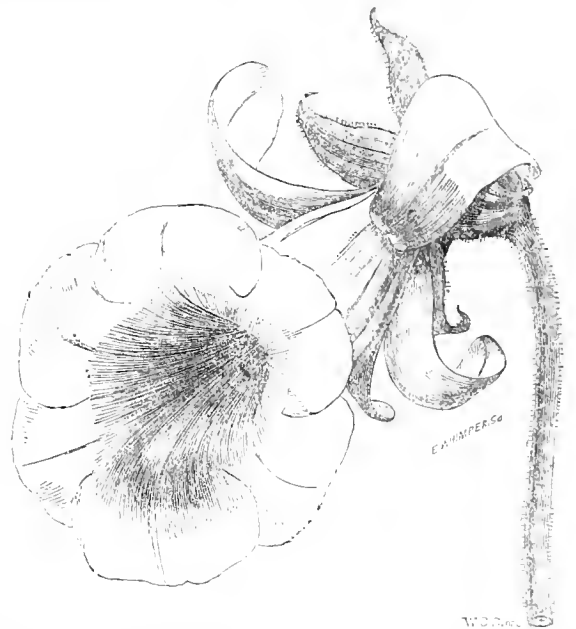

LILACS NOT FLOWERING (E. M. S.).—We fear the situation your plants are in must be an unfavourable one indeed, as the plant accommodates itself to most positions, and generally speaking receives no further treatment than cutting back any portion that overtops or interferes with neighbouring shrubs. It invariably flowers in seasons when other deciduous shrubs and trees do so; but in such a year as 1861, when few or no flower-buds had been set the year before on account of the wet sunless weather, the blooms were comparatively few, and as you say the sun never shines on your trees the misery is at once told. We fear under such circumstances that no treatment you can give your plants will insure their flowering; but if you can remove anything that overhangs them so as to give them their due share of sunshine, you will have flowers. If not, you had better encourage the growth of evergreens or such other shrubs as join them and look better.

PLUM TREE AGAINST THE SOUTH-EAST WALL OF A HOUSE (J. C.).—If the situation be free from stagnant water we know not really why a Plum tree should not grow and do well against such a wall, even if the surface of the ground is made hard for a yard or pathway. If the natural soil is moderately good and drainage perfect, we do not think that flat paving-stones are wanted below the roots, excepting, perhaps, that one immediately underneath the collar may prevent tip-rot's descending there. If, however, the subsoil is unkind we would advise 6 inches of rubble, stone, or something of that kind in the bottom of the hole, which might be of a sort of horseshoe shape, and about 8 or 9 feet over; and with 6 inches of drainage materials at bottom, about 18 inches of soil for the trees to grow in will be sufficient. If the situation is damp a rather light stony soil may be used, but if dry, one somewhat stiffer. It would be better if the soil overlying the roots could be kept loose and in tillage for one year, so as to thoroughly sweeten it. Afterwards it may be trodden as hard as you like, taking care, however, that this is first done in dry weather.

ORNAMENTAL GRASSES (A. Y.).—The following twenty are about 2 feet high and less. We have not named any of the taller species. *Eglops cylindrica*; *Agrostis dulcis*, *nebulosa*, *plumosa*; *Briza major*; *Bromus briziformis*; *Chrysurus aureus*; *Coix lachryma*; *Eleusine oligostachya*; *Elymus caput-Meduse*; *Eragrostis elegans* (Love Grass); *Hordeum jubatum*; *Lagurus ovatus*; *Panicum concinnum*; *Paspalum elegans*; *Pennisetum longistylum*; *Setaria macrochaeta*; *Stipa capillata*, *penata* (Feather Grass); *Tripsacum dactyloides*.

CROCUS NOT FLOWERING (Wyeside).—There are so many sorts of Crocuses that we really cannot guess which it is that you refer to. The Crocus likes a light, rich, deep soil, and from the data given by you it would be difficult to surmise why it has ceased to bloom. Do not cut the foliage off it till it decays naturally, for if you do the bulbs will become weak and less likely to flower. Try what a little rich top-dressing will do for it.

DEAD PIGS BURIED IN VINE-BORDER (A. B. C.).—The reading of your letter has made us quite galling. Twenty-nine pigs from 6 to 10 stone weight buried in a vine-border within 3 feet of where Vines were planted last spring!!! Done wrong? Yes, most decidedly. Out with them all at once, or your Vines will suffer for it. Nothing can be more opposed to the nature and requirements of the Vine than carrion of any sort. We do not envy the person who is to be resurrectionist. Let the stinking mass be entirely removed and the place filled up with proper Vine-border compost, and never listen to any one who recommends dead animals to be put into a Vine-border. How any one can suppose that the roots of Vines can make use of such filth is a mystery to us.

FUCHSIAS — PELARGONIUMS — VERBENAS (A. Novice, Middlesborough-on-Tees).—*Six Fuchsias*: Guiding Star, Prince of Orange, Queen of Hanover, Souvenir de Chiswick, Minnie Banks, Comet. *Six Fancy Pelargoniums*: Acme, Arabella Goddard, Cloth of Silver, Madame Stanton Dolby, Sarah Turner, Celestial. *Six Verbenas*: Géant des Batailles, L'Avenir de Balleut, General Simpson, Fairness of the Fair, Il Trovatore, Madame Maltras.

FRUITING VINES IN POTS IN A GREENHOUSE (Wyeside).—We do not think you will obtain a double quantity of Grapes, or anything like it, by the arrangement you describe. You would obtain better Grapes and more of them by making a border to your greenhouse and planting out the Vines for a permanency. Moreover, you would do this with far less trouble than with two sets, or even one set, in pots. The arrangement we have recommended is quite compatible with making the house a wintering place for bedding plants. There is plenty of time to ripen the Grapes you name after May. The best time to apply fire heat to assist them is when the weather is cold and dull, and when the Grapes are colouring and ripening. The Vines would winter behind a wall as you propose, and you could easily protect them from frost with but little covering. The principal danger will be in spring, when the sap begins to flow, and Vines are then most susceptible of injury from frost. Vines in the Crimea and on the shores of the Caspian are ripened under a hotter sun than here, and consequently are better able to withstand frost than those ripened in a cool vineery. We do not think you will be able to ripen your resting set of Vines well by the method you propose. You might do so against a hot wall or in your orchard-house; but we do not recommend the arrangement you propose, and are certain you would get better fruit, and more of it at less cost, by making a border to your house and planting the Vines out.

BOILER (A. Constant Reader).—No advice was asked in your last note—you only praised, in no measured terms, your newly-invented boiler. We do not want a model; but if a drawing of the boiler reaches us, we shall give our opinion, favourable or unfavourable, without any reserve.

WEeping WALNUT TREES (G. Allsop).—You had better write to some leading nurseryman. The hook you mention is not a safe guide.

METRODIEROS FLORIBUNDA AND CORONILLA GLAUCA (Claude).—They are very hardy greenhouse plants, and ought to have done well in a temperature not under 40°. The losing of the leaves and flowers is a mystery to us. Perhaps an unhealthy atmosphere from something on the heating-pipes, an escape from a fine, stagnant moisture, or too great a degree of dryness is the cause. A little extra heat may cause the plants to break fresh; but we would not bury them, but give the increase gradually. Did the frost get at them in the severe weather? The Marie Louise Pear will do in the greenhouse against the wall provided you place no plants in front to shade it. Give plenty of air, and no more artificial heat in winter than will just keep out frost. Why not try the Peach?

CINERARIAS BLIND (P. Dixon).—Unless the plants have met with some great misfortune, we should say that you will have flowers if you wait for them. Perhaps you have given them too large pots. For winter and spring-flowering it is as well that the plants are not above 6 or 7 inches in diameter. We except from this rule those plants that were grown strong in autumn, shifted into large pots by the beginning of September, and had the pots like a cheesecake with roots before the first ten days in October. These would throw up strong and large heads, but for younger plants small pots are best in winter.

PROPOSED BOILER (F. D.).—Even with your present upright cylindrical boiler you will obtain most of the heat from the fuel by carrying the flue through or round the house, and, if the heat be too dry, use evaporating-pans of water in the mode you most approve of yourself. Even in that case it would be advisable to have a damper in the flue near the boiler, in order by that and the ash-pit door to regulate the draught in the flue, and concentrate the heat more about the boiler. We have known such upright boilers to do very well; but we prefer them of the sugar-loaf conical form, something similar to what you have shown by your inner lines, but then we would have the outside to resemble the inside in shape. By your proposed plan, with perpendicular outsides and conical-shaped inside, you obtain what we consider two great drawbacks—a great body of water at the top of the wedge-shape just opposite the flow-pipe, and no water at all at the sharp end of the wedge-shape, where the boiler would rest on the fire-bars. This with strong fires would soon cause the bottom to be burned out. We have known boilers require ever so many fresh sets of grate-bars, and the boiler would burn out as well as the bars but for the water inside. You should have given us the reference to Mr. Pierce's plan.

STEMS OF SEED CLOVER (B. H. W.).—We never but once knew these used for any other purpose than littering cattle. The exception was when fodder was very scarce, and the stems were then cut up in making chaff.

MELBOURNE HERO POTATO (G. A.).—We do not know where this can be obtained.

SPRING CUTTINGS OF GERANIUMS (Agnès).—If your young Geraniums are so leggy and you wish to increase them, the sooner you top them and put the cuttings in the better. This will cause the plants cut down to come stocky, and enable the shoots to be strong before planting out. The larger the cutting, other things being equal, the larger will the young plant be, and therefore the more show will it make out of doors when planted out. The larger the cutting the less nursing and growing will the plants need after being struck. Six inches is a good size for a spring cutting. We often make them of 1½ inch when we want to increase the stock; in fact, every joint with a bud at the base of the leaf may be made into a cutting. But these require more nursing to get them of a good size, and great care to prevent them damping. We have made spring cuttings of Golden Chain very small indeed; but if you have not had much experience you had better not have the cuttings less than from 2 to 3 inches long. As to the heat, that must be as you can get it. All these now will strike quickest if placed in bottom heat and the top of the cuttings exposed, with no covering except the glass sash, and if the cuttings are 18 inches from the glass they will need little shading. With plenty of light these Scarlet Geraniums will stand any amount of heat, when striking and when growing too—say 80° bottom heat and from 60° to 75° top heat. They will not draw and become lanky from mere heat, like the Pelargonium tribe, provided they have plenty of light and air. Of course, when your variegated Geraniums are striking, you will need scarcely any air during the day, and if a skiff from the syringe in a very bright day will prevent flagging, that is better than shading. A little air should be given at night, however, unless when very frosty. When struck, pot off and grow on in heat, for if you wish these spring-struck to be equal to the autumn-struck, you must get them a good size and then harden them off before planting them out, and be sure they are well watered before planting. The plants cut back will break all the sooner and make fine plants sooner if they have a temperature of from 60° at night to 70° and more during the day. The straggling Tom Thumb will make fine plants for the greenhouse so treated. For cuttings see last week's "Doings of the Week."

BACK NUMBER (W. Cardiff).—If you send four postage stamps with your address you can have No. 52 free by post.

PLANTS TO SCREEN A LOW WALL (A Subscriber).—As you only want about thirty plants, and desire as much variety as possible, you might have in your back row one common and one Portugal Laurel, and the same of Laurustinus, Green Holly, Common Yew, Ligustrum sinense, Arbutus, Alaternus, and Phillyrea, with purple and white Lilacs, Ribes sanguineum, a Laburnum, and one or two pillar Roses. In the front plant Cotoneaster microphylla, Berberis japonica and B. aquifolia, Aucuba japonica, Gold and Silver-edged Holly, the Fan Yew, two or three kinds of Rhododendrons, common and Majorca Box, and Griselinia littoralis as evergreens; and Deutzia scabra, Forsythia viridissima, and Weigela rosea as deciduous, with a few Roses. If the roots of your shrubs find their way into the vegetable border they may be stopped by cutting a narrow ditch or drain as deep as they descend, and filling this up with a sort of rough concrete well rammed in. We have slant out the roots of large trees from flower-beds by this plan, and recommend it to you.

NAMES OF PLANTS (G. Dieker).—It is *Physalis alkekengi*, or common Winter Cherry.

POULTRY, BEE, and HOUSEHOLD CHRONICLE.

PRIVATE MARKS ON FOWLS, AND THE RULE AS TO OWNERSHIP.

THE question of disqualifying fowls exhibited with private marks, which Mr. Hewitt has suggested in your Journal, is certainly deserving of consideration. As far as the Judges are concerned I have no doubt these marks are a positive nuisance; for, although in the great majority of instances they have not the slightest influence on the decisions, yet in some cases they afford a pretext for complaint, which disappointment is only too willing to lay hold of. The real obstacle to their abolition will be the reluctance of exhibitors to give up the means of identifying their birds; and most of us must have heard of cases where, by the aid of private marks, fowls misplaced or stolen at exhibitions have been recovered by the owners.

There are various modes of marking fowls. Perhaps the most frequent, especially in the Game classes, is a slit or cut in the nostril. So common is this method that it can hardly be considered a distinctive mark. There may be subtle distinctions in the outline of the cut, as Mr. Hewitt asserts, although I cannot remember that I ever noticed such to be the case.

To disqualify for visible marks alone would be an inadequate measure, for on the assumption that a Judge is base enough to act from collusion or a corrupt motive, a secret mark concealed by the fowlers would be infinitely more dangerous than a visible one. If, therefore, a rule is introduced on this point, let it be both comprehensive and stringent, extending to all private marks wherever they can be detected. It is true they might often exist without being discovered, but the knowledge that discovery would inevitably lead to disqualification, might at last induce exhibitors to abandon them altogether.

Should the committees of poultry shows be disposed to adopt such a rule as Mr. Hewitt suggests, there are several

difficulties which they will have to encounter. In the first place, it is not so easy as at first sight it may appear, to define a private mark, as it might easily be made so as to present the appearance of accident rather than design. Secondly, the practice of marking fowls has become so exceedingly common, that the sudden adoption of a disqualifying rule would, at least in the Game classes, almost amount to a degree of confiscation; and committees, if at all tender-hearted, will not forget the advice of old Izaak Walton, who, instructing a disciple in the "gentle craft" how best to impale a living frog on the hook, expressed a wish that the operation should be performed "as mercifully as may be." Assuming, however, that all difficulties can be surmounted, I think it will be generally acknowledged that Mr. Hewitt's suggestion is a valuable one.

As I have my pen in my hand, perhaps your correspondent who writes under the *nomine umbra* of "EGOMET" will excuse me if I take the liberty of pointing out, what appears to me, a misconception in his reply to Mr. Williams. He seems to assume that the exhibition of fowls is unjustifiable, unless they are the absolute and *bona fide* property of the person by whom they are exhibited. If I am not greatly mistaken, the rule as to ownership has been rescinded long ago, on the ground that practically it was found to handicap the scrupulous for the benefit of the unscrupulous exhibitor. At any rate the practice of hiring or borrowing birds for exhibition is, I believe, quite notorious; and if "EGOMET" stigmatises as unscrupulous all exhibitors who are not the absolute owners of the birds which are shown in their names, he is casting his net very wide, and would, I imagine, be astonished at the magnitude of some of the fishes included in his haul.

I am reluctant to revert to the exhausted subject of the Birmingham disqualified pens, but the allusion to the letter of Mr. Williams tempts me to a short reference to its bearings on the original charges or insinuations against Mr. Hindson. These insinuations were rather destitute of meaning, or they amounted to this—that the birds exhibited by Mr. Williams had been sent to Birmingham with Mr. Hindson's knowledge and consent, and that they had been exhibited in the name of a person under Mr. Hindson's control. To these charges, I replied that Mr. Hindson's conduct was entirely inconsistent with the imputation they conveyed. With me this conviction has never been shaken, and if there are any who still have a doubt on the subject, I would ask them to read the letter of Mr. Williams published in your Journal last week. Whatever opinion may be formed on the question of ownership, the strong assertions by Mr. Williams that the birds are his own, and the tone of hostility to Mr. Hindson which pervades his letter, most strengthen the conclusion, that whether it was justifiable or not in Mr. Williams to send these birds to Birmingham, Mr. Hindson had no knowledge, influence, or control in the matter. In fact, this charge, deficient in vitality from the first, has now, I think, totally collapsed; and as I was, unfortunately, present at its birth, allow me to assist at its funeral obsequies, and affix by way of epitaph on its coffin, "*Parturiunt montes, nascitur ridiculus mus.*"—J. H. SMITH.

WHY DOES A PIGEON TUMBLE?

In a former notice of new varieties of Pigeons, I adverted to the propensity of some breeds to tumble or turn somersaults, and asked if any one of my readers could give any description of the Lowtan or Ground Tumblers of India. I then proposed to offer a few remarks on what I believe to be the cause of a Pigeon's tumbling, and I shall now endeavour to fulfil that engagement.

It may have been noticed by many, that Pigeons when sporting in the air often beat their wings together in a joyous or excited manner, and rock themselves, as it were, up and down by the force of their strokes. This seems to be done in playfulness, in the exuberance of their happy life, and in course of time those being selected and bred from that moved their bodies most, a breed was established that turned quite over, or Tumbling Pigeons. This was my first opinion, and I believed that Tumbler Pigeons threw somersaults for their own satisfaction; however, since I have become possessed of a breed of extraordinary Tumblers, I

have seen reasons for thinking that they at least do not do so for the fun of the thing, but rather because they cannot help it. For instance: I have many birds that tumble so often, and sometimes so consecutively, making from ten to thirty somersaults a-minute, that they quite tire themselves, and are obliged to settle from exhaustion, and when the fit comes on they seem quite unable to stop. These are called Air Tumblers, because they tumble in the air, and are valued according to the regularity of their tumbling, each back spring being separate and distinct. The highest number I have had a Pigeon perform was forty-five clear somersaults in a minute; he was a large white cock with dark eyes.

Some Pigeons tumble within doors—that is, in flying from one part of the loft to another, or in attempting to rise from the ground: these are called House Tumblers, and I fancy the Indian Lowtan or Ground Tumbler must be something of this kind. If any one still supposes that a Pigeon can help tumbling, let him watch one of these birds attempting to fly up from the ground or floor when suddenly frightened; how it tumbles in the attempt within a few inches of the ground, and again tries two or three times, only to turn over each time when it attempts to follow its companions. When they have been on the ground, out of doors, and desirous of flying to the roof, I have frequently seen one rise about 2 feet, then throw a somersault, rise a little higher, and, perhaps, again go over, all the time trying its best to reach the roof; and often in the struggle between the endeavour to fly on and the propensity to tumble, its movement becomes retrograde, when at one time the propensity to tumble gains the ascendancy, and the struggling Pigeon is obliged to come down; while at another, the bird by a sudden exertion of will, overcomes the involuntary turning, and the Pigeon rather out of breath reaches the roof.

There is a third manner of tumbling called rolling; in this, the Pigeon throws several somersaults, or back springs, in succession and conjointly, thus falling considerably whilst flying, sometimes rolling till they touch the earth, and not unfrequently killing themselves. I had two young cocks which killed themselves on the spot in the past summer from this cause, and I have one that cannot come down from his perch except in a roll, and through this he often raps his head, the remembrance of which causes him to hesitate in coming down to feed. Of course he would not be safe to let out. He is a Kite, heavily feather-footed, and a large bird.

From these observations, I think it may reasonably be inferred that tumbling is not under the control of the Pigeon, that it is an involuntary act, and that excitement increases it—thus they tumble most during the pairing and breeding time, and if suddenly startled, are often unable to rise at once from the ground. It is probably owing to a want of proper balance between the parts of the brain, the involuntary getting the mastery of the voluntary, and thus, like a giddy person, they fall back, the movements being similar to the action of a bird that has its neck broken, which, in its death struggles, turns heels over head. These curious Tumbling Pigeons are evidently the effect of careful breeding and selecting for a long course of years, as a Pigeon in a wild state would soon come to grief if it tumbled much.—B. P. BRENT, *Dallington, near Robertsbridge, Sussex.*

THE GAME-CKOCK CASE.

On looking over the different papers, letters, justifications, and explanations that have appeared in your columns now for some weeks past, I am utterly at a loss to discover one single loophole that will throw a gleam of light on this very questionable transaction. All is mystery and obscurity; and you may rest assured, that were you to write till doomsday you would never arrive at the bottom of it, each succeeding attempted explanation rendering it more entangled and unintelligible. I think, therefore, you may well let the matter die and be decently buried out of sight, enough having been written and published to make all parties concerned heartily ashamed of themselves; and although no one has been convicted, it may yet have the good effect of deterring others from trying on the same dodge (to use a homely phrase) with impunity. No further good can be gained by keeping the

matter open; and harm is likely to arise by rendering exhibitors suspicious and dissatisfied, injuring the coming shows, and bringing into unnecessary and undeserved disrepute the poultry fancy generally.—Tom Trt.

FOUL BROOD.

DURING the heat of the foul-brood controversy, ere yet the "Calumet of Peace" had been puffed over it, I carefully abstained from expressing an opinion on either side, feeling convinced that such must necessarily be based more on theory than fact. Subsequent events, however, summoned me to come forward and take my place in the "witness-box," which occupation with other matters alone prevented me entering till now. Without further prelude I will proceed to give my evidence, or, in other words, detail something of foul brood as I have found it.

My long-looked-for Ligurian stock arrived at last in the middle of April, but I was sorely disappointed to find on examination, that instead of being, as I had fondly hoped, from the earlier and salubrious climate from which it came, at least a month in advance of my own, and full of bees with a good sprinkling of drones, it was by far the weakest, having not a tithe of the inmates of even my poorest hive, and what appeared to me—both novel and unaccountable—a vast amount of sealed brood quite in advance of the population. I of course duly remonstrated with "A DEVONSHIRE BEE-KEEPER" as to my bad bargain, but he told me it was as good as he could send, and advised me to strengthen forthwith with brood-frames from my strong black colonies. To work I went, weakening the blacks by robbing them of their best-filled brood-frames, only to find on next examination that the yellows had receded into yet smaller proportions. Finding my attempts to strengthen with brood useless, I next bethought me of introducing in abundance the adult element; but any strengthening from my own apiary could avail nothing, as the bees would only return to their old stance. Most opportunely a friend sought my advice as to how he could remove two hives from his old to his new residence, only about a gun-shot apart, without weakening his hives by losing the bees. This was an enigma which at that season he could not well solve, but which I arranged to our mutual satisfaction by proposing to exchange a Stewarton and a square-frame hive of mine for his two straw hives. As his residence was between two and three miles distant from mine, the exchange was effected without loss of bees to either. His best hive, well stored with brood, worker as well as drones, I at once broke up, setting the combs into a frame-hive, and I subsequently removed the queen, and then by a mode of union I had never before attempted, although recommended in this Journal, and to which I may again possibly advert in some notes on the season, I added all to the Ligurian stock. The sequel was the massacre of every unfortunate yellow-jacket and very rough handling to their queen, from which I saved her again and again, finding her always equally obnoxious to the blacks, till at last she expired in my hand.

A report of this sad catastrophe was duly transmitted to Devonshire, when Mr. Woodbury kindly proposed my sending him a black stock to be Ligurianised. This was accordingly done. The dwindling process meantime went on steadily, till the beginning of June found me at the miserable zero of one stock, and that but a sugar-fed "beat-out" of the end of last season. How I nursed this my sole survivor into seven may also be adverted to again. My next communication from Devonshire was, that my unfortunate black stock was on its way back not Ligurianised, but foulbroodised,* my friend having at last discovered the clue to all his misfortunes, as subsequently detailed in these pages. I was to burn bees, combs, frames, and slides, and coat the box with chloride of lime. Here was certainly rather a rough remedy; it struck me at the time if doomed, why not

* The stock in question was "foulbroodised" before it reached me, owing, doubtless, to its containing some combs taken from the unfortunate Ligurians. It was also queenless; and the royal cells it contained being all abortive from foul brood, I supplied it with a black queen and returned it, not liking to perform the unthankful office of executioner on my friend's bees, and fancying also, what turned out to be the case, that he might feel inclined to give them a chance of recovery, if such a thing had been possible.—A DEVONSHIRE BEE-KEEPER.

light the fatal match in Devon? Was my good friend going to add the refined torture to my misfortunes, of compelling me, as it were, who had never tolerated the hated brimstone fumes near my apiary, or ever wilfully deprived a bee of its life, to thus become the executioner of a whole colony of my favourites? Oh no! while there's life there's hope, thought I; so stopping the hive *in transitu*, I had it dispatched as a gift to a party, at a safe distance from my own apiary, who had no bees but ample knowledge of their management. Its receipt afforded him much pleasure, and he had a firm determination to work out their thorough cure, for which purpose I supplied him with as many frames and empty combs as he required, and he was only too proud to find ample supplies of the finest sugar. Honey, too, abounded at the time; and he told me with no small exultation, that his stock carried in more pollen and seemed to prosper in advance of all hives in his neighbourhood.

Thanks to the capital season, and a large supply of empty comb, the 1st of August found my apiary all I could desire. In addition to the product of my "beat-out," as above mentioned, I had procured two hives, making in all nine most promising stocks. The evening of that day brought the climax of my prosperity—the receipt of a good strong Ligurian stock from Devonshire, accompanied by the opinion that I might yet propagate Ligurians. Nothing loth, to work I went at once on two very strong black stocks, hoping yet to make up for my many disappointments. The Ligurian stock wrought amazingly, the queen squaring off large masses of brood to my great delight. My two black hives, meantime, raised lots of royal cells; but to my no small disappointment no young queens emerged, and at last I cut them up, finding all abortive. Better luck next time! fresh Ligurian frames, then a period of anxious suspense with the like result. It was now too late for further efforts, and my black queens were safely reinstated. The yellow-jackets were ever active; but I need not now wait to detail their proceedings, as that may form matter for another paper; suffice it to say that those masses of sealed brood which were the delight of admiring friends—"so late in the season too"—were ever to me a source of fear and trembling. I consulted my Devon oracle. "Are the cell-covers flattened, with small perforations?" "Do they on examination contain thick brownish slimy stuff?" were queries I could only answer in the affirmative. In short my prized Ligurian colony was but a mass of putrifying corruption. The sequel of the story is, my beautiful Ligurian queen "winters in Devonshire," the monarch of a strong black stock, which, I am given to understand, pays her due homage; and for her old subjects—shall I own it?—my rusting fumigator was looked out and charged, not with the contents of Messrs. Neighbours' neat little packet as in days gone by, but with the deadly brimstone, and they had hardly time to miss their queen till they received their quietus.

Would that my misfortunes had here terminated. A subsequent examination revealed that not only my two strongest stocks, which I had attempted to Ligurianise, but every hive, with the exception of a "beat-out" of stranger bees, and even a virgin hive standing next the Ligurian, was in the same sad plight. What was now to be done? To deliberately brimstone all my poor favourites was not to be thought of, my unfortunate yellow-jackets having already been duly treated after the orthodox Devon fashion; why not adopt the more humane mode of cure extolled by the Edinburgh school? I therefore examined comb after comb in each hive, and carefully cut out every vestige of brood, pure as well as impure, then administered copious libations of food—the finest "Greenock Crush." Late bind-weeds, and skillocks* abounded, from which lots of pollen were carried in. After a time my anxious scrutiny was rewarded by finding the large gaps in the frames duly filled up with the most beautiful glistening white combs, and in the central ones no mean display of sealed brood, with fine swelling cell-covers all right. So satisfactory a result, coupled with the last good report of the returned condemned stock from Devon, induced the hope that however destructive this vile scourge might be to the half-acclimatised Italians, still the good old black aborigines might after all have stamina enough to overcome it.

Weeks passed on, when who called after a time but the

* Or "bee nettle," often so called hereabout.

proprietor of the above returned stock to inform me that, noticing several bees on the board he had raised the hive, and found its sole occupants 120 dead bees and their defunct monarch, abundance of sealed honey, and still the unmistakable proofs of the fearful malady to which they had succumbed. We, rightfully I think, agreed that the terrible dwindling was ascribable to the adult population gradually dropping off at full age as the cold weather set in, and a lack from foul brood of the youthful element to take their place.

My confident hopes having been a little shaken by this visit, it was with no small apprehension I once again proceeded to make another overhaul of my entire stock; and the reader who has followed my narrative so far may judge of my mortification at finding, although the brood in part no doubt hatched, still in every instance my pure comb largely centred by impure foul brood. Such, then, is my melancholy experience of the bee plague. Twice in one season, either directly or indirectly, has my apiary been reduced to a single "heat-out;" in the first instance from six, and in the second from nine most promising stocks, and all my previous store of beautifully-combed frames, which I had hoped to have turned to good account for Ligurian propagation, from having been in contact, as nadirs or otherwise, with these stocks, I cannot now be certain of the purity of a single frame, and consequently they are only fit to be broken up and consigned to the melting-pot.—A RENFREWSHIRE BEE-KEEPER.

(To be continued.)

THE FIRST LOAD OF POLLEN.

THE first load of pollen that I have seen for the year was brought home yesterday, Sunday the 24th. After morning service I was taking a casual look at my hives, when I was surprised at witnessing the return of a pollen-laden bee. The forenoon had been warm and sunny, after a frosty night, and doubtless numbers of bees had been disporting themselves, although, when I looked at them, all were pretty quiet; but amongst the stragglers that dropped in was one with a full load of dingy-coloured pollen, the produce, doubtless, of the laurustinus, now in full bloom in our gardens.—A DEVONSHIRE BEE-KEEPER.

DO MICE EAT BEES?

HAVING three hives under my care, I found it necessary, through the severity of the weather, to cover two of them. The frost disappearing, I felt anxious to know how the bees had fared; and removing the oat straw which I used for covering them, I was surprised by finding a quantity of bees at the back of one of the hives all lacerated. I thought mice had paid them a visit inside, but found the remaining bees with their combs all right.—T. R.

[A closer scrutiny would probably have revealed one or more large spiders sheltered under the straw covering of your hive. We think we recognise their handiwork in the quantity of lacerated bees which you describe. The mouse is probably quite innocent in this case. Remove the straw covering more frequently in future, and destroy all spiders and other vermin which you may find harbouring there.]

A DONKEY KILLED, BUT SHEEP UNINJURED. BY EATING YEW.

HAVING read in your Number for January 5th some remarks showing the yew to be poisonous to deer, and observing you ask for communications as to its effects on animals browsing on it, I give you cases in point. This morning (January 26th), a fine and valuable donkey, the property of my employer, was found dead in a small paddock. From the suddenness of this loss, the animal being in perfect health the evening previous, I was led to suspect that it had partaken of something poisonous; and knowing a yew tree to be growing in the hedge, on a close examination of it I found the points of three or four small branches had been recently bitten off; and further, on examining the animal's mouth, there were found several small pieces

of the yew foliage unchewed, leaving not the slightest doubt in my mind that eating yew had proved fatal to this animal.

On the other hand, a flock of ewe sheep grazing by day in the park have been browsing largely, as far as in their reach, on yew trees recently exposed to them by the removal of a fence, and so far without the slightest ill effect having been produced.—R. C.

GREEN YEW NOT POISONOUS TO DEER.

YOUR correspondent, "A HILL-SIDE MAN," corroborates a fact of which we had evidence in this neighbourhood many years ago, before the waste lands were enclosed, for I well remember many yews scattered over them, and the open fields were depastured by every class of cattle.

During the forty years through which I have been a practical farmer, I never had any accident from the cattle eating yew. For your information, I will mention that on the Monday following the day I sent my letter to you, I turned fifteen stirks, or two years old, into a three-acre field in which there are five yews, and as there was plenty of grass I let them remain until New Year's-day; as the weather was then beginning to be cold they were taken away.

I have heard of horses and cattle being made very ill from eating box and laurel; probably they were famished, as no doubt was the case in the instance which I mentioned in my former letter. All animals seem from instinct to avoid poisons, but the cravings of hunger will force them to eat what may prove dangerous.

A general prejudice exists against the yew tree, and to some degree justly, from the well-authenticated accidents that have occurred from its being eaten; but the cause of the cattle eating it has most probably been a positive want of any other food.—P.

OUR LETTER BOX.

"HARE SKINS AND RABBIT SKINS!"—May I ask any of the readers of THE JOURNAL OF HORTICULTURE for a receipt for the curing or preparation of small skins for domestic use? Hare skins and rabbit skins are now, during winter, in a good state, and there are few country houses where they may not be had, as also an occasional cat, polecat, stoat, or squirrel skin, which, if a simple and effective mode of preparation were known, might be turned to useful account. These skins, if nicely dressed, are very comfortable to wear as socks or on the chest, and for the lining of waist-coats, &c. They also make warm tippets, muffis, or gloves for children. The receipt to be useful should be simple and free from deadly poisons; yet it should be so effectual as to prevent disagreeable smells if the skin get slightly damp. I find by sending a skin now and then to the country tanners that they do not care to do such small articles, and often tear them very much, not, however, forgetting to charge. I should, therefore, feel obliged if any reader can supply the requisite information.—B. P. BRENT.

GAME BANTAM COCKS at KENDAL (A. T. E.).—We have inquired, and find that the card must have been put into your hamper accidentally. Your birds were considered good, but out of condition.

ALMOND TEMPLERS (A Subscriber).—We cannot give you any information relative to Mr. Eaton's book.

COCHIN-CHINA'S COMBS BLACK (Cochin-China).—Your cock's combs are frozen at the points. It is a very common occurrence, and far more so with Dorkings and Spanish than with Cochins. Strong camphor ointment is the remedy. Some fowls suffer more than others, just as in the ward of a hospital, out of twenty patients six die and fourteen recover when attacked by the same disease.

PREVENTING POULTRY FLYING (S. J. T.).—There is no way of preventing a fowl from flying without more or less of damage to the feathers. The simplest plan is that adopted in Holland. A narrow strip of parchment is taken and twisted in and out of the flight-feathers of the wing and then tied at the end. This being carried from the tip to the bottom, not a feather is injured and flight is impossible. Or they may be braced. Take a piece of list and tie back wing when folded; let the list pass over the back from one wing to the other. This is the way Peacocks are tied to keep them from gardens. They cannot fly over a wall 2 feet high.

POULTRY NOT INJURED TO PASTURE (J. R.).—Poultry may do some damage in a corn field by pulling down ears, or in a grass field when it is laid up for hay, by trampling; but we believe they make a good return by the insects they devour. They also kill mice. Any animal will feed after poultry. He was a wag who first said nothing would eat after a Goose. The truth is, a Goose's bill cuts off the grass as closely as a pair of scissors, and leaves nothing for any other animal to bite.

HOARSENESS OF MALAY COCK (G. H. P. P.).—We have generally found the crow of a cock returned with the warm weather, and it will probably be so in this instance. We know no treatment but cooling food. Malays are subject to a chronic hoarseness, but it leads to no other result than extinction of voice.

WILLIAMS v. HINDSON (Duckwing).—We understand that Mr. Williams is now pressing his claim for the award to his Game fowls at Birmingham. The Committee ought to publish the result for the satisfaction of the public, as well as in justice to the right claimant.

WEEKLY CALENDAR.

Day of Month	Day of Week	FEBRUARY 9-15, 1864.	Average Temperature near London.			Rain in last 37 years.	Sun Rises.	Sun Sets.	Moon Rises.	Moon Sets.	Moon's Age.	Clock before Sun.	Day of Year.
			Day.	Night.	Mean.	Days.	m. h.	m. h.	m. h.	m. h.		m. s.	
9	Tu	SHROVE TUESDAY. [MARRIED, 1840.	45.1	31.7	38.4	15	29 af 7	0 af 5	49 7	56 7	2	14 30	40
10	W	ASH WEDNESDAY. QUEEN VICTORIA	44.5	29.4	36.9	14	27 7	2 5	15 8	18 9	3	14 31	41
11	Th	Primrose flowers.	41.1	29.7	35.9	15	25 7	4 5	40 8	36 10	4	14 32	42
12	F	Gold-crested Wren sings.	44.6	29.9	37.2	15	23 7	6 5	6 9	52 11	5	14 32	43
13	S	Elder foliata. [DAY.	43.9	29.6	36.8	14	21 7	8 5	37 9	morn.	6	14 31	44
14	SUN	1 SUNDAY IN LENT. VALENTINE'S	45.2	31.3	38.3	14	19 7	10 5	12 10	3 1	7	14 29	45
15	M	Red Dead Nettle flowers.	46.5	31.4	39.0	13	17 7	12 5	53 10	8 2	8	14 27	46

From observations taken near London during the last thirty-seven years, the average day temperature of the week is 44.8°, and its night temperature 30.4°. The greatest heat was 65°, on the 10th, 1831; and the lowest cold, 0°, on the 13th, 1855. The greatest fall of rain was 0.52 inch.

BLOOM-BUDS FALLING PREMATURELY.

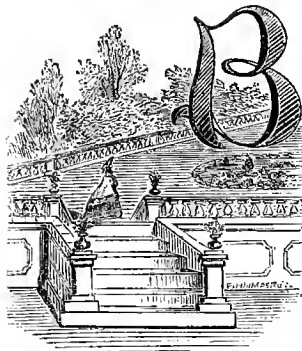

BECAUSE certain essentials for their proper formation and development are not provided, flower-buds fall prematurely.

Foremost among plants notorious for throwing off their flower-buds stands the Camellia, and next to it we have the Peach. On the causes of these casting their buds prematurely I purpose to offer a few remarks, and will begin with Camellias; and as this is about the time that they are placed in heat to

make their growth, an exposition of the subject is seasonable.

CAMELLIAS, as is well known, are exceedingly tender-rooted, and yet little apt to show the deficiency of their root-action by the foliage. Extra efficient drainage and particularly sweet compost are of paramount importance in their successful management. They cast their buds more frequently through an imperfect root-action than any other cause. But I must have a point to start from.

I will presume that the plants are placed in heat in March to make their growth and set their buds. This is mostly accomplished under the shade of climbers in a greenhouse, or under Vines in vineries. Whilst making their growth they receive copious waterings and syringings overhead. The buds are set by June or July, and the plants are placed outside. They sometimes are judiciously prepared for a change of temperature, for exposure to a stronger light, and a free current of air from all points; but too often the opposite course is adopted, and when the buds are set and about the size of peas the plants are put outside, without any care being taken previously to harden them off. Their system consequently receives a check, owing to the sudden change from a higher to a lower temperature, from a diffused light to a strong direct light, from a saturated to, it may be, a dry atmosphere, or at least a fluctuating moist or dry state of the air. The plants, however, show no traces of suffering immediately. Their leaves become deeper green, and people say, How much better they look after a few weeks' sojourn out of their confined quarters! But let us pause ere we get too far. Did you ever dream of disappointment? If not, you will have no forebodings of that dark bright green foliage deceiving you.

I had to experience this state of things more than once before I could convince myself of the absurdity of thus exposing Camellias in summer. Everything was more likely to cause the buds to fall than the check resulting from placing the plants outside after the buds were set. On dissecting the fallen buds I found that the flowers had never been perfectly formed in embryo, and must consequently have become defective at an early stage of

their development. In the following year the plants were put out again, and I cut several buds open and found them perfect. Every ten days from this time I cut open half a dozen buds of each plant, and at the first ten days I found some buds were then defective, but others not so. I marked the plants with defective buds, and found that all the buds dropped off these when they were taken into the greenhouse. The others retained their buds, and these were marked with green worsted. They had been placed in a cool greenhouse after the buds were set, and the wood was consequently hardened and ripened, and the buds fully formed. The others were placed outside at once without any ripening process; and the wood being unripe, the buds not fully formed were chilled, the system of the plant stagnated, and the result was that the buds fell.

No one can tell when the buds are formed from general appearances; and to place the plants outside before they are, and when the wood also is not well ripened, is sure to result in disappointment. I know placing them outside is a common practice, but I do not like it, and I will tell of more mishaps that come through adopting this plan. It is not uncommon to stand Camellias on a concrete floor, but no one thinks of placing some mulching round the pots so as to prevent them becoming dry. Should the pots become dry farewell to the delicate roots there; and it very often happens that, the sun and air acting on the pot, the water is evaporated from it, and a vacancy between the pot and the ball of earth takes place. All waterings after this pass through without wetting the centre of the ball at all, and the roots are dried up. The leaves, and even the buds, show no marks of injury, and the cultivator hopes all will be well. Then again the weather changes. It is as wet now as it was dry, and deluging shower after shower falls on the foliage, and the soil in the pots becomes sodden. Further, it may be, gentle showers fall, or what we may term a good syringing twice or thrice daily, doing nothing more than wet the foliage and damp the surface soil; and the cultivator, taking advantage of these showers, but in reality abusing them, fails to water the plants, and the soil becomes dust dry or nearly so, and it is farewell roots again.

All of the foregoing is melancholy certainly, but not the worst. Camellias are often placed on ashes on walks and other places not impervious to worms. These natural drainers are very good out of a plant-pot, but they seem to have a natural instinct to get into places where they are not wanted, and they choke the drainage, and the soil becomes sodden or sour, completely destroying every root that has been left. In this condition the plants are housed, and from the moist atmosphere of our climate in autumn they are brought into a dry conservatory atmosphere. The leaves begin to evaporate, owing to the dryness of the air; but there being no roots, or next to none, to feed them, the buds do not swell, or the flower just shows its colour and then drops, being dead at the core. Who can wonder at this?

I could point to several plants that have been ruined

by the injudicious system of placing them outside, but forbear, for I have enough of my own that have been so injured. The practice may do well enough in the south, but north of the Humber I am persuaded it does more harm than good.

The causes likely to occasion Camellias to cast their buds, then, are in order as follow:—1, The check given the plants at placing out, which may hinder the ripening of the wood, or the proper maturation of the buds should they not be fully formed; 2, Dryness of the soil; 3, Wetness of the soil; 4, A sodden and sour soil through worms entering the pots; 5, The change from an out-door to an in-door atmosphere. Any of these will cause the Camellia to cast its buds.

To avoid the first cause, the plants, after the wood is made and the buds set, should be gradually hardened by admitting more air and giving them more light for about a fortnight prior to placing them outside. They should be placed on a hard and level floor impervious to worms, and the situation should be shielded from winds, and not receive the sun's rays after ten o'clock in the morning up to four in the afternoon. They are to be placed so that light can reach them on all sides, and the pots should be protected from the sun and air by moss, cocoa-nut fibre from the brushmakers, or some such material. They should be daily examined to see that the soil is moist, and they should be watered before it becomes dry; but it should feel rather dry before any water is given, then enough must be applied to thoroughly moisten the ball. In dry weather a syringing overhead is advantageous, as it refreshes the leaves and assists in keeping them cool. When heavy rains occur the pots should be laid on one side, so that the soil may not become sodden. They are to be housed by the middle of September, and all the air possible should be given, and occasional sprinklings of the paths, so as to make the atmosphere as nearly like that from which they came as can be until the plants become accustomed to their new quarters. In the greenhouse they should have air daily, and be carefully watered, taking care not to make the soil sodden by "regular" waterings, nor dry by failing to water them when necessary. The soil in which a Camellia grows should at all times be kept healthfully moist. The plants in winter cannot have too much light. The further they are kept from the heating apparatus the better. It is very common for Camellias to cast their buds after severe weather. This is only what we might expect; for the dry heat generated causes the leaves to evaporate at night more than is good for them, and this continued night after night results in their casting their buds. A few degrees of frost will do the Camellia less harm than an hour's confinement in a dry hot atmosphere. Where there is convenience Camellias are liable to mishaps enough without being put outside, and under glass they occasionally cast their buds. Sometimes this is occasioned by dryness at the root, or through a deficiency of light, bad soil, and defective drainage. This applies equally to those planted out as to those in pots. With a plant always under the eye it is difficult to say how it does become dry at the root. Amateurs, however, are always afraid of overdoing anything; and they, seeing a plant dry, or because it has not had any water for a long time, think it would be none the worse of a little. It is little they give, and it does no more than wet the surface: consequently, the soil lower down becomes dry, and it is there that the roots are situated, and they are, therefore, dried up and perish.

When a plant needs water it should have enough to run through the soil and show itself at the drainage. If planted out the constant attendance required by plants in pots is not necessary, but the soil is more liable to become sodden than when in pots. In whatever position a plant be, whether in a pot or planted-out, perfect drainage must be provided, for stagnant water lodging at the roots is certain death, and the buds fall as a necessary consequence. There are no roots to supply them with food, and the buds fall from want of support. When a plant remains for a long time with the soil wet the drainage should be examined, and be made secure; but should the soil still remain wet it would be well to remove as much of the old soil as can conveniently be done without injuring the roots, and replace it with fresh. At all times the soil about a Camellia should be sweet, the pot or border provided with perfect drainage, and be kept moderately moist continuously.

THE PEACH.—This, unlike the Camellia, is a deciduous tree; but in no wise much better on the score of casting its buds. Dryness of soil will cause this, so will immaturity of wood, and the same may be said of wetness of soil. The main cause of Peaches casting their buds is due to immaturity of wood. This may be occasioned by insects sucking out the juices of the leaves, or from a deficiency of light.

The red spider is very fond of the juices of the Peach, and commences its attacks on the under side of the leaf. For a time it is content to remain there, but when the leaf becomes enfeebled so that it does not perform its functions properly, then the red spider extends its operations to the upper surface of the leaf, and takes an equal pleasure in sucking out the crude sap as in feasting on the elaborated juice at the under surface. Now, a Peach leaf infested with red spider at the under surface is robbed of its elaborated juice, and it is this elaborated juice that forms the fruit-bud at the axil of the leaf. The buds cannot, therefore, be perfectly formed when red spider infests the leaves. I have some trees in pots, and these were placed in ainery last season to force. During summer some of them became infested with red spider through the impracticability of syringing them where they were. There were others that had no red spider on them, and they are now in flower, whilst those attacked in the preceding year have cast their buds. To further prove that red spider is the cause of Peach-buds falling, I may observe that in ainery where some Peach trees are planted, one of them was attacked by red spider, and a more desperate attack I never knew. Sulphuring the hot-water pipes did not rid us of the pest, and it held its own more or less through the summer. Its neighbour under the same treatment was clear of the spider, and the buds are now swelling, and are everything that could be desired, but the other tree has lost fully nine-tenths of its buds. More trees lose their buds through attacks of red spider than any other cause, as it is next to impossible for the buds to be properly constituted with red spider intercepting the elaborated juice in its passage from the leaf to the bud at its axil, and so destroying their future fruitfulness and vigour.

Deficiency of light is another cause of Peach trees forming defective fruit-buds. It is chiefly in vineries, under the shade of the Vines that the buds are not properly formed. Trees on the back walls of Peach-houses also form defective buds owing to the trees in front shading them too much. The leaves do not properly perform their functions, the crude sap is not acted upon by light sufficiently in the leaves to enable these to duly digest or elaborate the food, and the buds are not properly fed. The food is spent in the formation of new parts: therefore, trees in the dark grow more than they flower, and are more gross than fruitful. There is no remedy for this but more light, and a Peach cannot have too much. If the buds of a Peach are dissected when falling from insect attacks, or through a deficiency of light, the anthers will be found short, and of a brown colour, and when the buds fall the inside of these will be found brown and dead.

Another cause of Peach-buds falling is dryness whilst the leaves are on the tree. Allowing the leaves to flag from want of moisture, or keeping the soil dry so that they turn yellow and fall, is inimical to the thorough ripening of the wood, and the buds fall. The soil in which a Peach grows should never become dry, not even when the fruit is ripening; for though too much water may make the fruit flavourless, yet dryness oftener makes it mealy, and nothing is so detestable as a Peach without juice. It is very doubtful whether watering a tree whilst it is ripening has any effect on the fruit in making it high or poor flavoured; but trees are often kept so dry at that season as to place in jeopardy the future bloom-buds. The leaves cannot form the buds without moisture, and if they be badly fed they must fall in the winter following, for Nature casts off leaves and buds when they are no longer wanted for the increase of the head, or the propagation of the kind.

Again: Peach trees are often allowed to become so dry at the root after the fruit is gathered, in order to ripen the wood, that the roots are almost dried up by the practice. The leaves feel this, and the immature buds too, and they become "dead" through want of support. The soil in which a Peach grows should never become dry; and although trees

in pots are recommended to be kept dry in winter, I am certain, if I may judge by some I had in an orchard-house, that a worse plan cannot be adopted. All through the winter the roots of a Peach are more or less active, and dryness cannot either preserve the roots there are, or allow fresh to form. The roots should be kept moist, but not wet, and when water is applied it should be given in sufficient quantity to wet the mass. Dribbling waterings do no plant any good, but they very often cause the roots to become too dry owing to the surface being merely wetted. Extreme wetness is equally destructive to the roots as dryness, and does a great deal of harm when the trees are at rest. If the soil where the trees are planted out be watered when the leaves are falling, the trees will need no more until the buds begin to swell; nor will trees in pots need any if the pots be plunged in the soil, which saves the roots from frost, and is, to my thinking, a better practice than covering the pots with hay.

Lastly: the Peach casts its buds when they are formed too soon, and in too high a temperature. Last season I had a tree that flowered from buds of the same year, and as these buds set, no one can say they were not perfect. The fruit became as large as beans, and then the leaves began to fall. The fruit, however, did not fall then, but remained on the tree until the middle of January. It then withered and fell, and the greater part of the buds have followed its example. The reason of buds being too highly developed is owing to keeping them in a temperature and atmosphere conducive to their further growth. After the fruit is ripe the buds are then developed, and no good comes of keeping the atmosphere hotter after that; but air, and a lower night temperature, and less atmospheric moisture, will do all that is requisite towards inducing rest.—GEORGE ABBEY.

THE FLOWER GARDEN.

SPRING PROPAGATION.

The present generation of gardeners have annually to get through an amount of propagation, which would have sounded more like fiction than like fact to our forefathers. Plenty of gardeners, now in their prime, can remember very well when the principal preparation for the decoration of the flower garden consisted in putting up a bed for a one or two-light box, in which to sow Stocks and Asters, and a few other tender annuals, which, with a few Dahlias, made up the major part of the tender plants that helped to beautify the mixed beds and borders of hardy things. This, with the sowing of a few annuals in patches in the open borders after they were raked the first time for the season, completed a gardener's labours in this respect. He knew nothing of the potting and manufacturing, and otherwise caring for the tens of thousands of tender plants which are the order of the day now. If we could go back to what some call the good old times, many of us could "take the play" more frequently than we can afford to do now. Little did Mr. Caie think, when at Campden Hill he inaugurated the massing of tender plants, of the amount of bustle, labour, and emulation that he was entailing on a gardener's life—to say nothing of the wakeful scheming and makeshifts which many have had to encounter in order to be able to follow the fashion.

Let us fancy for a moment a return to the system of olden times—that some knight-errant should make a clean sweep of the massing system, and reinstate us in the ways of thirty years ago, and some gardening conservatives profess that it would delight them to see this, I should get rid of fifteen thousand Geraniums, as many Verbenas, and a similar proportion of the other plants which form the rank and file of flower gardens. And I fancy I hear Mr. Fish saying, "Why, dear me, we should be gentlemen—if freedom from bustle and thought to a large extent has much to do with that denomination—we should scarcely know what to do with ourselves for the next three months." I fancy, however, that we would not like so sudden a change as a return to the old speckled borders, with Geums, and hardy Asters, Veronicas, and Potentillas, lashed tightly in bundles to stakes like faggots. I expect we should as soon be found in Regent Street with swallow-tailed blue coats and gilt buttons, thick enough for the sides of a steam ram, with

nether garments of "hoddin grey" If we are to have such a retrogression, let it be by degrees, step by step, or we shall certainly be mobbed by the ladies for taking away what may be termed the cosmetics of the garden. Into the ladies' hands we commit the conservation of the massing system to its proper place, and we have no anxiety as to its fate, nor do we grudge the labour and forethought which it demands, especially for the next few months.

It is now a well-established rule, that the majority of bedding plants answer the purpose for which they are intended much better when propagated in spring instead of autumn. To this rule a few, such as Geraniums and Calceolarias, form an exception, and are much better propagated in autumn, although most seasons it is found desirable and necessary to increase some varieties by spring propagation; and good plants can be so produced with proper convenience; but autumn-struck plants make far the finest plants, and come earlier into bloom.

For a good many years I have made it a study how to compress spring propagation into as short a space of time as possible, and have so far accomplished the object as to greatly reduce the time occupied with that work, and at the same time improve the quality of the plant. In the case of Verbenas, for instance, which form a large proportion of spring-struck stock, it was a common practice to pot these in autumn into three or four-inch pots, putting a few plants into a pot. About the beginning of February, these were shifted into larger pots and forced for cuttings. By this means I have kept them in good condition, and obtained very large numbers of plants, but not without much more labour and attention than I can now winter a greater number in much better condition, to enable short work to be made of spring propagation. The plan now adopted is the best that I have tried, and it is to strike a larger number in autumn, and when rooted to prick them out into pans about 13 inches in diameter, and 7 inches deep, filled with rich soil. These are struck and otherwise managed without any artificial heat. From eighty to a hundred of these pans occupy but a comparatively small space, require little attention in the way of watering, and in spring are found in splendid health, yielding fine strong cuttings by the thousand at a time. At the present moment we have some twenty pans of Purple King—considered difficult to manage well—that might be sheared with a hook, of a fine dark green, without a spot of mildew. Reference to a note-book of 1863 shows that on February 2nd the first batch of this sort was put in, numbering two thousand five hundred, a propagation that I could never accomplish with so little labour on the small-pot system. In a few weeks, by this means we propagate from eighteen to twenty thousand Verbenas. The rule is, never to winter Verbenas in anything less than an eight-inch pot. A given number of plants require less room in these larger vessels, and are in far finer condition than when put into little pots. Although plenty of fine fresh cuttings could be taken before they are put into heat, they strike much more readily after being in a nice, growing, moist atmosphere of 60° to 65° for a while. They are therefore introduced into a vinery, or any convenient place, where they can have a good share of light to keep them healthy. A very few "clips" soon give the desired number, and the contents of the store-pans, though never planted out by ourselves, come in handy for giving to cottagers who look to us for a few plants for their gardens; and, I am happy to say, the Scotch are now fast wiping off the stigma of not caring for beautifying their cottage fronts with flowers.

These remarks are also applicable to the rapid production of strong healthy cuttings of nearly all the other bedding plants that are propagated in spring, such as Heliotropes, Ageratum, Salvias, Petunias, &c.; and having found great advantage from wintering a somewhat larger store stock in larger pans and pots than are generally used, I would recommend a trial of the method to those who still adopt the small-pot system. It has saved me time and labour, and afforded a far healthier supply of cuttings than I have been able to produce by any other means; and the production of fine cuttings quickly in spring, is the most important part in the whole process of preparing the requisite number of plants; for if cuttings cannot be had in large quantities at a time, the propagation is of necessity extended over a

longer period, and much valuable time is lost in nibbling over smaller numbers at many different times.

To strike cuttings of the plant now under consideration, I am not certain that any appliance for the supply of heat is better than a good old hotbed properly made up with stable-manure and leaves of hard-wood trees. There is, however, much less labour connected with striking in a more modern propagating-house or pit, where top and bottom heat can be nicely maintained by means of hot water, and I would never adopt the hotbed when hot water could be made available. A regular propagating-house is one of the most useful and necessary structures connected with a garden establishment, and all gardeners who have much flower gardening to do should be supplied with one. I cannot avail myself of such a convenience, nor yet of an old-fashioned hotbed, and am consequently obliged to make use of a succession Pine-pit when it can be most spared from its legitimate purpose. The extra bottom heat is obtained by putting in a greater depth of fresh tan than would be safe for the roots of Pines, and top heat is supplied by a flow and return four-inch pipe, and in order to produce the top heat that is necessary to strike with rapidity, coverings of mats are used at night except when very mild. Circumstances will, therefore, in many cases no doubt determine how the heat necessary for spring striking is secured, when the operator unfortunately has not a proper propagating-house always in readiness; but those who cannot by some means command a smart top and bottom heat need not attempt spring propagation. To do it in cold pits or frames is out of the question. Those who are so situated should not be expected to have a fine healthy stock of bedding plants, and must depend on autumn-struck plants, or have recourse to the nurseries in May. At the same time, any amateur or gardener who can make up a hotbed large enough for a one-light box, and put a hot lining to it when the heat declines, is in a position to turn out many thousands of plants in the course of March and April. Sawdust, cinder ashes, or sand to plunge the pots or pans in, some nice silver sand to put the cuttings in, and a little light rich soil, are the principal materials wanted; and there are few operations within the whole range of gardening calculated to prove a more pleasing recreation than the propagating and rearing of young plants; and the fact that the gay garden is the result of one's own handiwork must enhance by many degrees the pleasure and enjoyment derivable from such a source.

There are many ways of propagating so far as heat is concerned, of which the possessor of an early vinery or forcing-pit alone can take advantage. Take, for instance, such a structure heated with a common flue. Let a box 15 or 16 inches deep be placed on the flue. Fill it up half way with fibry soil, and follow with an inch or two of fine light soil, and over all place an inch or two of pure propagating sand, leaving 2 or 3 inches of the box not filled up. Cuttings inserted in the sand and covered over with a few large panes of glass will enjoy a nice bottom heat ascending from the flue, and the glass over the mouth of the box will prevent evaporation, and the cuttings will root freely. Care must, however, be taken that the box is not placed on a part of the flue that is too hot; 90° of bottom heat should not be exceeded under such circumstances. A space of two or three square feet may in this way be made to produce as many plants as will fill a good many beds.

It may not matter much so far as successful striking is concerned into what sort of vessels—whether pots, pans, boxes, or drain-tiles, &c.—the cuttings are put. In all of these they will root perfectly well. But looking at the work in the light of time, attention, and labour, I would give the preference to large shallow boxes about 2 feet by 1½ foot. These are what, after trying all sorts of things, I have found the best for dispatch. The crocking and nibbling connected with small pots and some of the makeshift receptacles is dispensed with. In the case of these boxes all that is necessary is to strew a layer of rough stuff (the fibry part of loam) over the bottom of the box, blind this over with a little finer mould, and then lay on a sufficient depth of sand for the insertion of the cuttings. From 500 to 700 Verbena cuttings according to their size are put into these boxes. After being well watered they are placed on the surface of the tan, firmly bedded into it, and they root without any attention in the way of watering, and in this way the work of the pro-

pagating-pit is simplified, no plunging or anything of that sort being required. In this way a very few boxes and little space are required to raise a large stock of plants.

Probably the most expeditious way of striking Verbenas, in particular when a strong bottom heat can be applied and steadily maintained by means of hot water, is to insert the cuttings into water-tight saucers filled with sand, and just so much water as to enable the operator to stick the cuttings into the sand without a dibber. In this manner with a sufficiency of heat they root in a few days. In my own case the appliances are not of such a nature as to enable me to adopt this method; but all who have a propagating-house well heated will find it an expeditious and excellent mode.

Although every joint of some bedding plants, and of Verbenas in particular, will root and make a plant, I have a decided preference for good strong cuttings. They require a shorter period of tender nursing, and that is no small consideration at a season when there is such a host of candidates for warm quarters. It is much preferable to have to pinch their tops off than to be obliged to coddle them for weeks in heat to make respectable plants of them.

No matter how strong may be my store stock from which cuttings are furnished, I like the cuttings that are produced in heat the best: consequently, propagation is not commenced till after the store-pans have been in heat for a time. Such things as Heliotropes, Petunias, Gazanias, and a few others that do not emit roots without some time to callus, are best struck in a lower temperature than is desirable for Verbenas. The plants referred to if plunged in strong heat become drawn and debilitated before they are ready to pinch-out or pot-off. I seldom plunge them at all, and I place them in the coldest part of the pit.

There is, however, no necessity for propagating the Gazania in spring, for it does splendidly treated in the same way as Calceolarias and put in late in the season, just at the same time and in the same place as Calceolarias; and the Gazania well cultivated is one of the most gorgeous of our bedding plants.

D. THOMSON.

ROYAL HORTICULTURAL SOCIETY'S SCHEDULE.

HAVING given a general survey of the wisdom that has arranged the schedule for this year, I, according to promise, now enter a little more into detail.

I cannot, however, but admire the refreshing innocence of those who question whether offering a prize for British botanical collections be not exceeding the limits of the Society when not a word is said about prizes for volunteer bands (it must be *flower* music, I presume), or of another equally legitimate object of expenditure, which *The Times* assured its readers with much pleasure the Council had determined upon—viz., appointing an instructor to teach the lady Fellows skating! Was it a joke or not? for it was never contradicted, and was asserted with great gravity.

Again have the Orchid-lovers in the Council carried their way, no less than £22 being offered in prizes for them at the first great Show, and £74 at the second. The very questionable plan of dividing them into families has been adopted also. What possible end can be gained by this I know not. It must tend to great sameness in these collections and shut out small growers, for few would devote their houses to a few genera, but would rather seek to have variety; and it is only from a large collection that a sufficient number could be obtained for such a competition. Why not, as so much is said in favour of the cool treatment of Orchids now (and justly so, as it will put Orchid-growing within the reach of so many), offer prizes for plants so treated? Prizes are offered for Hyacinths in windows, would it not be as legitimate to offer them for Orchids grown in greenhouses?

With regard to the prizes for Azaleas, the Council have very wisely taken the hint given them last year, and instead of waiting until Azaleas were out of bloom to offer prizes for the novelties, have offered them at the first Show. But now mark the wisdom: They offer a prize for three Azaleas of 1862 and 1863, and a prize for Pelargoniums, three, of 1863. Now we very well know that, with three or four exceptions, the Pelargoniums of 1863 were all sent out by Mr. C. Turner, of Slough; and it is in effect putting the

prize into his hands, because, as he holds all the old plants, he must be in a superior position to any other grower. Had they made it six of 1862 and 1863, then there might have been some reason in it; but as it is it is utterly meaningless.

Then, again, look at the wisdom displayed about Verbenas. Prizes are offered for twelve kinds in pots on the 1st of June, and prizes for twenty-four cut single trusses on the 6th of July—i. e., a prize is offered when a Verbenas in a pot can hardly be obtained without an amount of forcing that would destroy its character; while if reversed one might get something really worth looking at. And single trusses of Verbenas in July! What will they be before two or three hours of a July day pass over their innocent heads?

In the Rose Show more wisdom has been displayed. The hints of those acquainted with the subject have been regarded, although I notice that the fact of its being the National Rose Show inaugurated by the Rev. S. Reynolds Hole is quietly ignored. But those very absurd classes are still retained which have been so often criticised in THE JOURNAL OF HORTICULTURE under the head of Fancy classes, while prizes are also offered for six kinds of Moss Roses. What a charming box this will make! Or are they to be shown in bud, in a bouquet, or how? for how can one ever set up six Moss Roses? What a delightful knowledge of florists' flowers seems to be possessed by the Council!

On the 6th of July prizes are offered for Carnations and Picotees. Well! And also for Pinks! If the former are in bloom, which doubtless they will be, the latter will be out of bloom—at least as far as metropolitan or southern growers are concerned; and I presume it is for them that the exhibition is intended.

And let it not be forgotten that all these things which I have selected are by no means the only blemishes. The points of all others at which exhibitors have a right to grumble are—1, The continual changes that the Society makes; and 2nd, The two-days Exhibition—at one time fixing the sizes of pots, at another doing away with them; making classes one year, and doing away with them another; selecting special kinds as in the fruits, and thereby stamping them with their seal as if they were the best, and another year altering that again, so as to leave people to fancy that blunders had been made. And I, moreover, think that the growers of florists' flowers—of such, at least, as are shown in a cut state, have much to complain of. Although many prizes are offered for early Tulips, not one is given for late-flowering kinds. The Ranunculus and Anemone are also entirely left out; while others, as in the case of Verbenas, are entirely misplaced. Meanwhile, the other great exhibitions hold on their even way; and while all is dissatisfaction, and grumbling, and annoyance at Kensington, all is agreeable and pleasant at the Regent's Park and the Crystal Palace—and so must it ever be until the whole affair topples.

Strawberry feasts, and volunteer bands, and all the other contrivances to make an aristocratic tea garden of that at Kensington will not be able to keep it up, and it will be another instance of what "clique" and red tape can do to destroy the finest prospects.—ARGUS.

I HAVE read the admirable article in last week's JOURNAL OF HORTICULTURE; and as there is an intimation of going further into details, I hope you will have a word or two to say of the most interesting feature of all horticultural shows—viz., new plants and the way their exhibition is encouraged (or rather discouraged), by the Royal Horticultural Society.

There can be no doubt about their being the most attractive feature of our metropolitan shows, and yet the prizes awarded to them are of the most insignificant description. I have always been at a loss to know why a given sum should not be fixed on the schedules as awards for them, instead of the indefinite phraseology now employed, which in the end proves itself to be a mere nothing.

Last year at the Great Exhibitions of the Royal Horticultural Society, I received as follows:—

May 27.—Silver Knightian, Banksian, and Bronze Medals.

June 17.—Bronze Medal.

July 1.—Silver Banksian and Bronze Medals, besides no end of honorary awards. For all this at the end of the year I was sent the magnificent sum of £5 6s.!

The Horticultural Society is thus discouraging what should be its legitimate object, that in which the public take an immense interest; and to do what in its place? Offer valuable medals for wild plants, which is scarcely justifiable—certainly not what horticulturists or the public in general would take much interest in.—WILLIAM BULL, *King's Road, Chelsea.*

CULTURE OF PERENNIAL PHLOXES.

THERE are few herbaceous plants superior to the many beautiful varieties of Phlox decussata, combining as they do fragrance, beauty, and size of flower, with rich variety of colour. They are well known also as being late autumn-flowering plants, gifted with a hardihood that enables the most delicate of the newer varieties, with very slight assistance, to withstand the assaults of frost with impunity. They are, almost without an exception, readily propagated by the young growths of spring, which growths are already discernible above ground. These should be taken off when with two or three joints, and struck like Calceolarias. Plants are also readily multiplied by division of the old stool of a year or more old, though I have a preference for properly-treated cuttings, which make very handsome plants the second season. Phloxes delight in a light loamy soil, especially if with a slight sprinkling of good decomposed leaf mould intermixed. I would observe, more especially, one marked feature in their successful treatment, attention to which increases materially not only their large heads of flower, but also the well-being of the plants generally. They should at all times be in a place shaded from the midsummer sun between the hours of 10 and 3, as from the very delicate texture of the florets these become very readily scorched.

In such a partially-shaded border I would plant out a few of the more showy and better varieties, having the shortest, some of which barely reach 12 inches high, in front. What a beautiful little plant as an edging, or for the front row, would be the Phlox frondosa. Before planting it, it would be advisable to form (slightly covered with the soil, and slightly mound-shaped), a ridge with moderate-sized stones, say four or five thick, upon which to plant them firmly. This little frondosa I seldom meet with grown successfully; its neat little branches are 3 or 4 inches high, and covered, Heath-like, with pointed leaves; and it bears, for its size, a large and lively flower, in colour somewhat of a dark rose.

I add a few of the most showy sorts of Phlox decussata—a collection of twenty-four.

WHITES, VARIOUS-COLOURED EYES.

Comte de Chambord. Dwarf.	Julie Roussel. Bright eye.
Madame Duldensluck. Crimson eye.	Madame Le Cerf. Purple eye.
Dwarf.	

CRIMSON AND REDS.

Souvenir de Fries Morel. Dark purple.	Doux Reveil. Rose.
Madame Rivère. Deep red.	Hébé. Lilac peach, dark cherry eye.
Orientalis. Dark red. Dwarf.	Madame Girardeau. Blush striped.
Ji-cm-Jee. Red. Dwarf.	Dwarf
Dr. Bois Duval. Red, approaching crimson.	Triomphe de Twickle. Rose striped.
Madame Lierval. Carmine violet.	James Veitch. Pink.
Jacques Duval. Pink.	Madame Andry. Blush. Dwarf.
Madame Durdan. Lilac carmine eye.	Madame Lebouchere. Rose violet, dark eye.
Alexandre Roussel. Dark rose. Dwarf.	Indispensable. Good.
Alice Allain. White with pink eye.	Novelty. Singular.
	Evening Star. Peculiar and pretty.

The greater part of the above are show flowers, or such as might be used for that purpose.—WILLIAM EARLEY, *Digswell.*

POINSETTIA PULCHERRIMA.

IN ANSWER to "A SUBSCRIBER" at page 62, No. 147, you say concerning this plant, "About September give all the light possible, and begin to curtail watering. After June there must be no stopping of the plants, or, rather, after May, as the flowers and floral leaves are produced at the points of strong well-ripened shoots."

This, I beg to say, is in direct opposition to my practice, as we never think of curtailing water till the floral leaves begin to fade, and we take the points off as late as September. We also make a flowering plant the same year of each

shoot so taken off. We have had hundreds in 60's and 48's flowering in November and December, at which time they are no mean objects; for bright colours during these two dull months are generally more pleasing to the eye than at any other time. I never remember seeing a healthy shoot refuse to flower at its proper time, although we have some plants in a border of rich soil, where they make growths 5 or 6 feet long in a season, if not stopped; in fact, if the flowers are cut off early, the plants will attempt to furnish fresh ones, showing plainly that they will bear stopping later still. The object of stopping so often is plain enough, as it multiplies the number of blooms every time by two or three, while the floral leaves are nearly as large as on plants not stopped at all.

A variety called alba is mentioned in some books, does any one know the plant?—K. T. W.

[The object in the instance to which we replied was to have a profusion of bloom in summer; your object is to have autumn and winter-flowering plants.]

RELATIVE MERITS OF WOOD AND METALS FOR HORTICULTURAL STRUCTURES.

(Concluded from page 93.)

CAST IRON FOR HOUSHOUSES.—Some of the first houses made of metal were of this material, the substitution of cast iron for leaden framing for windows having led to its application in lights for frames and structures of larger size. In my early days I had much experience with cast-iron lights, but they were not favourites with me. One quality they had—I never knew one blown off its place; but they possessed no other advantage over the wooden sashes in use even at that time. I believe that they have now fallen into disuse in all cases, excepting where fittings of an extraordinary size are required; pillars, girders, and such like being of cast iron, and where very large curves are wanted, portions of cast iron bolted together are occasionally used. This, however, is a subject lying more within the province of the engineer than that of the gardener; and as the utility of cast iron for small work is far exceeded by that of wrought iron I will dismiss the subject, merely remarking that cast iron can only be regarded as an auxiliary to wrought iron, and that as such it often does good service.

ZINC.—I cannot remember ever seeing this metal used except as glazing-bars secured to a wooden frame, its want of rigidity preventing it being employed alone; but in combination with wood it has many advantages, and some practical men of high standing prefer it to any other metal. One advantage which zinc seems to have over all other metals is the affinity it appears to have for oil paints, as paint and putty adhere to it better than to anything else. I have seen some very simple and easily-made glazing-bars of this metal that were merely formed by bending portions of ordinary plate zinc into the required shape. They presented a great degree of rigidity, and I believe would be durable, but the fixing of metallic substances into wooden frames is more destructive to the latter than when all wood is used. This, however, is not a serious objection. In the form above zinc is often useful to the forcing gardener, as the expense is not serious; but highly ornamental and costly structures are more commonly formed of iron.

COPPER.—The great expense of this metal precludes its adoption in glass structures, excepting those of the most highly finished character, and it is generally only found in connection with plate glass and other expensive features. For glazing-bars it is certainly superior to any of the metals above mentioned, but its costing four or five times as much is a serious drawback to its general adoption; in fact, it is rarely found except in the more highly finished portions of a grand conservatory or some such structures, or perhaps in the framework of some decorated front; and I am not certain that I have not seen more than one house in which it was used for the roof, but that house was said to have cost several thousands of pounds. Copper, therefore, must be regarded as too costly for the general public; neither need they regret the circumstance, for its superior qualifications are in no way equivalent to its extra cost—on the contrary, its superiority, if any, is only over that of other

metals. As compared with wood for houses it simply possesses the same advantages and disadvantages as other metals, with the serious drawback of being so very much dearer than any of them.

COMBINATIONS OF WOOD AND IRON are not uncommon, and in many cases there is much to admire in them; in fact, there are comparatively few glass houses without more or less of timber in their construction, and it must be admitted the latter is the more indispensable of the two. A house composed of timber rafters, wall plates, and front lights may have the glazing-bars of the roof of iron and be found to answer well, and some houses are made to appear without rafters, a stout purlin either of wood or iron, with supporting pillars at intervals, being made to carry the roof, and there are some advantages in this class of house; even wooden-built houses are sometimes of this construction. My object, however, being to place the merits of timber and metal before the reader, the different forms which each is capable of assuming need not be gone into here. Suffice it, therefore, to say that by the combination of the two some of the best-constructed houses are formed, and most assuredly such a combination is better than a metallic house alone, but whether better than a wooden one is a question requiring a qualified answer.

As to the comparative cost of the wooden and metallic framed houses, notwithstanding the great improvement in the machinery used in the working of iron for many purposes to which at one time people never dreamt of applying it, there is no question that at the present day timber is still cheaper; and all the cheap class of houses are of wood, excepting perhaps in the case of those who deal in the other material, and who, having a staff of workmen skilled in iron work, may be able to put one up for themselves as cheaply as it could be made in wood by a less skilled body of men; but this is not a fair example. The best test of the relative estimation in which the two classes of houses are held by the public in general is shown in their patronage of each kind, and certainly nine-tenths are of wood. The greater cost of iron has something to do with this; but there also lurks an idea amongst the many that iron is not so durable as wood. Be this, however, as it may, it is certainly much dearer; and notwithstanding the advantage it possesses of being capable of assuming any fantastic shape that may be desired, it is comparatively little used excepting for these forms. As a hothouse-building material it has not kept pace with wood during the last fifteen or twenty years, the proportion of iron houses relatively to those of wood at that date back being quite equal to what it is at the present day.

On the relative merits of wood and iron houses for horticultural purposes, much information would be elicited if the subject were freely discussed, each writer giving his opinion on the matter. My own views of the case are certainly in favour of wood, but I am by no means opposed in any prejudiced way to iron. I certainly think that wooden houses have approached much nearer to perfection than those made of iron; but that the latter may make great advances I have no doubt, for it is only by degrees that such progress is really made; and we are told that this is the age of iron, and if we look at the many great objects attained by the use of that metal, the justness of the observation is beyond a question. Perhaps the advocates of iron for hothouses received a great repulse by the universal condemnation that was passed on the large domes at the International Exhibition in 1862; but on the other hand, they have the Crystal Palace as an example of a structure in which iron may be used to advantage to a certain extent, but in that case very little is used as glazing-bars. Some railway stations also afford examples of the same kind, but on the whole the art of building metallic houses for horticultural purposes is yet far from being perfect. Perhaps some of your readers will be kind enough to record their observations on the matter; and if backed by examples that tend to prove iron to be better than wood I confess I am not so wedded to the latter as not to be likely in the end to become a convert to the same opinion, but the superiority ought to be shown, not alleged. Even if it can be proved that iron houses can be built as cheaply and as well as wooden ones a great point will be gained, and assuredly this may be done. Iron is at the present time competing successfully with stone and

brickwork for bridges, and with timber for ships and fences; why should it not do the same with timber also for horticultural buildings?—J. ROBSON.

SOAPSUDS AND THEIR UTILITY.

Is it true that soapsuds when thrown down into drains cause the most dangerous sort of miasma? and if so, what is to be done with them? Is there nothing for which they would serve as manure?

There has lately been a fearful outbreak of scarlet fever turning to typhus in the house of a woman living at the lodge of a healthy park, and it has been attributed to her taking in a considerable quantity of washing, and naturally allowing the soapsuds to run away in the drains. The father and three children have died; and although the drains are not allowed to be discharged any longer into the Thames, but into cesspools, yet the blame is not laid upon this but upon the soapsuds. It is also hinted that one of the neighbours, wishing to utilise the sewage of his cesspool, spread it upon his field, and that this poisoned the air. In short, there is a panic, which is as likely to spread the epidemic as any bad smells.

There was a small pamphlet published a year or two ago on the use of domestic sewage by mixing it with earth, but the writer cannot remember the title, nor where it was published. Surely there should be some inexpensive means of using it without risk made known to the ignorant public.—A. A. Y.

[It is a total fallacy that soapsuds emit any dangerous miasma. Mixed with the other drainage from a house, and kept stagnant for a lengthened time, the mixture would become putrescent, and emit offensive gases, but not more so than if the soapsuds were excluded. The contents of a cesspool spread over a field would not poison the air; and within a few hours after being so spread there would be no smell perceptible, so effective a deodoriser is earth.

Soapsuds might be beneficially poured upon any vacant quarter of the kitchen garden, and over Asparagus, Rhubarb, and Sea-kale beds when the plants are growing. The suds may also be poured between the rows of any of the Cabbage-works during their growing season.

The pamphlet alluded to is published at our office. The second edition is called "Manures for the Many."]

ANNUALS TO SUPPLY THE PLACE OF LOST BEDDING PLANTS.

HAVING lost all my bedding plants with the exception of Calceolarias, through neglect after covering from frost, I shall be much obliged if you will inform me what plants can without much difficulty be raised from seed, so as to form distinct and separate beds. Would the Mimulus do for this purpose? Please also state when and how the seeds should be sown. I can easily make a hotbed for raising them, and have a very good cool greenhouse for growing the plants in.—A LOVER OF FLOWERS.

[As likely to come in with your Petunias we would instance the following:—Prince's-Feather; Love-lies-bleeding; Calhopsis marmorata, Drummondii, rich orange, and seven or eight varieties; Chrysanthemum tricolor, aureum, Burridge-anum; blue Branching Larkspur; Eschscholtzia californica and others; Tropæolum majus in varieties, as Tom Thumb Scarlet, Yellow, Pearl, and others; and Phlox Drummondii. For foliage—Purple Spinach, Perilla nankinensis, and Amaranthus melancholicus. All these may be sown out of doors in March, with the exception of the Phlox, Amaranthus, and Perilla, which had better be sown in pots in a mild hotbed in the beginning of March, and be potted-off and hardened-off before planting out. To make good beds of the others we would make a slight hotbed about the third week of March—say 1 foot of dung, place on it 3 or 4 inches of rough leaf mould or rotten dung, then 2 or 3 inches of roughish loam and 2 inches of fine, draw drills about 4 inches apart, sow thickly, and plant out in the end of April or beginning of May in small patches with the earth and dung adhering to them. This is the best plan to insure regular beds; and we would also do the same with the following

low-growing things, suitable either for beds or edgings:—Alyssum maritimum, Collinsia grandiflora, Convolvulus minor, Kaulfussia amelloides, Lopezia racemosa, Sanvitalia procumbens, Saponaria calabrica and varieties, Silene pendula, S. Schafta, &c., Venus's Looking-glass (three colours), Clintonia elegans, Lobelia speciosa, and Nycteria selaginoides. The last three should be sown in pots, and pricked-off and hardened-off before planting. Then there are Marigolds, Stocks, Asters, &c., that may be reared in a slight hotbed or in a greenhouse, which will be very useful and beautiful. Such annuals as Virginian Stock and Nemophilas may also be kept on by sowing in March, May, and August. Not to enlarge at present, you will find much to suit you in the first volume for 1863, Vol. IV., New Series; and you will find a paper just to suit you in No. 110, page 321.

EARLY PEAS ON CLAYEY SOIL.

How to grow early Peas without the trouble of sowing them under glass, transplanting, and coddling afterwards is a problem, I think, many of your readers would be glad to solve. Even if they have plenty of room it could be well used for other purposes, such as bedding plants. But the few remarks I intend making are more for persons not having the above-named conveniences, the saving of labour being the principal object.

Many, I know, will dispute the utility of steeping seeds, I differ in that respect. Not only steeping Peas, but many other seeds, such as those of Spinach, Radish, Turnip, and Onion, is advantageous.

For the last three years I have adopted the following plan with Peas. I steep them in warm water for twelve or fourteen hours, drain-off the water, and mix sand or light soil with them, and put them by for a day or two till nicely sprouted. I have sown them with sprouts an inch long. I then sow them in drills in the usual way, covering with light dry soil or ashes.

I have tried this plan against Peas sown in pots and turned out when 6 inches high, and I find little difference in their earliness, the pot Peas having the most sheltered situation, care in watering, &c., bestowed on them.

I usually sow during the first fortnight in February, and find after trying many kinds that the following three sorts sown at one time form a good succession: Sangster's No. 1, Auvergne, and Ne Plus Ultra.

The ground is well manured and thrown up into ridges 2 feet wide during winter. The soil is very heavy and cold, the subsoil, a stiff clay, having been brought to the top, which is much against early sowing.—J. T. CREED.

PUTTERIDGE BURY.

THE residence of Colonel Sowerby, three miles and a half from Luton, has been several times described in our pages; and as we had heard much of the general gardening, and, perhaps, more especially of the flower gardening on the bedding system there, we went down in the month of August expecting to find everything burnt up, as Mr. Fish had been writing most dolorously on the want of water. We endured a good pelting from a thunder shower in going from Luton, which put our coadjutor in the best possible spirits, as he expected to get an inch or two of water in his tanks, and little cared he for our having the bloom taken off our costume.

Though we had evidences of the great drought in that part of that country, we were surprised to find so little appearance of it in the garden, and, perhaps, least of all in the flower department. That was, no doubt, much owing to the means adopted, as frequently described in our pages. We were certainly surprised at the massive and effective combination and contrast of flowers and foliage, and the great variety produced by the still greater simplicity in the arrangements. We did not notice a single bed or border in which there was a blank: scarcely an inch of soil could be seen anywhere for masses of bloom; and such attention had been paid to the natural heights and modes of growth of the plants, that though the colours were distinct when meant to be so, there was scarcely a particle of training of any kind at all perceptible, though no doubt that training had been given, and hence in a great measure the economy with

which such a garden can be kept in comparison with one where much pegging and training are resorted to. This was all the more pleasing, as we were informed that, owing to the force of the wind in such an exposed place, there was scarcely a plant that was not secured, but the means of doing so could not be seen without close inspection.

The entrance to the mansion is on the north side. Westward from it extend the offices, stable-yard, and then the

kitchen garden. On the east side are a terrace, beds, &c. On the south side a verandah 370 feet long, going on to the kitchen garden and stable-yard. Part of this verandah near the west end is formed into a large conservatory. In front of this verandah is part of the flower garden. In front of the south wall of the kitchen garden are placed the chief ribbon-borders with a walk between them.

The following is a rough sketch of part of the ground:—

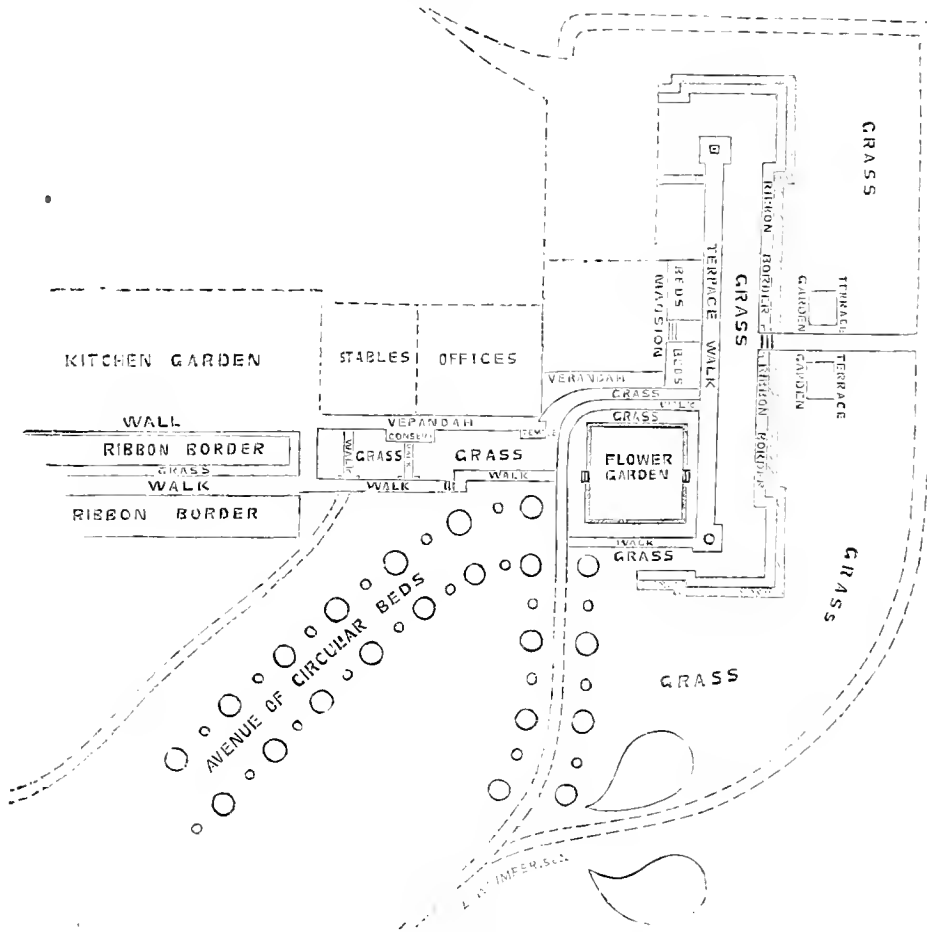

We will glance at the east side of the house first. Section 1 will give an idea of the surface-outline.

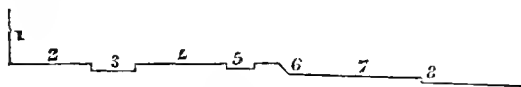

Section 1.

- | | | | |
|--|------------------------|------------------------------------|----------------------------------|
| 1, Wall of mansion. | 3, Walk 12 feet wide. | 5, Border 5½ feet wide, with broad | 7, Ground on which there are two |
| 2, Stone pavement, 18 feet wide, as far as the mansion goes. | 4, Grass 20 feet wide. | 6, Slope of turf. | groups of beds. |
| | | | 8, Walk. |

This ground below the terrace, besides these beds, is planted with Thorns and evergreens. Length of terrace nearly 400 feet, most of it extending south of the mansion. The stone pavement, 2, on section, is divided into three parts, one in the middle, in front of a glass case or small conservatory, communicating with an ante-room.

The other two spaces on each side have each 15 beds in front of dining-room and drawing-room windows respectively. Both sides were planted alike and in the low pincushion style, so that all could be seen at once from the windows. Two feet of stone separate the beds from the house, gravel, and grass at north and south ends, and 1 foot separates the beds from each other. The beds are 4½ feet square. There is nothing artistic in the arrangement, but the beds look beautiful when planted.

They are arranged in the following order:—

- | | | | | |
|---|---|---|---|---|
| 9 | 6 | 3 | 6 | 9 |
| 8 | 5 | 2 | 5 | 8 |
| 7 | 4 | 1 | 4 | 7 |

The following is the planting of one side:—

- 1, Geraniums Stella and Cloth of Gold.
- 2, Madame Vaucher Geranium and Verbena Purple King.
- 3, Geraniums Stella and Golden Chain.
- 4, 4, Calceolaria Aurca floribunda and Lobelia speciosa.
- 5, 5, Geraniums Scarlet, Garibaldi and Bijou.
- 6, 6, Calceolaria Aurantia multiflora, edged with dark Heliotrope.
- 7, 7, Geranium Brilliant, Variegated Alyssum, and Charwoodia Verbena.
- 8, 8, Geranium Christine and Tropaeolum elegans.
- 9, 9, Geranium Boule de Feu, and Verbena Mrs. Holford, edged with Christine.

The border, 5, on section 1, is more than 500 feet long, as it goes round the end of terrace. The circular dots along

the centre, about 8 feet apart, were planted alternately with *Chenopodium atriplicis*, *Lupinus Cruickshanki*, and *Salvia fulgens*, and were grown into massive blunt pyramids of 5 feet in height and from 2½ to 3 feet in diameter. The body of the border was planted in straight rows, the centre being a fine row of *Aurantia multiflora* *Calceolaria*, the next

dark *Victory Calceolaria*, with a broad band next the grass of *Cerastium tomentosum*. The other side the same. The tall plants along the centre were intended somewhat to break the views of the ground below the terrace.

The groups, one of which is represented beneath, in front of about the middle of the terrace, with steps and a walk

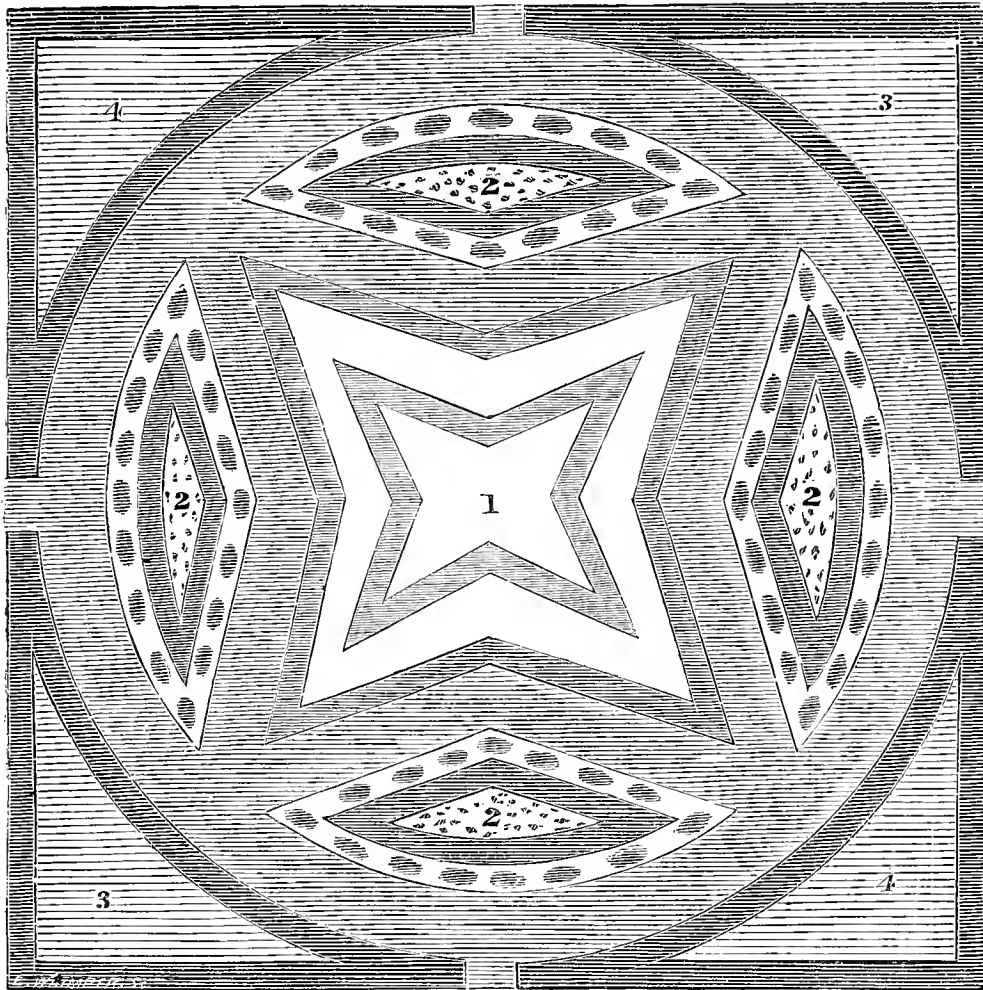

- | | | | |
|--|---|---|---|
| 1. China Daisy White, Lady Colville Geranium, White Ivy-leaf Geranium, Crimson Ivy-leaf. | 2, 2, 2, 2. Bijon Geranium, Tom Thumb Geranium, edging Alyssum and <i>Lobelia speciosa</i> mixed. | 3, 3. <i>Aurea floribunda</i> , with <i>Verbena</i> Purple King edging. | 4, 4. <i>Prince of Orange Calceolaria</i> , with <i>Verbena pulchella</i> edging. |
|--|---|---|---|

between them, and the beds all surrounded with grass, there being 5 feet between the walk and the beds, had a very fine effect from the terrace, and also from the higher windows of the mansion. The plants first named formed the centre of the beds. Both sides were alike.

Whilst examining these from the terrace we have also longed to look at more narrowly a sunk garden on the south front of the mansion, with the terrace as the boundary on the east and south sides of it. For the position see the accompanying section:—

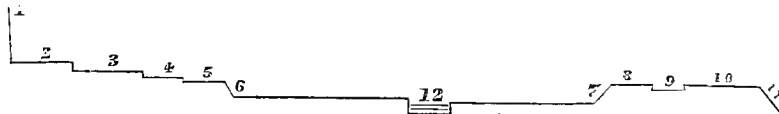

Section 2.

- | | | |
|-----------------------|---|--|
| 1, House. | 5, Grass, 8 feet. | 11, Slope to ground beyond, which goes on to park. |
| 2, Verandah, 10 feet. | 6, Sloping grass. | 12 Is a fountain in centre of sunk garden, which is 100 feet square. |
| 3, Grass, 10 feet. | 7, Ditto. | |
| 4, Walk, 8 feet. | 8, Grass. | |
| | 9, Walk. | |
| | 10, Grass, on which are raised Ivy-beds 10 feet in diameter, with iron rods across. | |

This is so planted as to be seen all across from the walks round the garden; and though there was little difference in the height of the plants, the tallest were placed next the fountain, and the lowest at the four corner square beds. This is the garden that our worthy coadjutor, Mr. Robson, finds so much fault with, so far as the tameness of the figure is concerned, as hardly anything can be more simple. But

the mere figure is little thought about, amid such a gorgeous display in summer! We heard an eminent connoisseur say that he thought there might have been an improvement if the four corner beds had been brighter. We may just add that each bed was a mass of bloom, and pretty well level all over.

(To be continued.)

POISONOUS GARDEN PLANTS.

HAVE any of the readers of this Journal had experience in the evil effects of Rhododendrons, Laurels, or any other shrubs, on the animals which have partaken of them?

I know for a certainty, that in very severe winters hares and rabbits are not particularly nice as to what they eat; and I have seen scores of Hollies, Broom, Hazel, and even quickset hedges, barked as high up as the animals could reach; but at the place this was done there were no Laurels or Rhododendrons. My purpose, however, is to ask more particularly after poisonous plants or shrubs, and whether they are obnoxious or otherwise to cattle. The common Laurel is certainly not a rank poison, although I by no means affirm it to be harmless; and I have known a rather serious case of poisoning attributed to the Rhododendron. Can your readers confirm this?—J. ROBSON.

PRUNING AND MANAGING OLD PEACH TREES.

OTHERS besides "ERIN" may possibly have some old Peach trees, and a few hints may not be unseasonable. Age in trees, as in man, is characterised by decrease of vigour; but for all that the trees may be possessed of vitality enough to produce fruit. In fact, old trees are more fruitful than those which are free-growing, and are apt to produce fruit to an extent that threatens their existence. Year after year do those old trees continue to produce a plentiful crop of fruit with but little pruning and attention. The difficulty seems to be rather to induce them to grow than produce fruit; and beyond the dying away of an old branch and but small annual growths in proportion to the quantity of fruit produced, they present no sign of their approaching end. Our correspondent does not furnish us with any particulars; we are, therefore, left a wide field for surmise.

Old trees, as said before, are mostly weak in growth, and anything tending to increase their vigour must necessarily be of great service to them. No manure is so beneficial to the Peach as that of a cold nature, such as cowdung and rich compost. I have found stable, pigeon, hen, and other hot manures too highly stimulating for old plants, and liquid manure, especially that containing a large proportion of urine, destroys rather than renovates trees in health, though weak and old. Hot manures decompose too rapidly, and the matters they contain are washed down by watering in too powerful doses to the roots, and these are consequently destroyed by an excessive supply of strong food. Strong food is only suited for strong constitutions, it completely deranges old trees, and those not strong by nature; the roots cannot absorb nor the leaves digest it, and the trees consequently perish. The same food in a less concentrated form is more suitable for them. The business of the root is to collect the food in a diluted state, to transmit it upwards to the leaves, where a quantity—an immense proportion—is given off again; but all that is necessary or required for the constitution of new parts and the repair of the waste in the old is retained, and becomes part and parcel of the trees. Old trees do not require their food so strong as young trees.

To improve Peach trees I have found nothing better than placing cowdung in its fresh state, about an inch thick, over the surface of the border, doing a foot at a time, and then pointing the manure in with a fork, taking care not to go so deep as to injure the roots, and a neat finish is given the whole by covering the surface with an inch of fresh compost. Strong but friable loam is the best for covering the surface. This surface-dressing is best given either in autumn, for then the manure is in a great measure decomposed before spring, or in spring after the fruit is set. If applied when the trees are on the point of expanding their flowers, and the soil is then watered, too much food is likely to be thrown into the flowers, and they fall without setting. Manure should not be given any plant unless there be leaves to enable the plant to make use of it. The manure if applied in autumn will have parted with a great deal of its virtue by spring, and have passed into the soil above and below it, and when watered in spring it is in a form calculated to afford direct food to the trees, and, consequently, to in-

vigorate them. The same may be said when the manure is applied after growth takes place. Water washes the fertilising principles down to the roots, and the trees, therefore, obtain immediate support, and subsequent applications of water mix the manure with the soil and carry some part of it to the roots, or these extend and reach it. Old trees thus manured are not long ere they show a marked improvement in their foliage; in fact, they seem to become reinvigorated.

In some cases where the trees are very old, and the soil much exhausted, taking away a quantity of surface soil and replacing it with fresh compost is of great service to the trees. Good strong loam with about one-third of cowdung one year old, and thoroughly mixed, is the best for this purpose. The roots should not be covered more than 6 inches with the fresh compost, and the operation is best performed in the autumn, and it should be done without injuring the roots. If these are near the surface a top-dressing of rich compost, of which fully one-half should be cool manure, as cow or sheep dung, should be neatly forked into the border, so that its fertilising agents may not be evaporated in the atmosphere before water is applied, and they are washed into the soil and pass down to the roots. The next best plan, presuming the above manures cannot be had, or are inconvenient to apply, is to water the borders with weak liquid manure during the summer—say at every alternate watering, until the fruit changes for ripening, when it must be discontinued. The manure water should be heated to a few degrees higher than the temperature of the border, and be much diluted with water, soft being the best for the purpose. If it be as thick as mud it should be brought by dilution to the appearance of pale ale, and that is strong enough for anything. One ounce of Peruvian guano dissolved in a gallon of rain water, and applied to the trees at every alternate watering, will much improve their appearance.

In pruning old trees the cultivator should have in view the supplying of the tree with young wood, and the removal of old useless parts, more than trying to form a handsome tree. The small, twiggy shoots from weak main stems, especially if they are old, are to be removed, and a young shoot brought up or down into its place. The main branches should be distributed fan-fashion, and at such distances that from 9 inches to a foot will be left clear between them. A proper number of the shoots of the last year should be retained at a certain distance from each other along the main branches to produce fruit, and not nearer than 9 inches from each other, nor farther apart than 1 foot. The first should be left as near the bottom of the branch as possible, and the others 9 inches apart from it along the branch, leaving the last 9 inches from the extremity of the branch. It is best to leave these fruit-producing shoots on the upper side of the branch only, as when they are left on the lower side the tree becomes too full of wood, and light and air cannot reach to the leaves.

The shoots should be trained straight, and at an angle of 45° from the centre of the tree, and the fruit-producing shoots at an angle of 45° from the shoots they spring from. If on a trellis they are to be neatly tied with matting or Cuba bast. If they are not more than 9 inches in length they should not be shortened; or if there be nothing but fruit-buds on them, but only the short branches with a wood-bud situated at the extremity of the branch, they must not be pruned, but tied-in their full length. On the other hand, if the shoots have two fruit-buds and a growing bud between them, they may, if more than 9 inches long, be pruned to one of these, always taking care to leave sufficient buds below the pruning to provide for a crop. It is necessary to leave a wood-bud at the extremity of the shoot to draw the sap into the fruits that are presumed to be situated below it. This pruning and training is best done when the trees commence swelling their buds, for the uninitiated are then better able to distinguish wood from fruit-buds. All shortening of the shoots should be to a wood-bud either by itself, or situated between two fruit-buds.

When the fruit is set and the shoots growing, the process of disbudding should commence. This is removing all shoots not wanted either to draw the sap into the young fruit or to form shoots for next year's bearing. The latter should be left as near the old branch, or the place from which the previous year's bearing shoot proceeded, as

possible, and this shoot is to be trained to the trellis to supply the place of the shoot now producing fruit. At the extremity of the shoot producing fruit a shoot should be retained, and when it has made three leaves it is to be stopped to that number, or it may be allowed to grow if it be wanted to fill-up vacant space. Shoots with fruit at their base are to be stopped to three leaves, and so on through the tree. No shoots are to be left but those wanted either to extend the area of the tree, to draw the sap into the fruit, or to form fruit-bearing shoots for another year. Shoots not wanted are to be rubbed-off closely. It is better to go over the tree twice or thrice at intervals, and disbud a portion of the shoots each time. The fruit should be thinned, leaving one to each shoot; but to make sure of a crop it is best to leave two or three to each shoot, but not more than three, for that is as many as any tree can bring to perfection. One fruit in every square foot is a good crop, and quite as many as can be had consistently with size, quality, and flavour. After this the trees will only need an adjusting of the shoots occasionally. Any shoots not producing fruit should be removed at once, and that springing from the base of the bearing shoot should be trained in its place to supply bearing wood for another year. The leaders are to be shortened at the spring pruning to half their length if weak, and two-thirds if very weak, and shoots left along them in summer to supply fruiting shoots 9 inches apart. If the leaders be very strong they should be pruned back about one-third of their length. All pruning when the leaves are off the trees must be to a wood-bud. No stopping of the shoots is necessary, except in the case of those left to draw sap towards the fruit, as doing so causes the production of a quantity of useless spray.

In autumn the shoot that has produced fruit is to be cut clean out—*i. e.*, to the shoot destined or provided to supply its place, unless it be a leader, or furnished with a shoot at its extremity to fill vacant space, when it must, of course, be retained. The short spur-like shoots left to draw the sap into the fruit are to be removed soon after the fruit is gathered; for although these short spurs might yield fruit the following season, yet they do not improve the appearance of the tree, nor give fruit nearly so fine as that from regular shoots.

All the air possible should be given from the time the buds begin to swell, and the atmosphere must be kept moist by frequently sprinkling the paths, &c. The air should be kept rather dry when the flowers expand, to assist in airing the pollen and distributing it. An occasional shaking of the trellis when the trees are in full bloom also helps to disperse it. The best plan, however, is to set the blooms with a camel-hair pencil, and it is a good sign if the bees are busy at the flowers. The trees having set their flowers are to be syringed twice daily, morning and evening, forcing the water against the under side of the leaves, and this is the best of all preventives to the attacks of the red spider. A current of fresh air should blow upon the trees continually, lessening the quantity by night, but leaving a little on even then if the heating apparatus be sufficient to provide for their safety. When the trees are in bloom the temperature should be 45° at night, with a rise of 15° by day with sun and abundance of ventilation. After the fruit is set let it be 50° by night, and this should be gradually raised so as to have it 55° at night by the time the fruits commence stoning. A rise of 5° on dull days, 10° to 15° on cloudy with clear intervals, and 15° to 20° with bright sun should be allowed the trees by day. The temperature may be increased to 60° at night after stoning has been completed, and this is high enough for the Peach at any time afterwards. The syringings are to be discontinued after the fruit changes for ripening; and beyond a syringing after it has been gathered, to free the leaves of dust, no more syringings are required. The soil of the border should at all times be kept healthfully moist. Copious waterings must be given whilst the trees are in bloom, and afterwards until the fruit begins to ripen, when they must be gradually diminished, so that they may be discontinued altogether by the time the leaves begin to fall. After the fruit has been gathered, air and every encouragement should be given to promote the hardening and ripening of the wood, on which depend the prospects of the ensuing season. Insects must be kept under, as these suck out the juices of the

leaves, and hinder the formation of perfect buds and sound well-ripened growths.

At all times shoots springing from the base of the tree or main stem are to be encouraged, and as these advance in growth old branches may be cut away, and in this way old trees may be resupplied with young healthy shoots.

Such are a few hints hastily strung together, but which I hope may be of service to our correspondent and others.—G. ABBEY.

WORK FOR THE WEEK.

KITCHEN GARDEN.

THE continuance of fair weather will permit the operations that peculiarly belong to this month to be proceeded with. *Asparagus*, prepare soil for new plantations when required. This is an operation worthy of the greatest care, for if properly done the plantation will last for many years. The principal requisites are good fibrous loam and dung. Where the soil in the garden is what is technically termed "old," add a third of the whole of maiden loam, and put 6 inches of good rotten dung over the whole surface; trench at least 2½ feet deep, and drain if necessary; then add as much more dung, and dig it in as deep as is generally done for general crops. Mark off the beds 4 feet wide and 2 feet for the alley; then mark the rows in the bed, one in the centre and one at each side; lay a ridge of maiden loam, leaf mould, and sand in equal parts along where each row is to be planted, and on these ridges place the plants. They may be either one or two years old, but not more than two, and should be taken up with great care, so as not to break the points of the roots. When placed on the ridges with an equal portion of roots on each side, cover them to the depth of 2 inches with pure sand when it can be procured, which will induce the plants to throw out a number of young roots, which, passing through the sand, will seize with avidity on the more nutritious food prepared for them. Above the sand add 4 inches of loam over the crowns; and should the season prove dry, mulch between the rows, and give occasional waterings with liquid manure. Give plenty of air to these and all other crops in frames. *Cauliflowers*, plant-out from the seed-pans all the young plants before they become too much crowded, and, if needful, make fresh sowings. *Carrots*, sow in frames, and thin those already up; also sow a crop in the open ground. *Lettuce*, sow a crop of *Cos* in frames and in the open ground. *Peas*, to provide against failures in vegetable crops already sown, or where the climate or soil is too cold to trust to seeds for the present in the open ground, we advise sowing these and Broad Beans, &c., either in small pots for their more easy transfer to the open ground, or when the quantity is considerable cut fresh pieces of turf 1 foot long and about 4 or 5 inches wide, turn the grassy side downwards, and form a channel along the centre of the upper part, in which sow the crop as you would in the open ground. Managed in this way they will sustain but little check, and will root through the turf into the soil, and grow away freely. *Potatoes*, plant for the first crop in a warm sheltered situation, if not already done.

FLOWER GARDEN.

Give lawns a good rolling after wet, and, as was stated lately, if it be necessary to take up any of the turf for the purpose of levelling the ground, the sooner it is done the better. Proceed with cutting the edgings of walks, and keep them clean, and roll frequently to make them firm, and also to prevent the growth of weeds. See to even small plants being secured against wind, for these are often greatly injured by being blown about, especially if recently transplanted: small stakes and a few minutes' work would prevent the mischief. As before observed, see that all planting is completed forthwith. Improve as much as possible all outlines. Plant fresh masses or groups where necessary, and introduce specimen plants where fitting opportunities offer. Do not plant single specimens in recesses; these as a general rule should be carefully preserved to give deep shadows, and to throw the prominent features into bold relief. Finish pruning *Roses*; in doing so thin out the weak shoots, and shorten the strong and well-ripened to four or six buds, according to their strength. Strong-growing kinds, such as *Brennus*, *Fulgens*, *Triomphe*

d'Angers, and others of similar habit, with most of the Noisettes when budded on tall stems, make beautiful objects, if, instead of being shortened, the shoots are turned down and tied to the lower part of the stem, so as to form a balloon-shaped plant. In the borders sow Sweet Peas and Larkspurs, and prepare for the general sowing of annuals next month.

FRUIT GARDEN.

Prune Raspberries. Any Gooseberries and Currants not previously pruned should forthwith be attended to. Make arrangements to procure a sufficient supply of pea-sticks, and collect fir boughs to protect the blossoms of Peach and Apricot trees. Gooseberry and Currant bushes occupy much less space in a garden trained to stakes across rods, as practised by Mr. Tombs, gardener to Major-General Fox, Addison Road, Kensington, and afford a greater amount of fruit.

GREENHOUSE AND CONSERVATORY.

As a general rule, when specimen plants require shifting, the best time to perform the operation is from the beginning of February to the middle of March. The advantage of spring-shifting is, that you provide a good store of roots for the summer growth, and hence you are almost sure of the plants setting their bloom for the following season; but if you shift them in the summer and autumn after they have bloomed there is a great probability of their making a late growth, and not setting bloom at all. However, it must not be inferred that all plants are to be potted at the same time, as, under favourable circumstances, it may be necessary to shift certain plants more than once, twice, or thrice, within twelve months. In potting, for all delicate-rooted plants, such as the finest kinds of Heaths, Epacris, &c., use turfy fibrous peat, with a liberal admixture of sand.

STOVE.

Some little increase of temperature may take place here, and that chiefly in the afternoon, by shutting up early, at the same time using a sufficiency of moisture. Look over the fastenings of Orchids on blocks or in baskets, and remove the wires where necessary. Examine and shift all plants that require such attention, and cut back after flowering such kinds as it may be desirable to increase by cuttings, or to make more shapely.

FORCING-PIT.

This useful structure will now supply Hyacinths, Tulips, Lilacs, Sweet Briar, Azaleas, Kalmias, &c., to give beauty and fragrance to the conservatory. The rich yellow flowers of *Cytisus racemosus* will add to the general effect. Take care to keep up a regular succession, and fumigate occasionally to keep all clean. Temperature 65° to 75° by day, 55° to 60° by night.

PITS AND FRAMES.

Alpines and other rare plants in pots to be looked over, all decaying matter to be removed, and the surface of the soil stirred up. Sow seed of *Salvia patens*, and of *Lobelia speciosa*, to be started in heat. Put in cuttings of *Petunias*, *Verbenas*, &c., for bedding-out. Keep up a good growing heat in the cutting-frame. The thermometer to be from 65° to 70°.

W. KEANE.

DOINGS OF THE LAST WEEK.

KITCHEN GARDEN.

Dug and trenched ground. Sowed Peas and Beans, planted some early Potatoes, gave plenty of air to those in beds, also to Radishes, Lettuces, Carrots, &c. Cleared dead leaves from vegetables outside, watered Asparagus in frames, and washed the glass to give all the light possible that the tops may be nice and green. Took up a little more Rhubarb and Sea-kale. Swept the beds bearing Mushrooms slightly with a hair-broom, and as no covering is on them, we have pretty well conquered the snails and slugs. Potted-off more Dwarf Kidney Beans, sowed some early Basil, &c., and performed other work of routine.

FRUIT GARDEN.

Full-pruned Currants, and more sparingly pruned Gooseberries, so that something may be left for the birds, and syringed them all with a rather thick mixture of clay, cow-dung, soot, and lime. We have used frequently in pre-

paring the above wash strong laurel water, made by chopping laurel leaves and young stems with a bill-hook, or bruising them with a mallet, placing them in a barrel and covering them with boiling water, and putting an old sack over the top. Such water may be used strong for this purpose, and some sulphur lime water will also be good for making the pecking of buds unpleasant. Already we have had to net some Plums, on which the birds had commenced in earnest. A few boys with bat-folding nets took twenty dozen the other night from a piece of Laurels, and we candidly own that we were so wanting in feeling as never to ask the boys what they meant to do with them. Nailed and pruned as weather permitted and opportunity offered, our chief strength just now being directed to rake leaves before they all blow away. We believe we could collect more if we raked before the leaves were much more than half down, as after the trees are bare the wind takes off a good share before we can rake, as that might interfere with the game for shooting parties. Where game is highly preserved and no birds' nests are taken, and the garden is near the preserve, it will, ere long, be found that the garden will yield little unless everything is well protected by netting. When that is done there will be a chance that the birds will only get their proper share, instead of leaving the gardener scarcely the gleanings. This would satisfy alike the humanitarians and the utilitarians, as but for the destruction birds make few would wish to hurt or even curtail unreasonably the numbers of the sweet little creatures, as there can be no doubt that they do us good as well as evil. But say and argue as we will, it is not pleasant to have the most of our fruit-buds gnawed through, our Peas grubbed up, and the best Cherries and Strawberries holed or carried off. Nets are of no use for the Cherries, &c., unless they are kept some 15 inches from the wall, tree, or plant, and well secured and no hole left. Even when small hooked sticks keep the net from the wall, we have seen blackbirds fly at that part of the net between the sticks, and the momentum thus given would bring the net close to the wall, and enable the bird to take a Cherry or a part of one through the net. The very sight of a net is often an inducement for them to pry and investigate what is underneath it. Difficulties, just as in the case of a higher intelligence, seem only to whet the desire to overcome them. Could the birds only keep cool when disturbed and fly quietly to the hole by which they entered, few would be caught by men or boys more flurried than themselves.

Smoked an orchard-house again before pruning, washing to make all safe. Gave a little water to Strawberries, potted-off Melon plants, temperature about 60° at night, and a rise from sunshine when it could be commanded. Peaches, Vines, &c., much as in previous weeks.

ORNAMENTAL DEPARTMENT.

Proceeded with pruning Laurels, making turf edgings right, wheeling a little half-rotten leaves on some flower-beds on a frosty morning; the beds being previously ridged up, the manure will be spread over the ridges for a short time to be sweetened and frozen if possible, and then the ridges will be turned over to be still further exposed to the air. Swept and rolled walks, as on most gravel a greenish slime is apt to come on the surface after such dripping weather. In some frosty mornings scrubbed the walks well with an old hard birch broom, which removed a good deal of the green matter, and any small weeds that might be present, without moving the smooth surface of the gravel in the least. This often makes a walk more solid and firm in spring and summer, and quite as bright as digging it over, treading, levelling, rolling frequently, and all the rest of it. The walks here which have been admired by connoisseurs, are too shallow for digging, and the surface has been unbroken for many years, except in shady places where they would become greenish, and such parts were either scraped or hoed slightly, and raked when dry and sunny.

Looked over Hollyhocks and herbaceous plants: find the first in the little mounds of dry burnt clay and rubbish all right, at least mostly so, and few things are more effective in front of a bank of Laurels. All such plants as Auriculas, Polyanthus, the better Primroses, Carnations, Pinks, double Wall-flowers, Stocks, &c., in pots, should still be kept rather dry, which will be a great preservative against severe frost if it should come. All the air possible should be given in mild

weather. If dripping, elevate the glass or other covering back and front that there may be plenty of air, and yet the wet be kept out. The same rule will apply to all half-hardy things in cold frames, turf, earth, and other pits, but even they must be treated according to their nature. For instance: old Scarlet Geraniums packed away in faggot-style beginning to break, should now receive a little water at the roots if the soil is very dry, but the tops cannot well be kept too dry. There is a bed of young Calceolarias as thick as they can stand, and we do not want to move them into an earth pit just yet; they like moisture, but were we to water much at the root they would injure each other, and very likely get yellow leaves, and insects too, of which they, owing to the hardy cool treatment, are as yet free. A slight skiff with the syringe is better, therefore, for them under the circumstances than much watering, and even a slight dewy drizzle in a mild foggy day so as to wet all the foliage and just the surface of the soil, is also better in their present condition than watering. The less water plants have at this season as a general rule, provided they are not allowed to flag, the better they will succeed afterwards. Of course an exception must be made in the case of plants in bloom, and standing in a high temperature. The temperature must regulate the water-pot in a great degree. With the exception of the Amplexicaulis Calceolaria, all other Calceolarias used for the flower garden will thrive better afterwards if they never have fire heat in any shape, and they are more easily kept in cool places out of doors than most other bedding plants, as they are not inclined to damping, but rather relish a moist cool atmosphere when young, though they like a warm bright atmosphere and coolness for their roots in order to bloom well out of doors.

We may just mention that we have pruned a lot of Fuchsias that have been kept rather dry all the winter, and placed them in an average heat of 45° to start them before repotting. Thinned boxes of Scarlet Geranium cuttings inserted in the autumn, and which were becoming as thick as Mustard-and-Cress-boxes, though where we are to find room for the half of them before we turn them into earth and turf pits seems a mystery, with all our knowledge of cramming. We find that the cuttings we inserted in old spouting-troughs, and placed in a pit a yard from the glass, are doing well, and not drawing, owing to their needing no shade by day, and no cover by night. We would have liked better if they had only been 2 feet from the glass. To our window-gardening friends we would say, Keep all plants clean, free from dust, and except for bulbs, Violets, and other things in bloom, water moderately. If Hyacinths do not rise freely try the paper funnel over them, and keep them on the chimney-piece for a few days. We must give them a whole paper presently.

PELARGONIUMS.

We have just been giving a small shift to a number of Pelargoniums of a rather large size, and becoming quite pot-bound, and yet the pots are hardly large enough to support large heads of bloom, without extra attention being given. These plants had been potted in the autumn in light sandy loam, with a little peat and leaf mould. Similar soil, with a little more loam was again used, and after placing a little moss over the drainage, sprinkled with soot, a handful of nodules of old dried cowdung was placed over the soot, then a portion of soil, and then the fresh soil added in the usual way, with a few bits of the cowdung worked in as the work proceeded. Some pieces of charcoal would have been added, but we did not happen to have any. Of course, the plants at all dry had been watered a few days before repotting. The cowdung had been collected in dry cakes in hot weather nearly a twelvemonth ago, and was stored loosely, so that the cakes were hard and as sweet as a nut, and might be broken in bits by the hands of a lady without soiling her fingers. We are thus minute because we have several notes wishing for more particular directions, and stating that we ought to describe all operations as if to persons who had never seen these operations performed.

The keeping plants comparatively dry in winter, has brought to our recollection some half a dozen of inquiries how to cure and how to prevent the spot in Pelargoniums, and in a few words we will give the results of our practice on this subject.

1. When the brownish spots appear on the leaves of a

Pelargonium, we know of no means by which these spots which disfigure the plant can be removed.

2. We hardly think the spot is infectious farther than this, that other plants placed in similar circumstances will come to be affected in the same way.

3. Though it is unadvisable to keep a tainted stock of any plant, we do not think there is anything hereditary in this disease; as plants very much affected with the spot, when set out of doors, well hardened in their wood, and kept rather dry in summer, pruned in early autumn, potted in fresh soil when broken, and differently treated, showed no spotted leaves afterwards.

Now for the preventives of this spot, which appear to us to be as certain to keep it away as the opposite treatment will be sure to bring it on.

1. Keeping the soil dryish instead of moist in winter and spring, and, if possible, choosing a bright sunny day to give what little water would be necessary, and spilling as little as possible.

2. Setting the plants on a dry, solid substance, be it wood, slate, or stone, with air beneath as well as above the shelves, platform, &c., instead of standing the plants on beds of earth, ashes, &c. For extra fine plants it is a good plan to set the pot on the bottom of another pot reversed.

3. Keeping the atmosphere sweet, airy, and rather dry, instead of moist, close, and stagnant.

4. Giving air so early that all the foliage should be dry before the sun shines much upon it.

"In the multitude of counsellors there is safety," although at times attended with a little distraction; and, therefore, any friend who from his own practice can simplify or improve on these modes of prevention, will confer a boon on many Pelargonium-growers, and, more especially on amateurs.—E. F.

COVENT GARDEN MARKET.—FEB. 6.

The market is still well supplied with vegetables, Savoys, Brussels Sprouts, and other winter greens being plentiful. These are rendered much more tender if soaked in cold spring water for three or four hours previous to cooking—a fact which is not sufficiently known to the majority of cooks. Of French Lettuce, Endive, and small salads there is a good supply; and in Apples large importations have come in from Belgium, which is a great boon to the poorer classes, home-grown fruit being scarce and dear. A few Spanish Melons may still be had, and some excellent samples of new Black Hamburgs have this day made their appearance. Cut flowers are the same as last week.

FRUIT.

	s.	d.	s.	d.		s.	d.	s.	d.					
Apples.....	½	sieve	2	0	to 4	0	0	Mulberries.....	quart	0	6	to 0	0	
Apricots.....	doz.		0	0	0	0	0	Nectarines.....		0	0	0	0	
Figs.....	doz.		0	0	0	0	0	Oranges.....	100	4	0	10	0	
Filberts & Nuts 100 lbs.			0	0	0	0	0	Peaches.....		0	0	0	0	
Grapes, Hothouse.....lb.	10	0	15	0	0	0	0	Pears.....	bush.	8	0	12	0	
Foreign.....	1	0	2	0	0	0	0	dessert.....	½	sieve	6	0	10	0
Muscats.....	10	0	15	0	0	0	0	Pine Apples.....	lb.	5	0	8	0	
Lemons.....	100	6	0	10	0	0	0	Pomegranates.....	each	0	0	0	0	
Melons.....	each	3	0	5	0	0	0	Walnuts.....	bush.	14	6	20	0	

VEGETABLES.

	s.	d.	s.	d.		s.	d.	s.	d.					
Asparagus.....	bundle	8	0	to 12	0	0	0	Leeks.....	bunch	0	4	to 0	0	
Beans, Broad.....	bush.	0	0	0	0	0	0	Lettuce.....	score	1	0	2	0	
Kidney.....	100	3	6	5	0	0	0	Mushrooms.....	pottle	1	0	1	6	
Beet, Red.....	doz.	1	0	1	6	0	0	Mustd. & Cress, punnet		0	2	0	0	
Broccoli.....	bundle	0	9	2	0	0	0	Onions.....	tnshel	2	0	4	0	
Brussels Sprouts ½ sieve		1	6	2	6	0	0	pickling.....	quart	0	6	0	8	
Cabbage.....	doz.	0	0	0	0	0	0	Parsley.....	bunch	0	4	0	6	
Capsicums.....	100	0	0	0	0	0	0	Parsnips.....	dnz.	0	9	1	6	
Carrots.....	bunch	0	6	0	8	0	0	Peas.....	bush.	0	0	0	0	
Cauliflower.....	dnz.	3	0	6	0	0	0	Potatoes.....	sack	5	0	8	0	
Celery.....	bundle	1	6	2	0	0	0	Radishes doz.	bunches	1	6	2	0	
Cucumbers.....	each	2	0	5	0	0	0	Rhubarb.....	bundle	1	0	0	0	
Endive.....	score	1	3	2	6	0	0	Savoys.....	per doz.	1	6	2	0	
Fennel.....	bunch	0	3	0	0	0	0	Sea-kale.....	basket	1	6	2	0	
Garlic and Shallots, lb.		0	8	0	0	0	0	Spinach.....	sieve	2	6	4	0	
Herbs.....	bunch	0	3	0	0	0	0	Tomatoes.....	½	sieve	0	0	0	0
Horseradish... bundle		1	6	4	0	0	0	Turnips.....	bunch	0	4	0	0	

TRADE CATALOGUES RECEIVED.

Hooper & Co, Covent Garden. *Spring Catalogue of Flower, Shrub, and Kitchen Garden Seeds.*

W. B. Jeffries, Arboretum Nurseries, Ipswich.—*Descriptive Catalogue of Plants, Seeds, Bulbs, &c.*

J. W. Mackey, 40, Westmoreland Street, Dublin. *Descriptive Seed Catalogue and Cultural Guide.* 1864.

TO CORRESPONDENTS.

* * We request that no one will write privately to the departmental writers of the "Journal of Horticulture, Cottage Gardener, and Country Gentleman." By so doing they are subjected to unjustifiable trouble and expense. All communications should therefore be addressed solely to *The Editors of the Journal of Horticulture, &c.*, 162, Fleet Street, London, E.C.

We also request that correspondents will not mix up on the same sheet questions relating to Gardening and those on Poultry and Bee subjects, if they expect to get them answered promptly and conveniently, but write them on separate communications. Also never to send more than two or three questions at once.

LEAVES BROWNED AND SPOTTED (*Rose, Guernsey*).—The Azalea leaf is much infested with thrips. The house should be smoked with tobacco, filling it with the smoke. You will find the pest on the under side of the leaf. The Camellia leaf is spotted by keeping the air too moist and close. Give more air, and in future omit the liquid manure in watering the Azaleas and Camellias. Liquid manure, however, would not spot the leaves, but it is not suited for Azaleas and Camellias. We fear the peat you employ is not suitable for your plants; but if it is sandy, and crumbles freely when rubbed with the hands, without becoming a soap-like lump, it is all right. See to the drainage of the Camellias, and be sure it is perfect. Whatever you do, get rid of the thrips on the leaves, and whenever you see them again smoke the house immediately. The foliage should be dry when the house is smoked.

FLOWER-GARDEN PLAN (*A. A.*).—With the materials you mention we would bill the centre bed with *Calceolaria*, either mixed or broad-edged by the *Amaranthus*, and the two side beds with Tom Thumb, and an edging of variegated *Alyssum*. The border we would plant with the *Mimulus* in dots in the centre, and then with *Lobelia* edged with *Cerastium*. The lean-to house would do best. The *Verbenas* were taken off too late, unless placed in a close warm place.

CONSERVATORY ALTERATIONS (*G. Briggs*).—No doubt it would be desirable to have some of the sashes to open; but as the house is lofty in proportion to its length and width, we would like to give it a fair trial before making the alterations spoken of. If we understand the gable ends rightly, a great body of heated air will pour out at these ends, and if opened to the full there will be a great draught through the sixteen five-inch openings in front. Such lofty upright houses are less influenced by the sun heat than smaller lean-to houses. In the meantime we would have a ventilator at back opposite the doorway, and then, if necessary, increase the size of the ventilators in the gable; but one more ventilator at back we should like to try first. In such a house the door could be half open from April to June, and again in autumn, and might be open all the summer months, and all the ventilators also. If these ventilators are opened early in spring, autumn, and winter, we have a strong opinion that the house will not become so hot as you imagine. In the heat of summer the sun will strike obliquely on the upright glass. However, there can be no objection to the front glass being made moreable.

CAMELLIA FLOWER-BUDS NOT EXPANDING (*A Subscriber since 1856*).—You will see a detailed consideration of the subject in our Journal to-day. The failure almost certainly arises from defective root-action; but you must judge for yourself after reading those details, what induces the defective root-action in your Camellias.

MANURE ON VINE-BORDER—INARCHING VINES (*An Amateur*).—Your Vines will do very well without manure at this season; the roots being inside the house, the soil temperature will be sufficient for ordinary forcing. The best way of inarching Vines is to unite green wood to green. After the Vines have grown 2 or 3 feet take a slice (about 3 inches long, and deep enough to reach the centres of the growths) from the sides of both the stock and Vine to be united to it, fit them nicely together, and tie with a piece of soft matting. Stop the stock when this operation is performed. In about a fortnight or three weeks the union will be sufficiently formed to allow of the inarch being nearly severed from its roots, and in a week more it may be cut entirely away. Then the tie should be undone and tied more loosely, and left on for a short time. The operation is so simple that you cannot but succeed with ordinary care.

SUPPLEMENT TO COTTAGE GARDENERS' DICTIONARY (*G. Brown*).—It will contain various corrections and additions, and bring down the details of gardening to the present time. It will not be able to give directions as to pronunciation.

PEACH CULTURE (*Westmoreland*).—Our "Fruit-Gardening for the Many" contains what you need. It can be had free by post if you enclose five penny postage stamps.

LADAGERIA ROSEA PLANTING OUT (*Ignoramus*).—If the surface of the border is some distance from the glass, it would be better to plant it in the border after the shoots have grown considerably. On the other hand, if the border has plenty of light, we should prefer putting in the plant now. There would be less likelihood of giving the plant a check by planting now than there would be when the shoots are considerably advanced.

MADAME VAUCHER AND CHRISTINE GERANIUMS (*B. H.*).—These Geraniums are not more tender than many others. They are rather strong growers, and bloom more freely when plunged in the beds or borders in pots. In a cold exposed situation in Yorkshire they did moderately well last season, and Lancashire is not colder than there.

SEEDS FOR AN ACRE OF KITCHEN GARDEN (*W. H. M.*).—A supply of genuine seeds for one year is not dear at four guineas. A collection at that price would contain everything needed all the year round, except Potatoes, Jerusalem Artichokes, culinary roots, &c. Why not trust such matters to your gardener? He would make out a list better than any seedsman can do it, and although the seeds might cost a trifle more, you would gain by the ability of the articles. Some seeds usually included in collections are not wanted, and these your gardener would leave out, and he would substitute others better adapted to the soil and your requirements.

SHAUBS FOR PLANT CASE (*Dublin*).—*Desfontania spinosa* would live in your plant case, but you must not expect it to flower. The small and broad-leaved Myrtle, and *Skimmia japonica*, would also keep green. There are no plants so suitable as Ferns, and these we should advise you to employ exclusively. No flowering plants will do any good in a plant case with a north aspect, and the same holds true of climbers. We know of none. All plants want light to do any good, and that they must have.

PYRETHRUMS—PANSIES, &c. (*E. F.*).—You will find *Pyrethrums* noticed fully in our next issue. The "Garden Manual" published at our office, price 1s. 6d., contains particulars of Pansy culture. Pansies do well in a shady situation, but not under trees.

CAMELLIA CASTING ITS BUDS (*Trin*).—It may have been occasioned by dryness at the root, wetness of the soil, sour soil, imperfect drainage, and sundry other causes, which are considered in to-day's Journal. Your other question is treated of elsewhere.

REGNEA'S IVY.—An *Old Subscriber* would be obliged by being informed from whence, and how long since, this Ivy was introduced.

VARIATION OF GYMNOGRAMMA PULCHELLA (*G. Edwards*).—The golden colour is not common, but has occurred before with *G. calomelanos*, which in the Oxford Botanic Garden has produced both gold and silver portions. The other appears to be a sulphureous tartarea, or some sport coming between tartarea and *Martensii*.

CUTTING-DOWN YOUNG VINES (*J. D., Ilford*).—Plant them in your house, rub-off all the upper buds except the lowest three, and when the lowest shoot from these has become about 6 inches long, then cut the stem away just above it.

VERENAS (*J. Horton*).—Any of the principal florists who advertise in our Journal could supply Madame Jenson, Paul Tiresas, Faust, and Made-moisele de la Nalline. We cannot specially recommend any florist.

MIMULUS CUPREUS AND MACULOSUS (*A Subscriber, Cirencester*).—There is little doubt but plants of these raised from seed sown in February will flower during the summer, as they are fast-growing plants and quickly come into flower. The hybrids of the maculosus stamp like a rather damp or shady position, especially in the hot summer months; and planted out, the north side of a wall exactly suits them.

HOTBED MAKING (*E. A. P.*).—Taking for granted that horsedung forms the principal substance on which to rely for heating purposes, we may, in the first place, observe that it is better when it can be had without being heated much, or rather before it has heated itself into what may be termed the scalding process—i. e., when it has heated and become of a white musty colour. It is not spoiled entirely when in this condition, but is certainly injured. It may, however, be used; and mixed with other dung it comes round again wonderfully. Procuring a quantity of this dung, with as large a proportion of litter in it as may be, let it be thrown into a heap, and on the fourth or fifth day it will require turning, and perhaps even before that time if it appear very hot. Turning four or five days afterwards will also be necessary; and, if time will allow, a third or fourth turning will likewise be of benefit; but as it often happens that a hotbed is wanted before this can be accomplished, we may state that when the dung has a tendency to overheat it would be better not to build the hotbed too high, and to tread it well; not, however, too firmly, as we have known when this was done that it would not heat at all. When, however, the time and circumstances will allow, it is better to well sweeten the dung by repeated turnings before making up the bed, and a more lasting heat will be the result. Bear in mind at the same time, that if the bed be wanted in the first instance to raise seedlings, the time of preparing the dung need not be lost to them; for by some simple contrivance, which will readily occur to the operator, a small box, if even without lights, but covered in, may be placed on the side of the heating material, and pots, pans, or boxes placed on it. The seeds will be progressing towards germination during the few days in which the dung is being prepared for the bed for their reception. Of course it is necessary to take care that rank steam or heat above 85° does not come in contact either with the pots or the germinating plants. This, however, is easily guarded against; and when once a hotbed is prepared of materials properly sweetened, it is much better than when put too hurriedly together. Sometimes the admixture of a less active material than dung is of great service in checking and prolonging the heat; such substances ought to contain fibrous matter enough to resist decay for a time. For this object leaves of certain kinds answer very well, especially the harder and firmer description, as Oak, Sweet Chestnut, Beech, and some others; while soft leaves, which in themselves contain more water than fibre, heat quickly and as rapidly decay. Of this class Lime, Elm, and Sycamore are perhaps the worst; and more rapid still in its haste to destruction is short fresh grass. There are other substances to be had which have a useful heating property, as tan, which, next to dung and leaves, is perhaps the most commonly used; but it certainly does not answer so well in that way as it used to do before so many improvements in the tanning process were introduced. Nevertheless it is a useful agent still, but most so when worked alone. Certain kinds of factory refuse likewise ferment, and produce a heat more or less lasting in proportion to the slowness or rapidity with which they decay; but as most of these things have only a local position, hot dung in villa and suburban places, and dung and leaves in more rural ones, may be regarded as the most important heating substances we have at command. For a brisk heat a mixture of dung and leaves is to be preferred to either alone; while for a long-continued heat—say to last one year or more—good Oak or Beech leaves require no mixture, the heat they give off being gentle and agreeable to everything. If the ground be dry we may say it might be sunk a foot or more with advantage, as it would give the manure more command of the inside. If, however, the place be wet, and an excavation for the hotbed likely to collect water, then by all means let the bed be above the surface. Hotbeds put up early in the season are, however, not unusually heated by linings of dung applied to their sides when part of the bed has subsided; and it may be observed that when hot dung has to be applied against another substance of a like kind to augment its warmth, it may be as hot and rank as convenient, taking care, however, that none of the impure steam pass into the frame. We may also observe that some hotbeds are worked entirely by linings, the frame itself standing over a hollow chamber, or its foundation in some way being accessible to the heated vapour of the fermenting material. One of the best foundations which we ever had was a pile of billet wood of the size and shape of the box frame, to be placed upon it; and the inside being covered over with turtly litter, and soil put on, the box was set on that, and frequent applications of hot dung around all its sides kept up the required heat.

PINE APPLE (*S. Wilson*).—We have published no separate work on the culture of the Pine Apple.

CLANTHUS DAMPIERI SEEDLINGS (*A Young Amateur*).—This capricious plant is very difficult to manage, and we would advise you to treat your two plants differently—say, let one of them be potted into an open mixture of rough half-decayed turf with most of the soil shaken out of it, and mix some old moss and bits of charcoal with it. Let another plant be potted in sandy peat in the ordinary way, and report your success. We have tried plants in both ways, and for a time both went on well, but eventually died. In your case, however, the plants evidently want repotting; this done, we hope to hear of your successfully flowering this most handsome plant.

PLANTING FOREST AND FRUIT TREES IN MARCH (*A Young Amateur*).—You may do this in the early part of the month, but it would have been better if done in the autumn. They may, however, succeed pretty well if the ground has been in tillage, or is in a good condition. Much depends on this. If it be all right we would rather plant now than lose a season; but if it has been occupied by buildings, or otherwise denied access to the sweetening influence of air, let it have a season's fallow before planting, and you will gain by the delay.

VERBENAS DAMPING-OFF (*G. H., a Lover of Verbenas*).—It would be better to remove some of the plants at once to a hothed, where the increased heat will perhaps create fresh growth and arrest decay; and cuttings taken off after this have plenty of time to become plants. A pit is not the best place for Verbenas, still less so for Geraniums in the dull damp months; but as they are now receiving sun you will save what are left.

FRUIT TREES FAILING ON GRAVELLY SOIL (*Idem*).—Some gravels are very pernicious, containing so much mineral poison that trees often do badly in them. Neither will manuring prove a complete remedy with fruit trees, although for vegetables it has much effect. The only remedy we know of (and that is an expensive one), is to add considerably to the existing thin surface soil by large importations of soil of a more suitable kind for the growth of fruit trees. Perhaps, however, your situation is a bleak exposed one; if so, we fear great success can hardly be expected. However, try a few trees by removing a cartload or two of the subsoil, and replacing it with fresh loam from a rather stiff pasture, and in this, mixed with some of that already in tillage, plant healthy young trees.

TAPWORM (*G.*).—If no one was troubled with this parasite until it was introduced into his system by Strawberries manured with horse-droppings, we think that the tapeworm in the human intestines would be very rare—almost as rare as the unicorn and phoenix. It is a topic not suited to our columns.

HEATING A PEACH-HOUSE (*Barton*).—For very early forcing, say to commence about the end of October, it would be an advantage to have the heating-pipes close to the front wall, so as to heat the front air as it was admitted. This would not be necessary for forcing after January or February, and, therefore, we would further propose having the pipes on a level on the floor of the house, which will not at all interfere with the trees. It would be as well to have a ventilator under every light in the front wall. Were you to force early you would require four four-inch pipes the length of the house; moderately early, three; and to help on and keep out the frost, two pipes. We would place the pipes on the same level. In the first case, three flows and one return; in the second, two and one; and in the third, one of each. In any case we would raise the pipes to the extreme end, so as to be 3 or 4 inches above the level, insert a small open pipe there, and of course the return would have a similar fall to the boiler. Train as you say.

NAMES OF PLANTS (*G. C. A. C.*).—It is *Justicia speciosa*. (*Amateur*).—Your "gum" leaf is probably from *Eucalyptus piperita*, but we cannot be certain. (*R. M.*).—*Daviesia mimosoides*. (*H. H. B.*).—We cannot identify plants from such seeds. (*B. B.*).—Apparently a very bad specimen of *Aplonium bulbiferum*. If so, it is a freely-growing evergreen greenhouse fern. (*A Young Gardener*).—1, *Justicia calytricha*; 2, *Pilea serpyllifolia*. The leaves we do not recognise.

POULTRY, BEE, and HOUSEHOLD CHRONICLE.

MR. WILLIAMS AND THE DISQUALIFIED PENS AT BIRMINGHAM.

HAVING sent you last week an epitaph for the Birmingham controversy, I am afraid you will think me unreasonable in now asking you to exhume it for a post-mortem examination. I unwillingly make the request; but I have received to-day a letter from Mr. Williams, and it appears to me the information he gives, in conjunction with what is already known, may explain this "Comedy of Errors" in a manner which leaves no stain either on Mr. Williams or Mr. Hindson.

Mr. Williams, of course, considers the disqualification unjust, and claims the absolute right to exhibit the birds where and when he pleases. He says that he obtained them of Mr. Evan Pugh, who seems to be a breeder of Game fowls in the neighbourhood of Welshpool, that Pugh was once in the habit of supplying Mr. Hindson with birds for exhibition, but that when he bought the birds in question he was satisfied from Pugh's explanation that all connection between him and Mr. Hindson had ceased. He adds that the marks on his birds and Mr. Hindson's are probably the same, as he thinks they have all been marked by Evan Pugh. Of Mr. Hindson he says he knows absolutely nothing except by name, and that he never had any communication with him.

I will ask you first to allow me, by the light derived from Mr. Williams's letter, to review a few of those singularly groundless insinuations which, from some motive I cannot

understand, have been so persistently repeated. The first insinuation was that of collusion between Mr. Hindson and the exhibitor. My argument, that this charge was utterly inconsistent with the fact that Mr. Hindson himself insisted on the disqualification before any complaint could possibly have been made, apparently had little effect. May I, therefore, confirm it by the declaration of Mr. Williams, that he never in his life had any communication with Mr. Hindson? As a sort of corollary to this insinuation, it was next suggested that Mr. Williams was a kind of humble dependant of Mr. Hindson's. When this remark was made I could only express my disbelief. I now reply that Mr. Williams fills the honourable position of Mayor of Welshpool. There is another insinuation which I should not notice if it had not apparently received the sanction of Mr. Hewitt, of whom I hoped better things. After a rather elaborate account of the examination of the nostrils of all the Game cocks at Birmingham, with the result of which I am perfectly satisfied, he states the investigation was made "long prior to the disqualifying cards being put up." Now, the marks were the same whether the discovery were made before or after. I am afraid, therefore, the words I have quoted were introduced to suggest the groundless inference that the disqualification was the result of the discovery, about which he seems to have taken such great pains. How the delay occurred might be shown in a perfectly satisfactory way if it were necessary; but this point is not now of the slightest importance, as the present aspect of the case by no means implies that there was any hesitation on the part of Mr. Hindson, but rather that the step was taken with too great precipitation, and without time being allowed for sufficient inquiry.

But I return to Mr. Williams's letter, which really has an important bearing on the matter. It is written apparently with perfect frankness, and it is only just to say that he has shaken the opinion I once had as to his right to exhibit these birds. At the same time, I am not yet convinced that the disqualification was wrong. As this may appear inconsistent, let me explain it. I accept implicitly his statement that he bought the birds of Pugh, believing that Pugh had a right to dispose of them. This, of course, would justify Mr. Williams in sending them where he chose; but he admits there had been some connection between Pugh and Mr. Hindson. Now, if Mr. Hindson was the owner or had an interest in the birds, and Mr. Pugh, suppressing that fact, improperly disposed of them, Mr. Hindson was justified in disqualifying them, although Mr. Williams was not to blame. It is true Mr. Williams asserts positively the birds never were Mr. Hindson's; but, in making this assertion, he is probably relying on the statement of Pugh, whose interest it is to establish the validity of the sale to Mr. Williams. Assuming that Pugh had a perfect right to dispose of the birds, then the disqualification was a mistake; and as the marks on Mr. Williams's and Mr. Hindson's birds appear to be the same, it is just possible that those very marks, the existence of which has been established with so much care, and apparently for a totally different purpose, may tend to show how the mistake was made. All that seems necessary to make the question quite clear is satisfactory evidence as to the ownership at the time the birds passed into the hands of Mr. Williams. If Mr. Hindson had an interest in them at that time, although the fact was suppressed by Pugh, the disqualification was right; but if Mr. Hindson had no such interest the disqualification was a mistake. I think this is presenting the facts quite fairly, and in no light in which I can view them do they imply anything dishonourable either in Mr. Williams or in Mr. Hindson.

One fact stands out clear and distinct, and beyond all possibility of further doubt—viz., that between Mr. Williams and Mr. Hindson there never was, not only any connection, but not even the most trivial acquaintance. All the insinuations, therefore, once indulged in on the hypothesis of collusion are literally baseless. Let it come to the worst it cannot amount to more than this, that three pens of Game fowls were disqualified on grounds which were subsequently discovered to be insufficient.

If I have succeeded in showing that there is no necessity to cast aspersions either on Mr. Williams or Mr. Hindson, I am repaid for the trouble I have taken.—J. H. SMITH.

GAME-FOWL PRIZES AT BIRMINGHAM.

CAN you inform me what has become of the question raised in connection with the disqualified pens at the late Birmingham Show? What with Mr. Hindson's furious onset and Mr. Williams's spirited rejoinder, it bid fair to become as "pretty a quarrel" as one could desire; and now that it should have been allowed to subside and evaporate is not only very disappointing, but wears an air of suspicion. Having felt a more than ordinary interest in having this matter cleared up either one way or the other, I naturally waited in expectation of at least seeing a reply from Mr. Hindson to the rejoinder of Mr. Williams; and none having appeared, the matter, I repeat, remains in a very unsatisfactory, if not highly suspicious, condition.

Now, sir, the facts appear to be that the birds in question belonged to neither Mr. Hindson nor Mr. Williams, but were the property of Mr. Evan Pugh, Welshpool; and when Mr. Hindson exhibited them he, of course, had to borrow them. I have in my possession a letter from the owner of the birds (Mr. Pugh), in which he states that he sold and delivered them the Monday after the Birmingham Show; so that they never were Mr. Hindson's property. This being the case, and Mr. Hindson having exhibited them at shows where it is compulsory for the birds to be the *bonâ fide* property of the exhibitor, it behoves him to refund to the secretaries of the respective shows the prizes he has taken under these circumstances.

Another point which I also expected would have been noticed, and which requires to be cleared up, is the communication of Mr. Smith in your impression of December 22nd, 1863. It behoves him to explain where he obtained his information on the subject on which he there speaks so positively. Where, for instance, did he obtain the information that "it was perfectly true that some of the Game fowls to which prizes were awarded belonged to Mr. Hindson," when, as I have shown, Mr. Hindson had no property in them? Or where did he learn, as he stated to some of the bystanders, that these fowls had been stolen from Mr. Hindson, to whom they did not belong, and that Mr. Hindson intended to prosecute the delinquent?

By the way, Mr. Smith states that Mr. Hindson was the first to call his attention to the birds; whereas no notice was taken of the matter till public attention had been drawn to it. But let that pass. It is, nevertheless, assuredly incumbent on Mr. Smith to explain to your readers these anomalies in order to set himself straight with that part of the public which feel an interest in the question of poultry.

Under all these circumstances Mr. Hindson, if he value the opinion of others, will feel it to be incumbent on him to reply to the letter of Mr. Williams in your impression of the 19th ult., to say nothing of the facts in this communication. I have been given to understand that he has visited Mr. Evan Pugh, of Welshpool, and, therefore, ought to be in a position to defend himself. The portion of the public who exhibit poultry are most deeply interested in receiving an explanation of the reasons on which Mr. Hindson disqualified birds as being his own, when at the same time he had not, nor every had, any claim to them as his property.—F.

THE SCHEDULES OF POULTRY SHOWS.

HAVING been considerably interested in the concise and very interesting paragraphs which have appeared in your columns signed "Y. B. A. Z.," I venture to make a few comments and remarks both on prize schedules in general and that of Darlington in particular.

In the article written by that correspondent in your Number for the 5th of January, I notice his approval of the system adopted of varying the entrance-money according to the prizes. This system is one that seems so very fair in its scheme, and so very advantageous both to the Society and the exhibitor, that I am astonished that it has not been more generally adopted.

In looking over the prize lists of our principal shows we cannot fail to be struck by the unequal arrangement of certain prizes. Thus, in the Duck classes at the Crystal Palace, only two prizes, £1 and 10s., are offered in each class, with an entrance-fee of 6s.; whilst for the same fee fowls can compete for £5-prizes.

If we suppose an exhibitor living at a distance even winning the first prize, the expenses of carriage in going and returning, together with the aforesaid fee, would probably leave only a couple of shillings.

If in arranging our schedules we wish to secure the largest number of entries for the money we have to offer, we must not only adopt the varying state of entrance-fees, which of itself is highly profitable, but we must take into account the expenses that would be incurred by exhibitors. Thus, it is of but little use for many of our shows to offer a £1-first prize for Turkeys and Geese; and as a result how seldom do we see good classes in either numbers or quality? For Turkeys and Geese the prizes should be high, if a good show is desired, as their weight involves heavy railway dues; Cochins, Dorkings, and Brahmas should be also well cared for in the prize list because they demand it, both on account of their weight and numerous admirers; whilst a good show of Bantams generally can be had for a £1-prize.

I would not, of course, say that the heaviest birds should necessarily be those that ought to be most encouraged; I simply wish to remind those connected with the arrangement of prize lists that they should not forget travelling fares if they wish for a good amount of entries.

Again: we are aware that our shows are formed for the encouragement of domestic poultry, and that those varieties which possess the highest qualities both for use and ornament generally receive the most prize money. Thus, if the Cochin is proved to be almost the most useful and economical fowl in existence, and that the Bantam is simply kept for fancy, let the Cochin have the lion's share of the prize. And yet both "Y. B. A. Z." and "FAIR PLAY" are crying out against the prizes offered to Bantams at Darlington Show.

The answer I give the former is simply this: If we can have a show of Bantams from every part of the kingdom of great excellence for £1, why should the prize be increased? Rather let us encourage other heavier varieties which involve more expense in carriage.

To "FAIR PLAY" I would say that I am afraid that his interest in these "pigmies" hardly renders him an impartial judge. The last two or three sentences of the article of the 5th of January did certainly a little surprise me. I was astonished that any one should think of offering separate prizes to a breed which brought in such "pitiful returns" at Birmingham, and of which not even one pen appeared in the class for "Any other variety." Surely Black Hamburgs or Crève Cœurs are more deserving than Malays.

In conclusion, I think that it is an unfortunate circumstance that there is so very indistinct an understanding as to the comparative merits of various breeds, and such great differences in the proportions of prize money allotted to each variety. I think that if the question were properly discussed some improvement might be effected.—A COMPILER OF THE DARLINGTON SCHEDULE.

NANTWICH POULTRY AND PIGEON EXHIBITION.

THE fifth annual meeting of this Society has just concluded, and the result has been that a better show has taken place this year than in any one of those preceding. So welcome a result arises, without doubt, from the earnest and harmonious working together of the general Committee, each member of which body evidently fulfilled his duties as though the absolute success of the whole undertaking rested exclusively with himself. At Nantwich all the Committee "pull together;" and certainly if any one cause leads to success more than another, it is the carrying out of this principle. From the very institution of the Show such has been the happy state of matters at Nantwich; and we feel assured we cannot too strongly suggest its general imitation, for memory easily recalls to us various instances where little jealousies arising in Committees have ruined a local poultry show beyond power of redemption. It is a feature that speaks much for the immediate locality, that though entries are inadmissible except from within a circle of thirteen miles of the place of exhibition, the Nantwich Show quite holds its own among the best of our local poultry shows, even where no such restriction prevails. The Nantwich Town Hall is a really excellent and very convenient

building for the holding of a poultry show, and the authorities very kindly allow its use to the Committee at these annual *réunions*. The pens used are both light, airy, and convenient, and, what is most important, any particular fowl can be readily taken out for a more searching examination without the slightest trouble. It would be well for committees generally to give attention to this item in their arrangements.

Spanish fowls headed the prize list. Among them were many very first-rate birds, but as usual of late, the sharp frosts of some six weeks back left evidences of how much this beautiful variety of fowls suffer from such hardship. This remark scarcely has a stronger application than in the case of the second-prize Spanish cockerel; a better bird need scarcely be, but the loss of a considerable portion of its comb is now inevitable. The pullets shown with him were marvellously good, and seemed not in any way to be injured by being frostbitten. Our readers who value Spanish fowls, would do well not to turn out the Spanish cocks at all during sharp cutting weather, their susceptibility of injury being greater than with any other breed.

We next come to Aylesbury Ducks, following the prize list. The first prize (three birds) weighed 23 lbs., and the second prize 21½ lbs. They were very good, as were also the Rouens, so far as the prize birds were concerned. The weight of the first-prize Rouens was, however, only 20½ lbs. In the Variety Duck class, were shown some capital Muscovies, and a pen of Wild Ducks in a very first-rate condition. Two White Geese weighing 40½ lbs., took precedence, the second being Grey ones of 35 lbs. weight.

The Turkeys (shown also in pairs), weighed respectively 34½ lbs., and 33½ lbs. An extra prize of well-deserved merit was here given to a pen of very first-class White ones.

The White Dorkings were far beyond what we generally and exhibited even at our largest shows, every pen shown being most praiseworthy. In the Grey Dorkings want of condition was evidently more than usually apparent throughout, and, strangely enough, the best birds otherwise considered, were in this respect the most faulty. We must warn amateurs from exhibiting wry-legged birds, as it is a fatal shortcoming for prizetaking. We have very rarely seen so good a display of White and also Partridge-coloured *Cochins*, as took place this year at Nantwich; but the Buffs were decidedly indifferent. The selling class was not well filled. In the Game classes, the Brown Reds, for which breed Nantwich has always been so famous, kept up their high standing with faultless specimens; the cup cockerel of this colour being claimed within a few minutes of the opening of the Show by an amateur who largely exhibits this variety, and who travelled more than fifty miles for this express purpose. Some of the Black-breasted Reds were also very good, but not comparable to the variety first named. It was a singular coincidence, that in the Game *Bantams* the same observation as to Brown Reds holds good; and not alone to a solitary pen or so, for more than a dozen lots of this colour, all good, were exhibited. In *Polands*, Mr. Heath's Silver-spangled placed all the rival pens quite out of the reach of anything approaching competition. They were carefully bred, and very meritoriously shown. The *Hamburghs* failed to hold so good a position as on some former occasions. Imperfect combs were very general, and in consequence, some of the prizes were withheld.

The Nantwich Show always deserves high credit as to its Pigeons. The Carriers were capital, as were especially the Barbs, and the Turbits also. We noticed some excellent specimens of Black Magpies, Black Spots, Yellow Rough-legged Tumblers, White Doves, and Black Balbs.

The show of *Canaries* and *Singing Birds*, was quite a feature of the Meeting; and a large portion of the prize birds soon changed hands, for although very high-class specimens, they were entered at very reasonable prizes. We cannot speak too highly of the care and attention of the Committee to the birds of all kinds; and are happy to state the Meeting was decidedly successful.

SPANISH.—First, R. Hulse, Winsford. Second, W. Woolley, Bunbury. *Chickens*.—First, W. B. Eches, Whitechurch. Second, W. Woolley, Commened, Miss Hill, Wistaston.

DORKINGS (White).—First, J. Platt, Swanlow. Second, Mrs. Tollemache, Dorfold Hall. Highly Commended, Mrs. Tollemache. Commended, C. B. Davies, Eardwick Hall.

DORKINGS (Any other colour).—First, T. Green, Stapelay. Second, T.

Burgess, Burleydam. Highly Commended and Commended, E. Tadman, Whitehurch. *Chickens*.—First and Second, Mrs. Tollemache, Dorfold Hall. *Sweepstakes*.—Prize, Rev. E. Duncombe, Bartroumley.

COCHIN-CHINA (Cinnamon, Buff, or Partridge).—First and Second, E. Tadman, Whitechurch. *Chickens*.—First and Second, E. Tadman.

COCHIN-CHINA (Any other colour).—First, J. Dutton, Burbury. Second, J. Dodd, Minshall Vernon. Highly Commended, J. Dutton; G. Williamson, Nantwich. *Chickens*.—First, G. Williamson, Nantwich. Second, J. Dodd, Minshall Vernon. Commended, J. Dutton. *Sweepstake*.—R. Stockton, Nantwich.

SELLING CLASS.—First, Second, Highly Commended, and Commended, J. Heath, Nantwich.

GAME (Black Reds).—First, J. Pedley, Nantwich. Second, J. Heath, Nantwich. Third, R. Ashley. Highly Commended, P. Falkner, Maccles; J. Grocott, Nantwich. *Chickens*.—First, J. R. Court. Second, W. Hodgkisson, Over. Third, J. Platt, Swanlow. Commended, G. Williams, Acton; W. Ruscoe, Rease Heath.

GAME (Brown Reds).—First, H. Holland, Nantwich. Second, R. Ashley, Nantwich. Third, J. Heath, Nantwich. Highly Commended, T. Whittingham; J. Grocott; J. Heath. Commended, S. Edwards, Nantwich. *Chickens*.—First, E. Bowers, Nantwich. Second, W. Furnival, Norton. Third, T. Whittingham.

GAME (Any other variety).—First, Miss Sadler, Whitehurch. Second, J. Pedley, Nantwich. Third, T. Burgess. Commended, G. Grocott. *Chickens*.—Prize, J. Pedley, Nantwich.

GAME SWEEPSTAKE (Any colour).—Prize, R. Ashley. (Any other colour than Black or Brown Red).—Second, J. Grocott, Nantwich.

GAME HENS (Any variety).—First, W. Galley, Nantwich. Second, W. Fisher, Ravensmoor. Highly Commended, T. Eaton, Audlem. Commended, J. Sheen, Tilston.

DUCKS (Aylesbury).—First, J. Platt, Swanlow. Second, J. Grocott, Nantwich.

DUCKS (Rouen).—First and Third, T. Burgess, Burleydam. Second, J. Platt, Swanlow.

DUCKS (Any other variety).—First, Miss Hill, Wistaston (Muscovy). Second, E. Bowers, Nantwich (Wild). Highly Commended, J. Eateman, Chorley (Muscovy). Commended, J. Dutton, Bunbury (East Indian).

GESE (Any colour).—First, J. Thursfield, Lightwood Green. Second, T. Whittingham, Batherton.

TURKEYS (Any colour).—First, W. Furnival, Norton (Brown). Second, T. Burgess, Burleydam (Grey). Third, W. H. Hornby, M.P. (Brown).

SINGLE COCKS.

GAME (Black Reds).—First, J. Pedley, Nantwich. Second, T. Stanyer. Third, J. Wilkinson, Norbury. Highly Commended, G. Harlock, Nantwich. Commended, J. Heath, Nantwich.

GAME (Brown Reds).—First, R. Ashley, Nantwich. Second, W. Drury, Hurleston. Third, J. Wilkinson, Norbury. Highly Commended, D. Bevin, Marton; W. Galley, Nantwich; J. Grocott, Nantwich. Commended, J. Heath, Nantwich.

POLANDS.—First and Second, J. Heath, Nantwich. Commended, G. Williamson. *Chickens*.—First and Second, J. Heath. Commended, T. Sproston, Middlewich.

HAMBURGHS (Golden-pencilled).—First, G. Williamson, Nantwich. Second prize withheld.

HAMBURGHS (Silver-pencilled).—First, G. Williamson, Nantwich. Second, J. Wainwright, Norton.

HAMBURGHS (Golden-spangled).—Second, T. Burgess, Burleydam. First prize withheld.

HAMBURGHS (Silver-spangled).—First, J. Kenyon, Maccles. Second, T. Dale, Middlewich. *Sweepstake*—Prize, J. Wainwright, Norton.

VICTUALERS PRIZE FOR GAME COCKERELS (Any colour).—Silver Cup, P. Jodson, Nantwich. Second, G. Williams, Acton. Third and Fourth, W. Galley, Nantwich. Highly Commended, E. H. Martin; T. Burgess, Burleydam; R. Ashley. Commended, H. Vickers, Wybachury; E. Bowers; R. Ashley; T. Eaton, Audlem; J. Heath.

BANTAMS (Game).—First, T. Stanyer (Brown Red). Second, T. Hassell (Black Red). Third, — Wilson. Highly Commended, T. Stanyer (Brown Red); J. Walker, Crewe (Black Red); J. Grocott, Nantwich (Black and Brown Reds). Commended, J. W. Haslem, Drayton (Black and Brown Reds).

BANTAMS (Other than Black or Brown Reds).—First, G. Williamson, Nantwich (Gold-laced). Second, T. Butler, Middlewich (White). Commended, G. Williamson (Gold-laced). *Sweepstakes*.—Prize, G. Williamson (Gold-laced).

BANTAMS (Game).—First and Third, T. Stanyer, Nantwich (White, and Brown Red). Second, — Wilson. Commended, J. Walter, Crewe (Saddle-back Grey).

PIGEONS.

CARRIERS.—First, Second, Third, and Highly Commended, W. Woolley, Bunbury.

DRAGONS.—First, W. Woolley, jun. Second, G. Nixon, Acton. Third, W. Hesketh, Nantwich. Fourth, W. Cliff, Nantwich.

JACOBS.—First and Second, J. Hockenhill, Nantwich (Yellow). Third and Fourth, W. B. Lea, Middlewich (Yellow).

POWERS.—Prize, W. Crawford, Nantwich (Buff). Highly Commended, J. Withinsaw, jun.

BARBS.—First, W. Woolley. Second and Third, J. Hockenhill (Black). Fourth, J. Wilding, Nantwich.

NUNS.—First, J. Dutton, Bunbury. Second and Highly Commended, J. Hockenhill.

FANTAILS.—First, J. Withinsaw, jun. (Black). Second and Highly Commended, C. B. Davies, Eardwick (White).

BEARDS.—Prize, S. Cawley, Priestland.

TRUMPETERS.—First, C. B. Davies, Eardwick. Second, A. Garnett, Nantwich (White).

OWLS.—First, J. Hoole, Crewe. Second, J. Breaton, Ruvensmoor. Third, J. Wilding, Nantwich. Fourth, J. Withinsaw, jun. Highly Commended, W. Venables, Whitechurch. Commended, A. Garnett, Nantwich.

DOVES.—First, J. Hughes, Audlem. Second and Third, J. Cooper.

BALBS.—Prize, W. Crawford, Nantwich. Highly Commended, T. Barratt.

TUMBLERS.—Prize, F. Cawley, Priestland. Highly Commended, T. Barratt, Winsford.

TURBITS.—First, J. Withinshaw, jun. Second and Third, J. C. Withinshaw, Nantwich. Fourth, J. Hockenbuhl, Nantwich. Highly Commended, W. Crawford, Nantwich.

ANY OTHER VARIETY.—First, J. Withinshaw, jun. Second, J. Hockenbuhl, Nantwich. Third, W. Crawford.

SINGING BIRDS.

CANARIES (Yellow).—First, H. Prince. Second, S. Williamson.

CANARIES (Buff).—First and Second, S. Williamson, Nantwich.

CANARIES (various).—First, J. Lewis, Crewe. Second, S. Williamson.

BROWN LINNETS.—First, D. Robinson. Second, S. Williamson.

RED LINNETS (Goldfinches).—First, R. Williamson. Second, S. Williamson.

SKYLARKS.—First and Second, J. Willett, Nantwich.

BULLFINCHES.—First, S. Williamson. Second, D. Poole.

JUDGES.—*Poultry.*—Mr. Edward Hewitt, of Sparkbrook, Birmingham. *Pigeons.*—Mr. Bowles, of Chester, and Mr. Cotten, of Crewe. *Canaries and Singing Birds.*—Mr. John Grace.

FOUL BROOD.

MR. LOWE has altogether failed in his attempt to establish the identity of chilled and foul brood. The malady he describes, though similar in appearance, is not infectious, and would, if left to itself, terminate at the worst with the destruction of the colony in which it had originated. Foul brood, on the other hand, is highly infectious, and would generally be conveyed to many of the neighbouring hives without any interference on the part of the bee-keeper, as has been amply proved by "G. F. B.," and others to whom Mr. Woodbury unfortunately sent infected hives before he was aware of the existence of the malady in his own apiary. At the same time, even the minor evils described by Mr. Lowe can only exceptionally arise, as they have never appeared in my own apiary where the management has been such as is exactly calculated to develop the mischief on Mr. Lowe's hypothesis. The history of one hive (one out of several), will sufficiently illustrate this.

June 27th, 1860. I formed a swarm by driving an old worn-out hive, and putting the swarm in a new empty straw hive on the old stand.

June 20th, 1861. I drove this hive and made a swarm as before, and on the 4th of July again formed a second swarm from the same stock.

May 29th, 1862. I made a good swarm by driving, and placed the swarm on the site of the old hive.

June 19th, 1862. Drove all the bees with their young queen out of the old hive, and put it on one side in hopes of obtaining a late Italian swarm with which to people it.

July 10th, 1862. Italian swarm of May 19th sent out a swarm, which was located in this old hive the same evening.

May 9th, 1863. This hive was removed from its stand, and a swarm put on its old site.

May 27th, 1863. Drove the bees and put them into a unicom-hive, which was put on the site from which the stock had just been removed.

After this series of operations this self-same hive containing the combs made in 1860, was again driven about the 6th of June, and three royal cells removed to introduce into other hives, and, finally, was driven after piping had commenced, and a young queen captured, to prevent another swarm from issuing forth.

This hive still exists, and contains a very numerous and flourishing family of well-marked Ligurians, and I do not believe that a single cell is prematurely encumbered with either a dead larva or pupa.—J. E. B.

COMMENCEMENT OF BEE SEASON IN SCOTLAND.—It may interest your apian readers to hear that bees have been seen working and carrying pollen from flowers of snowdrops, *Pyrus japonica*, and *Jasminum nudiflorum*, on Saturday last, January 30th, in the gardens, Gordon Castle, Morayshire. These flowers are all in the open air in front of my house. *Garrya elliptica*, which was in flower early in December, and a flower of *Magnolia grandiflora*, are still fresh, apparently but little injured by the frost, which was rather severe for about eight days, the lowest point of the mercury being 14°, or 18° of frost. Roses and most other tender plants being well ripened and well prepared last autumn, seem to have stood the frost well. The past fortnight having been very mild, buds are making rapid progress.—J. WEBSTER.

PRESERVING HARE AND RABBIT SKINS.

In your last week's Journal, Mr. B. P. Brent wishes to know how hare and rabbit skins may be so thoroughly tanned as not to smell if they get damp. I have often tanned them with success by the following receipt. "Put nine ounces of alum into a saucepan with a pint of hot water, and let it boil gently until the alum is dissolved, then add a quart of cold water. When the solution is quite cold, put in the skins. It is necessary to wait till it is cold, because if they are put in while it is hot the hair would come off. A rabbit skin may be kept in for about three days, the solution being stirred and the skin turned every day. The skin should then be stretched on a board, or it will shrink."—A BOY NATURALIST.

TAKE your skin quite fresh, and with lace-pins or short needles pin the skins fur downwards on a strong mill-board, stretching them as much as they will bear; then with a knife tenderly take off any remaining flesh or fatty substance, and rub on chalk, flour, and black pepper well pounded together; place the board in a sunny window or a short distance from a slow fire. After twenty-four hours remove this, and keep renewing the application until the skins are quite dry. They will remain soft. I have tried this, and find it answers very well.—FREDERICK G. PHILLIPS.

OUR LETTER BOX.

PRIZE FOR EGGS.—In the schedule of prizes of the West Cumberland Poultry Show is the following:—"Class 4.—A silver jug for the best dish of one dozen eggs of one distinct kind, and the kind to be specified. Entrance 2s. each." Should you consider cross-bred eggs between Game and Black Spanish qualified to compete or take prize?—J. C.

[We think eggs from such a cross would not come within the definition of "one distinct kind."]

DORKINGS (A Subscriber, Ireland).—The direction you ask for is Mr. Robson, Gardener, Linton Park, Staplehurst, Kent. The vendor is not bound to make up any failures in the eggs sold. If you wish to breed for exhibition, buy two sittings of eggs from two distinct first-rate yards, and mate the cocks from one brood with the hens from the other.

CRÈVE-CŒUR (An Old Subscriber).—There is a town so called near Cambridge, and the French breed of fowls so called originated in that neighbourhood.

PULLETS PLUCKING COCK'S FEATHERS (Subscriber, F. W. R.).—Remove the two pullets immediately. Fowls, like children, soon learn bad habits, and all the others will acquire this. It is unquestionable it arises from a disordered state of the stomach, generally a heated one. If they are very highly fed, lessen the quantity of food, and avoid everything of a stimulating nature, especially meat. Rub all the bare places with compound sulphur ointment.

FARM POULTRY (B. H.).—As you wish for good layers have pullets of any of the Cochín-China breeds. If you have a Dorking cock with them you will have good chickens for table also. In our No. 143 we gave recipes for dyeing moss green and blue.

PREPARING GAME FOWLS FOR EXHIBITING (C. C.).—The bright face and eye of the Game cock are due to judicious and careful feeding. Scraps of raw beef, an occasional meal of peas, and frequent yolks of eggs, have much to do with it. Cleanliness is also interested in it. The removal of every feather and hair from the crown and face is very desirable. The head should look hard and snake-like. Such is prevented if two rows of upright bristly feathers are seen marking the comb's place, or if theyatory down covers all the skin of the throat. This is considered legitimate training in Game classes, and every hair and feather should therefore be removed. The head and face may be washed with cold water and vinegar. A Game cock should have a sharp snake head, strong-curved back, round hard body, narrow towards the tail, short thigh, stout leg, low spur, feet not too much webbed, hard plumage, rather drooping tail and not too much of it, breast perfectly straight. These are the principal points, and we repeat it is perfectly admissible that the head be trimmed. A good specimen will require nothing more.

INCUBATOR—SIZE OF BANTAMS (Herberta).—We do not know of any incubator at work in London. They have not been much in use for a long time. Hatching is easy, but a valid substitute is wanted for the hen as a mother. It is difficult to do without her care and her warmth. Bantams cannot be too small, provided symmetry is preserved. It will be plainer, perhaps, to say they should be as small as possible.

CLEANING WHITE FOWLS' FEATHERS (A. P. Q.).—Wash the feathers of your bird with warm water and soap, and if very dirty a little soda. Wash with a soft sponge or a flannel, and be very careful to wet only the outside of the feather, and to wipe downwards, not to rub. The inside is never dry. When clean put the bird in an open basket with clean soft straw, and place it before a fire till dry.

TAILS OF SILVER-SPANGLED HAMBURGS (Old Subscriber).—By "clear tail," we mean a white feather with a black tip or moon at its extremity. A white feather without this mark would be a capital fault. The part under the tail is, and should be always, dark.

TURKLEYS (J. M.).—Give those with enlarged crops a table-spoonful of gin, and repeat the dose each morning until the symptoms abate.

BLUE AND YELLOW MACAW (W. King).—We are not aware of any instance of the Blue and Yellow Macaw, or any other species, having been in this country. It is not uncommon for that class of bird occasionally to lay eggs, but we never before heard of one laying nine eggs within ten weeks.

WEEKLY CALENDAR.

Day of M'nth	Day of Week.	FEBRUARY 16—22, 1864.	Average Temperature near London.			Rain in last 37 years.	Sun Rises.	Sun Sets.	Moon Rises.	Moon Sets.	Moon's Age.	Clock before Sun.	Day of Year.
			Day.	Night.	Mean.								
16	Tu	Yellow-hammer sings.	46.5	31.0	38.7	8	15 af 7	13 af 5	40 11	4 3	9	14 23	47
17	W	EMBER WEEK.	46.5	31.5	39.0	14	14 7	15 5	after.	53 3	10	14 20	48
18	Th	Dandelion flowers.	44.9	31.0	38.0	15	13 7	17 5	29 1	34 4	11	14 15	49
19	F	Greenfinch sings.	45.0	31.1	38.1	13	10 7	19 5	30 2	8 5	12	14 10	50
20	S	Spring Crocus flowers.	45.6	30.7	38.1	20	8 7	21 5	35 3	5 5	13	14 3	51
21	SUN	2 SUNDAY IN LENT.	46.6	32.3	39.5	17	6 7	22 5	38 4	2 6	14	13 57	52
22	M	Sun's declination 10° 21' S.	46.4	32.4	39.4	17	4 7	24 5	42 5	24 6	○	13 49	53

From observations taken near London during the last thirty-seven years, the average day temperature of the week is 45.9°, and its night temperature 31.4°. The greatest heat was 58°, on the 16th, 1859; 21st, 1846, and 21st, 1859; and the lowest cold, 2°, on the 17th, 1855. The greatest fall of rain was 0.51 inch.

THE ROYAL HORTICULTURAL SOCIETY.



If there were fears in the minds of any one that the horticultural element of the Royal Horticultural Society had become dormant or lost in the crowd of pleasure-seeking Fel-

lows who have recently joined it, the result of the annual Meeting on the 9th inst. will tend to dispel any such illusion. It was evident from the large

concourse of the true representatives of Horticulture who assembled on that occasion, that it only requires a fitting occasion to be afforded, for a firm expression of opinion to be exhibited on their part.

It has long been evident that a party has crept into the Council of this Society, whose object is not the advancement of horticulture, for they have no horticultural associations, tastes, or pursuits; and they have shown by the way in which the affairs of the Society have been so shamefully mismanaged, and the funds squandered and frittered away, that they either have not the judgment necessary for the successful carrying out of the operations of the Society, or that they are bent on another course than that which the Society was instituted to prosecute.

By degrees this state of things has become more and more apparent, until a decided conviction has entered the minds of all who may be called the Horticultural Fellows of the Society, that it is not the encouragement or advancement of horticulture that is meant, but the subserviency of the Society to a purpose altogether foreign to its objects.

From the time that the connection between the Royal Commissioners of the Exhibition of 1851 and the Society was first formed, and the project for uniting the Society in the South Kensington speculation was first propounded, it was the opinion of a great portion of the Fellows that this would be the step either to a complete breaking up of the Society as a purely horticultural body, or to its ultimate amalgamation with the South Kensington Museum. Those who have watched the current of events since then must have observed how silently, yet how perceptibly, this process has been going on. The first step was the partnership between the Society and the Commissioners, which covenanted, among other things, that each of the parties was to expend in the formation of a garden the sum of £50,000. The Society raised and spent their part of the money without being able by a long way to complete their works, and the Commissioners were in the same condition with regard to their part of the contract. The Society was compelled to spend £23,000 in addition in order to make the garden what it even now is; but the Commissioners refused to complete their works, assigning as the reason that their money was

all spent. Here, then, was the Society, after spending £73,000 left in the lurch with an unfinished garden, which was to have been "the gilded coach to draw the crowds," as we heard one of the late Vice-presidents express it, the reproach of its friends, the ridicule of its enemies, and the laughingstock of the whole gardening community. Dragged up from Chiswick with a debt of something about, or a little under, £4000, the Society was launched on a wild speculation, which with all the patronage, influence, excitement, and attractions that have been brought to bear upon it, leaves the Society at this present moment with a debt of £53,000, after an expenditure of £76,000. And what is there to show for it?

Now, how came all this about? Be it remembered that there sat on the Council of the Society a member of the Royal Commission of 1851—Sir Wentworth Dilke, Bart. He was not long there before the proposition was made to transfer the Horticultural Society from Chiswick to Kensington. The Society did not seek out the Royal Commissioners, but the Royal Commissioners the Society; and the object of their doing so was apparent. A grand building scheme with an architectural garden to form "an ornamental centre to the main square of the estate" were to be carried out at South Kensington, and what body so convenient to make use of for the formation of this garden as the Horticultural Society? It was constantly dinned into their ears that the Society was in debt, and insolvent, and no power on earth could save it except this partnership with the Royal Commissioners. How the change has benefited it we now see; and a Society of upwards of half a century standing, supported by the wealth and influence of the country, with one of the best gardens in Europe, and a paltry debt of £4000, which this year's sale of produce from Chiswick Garden would have paid the interest of twice over, was taken under the patronage of the Royal Commissioners to make their property valuable, and to become involved in the sum of upwards of £50,000 debt. And now here is the Council without the shadow of an idea how to be extricated from such a position, except the usual delusion of the bankrupt, by getting deeper in debt.

When it was known, then, that at this annual Meeting it was intended to bind the bonds of union with the South Kensington or Kensington Museum party more closely, need it be wondered at that the Horticultural part of the Society should put in an appearance to protest against it? We do not recollect seeing so large a gathering of the Fellows at any previous annual meeting, and it could only be a movement of some extraordinary description that could induce them to muster in such force. It had been arranged by the Horticultural party to oppose any farther infusion of the South Kensington element into the Council; and when it was known that the keeper of the South Kensington Museum, Mr. Henry Cole, was to be put on the Council they became perfectly exasperated. Some members of Council resigned, and everybody, except those of the Commissioners' party, dreaded the result of the step that was to be taken.

It was ascertained that five members of Council had

resigned. According to the charter these resignations are to be accepted by the Annual Meeting, and five others balloted in their stead. In addition to these there were the three retiring members, it being provided by the charter that one-fifth of the Council shall retire annually. This gave eight removals from the Council, and the Horticultural party thought this a good opportunity of voting-in a good proportion of Horticultural members. This was an opportunity, however, which the Council were not willing to allow; and instead of acting up to the requirements of the charter, they had recourse to the unworthy expedient of treating only two of these as resignations, and reckoning the other three as the three retiring members to be "recommended" to the annual Meeting. Now, instead of the five resignations being accepted by the annual Meeting, the Meeting was only permitted to have two of them, the letters read being those of Dr. Lindley and Earl Ducie. What came of the letters of resignations sent by Mr. Veitch, Mr. Cooper, and Mr. Fleming?

A strong party of the Horticultural Fellows were not to be out-manœuvred in that way, and they came prepared with their own two schedules—one containing five names for the five resignations, and one with those of the three retiring members, according to the form prescribed in the bye-laws. It will be seen, therefore, that the Horticultural party conformed to the charter, while the Council and the Museum party violated it. A day or two before the Meeting it became known that the Horticultural party were at work, and were determined to save the Society from merging into the hands of the Museum party if possible. This set the whole of South Kensington in a state of agitation, and it was amusing when the Horticultural body entered the room a quarter of an hour before the proceedings commenced to see all the front rows of seats occupied and densely packed. It was quite evident it was to be a trial of strength; and the Horticultural party would have been the stronger, were it not that the others seeing the force that was arrayed against them, sent out scouts in all directions. It was amusing, too, to see the clerks of some members of the Council, and a few aides from South Kensington Museum, who had been sent for, rushing in as the ballot was proceeding, with all the jollity beaming in their countenances which young men of buoyant spirits usually exhibit when they think there is going to be "a jolly row." Lady relatives of members of Council were also pressed into the service, and came dropping in just in time to save the ballot, and with all this exertion the Council's list was carried.

But, now, the question of the legality of this election is to be opened up. The Council's list was unquestionably illegal, and the lists of the Horticultural party were strictly in accordance with the conditions of the charter. The Horticultural party, we are informed, do not intend to let the matter pass so lightly by; and we learn that ere long protests against their sitting on the Council will be placed in the hands of all the members who were illegally elected, and of those who were legally removed from the Council. The list submitted by the Council was—

Earl Grosvenor	Major Trevor Clarke
Lord W. Lennox	Mr. Henry Cole,
James Bateman, Esq.	

of whom two only are horticulturists. The lists of the Horticultural party were—Retiring members supplied by

EARL GROSVENOR
SIR JOSEPH PAXTON
MAJOR TREVOR CLARKE,

in place of

Sir Wentworth Dilke, Bart.
Mr. John Chutton
Mr. John Lee.

The resignations to be supplied by—

Mr. James Bateman	Mr. William Paul
Mr. Thomas Rivers	Mr. Charles Edmonds
Mr. Robert Fortune	

in place of the following, who voluntarily sent in their resignation—

Earl Ducie	Dr. Lindley
Mr. James Veitch	Mr. John Fleming.
Mr. Robert Cooper	

The result is, that out of the Council's list, Earl Grosvenor,

Major Trevor Clarke, and Mr. Bateman are the only members legally elected.

Now, seeing Major Trevor Clarke and Mr. Bateman were both in the Horticultural party's list, taking these names out of the Council's, we ask all true horticulturists, What comparison is there between the Museum party's Council and that put forward by the Horticultural party? This is, indeed, a parallel case to *Punch's* "Shakspeare and the Pygmies"—HORTICULTURE AND THE PYGMIES.

ANNUAL MEETING OF THE ROYAL HORTICULTURAL SOCIETY.

THE annual meeting of the members of this Society was held on Tuesday, the 9th inst., at South Kensington, Sir Daniel Cooper in the chair.

Mr. MURRAY, the Assistant Secretary, having read the notice convening the meeting, it was proposed that the Hon. Judge Des Barres and Mr. J. Bateman should act as scrutineers of the ballot for members of the Council and officers for the year ensuing. It was stated, however, that Mr. Bateman was one of the candidates for the vacancies in the Council, and, therefore, Mr. George Godwin, F.R.S., was appointed in his stead. Mr. Murray then read the minutes of the previous meeting, which were approved and confirmed. Mr. Murray then proceeded to read the Report of the Council, which we shall publish in our next.

The CHAIRMAN said that before formally moving the approval and adoption of the report, he thought it might be more convenient for Fellows who had any remarks to make that the ballot for members of Council and officers for the year ensuing should be opened, and it could proceed while the meeting was being addressed. (The ballot was then opened.) The Chairman said that two of the Vice-Presidents of the Society had sent in their resignations, which the Secretary would read to the meeting.

The SECRETARY said that Lord Ducie in his letter said he regretted that he could not attend the Council. The death of his father-in-law had added to his business appointments, and he trusted that he might be permitted to resign. Dr. Lindley in his letter asked that he might be permitted to place his resignation in the hands of the Council. His health was so broken that he could no longer take part in any public matters, and, therefore, he suggested they should elect some more active Fellow to fill the office.

Mr. A. F. GODSON said that on the lists which had been distributed there were five names down—the two Vice-Presidents who retired, and Messrs. J. Veitch, Robert Cooper, and John Fleming. According to the bye-laws there ought only to be three.

The CHAIRMAN said the meeting could take the names separately, and could write in the names of other Fellows than those in the list if it was thought desirable.

Mr. HARRY CHESTER said that it was necessary that they should conduct their proceedings properly. If it was as stated by Mr. Godson, then the ballot was not being properly conducted.

Mr. A. F. GODSON said the most serious consequences might arise, as they were not acting according to the 29th clause of their charter of incorporation.

The CHAIRMAN said if they were going to discuss legal points they should frame them properly, and take them into some court of law and have them decided. He was there as Chairman of the meeting, but it was not his duty to hear legal arguments and give decisions upon them.

Mr. A. F. GODSON asked if the three names he had mentioned were resignations or removals.

The CHAIRMAN: I do not think that you ought to ask that question.

Mr. A. F. GODSON: I do not think I am wrong in asking it.

The CHAIRMAN: As it comes before this meeting they are removals.

Mr. A. F. GODSON: I do not care how it comes before the meeting.

The CHAIRMAN: They are removals—at least, they are recommended for removal.

A MEMBER thought that it was to the interests of all that they should get good working men on the Council. It was, he considered, a great pity that these questions should

arise, when their great object should be to see to getting the gardens improved, as they had pledged themselves to the public to do.

Mr. CHESTER said his only object was that the proceedings should be valid; but he did not think the questions raised by Mr. Godson were of sufficient importance to detain the meeting. There were five names proposed to fill the vacancies; but members could fill in any other names. They did not have the reasons why the three gentlemen retired brought before the meeting.

The CHAIRMAN said there was no disunion whatever in the Council leading to the resignations. They all alleged press of business rendering their attendance at the Council impossible. If members had any technical objections to make they could be taken down, and the charter of incorporation altered accordingly if it was worth while [No, no].

Mr. A. F. GODSON asked if he wished to propose any names in addition to those on the lists, could he do so publicly before the meeting?

The CHAIRMAN said that any names must be written, otherwise it would not be a ballot.

It was then decided that the ballot should proceed in the usual manner.

The CHAIRMAN said he would not detain the meeting with any lengthened remarks on the Report in moving the approval and adoption of that document. It went very fully into what the Council had done in the past twelve months, and also as to what they hoped to do in the future. He thought that any observations of his would weaken rather than strengthen that Report. He would therefore formally move the approval and adoption of it.

Mr. W. W. SAUNDERS seconded the motion, and the Chairman invited discussion.

A MEMBER asked whether the extra admissions to be given to the Fellows would be in the shape of printed orders as at the Botanical Gardens.

The CHAIRMAN: Those details have not been finally adopted.

The MEMBER suggested that the Gardens at Chiswick should be opened on Sundays. He regretted to see those Gardens kept in such a bad state. The grass had not been removed, and the palings required repairing. In one place an old horse was grazing, and that was not one of the objects of the Royal Horticultural Society. He merely threw out the suggestion, and without any disagreeable spirit towards the Council.

The CHAIRMAN in answer said that the Council regretted that they could not do more in improving the Chiswick Gardens. They had only a limited sum of money at their command; and, in fact, they had expended more than was placed at their disposal, and if they spent more it would have to come out of their own pockets.

The MEMBER: It could be done for £10 a-year.

The CHAIRMAN: We have not £10 to spend.

Mr. BATEMAN said he had heard with regret the suggestion for opening the gardens at Chiswick on Sundays. Many of them might regret that their gardens at South Kensington had been opened on Sundays. If they opened Chiswick Gardens on Sunday they must have a large number of men employed to take care of the gardens. When speaking of that he saw breakers ahead, which gave him grave doubts as to whether the most injurious effects would not result to the Society. He should like to see the real objects of the Society carried out; but as to the suggestion which had been made, he must enter a sort of caveat against it.

The MEMBER said he was sure that it would add materially to the position of the Society if they could have a series of lectures given on the Science of Horticulture as were formerly given.

Sir WENTWORTH DILKE said that the subject was under the consideration of the Council. They had remembered the old Regent Street meetings, and it was under consideration to renew them by having a good Horticultural Show, and an able lecturer, like Professor Lindley, to explain the science. It was in the minds of the Council to have a series of papers read on the subject.

Mr. WRENCH was afraid that the gardens at Chiswick would be much interfered with, as there were schemes for two railways to pass through them.

Mr. CHESTER said that there were so many things in the

report which either directly or indirectly affected the position of the Society, as to lead him to believe that this was the time when they should either go forward to prosperity, or in a retrograde way to destruction. He had hoped that some gentleman of sufficient ability and skill would have taken the Report of the Council and reviewed their active proceedings, blaming them if blame were necessary, which, on the whole, he thought they were not to be. He should, in the absence of any person more competent than himself, offer a few remarks. As to the Chiswick Gardens he agreed with some previous speakers that they were in a most scandalous and odious state. In fact, in connection with any Horticultural Society, he had never seen anything so disgraceful. In fact, it would bring disgrace upon them from all foreigners who had visited their gardens. He hoped that the feelings which had been expressed at the meeting would have their full weight with the Council, and that they would take the matter up and not allow so scandalous a condition of the gardens to be continued. As to the opening of the gardens on Sundays, the Parks were opened on Sundays and vast numbers of people attended them; but there was never any such conduct as might lead to the imagination that a large body of men would be required to preserve order in case of the gardens at Chiswick being opened. As the gardens at South Kensington had been opened, he thought the Council should decide on opening those at Chiswick. The state of the gardens at Kensington reminded him of an ill-planned and ill-kept cemetery, whereas if the original plan had been properly carried out, the gardens would have been most beautiful, but the fact was they were not half-finished. He thought that they should substitute gravel walks for grass. Every one must admire the beauty of the glorious turf; but at the same time there were many periods in the year when the ladies complained very much of the damage done to their dresses by the gravel [laughter]. What they wanted to do was to get rid of the "cemetery" appearance of the gardens—to remove the many stone ornaments, and plinths, and long lines of stone string-work, and then place the flowers on the banks, the effect of which would be most picturesque. He did not object to statuary, but the floral aspect of the gardens should be made complete before those additions were made. Horticultural gardens ought to be gardens of horticulture, and the flowers should have the precedence of the statuary. He could not help thinking that the application of the Commissioners of the Exhibition of 1851 of the annexes of the recent Exhibition was a mistake. By opening up those arcades the visitors would be subject to the most horrible draughts; and, therefore, for the sake of the public the plan should be carried out as originally intended. He was very glad to hear from Sir W. Dilke that it was intended to have a series of lectures for the study of horticulture. It was the duty of this Society, as a scientific body, to promote the lectures and give prizes for the best papers on the subject. Let them not forget that they were originally a scientific body. He had heard objections made to the use of the gardens, but he thought they were most conducive for the growth of choice plants, many rare specimens of which would never be known or recorded but for the Society. His opinion was that the gardens and large conservatory might be made more attractive. He had heard with pleasure that it was the intention of the Council to light up the large conservatory during the dark evenings; and he saw no reason why there should not be a band there for the ladies to dance, and tea and so on might be supplied [laughter]. He was not quite sure that the fruit grown at Chiswick might not be made profitable by sale at South Kensington. The very fact of the assemblage of a number of ladies would be conducive to the consumption of a quantity of Strawberries and cream [laughter]. There was no doubt that many gentlemen were present who had subjects of more grave import in their minds, but at the same time he felt that there was much room for the consideration of the topics to which he had called attention. He would not make any amendment to the motion for the adoption of the Report; in fact, he supported that document, believing that the Council had worked well, considering the many difficulties with which they were beset [hear, hear].

Mr. BORN objected to some of the observations which had been made by Mr. Chester. He thought that they had

too much casino already, and therefore they should not have anything like dancing in the gardens. They should not be conducted on the same principle as Cremorne Gardens, else they would want croquetting, bowls, and skittles superintended by Miss Skittles herself [loud laughter]. He then proceeded to say that he had been very early in the Council with the late Prince Consort, and he had had many opportunities of judging of the opinion of His Royal Highness with regard to the manner in which horticultural gardens should be conducted. He still advocated the amendment of the gardens at Chiswick, which new arrangement he hoped to see carried out before long. He must say that there had been some very shameful neglect. As to the suggestion for tea and coffee, he felt sure that if they were once introduced that brandy and water would follow, with many other delectables of a similar character, and the result would be that that which was intended to be the medium of a great science would be turned into a casino, and worse than toy shop. With regard to the £13,000 offered to be advanced by the Commissioners of 1851, he wished to make a few observations.

Mr. HARWOOD HARWOOD said the question was whether there would be any interest on the £13,000.

Mr. S. H. GODSON said he was glad to see Sir W. Dilke and Mr. Edgar Bowring present, as they could give explanations on many most important points. He must say that from having the £200 disallowed them by the Commissioners, and other things, he thought the Society might have been more charitably treated. With regard to the observations which had been made during the discussion, there was this to be said in favour of opening the gardens at South Kensington as against the proposition for opening those at Chiswick on Sundays, that the gardens at Chiswick were surrounded with palings, and people made themselves most obnoxious to the visitors at those gardens, and if they were open on Sundays the inconvenience would be still greater. In addition to this there would be great expense from the number of police required. He would refer to the letter from the Commissioners of 1851, in answer to that of the Council of the Society. The matter stood thus: The Society applied to the Commissioners for a sum of money, but they did not say, "Let us have it free of interest," although the Commissioners had dropped them down considerably. He had a great respect for the Commissioners individually, but they all knew what Commissioners were as a corporate body. Some gentlemen had spoken about the interest on the £13,000, but that was a matter which would, perhaps, be explained; at all events the matter was in the hands of the meeting. It would be for the meeting to say what the Government—at least what the Commissioners of 1851—should do. There was also the question of the Society having to give up certain privileges. It was said that it was a question which should have been brought before the Council, and not before the members at a general meeting [hear hear]. But he had always been told that he stood alone in the Council, and he told the meeting that he should continue to do so. He was determined to put the matter before the members; for he had no doubt that the present meeting was quite powerful enough to come to a decision as to what the Society was entitled from the Government. The acceptance of the £13,000 would entail additional expense by way of interest, and there would be no advancement made in the cause of horticultural science. The money would not be spent in advancing or promoting the advancement of the science. He trusted that steps would be taken that would secure for the Society fair and honourable treatment.

Mr. H. HARWOOD: The question is, Whether this £13,000 is a loan or a gift?

Mr. CHESTER: There is nothing about it in the Report, whether it has been asked for as a gift or not. It seems we asked for a gift and we have got it.

Mr. H. HARWOOD: I believe that it is a gift.

Sir W. DILKE said that as he had been pointedly alluded to by previous speakers, he was desirous of giving any explanation that laid in his power. He must, in the first place, ask the meeting to bear in mind that the letter from the Commissioners of 1851 in reply to that from the Council of the Society was only agreed to on the previous Saturday, and the letter itself was not received until much later. The

details had not yet been settled; but, so far as he knew, what had transpired at the meeting of the Commissioners, and without any breach of confidence, he would state to the members of the Society for their information. It was, therefore, impossible for the Council to state what had been the exact terms decided upon; but he might say this—that of the £13,000 there would be the two sums of £6000 and £3000, upon which no interest would be charged by the Commissioners, and the remaining £4000 would rank as landlords' assistance, and consequently bear a small rate of interest. But he must say that on the whole the Commissioners had behaved most liberally to the Society. The fact was that the Commissioners had been short of funds, and they had in consequence to cut the coat according to the cloth. Under all the circumstances he contended that the Commissioners had behaved most liberally to the Council of the Society in their respective positions of landlord and tenant. He then went on at some length to explain why the gardens at Chiswick were in the condition at present complained of by members of the Society. With regard to the grass land at Chiswick, there had been no attempt to preserve it, and no visitors ever went upon it. It was most surprising to find that there was so small a number of visitors at the Chiswick Gardens; but it would be still more extraordinary if the residents of Hammersmith were taken out of the calculation. For some years the average had been below 200 per day. The attention of the Society had been directed to the growth of Grapes in addition to the many other most important matters, and the result was, that the attendance at the gardens had increased. In reference to the remarks of Mr. Chester as to the gravel paths, he thought that if the ladies were polled, they would be found to complain in greater number of the injury to their dresses and feet by the grass than the gravel. He objected to opening the gardens at Chiswick on Sundays, as it had already been found that notwithstanding the number of men employed, even some of the Fellows of the Society had been found to be picking the Strawberries.

Mr. H. HARWOOD thought that the explanation was very satisfactory, especially with regard to the fact that the money to be advanced would not bear interest with the exception of £4000, and in that respect the landlord must, as in all other cases, expect some interest on the money he laid out.

Mr. J. CLUTTON said that while, as the late Treasurer, he was on the Expenses Committee, he had had ample opportunities of judging the conduct of the Commissioners of 1851. He had always found that on the part of that body of gentlemen there had been every disposition to assist the Council of the Society. The Commissioners had been without means, but when they got them they had assisted the Society. As to the success of the gardens, that very much depended on their attractiveness, and they could only be made attractive by the money which had been offered to the Council by the Commissioners of 1851. He believed that the gardens might be made remunerative, and that they would be remunerative if they were made attractive. In addition to the gardens being made remunerative, they would have a tendency to promote the advancement of the Science of Horticulture. With respect to the keeping of the gardens at Chiswick, there were no reasons why they should be maintained. The first was the promotion and advancement of the science; and the second was that Chiswick could be made available in supporting the South Kensington Gardens. Had it not been for the gardens at South Kensington, the Society could not have kept those gardens at Chiswick [no, no]. They must bear in mind that there were many strong opponents to the South Kensington Gardens of the Royal Horticultural Society, and, therefore, they should impress upon the Council the necessity of making them as attractive as possible. They had a most formidable opponent in the Botanical Society, also they had the Crystal Palace and the Agricultural Hall, and, therefore they ought to meet the requirements of the public, and make the gardens as attractive as possible. To do that they must have ample resources, and, therefore, they should at once accept the offer which had been made by the Commissioners of 1851. His opinion was, that the Fellows of the Society should exert themselves to promote its advancement, and that the gardens at Chis-

wick should be used for their original purposes. The proposed outlay, if properly expended by the Expenses Committee, would make the Society prosperous; but they would never have prosperity if they fouled their own nest, and cried stinking fish. He, therefore, thought that they should not object to the terms of the letter of the Commissioners of the 6th inst., but rather that they should accept the offer in the same graceful manner in which it had been proposed by the Commissioners.

Mr. H. CHESTER said he should be desirous of proposing an amendment to the carrying of the Report, not out of disrespect to the Council, but on the question of the £13,000 offered by the Commissioners of 1851. He thought it would be premature to adopt a Report of which the letter of the Commissioners was a portion, without the members being acquainted with some of the circumstances under which the £13,000 was offered to the Society.

The CHAIRMAN: I must repeat what has already been said at the meeting, that the letter containing the proposal of advancing the £13,000 was only agreed to on the previous Saturday, and the whole of the rest of the terms will have to be settled. None of these negotiations have yet been made.

Mr. H. CHESTER said it appeared to him to be quite premature to adopt the Report in the present stage of the negotiations with the Commissioners of 1851; and he should therefore, without the slightest feeling of hostility to the Council of the Society, wish to move as an amendment—"That this meeting do adjourn to this day month, in order that the Council may have an opportunity of obtaining from the Commissioners of 1851 the terms on which the £13,000 is offered to the Society—whether it is in all or in part a loan." He thought that a great advantage would result to the Society from having another meeting, and he trusted that the Council would receive from him the most profound assurance of his confidence in the Council, and he hoped that that expression would prove the *bona fides* with which he acted. It was with the best possible intentions that he moved his amendment.

Mr. A. F. GODSON seconded the amendment.

A MEMBER said he thought the matter ought to be left in the hands of the Council. Would any good result from an adjournment? Would the Council be able to give any information in the course of a month as to the matter of the advance of £13,000 offered by the Commissioners of 1851?

The CHAIRMAN: No, I do not think so.

Mr. CHESTER: I am willing to make it a fortnight instead of a month, if the delay is considered too great.

Mr. HARWOOD: I am perfectly satisfied with the explanation which has been given, and therefore I think we ought to adopt the resolution for the approval of the Report.

A MEMBER: Do you think you can give us any more information in the course of a fortnight?

The CHAIRMAN: No, I do not. The Commissioners will have to settle the details of the offer which they have made in answer to our letter. The adjournment might affect the bargain as it at present stands—perhaps against us; and therefore it will only be giving members a large amount of additional trouble in coming here again.

Mr. CHESTER: We had better come two or three times than have things in this state [hear hear].

Mr. H. COLE, C.B., said that the meeting ought well to consider the position of the Council with the Commissioners of 1851. It had been said that the gardens were like a cemetery, and, therefore, it was necessary to alter that appearance to go to the Commissioners, who were the landlords, and ask for assistance. They said they would advance £13,000, and they did not ask the Society for any security or rent, but left that all to be settled hereafter, merely saying, "You want money, we advance you £13,000." He advised them to accept the advance as it was made, because he believed that if they objected it was very likely that the Commissioners would not give them any money at all, or, at least, drive a very hard bargain. Under the present circumstances he asked them what they would do, if they did not get the money which was now offered to them by the Commissioners? It was very impolitic to huxter about how they should do it.

Sir WENTWORTH DILKE should like to hear from Mr.

Edgar Bowring, the Secretary to the Commissioners of 1851, whether there had been any mis-statements.

Mr. EDGAR BOWRING said he had not intended to have made any remarks, but he willingly responded to the appeal which had been made to him. He had been much surprised to hear remarks which had been made by some gentlemen as to the "treatment" the Society had received at the hands of the Commissioners. The very statements of the gentleman next the Chairman (Mr. S. H. Godson), that he had always stood alone in the Council, was an ample answer to that part of the question as to the "treatment" of the Commissioners [laughter, and hear hear]. The £200 spoken of by Mr. Godson as having been disallowed by the Commissioners, was actually disallowed by the Expenses Committee of the Society themselves. It had been asked what was meant by the word "advance?" It was said that that was the word of the Commissioners, but it was the very word used by the Council of the Society themselves in their letter to the Commissioners. It was true that the Commissioners afterwards said, "That the terms are to be agreed upon." He could say the Commissioners referred the matter to the Finance Committee of the Commission, and their whole instructions were to consider it in the most liberal manner. He assured the Fellows that the manner in which the Commissioners had acted towards the Society in the relative positions of landlord and tenant had been most liberal—in fact the liberality of the Commissioners was most unprecedented, for they had advanced money which they had had to go into the market for, without asking the Council of the Society for any security whatever. The Commissioners had also been most liberal in their agreement with regard to the rent, for they gave the Council five years without asking for rent, and another five years would elapse before the rent would be enforced—payments being made according to the position of the Society, and an average being struck at the end of the ten years. The Commissioners never looked upon the Horticultural Gardens in a commercial aspect, but to make it the centre of a great and important estate, and to aid the promotion of science.

Mr. CHESTER said that to suit the convenience of members of the Society he would alter his amendment, so that the adjournment should be for a fortnight instead of a month.

Mr. COLE repeated that the Commissioners had behaved most handsomely to the Council of the Society, and he therefore strongly advised the meeting to accept the letter as it was, and not drive a hard bargain with the Commissioners, because if that course was persisted in the Society would be found to be the sufferers eventually.

Mr. KELK said that the Chairman had already told the meeting that the letter had only been decided on by the Commissioners on the previous Saturday, and they were discussing the question on the Tuesday. It was most necessary that they should have the money to carry out the objects of the Society, and he should advise them to accept the advance, as in the case of any opposition on the part of the Society, it might be found that the Commissioners would not be so willing to make the advance, but that they would be found to hold a very tight hand on the bargain.

Mr. CHESTER, however, persisted in having his amendment put to the meeting.

A show of hands was then taken, and the Chairman declared that the numbers were about 40 for the amendment (for the adjournment for a fortnight), and 24 *per contra*.

Mr. GODWIN asked for a division, but it was not persisted in.

The result of the ballot was then reported. The following members of the Council were declared to be elected: The Earl Grosvenor, M.P., 28, Prince's Gate; Lord Henry Gordon Lennox, M.P., 51, Portland Place; Henry Cole, C.B., South Kensington Museum; James Bateman, Biddulph Grange, Congleton; Major Trevor Clarke, Welton Place, Daventry.

The following gentlemen were declared to be elected as officers for the year ensuing:—President, The Duke of Buccleuch. Treasurer, Sir Daniel Cooper, Bart. Secretary, William Wilson Saunders, F.R.S. Expenses Committee-men, The Treasurer, The Secretary, Henry Cole, C.B. Auditors, Jonathan Clark, Charles Edmonds, James Nicholson.

Mr. A. F. GODSON said that as there had been some other

names proposed, would it not be as well to announce the numbers?

The CHAIRMAN said that this was against the principles of the ballot, and therefore the report of the scrutineers must be taken as the result [ironical cheers].

A vote of thanks was then passed to the Chairman, and the meeting was adjourned until the 23rd inst.

ROYAL HORTICULTURAL SOCIETY.

I HEREWITH send you an extract from a letter written by one of the first practical gardeners in the kingdom upon the subject of the annual Meeting held last Tuesday, which must be interesting to all the Fellows of the Royal Horticultural Society who wish well to horticulture.—F. R. H. S.

"They [the gardens] are approaching that point when they must be designated tea gardens. As we commence at the bottom entrance, we find the only redeeming feature in the way of grand effect in the garden cut up into fortifications or Dutch dykes, with old spent Rhododendrons put upon the top, excluding the fine outline of the shrubs behind and increasing the labour of watering to an immense extent. And pray what shade will they ever give? All this is simply money wasted, and will have to be undone again. Go a little further up, and you will find skittle-alleys introduced without the least meaning; and what is more, at most two years will spoil all the grass near them from the wind blowing the drip upon it. On each side are signs of hedges to make more expenditure and to be undone again. If Mr. Cole, who, I understand, is now *Jardinier-en-chef*, knows but little of that profession, he evidently knows less of taste, or he would not have placed Her Most Gracious Majesty with her back to the centre of the garden and its visitors, and as a block to the view of the statue of H.R.H. the late Prince Consort, which is the most redeeming feature in the whole garden. There is a great deal more of this sort of muddle. See the broad walk to the music temples. If this had been too broad, surely no one with any notion of the rules of taste would have done more than reduce it to the width of the steps. All this will have to be undone again; and as far as the arcades are concerned, they will never be of any earthly use to Horticulture, unless some very different plan be adopted.

"There is one consolation: if we come to divide the Fellows as they have divided the gardens (Kensington has all now), Chiswick and Horticulture would take the better half; this is what we are coming to, and the sooner the better. The sooner it is known that Horticulture is disgusted with the one-half who are dragging her down to bankruptcy, the better will she stand with the world for another independent combination. The Society will find all this to their sorrow some day, when they wish that more representatives of what the Society profess to foster and encourage had been put upon the Council instead of such men as have been elected." [They are not elected.]

I was present at the annual meeting of our Society on Tuesday last, and I was not surprised that the discontent at the proceedings of the Council at length broke out. I was not surprised that the financial statements were considered unsatisfactory. I was not surprised that the influence of the Commissioners of 1851 was regarded with distrust. That body, to use the words of one bold-speaking member of the Council, "have borne the Society down to the ground;" they have made it a means of improving the value of the property which they hold in trust for national objects; they have made it a source of profit. And now they agree to advance £13,000 to the Society, but on what terms that large sum is to be handed over we were not informed, further than that these terms would be most liberal—in fact, that the money would be almost a gift. "*Tinco Danaos et dona ferentes*" say I, and this was the general feeling; for it was on this very point that the meeting was adjourned. What the Commissioners' ideas of liberality may be I know not; hitherto these seem to have been limited enough. The Commissioners of 1851 are too much alive to the interests with which they are entrusted to lend money without security and without interest. "Nothing

for nothing" has been their guiding principle all along, and it will be strange indeed if at last they are going to blaze forth in a fit of liberality. They either know that the security will be ample and the interest sufficient, or else they are betraying their trust.

The present condition of Chiswick Gardens was another subject on which considerable feeling was manifested, the general sentiment being that they should be kept in a more creditable manner than they at present are; but I do not conceive that the speakers took a sufficiently comprehensive view of the matter. It is true that according to the revenue account they cost in the last year £2064 1s. 3d., but then the return which they made was by no means inconsiderable; it was £549 8s. 8d., which reduces the expenditure to £1514 12s. 7d. But against this sum we have a set-off. They are, it was admitted by some of the Council, the storehouse and the manufactory of the materials for Kensington; and what merchant having a warehouse would seek to dispense with his warehouse because it would not of itself pay its own expenses? He would know that a warehouse was indispensable to his business, and he would charge its cost among the general expenses of that business. That some storehouse and place where horticultural experiments can be carried on is necessary we have the express declaration of Sir Wentworth Dilke, who stated that the late Prince Consort knew as well as any one that trees, &c., could no more be grown at Kensington than in Berkeley Square, but that he considered that the gardens at Kensington would be a means of collecting money for the benefit of horticulture. From all this I conclude that a garden as a feeder to Kensington and for experimental purposes is necessary—whether at Chiswick or elsewhere; but that it should receive credit in the financial statement for what it supplies; and, therefore, that the sum of £1514 12s. 7d. does not fairly represent the cost of Chiswick *per se*.

I cannot close these remarks without adverting to a proposition which was made by a Fellow of the Society—that tea and bread and butter should be sold in the gardens. At first I thought he was not in earnest, but I was deceived. Why, this would be turning the grounds into tea-gardens, which they are too much like already; and I suppose we should see put up, as at suburban villages, "Tea at 9d. a-head," and in the arcades that "parties bringing their own tea will be supplied with boiling water." What a fine field, too, would be opened, if such a proposition were adopted, for the Council to invite Messrs. Sloe & Pluckweed, Messrs. Hyson & Pekoe, and other great tea-dealers to enter into a "grand" competition (of course supplying tea gratis); and how delightful and instructive it would be for our wives and daughters to decide on the merits of the rival productions of those eminent firms! The Society has had too much of such miserable shifts already—shifts discreditable to the Society, to science, and to the age.—ETA.

PYRETHRUMS.

DOUBLE FEVERFEW and the new continental varieties of this genus are rather handsome, and make a fine display in the border in summer. Double Feverfew has latterly been employed in ribbon-borders, its pure white flowers, stiff habit, and profusion and continuance of bloom seem to fit it for a place amongst the denizens of the flower garden. The single and semi-double varieties are easily propagated or raised from seed, whilst the double kinds are increased by cuttings and division of the root. They are hardy perennials (except some few, which are greenhouse plants, coming from the Canary Islands), and grow readily in any description of soil; but that which is of a light sandy nature and dry is most suitable for them. In strong rich soil they grow more strongly and bloom less than on poor stony ground. Some of the new varieties are very handsome when grown in pots for the decoration of the conservatory, and all are highly decorative for mixed flower-borders. The double Feverfew (*Pyrethrum parthenium flore pleno*), is very suitable for planting in clumps, or in straight lines along with other plants that continue a long time in bloom. Pyrethrums usually flower in June and onwards through the season. Their greatest show of bloom is in July, and they remain a long time in flower—from six weeks to two months. The

double Feverfew, as everybody knows, commences flowering in June and continues to bloom until the end of September.

All the varieties strike readily by cuttings of the young shoots. These when about 3 inches long are cut transversely below a joint, and the leaves from the lower half of the cutting are cut off. The cutting is then inserted up to the leaves in a compost of sandy loam one-half and leaf soil one-half, with which a sixth of silver sand has been incorporated. A shady place, as a north aspect, is best; and after the cuttings are put in as near each other as possible without touching, a bell or hand-glass should be placed over them, a gentle watering being given to settle the compost about them. Keep the glass on for a fortnight, when it should be tilted a little on one side, and the plants (for they will be rooted), are to be gradually hardened-off. After the cuttings are well rooted they may be transferred to the flower-borders, and if the cuttings were strong they may afford a late bloom—that is, if the cuttings were taken in May. In the ordinary course, however, the plants are usually transplanted into nursery-beds on an east or west border, putting them in lines 6 inches asunder, and the plants 6 inches apart in the row. In October or the April following they are planted in the quarters where they are to flower. All transplanting is done with a ball, as this materially facilitates their rooting afresh and doing well. Cuttings made in August make handsome and strong plants for blooming in the following year. I have taken slips in September—a moderate-sized plant to begin with—in the same way as is done with Sage, planting them in lines 6 inches asunder on four-foot beds with one-foot alleys between the beds, and the slips 6 inches apart in the lines. Before putting in the slips a little leaf mould was worked into the soil, and some sharp sand if the soil was in the least heavy. The beds were duly watered and shaded by mats thrown over hoops, and in this way the plants became well rooted before winter. They needed nothing more than transplanting to their final quarters in the following April or May. These slips, which are cuttings with a small portion of root to them or simply a small unrooted branch, may be made at any time; but I find they are more certain to succeed if put in in the spring. May is a good time.

The new double-flowering varieties of *Pyrethrum* are readily increased by division of the root, which is best done in autumn after blooming, or in spring when the plants are commencing growing. Cuttings of the young shoots strike freely in a compost of light loam, leaf mould, and sand in equal parts; inserting them in small pots and placing them in a cold frame, shading, and keeping duly supplied with water until they are well rooted. It is better to winter the new varieties in cold frames, for they are not exactly hardy in cold wet soils and exposed situations. The roots divided in spring flower well the same season, and a few potted them in loam and leaf mould, with a sprinkling of sand intermixed, make rather pretty pot plants, and are very useful. They should be placed in a cool but not shaded situation until July, when removing them to a sunny position will cause them to flower well in August, and far into the dull months of winter in a cool greenhouse or conservatory. If half the plants are stopped when the shoots are 6 inches long they will flower about a month later than those not stopped, and continue long in bloom. I have had fine bushy plants in 18-sized, and some handsome specimens in nine-inch pots, and they were most profuse and lasting in their flowering. Cuttings of the double Feverfew struck in spring and grown on through the summer are very useful for blooming in a cool greenhouse in autumn. In any way all of them are fine border plants deserving of more extended cultivation.

Seed is best sown in any light soil in pans, and placed in heat until fairly up, when the young plants are hardened-off, and pricked-off into beds, and finally transplanted into the flower-borders in autumn, or in spring, and they come into fine bloom in the second year. They grow from a foot to 18 inches high in light soils, but rather taller in rich soil. Some of them, as *Pyrethrum carneum*, a flesh-coloured species from Barbary, grow from 2 to 3 feet high, and *P. roseum*, the double variety of which is really beautiful, attains about the same height; *P. atro-sanguineum*, a dark variety, does not grow more than 9 inches high; but Brilliant, Delhay, and Duchesse de Brabant, grow to a

height of nearly 3 feet. There is a list of eight new varieties in Dr. Hogg's "Gardener's Year Book," but these I have not yet seen. There are none of the new varieties which I know that beat the old double Feverfew for general usefulness; and although the new double varieties, with their crimson, rose-striped, red, purple, and lilac flowers, are very fine when viewed individually, I very much doubt whether their colours are bright enough to be employed extensively in ribbon-borders or flower-garden decoration in the highest style of the art. They certainly are worth a trial; but it would be wise to try them on a small scale in the first instance.

If we could employ more of these plants for the parterre, or others, like them, hardy, and so diminish the labour of taking up and preserving through the winter plants that make our houses more like nurseries than private gardens, I am persuaded that it would be a boon to the employed, and a saving to employers. I saw a border last season in which a large-flowering variety of the double Feverfew was employed, but I could not learn the name of it. The border which abutted on an asphalted walk made white with spar had an edging of *Lobelia speciosa*, then *Cerastium tomentosum*, a foot wide, and kept about 6 inches high; a foot of *Saponaria calabrica* next, then *Kayi Calceolaria*, *Tom Thumb Geranium* next, then a row of double Feverfew, behind it *Zelinda Dahlia* pegged, then a row of rose-flowered *Hollyhocks*, and a hedge of *Laurel* at the back of all. The whole was materially improved, I think, by some fine plants of *Humea elegans* placed 12 feet apart in the row occupied by *Scarlet Geraniums*, their graceful plumes taking off a good deal of the monotony, besides relieving the gaudiness of the scene. In the same way beds of *Cannas*, specimen *Pampas Grass*, and some of the *Cupressus* tribe, might advantageously be employed in masses of brilliant colours, which are too dazzling to look upon without the colours running one into the other, fatiguing and distracting the eye. Such plants would at once remove the flatness and monotony, and act as rests for the eye, and make the study of the arrangement a pleasureable instead of a fatiguing employment.

SOME OF THE THINGS NOW TO BE SEEN AT KEW.

The principal features in stove No. 1 are the *Aralias*, of which the collection probably stands unrivalled. Perhaps the majority of these plants are not destined to be petted by the gardening million, yet many of them are well worthy of notice. There is the *Dumbcane* (*Dieffenbachia seguina*), with its pretty spotted variety *picta*, which is not only very ornamental when judiciously mixed with other plants, but is highly interesting when its remarkable properties are considered. When chewed it is said to swell the tongue and destroy, for a considerable time, the power of speech. It also is said to impart an indelible stain to linen, and to be sometimes used in the refining of sugar. There are some remarkably fine specimens here of the genus *Philodendron*. The South Americans use the numerous species of these for a great number of purposes. Some are said to be used for cleansing sores or ulcers. Most of the order have a strong acrid quality. Some *Colocasias*, *Alocasias*, &c., produce a violent burning sensation, accompanied by salivation, as any one may prove by chewing a portion of the root of *Alocasia macrorhiza* to cure the toothache.

Many of this order are of the utmost service to mankind, independently of their beauty. For instance: a kind of sago is manufactured from the corns of *Arum maculatum*, by being crushed, steeped, and dried, when the remaining powder is used for a variety of purposes. *Amorphophallus campanulatus* is said to supply the place of the Potato in some parts of the East Indies, and is reckoned highly wholesome and nutritious.

The flowers (spadix) of these plants have mostly a faint, unpleasant smell, as those may have found who have flowered *Alocasia macrorhiza*, or, perhaps, as a better known example I may mention *Arum dracunculoides* which is not faintly but very highly unpleasant. Indeed, I have seen flies deposit their eggs upon it, more especially during bright sunshine, at which time its smell more resembles

putrid flesh than anything I am acquainted with. Its odour will produce headache, dizziness, and even vomiting.

There are some few *Pandanus* here, the most beautiful in a small state undoubtedly being *P. javanicus variegatus*, its beautifully variegated arching leaves giving it a grace peculiarly its own, and it might parade with advantage on a dining-table.

In the Palm-house there is *Monstera deliciosa*, well known, undoubtedly, but not seen so frequently as its handsome foliage would render advisable. Here are *Anthuriums* by the dozen, of more or less merit. The pretty spadix of *A. Scherzerianum* might remind one of a coral teapoon stuck blade upwards in a tuft of small Ivy leaves. *Scindapsus pictus*, of which there is a good plant, is useful for certain purposes. Indeed, there are hosts of these plants which are admissible in the collections of private growers for their foliage alone.

As a relief to the monotony which might otherwise exist, Palms, Musas, and other stove plants are introduced. I may especially mention the two magnificent specimens of *Angiopteris*, the one *evecta*, the other *Brogniartiana*. It is somewhat difficult to believe that these gigantic specimens have any connection with the delicate little *Trichomanes*, or *Hymenophyllum*, but I suppose they hold the same relation as the Patagonians do to the Esquimaux in the human family. The fronds of these monsters are about 20 feet long, supported by a thick stem (*rachis*), radiating from a large solid crown, and having two thick fleshy appendages at the base of each. The fronds are twice-divided (*bipinnate*), the ultimate divisions being linear-lanceolate, and 5 or 6 inches long. They are inhabitants of the Indian Archipelago, consequently requiring a stove and plenty of water. They, unfortunately, cannot be grown in a Cucumber-frame; but where there is room certainly a specimen of these magnificent spreading fellows is worthy a place.

We will now pass on to No. 2. This is the old orangery, now thoroughly established as a museum for specimens of wood, polished and otherwise. Of these there are fine collections from the Australian colonies, New Zealand, Natal, Tasmania, the East Indies, Trinidad, British Columbia, and Canada. There are two splendid planks of the Indian Cedar (*Cedrus deodara*). I believe these to be 4 feet broad, and 20 long. On a table in the centre is a splendid batch of specimens of *Welwitschia mirabilis*, and curious they are. There are also cases containing wax models of fruit. One of Pears contains a specimen called Uredale's St. Germain, weighing 2 lbs. 11 ozs. Here on a table is a specimen of Herne's Oak, presented by Her Majesty. On the same table is a beautiful vase of artificial flowers, composed of the red seeds of the *Abrus precatorius*, and the brown ones of *Desmanthus virgatus*. Indeed, it would seem that the old orangery could not be appropriated to a better use than the present, as it is not a first-rate plant-structure.

In the Palm-stove improvement seems to be the motto. Four of the larger Palms occupying the centre have been successfully stubbed, and as they lie on the floor prove what conquers glass and iron make. Two are *Caryota urens*, which measure respectively 57 and 59 feet long. Their places have been filled by *Bambusa gigantea*, *Acrocomia sclerocarpa*, *Astrocaryum rostratum*, and *Caryota urens*. In making these improvements, it must be regretted that such splendid specimens as the before-named *Caryotas* must be sacrificed from want of space. In the south end of the house are two specimens of *Musa ensata*, which are probably unrivalled in Europe. *Musa vittata* has ripened fruit during the autumn, but I understand it is not of good quality. *Scaevola elegans* has ripened seed during the autumn, as have *Area Baueri* and *Cocos plumosa*.

In the "Botanical Magazine" for January, 1857, it is said of *Scaevola elegans*, "Plants have been raised from seed transmitted by Allan Cunningham, and one of these having attained a height of 21 feet from the ground, produced its racemes of flowers, of a pale dull lilac colour, from the side of the dark green, graceful trunk in the autumn of 1856. These flowers were none of them succeeded by fruit." But in the autumn of 1863 it has produced fruit in right earnest, and this is abundantly testified by the splendid batch of young plants in the propagating-house here. There are also thriving specimens of *Corypha australis*, *Arenga saccharifera*, *Phoenix*, *Urania speciosa*, *Dracena draco*, and

many others. Indeed, considering the ill-adapted house, the collection has made considerable improvement.

The Orchid-houses are tolerably attractive in the way of bloom, but the aim seems to be to produce improved specimens; and it must be a source of congratulation to the grower to find that his efforts are at last being crowned with success.

It perhaps may not be out of place to append a list of those which are in bloom, beginning with such as are under cool treatment. *Bletia acutipetala*, *B. gracilis*, *Dendrobium æmulum*, *D. speciosum*, *Epiphora pubescens*, *Leptotes bicolor*, *Lycaste cruenta*, *L. Skinneri*, *Maxillaria densa*, *Monacanthus fimbriatus* and species, *Pleurothallis racemiflora*, *Polystachya luteola*, *Ponera stricta*, and *Sophranitis grandiflora*. Those under warm treatment are:—*Ansellia africana* and varieties, *Cymbidium sinense*, *Dendrobium Pierardi*, *Epidendrum fuscatum*, *E. fragrans*, *E. Stamfordianum*, *Phalaenopsis grandiflora*, *P. Schilleriana*, *Oncidium bicallosum*, *O. Cebolleta*, and *O. sphacelatum*.

The Ferns continue to flourish. The new house built some while ago, will soon be too small for their requirements, as the tree Ferns not only get larger in size, but are frequently receiving additions to their number.

The greenhouses are gay for the season with forced bulbs, *Primulas*, *Cinerarias*, &c.

The Heath-house is very gay with *Epacris*.—J. Mc. P.

BEDDING CALCEOLARIAS.

THANKS to Mr. Robson for his paper on "Bedding Calceolarias," but I fear it may mislead many whose climate is not so genial as that of Kent.

I, taking the advice of a friend, struck in August last in a common Cucumber-frame, cuttings of the following kinds of Calceolarias: *Aurea floribunda*, *Prince of Orange*, *Amplexicaulis*, *Superb*, *Gem*, and *Canariensis*. They were struck without heat, and during the frost of last month the frame was well covered with litter, but they were all killed with the exception of *Gem*, which was not a leaf the worse. I live in the centre of Ireland in a very damp county, and I find the winters extremely fatal. I therefore put my experience on record, as I doubt whether Calceolarias will keep safely in a frame, except through a very favourable winter.

I should mention that some cuttings of *Calceolaria Beauty of Montreal*, under a cup glass, put in also in August, in the open border, have lived; and likewise that although the tops of *Amplexicaulis* in the frame have been killed, I find that several of the plants are shooting from the bottom.

I am sorry that Mr. Robson does not take any notice of *Canariensis*. I had only two plants of it last year, but as far as I can judge of them, it is in every way better than *Aurea floribunda*—certainly it did not seem to lose its power of flowering so early.

I find *Beauty of Montreal*, which is a very handsome variety, exceedingly difficult to strike in a pot, but it strikes with great freedom in the open border under a cup glass.—Q. Q., Ireland.

COVERINGS FOR FRAMES.

I SEE that "AN AMATEUR" has been complaining of the trouble of shifting litter off and on his frames for protection. The following is a plan I advised an amateur to adopt, and by its means he kept his plants in a frame safe through the hard winter of 1860-1. I do not say that it is more efficient than litter, but it is much cleaner. His frame was boarded about 1 foot wide all round, and the space filled with sawdust. For top covering he had a bag made so much larger than the frame as to cover the sawdust also. This bag was filled with oat chaff, about 1 foot thick. The bottom of the bag or mattress was of canvas, as being more pliable, and the top and sides, or parts exposed to the weather, were of that cheap glazed cloth they make tablecovers of, which kept all dry, and has lasted him now four years. When the canvas became a little wet, which was seldom, a short time in the sun or at the fire put all right. It was so light as to be easily shifted about, made no mess, and always looked well.—J. NORVAL.

ROCHEA FALCATA CULTURE.

THIS, though comparatively an old introduction, is one of the loveliest of the many succulents added to our lists from the Cape: therefore it does seem strange that it is not more frequently to be met with in our collections of stove plants, especially when we take into consideration the brightness of its flowers (bright scarlet and yellow), contrasting admirably with its semi-frosted foliage. From the plant having a habit of growing with but a single stem from the pot upwards, it has the demerit of soon becoming very lanky, which proves a great drawback to it, though it will yield to a system of training and become a specimen plant of moderate size.

With this object in view I have practised a plan of flowering it from cuttings in small pots, thus insuring a show of its flowers without encroaching materially upon space.

The cuttings should be taken from the heads of the plants in early spring, and have three joints at least, taking care not to make the wound too close to the joint. When they are made every vestige of leaf from around the lowest joint should be removed, as when any of this very fleshy substance is left attached it has a great tendency to cause rotting in the cutting.

The cuttings made thus should be placed two or three around a 60-sized pot in an ordinary cutting-compost; abundance of sand, however, must be used with the cuttings when dibbling them in, which should be done firmly. If placed in a position where they will receive abundance of light and even a little sun they will root readily, especially if with a nice moist atmosphere.

When rooted pot them off into a mixture of good yellow loam and sand, adding a portion of well-broken potsherds, thoroughly decomposed leaf mould, and peat. Pot them into small pots firmly; place them upon the back or top shelf of the stove, in the full light of the sun if possible, and keep them well supplied with water, not forgetting their corner of the house when the syringe is brought into requisition in the afternoon, for a good overhead-sousing will be very beneficial to them.

When potting is required again, shift the strongest into 48's, the lesser cuttings into large 60's, using the same compost as before, with the exception of the leaf mould, which should be omitted, and again potting firmly. Afterwards replace them in the corner originally selected for them, with a repetition of the treatment, until, as the days become shorter, the temperature is reduced; then all moisture should be gradually withheld from them until the spring, when, with the returning warmth of the sun, each plant should produce a good strong spike of flowers.

As cuttings in any considerable quantity are difficult to obtain except when a correspondingly large number of old plants are grown, the following means may be adopted in order to obtain a supply for propagating from—viz., keeping the beheaded old plant dry, or moderately so, until it breaks, and then treating it as above directed for the cuttings, and it will produce one or two pairs for the following spring, with, perhaps, an occasional spike or two of blossom also, though these will be small comparatively.—*W. EARLEY, Digswell.*

CUCUMBERS AND MELONS IN POTS WITHOUT BOTTOM HEAT.

IN addition to the contribution to your Journal of the 2nd, allow me space to detail my experience.

I will begin with a description of the pit. In January of last year, I superintended the erection of a pit, according to my own plans. It was made 40 feet long by 10 feet wide (inside measure), 7 feet high at the back, and 3 feet high in front, of nine-inch brickwork, divided into two compartments, each heated separately, and having a path 3 feet wide along the back. It was fitted up with a small cylindrical boiler, with two four-inch pipes around the front and ends, and with one return-pipe along the inner side of the path, the front pipe being placed as near the glass as circumstances would allow, and supplied with one trough-pipe in each house for evaporation. I then built up an inner pit of 4½-inch brickwork (the pipes completely enclosing it), 3 feet high in front, and 4 feet high at the back

part, near the path. I laid a drain through the centre of this inner pit sloping the ground on each side to the drain, upon this I made a perfect drainage to the depth of about 2 feet, composed of such materials as logs of wood, &c. I placed a layer of stable-litter over the drainage to prevent the soil going down into it, and I then put on my soil, composed of equal parts of good rich loam and leaf mould, to the depth of 18 inches at the back, and 1 foot towards the front. On this I placed my pots, No. 2's well drained, 2 feet apart along the front and back. The front pots were for Melons, and were filled with a rather heavy loam, but not clayey, and the back pots were for Cucumbers, and filled with a mixture of one part well-rotted leaf mould, two parts good turfy loam, and one part good rotten dung. Into these pots I put good strong plants of Turner's Gem and Wilde's Orion Melons, and Lord Kenyon's Favourite and Stanley's Winter Prolific Cucumbers; and they were well watered, and shaded when necessary, until well established.

I find them succeed well in a temperature of 70° by night, increasing that to 80° by sun heat in the day, well syringing them morning, afternoon at shutting-up time, and again at 9 o'clock at night; and at intervals during the day I sprinkle the floor with a watering-pot.

The plants were trained to a wire trellis 8 inches from the roof, and divested of all their strongest shoots to throw them into a fruiting state and to set a crop as soon as possible, when they were again pinched-in to form a new growth for a second crop, and the result was that from the second week in April to the first week in July I cut a hundred and fifty Cucumbers, and nineteen good Melons, at which time I followed my employer to another place, otherwise I feel confident I could have cut Cucumbers until November.

I think growing Cucumbers and Melons under such a mode of treatment with success greatly depends upon having strong plants before putting them into their large pots, and, after the first batch of fruit is cut, top-dressing with rotten dung and a little loam, taking care not to injure the fleshy roots, and supplying manure water twice a-week.

The lights of the roof were made to run past each other, therefore the frame is comfortably ventilated and of easy access, either at the top or bottom.—*THOMAS RECORD, Gardener to T. Cove, Esq., Belmont House, Hendon.*

CRACKING OF THE APPLE AND PEAR.

THE cracking of the Apple and the blotches and scarifications frequently observed on its surface have been referred to the attack of fungoid growths or mildew. Various examples have been cited where orchards, sheltered from prevailing winds, have shown a decided exemption from these attacks. In opposition to this supposed cause of immunity it has been asked, Are our orchards more exposed now than they formerly were? As a general rule, we think it quite likely that they are, seeing that in all sections as cultivation increases the forests are gradually thinned and cleared. The effects of destroying the forests of a country have already been noted; and we have a partial recognition of the importance of shelter in the precept of many intelligent orchardists who advocate the planting of fruit trees much closer than has formerly been the rule, and also in the practice of encouraging the trees to branch quite to the surface, instead of training to a clear stem 5 or 6 feet from the root. Both these expedients have a tendency to prevent rapid circulation of air through the orchard, and consequently are so far a preventive against evaporation from the soil as well as from the surface of the trees. Examples are not yet sufficiently numerous to warrant a decided opinion; but so far as they have been noted, the prospect of greater immunity by this mode of treatment is encouraging.

The cracking of this fruit has given rise to much speculation, and various theories have been advanced with reference to the cause. For a long period the opinion prevailed that it was owing to a deficiency of certain mineral ingredients in the soil, and various remedies based on this assumption were freely dispensed and tried, but with indifferent success. It is not now doubted that it is the result of mildew, and that the atmosphere, and not the soil, is at fault. In support of the opinion that it is governed by atmospheric influences, the fact may be quoted that the *White Doyenné*

one of the finest Pears when perfect, rarely succeeds in exposed localities; yet, when grown in positions thoroughly protected, it is still produced in all its pristine beauty and excellence. Referring to cases with which we are familiar, we have seen annual exhibitions of this fruit grown in the built-up portions of the cities of Philadelphia and Baltimore, most perfect of its kind, without spot or blemish, when those from trees growing in the more exposed suburbs invariably proved defective. Again, it has been lately shown that, fruited in the quiet atmosphere of a fruit-house, they attain great perfection; and further, we have seen a tree, one of a row that produced worthless fruit, enclosed on all sides by a small box, open at top and elevated a few inches above the soil, produce perfect fruit, while the productions of the adjoining trees were, as usual, cracked and worthless. Whatever may be allowed for protection in the above cases, it is very evident that they were not influenced by the nature of the soil.—*Report of the Department of Agriculture (America).*

EARTH PITS AND TURF PITS.

In answer to "J. C. L." and other correspondents, I have some large pits wide and deep, but they are rather more than earth pits. For instance: I have one some 3 feet below the ground level, 1 foot above it in front, and some 3½ feet above it at back, to allow of some old wide sashes being laid across from back to front. This pit does almost for anything from Potatoes to late Cucumbers, &c. After the hole was dug out some rough posts were driven in back and front, and against these rough slabs and old pieces of wood were laid, and earth banked up against them right up to the top, the earth being left in a sloping position at back and covered over with turf, leaving about 2 feet at top to walk on. The front was not turved but finished with a coating of tar, and then sifted gravel, to take off the water. The bank of earth at back was rather more than 3 feet wide at bottom, and fully 2 feet at top, and was well beaten and trodden. Such a place, as a cold pit, is as secure as any brick pit. The weight of earth at back would tend to press the back wall inwards; but this is counteracted by stout poles, at every 5 feet or so, being jammed in between the posts in front and the posts at back.

Pits from 6 to more feet in width may be made partly below or wholly above the ground level by a similar plan of posts and slabs, and the bank of earth will keep them secure; but, properly speaking, these should be called slab and earth pits. If the outside banks are well tarred and gravelled and a slope given to them no rains will pass through them, and if a slight covering of litter is thrown over them no frost will penetrate into the pit in winter.



Our true earth pits are generally those used only for a season. In fact, I make the trenches used for my Celery-beds into earth pits. No. 1 will show a section of such a pit 5 feet wide, and both sides of an equal height. This does well enough for protecting hardy things for a few weeks, but unless the protection is waterproofed, the plants might be deluged in the trench. No. 2 is, therefore, generally the

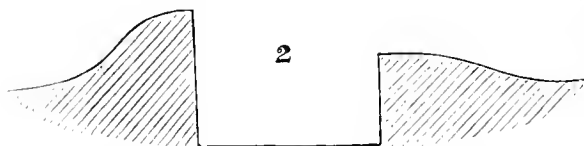

mode 1 adopt, which is merely throwing most of the earth from the trench to one side, and then, whatever the protecting medium, the rains will mostly be thrown off to the lower side of the pit. When I have made earth pits for a continu-

ance, I have made the walls sloped, as in No. 3, and then they would stand for several years. I once had such a pit made



above the ground level, as in 4, that it grieved me afterwards to destroy. It was 2½ feet at back and 15 inches in front, formed of clay and earth; the clay, kept chiefly next the inside, well rammed, and when finished smoothed with a face like plaster, and then covered with a thick brush of lime and sharp sand, which from its reflection of heat kept the clay from cracking. Unless for temporary purposes, all pits of earth or turf are best made above the ground level, as then there is less danger of plants damping. Dryness will also be insured by having small drain-tiles at every 6 feet through the front wall into the pathway.

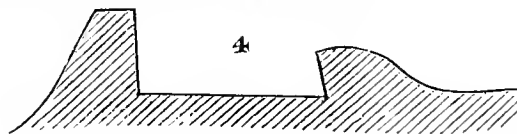

No. 4 is a section of simple turf pits, which have been almost constantly in use for many years. The pit is about 5 feet wide inside measure. The walls, about 3 feet and 1½ foot respectively, are about 1 foot wide, formed of layers of turf with soil between them, then banked-up with earth and covered with turf. These turf walls hardly ever get wet, however wet the weather. As above stated, some of these pits are almost constantly in use. In winter they come in for Endive, Lettuces, and Cauliflowers; in spring for bedding plants, Potatoes, &c.; and in summer they have been used for sowing seeds, for Cucumbers, Love Apples, and salads. I should prefer wooden shutters in winter. I generally use straw covers, or sometimes hurdles, drawn thick with evergreens. For bedding plants I prefer calico if I can get it, wide enough for the width of the pit, a piece some 30 feet in length being fastened to two poles and the calico having short strings sewed on along the sides at every 4 feet, opposite to each other, which strings fastened to wooden pins in the bank keep the calico as tight as an open umbrella. I have turned out bedding plants, watered them at bottom, kept dry soil for the surface, stretched the calico, and scarcely taken it off again until to thoroughly barden-off the plants before planting in the open ground. In severe nights a little straw, or straw covers or evergreen boughs, had to be laid over the calico. The calico would be of little use in winter. As hinted above, wooden covers, asphalt covers—anything waterproof—are best in winter, to be taken off in fine days, and propped up in days not so fine with notched sticks. I have chiefly straw covers which may be propped up in the same way. I commend the No. 4 form to "J. C. L.," as the most useful.

If there were posts and slabs for the sides the whole of the rest might be rammed earth, made smooth, painted with tar, and road drift thrown over it.

No earth pit alone will stand with straight inside walls. Turf will stand pretty erect for many years. Sometimes I lay glass sashes for frames over such pits; but then I lay poles lengthwise on the turf for the ends of the sashes to rest on.

As to Trentham flower garden, page 434, the whole width being 210 feet, the half width from the middle of the centre walk will be 110 feet, which will give close on 2 feet to the one-tenth of an inch, or, in other words, 1 inch will be 20 feet. "J. C. L." may, therefore, make a scale for himself.

The easiest way to lay down such intricate figures as those in the centre, is by using plenty of straight strings. I myself am too much out of practice, to give specimens and directions for scroll and volute drawing, but I heartily commend the subject to my coadjutor, Mr. Robson, who is peculiarly at home in such matters. Perhaps, also, some other friends will be glad to oblige.

R. FISH.

HOW TO HAVE GOOD MUSHROOM SPAWN WITHOUT BUYING IT.

In the spring, in a four-light frame, I make up a bed for Cucumbers, consisting of leaves, and dung fresh from the stable. To eight wheelbarrowsful of good turfy loam I add four of soil and droppings from my old Mushroom-beds, in which is some spawn; I well mix the whole together, put it on the top, and plant my Cucumbers in it. The heat from the dung and leaves causes the spawn to run, and in five or six weeks the bed is full and Mushrooms appear. I never found that it injured the Cucumbers, always having a good crop. When they have done bearing, which will be in September, I throw them away, and fill the frame with bedding plants, which remain there till I want to spawn my first bed; I then remove them, get a fork, push it into the bed, and turn up a forkful of Mushroom spawn, such as you do not see every day. With this I spawn my beds, and never fail in having a good crop of Mushrooms.—IGNORAMUS.

HYDRANGEAS PALE BLUE WITHOUT ARTIFICIAL APPLICATIONS.

I HAVE read in THE JOURNAL OF HORTICULTURE some remarks about Hydrangeas, and amongst others those of my friend Mr. Shearer, of Yester Gardens, who very kindly offers to analyse small portions of soil should any person send some to him for that purpose. Chemistry is of valuable assistance to gardeners in many respects; and should it only settle this long-pending and much-vexed question as to the cause of Hydrangea flowers turning blue, it will certainly have rendered a very great service. I have for years, every now and then, heard of first one person and then another who had succeeded in making Hydrangeas produce blue or pale blue flowers for one year, but could not do so the next.

About fifteen years ago I went to live in Cornwall, and close to its south coast, where in general the seasons are much milder than in almost any other part of the south of England. In the shrubberies and home plantations there a good many Hydrangeas were planted. I was agreeably surprised to see so many planted about, having gone from London where they cannot live out of doors over winter, and likewise at the size which many of these plants had attained. The Hydrangeas generally produced that most-coveted colour blue, about which so much has been written from time to time. One portion of the grounds produced these pale blue flowers in greater perfection than any other part. This part was under very large trees, principally Silver Firs, and some of these were indeed noble specimens of their kind, being, at about 18 inches above the ground, from 14 to 16 feet round the trunk, and as straight as they could be grown. The Hydrangeas seemed quite at home. Some of them had attained 4 or 5 feet in height, and were from

6 to 8 feet in diameter, forming quite a bush. The soil was for the most part a rich loam, somewhat inclining in places to a brick earth. The subsoil was generally composed of a small friable sort of slaty stone, having in it a kind of material approaching a clay, always commanding plenty of drainage, and never suffering much from very dry weather.

As I have already stated, under these high trees and well-sheltered amongst shrubs, the Hydrangeas grew in the greatest luxuriance. I have often seen a plant produce from twenty to thirty large heads of bloom, quite a ball shape over the top, and from 8 inches up to 1 foot in diameter. Some of the larger bushes would produce fifty or sixty heads of bloom, but it took an old plant which had not been injured for years to yield so large a number. I always observed they came of the prettiest and most desirable colour where they enjoyed the most shade under the trees and shrubs. On the south side, and otherwise where exposed to the full influence of the sun, they sometimes yielded heads of bloom of a creamy dirty white, anything but pleasing to see; and of course their foliage, instead of being of a light green as it was where well shaded, was very nearly the same colour as that of the flowers.

The length of time which these kept in flower was a matter of great consideration, and especially so when their blooming period included some of the dullest months in the year. Some would show flower by the end of July; but from the middle of August all through the autumn, as there is seldom frost there to hurt anything tender until after Christmas, those under trees would, in many instances, keep in tolerably good condition up to Christmas.

I often made use of the heads of bloom to mix amongst evergreens in decorations at Christmas and on other occasions. Visitors in the autumn generally admired them very much, remarking that they seldom saw any of so decided and pleasing a colour, and certainly never so many at one time. I never knew frost there severe enough to injure the Hydrangeas in the plantations during winter, as the plants will withstand a few degrees of frost without receiving any injury.—G. DAWSON.

TODMORDEN BOTANICAL SOCIETY.—Meeting, February 1st, the President in the chair. The following were noticeable among Ferns exhibited:—The beautiful *Adiantum capillus-Veneris rotundatum*, and an admirably crested variety of *Polystichum aculeatum*, both Ferns having been recently gathered in Devonshire by a correspondent of the Secretary—Mr. J. Dadds. The Vice-President announced that he had within the last fortnight the good fortune to discover, near Todmorden, a Moss which previously he had not presumed to inhabit our valley; the Moss in question is *Dicranum Schreberianum*. Mr. Nowell thought he had at least "sought up" this neighbourhood; but the Vice-President was mistaken.

METEOROLOGY OF 1863.—HARROCK HALL, WIGAN, LANCASHIRE.

1863.	THERMOMETER.			BAROMETER.			FROST. No. of nights.	RAIN.		Prevailing Winds. No. of days each month.							
	Max.	Min.	Mean.	Max.	Min.	Mean.		No. of days.	Amount.	N.	N.E.	E.	S.E.	S.	S.W.	W.	N.W.
January.....	53.0°	27.0°	38.0°	30.101	28.500	29.230	12	14	5.02	...	1	3	8	5	7	4	3
February.....	62.0	29.1	45.6	30.250	29.250	29.871	7	6	.78	7	4	6	6	5	...
March.....	62.1	27.0	44.2	30.100	28.800	29.600	8	7	1.71	2	2	6	3	1	3	8	6
April.....	62.0	32.0	49.1	29.950	29.160	29.580	1	6	.67	1	...	2	3	1	8	10	5
May.....	66.1	40.0	52.7	29.901	29.101	29.561	...	7	1.80	...	3	4	3	...	4	16	1
June.....	70.0	40.1	61.4	29.850	29.050	29.485	...	14	4.10	...	3	...	5	2	7	11	2
July.....	76.0	50.1	60.7	30.151	29.150	29.731	...	7	1.28	...	1	...	5	1	7	12	5
August.....	72.0	49.0	59.8	29.800	29.300	29.496	...	13	2.91	...	4	...	4	1	4	15	3
September.....	62.0	38.0	50.2	29.950	28.370	29.300	...	17	4.33	2	...	2	24	2
October.....	58.0	32.0	47.7	29.851	28.500	29.3	3	21	5.82	2	...	2	5	2	6	11	3
November.....	55.0	32.1	45.5	30.171	28.801	29.530	5	11	3.16	1	...	10	4	1	...	12	3
December.....	51.0	28.0	39.4	30.050	28.461	29.542	4	5	1.22	...	1	4	12	12	2
Totals.....	40	128	32.80	6	15	38	46	20	66	139	25

The highest reading of the barometer during the year was 30.250 inches, on February 13th, at 9 A.M.; wind E. The lowest ditto, 28.301 inches, on November 2nd, at 10 P.M.; wind W. The highest temperature of the year was

76.0°, on July 6th. The lowest ditto, 27.0°, on January 10th and March 14th. The greatest rainfall in twenty-four hours was 2.62 inches, on January 1st, and the time occupied in falling was 7 hours and 30 minutes.—J. DUNN.

WORK FOR THE WEEK.

KITCHEN GARDEN.

The severe frost which set in last week in a great measure suspended gardening operations, and the performance of what is now directed to be done will depend on the weather which may follow the thaw. *Cabbages*, a bed of Early York may be sown on a warm border. *Broad Beans*, this is a good time to plant a good breadth of them, they will produce a greater weight if planted now than at a later period. *Dwarf Kidney Beans*, sow a few Fulmer's, Negro, or Early White Dwarf in boxes for planting out. *Peas*, earth-up early sowings, and sow for principal crops. See that the land for Carrots, Onions, and other keeping root-crops is well wrought, and, if possible, trenched. *Parsnips*, this is also an excellent time to put in a good breadth of these in ground deeply trenched with the manure at the bottom; it is a very useful vegetable, and none pays better for extra care in cultivation. *Potatoes*, a few early sorts may now be planted on a warm south border. *Spinach*, run the hoe through the Winter Spinach as soon as the ground is mellow, and pick away all decayed leaves and weeds. As soon as the ground becomes mellow let all the coming-on crops have a thorough hoeing or surface-stirring. This is of the utmost importance at this period. Let it, however, not be done until the ground is somewhat dry.

FLOWER GARDEN.

When planting biennials and perennials the object should be to have as much variety of colour and succession in the borders throughout the season as possible, arranging the plants for a striking effect by contrasting the colours, those plants which are smallest being in front or nearest the eye, and the others rising in height and massiveness as they recede from it. Flowers to be chosen which will be beautiful when in bloom, however common, and which will bloom at the particular seasons required. A pleasing effect may also be produced by mixing the best annuals and sowing them thinly, towards the end of the month, on the borders. A selection of each sort most suitable as to colour and height for the situation can be made, but a discriminating eye is necessary when hoeing or weeding amongst them. A little rockwork made to hide unsightly, or to harmonise with surrounding, objects may be introduced in many places, and planted now. Simple outlines, and surfaces not too much broken, are preferable to the imitations of hills with high narrow peaks and fantastic forms that are seen in some parts of the country where stones abound. Many of the common hardy plants, such as Wallflowers, Indian Pinks, Alyssum, Aubrietia, Cerastium, Ferns, Fragaria, Geum, &c., are suitable, some to be disposed in the recesses and others in the more prominent parts, according to their natural habits of growing in the sunshine or shade. As soon as an opportunity occurs of planting Ranunculuses get them in, as it is probable, now that the frost has gone, we may have some heavy rains, and after the last week in this month they will be better in the ground than out of it. Complete all new work and improvements which have been retarded by the severity of the weather.

FRUIT GARDEN.

Proceed with pruning and nailing when not too cold for these operations. If any planting still remains to be done let it be performed as soon as the ground is in a fit state for that purpose. It is a great mistake to induce by rich manure the production of gross, long-jointed wood in any stage of the existence of a fruit tree. Wood of that description never becomes thoroughly ripened, and with Peaches, Apricots, and other stone fruits gum, canker, and premature death are frequently the results. Ground intended for fruit trees should be efficiently drained and then trenched to the depth of 2 feet, and if the natural soil is found to be too poor a sufficient quantity of fresh turfy loam should be added.

STOVE.

Increase atmospheric moisture in proportion to heat and light. Look sharp after insects, the snails are fond of the young buds of Orchids, &c., at this time. Some early Achimenes, Gloxinias, &c., to be set to work. The Gloxinias to have the earth shaken from the bulbs, and to be repotted in a mixture of half-decayed vegetable mould, and half good rich loam, with the addition of a little sand or charcoal. In planting press the roots gently on the surface of the soil,

and give no water for some time. When potted place where the temperature is about 60°, and give them a little water when they begin to grow, the supply to be gradually increased as they advance in growth. In May, when in flower they should be removed to the conservatory. They are readily increased by seeds and cutting. Begonias being of free growth and delighting in fresh soil, equal portions of sandy loam and leaf mould, it is necessary to repot them twice in the course of a year—viz., February and August, as a general rule; but exceptions must be made according to the growth of the plants, as when the roots become cramped or matted in the pot an injury is inflicted on the whole system of the plant. The knife to be used cautiously except with the tall-growing sorts. Plenty of water to be given during the growing season.

GREENHOUSE AND CONSERVATORY.

The sun will now be getting more powerful, when plants will require more attention in watering; therefore, it is necessary to look over them frequently to see that no plant is suffering for want of it. In dull weather little or no water will be required. Scarlet and other Pelargoniums which were taken up from the beds in the autumn should now be placed in heat to start them into growth. Herbaceous Calceolarias to be put in their blooming-pots and pushed along in a gentle heat, keeping them free from insects until they show bloom in April, after which they must be grown in a cool airy place to prevent the flower-stems from becoming too much drawn. It is advisable to give all the air possible to the plants by day unless cold cutting winds prevail, and to shut up early in the afternoon. In frosty weather when fires are required the soil in the pots, especially over the flues or hot-water pipes, is soon dried up, when frequent waterings are necessary. The water to be kept in the house during the night and given to the plants in the morning. All soils intended for potting purposes to be removed under cover, after having been exposed to the pulverising influence of the late frost, before the rains that generally occur at this season shall have saturated them and made them unfit for potting purposes. W. KEANE.

DOINGS OF THE LAST WEEK.

KITCHEN GARDEN.

The frost having again set in severe, there has been little work out of doors except raking tree leaves where there was no snow, wheeling dung and earth on to spare ground, giving a dressing of the former to Asparagus-beds, covering up Cauliflowers under hand-lights after the ground was frosted, and allowing the covering to remain several days though sunny. Protecting and yet giving all the air and light the weather would permit to Asparagus, Radishes, and Potatoes under glass, and keeping up a good succession of Mushrooms, Rhubarb, and Sea-kale. Protecting Potatoes, &c., for use from frost, and also protecting Celery, and placing some evergreen boughs as the only thing we could get, over and amongst Broccoli. Have delayed sowing Peas in pots, boxes, turf, &c.; until the frost shall have gone, and because we have hardly a place to put them in. Put up a bed that when warm enough will come in for Cucumbers.

FRUIT GARDEN.

The frost being so severe, stuck some laurel boughs among Strawberries in the open ground; also, placed some among the branches of Peach and Apricot trees, which will alike keep the frost from injuring them much, and prevent their being roasted on such a bright day as Wednesday, after such a frost the night before. Stuck, also, some branches among rather tender Roses, and against Tea Roses on walls. Shut up the orchard-house at night, but opened it as soon as it rose above freezing, the great point as to success where there is no artificial heat being to keep the trees as late as possible. Some keen amateurs were telling us a fortnight ago that their trees were coming into bloom, and there was no little quizzing about the old slow coaches. Well, unless they had some improvised stoves or basins of charcoal, we would rather be the slow coach than the fast one. In our orchard-house at daybreak on Wednesday it was 11° below the freezing-point, but as the air was still and dry, and the buds but slightly swelled, we apprehend no danger. We have seen no trace as yet of our

enemy the brown beetle after the second smoking, in which we used a quarter of a pound of shag tobacco along with the laurel leaves.

We notice that the farmers are to have malt duty free for cattle-feeding, and we do not see why the gardener should not have tobacco duty free for the destruction of his enemies. It would be easy to mix it with something so that no lover of the weed would ever be able to smoke it if he tried. Of all means for destroying insects none beats tobacco when pure, either as snuff or smoke, provided the latter is not too strong and not presented hot, which is more than can be said of tobacco paper and other means we resort to merely on the score of cheapness. Let the gardener get good tobacco, shag or roll, without duty, and most other assistants in vermin-killing would be but little used.

Brushed over the blossoms of Peaches and Strawberries in bloom to help to set them. Gave less air during the day than usual on account of the cold, but let the fire out when sunny, so that much air was not necessary; and, also, let all the houses beginning to move fall lower than usual at night, so that less fire might be necessary. Unfortunately, we have no dung as yet to go on with Melon-frames, &c. Pines in dung-frames and pits should be well banked up to the top with litter, which will secure a nice atmospheric temperature inside without too much bottom heat or too much vapour. Where fire heat is used for top and bottom heat, some of the forwardest successions will require potting as soon as the weather is fine. Soil, meanwhile, should be taken into a warm shed if possible where there is a furnace, so that it may be nicely aired and warmed before being used. Nothing is better than the top spit of 2 inches or so of fibry loam, made dry and kept dry in a stack for a twelve-month before use, and then cut down and not too much broken. Though a Pine plant does not show sudden checks at once, there is no plant more sensitive either as to its roots or leaves.

ORNAMENTAL DEPARTMENT.

Stuck a few laurel twigs among tender Roses. Wheeled some half-rotten leaves on beds, which was pretty well all we could do through snow and frost out of doors. Potted some Pelargoniums. Shook the earth from Lantanas, and gave them smaller pots. Placed Fuchsias in a shed behind conservatory. Examined Dahlia roots to see if all were safe, old Scarlet Geraniums, &c. Would like the weather to be more settled before potting any hardwooded plants, as it is always advisable to give a little extra stimulus after potting. Winter-blooming Heaths now finished flowering may be pruned according to their sorts; the free-growing ones, as *hyemalis* and *Wilmoreana*, &c., being cut pretty freely back, and such plants should be set by themselves, and kept rather close until they begin to break, and not soaked too much with water. Camellias will want a great deal of water if much fire heat is used. In such cold weather a greenhouse will be better at 40° at night than at 50°, as, in the latter case, the air is apt to become too dry. The health of the plants will much depend, if the day is sunny, on giving air early rather than in great quantity: hence stove plants have had little air, and little shifting of pots has yet been done among them. Except our late vinery and orchard-house, we have not a bit of glass that is not crammed with plants. For instance: our vinery starting has the floor covered, the stage covered, a foot left for paths, and shelves back and front, and shelves suspended from the roof besides; and that will ere long be the case with every house and frame. When shall we ever see the day when a house shall be kept to one purpose and one crop only? This bedding system has been a rare rod for the gardener's back and one of his own making. In all forcing-pits, to bring forward flowers it will be better to cover a little, instead of using too much fire heat. In an emergency a bundle or two of wheat straw is a capital thing laid thickly over the glass, and it can be easily taken up and tied in straight bundles for future use.

FROSTED PLANTS.

We have several inquiries on this subject as respects bedding and greenhouse plants, and would merely say that the drier the soil and the foliage, so as to be safe, the less likely will they be to be frosted. When in that condition a couple of degrees of frost will rarely injure Geraniums, Primulas, &c., if due caution is observed afterwards to

thaw them by degrees, and let light on them gradually. When considerably frosted and these means will not cure them, it is best to throw all away at once. A number of years ago, in order to prolong the beauty of the flower garden as long as possible, if we wished to save a few Geraniums we generally let them stand till November, and did not mind though the leaves were several times crusted with frost, provided the base of the stems seemed hard and all right. But as a rule we found a good number of these plants, however treated, used to die in the winter; and we verily believe that one reason why so many fail to keep old plants of Scarlet Geraniums over the winter is owing to the fact that they have been frosted before taking up. We find it is safer to take up these plants in October before they have been frosted at all, and by that time a week or two will make little difference in the general effect.

But now as to plants frosted at present. We think it is no more than right to give the result of practice, be it favourable or unfavourable. In fact, a mischance rightly used is as instructive often as a success. Well, from causes which we need not allude to, the frost penetrated into one of our places on last Tuesday morning. Many of the plants had been watered recently. At daybreak the glass inside indicated 4° below freezing, and some of the pots were sticking to the shelves. The first thing done was to put a fire on, and to raise the temperature gradually above the freezing-point. Whilst this was being accomplished the plants were syringed overhead with water as cold as it could be had under the ice. In half an hour another syringing was given. In less than an hour, owing to the cold water and the rise in the temperature combined, the frost was drawn out of the leaves; and on many of the *Cineraria* leaves there were swimming plates of ice, which were between the thickness of a sixpence and a shilling, but which soon melted. Fortunately, though the sun appeared the rays were inoperative, owing to a deep red haze of vapour round it, until near midday, so that no shading was wanted, as by that time the whole of the plants, with the exception of a dozen of leaves or so, bore no trace of the mischance. If such plants had been in a cold pit we would not have uncovered for a day or two, or even longer, if the internal temperature did not rise to from 35° to 40°. In such a case there would be no necessity for using cold water. The great danger in such a case is too rapid thawing, and too sudden exposure to light. We should think that if such plants as *Cinerarias* and *Pelargoniums* had from 5° to 10° of frost, no means would be available for their recovery.

We may state here what we have forgotten to mention under orchard-houses—that as a precaution against insects, when we expected the frost not to exceed from 2° to 4°, we have syringed the trees, and left the house open that the water might freeze on the trees. Of course that would not be advisable at any time when the frost was from 5° to 10°, and would be particularly unsuitable after the buds were swelling and opening. The drier the place then the better, and the closer in proportion as the frost is more severe.

Some inquiries have been presented as to the *simplicities* in the managing of fires in stoves, flues, furnaces for boilers, &c., and, if possible, we will meet these wishes ere long.—R. F.

COVENT GARDEN MARKET.—FEB. 13.

Notwithstanding the late severe weather there is an ample supply of outdoor vegetables, and especially of Savoys, Coleworts, and various kinds of Sprouts. Heavy importations have also come in of French Lettuce, Endive, Carrots, and Radishes. New Grapes, the appearance of which in the market was noticed in last week's report, are selling at from 15s. to 20s. per lb. Dessert Apples consist of Court Pendu-Plat, Golden Knob, and American Newtown Pippins; and of Dessert Pears almost the only kind now to be had is the Easter Beurré. The best Cobs are bringing 120s. per 100 lbs. Cut flowers chiefly consist of *Pelargoniums*, *Camellias*, *Azaleas*, *Cinerarias*, *Acacias*, *Hyacinths*, *Early Tulips*, *Snowdrops*, *Roses*, *Violets*, *Mignonette*, and *Chinese Primulas*.

FRUIT.

	s.	d.	s.	d.		s.	d.	s.	d.
Apples.....	½	sieve	2	0	10	±	0	0	0
Apricots	doz.		0	0	0	0	0	0	0
Figs	doz.		0	0	0	0	0	0	0
Filearts & Nuts 100 lbs.			0	0	0	0	0	0	0
Grapes, Hotthouse...lb.	10	0	15	0					
Foreign	1	0	2	0					
Muscats	10	0	15	0					
Lemons	100	4	10	0					
Melons.....	each		3	0	5	0			
Mulberries.....	quart		0	0	0	0	0	0	0
Nectarines			0	0	0	0	0	0	0
Oranges.....	100	4	0	10	0				
Peaches			0	0	0	0	0	0	0
Pears	bush.		8	0	12	0			
dessert.....	½	sieve	6	0	10	0			
Pine Apples.....	lb.		5	0	8	0			
Pomegranates.....	each		0	0	0	0	0	0	0
Walnuts.....	bush.		14	6	20	0			

VEGETABLES.

	s.	d.	a.	d.		a.	d.	s.	d.
Asparagus bundle	8	0	to	12	0	0	0	0	0
Beans, Broad..... bush.	3	0	0	0	Lettuce..... score	1	0	2	0
Kidney.....100	3	6	5	0	Mushrooms.....pottle	1	0	1	6
Beet, Red..... doz.	1	0	1	6	Must. & Cress, punnet	2	0	0	0
Broccoli..... bundle	0	7	2	0	Onions..... tubsel	2	0	4	0
Brussels Sprouts, sieve	1	6	2	6	pickling..... quart	0	6	0	8
Cabbage..... doz.	0	0	0	0	Parsley..... bunch	4	0	6	6
Capicums.....100	0	0	0	0	Parsnips..... doz.	0	9	1	6
Carrots..... bunch	0	6	0	8	Peas..... bush.	0	0	0	0
Cauliflower..... doz.	3	0	6	0	Potatoes..... sack	5	0	8	0
Celery..... bundle	1	6	2	0	Radishes doz. bunches	1	6	2	0
Cucumbers..... each	2	0	5	0	Rhubarb..... bundle	1	0	0	0
Endive..... score	1	3	2	6	per doz.	1	6	2	0
Fennel..... bunch	0	3	0	0	Sea-kale..... basket	1	6	2	0
Garlic and Shallots, lb.	0	8	0	0	sieve	2	6	4	0
Herbs..... bunch	0	3	0	0	Spinach..... doz.	0	0	0	0
Horseradish ... bundle	1	6	4	0	Tomatoes..... sieve	0	0	4	0
					Turnips.....bunch	0	4	0	0

TO CORRESPONDENTS.

** We request that no one will write privately to the departmental writers of the "Journal of Horticulture, Cottage Gardener, and Country Gentleman." By so doing they are subjected to unjustifiable trouble and expense. All communications should therefore be addressed solely to *The Editors of the Journal of Horticulture, &c., 162, Fleet Street, London, E.C.*

We also request that correspondents will not mix up on the same sheet questions relating to Gardening and those on Poultry and Bee subjects, if they expect to get them answered promptly and conveniently, but write them on separate communications. Also never to send more than two or three questions at once.

N.B.—Many questions must remain unanswered until next week.

HEATING A SMALL GREENHOUSE (F).—For such things as you mention one iron of the flue would be sufficient, and such a flue would heat three, four, or six lights as well as one if you only wanted a mild heat. There is no reason, however, why you should overheat even one light. Your case reminds us of a poor fellow who was always getting the worse for just a single glass; and his master told him there was no excuse, for if a single glass did so much harm he should only take half a one or a quarter of one or none. Just so: if three shovelfuls of cinders do so much more than is wanted, why not try two or one? With a close door for the ash-pit, and with or without a damper in the flue, we would undertake to have just as much heat as wanted and nothing more. However, you could hardly expect to have enough of heat for early propagating and growing such plants as you name in one light. If you extend a light or two more, we would not extend the flue farther, but leave the cross at the end more exposed. We would then make a chamber over the flue in the first light for propagating, by placing iron, slate, stone, or slabs across, 4 or 6 inches above the flues. If slabs, let them be a little apart, and stuff in between with clinkers and stones to let the heat up, and plunge in ashes or sand. The chamber should be shut in, and in severe weather you might have an opening made into the other division. You could also give more air there. We are speaking as if there were no alterations in the flue. All furnaces require looking after. A spadeful or two of damp cinders placed in such a furnace at bed time, with the door of the furnace and ash-pit door close, and the damper in the chimney 1 inch, or so as just to allow the smoke to escape, ought to burn slowly and give out a little heat for a long time.

VARIEGATED ARABIS (*An Old Subscriber*).—Your specimen cannot be *A. lucida*, for that has smooth leaves. Your leaf, apparently, is the common *A. abida*.

CRICKETS IN GREENHOUSES (*J. B., Constant Reader*).—If you refer to page 101 of our Number for February 2nd (No. 149), you will find directions for destroying them.

HYACINTH BULBS (*L. R. M.*).—Your bulbs were not sufficiently matured, consequently they had not a sufficiency of material stored in them to perfect the growth of the leaves and flowers. It is an evil of very general recurrence now, and we attribute it to the growth of the bulbs being overhastened in the previous summer for the purpose of getting them early ready for sale, it having become the fashion—the unreasonable fashion—to require the bulbs for room culture, and other modes of forcing, early in September, and even in August.

GARDEN PLANS (*May*).—We know of no work giving plans such as you need. If you require beds spread without regularity, why not select the shapes from the plans you mention, and place them according to your own taste?

WALTONIAN CASE (*M. H. F.*).—The last we heard of Mr. West, the maker, was that he was in business at Bournemouth, and we know of no one else who manufactures them.

CHAMBER SLOES (*H. W. B.*).—They are best thrown upon vacant plots of the kitchen garden, which will be dug and planted with Cabbage-works during the year. If used for watering growing crops, they should be mixed with at least five times their bulk of water.

CAMELLIA BUDS FALLING (*Amateur*).—If there is the least sourness in the soil, that would destroy the roots or make them inert; but as you acknowledge that the soil may have been dry or want of water, we think that is the most likely cause of failure. When a Camellia is swelling its buds the soil should at all times be kept well supplied with water. Watering may be necessary once a-week, but that depends on circumstances, and, as a rule, the soil in which a Camellia grows should never be allowed to become dry, but should at all seasons be kept moist.

VINES IN POTS (B).—The Black Champion would be better shifted into a No. 1 pot at once, providing good drainage, and employing a moderately rich loam for potting. The soil should be rather firmly pressed into the pot. It should be potted with the ball entire. As it is a fruiting cane, it should be pruned to a length of 5 feet. If it is not longer than 6 feet, we should not prune it at all, for there will be a danger of its bleeding if pruned late, and it is easier to rub off the buds not wanted, and then prune or cut off the useless cane after growth has commenced. The Blackland Sweetwater and Chavoush should be potted into 12-inch pots, pruning to the height required as stems for the future canes, and train a young shoot from each to become the fruiting cane next year. You might grow your Vines on in a greenhouse or curate'sinery until such time as your proposedinery be ready to receive them, when they should be planted in the border prepared for them.

BOGAINVILLEA SPECIOSA CULTURE (*Dougainvillaea*).—This plant blooms, as you rightly judge, from the sublaterals. Give water freely whilst the plant is growing, say from now until June, then diminish the supply, and keep the shoots rather thin and near the glass, and this, with dryness at the root, should give the scarlet bracts in August or September for which this plant is noted. We have had it in bloom in April, July, and August; but could not make certain of blooming it at any particular time. The main points are to obtain a good growth, and expose the shoots to all the light possible, and to keep the soil just dry at the roots. This will mostly produce flowers, for a wholesome check seems to be necessary for its flowering.

LOBELIA SPECIOSA FOR PRESENT YEAR (*C. B. F.*).—Seed sown early, say in the beginning of March, placed in heat until the seedlings are large enough to handle, and these hardened and potted-off, or pricked-out into boxes and grown on, will produce fine plants by the first week in June; and if they are then finally planted out they make a fine display in July, and until frost cuts them off. Cuttings from old plants have larger flowers, are more profuse bloomers, and flower earlier than those raised from seed; but plants from the last answer well for ordinary flower-garden decoration.

VINES AND CUCUMBERS TOGETHER (*A. D. B.*).—Cucumbers and Vines require all the light practicable, and must be grown so that the leaves of one do not shade the other. You might devote one-half of the house to Cucumbers, and the other to Vines in pots, placing the latter in the pit now, and commencing with a low temperature, and gradually increasing it, so as to have it 60° by the time the Vines are in leaf. The temperature may then be raised to 65°, when the Cucumbers may be planted out or introduced in pots. In this way you might have half a dozen Vines in pots, and devote a space of 9 feet by 4 to Cucumbers. You must not expect the Grapes to be so fine as if they were grown by themselves.

ROSES, FORCING (*H. P.*).—The temperature should be 50° at night for a fortnight, with a rise of 10° to 15° by day, and abundant ventilation. The heat may then be increased to 55° at night, with a rise of 15° by day with sun and plenty of air, admitting a little of the latter at night.

BOUVARDIA TRIPHYLLA (*Henry Geddes*).—Your plants would bloom better if they were a little older. Young plants grow more than flower. To grow it well it requires a cool greenhouse or cold frame, though it does well out of doors in hot summers, but badly in cold or wet seasons. A moderately light loam and sandy peat in equal parts, is a good compost, adding a little sand if the compost be deficient in that substance. The main point is to have the plants far advanced for flowering, and well hardened off before they are put out.

GRAFTING BEURRÉ DIEL PEAR ON BERGAMOT (*An Old Subscriber*).—We should prefer grafting on strong shoots of last year. You may bud on the present year's wood, and even graft; but we advise you to graft on strong healthy branches of the stock, and to do it as near the stem as possible. You must shorten the branches back to the girths, so as to force the rising sap into them. The price of the "Florist and Pomologist" is 1s. per month, or free by post 1s. 1d.

NIEREMBERGIA ORACILIS FROM SEED (*Perio*).—We experience no difficulty in raising this plant from seed. Drain a pot well, and fill to within half an inch of the rim with a compost of light loam and leaf mould in equal parts, and intermix a liberal quantity of silver sand. Level the surface, and sow the seed, just covering it with silver sand or the compost finely sifted. Water slightly, and place in a mild hotbed of 70° or 75°. Water sparingly, only keeping the soil moist, and when the plants are up keep near the glass, and when a couple of inches high, harden them off gradually. Pot, when sufficiently hardened, into small pots in the same compost as before. Keep close for a few days until they recover from the check occasioned by potting, then admit air freely, and plant out after all danger from frost is past. Seedlings usually flower in the August or September of the year in which they are sown; but not unless the seed is put in early. They make fine plants the second season, but should be taken up and wintered in the greenhouse.

FUCHSIA, POTTING (*Idem*).—It is best to shake as much soil from the roots of old Fuchsias as can be done without injuring the young fibres too much; and in potting them they should be put into pots a size less than those in which they have been growing. When they have filled the pots with roots, shift them into others a size larger, and when these are full of roots the plants will flower, or you may pot again to obtain larger specimens and a later bloom. The beginning of March is a good time to repot them.

FUMIGATING (*Idem*).—Employ as much shag tobacco as will fill the frame with smoke, but omit the sulphur; for no plant will withstand sulphur fumes, which are certain death to vegetable and animal life. Brown paper dipped in a solution of saltpetre, and then dried, may be used, the tobacco being laid thinly on one side; then roll the paper up loosely like a piece of parchment, tying it with string in the middle to keep it in its place. One, two, or three of these rolls, according to their size and the size of the frame, lighted at one end and put in, would fill the frame with smoke and kill aphid and thrips, but not red spider. Sulphur placed in basins with a little water over it, and put in the frame so that the sun could act upon it, is useful in preventing attacks both of mildew and red spider.

VERBENAS (*J. Horton*).—The following are the correct names:—Madame Jenson, Paul Tiscus, Mademoiselle de la Valliere, and Faust. The three former you will have no difficulty in obtaining. Not so Faust, for we do not know any catalogue in which it is; and yet we consider it one of the very finest in growth. Certainly in its colour there is nothing to beat it. It was introduced some years ago from France.

GOOD LATE PEAR (*J. Nicholls*).—You are tolerably correct in saying that most late Pears "have the texture of a Pear with the flavour of a Turnip;" but we think you will find *Beurré Sterckmanns* an exception.

PHLOXES (*G. M.*).—We find it only a disappointment to name dwarf varieties of Phlox, for they are all pretty sure after they are established to run up. The following are some of the best. Those marked * are dwarf:—*Punch*, *La Comtesse de Bresson*, **Licrvali*, *Souvenir de M. Fries Morel*, *Triomphe de Twickle*, *Madame de Wendel*, *Madlle. Anais Aubert*, *Boule de Niede*, *Mrsdame Licrval*, **Dr. Bois Duval*, *Madame Fontaine*, *Mrs. Standish*, *Mr. Rollison*, *Souvenir d'un Ami*, *Apollon*, *Madame Vilmorin*, **Victor Hugo*, **Madame Aubin*, **Madame de Chambry*, **Madams Lacroix*, *Madame Louise Ingelrelet*.

DOUBLE TUDEROSE CULTURE (*Q. Q.*).—Pot the bulbs as soon as received in a compost of turfy loam three-fourths, well decomposed manure or leaf mould one-fourth, with a free admixture of sharp sand. Water moderately, and place in a hotbed until the pots become full of roots, which is best promoted by keeping the atmosphere cooler than the heat of the hotbed. When this is accomplished, remove the pots to theinery, taking care to lift them out of the hotbed by degrees, so as not to give the plants a check. Water more freely as growth advances, and keep as near the glass as practicable. When the plants flower they may be removed to a greenhouse or warm room, where they remain a long time in bloom.

POMPON ON BOUQUET DAHLIAS (*Idem*).—Meteor, fine yellow; Pet of the Village, buff; Star, orange, tipped with scarlet; Goldlight, yellow, changing to creamy white; Dr. Webb, scarlet; Crimson Beauty, maroon crimson; Fireball, orange scarlet; Bride of Saxony, bluish, tinted and mottled with violet purple; Jeanette, crimson red, tipped with white; Little Darling, rose; Little Fred, bluish salmon; Pretty Polly, lilac; Snowrose, white; Pearl of Liliputs, puce, tinted purple crimson; Silver Pheasant, sulphur, tinted white; Master Dick, violet or puce crimson; Pheasant Girl, bluish white, belted with rosy crimson; and Little Gem, buff or rich drab, the best shaped flower in the lot.

LAWTON AND DORCHESTER BLACKBERRIES (*Idem*).—The Lawton we have grown, and can vouch for its producing fine fruit, which makes excellent preserves. It requires to be planted against a wooden fence or palings, to which the shoots should be tied or fastened with nails and list. We have it nailed to an east wall, and had some quarts of fine fruit from a few small plants. It likes a rich friable soil, but will do well in almost all soils. It requires no care beyond cutting out old shoots done bearing, and supplying their place with young shoots; this should be done in the autumn. The fruit is produced on wood of the current year; but these shoots spring from last year's wood, as with Raspberries. The Dorchester, as far as we know, is only a larger variety of the common Blackberry; but we have not grown it, and cannot, therefore, speak decidedly.

TROPÆOLIUM CARARIENSE FOR BEDS (*A Notice*).—We do not happen to hit upon the place where the above plant is noted as a bedder. We have never employed it as a bedding plant, but have had it in rustic baskets to cover the handles, supports, &c., and then, of course, its climbing habit was called to requisition. In a bed a wire trellis should be provided for it to run over; and over this the shoots are to be trained so as to produce an even or flat surface. When left to trail over the ground and pegs are used to distribute the shoots evenly over the surface, the heavy dashing rains spoil it fearfully, and in some cases destroy it; but in all cases it is a sorry plant for surface covering. *Cobea scandens* makes an indifferent climber out of doors in a pot, in summer, in the north. *Lophospermum* do better; but even they require a warm situation to grow and flower freely in Yorkshire. Most climbers as Tropæolums for beds are pegged down like a Verbena, so as to keep the shoots in their proper position. We will treat of the cultivation of annuals in an early Number.

HOT-WATER PIPES DESCENDING (*J. D. and an Old Subscriber*).—It is awkward having pipes for hot-water heating to descend. It will not do if you take the pipes below the boiler. If you would give us a section showing us the position of the boiler, pipes, &c., we should be better able to advise you. You may rise from close pipes as much as you like. You may also take a flow-pipe from the boiler to a cistern, and from that cistern you may descend several feet, provided all is above the top of the boiler. We have taken pipes down under doorways, &c., but always attended to these conditions, and had an upright air-pipe at the bend.

PROPOSED BOILER (*F. D.*).—Once more might we trouble our friends not to refer to anything in our pages without giving us volume and page? Will they allow us to tell them the reason? It is shortly this: When a letter reaches us we give it the utmost consideration in our power, and if we cannot answer it satisfactorily we at once say so; but having done our best, and having many other cares, we at once dismiss it from our consideration, and pretty well from our memory. It may be the subject of subjects to our correspondent's estimation; but then we have to deal with hundreds of such pets, and scores of matters besides. Our friends will much oblige us, and serve themselves, by co-operating with us in this matter. We perfectly recollect "F. D.'s" communication, but so forgot the time, that we had to look over five Numbers before we found the reference to it at page 103. On reading over carefully his second communication, our opinion as there expressed remains unchanged. Of course we do not for a moment wish to set up our judgment and practice as superior to his own experience, but we may agree to differ through our doing so. We say that we see no improvement in the plans he suggests, except in his disposing now of one objection we made, by bringing the water of the boiler down to the bars.

POINSETTIA ALBA.—In the *JOURNAL OF HORTICULTURE* of February 9th, "K. T. W." asks (page 112) if any one knows the *Poinsettia alba*. I cultivated it largely for a number of years, and nothing could be more beautiful than a basket filled with the red and white *Poinsettia*. I lost my stock of alba through the negligence of a man who had the charge of the plants, and have never been able to obtain it again.—G. SMYTH, *the Hirsler, Coldstream*.

AGRICULTURAL CHEMISTRY (*A Constant Reader*).—"Johnston's *Lectures on Agricultural Chemistry*," price 21s., is the best work on the subject.

STOPPING THE SHOOTS OF PELARGONIUMS (*F. H.*).—By stopping the shoots at the present time, the blooming period will be later, but it will not be in any way inferior, and the plants if becoming tall, will be improved in shape by stopping. Generally speaking, small young plants rising up with only one or two stems are stopped now, while older specimens that have formed suitable heads are left to grow on and flower at the proper time.

VARIEGATED GERANIUMS (*L. S. H.*).—The leaves of the white variegated Geranium were too much faded at the sides to enable us to determine what they were—whether Brilliant, Alma, Eijon, Mountain of Light, or a score of others. In fact, it is next to impossible to say what kind they belong to by a small leaf or two. The one with the yellow edge is, or like, one called Golden-edged. If so, it is rather strong-growing, and though showy, yet inferior to Golden Chain and Cloth of Gold. It would be well to lay the cuttings you have received in a shady place, and sprinkle them with water of about 60°. This is much better than putting them in water. Then to get them to strike fast, you can make them in the usual way, and insert round the sides of pots in sandy soil; and as you have a tank, give them a bottom heat of from 65° to 80°, and a top temperature of 60°; and though the soil must not be dry, the plants should have little water before they begin to grow. Much moisture after a journey is apt to destroy them.

DELTZIA GRACILIS NOT FLOWERING (*Torkshire*).—It is difficult to account for your plants not flowering from any other cause than that they may have been neglected after going out of bloom the preceding year, as we have sometimes seen such plants thrown aside with very little attention; and, perhaps, in very cold weather in early spring, taken from the plant-house and put out-doors. If such has been the cause, their not flowering is easily accounted for, as of all plants this seems the best and surest bloomer we know of. Ripen the plants well in the sun the previous year, and we have no doubt but you will succeed in blooming it profusely. It never gets very large. The old wood seems to give place to the young something in the same way as the Raspberry.

BOILER REQUIRING NO SETTING (*Idem*).—We have seen one of the kind you mention doing duty in a greenhouse in Kent, but we did not notice the name of the maker. It was a double cylinder, the water forming a sort of jacket, being between the two cylinders in a body about 2 or 2½ inches thick, the inner or chimney part being about 8 inches in diameter. As near as we can remember it stood upright in a back shed. A short iron pipe connected it with a chimney the same as ordinary Arnott's stoves. We understand it did its work pretty well. Certainly it heated the shed also. Whether this might be so much heat wasted or usefully employed must be left to the opinion of those who propose to erect such things.

SEA-KALE ON SANDY SOIL (*An Old Subscriber*).—From your description your soil seems better adapted to the growth of *Rhododendrons* than Sea-kale, as the prevalence of iron in the sandy subsoil is not by any means favourable to the latter. Nevertheless, if you have a depth of 15 or 18 ins. of good working garden soil, Sea-kale may be made to grow tolerably well, if a liberal allowance of good dung is afforded, as well as now and then a dressing with salt, the latter being scattered on at various times during the summer. If your soil had not been sandy we should not have advised much salt, but being open and porous, frequent saltings during the growing season will be of service. Generally speaking, Sea-kale suffers much from the careless treatment it receives after being forced. The plants are often suddenly exposed to the cold frosty air of February or March, after being confined amongst hot dung and leaves, and such sudden changes are sufficient to account for the death of now and then a root or two; but we have rarely found Sea-kale fail under any ordinary cultivation, while it is needless to say it relishes the good things of the manure-yards in tolerable abundance, and that all the better when combined with salt.

TREE ONIONS.—We should be very pleased to supply a "Young Subscriber" or any other lover of the curious with a bulb or two. They can be had by addressing—W. EARLEY, *Digswell, Welwyn*.

GROUND VINERY (*F. H. A.*).—You will find a drawing and description in No. 28 of the New Series of this Journal.

NAMES OF PLANTS (*A Constant Reader*).—Probably *Eperis nivale* and *impressa*; but quite as likely to be some of the many garden varieties, with white or pink flowers, and which it is impossible to name from fresh (let alone faded) specimens, without a collection at hand for comparison. (*Wm. L.*).—1, Damaged, apparently a *Tydem*; 2, *Eranthemum nervosum*; 3, *Cyanotis vittata*; 4, an *Echeveria*, but insufficient; 5, *Cassia articulata*; 6, *Pilea serpyllifolia*.

POULTRY, BEE, and HOUSEHOLD CHRONICLE.

THE DISQUALIFIED GAME FOWL PENS AT BIRMINGHAM.

WERE I to remain silent my motives for so doing might be open to misconstruction, after the really unexpected and equally undeserved imputation spontaneously cast upon my good name by Mr. Smith, in his letter inserted in your last week's publication.

I distinctly stated a simple fact, the truth of which Mr. Smith is unable to controvert—viz., that the Game cocks in the Birmingham disqualified pens bore distinctive marks—that is, marks different in formation to those of their competitors. I should have supposed my statement palpable enough to bear no occult construction. It certainly was my sole intention when writing, that it should be open to none other than the expression of the one single fact conveyed. The suggestion in your last week's paper I repudiate altogether; it emanates exclusively from Mr. Smith himself, it is none of mine. I am not aware that my examination of the Game fowls in question at Birmingham (both on the Monday morning, several hours before the prize cards were taken down, and a second time later in the week by gas-light, long after such prizes were removed), at the earnest request of many amateurs then present, and whom I know to move in positions in society equally respectable as Mr. Smith or myself, had anything whatever to do with the "dis-

qualifications" that eventually ensued. I must, therefore, leave Mr. Smith to the full enjoyment of his own surmise, if he really holds it to be the correct one; for with these so-called "Game fowl disputes," in which Mr. Smith seems to take so active a part, I will personally have no connection whatever, as it is no business of mine: consequently, it is useless of Mr. Smith thus seeking to involve me in these proceedings. EDWARD HEWITT, *Eden Cottage, Sparkbrook, Birmingham.*

RELATIVE ENTRIES.

MANCHESTER POULTRY SHOW.

"Tis a long lane that has no turning." Some of your readers, perhaps, think my yarns are like the long lane; but having promised an analysis of the Manchester entries, I can only make it, post it, and leave you to commit it to the tender mercies of the waste-paper basket if you think the subject has been mooted *usque ad nauseam*.

Manchester has had its fling—the prize-list liberal and grand beyond the height of poultry grandeur. Has the result equalled the anticipations? Not being there to see I cannot possibly say. I can only judge from the catalogue and the remarks in the poultry papers. From the catalogue I should augur that, excepting certain classes, it was a decided failure. Firstly, in 129 classes we have only thirty-eight containing commended or highly commended pens, excluding those obtaining prizes. From this I gather either that the Judges were exacting, or that birds of inferior quality competed. In several classes the birds exhibited had "no merit." In nineteen classes there was absolutely no entry at all, and in the same number only one entry, whilst in eleven others only two entries were made. Forty-nine classes, in which the highest entry was two, would seem to speak volumes. To me it says that there is something either in the promoters, the situation, the season, or the principle of the Show, which renders it distasteful to the mass of exhibitors. The first two may be dismissed, as from all reports they are eminently satisfactory. The season has been urged by some of your correspondents as a reason for not entering at Manchester—the fact that Christmas day occurred in the middle of the Show. It may be the cause of paucity of entries, but I cannot think it is; for my own part I would much sooner my fowls had a day's quiet in the middle of the Show, as would happen on Christmas day or Sundays, than I would have birds started from a distant show late on Friday evening or on Saturday morning, their owners vainly looking for them on Saturday, sending some miles, perhaps, once or oftener, as I have done myself to avoid, if possible, that work on the Sunday; and when the birds do arrive, and you fetch them from the station on the latter day, some kind friend wonders that you should so desecrate the Sabbath. This point has been noticed in your columns before, and I go hand-in-hand with all those who urge on framers of rules, &c., the necessity of so arranging the days that the sanctity of the Sabbath should not be unnecessarily interfered with.

The principle of this Show is the last point, and, as I believe, the chief point which has affected the entries. The Sheffield Show, which was a failure in many ways, especially to "successful" exhibitors, and the Manchester Show, have these two points in common—a redundancy of classes, and prizes dependant on entries. I am disposed to think success is incompatible with the junction of these two principles. An abundant class list may be tolerably filled when an exhibitor sees there are prizes to be obtained; but if the "prizes according to entries" are to succeed, it strikes me the classes must be as few as possible. At this time of year young birds can often beat their seniors, and in many of the classes they might very advantageously to the prizetakers have competed together.

Few of us like to send our birds long distances to find that they are awarded first prizes which only amount to their own entry money. Moreover, prizes thus obtained place a fictitious value on the birds that win, yet it must be allowed that the principle is fair and just. To make it, however, really palatable to the great mass of the exhibitors some alterations appear necessary. I would suggest two plans—first, to give a prize of small value, say £1, and to add to it a share of the entries until that is repaid; if there are

still more entries, the whole then to go to the prizes, but not to limit the prizes to the number three as at Manchester—much better have five or six. The other plan I would suggest is to give a certain prize for any number of entries under five, to increase the prize or prizes for any number under ten, fifteen, twenty, &c. By the adoption of either plan an exhibitor would feel that if these birds had merit, and he was the only exhibitor, that his prize would pay expenses. I know not how others feel, I answer for myself. I like my hobby to be self-supporting. This it could not have been to the sole exhibitor in Classes 48 and 49, who had his entry money returned, and all his carriage expenses on his hands, yet your reporter says, these birds were very good.

While on the matter of carriage expenses I may add my testimony to that of one of your contributors lately, that the expenses of carriage by rail form a serious item in the expenses of "Exhibitors in a Small Way," and one deserving the careful attention of secretaries of shows.

But to return to Manchester. By the peculiarity of the entries and prizes I must conduct my analysis in another form. I propose to take the average number of entries in a class as the order of merit. The various breeds then come in the following order:—

Order.	Breed.	Classes.	Entries.	Average in Class.
1	Spanish	6	54	9
2	Game	21	140	6½
3	Hamburgs	20	93	4½
4	Cochins	15	64	4+
5	Brahmas	4	16	4
6	Dorking	14	55	4—
7	Bantams	18	42	2½
8	Crève Cœurs	2	2	1
9	Polands	14	3	
10	Malays	4	0	

It would almost appear that the Spanish-breeders had sent each other challenges to "meet at Philippi." This is the only Show, whose entries I have analysed, in which this aristocratic breed has made any sort of approach to the head of the list; but here they head the poll by a very long figure, no other breed coming anyway near them. This curious anomaly is difficult to account for. The Game with their multiplicity of classes follow at a very respectful distance; Hamburgs, equally favoured as to classes, come next, but far behind the Game; indeed, the former with the Cochins, Brahmas, and Dorking all come close together. In no other show that I have particularly noticed has the Dorking figured so low on the scale—positively the sixth! Bantams a long way off from these; Crève Cœurs next; then Polands, with fourteen classes mustering only three pens!! Malays with four classes—absolutely none!!

It is specially in breeds which muster indifferently that this method of awarding prizes will have a very bad effect, and tend to the positive cutting off of certain fowls which every one would regret to miss, simply because A reasons—"B and C are the only other fanciers, if they do not send I cannot pay my expenses if I win," and so A stops at home. Considered thus, these shows on this principle would deteriorate certain breeds. I trust, therefore, that if this principle is to be generally adopted it may be in a different form.

As a Brahma-breeder I am delighted to find that, examined by this peculiar prize list, my favourites are far from last; indeed I could look towards the future for my pets without fear, but for rumours that one hears that they are to be made "birds of feather," and that they are to be mapped out with a distinctness that would be becoming to a Laced Bantam or Hamburg, but is wholly unsuited to a breed which should be noticeable for size and form rather than colour. Experience has abundantly proved with large breeds that a forced attention to colour has been mischievous in effect. Who that is interested in the Cochin can forget its bad effect on that breed, and the sacrifice of nobler properties for the sake of colour? Indeed it may be truly said that they are only now recovering. I cannot but fancy some enemy has suggested the idea. Why should the dark or black portions of the light strains be restricted to hackle, tail, and flight feathers? My earliest light birds were from the choicest strains, and I was wont to look coldly on birds, the fluff of which was not grey, if not darker. But enough. I only desire to raise a voice of warning, feeble it may be, but sincere and impartial as I no longer keep the light

birds, against the folly of making colour the most important point.

I have now arrived at the end of my tether or my promise as regards these large shows. The result of this scrutiny may be briefly summed up thus:—Firstly, that certain breeds are treated too well—viz., the Spanish, Polands, and Malays, the two latter breeds especially so. At the larger shows it appears imperative that some alteration in amount of premiums should be made.

Secondly, that Cochins, Game, and Hamburgs, by the number of classes and the prizes generally offered, have sufficient justice. Black Hamburgs have earned and well support a class of their own. They appear a useful breed, but of their purity I say nothing.

Lastly, the Dorking, although receiving large prizes in competition, does not obtain its fair share. Neither does the Brahma, fast becoming a very popular fowl. At the larger Shows, as Birmingham, the Agricultural Hall, and the Crystal Palace, they deserve more classes and more prizes. The two varieties might be separated in the "cock and two hens" classes, whilst fresh classes of "two hens or pullets," or "cock and one hen" might be added, and I feel confident the addition would be to the benefit of the show. At any rate, the most impartial person must allow that I have sufficiently proved that every "grand" poultry show ought to have separate classes for this most valuable breed.—Y. B. A. Z.

P.S.—Since writing the above it has struck me that a simpler plan of prizes on the Manchester principle might be adopted—that is, to let the prizes begin with £1, adding each entry. The visitors at a show ought surely to pay for something more than the feeding and attendants, and a liberal return to the promoters—they ought to pay a little to the prize money.—Y. B. A. Z.

ULVERSTON POULTRY SHOW.

THIS Show was held in the Victoria Concert Hall on Wednesday and Thursday, February 10th and 11th. The following is the list of awards:—

SPANISH (Black).—First, Burch & Boulter, Sheffield. Second, J. Garlick Liverpool. Highly Commended, T. Hanna, Ulverston.

DORINGS (Coloured).—First, Capt. W. Hornby, R.N., Knowsley. Second J. Robinson, Garstang. Highly Commended, J. F. Newton, Captain W. Hornby.

GAME (Black-breasted and other Reds).—First, J. Boulton, Ulverston. Second, T. Eastham, Preston. Highly Commended, J. Fletcher, Manchester; J. Boulton, Ulverston. Commended, K. Geisler, Ulverston; M. Billing, jun., Birmingham.

GAME (Duckwings and other Greys and Blues).—First, W. Myers, Ulverston. Second, H. Worrall, West Derby. Highly Commended, J. Fletcher; M. Billing, jun., Birmingham; W. J. Cope, Barnsley.

GAME (Any other variety).—First, J. Fletcher, Stoneclough. Second, T. West, Eccleston. Highly Commended, H. Adams, Beverley; S. Matthew, Stowmarket. Commended, F. A. Bretherton, Ramhill.

COCHINS (Any colour).—First and Second, Miss E. A. Aglionby, Grasmere. Highly Commended, T. Stretch, Ormskirk.

HAMBURGS (Golden-pencilled).—First, J. E. Powers, Biggleswade. Second, J. Dixon, Clayton. Highly Commended, T. H. Ashton, Tanworth. Commended, N. Barter, Plymouth; T. Robinson, Ulverston.

HAMBURGS (Silver-pencilled).—First, C. Moor, Foulton-le-Fyde. Second, S. Haggas, Keighley. Highly Commended, W. Harvey, Sheffield. Commended, J. Robinson, Garstang; J. Dixon, Clayton.

HAMBURGS (Golden-spangled).—First, Burch and Boulter, Sheffield. Second, N. Marlow, Denton. Commended, J. Dixon, Clayton.

HAMBURGS (Silver-spangled).—First, J. Robinson, Garstang. Second, J. Dixon, Clayton, Bradford.

ANY OTHER DISTINCT BREED.—First, J. Dixon, Bradford. Second, Mrs. M. Seamons, Aylesbury. Highly Commended, W. A. G. James, Kirkby Lonsdale; W. Hargreaves, Baeup; G. Linguard, jun., Birmingham; H. Laey, Hebdon Bridge; J. Dixon, Bradford; W. Harvey, Sheffield. Commended, R. H. Nicholas, Newport.

BANTAMS (Game).—First, T. Eastham, Preston. Second, D. Parsons, Cuerden, near Preston. Highly Commended, R. M. Stark, Hull; C. W. Wilson, Oxenholme; J. Munn, Manchester; J. Garlick, Liverpool.

BANTAMS (Any other variety).—First, Miss K. Charlton, Bradford. Second, W. J. Cope, Barnsley. Highly Commended, R. M. Stark, Hoi; G. Maples, jun., Wavertree, near Liverpool; R. Chase, Birmingham.

DUCKS (White Aylesbury).—First, Second, and Highly Commended, Mrs. M. Seamons, Aylesbury.

DUCKS (Rouen).—First, T. Robinson, Ulverston. Second, H. Worrall, West Derby. Highly Commended, M. Redhead, Kendal. Commended, T. Robinson, Ulverston.

DUCKS (Any other variety).—First, D. Parsons, Cuerden. Second, J. R. Jessop, Hull. Highly Commended, R. M. Starke, Hull; T. H. D. Bayley, Ickwell, near Biggleswade.

EXTRA PRIZES.

GAME COCKS (Any colour).—First, J. Fletcher, Stoneclough, near Manchester. Second, M. Billing, jun., Birmingham. Third, J. Fletcher, Stoneclough. Fourth, J. Hodgson, Whitlington, near Euron, Westmorland. Highly Commended, T. Robinson, Ulverston; M. Billing, jun., Birmingham. Commended, J. S. Butler, Foulton-le-Fyde.

GAME CHICKENS (Any variety).—First, M. Billing, jun., Birmingham. Second, W. J. Cope, Barnsley. Third, J. Fletcher, Stoneclough. Highly Commended, A. B. Dyas, Madley. H. Thompson, Minthorpe; Capt. Hornby, Knowsley; Miss J. A. Aykroyd, Bradford; G. C. Whitwell, Kendal. Commended, T. West, Eccleston; J. Fletcher, Manchester.

GAME BANTAM COCKS (Any colour).—First, J. Munn, Newchurch, near Manchester. Second, G. Maples, jun., Liverpool. Highly Commended, R. J. Robinson, Ulverston; J. W. Morris, Rochdale; J. Crossland, jun., Wakefield; C. B. Kennedy, Ulverston; R. Moon, Wavertree, Liverpool. Commended, R. M. Stark, Hull; T. Eastham, Preston; Miss M. Auckland, Chesterfield.

MR. HINDSON AND THE GAME FOWLS AT BIRMINGHAM.

IN reply to your correspondent "F.," I have to state that the man Pugh has been my paid servant for several years, as receipts in my possession will prove; and I have no hesitation in again asserting that the birds alleged to have been purchased by Mr. Williams were my property; and the Black Red bird which he says I "borrowed to show in 1863," was exhibited by me, when a chicken, in 1862, and at that time I refused to sell him for the sum of £5.

Beyond this explanation I do not at present purpose entering, as it is scarcely likely any person really desirous of sifting the truth of the matter would prefer writing under an assumed, when his real, address ought to redound to his credit.—JOSEPH HINDSON, Barton House, Everton.

FOUL BROOD.

(Concluded from page 106.)

ON the second outbreak of the malady I sought the opinion of "A DEVONSHIRE BEE-KEEPER," and a most experienced apiarian friend on whose opinion I can always place much confidence. The former recommended me to destroy every stock in which foul brood existed; the latter told me in addition, that although "a prophet hath no honour in his own country," still when once I had fairly been a sufferer from foul brood I would never be entirely quit of it. In his own case (I may mention he is no experimentalist, but thoroughly practical, his combs all fixtures), he would have been out of a stock long ago but for buying in swarms annually. Now as to the first advice, it would certainly have been much better to have destroyed my stock as recommended by "A DEVONSHIRE BEE-KEEPER," and saved my feeding. Still it has not altogether been thrown away, I having in one sense had value for my money in being thoroughly convinced of the malignity of the disease. This possibly may save me from further losses in the time to come. As to the second, I sincerely hope my friend may prove a "false prophet" so far as regards the apiary of Mr. Woodbury; and sooner than be a continuous sufferer as my adviser has been, and possess what of all things I would most dislike, "a dwindling apiary," I am quite prepared to make a grand configuration of my entire stock and whole appliances in use during the late season (for the plague infection, as it undoubtedly is, cannot surely be atmospheric), and so shake off the disease, buy in a new stock, and commence bee-keeping *de novo*.

Before proceeding to take a glance at the controversy generally, I must confess to have been more nonplussed by this foul-brood business than by anything I have met with in my apiarian experience. Could it be that these interesting insects which I always deemed, if properly looked to and tended, proof against disease, were to become the victims of a virulent malady—bad enough, certainly, in every individual case to the owner of a row of common straw skeps, but fearful to contemplate in its results to the proprietor proud of his scientific apiary? I all along wished for the sake of bee-keeping generally that Mr. Lowe's able arguments were sound; that our brother of Devon had somehow been too experimental; but then there were the undoubted details of that brother's painful experience, not lightly to be explained away by any amount of plausible theory.

Mr. Lowe was borne out in his opinion by Mr. Taylor, that foul brood is simply another term for chilled brood, is not at all an infectious epidemic, and, like chilled brood, easily extirpated by excision. No doubt any opinion emanating from so trustworthy a source as the respected author of the "Bee-keepers' Manual" carries with it its due weight

so, too, must that of Mr. Lowe, one whose enlarged views on many points of apian science and graceful contributions tend so much to adorn THE JOURNAL OF HORTICULTURE. But as to foul brood, the former, with that frank uprightness to be expected from such a quarter, admits that "it never came within my own observation." As to the latter, is it not possible he may have mistaken chilled for foul brood? If we except such allies as "AN OLD-FASHIONED BEE-MASTER" and Jonas Jackson, Mr. Lowe stands alone—at least, the mass of evidence is all *against* his peculiar theory. The keystone on which he rests his argumentative superstructure is, that bees do not remove chilled brood, on which point he invites the opinion of practical apianians, and on which I must beg most respectfully to differ from him. My experience taken negatively, if I may use the expression, is that in all hives put down at the end of the season after the cessation of breeding, or twenty-four days after swarming—saving an odd sealed cell here and there over the combs—I do not recollect of having met with, in a single instance, masses of chilled brood at all similar in extent or appearance to my diseased stocks of this season; and positively I have seen bees over and over again drawing out chilled brood after frost, and from different causes, in various stages of development. Then, again, we have the most marked contrast with foul-brooded stocks. The bees make no effort towards removal beyond piercing the cell-covers, as it were to satisfy themselves of its real presence, and display considerable anxiety to free themselves of the sticky offensive fluid at once if brought in contact with their bodies.

That foul brood is a contagious disease I have experienced to my cost, as detailed in the foregoing narrative; and what is of the next importance to the bee-keeper, contrary to my own hope and expectation, I have proved that it is *incurable by excision of the infected parts*.

I cannot draw these remarks to a conclusion without joining in the protest of more than one correspondent as to the peculiar "tone" of some of Mr. Lowe's communications affecting the experiences of "A DEVONSHIRE BEE-KEEPER," although it is pleasant to observe in his last communication he has condescended to come down from his theoretic eminence to examine—not ignore—the experience of his brethren, where, I have no doubt, Mr. Woodbury will meet him, as heretofore, with fair argument.

In particular, while deprecating, as much as Mr. Lowe possibly could do, keeping combs-brood one instant longer than is absolutely necessary from their natural guardians, still I do think he was a little too hard on our Devon friend. Surely some little allowance ought to be made for the peculiar position in which the latter was placed. He certainly did not advocate such a procedure as a rule; on the contrary, I have formed the opinion that he is far too enthusiastic a lover of the bee to adopt the course alluded to but from sheer necessity—indeed, he had no occasion to tell us of it; but he is fully aware that details of apian operations are at all times more interesting and useful to the reader than mere generalities. But what would Mr. Lowe say, did I tell him of a case that once came under the observation of one of the most practical and successful apianians in the West of Scotland? Finding the beauty of a valuable octagon-super marred by the presence of brood, and fearing were he to cut it out some irregularity might occur in the filling-up, he resolved, as the best plan, to take it off till the brood perished, then replace it, trusting to the known practice of the bees to carry out chilled brood; the cells subsequently to be filled with honey, the value of the box being in no way deteriorated. What was the result? After the super had lain not "in a warm corner of the kitchen for the night," but in a cool room for *seven days*, did it transform agreeably to Mr. Lowe's theory, that many-storied octagon tower into a mass of foulness? No, verily, but to the surprise and mortification of the bee-keeper, the brood was hatched out in due course, leaving behind them their dark impress, to the no small lessening of its value.—A RENFREWSHIRE BEE-KEEPER.

It was not till my return home the other day, after an absence of some duration, that I read over Mr. Lowe's recent communications on "Foul Brood," in which he labours to maintain his theory upon the subject in the face of the

most overwhelming mass of evidence in disproof of it. My opinion upon the subject has been clearly put forward in the pages of this Journal; and in all the multitude of words which Mr. Lowe has cleverly put together, I see nothing in the shape of fact or evidence to alter it. As to foul brood itself, I am happy to say that I have as yet had no experience of it (very familiar as I have been with corrupted chilled brood like Mr. Lowe), and I feel assured, begging his pardon, that Mr. Lowe is as entirely ignorant of this disease as I am. May he long continue to be so. My opinion has been deliberately formed on the abundant evidence detailed in these pages. If that evidence is insufficient to satisfy a reasonable mind, then I am free to confess there is no evidence in all the world, short of ocular demonstration, which ought to satisfy a reasonable mind, and we may gravely read and allow the "historic doubts of the existence of Napoleon Buonaparte." I wonder what Mr. Lowe will say to the story given by "A RENFREWSHIRE BEE-KEEPER," in your Journal of February 2nd? Here is fact on the evidence of a most credible witness, and fact most particular, and to the point. But there has not been wanting fact on evidence quite as credible before, yet Mr. Lowe maintains his theory.

He refers to a remark of mine at page 364, No. 136, where I say that "in strong hives bees are fully up to the requirements of the case, and remove all impurities as they occur." Surely this is no overstatement of the case. I must have been understood to mean in all ordinary cases it is so. If a sharp frost suddenly occurs after mild weather of some duration, in early spring or late autumn, it kills in many hives, both strong and weak, a quantity of larvae in every stage of growth. On the return of mild weather all these are dragged out of their cells and carried out of the hive, till the balance of purity is restored. Who has not seen this done scores of times? Bees invariably do this if strong enough, except of course when some epidemic visits them, such as dysentery for instance, or this fatal new disease, foul brood, which overmasters them. These are exceptional cases, and prove the rule. But I feel it is time to stop; Mr. Lowe in the very paragraph which contains the above quotation from my former communication argues entirely from supposition. We may go on supposing cases for ever and ever, and "out of nothing comes nothing." So I lay aside the pen in this controversy, content to abide the sure progress of truth, which must ultimately prevail.—B. & W.

ACCLIMATISATION OF BEES.

MUCH has been done and more is doing for the introduction of different species of honey bees both in this country and in America. In the latter country, Dr. A. Gertsacker, in concluding a very extensive memoir on the distribution of the honey bee, observes that the most valuable form for Europe would be the Egyptian, partly on account of their beauty, and partly because of their unwillingness to use their stings, which appears to be common to all African bees, and is also one of the recommendations of the Italian bee. The Syrian bee agrees so closely with the Egyptian that it may prove equally valuable; and next to these in value are the bees of the coast of Asia Minor. In England measures have been taken to import swarms of one of the East India species. We wrote for some relative information, and the following is an extract from a letter we have received from the vicinity of Myser.

"The natives call them 'makyam-flies,' and positively assert that they move their homes every month at the full moon, after eating up all the honey which they have stored during their stay in that place. They alight in the centre of a thick bush, a tree, inside the roof of a house—in fact, anywhere, except on the ground. After clustering for a short time they commence working, and soon get a comb filled with honey and larvae. I took a nest yesterday in my dhobie's house, but it was only a small one, and the bees seemed to have laid themselves out for breeding rather than storing honey; for though the comb was about 8 inches broad and 6 deep, there was only honey in the upper combs to the depth of about 2 inches, and the remaining cells were mostly filled with the grubs. I killed some of the bees as specimens for you; but as I am out in the jungle I forgot to bring them with me, so I will send some next time I

write. They are about half an inch long, rather slender, and striped black and white across their bodies.

"The curious thing is, that though they have stings they never use them when you take their honey; and if you like to rob the comb at night during this cold weather, you can take the bees up by handful without danger, for they are completely numbed. I have not tried to hive them, for a fellow engineer has told me that from experience he is almost sure that the story about their eating their own honey at the full moon is really true.

"I remember myself, that a long time ago, a swarm settled in a thick bush in the garden, but we took no notice of it at the time; and afterwards, when you made inquiries, I went to look at them, but they were gone, though the comb was left perfectly empty. Two swarms have come within the last fortnight, so that when the full moon comes again I will watch and see whether they are really such improvident gluttons as they are supposed to be. This kind, as I have said, are harmless, but there is a larger and more savage kind, which I have not seen. A fellow dare not go near their nests, for they would instantly attack him most savagely. Don't you remember the narrative of the two young fellows near Jubbulpore, which you inserted in the Journal when I was at home? They were hunted by these bees, and one poor fellow was drowned and the other nearly stung to death. They are terribly savage; and I hear from fellows I can rely on, that they have seen their combs hanging nearly 6 feet from the timbers to which they were attached."

DO MICE EAT BEES?

Asks "T. R.," at page 106. Most assuredly they do, combs and honey too, and are depredators much more to be dreaded during severe weather than spiders.

They often form a snug nest in the apex of the hackle, or even in a corner of a weak hive, gradually appropriating the contents. The careful bee-keeper is at once apprised of their presence by their excrements lying about on the hive or board. They are easily expelled from the hackle, and may be caught in the hive by throwing a piece of cap net or leno over it so soon as inverted; a few taps dislodge the mouse, which shows itself by darting against the net in its endeavours to escape.

Earwigs too are fond of nibbling at dead bees, but during severe frost the worst enemies of the living ones are the mouse, and that sly little marauder the tit-mouse.—A RENFREWSHIRE BEE-KEEPER.

BEES TRAVELLING BY RAILWAY.

PERHAPS the enclosed account of the removal of five stocks of bees may not prove uninteresting at this slack time among bees.

On the morning of January 6th, 1864, four stocks were packed with their floor-boards in a crate, two being placed on some straw at the bottom, and two above them with straw between; straw was packed all round and at the top. The fifth was packed with its floor-board and straw in an American flour-barrel. They were then forwarded to a railway station one mile on a goods van, thence a distance of sixty miles by goods train at night, and on the morning of the 9th taken by goods van a distance of twelve miles. The whole reached their destination without damage. They were all common cottage-hives. I took the precaution to remove all obstructions from the mouths of the hives, and prevented the bees escaping by means of a piece of perforated zinc. I also placed perforated zinc over the holes at the top, thereby allowing a free draught through the live. During the night of the 9th one hive was overturned, detaching all the combs from the hive (this was a swarm of 1863, and had had the bees from another hive joined to it in the autumn, and weighed 36½ lbs.), which was extremely vexing. However, I proceeded to remove the combs one by one, brushing the bees back into the hive. When I had removed all the combs, I inverted the hive containing all the bees upon the top of another stock-hive, having previously removed the covering from the hole in the top of the stock-hive to make a free communication between the two. By the evening all the bees had descended very peaceably into the stock, when I re-

moved the empty hive, and covered up the stock again with its perforated zinc. By-the-by, I cover up the holes in the tops of all my hives during the winter simply with perforated zinc, and have found great benefit from it; I now never know what damp in a hive is.

Let me also call the attention of your readers to a hive-stand I have used for several years, which is very simple and not expensive. It consists of a piece of 1½-inch gas-piping 3 feet long, driven into the ground about 20 inches; at the top is a block of wood about 10 inches square, and 2½ inches thick, with a hole through the middle into which the iron is fixed firmly; about half way up the pedestal is a kind of cup made of zinc, standing about 1 inch from it all round, which I fill with water. I was obliged to invent this last autumn, as my bees were infested and annoyed with earwigs, spiders, and ants, and the cup quite prevents their gaining the top.

The last two or three days there have been several drops, about as large as a pea, of dark orange-coloured semi-liquid stuff upon the alighting-board of some of my hives. The bees seem prosperous enough. Can any of your readers inform me what it is?—F. W.

EARLY POLLEN-GATHERING.—As many bee-keepers are interested in the first indications of returning activity, it may be desirable to record an unusually early commencement this year. On Monday, January 25th, being a bright and remarkably mild day, the thermometer in the shade ranging between 51° and 56°, my bees brought in abundance of bright yellow pollen, evidently collected from the yellow crocus. The crocus is cultivated in large quantities in this neighbourhood as a field crop, and, therefore, though but thinly in bloom at present, it constitutes a considerable pasturage in the aggregate. We have also in the gardens arabis, aconite, snowdrops, and primroses in bloom.—G. F. B., *Spalding*.

BEE SWARMING EXTRAORDINARY.—It is not always either agreeable or safe to have a swarm of bees almost inside your house; in such cases efforts to remove or even get rid of them may be deemed excusable. On Friday, January 22nd, a swarm, which for years past has taken possession of the space between the drawing-room floor and the dining-room ceiling of the residence of Mr. Buchanan, at Poultoncum-Seacombe, Wallasey, came out in vast numbers from their winter quarters, and disported themselves in front of his house as if it had been midsummer. The annual movements of this swarm have long been a source of interest and curiosity in the neighbourhood. On one occasion the entrance to their cells was closed up during the winter; but in the following spring the bees made their way out into the light through the same aperture which had been barred against them. And on another occasion, when it was thought they had been effectually destroyed by the action of burnt brimstone, great numbers of them were, nevertheless, untouched, and forced their way into the air in the following spring, and the swarm has never since been disturbed.—(*Liverpool Albion*.)

PREMATURE DRONE PRODUCTION.—On the 2nd inst. I was surprised to find a young drone still alive, and apparently quite matured, turned out of my Bevan bar-hive. This hive is very strong, but has no internal protection whatever, and has been fully ventilated since the middle of November; hence it would seem that the queen was actually laying, and that the bees succeeded in rearing brood in spite of ventilation during most intense frost.—J. E. B.

DORMICE AND OTHER MICE.

In reply to your correspondent, "Mus," as to where he may find some dormice, he must look along the hedgerows, and in woods and coppices, among the bushes, and in hollow stubs. They are frequently found by the hedgers and woodcutters. They build a small round nest of dried grass or bent, sometimes in a hollow stub or hole in a tree or

bank, but also frequently in a hawthorn, blackthorn, or gorse bush, at 2 or 3 feet from the ground. In these nests they are frequently found curled up in a drowsy, half-torpid state, generally two in a nest, with their tails turned over their noses, lying belly to belly, but crosswise. My children often have them. They feed on nuts, corn, seeds of weeds, and such like. Most persons who go nutting are familiar with the empty nutshells, with a small hole scraped on one side like what the squirrels make, only smaller. In confinement they are very fond of bread and milk. Some of these mice seem very tame, while others display much wildness. If mice that are unacquainted are put in the same cage they sometimes fight, and one or other will be killed. They are pretty little animals, with their bright black eyes, their sandy-coloured backs, and white bellies. Sometimes one has a white tip to the tail, which differs from the tails of other mice in being hairy, and slightly bushy. They seem to be nocturnal in their habits, as they become more lively and generally run about at night, while in the day they seem drowsy, from which cause they are commonly called sleepers. I know no reason why they should not breed in cages, but ours have generally escaped, or met with some accident before summer came. The last the children had was very tame, and frequently made its appearance at the tea-table, where it would sit up on its hind feet holding a piece of bread in its front paws, or drink milk from a teaspoon, and it seemed to enjoy cuddling in the children's bosoms. But poor "Benny" was not doomed to be a pet long; the cage door being unfastened, he got out when no one was near, and the tortoiseshell kitten cut short his existence.

When at school my schoolfellows were mice-fanciers. The common house mice we could do very little with, they were so very wild and untractable, and they gnawed our cages. The general favourite was the long-tailed field mouse. This handsome mouse is rather larger than the others and has a jacket of a reddish grey and a white vest; the ears are very large; the eyes large, prominent, and lustrous; the tail long and slender, which gives rise to their name. These will breed in confinement. We used to search for their holes in the stubble fields, and dig them out with our knives. They were easily tamed. The plan adopted was to drop the mouse if it seemed to be wild, into a hand-basin of water, where it was allowed to swim until quite tired, when it was taken out, wiped, rubbed, warmed, and comforted till quite recovered, when it seemed quite tamed, and a second ducking was rarely required. It was not so with the common house mouse, as no ducking would tame it.

The short-tailed field mouse differs from the long-tailed field mouse in having a short tail, and smaller ears and eyes. I do not recollect that we ever kept them, though I dug one out on the common at Calais that was partly white, and I kept it for some time as a curiosity.

The harvest mouse is the smallest which I know of the mouse tribe. They are very pretty, gentle, and delicate little things, of a light sandy colour, with a white belly and very delicate feet. They do not seem very wild and are social, being generally found in considerable companies.

The white mice so common in cages, and which may be bought in London for 6d. a pair, are also amusing little pets, and if not so easily tamed as the long-tailed field mouse, are nothing like so unmanageable as their common grey brethren. Mine used to climb a pole, swing on a string, or, yoked like oxen, draw a little waggon.

Bread and milk is the best food for mice, with oats; but they will eat almost any kind of corn or seeds, and show a great fondness for hempseed. They must be kept clean, or their cages smell offensively.—B. P. BRENT.

HERBIVOROUS ANIMALS AMONG YEW.

THE remarks under the above heading in your publication of the 29th of December recalled a conversation I once had with a most experienced forester as to the risk a gentleman ran in allowing his cattle to feed in a field centred by a yew quite unprotected. He held there was no risk, against which opinion I adduced the fact of a depredator having some years ago sawed off a branch from an old yew here, throwing the spray over the garden wall to escape notice, by

eating which spray six valuable bullocks browsing in the wood behind perished. He explained this after the manner of "J. M. S.," that in a withering state yew branches were rank poison, while in a growing one they were perfectly innoxious.

Some little time afterwards half a dozen heifers broke through a fence into the policy of a neighbour, and fed on a growing yew, and all died. This occurred about midsummer, during the full growth of grass, when the animals, unlike the famished deer, had no temptation to eat the yew to excess.

Next time I met the forester I duly apprised him of the exception to his rule in this catastrophe. He, however, frankly owned there seemed to prevail a wide-spread diversity of opinion on the subject, as at two noblemen's seats where he had served in his young days, the yews were in the one case quite unprotected, while in the other they were as rigorously enclosed.

For my own part I can offer no better solution of the difficulty than that there may exist a certain amount of fermentation in the withering branches generating an amount of gas in the stomachs of the animals partaking of it, similar in effect to what may be expected from their eating excessively when either prompted by novelty or hunger, as in the case of cattle breaking into a clover field. However, be that as it may, those having yews would err on the safe side by protecting; and at the same time, it would be very satisfactory could this diversity of opinion be properly reconciled.—A RENFREWSHIRE BEE-KEEPER.

OUR LETTER BOX.

POULTRY AND PIGGERY DIARY (*M/s. P.*).—It was not remunerative to the proprietor, who lived in Essex, and it is not now published.

VARIOUS BREEDS UNSEPARATED (*Old Cock*).—We are not friendly to crosses, because they are always unsaleable; amateurs of crosses like to make them themselves. Your cross would be a good one for eggs, but for nothing else. Crève Cœur and Spanish are both non-sitters, but excellent layers. The Dorking are excellent sitters and mothers. It is probable the mixture would in both cases lessen excellencies. You can only get good fowls by giving good prices. If you wish to know the points of the different breeds, you will find them in the new edition of "Bally's Fowls;" and they have been repeatedly published in our columns.

EGGS OF SEEBRIGHT BANTAMS (*C. G.*).—Sebright Bantams lay as many eggs as any others. The eggs are as large, but not always as fertile. Sebright Bantams are uncertain breeders.

PROFITABLE LAYERS (*Regular Reader*).—The hardest hens are the best layers in confinement—Spanish, Brahmas, Cochins, La Flèche; especially the first, because they are small consumers of food.

FOOD FOR COCHIN-CHINA FOWLS (*R. L.*).—Ground oats form the best food for Cochin cockerels and pullets. The scrap-pail of the kitchen is a very useful adjunct. Any buff feathers on the breast of a Partridge Cochin cock are a very grave fault if he is for exhibition. If only as a stock bird, put to dark hens free from the encroaching yellow tint, they may be got rid of; but it is very preferable to have a purely black breast.

PARTRIDGE COCHIN-CHINA COCK'S TAIL (*R. Webster*).—It is no advantage for a Partridge Cochin cock to have white feathers in his tail; but it is not a serious detriment, nor a disqualification. There is no cure for it. If you pulled them out they would be whiter. It is a common occurrence to find, after every moult, rather more white.

FOUL BROOD (*J. W. A.*).—We begin to think that we do not need any more "opinions" upon this subject, and that we had better wait until more researches have been made during the coming summer.

BEES (*James Jawling*).—The successful result sufficiently attests your good management. We think, however, you went for rather too much in attempting to get honey from stocks which had already given you two swarms a-piece. Colonies that are to be united in autumn should either adjoin each other, or should be a considerable distance apart; otherwise many lives are lost from bees returning to their old stand. For this reason bee-keepers might often exchange driven bees with advantage. We never tried the mode of uniting which you describe. Your partially-filled super may be completed in the spring. We have not found any advantage from giving bees flour in the spring.

MIGNONETTE (*R. N., Devon*).—It is one of the best of bee flowers wherever grown. The 10th instant was not very early for pollen-gathering commencing in Oxfordshire.

LONDON MARKETS.—FEBRUARY 15.

POULTRY.

The supply is moderate, and the trade very bad for any but the best quality of poultry.

	s.	d.	s.	d.		s.	d.	s.	d.
Large Fowls	3	0	3	6	Pheasants	0	0	0	0
Smaller do.	2	3	2	6	Guinea Fowls	2	6	3	0
Chickens	1	9	2	0	Hares	0	0	0	0
Geese	6	0	6	0	Rabbits	1	4	1	5
Ducklings	3	0	3	6	Wild do.	0	8	0	9
Partridges	0	0	0	0	Pigeons	0	8	0	9

WEEKLY CALENDAR.

Day of M th Week.	Day of Week.	FEBRUARY 23—29, 1864.	Average Temperature near London.			Rain in last 37 years.	Sun Rises.	Sun Sets.	Moon Rises.	Moon Sets.	Moon's Age.	Clock before Sun.	Day of Year.
			Day.	Night.	Mean.	Days.	m. h.	m. h.	m. h.	m. h.	m. h.		
23	Tr	Ring-Dove coos.	47.1	31.5	39.3	18	2af 7	26af 5	46 6	44 6	16	m. 8.	54
24	W	St. MATTHIAS.	46.8	32.9	39.8	17	0 7	28 5	52 7	4 7	17	13 33	55
25	Tr	Sweet-scented Coltsfoot flowers.	47.4	32.5	40.0	19	57 6	30 5	59 8	25 7	18	13 23	56
26	F	Alder flowers.	47.2	33.1	40.1	20	55 6	31 5	7 10	47 7	19	13 14	57
27	F	Frogs spawn.	47.9	33.7	40.8	18	53 6	33 5	14 11	11 8	20	13 3	58
28	SUN	2 SUNDAY IN LENT.	48.9	33.5	41.2	14	51 6	35 5	morn.	41 8	21	12 52	59
29	M	Ivy-leaved Speedwell flowers.	46.3	33.5	39.9	3	49 6	37 5	21 0	16 9	22	12 41	60

From observations taken near London during the last thirty-seven years, the average day temperature of the week is 47.5°, and its night temperature 32.9°. The greatest heat was 62°, on the 27th, 1846; and the lowest cold, 18°, on the 24th, 1860. The greatest fall of rain was 0.92 inch.

THE FLOWER GARDEN.

MANAGEMENT OF CUTTINGS AFTER THEY ARE ROOTED.



HE way in which a gardener accomplishes his objects and meets the demands that are made upon him has, in far too many cases, to be determined by the means and conveniences with which he is furnished. He has to carry out his operations as best he can, not as he would, or in that manner which he knows to be the best. It may be a mistake; but I do not think that I could possibly have made a remark to which more gardeners would respond with all their heart than that with which this paper is commenced. Do not, however, let the employers of gardeners suppose that I cast any reflection on their conduct in relation to this matter, for I feel that I have stated a fact of which they are to a great extent not so well informed as it is desirable that they should be. This

is, perhaps, one of the greatest barriers standing in the way of the advancement of improved gardening that could possibly be named. It may be questioned whether it be a subject for public discussion. That cannot set the fact—if it is a fact—aside. Doubtless this is a point in gardening which would require cautious and judicious handling, and much could be said on both sides of the question.

In no other department of gardening has the makeshift system swelled into more gigantic proportions than in its relation to the preparation of plants for the flower garden. Employers have little conception of the shifts and contrivances which many an intelligent gardener has to adopt between this time and the middle of May; and in many cases very little allowance is made for the ruinous effects that are caused to other things by cramming forcing-houses with plants for which they were never intended. Could the great anxiety, the immense labour and waste of time that are caused by the want of proper appliances and accommodation by which to rear flower-garden plants be correctly estimated, a good many would be startled. I do not make such an assertion as this without a fair share of experience both ways; and I would not recommend the owners of flower gardens to look into the subject as one in which their own interests and the comfort of their gardeners are largely concerned without being well convinced in my own mind.

In treating of the management of bedding plants from the time that they are struck till planted out in May, it is not intended to enter into the many contrivances which have been and might be adopted under different

circumstances. Knowing that all applications made to the Editors for information to meet the requirements of different cases receive special answers, it would only be a waste of time and space to attempt to anticipate all wants, knowing that many of the readers of this Journal have to prepare their plants under a great variety of circumstances: therefore I purposely avoid descanting on many makeshift systems, and shall confine my remarks to what I consider the most expeditious way of preparing a fine healthy stock of plants, at the same time keeping strictly in view economy of labour and space, as well as arrangements which tend to facilitate the operation of disposing of the plants when planting-out time with all its bustle shall have arrived.

As soon as spring cuttings make roots about an inch long they are immediately pricked off. When allowed to remain longer in strong heat they become drawn and weakly, and make a mass of interwoven roots to be broken more or less when moved. For this purpose we use the boxes from which the greater part of the Geraniums have been potted-off. They are all of one size, being 2½ feet by 1½ foot, and 4 inches deep. A crock is put over each hole—nine in number—in the bottom, and then 2 inches of old Mushroom-bed dung, nearly pure horse-droppings, is sifted on through an inch sieve. The boxes are then filled up nearly to the top with rich turfy loam and leaf mould in equal parts, with a little sand. The whole is sifted through the inch sieve to mix it properly and keep back any large tufts of fibre. Into these boxes 150 to 200 plants are pricked. They are then put into any convenient place where they can have a night temperature of 60°. They are shaded as little as possible—no more than is necessary, in conjunction with a moist atmosphere and an occasional dewing overhead, to keep them from flagging. A short time in such quarters suffices to set them growing freely; and they are then removed to cold pits, or frames where there is no artificial heat. For a time they are kept close; sun heat is husbanded by shutting up early and covering at night.

The roots soon reach the manure at the bottom of the boxes, and make fine, strong, dark green plants. From a large store stock in good health a great number of cuttings are obtained and pricked off at one time; and under such circumstances there is done away with that waste of time which is inevitable when the same work has to be frequently commenced and again left off. The boxes, being all of one size, pack closely together, and a small space holds a large number of plants. They require very little attention in the way of watering, are quickly removed from place to place when such is required; and when, as is the case here, the flower garden is a long way from the place where the plants are reared, the transit is speedily and safely accomplished. On these accounts I give the preference to the large-box system over any other that I have tried. In the light rich soil used they make fine healthy plants, and at planting-out time they are easily disposed in the places where they are required. Where distance has to be contended with, this mode has a great advantage over the pricking-out

in beds of earth, either in pits, frames, or artificial or makeshift trenches, by which means fine stock is very often raised. Either of these two ways is better than cramping such plants up into small pots, by which a vast deal more labour is incurred with less chance of getting a fine healthy stock.

We apply this system to nearly all spring-struck stock, such as *Verbenas*, *Ageratum*s, *Gazania*s, *Alyssum*s, *Heliotropes*, &c. *Verbena venosa*, that gem of all *Verbenas* for steady autumn display, is managed in the same way. It is sown in the first week of February, after steeping the seeds for forty-eight hours or more. When ready to handle two hundred or thereabouts are put into each box. It stands, or rather requires, more heat to make it grow quickly into strong plants than the other *Verbenas*, and can do with any amount of water. It is one of those plants that will almost bear to be as wet as a bog plant if in a smart heat, and will do all the better for it. *Lobelia speciosa* is sown about the middle of February, and boxed at the rate of 250 in a box, and in that way it makes fine plants.

I recommend this general use of large boxes to any who may still be pursuing the potting-off system, and with confidence say that it will save them much time and produce a healthier stock of plants. Even over the planting-out in beds it possesses many advantages, and that chiefly from the facility with which heat can be taken advantage of or done without when no longer required. I have seen such things as *Verbenas* and many other bedding plants struck in heat, then hardened off in colder places to make them fit for planting out in some makeshift frame, but not till they were long and wiry, after which, if they are to make fine plants, it must be by coming away again from the bottom eyes. I have had nearly twenty thousand *Verbenas* in boxes placed close together in the month of May, presenting the appearance of a surface that would give fine score for a green swath with a keen scythe. This year we shall not have nearly this number, as the arrangements in most cases are entirely altered every season.

It is generally found desirable, if not necessary, to multiply the stock of certain sorts of *Geranium*s by spring propagation, and fine plants can be had by the end of May from cuttings struck in February and March. In the case of scarce or newly-introduced varieties which it is desirable to multiply as rapidly as possible, propagation may be carried on the whole winter with success, provided a temperature of 60° with a rather dry atmosphere is at command. Before taking the cuttings from plants that have been potted up in autumn, I always like to let them have as much heat this month as will excite them into growth, and have always found them do better than when taken from a cold house while the plants were comparatively dormant. The method I adopt is to put the store-pots into a temperature of about 60° early in February; shady positions are avoided, if possible. They are kept in a healthy growing state as to moisture at the roots; and by the end of February or first week of March, all the longest growths are taken from the parent plants, first leaving two or three of last year's growth. If all the cuttings were ready and taken from the plants at once these would receive a sudden check, the young roots would perish, and in the case of delicate sorts some might die altogether. Whether in spring or autumn we like large cuttings, consequently they are left on the plants till they attain a good size. They are made in the usual way, and put into well-drained pots, pans, or boxes, as is most convenient, in sand and finely-sifted leaf mould in the proportions of two parts of the former to one of the latter. They are then placed near the glass in any position where they can have the full sun, and a temperature of about 65°, and when a little bottom heat can be afforded all the better. The atmosphere should be rather dry than otherwise. Under these conditions, and with a uniform medium state of moisture at the root, they are ready to pot-off in about three weeks after they are put in. As fine a striking of *Golden Chain* as ever I saw, was effected by putting a few inches of sand over a bed of hot leaves in a light, airy house. About a thousand cuttings were put in at one time in March, and very few out of the whole batch were lost. I have, however, given up the spring propagation of *Golden Chain*, finding that cuttings taken in the end of July or August, and struck out-doors in the hottest and most sunny position possible,

root like weeds, and make much finer plants than spring-struck ones. Besides this, other golden-leaved plants of more than equal beauty, and much hardier, render it not necessary to grow *Golden Chain* so extensively.

When it is desired that any favourite new *Geranium* should be increased into a large stock in the shortest possible time, the plants are not turned out of their pots when put into the beds. They are shifted into six-inch pots, and in these they are plunged into the beds, covering the pots 2 inches deep. In this way they, of course, grow freely; and when removed from the beds in October, they receive but little check compared to what they always must endure when planted-out and lifted and potted in the usual way. They are, consequently, in a far better condition for yielding cuttings throughout the winter and spring, and it is astonishing how speedily a large stock can be obtained in this way. In the summer of 1858 I procured about eighty plants of *Golden Chain*, with which to make a start here. They were treated as I have now described; and all that could be made of it in 1859 were plunged in their pots, and by May, 1860, I had more than two thousand plants. It may, however, be remarked, that it grows with unusual vigour here, the soil and climate being most suitable for it, and, in fact, all *Geranium*s.

Where time and accommodation can be afforded, I would recommend that all *Geranium*s be potted-off singly into three or four-inch pots according to their size. They come much sooner into bloom than when planted out of store-pots or boxes, or planted out into beds, and they are, moreover, not so likely to grow too rank for profuse blooming. When planted without being potted-off they lose their foliage, and look shabby for a long time, particularly if the weather be cold and wet. When they do lay hold of the soil they are apt to grow more to foliage than to flower, and the season is far advanced before the beds have a respectable appearance.

There is one more point in the preparation of flower-garden plants that I would here touch upon—i.e., the hardening of plants previous to their being planted out. That they should be well "hardened off," it is almost needless to affirm. I am, however, of opinion, that in many instances there is too much of it after a certain fashion, and that the well-doing of the stock after it is planted out—which should be the end in view—is, to a large extent, defeated. It is not uncommon to meet with plants in small pots exposed to a flagging sun for some weeks before planting time, with the idea of making them hardy. In this way they are subjected to baking droughts and a ducking of cold water alternately, in far too rapid succession; and instead of being called hardened, they should be called starved or roasted, for they become so miserably stunted and wiry, that instead of increasing in size, they not unfrequently become less. When planting time arrives their tissues are dried up and contracted, and midsummer is past before they start into healthy growth.

While disagreeing with this method, I would not have it understood that I disapprove of all plants being well hardened off before being turned out into exposed beds; but I object to such an extreme mode of accomplishing it. If, instead of so exposing plants in small pots all day for weeks to hot sun, they were either slightly shaded for a few hours in the hottest part of the day, or had their pots plunged, they would look very differently, and would be properly hardened, while at the same time they increased in size. The full exposure should be allowed in the early and latter parts of sunny weather, and on dull days. This is far better for the plants, and saves time and labour in watering. In large boxes, and in beds, plants can take care of themselves in this respect, for scorching heats and drought do not affect them as in small pots. Heavy rains are what must be warded from them, and not hot sun, any amount of which they can bear with impunity after the plants have met together and covered the soil.

D. THOMSON.

POINSETTIA PULCHERRIMA.—In answer to "K. T. W.," I beg to say that the white variety of the above can be obtained, I believe, at most large nurseries. If I find any trouble in procuring a plant, I shall be most happy to forward him,

if he will send me his full address, a cutting of the wood when properly ripened. There is no doubt but that the Poinsettia may be flowered in both the ways spoken of in his letter and your answer; but I believe the best plan is to strike young joints of the old wood. As soon as these have made shoots of three joints nip out the points, and again nip out the points if desired to be very large; but this second stopping will make the plants very late. By this means I have plants in No. 12-pots with five or six heads of bloom, each about 12 or 14 inches in diameter.—C. M. MAJOR, *Cromwell House, Duppas Hill Terrace, Croydon.*

ROYAL HORTICULTURAL SOCIETY'S FRUIT COMMITTEE.

RESIGNATION OF DR. HOGG AS SECRETARY.

We are requested to publish the following correspondence between Dr. Hogg and the Council:—

“99, St. George's Road, Pimlico, S.W.,
February 10th, 1864.

“DEAR SIR,—When I accepted the office of Secretary to the Fruit Committee of the Horticultural Society it was under the impression that the Council intended to maintain and develop the horticultural character of the Society. For a time I believed the Council were in earnest in this matter, and so long as I believed they were so I continued to fill that office. Recent events, however, have convinced me that some other object than the advancement of Horticulture is that which a ruling majority of the late and present Councils have in view, and I therefore beg that you will have the goodness to lay this my resignation before the first meeting of Council.

“I shall be glad if the Council will accept my resignation at once, and allow it to date from the 25th of December last. On hearing from you, I will send all books and papers relating to the Committee; and allow me to remind you that there is a meeting of the Committee on the 23rd inst., and it will be necessary to appoint some person to be present to act in the capacity of Secretary on that occasion.—I am, dear Sir, yours faithfully, ROBERT HOGG.—To ANDREW MURRAY, Esq.”

“Royal Horticultural Society, South Kensington,
February 19th, 1864.

“DEAR SIR,—I have laid before the Council your letter of the 10th inst., resigning your office (with salary attached) as Secretary of the Fruit Committee, and requesting them to accept it as from the 25th of December last. I am directed in reply to inform you that they readily accept your resignation as from the date of your letter.

“The Council see no reason for antedating your resignation, though they cannot but remark that your conduct would have been less open to observation if your resignation had been tendered before you took active measures in opposition to the Council.

“I am to point out that you are wholly in error in supposing ‘that some other object than the advancement of Horticulture is that which a ruling majority of the late and present Councils have in view;’ and they direct your attention to the fact that in the year just before the establishment of the gardens at South Kensington the Society had given up its shows at Chiswick; had ceased to employ a collector abroad; had abandoned the publication of any Journal or Proceedings; held no ballots for plants or seeds; had sold its herbarium and library; had also sold its premises in Regent Street, and located itself in two small rooms in St. Martin's Lane, whilst the Fellows had diminished in number to 985. Whereas, after the establishment of the garden at South Kensington, and while the management of the Society has been in the hands of the ‘ruling majority of the late Council,’ the flower shows have been re-established; collectors have been and are employed abroad; their horticultural publications have been resumed; Fruit and Floral Committees organised; ballots for plants have been instituted; and the Fellows have increased in number from 985 to 3336. The present state of the experimental and practical part of the Chiswick Garden is in high efficiency, and

greater advantages are derived from it by the Fellows than at any former period of the Society's career. The Council intend to resume meetings of the Society for discussion of papers, similar to those held in Regent Street, before those premises were abandoned in 1858.

“In conclusion, the Council observe that they intend to continue the successful exertions of their predecessors, and hope, through the means of the increasing prosperity of the South Kensington Gardens, still further to promote the science of Horticulture. The Council will publish your letter and their reply in their ‘Proceedings.’—I am, dear Sir, yours faithfully, ANDREW MURRAY.—To Dr. HOGG.”

“99, St. George's Road, Pimlico,
February 20, 1864.

“ANDREW MURRAY, Esq.

“DEAR SIR,—In replying to your letter of the 19th inst., I have to thank the Council for the readiness with which they have accepted my resignation of the office of Secretary to the Fruit Committee.

“In asking the Council to allow my resignation to date as from the 25th of December last, I thereby meant to indicate to them that I relinquished from then till the time my resignation was accepted any claim that might be supposed to have accrued to me for services rendered during that period. If, however, the Council ‘see no reason for antedating’ my resignation, I can have no reasonable objection to their adopting their own view of the case.

“The remark that, ‘Your conduct would have been less open to observation if your resignation had been tendered before you took active measures in opposition to the Council,’ is evidently made under a misapprehension as to the relation that subsisted between me and the Council. When I undertook, at their solicitation, the direction of the Fruit Committee, for which they awarded me a small honorarium (yet sufficient for the purpose), I did not by that limited engagement with them sacrifice my privilege as a Fellow of the Royal Horticultural Society to criticise when opportunity offered any act of theirs I conceived to be detrimental to the Society's interest. In conducting the operations of that Committee I performed all that the Council could demand of me; but if they thought by inviting me to accept the office they thereby secured my allegiance to every act of theirs, they misunderstood entirely the conditions under which I accepted their terms; for no consideration the Council could have offered me should have induced me to sacrifice my privileges as an independent Fellow of the Society, or to endorse any policy of theirs that I believed to be injurious to its interests. Had the Council proposed such conditions I would have rejected them.

“Whilst the Council direct my attention to the facts ‘that in the year just before the establishment of the gardens at South Kensington, the Society had given up its shows at Chiswick; had ceased to employ a collector abroad; had abandoned the publication of any Journal or Proceedings; held no ballots for plants or seeds; had sold its herbarium and library; had sold its premises in Regent Street, and located itself in two small rooms in St. Martin's Lane, whilst the Fellows had diminished in numbers to 985.’—I am reminded that it was the identically same ‘ruling majority’ or dominant influence in the Council then that has descended to recent Councils, and under whose inspiration the Kensington Garden was formed; the flower shows ‘have been re-established; collectors have been and are constantly employed abroad; their horticultural publications have been resumed; Fruit and Floral Committees organised; ballots for plants have been instituted, and the Fellows increased in numbers from 985 to 3336,’ and all with results so unproductive and disastrous to the interests of the Society as to leave it with a debt of upwards of £50,000, exciting the fears of all who are interested in its welfare, not excepting the member: of Council themselves. In this I certainly do not see any cause for so much self-gratulation.

“When I see the purely horticultural objects of the Society neglected; the old homestead at Chiswick impoverished in every way and kept hardly decent, its principal approach closed, and the only entrance to it by a miserable back lane; when I hear of £500 of the Society's

money sunk in the base of the memorial of 1851, and £300 squandered for three successive years on a very ordinary sculpture exhibition; when I see it announced that upwards of £100 is to be given away for the encouragement of volunteer bands, and the prize schedules of the Society's Exhibitions are reduced to the lowest possible scale that decency admits of; when I am told that the administration of the Society is placed under the control of a gentleman who has no connection with and no knowledge of Horticulture; and above all, when I see the professional element all but entirely discarded from the Council, I cannot but feel justified in using the expression 'that some other object than the advancement of Horticulture is that which a ruling majority of the late and present Councils have in view.'

"As the Council have signified their intention of publishing the correspondence, I request they will include this letter likewise. I may mention that I also intend to publish the whole of this correspondence.—I am, dear Sir, yours faithfully, ROBERT HOGG."

"THE ORCHARD-HOUSE CONTROVERSY."

WHEN I read the above heading to the article by "D., Deal," in No. 149, page 93, I felt some interest, thinking I should find something new as to the mode of managing fruit trees under glass. After reading it, I wondered what motive could induce you to insert or "D." to write it, for not a line of instruction or information could I find. I know the author to be a florist, *pur et simple*, to employ his favourite phrase; and I could not help asking the question, Why should he write a tirade against a species of culture of which he has not the least knowledge or experience? and why does he give your readers the shop gossip of a brother florist, reminding one of the classical language employed by two rival chandler's shop-keepers in a country village? Carping and sarcasm are poor materials to use in discussing a subject purely practical. Auricula-culture may be agreeable and intellectual. Some forty years since I was an enthusiastic Auricula-grower; but the trouble they gave for eleven months and a fortnight for, perhaps, a fortnight's satisfaction when they were in bloom, fatigued me; so that when my mind became strengthened by the lapse of years, I left their culture to ladies, lads, and quiet-minded clergymen.

As "D." has divided his article into convenient paragraphs, pray allow me to notice them *seriatim*.

Paragraph 1. I presume this is intended to be witty, as "Punch" is drawn upon. It may be so. I have only to notice one great error—no bitterness, no hard words, have been employed in your columns in defence of orchard-house culture; many innuendoes and small thrusts have been made against it by your contributors.

Paragraph 2. I believe I may claim the honour of having invented the term "orchard-house," a house adapted to the culture of many species and varieties of fruits.

Paragraph 3. "D." does not recollect aright. Hedges did not form the back and sides of the first orchard-houses. Anon I will give in a few words their history.

The greatest success has not been obtained where heating has been used—quite the contrary. I have never employed artificial heat, and yet my success has been perfect for many years. The innocence (what other name shall we give it?) displayed by "D." when he visited a brother parson who was building a rather lofty house, is really amusing. A roomy orchard-house, owing to its containing a large body of warm air, resists spring frosts much better than a low-roofed one. I never employ even a pan of charcoal in my large houses, 12 feet high and 24 feet wide. But in my low houses, if a severe April frost comes on while the trees are in full bloom, I either cover their roofs partially with mats, or place a pan or two of ignited charcoal in them; so that "Well, you have got it tolerably high, and I should think that it would hold a good deal of cold air, and your blossoms will catch an early frost perhaps," tells well for the knowledge of "D.'s" friend, who seems to have known what he was about, but, I am inclined to think, not so well for the "cuteness" of "D.'s" mind. I say this without the least wish to be offensive: it is simply the truth, and I have quoted the passage correctly.

Paragraph 4. The original notion was not that the trees were to be grown in pots—quite the contrary. I had the pleasure last year of seeing Dangstein. My only and great disappointment was the orchard-house. I had pictured to myself a fine span-roofed house with a promenade in the centre and the trees planted in the borders, as I had heard they were. I found a long, narrow, lean-to house, built, I presume, in the earliest days of orchard-house culture, with borders bricked up by far too high, so that the trees, cramped in their upward growth by the roof, are not able to develop themselves. Mr. Vair, to whose courtesy and kindness I bear most willing testimony, is too good a gardener to suffer anything under his care to be out of health; consequently they were clean and healthy, but sadly cramped. I suggested to him that the house should at once be doubled in width by making it into a span-roofed house. As far as I remember, he agreed with me that it was quite necessary. I think I may say that this house would not give better fruit if the trees were trained; for it is too narrow for a trellis-house, too confined and narrow for an orchard-house, and is such a one as, I think, Mr. Vair would not have planned. It might do for Auriculas.

Paragraph 5. An orchard house may be "one *pur et simple*," and not "a make-believe," even if it be heated. North of the Trent as a rule—no, the exceptions are too numerous to make it a rule—we will then say in damp cool climates in Ireland, Scotland, and a portion of England, a four-inch hot-water pipe round an orchard-house is very beneficial, for it brings on the ripening of both fruit and shoots; but this does not destroy the nature of the house, for if it be heated even with three or four hot-water pipes, but still appropriated to the culture of various kinds of fruits, either planted out or in pots, it is a pure orchard-house. Call it a forcing orchard-house if you are rich enough to have more than one. The most successful orchard-houses I have seen have been without the least artificial heat, so that we need not "quietly shelve" their success. What an odd train of thought must have prompted this paragraph! It is certainly from that now rare species of the "genus homo," an original thinker. "Oh, that mine enemy would write a book."

Paragraph 6. Do they pay? (This reminds me of the nigger who, on being shown a beautiful flower said, "Him no no good. Somebody [meaning nobody] can't eat um.") Do Roses pay the amateur? Do Auriculas pay? Do Chrysanthemums pay? Does any garden, any mode of culture, to use that "shop expression," "pay" the lover of his garden? He may derive pleasure, and health, and other blessings from his garden; and what a blessing it is to be able to send a dish of choice fruit from the orchard-house to a sick neighbour or friend. "Does it pay" to do so? Yes, it pays the sender in the purest gratification the human heart can feel. The care the trees require in pinching and keeping from aphides (I am not aware of any "monsters" in the insect life of England; perhaps "D." is, and will tell us all about them), is just about the same as required by wall trees. Aphides, red spider, and the curl are all to be fought under a great disadvantage in the open air; and then we have the incessant disbudding, and pruning, and nailing, without the gratification of a fine climate in inclement weather.

Paragraph 7. I am neither an exhibitor nor a prizeman, but I will honestly confess I felt last July a strong wish to show my trees to the public. On consultation with those who knew their nature even better than I do, I reluctantly gave it up, for it was hopeless to think of transporting them unless in a handbarrow. I must here tell "D." and his friends, that no orchard-house Peach and Nectarine tree should be shown in a pot till its fruit are fully grown, fully coloured, and just on the verge of ripeness; Apricots, not till their fine golden colour is fully developed. Now, all orchard-house cultivators know that the least agitation of the tree when its fruit are in this state is fatal to their holding on. Like Jack, they may wish to do so with "fingers and toes," and you may wish them to do so, but to a certainty all the finest will drop if transported by road or rail; and this, friend "D.," sufficiently accounts for the poor unhappy trees with their miserable green fruit which we have occasionally seen exhibited.

End of the same paragraph. For "the proof of the pudding,"

please to read, the proof of a good mode of culture, be it *agri* or *horti*, is in the effects produced. If "D." had visited me last July with Dr. Hogg, he would have seen the most glorious crop of Apricots ever seen or tasted, and Peach and Nectarine trees in the most perfect health and fruitfulness; but, oddly enough, he, like your contributor Mr. Robson, whom I invited, and who publicly accepted my invitation, did not come. I am not anxious about a visit from "D.," because he is a florist "*pur et simple*," but I should have liked to have seen Mr. Robson, and to have convinced him against his will that my trees were not from the "spirit-rappers," but real trees full of fruit and leaves. I found that he visited Liverpool instead of performing his promise to me. Doubtless he found the journey shorter and more agreeable; but I repeat, it is odd that these people will not look at head quarters. If a new machine is invented and sometimes fails from the incapability of the users, they generally go for advice and satisfaction to the inventor. Verily some gardeners and florists are a little eccentric occasionally.

Paragraph 8. I presume this was written by the amanuensis of "D." and was not corrected, for surely no gentleman would ever think of repeating *verbatim* the gossip of a tradesman. This friend it seems, "has had no less than three collections to dispose of because the thing is a complete failure," and he knows of two other cases in which the "notion" has been abandoned. This makes a total of five failures, bearing but a very small proportion to those that have succeeded; for, taking the number of trees at two hundred, what will "D.'s" friend say to the startling fact, that from this place alone upwards of a hundred thousand orchard-house trees have been sent out within these few years, their after-culture having been attended with almost unvarying success, the exceptions, very few in number, having arisen from incompetent gardeners and houses improperly ventilated? In the former instance it has, perhaps, not been so much owing to incompetency as to the spirit of routine giving way with difficulty to anything in the shape of innovation. It seems, according to the informant quoted above, that "Mr. Blank, at Chiswick, was right when he said at the beginning of the attempt," and *before he had seen and tried* the experiment, "it won't, it won't do;" a powerful logician that Mr. Blank, most likely a prizeman from one of our universities. I may here mention that they have no orchard-house at Chiswick, and never have had one. It is true there is a dark house in a hole, in which Mr. Barron, the clever manager of the houses, has done wonders, for finer Plums, and I think Pears, I never wish to see than I have there seen, but Peaches, Nectarines, and Apricots cannot succeed in such a confined place. It seems that "D.'s" friend is very glad that he "did not go into the growth" of orchard-house trees. This is of course a very interesting fact to be recorded, as is that most remarkable one that "it is so much colder under glass" than in the open air. Your readers will, I trust, try the experiment, and give us the temperature of their houses in contrast with that of the open air.

Paragraph 9. This seems to breathe pure charity: the writer is anxious to save the pocket of his "very dear brother," and prevent his friends being disappointed. He has had no personal experience, but he has gossiped with gardeners in great places, where, as I have stated in a former Number, orchard-houses are out of place. He has not been to those who delight and succeed in their culture. He has not been here, where for years past the trees, when covered with their ripe fruit, have charmed all who have seen them. I repeat he has had no personal experience, without which no experiment in horticulture can be fairly understood. He has gathered the information from persons, like himself, without it. He has not gone to places where orchard-house culture is a source of great enjoyment; and, above all, I repeat he has not been here to go over the trees critically, to count their fruit, to taste their flavour, or even to share in the enjoyment of the blossoming season, when, to quote the words of one of our greatest philosophers, whom I am proud to number among my friends, "A well-arranged orchard-house is a paradise." He has not done this, and yet he has written a long tirade against a popular mode of cultivating fruit, which in time will supersede all other modes as certainly as that railways have superseded stage coaches. At the end of the paragraph I am now noticing I find a sneer—surely it looks like it—against dessert Orange-

culture. This branch of fruit-culture is no new idea; it is, indeed, nearly two hundred years old; for Evelyn, in his "Diary" for September 25, 1679, says, "Mr. Slingsby and Signor Verrio came to dine with me, to whom I gave China Oranges off my own trees, as good, I think, as were ever eaten." Surely we can do this now with our improved modes of heating and great advance in gardening skill. Tangierine Oranges are now, and have been for some years, regularly cultivated at Trentham and Welbeck for the dessert. Mr. Henderson, who certainly ranks among our most accomplished fruit gardeners, had a large supply of fine fruit from early in last October to Christmas, in their flavour and aroma far superior to those so abundantly imported at the latter season, and forming a most charming addition to the dessert after the Peach season. I have now lived some years, my life has been devoted to horticulture, and I have always held firmly one idea—that what one man can do well can be done by others. This will apply not only to Orange and orchard-house culture, but to everything connected with the progress of mankind in science and art.

"D.," it seems, "ventures to doubt the success" of Orange-culture, and knowing nothing about it, trusts to hearsay evidence, being "borne out" in his view by experienced horticulturists. I should much like to know the names of those who have tried Orange-culture and failed. The truth is, we shall in the course of a very few years have houses devoted to dessert Orange-culture in the garden of every man of taste and refinement. Such large, uncouth, worthless trees as we have hitherto imported from France and Italy will not be used for this purpose, but nice English trees, cultivated so as to show early fertility, which the foreign trees do not. I can imagine nothing more delightful, after the orchard-house Peaches are past, than an Orchard-house filled with trees of the most choice dessert varieties, such as the Tangierine, Mandarin, Maltese, St. Michael's, Silver Orange, and others, all in their different stages of ripeness, supplying the dessert till Christmas. I "am borne out" in my idea that all this *will* be done, because it *has* been done, and I do not trust to hearsay evidence.

I trust you will allow me to set "D." and some other writers in your columns right with regard to the origin and history of orchard-houses, which will prevent the repetition of errors like those in the third paragraph of the article in page 93. I pray your readers to pardon the unavoidable egotism.

In the remarkably fine summer of 1842, I happened to be making one of my usual happy summer tours in the provinces of France, and I remember one day having a rather lengthened rest at La Flèche. In rambling about its environs I came to the garden of an amateur, who seemed an enthusiast in fruit-tree culture; with the freemasonry peculiar to our craft, I forget how, I procured an introduction, and had a long walk and a long talk. I never remember having been so struck as I was with the trees in that garden, so nicely pruned and arranged; there were no espaliers or wall trees. I could not get out of my mind some rows of Apricot bushes nicely pruned and pinched, covered with fine fruit; and, planted between the rows, Melons with their fine fruit nearly ripe lying on the ground. I fear I envied Monsieur his climate. Well, this picture of what could be done in a fine climate haunted me, but it was not till about the spring of 1846 that I thought of trying to imitate it; and so I built a lean-to house with larch poles once cut down, half-inch boards, and asphalt felt, for, calculating that I might probably have to pull it down in the course of two or three years, I feared to build a more substantial structure (the house is still in being and perfectly sound). In this house it was my intention to make my first attempt at imitating the climate of France; so I excavated a path in the centre, and in the two raised borders I planted two rows of Peach and Nectarine trees (bushes), a row on each side of my path. The second year after planting they all blossomed gloriously, but fearing to make my climate too English, I kept the house closed. The blossoms nearly all dropped without setting their fruit; then came the young leaves, and with them aphides of all sorts and colours, then red spider. The season ended in my trees looking rather the worse for their year's growth in a fine climate. The following season aphides were killed with tobacco water and fumigation, and spider by abundant syringings morning and

evening, and although I lost most of my fruit from the blossoms dropping, I had some fine Peaches; but a full crop of Pitmaston Orange Nectarines gladdened my heart, and made me an orchard-house cultivator for life. In 1848, my trees, now three years planted, became impatient, and the roof of the house being low, I could not keep their shoots from sundry rude attempts to pierce it, so the next autumn I root-pruned the trees, still they were like Joe's sister in "Great Expectations," inclined to be "rampageous" during the following season, and then, and not till then—viz., three years or so after the first orchard-house idea had sprouted, did I think of pot-culture. Now, please Messrs. D, and E, and Co., not to write for the future "if I recollect aright," but remember that hedge-houses were not the first houses, nor potted trees the first orchard-house trees.

In December, 1851, at the earnest solicitation of my dear friend, then the curate of this parish, now the rector of another, I published my crude ideas in the shape of a pamphlet. To my surprise this sold rapidly, and now the eleventh edition (or eleventh thousand) sells well, for since its publication in October, 1863, it has not once been advertised, and yet will soon be exhausted. When I wrote the first edition I had no idea of the gigantic results to follow, in the demand for orchard-house trees. In the autumn of 1851, I remember having a few hundreds, which I had potted for my own amusement. They were soon disposed of, many friends even begging me to supply them as a personal favour. I was taken completely by surprise, for I thought I should find but few amateurs who would take the trouble to cultivate orchard-house trees; in fact, I had not half comprehended the idea, or calculated to what an enormous extent it would go.

From 12,000 to 15,000 trees are now annually potted, yet the demand is beyond the supply—i. e., for large well-grown trees. I calculate that all this has arisen from the sound basis on which the pot culture of fruit trees rests. If your readers will refer to that most excellent article by Mr. Creed, page 91, in No. 149, they will see the *rationale* of pot culture for fruit trees, and read as follows:—"As often as the top soil is matted with roots, I dig it out with a trowel to the depth of 4 or 5 inches, and add fresh soil, perhaps four or five times during the season." With fruit trees we take out the matted roots once a year, in the autumn when they have done their work, and feed the young roots the following summer, either with liquid manure or surface-dressings. What can be plainer than that "the basis of all pot culture is the renewal of food and consequent annual supply of feeding roots?" I feel, after reading Mr. Creed's article, half inclined to try the effect of removing a portion of the roots of one or two Peach trees about the end of June, merely to see if more food can be taken up by inducing a fresh growth of fibres—it is quite worthy of a thought.

The truth is, we have yet much to learn in fruit-tree culture. I have a firm belief that we are at the commencement of a new era in fruit-culture, and that we have much, very much, to learn. Depend upon it, fruit-culture under glass is as yet in an embryo state, it is not yet in its infancy. As to trades against any particular mode of culture I am a rhinoceros, my hide is so thick, but I like to use my horn. Some thirty years ago I advocated the culture of Pears on quince stocks for gardens, the "notion" was abused "a hip and thigh." A, and B, and C, and I daresay a "D" or two, declared that the trees would not live more than two years, and that to plant them was an imposture, to sell them was robbery. My magnificently thick epidermis carried me through unharmed. I used my horn now and then, and what is the consequence?—instead of Pears being worked on our common English quince, raised from layers by the Surrey nurserymen, the proper sort of quince is employed, and the most perfect success attends their culture. Allow me to give an instance. Eighteen years ago I planted 2000 pyramidal trees of the Louise Bonne of Jersey Pear for the purpose of supplying Covent Garden with their fruit. I lost many crops by the spring frosts so prevalent from 1846 to 1853-4; but I was amply rewarded by sending to Covent Garden in 1855 and following seasons some hundreds of sieves of the finest Louise Bonne Pears ever seen in that market.

I now come to the peculiar benefit derived from the use of the quince stock for Pears. The roots of my trees in the

course of years gradually made their way through the loam into a calcareous sand, which brought on "chlorosis," and made them wretchedly unhealthy. In the autumn of 1861, and in the springs of 1862 and 1863, I had them all removed to a deep loamy soil where they promise to do well. Now, although these trees are twenty years old, I have not lost five per cent. If they had been on pear stocks, as some are which were planted at the same time, not a tree could have been removed with safety.

And, now, Messrs. Editors, allow me to correct what the Yankees would call your "endorsement" of "D.'s" idea of an orchard-house. I originated the term, and humbly conceive that I know the idea I wished to convey. An orchard-house is a house in which should be cultivated many kinds of fruits. If, in the north, a four-inch pipe be necessary to hasten the maturity of fruits, it does not take away its character. A house for Vines is a vinery; a house for Peaches and Nectarines is a Peach-house; a house for the culture of the above, and many other kinds, is an orchard-house. Among our oldest houses of this kind are those at Stornoway, in the Isle of Lewis, erected by Sir James Matheson, I should think nearly ten years since. I remember having some Pears sent here which were grown in them, of a surprising size. Now, if in that damp, cool island one four-inch pipe is necessary to correct the climate, it does not take away the character of the houses. So I pray you to reconsider your verdict.

I am inclined to think that the love of fruit-tree culture is bred in me. I am the fourth generation living on this "hill," formerly called "Bonk's Hill." The little compact estate was bought by my great grandfather in 1720, a florist great in Carnations, and great in wine, if one may judge by the wine-cellar he built, now a capital fruit-room. My grandfather was a great planter and lover of fruit trees, my father the same. I inherit his love for trees, and plants, and flowers, and hope to continue to do so till the end. I can safely say that I find the culture of fruit trees more engaging than ever, and an unfailling source of quiet pleasure; still I feel that I am only a learner, and so I hope to continue.—THOS. RIVERS.

[We once heard a boy allege that "suit" was the way to spell soot, because the chimney-sweeper so spelt it, "and he must know," a logic not more correct than that of our esteemed correspondent's conclusion that "orchard-house" must mean what he intended it to mean—namely, a glass structure heated when the climate requires heat for successful fruit-culture. That, doubtless, was his intention, but that does not justify his definition. It is true that a heated structure for Peaches is called a peachery, and if for Vines a vinery; so for a miscellaneous collection of fruit trees it might be called a fruitery. An orchard is a collection of standard fruit trees cultivated without artificial heat; and an orchard-house, if the term be correctly applied, means a house containing a similar collection similarly unheated.—Eds.]

DOES SULPHUR KILL RED SPIDER?

In walking through fields where sheep are constantly kept, I have often been struck with the remarkably narrow track these animals make in following each other. It certainly is a strange propensity sheep have to keep one beaten track, and we are all apt to wonder how quadrupeds manage to make one so narrow. But in this respect are not most writers a good deal like sheep? Are not statements made and remade by us all one after another—things taken for granted and reasserted time after time, and acted on too without due proof of their truth? As an instance, who that has written on any horticultural subject has not recommended sulphur in some form as a remedy for red spider? I know I have, and yet what positive proof can any one adduce that sulphur, except when burnt, will kill this troublesome insect? No one doubts red spider, and plants also, can be killed by the fumes of burning sulphur; but what proof, I ask, have we that red spider can be killed by sulphur painted on pipes, flues, &c., or even applied as a wash to the leaves of plants?

My own opinion, after a number of careful experiments, is that it is perfectly useless. Where sulphur has appeared to do good it has been used in conjunction with clay, lime,

soft soap, soot, &c., in which case the insects have been as effectually disposed of as a recusant nun carefully bricked-up in a wall. But, I repeat, sulphur alone or mixed with water has never with me answered the end of killing red spider; nor do I believe it will, unless the plants are killed at the same time. I have often seen it carefully applied as a preventive in houses where the luxuriant foliage of the Vines, &c., appeared to be entirely free from this pest; but am inclined to think the healthy state of the plants had more to do with their freedom from spider than the so-called remedy.

My object in writing is to ask if any of your readers can give instances where red spider, after it has made its appearance, has been killed by the use of sulphur?—P.

THE ROYAL HORTICULTURAL SOCIETY'S SCHEDULE.

WHEN I brought my plaint against the Society I was quite confident, not only that I had understated the case, but that I had merely scratched the surface, and that there was ample cause for fault-finding besides the instances I adduced. This is abundantly testified to by Mr. Bull's letter, which opens out quite a field of complaints; and as there are few persons to whom we are more indebted for zeal and enterprise in endeavouring to introduce novelties amongst us, his words are well deserving of notice.

There can be no question that one of the great charms of horticulture is novelty: hence to have anything new is one of the great desires of every possessor of a garden or greenhouse. To cater to this taste is Mr. Bull's especial object; and any one who has witnessed the large amount of new things that he has introduced in one season, and then to be told that he received as an encouragement £5 6s., will at once see what a "lame and impotent conclusion" this is from such premises, and, as he justly says, this needs some revision. It is all very well for the Council to endeavour to shift all their failures and to lay all their jobs on the shoulders of H.R.H. the late Prince Consort; but no one would have more readily seen and acted on the knowledge than he would have done, that the main primary object of the Society is the encouragement of horticulture, and that, if the other objects he had in view were not to be accomplished except by sacrificing that, he would at once have given way. If, then, a society sends out a collector to procure novelties, and that to a part of the world where few are to be had, and is so ignorant as to send him to look for Orchids in a forest, which forest he finds has been all cleared, surely it ought to encourage those who endeavour to do, and do effect, what it fails in. I do not think that a sum of £150 or £200 a-year would be too much for a society like a nation's Horticultural Society to appropriate to this object. "Oh, what a large sum!" Yes, but I see that the Council have appropriated £500 for a piece of sculpture (of course H.R.H. is brought in to sanction this); and will any one tell me that this is what can be called the encouragement of horticulture? Moreover, there is to be a bowling-green and croquet ground! (why not add "a dry skittle ground?") and so ducks and drakes, as the common expression is, are made of the Fellows' money.

Imagine a distinguished foreigner, interested in horticulture, entering the gardens for the purpose of seeing what that which ought to be the foremost Society in the world is doing for the encouragement of his favourite science. His first view is not encouraging. The Cedars and Conifers generally won't grow; and as he looks round he sees the garden enclosed by a series of dirty brick galleries yclept arcades. He goes up the centre walk, and on one side he sees a number of young ladies playing at the exciting game of croquet. He is, perhaps, a Frenchman and a theoriser: he notes this, and concludes it has some mysterious connection with his favourite pursuit which he must think out. On the other side elderly gentlemen, puffing and blowing, are hurling balls along the ground at no small exertion to themselves in the heat of a July day, while strains of martial music, to encourage them as he supposes, float along the air. He will, however, look at the parterres. His eye first catches a great label, "This parterre arranged by Mr. —, of the Hooker Nursery: plants to be had at reasonable

prices." "Ah! it is, then, what you call a joint stock concern, I suppose." It would be difficult, I think, to explain to him the real position of affairs. Mr. Nesfield's floorcloth gravel patterns then attract his attention; and he not un-naturally concludes that there is such a difficulty in growing plants in this miserable island, that we are obliged to have recourse to stones and slates to make up for their deficiency; and then he rejoices to think that they "don't do things so in France." He enters the conservatory. Here he expects to find some of the noblest specimens to be seen of greenhouse plants of rarity and beauty; but in this he is disappointed. Flunkeyism prevails here too, and to fill it with plants given by this or that person, and of little or no merit, appears to be the object; while all is in confusion. Stages are being put up for a great flower show which is to be held to-morrow, and carpenters and joiners usurp the gardener's place. He gives up the pursuit; and as he lights his cigar and walks out he mutters to himself, "Strange people these English! They have their fifteen or sixteen thousand a-year to spend in encouraging gardening, and these are their examples of excellence!" shrugs his shoulders and exit.—ARGUS.

ROYAL HORTICULTURAL SOCIETY.

REPORT OF THE COUNCIL TO THE GENERAL MEETING, FEBRUARY 9TH, 1864.

(Postponed until to-day for reconsideration.)

1. AFTER two years of inactivity with the works in the Gardens at South Kensington, occasioned by circumstances over which the Society has had no control, the Council are happy in being able to announce to the Fellows that they have new reason to hope that Her Majesty's Commissioners for the Exhibition of 1851, are about to take important steps towards the completion of those works, and also to lend the Council their assistance in carrying out some operations not strictly falling within the landlord's province, which the Council think of importance, but which they could scarcely have undertaken without assistance.

2. The experience which has been acquired since the opening of the Gardens has given rise to various suggestions for the improvement of the original designs, and the Commissioners and the Council have devoted much time to their consideration. Some of these have appeared to them worthy of adoption, and the Council cannot better explain their nature than by laying before the Fellows the letter which they addressed to the Commissioners on the subject on the 15th Dec.

LETTER FROM THE COUNCIL TO THE COMMISSIONERS FOR THE EXHIBITION OF 1851.

"To Edgar A. Bowring, Esq., C.B. (Secretary to H.M. Commissioners for the Exhibition of 1851).

"Royal Horticultural Society, South Kensington
15th December, 1863.

"SIR,—I am directed by the Council of the Royal Horticultural Society to inform you, that they have had under their anxious consideration the present state and prospects of the Society's Gardens at South Kensington, especially in connection with those works which are under the control of Her Majesty's Commissioners, and that they have arrived at certain conclusions, which they request you to have the kindness to submit to the Commissioners.

"1. Since the foundation of the gardens by H.R.H. the Prince Consort and the Commissioners, many unforeseen circumstances have happened, affecting the fortunes of the gardens, which neither Her Majesty's Commissioners nor the Horticultural Society could have controlled. It is not necessary to enter into an examination of these circumstances, further than to point out that they have kept in abeyance the realisation of the plans upon which the gardens were projected, and upon the completion of which their success depended, and still depends.

"2. Whilst the Council are sensible that it may be difficult for the Commissioners to afford the Council any precise information of their future intentions in completing the original design, particularly as respects the buildings forming the central arcades, they cannot hesitate to express to the Commissioners their conviction that the present state of those arcades has an injurious effect upon the success of the

gardens and the Society. The imperfect decoration of the north arcades, in like manner, gives an air of poverty and hesitation which is injurious. Moreover, the ground at the east and west sides of the central arcades is a waste, which, in any case, requires to be put in decent order; and, certainly, the operation of removing the Great Exhibition buildings, so as to enable the Commissioners to dispose of their land to the Government—an operation which is likely to last during the present season—is not calculated to benefit the gardens.

“3. The Council conceive that a considerable amelioration of these depressing circumstances is possible, and they submit that it is the duty and interest both of the Commissioners and the Society to promote it. They feel confident that the Commissioners will be prepared to discuss the subject in an enlightened public spirit, and with the desire of promoting the eventual accomplishment of the original design in laying out the ground and devoting it to public uses.

“4. The Council have applied themselves to the consideration of what it would be best to do at the present time, to assure as well the Fellows of the Horticultural Society as the general public, that the gardens and arcades are not under a state of permanent paralysis.

“5. The Council propose themselves immediately to commence operations in the gardens, for the purpose of obtaining greater shade; also, of providing exhibition space under cover, and generally of adding to the decoration of the gardens, and making them more attractive.

“6. The Council estimate that the cost of these operations will be between £2000 and £3000, which they propose shall be borne by the Society.

“7. But there are other most important works, the expense of which the Council feel would be beyond the means of the Society, and they seem to be works in which Her Majesty's Commissioners have equal, or even greater, interest than the Society. The Council strongly recommend that these works should be put in hand immediately, so as to be completed before the 1st of May. They are as follows:—

“a. The *North Arcades* should be glazed and plastered, and certain carvings and decorations proceeded with. The Conservatory should be strengthened and improved, and lighted, so that it and the adjoining Arcades may be used for flower shows, &c. These would be permanent works, and would require the chief outlay.

“b. The *Middle Arcades* should be put into a suitable state of repair, likely to last for three years, and openings should be made between them and the adjacent waste ground. Planting should be done, so as to make the whole an attractive covered way.

“c. The adjacent waste plots of ground should be planted and grassed, and the palings raised. I am directed to observe, that the decorative completion of the *North Arcades* appears to the Council from a moral, if not a legal, point of view, to be imperative on the Commissioners at some period, at a very large cost, whilst the works in sections *b* and *c* may be considered really in the light of obligations on the part of the landlord, which for the general value of the property and its appearance, it is the landlord's interest especially to execute.

“d. The Entrances and the *South Arcades* should be made more attractive, and be sufficiently protected against the weather.

“8. The Council estimate that these works, exclusive of those in 5, could be properly executed for the sum of £13,000, and they will undertake that they will ask for no further sum on behalf of them.

“9. The Council are satisfied that this expenditure would infuse new life into the gardens, and give confidence to the public that the Commissioners' plan had not been abandoned. The Council submit that the experience of the next three years would be most valuable both to the Commissioners and the Society, in determining how far the comprehensive plans, as originally designed, should be prosecuted, modified, or given up.

“Should the Commissioners be prepared to sanction the outlay of the sum proposed, and advance the money, the Council would be happy that its expenditure should be carried on under the superintendence of the Expenses Committee, which represents the interests both of the Commis-

sioners and the Society.—I have, &c., (Signed) ANDREW MURRAY, Assistant Secretary.”

3. The Council attach considerable importance to the temporary loan to the Society of the ground on which the two annexes of the Great Exhibition stood. It will not only add to the pleasure-ground of the Society, and give additional room for the recreation of the Fellows at a trifling cost of maintenance, but will enable the middle arcades to be opened at intervals, and thus tend to lighten and enliven them. Perhaps it may be possible to arrange for the erection of one or more glass houses in which a portion of the horticultural operations of the Society may be carried on, and an opportunity afforded to the Fellows and the public to see them without going so far as Chiswick.

4. The chief alterations which the Council propose to make upon the gardens are increased planting for shade and a greater quantity of grass. They propose to plant and decorate with flower-beds the walks in the ante-garden, &c.

5. Some of the Fellows have proposed to establish independent clubs for croquet and bowls, and the Council readily lend themselves to the proposition, in the expectation of thereby increasing the enjoyments of the Fellows and the attractions of the gardens.

6. It has also appeared to the Council that increased interest would be given to the gardens if portions of them were set apart as exhibition grounds of bedding plants, flowers, and shrubs, &c., let out to responsible nurserymen and florists of eminence. They accordingly have invited tenders for filling such spaces during the year 1864. The selection and arrangement are proposed to be left entirely to the taste of the exhibitors, provided that the same be in keeping with the general character of the gardens. The beds so planted would be kept in order by the parties planting them throughout the season; and the names and addresses of the nurserymen and florists placed upon the beds so filled by them.

7. The object which the Council have had in view in recommending the Commissioners to be at the expense of glazing the upper arcades and lighting the conservatory has been chiefly to provide a place in which the Society might hold evening meetings. The want of such a place has been felt, and various plans have from time to time been proposed for supplying it. They expect that the work will now be undertaken without delay, and the Council look forward with pleasure to being able to hold occasional evening *réunions* in the conservatory during the present season.

8. They trust also, by this means, to be able to have their great Shows open on the evening of the first day of the Show.

9. On no point has the experience of the last three years been more instructive than on the question of the admission of the public to the gardens. On this point the two extremes have been tried, and neither of them found to answer. In 1862, the public were admitted with as great freedom as was well nigh possible. For the greatest part of the week, during the continuance of the Great Exhibition, the price of admission could scarcely be said to be more than 6d. a-head; and the Fellows, recognising the exceptional nature of the year, good-naturedly submitted for the time to this practical abrogation of exclusive privileges.

In the following year the Council went to the other extreme, and excluded the public altogether. The new rules were not long in operation before the Council felt that they would not answer. But, although strongly pressed to relax them, the Council adhered to the programme which they had announced, and maintained the exclusive character of the privileges to the end of the year. The experience which they have thus acquired, however, has thoroughly convinced them that the right policy lies between these extremes—namely, in admitting the public at an easy rate on certain days, and virtually excluding them on others. This was the policy originally laid down by H.R.H. the Prince Consort, as President of the Society. It was the footing on which Her Majesty's Commissioners entered into their agreement with the Society. This also is the policy which has been found most successful by a Society in a very similar position to that of the Horticultural Society—viz., the Zoological Society, and it is the policy which the Council now recommend for the adoption of the Fellows.

10. The Council feel confident that it is quite possible to

one group of the whole is concerned, we do not see how you could do better. No doubt the broad grass walks or avenues give repose; but we question much if the garden would not have been more telling if divided into three portions—a centre and two wings, with double widths of grass between the centre and wings, even although there should have been fewer clumps in the wings. The centre clump is also rather large for the rest, but you have neutralised that difficulty by your mode of planting, so that there is no one overpowering colour in the centre. We think your group would be improved by a raised centre in 12 and 13 as stand-points for the eye as well as in 1. Your system of planting is what is called cross-balancing, and we do not see well how you could improve it, unless, perhaps, in richer materials. It will also enable you to crop your beds in rotation. We question if you will beat it by any other plan; but we have no doubt that, having four of a sort, as 2, 3, 4, 5, if well contrasted with 1 and the figures outside, would also look remarkably well. The system of edging does away with sameness, and simplicity of arrangement is often more pleasing to the eye than mere intricacy. More depends on the getting-up of the beds in these matters than mere pairing or quadrupling of beds. For instance: in a group very much like one of your wings, we have had the outside of the centre, as 12, white; and we have had the eight figures round, in four crossed pairs, of scarlet, blue, orange yellow, and purple. Then another season we have had four scarlets and four yellows, with their suitable edgings. Last season we had four pairs of Geraniums with suitable edgings, as Rubens, Stella, Christine, Boule de Feu; and then of the eight beds outside, four were purple and four yellow, with edgings, and we could not say honestly what arrangement was the best. We shall be glad to know how you decide, and how you are satisfied.

We may just add that all arrangements that are not bold enough to be seen from the window or the gravel walk are hardly worth the labour bestowed upon them, and the same may be said of all mere shades of colour. Your Scarlet Geraniums we would advise to be planted shallow, and in moist seasons disleafed freely.]

AN INSTANCE OF ARNOTT'S STOVE BEING INEFFICIENT.

In answer to Mr. Fish, page 97, I beg to say that my orchard-house is divided down the centre into two raised beds, each supported by a brick wall 18 inches high. The Arnot's stove stands in the centre, the face of the stove being flush with the brickwork of the wall on one side. The flue enters immediately into a brick chimney, which is carried out about a foot higher than the ridge of the house. There is a damper in this chimney.

On Tuesday night, with the thermometer out of doors at 14°, there was ice on the surface of the water in a can not above 6 feet from the stove, though a good fire had been kept constantly burning for a week. The walls of the house are of wood; ventilators (closed) run longitudinally along each side of the house; above them runs a strip of glass 1 foot wide.—A. R.

[I am much obliged for the information conveyed in the note of "A. R." I cannot conceive what causes the difference in results except the reasons already alluded to, such as the house being span-roofed, and the boarded sides rather open. Perhaps the laps of glass are also rather open, and the heat may pass too easily up the chimney. I saw some of these stoves doing their work well at Mr. Rivers's, but the houses were lean-to's. As already stated, the few plants that suffered with me were near the boarded front, which was rather open between the joints, but which I mean to remedy. The rest are standing now in good condition in a cold vinery. I removed them there after the first severe frost was over, as I wished to keep the orchard-house cool. No doubt our stove being iron would tell more quickly; but then the heat from bricks is more lasting and genial. I presume "A. R." has a block opposite the smoke-flue to prevent the heated air getting into it too easily. Two plates of iron would be good for the purpose, and the smoke-pipe should go horizontally for a foot or two before rising up-

right. I am very sorry that I cannot explain how "A. R." does not obtain more heat; but much will depend on concentrating the heat about the stove. If I understand him aright, the chimney of "A. R." is inside the house, whilst all ours, with the exception of the horizontal pipe, is outside the house. In that respect he has the advantage, whilst I have the greater one of a thick back wall. It is well that all these different results should be carefully noted.

A gentleman lately told me that with an alteration advised he obtained more heat from one hundredweight of fuel than he used to have from half a ton. The fuel, previously, acted almost entirely on the farther end of the boiler, and then the heat rushed up the chimney, whilst from a doorless ash-pit enough of light came in a dark night to permit of reading the smallest print. The fireplace was altered, a damper placed in the chimney, a close door procured for the ash-pit, and then the beneficial results followed. I consider "A. R." to be too experienced to be benefited by any little changes; but his example is none the less valuable.—F.]

PORTRAITS OF PLANTS, FLOWERS, AND FRUITS.

FORRESTIA HISPIDA (Hairy-sheathed Forrestia).—*Nat. ord.*, Commelinaceæ. *Linn.*, Hexandria Monogynia. Native of Malay Archipelago, and North-eastern India. Beautiful from the purple colour which pervades the whole plant.—(*Botanical Magazine*, t. 5425.)

IPOMÆA FILICULIS (Slender-stalked Ipomœa).—*Nat. ord.*, Convolvulacæ. *Linn.*, Pentandria Monogynia. Native of "Asia, Australia, Africa, and even the warmer parts of the New World." An annual; flowers cream-coloured, with purple eye.—(*Ibid.*, t. 5426.)

GLADIOLUS SERICEO-VILLOSOUS (Shaggy-stemmed Cornflag).—*Nat. ord.*, Iridacæ. *Linn.*, Triandria Monogynia. Native of the interior of the Cape of Good Hope. Three to four feet high; flowers greenish yellow in a very long, densely-flowered spike.—(*Ibid.*, t. 5427.)

TRICHANTHA MINOR (Smaller-leaved Trichantha).—*Nat. ord.*, Gesneracæ. *Linn.*, Didynamia Angiospermia. Native of Tropical America. Flowered in November by Messrs. Veitch. "No Gesneraceous plant, perhaps, exceeds this in elegance of form, and beauty of colours." It is a stove climber. Flowers purple, yellow, and crimson.—(*Ibid.*, t. 5428.)

CANSCORA PARISHII (Parish's Canscora).—*Nat. ord.*, Gentianacæ. *Linn.*, Tetrandria Monogynia. Native of Moulmein. Leaves orbiculate-perfoliate; flowers white. An annual.—(*Ibid.*, t. 5429.)

DENDROBIUM CILIATUM (Fringed-lipped Dendrobium).—*Nat. ord.*, Orchidacæ. *Linn.*, Gynandria Monandria. Native of Moulmein. Sepals green, petals yellow, lip marked with purple lines.—(*Ibid.*, t. 5430.)

CHRYSTHEMUMUS.—*Lord Clyde*, crimson, rosette form; *Saint Margaret*, orange, anemone-shaped.—(*Floral Magazine*, pl. 181.)

ERANTHEMUM TUERCULATUM.—Native of New Caledonia. Exhibited by Messrs. Veitch, and obtained a certificate from the Floral Committee. Flowers white.—(*Ibid.*, pl. 182.)

SCHIZOSTYLIS COCCINEA.—Native of South Africa. Previously portrayed in the "*Botanical Magazine*."—(*Ibid.*, t. 183.)

GLADIOLUS.—*Randle Jackson*. Raised by Mr. Standish. Peach-blossom coloured, with dark crimson stripes.—(*Ibid.*, pl. 184.)

MAGNOLIA LENNÉ.—Believed to be of German origin, but introduced by Mr. W. Paul from France. It is one of the deciduous kinds. Flowers large, purple outside, inside creamy white, and fragrant.—(*Florist and Pomologist*, ii., 25.)

ENTOMOLOGICAL SOCIETY'S MEETING.

The Anniversary Meeting of the Entomological Society was held on the 25th of January, F. Smith, Esq., President, in the chair. Certain proposed alterations in the byelaws, chiefly with reference to the Publication, Cabinet, and Library Committees, and the duties of the Curator, were adopted; but the proposed repeal of the byelaw excluding residents in the United Kingdom from honorary membership

in the Society was rejected. The usual routine business of the anniversary meeting then took place, and the President delivered an address. The following gentlemen were elected officers for the ensuing year:—Mr. Stainton, President; Mr. S. Stevens, Treasurer; Messrs. Edwin Shepherd and Dunning, Secretaries; and Mr. Ianson, Librarian.

At the general meeting of the Society, held on the 1st of February, the Secretary stated that Mr. Stainton having declined to accept the Presidentship of the Society, a special meeting would be held on the 7th of March for the election of a President, and that Mr. F. Pascoe had been recommended by the Council to fill that office in the stead of Mr. Stainton. Donations to the library were announced from the Royal Society, the Royal Society of Munich, the Entomological Society of the Netherlands, and the Society of Arts. The continuation of the beautiful work on the Genera of European Coleoptera, by M. Jacquelin du Val, purchased by the Society, was also on the table.

The Rev. Hamlet Clark exhibited a photograph of the late Rev. F. W. Hope; and Professor Westwood stated that Mrs. Hope had presented a beautiful oil portrait of her late husband to the University of Oxford, to be placed in the Hope Museum.

Mr. Clark also exhibited a very interesting collection of the Plant-feeding Beetles of Australia, belonging to Mr. Wilson, of Adelaide; and also those collected by Mr. F. Waterhouse during his overland journey across New Holland.

Mr. S. Stevens exhibited some very clever imitations of gaily coloured Butterflies, intended for the decoration of ladies' head-dresses.

Mr. G. R. Waterhouse exhibited two closely-allied species of Psammodyus, and three of Onthophilus (minute genera of Dung Beetles), and described their destructive character.

The Secretary exhibited some specimens of wood which had formed portions of the head of a coffee-cask from Ceylon, and which had been completely destroyed by the larvæ of some species of Coleopterous insect, most probably belonging to the genus Anobium.

Professor Westwood exhibited a specimen of beautiful wild silk, pure white in colour, and very soft to the touch, which he had received from Mr. Daniel Hanbury, being the product of a colony of caterpillars, in St. Salvador, in Central America, which were said to feed upon a wild species of Oak. As the silk had been deposited in flat layers by the insects working in company, it would be impossible to unwind it in the usual manner, and would, consequently, require carding for economic purposes, supposing that a sufficient supply could be obtained from the trees, or from the insects if brought into a state of domestication. The Professor also exhibited and described two very curious new genera of Carabideous Beetles from the Hope Museum, at Oxford, as well as a fine new species of Moluri, to which he applied the name of M. Rowleiana, in compliment to the Rev. Henry Rowley, one of the clergymen attached to the Oxford and Cambridge Mission to Central Africa, by whom it had been taken at the Zambesi.

Mr. F. Smith exhibited a curious collection of nests of *Vespa vulgaris* and *V. rufa* in different stages of formation, the whole having been artificially obtained by Mr. Samuel Stone, by making holes in banks, which the wasps subsequently adopted for their abodes.

Mr. T. W. Wood exhibited a block of Honduras mahogany, enclosing a number of cells of a very light and brittle texture, apparently made of triturated and agglutinated wood and earth, and somewhat resembling the honey-pots of the humble bee, but larger in size.

Mr. Bates suggested that they might be the cells of some species of Termites, although apparently too large. No other satisfactory suggestion was offered as to their origin.

Major F. Parry read a paper entitled, "Further Remarks on Mr. Thomson's Catalogue of Lucanidae."

General Sir J. B. Hearsey exhibited a case of Indian and Chinese Coleoptera, some of the species being of great rarity.

WORK FOR THE WEEK.

KITCHEN GARDEN.

THE operations recommended here periodically cannot, perhaps, always be performed with propriety at the precise

period indicated; the position of the garden as well as the nature of the soil must be considered, and if these circumstances are unfavourable, they may be permitted, as exceptions, to modify our general rules. However, the preparation of the various quarters designed for main crops must be persevered in whenever the soil is dry enough to admit of being trodden on without being too much consolidated. This is of great importance on heavy stiff soils, and those who have such to deal with should take advantage of every dry day that occurs. On such soils it will be advisable to defer sowing main crops for a week, and even a fortnight. But on light dry soils the sooner the main crops are got in the better, because such soils are most liable to suffer from drought should it occur, and, therefore, the sooner the crops are well established, the better will they be able to resist its injurious effects. If, on the contrary, the season should be wet, they will still be in the best possible condition to profit by it. *Asparagus*, make new beds with two-year-old plants, and fill up old ones. *Beans* (*Broad*), plant out Mazagan from boxes and pots, and sow Longpods for the main crop, regulating the quantity by the demand. *Broccoli*, make a small sowing of Grange's True Early White, which will come in useful by-and-by. *Cabbages*, sow another batch of an early sort, and also of the true Drumhead Savoy, and of Red Cabbage. *Cauliflowers*, prick out the young seedling plants of these, and also of Lettuces, either on a warm border or a gentle hotbed, and shelter them for a time with hoops and mats. *Celery*, the first sowing to be pricked out as soon as it can be well handled, and another sowing made of both red and white. *Onions*, sow the principal crop. The best are the Deptford, Old Brown Globe, James's Keeping, White and Brown Spanish; to be sown in beds 4 feet wide, and in drills 9 inches apart, and if you can procure it, sow some charred refuse along the drills previous to covering-in. When the beds are raked smoothly over, and the surface is a little dry, pass a wooden roller over them, or tread the ground firmly, as consolidation of the soil is especially favourable for their healthy vegetation and growth. *Potatoes*, plant early sorts in a warm situation. For earlier crops a few may be first planted in boxes in heat, and transplanted to the open ground when they have vegetated, afterwards let them be protected from frost. Those growing in frames to have air given to them freely.

FLOWER GARDEN.

Continue the pruning and nailing of climbers; also, the arranging and tying of such as are against trellises and verandahs. The protection afforded during winter to tender shrubs may now be removed, only have it in readiness in case of a recurrence of severe weather. Proceed with the planting of hardy Roses. If the plants are strong the knife must be used with caution; if weak, cut them back to two or three eyes. Shorten all long and straggling roots, and prune away such as may be bruised or broken. If the ground has not been prepared as previously directed, we would recommend pits to be made, and to two pits give a wheelbarrowful of rotten dung and good loam well mixed. By all means avoid deep planting. Have a quantity of stakes and tarred twine close at hand, and stake each plant whether it be a dwarf or standard. Many losses are incurred and much injury sustained when this is neglected. If any of the Polyanthuses in beds have been raised by the late frosts, they should be fastened and a top-dressing of vegetable mould given. Any vacancies in the Pink-beds should be filled up, and new sorts required brought in, though it is the best plan to procure them in the autumn. The beds of Tulips, the beautiful favourites of the amateur, will now require very great attention, the foliage being generally well up above the surface, and, consequently, exposed to the vicissitudes of our changeable springs. At this season a rainy day is often succeeded by a sharp frost, or hailstorms mercilessly pelt the rising plants. Some think it of but little use to cover, supposing the Tulips to be sufficiently hardy; but when the leaves form a kind of cup, which holds a considerable quantity of water, and this on a frosty night is turned into a mass of ice enveloping the rising bud, we think it will be allowed that protection in this case, at least, is advisable.

FRUIT GARDEN.

Pruning should now be quite finished in every department.

increase the privileges of the Fellows in the use of the gardens, and at the same time, through the assistance of the general public, to make them much more remunerative than heretofore, and therefore auxiliary in promoting the scientific objects of the Society.

11. As respects increased privileges of the Fellows, the Council recommend that the evening meetings shall be confined to the Society itself and to other learned societies.

12. They propose that the Fellows shall have the new privilege of purchasing (previous to the day), any number of tickets of admission to each great show at half-price—that is, 2s. 6d. instead of 5s.

13. They propose that at each of the minor shows the Fellows shall have the privilege of purchasing tickets at the door for their friends at 1s. instead of 2s. 6d. each (which last price will continue to be charged to the general public).

14. They propose not only that the Fellows shall have the privilege of visiting the shows at an earlier hour than the general public, but also that they may bring their friends (who have tickets) at an earlier hour, although not so early as the Fellows' hour.

15. They recommend that each Fellow shall have the privilege of admitting two friends, personally or by written order, on Sundays; also on Mondays and Saturdays, on which two days the public will be admitted on payment of 1s. each person; on Tuesdays, Wednesdays, Thursdays, and Fridays, that Fellows shall only be allowed to introduce their friends personally as heretofore, and the public to be admitted by payment of 5s. each person. The privilege of introducing friends personally or by order will not extend to show-days.

16. Another point which has occupied much of the attention of the Council is the publication of the "Proceedings" of the Society. Several Fellows have recommended their more frequent publication. The only objection is the increased expense of delivery. It will be in the recollection of the Fellows that last year, in order to reduce the expense of the "Proceedings," the Council dropped the publication during the four months of the year when most of the Fellows were out of town. A considerable saving was thus effected; and a further saving will this year be effected by the new form of printing in double columns and smaller type, which has been adopted in the month of January. It is not the expense of printing, however, which would deter the Council from complying with the wishes of those Fellows who desire a more frequent publication; it is the expense of delivery which is the most serious obstacle; that is so great as to form an absolute barrier to the proposition, unless it be borne by the individual members themselves. This is done in some other societies. Those Fellows who are willing to pay the postage or expense of delivery receive the publications at once. To those who do not choose to incur that expense they are sent by parcel and at intervals when they have accumulated sufficiently. The Council recommend that in future this plan be adopted, and the "Proceedings" published once a fortnight, if possible.

17. Whilst the Council have thus had much of their attention directed to supporting the material prosperity of the Society, and promoting the general comfort and enjoyment of the Fellows, they have steadily kept in view the primary object for which the Society exists—viz., the advancement of Horticulture.

The operations of the Fruit and Floral Committees have gone on effectively, and the reports of their meetings have been published in the Society's "Proceedings." The results of the experiments at Chiswick during the past year will appear in them without delay. By means of these experiments the most important garden flowers and fruits are by degrees being reported on, and inferior sorts are eliminated from the lists; the Fellows and the public have thus a trustworthy report of the best kinds of each. Experiments have also been made in regard to improvements in heating, and on other horticultural matters, of which, when desirable, account will be given in the "Proceedings."

18. The collector, Mr. Weir, was last year recalled from South Brazil, that district having been sufficiently explored, and not found very productive; he is now collecting in New Grenada, and already six boxes, collected in the neighbourhood of Mompos, have been received in excellent condition. These will form the subject of ballot during the following

season; and as the access to New Grenada is easy, it is expected that materials for several ballots will be received.

19. The seeds and plants which he sent home from South Brazil were raised and propagated, and have been distributed by ballot last year among the Fellows; 5059 plants have been so distributed, and a few still remain for ballot during this season.

The total distribution of plants, seeds, &c., during the year has been—8300 plants; 78,065 packets of seeds; 2000 bundles of grafts of fruit trees.

The value of the privilege of obtaining fruit from the Chiswick Garden at wholesale price seems to be every year better known and appreciated. The Fellows have availed themselves of it during the past year to a greater extent than they have ever done hitherto. The Garden at Chiswick has, by means of its sales, contributed considerably towards its expense.

20. The Accounts and Balance sheet of last year have been already published. The different items of expenditure are suggestive of various alterations in the mode of management of the subjects to which they relate. The Council feel that even after three years they are still at the commencement of a large experiment, and they recognise the necessity of making alterations as experience suggests, or necessity demands them.

The efforts of the Council have been chiefly directed to the reduction of expenditure, and this they will continue to keep steadily in view.

The number of Fellows has been increased during the past year by 23. There have been elected 245. But the Society has to lament the loss of 86 by death.

The following is a comparative view of the number of Fellows belonging to the Society at the respective dates noted:—

Fellows on books at anniversary.	1 Guinea.	2 Guinea.	3 Guinea.	4 Guinea.	20 Guinea.	40 Guinea.	Total.
May, 1858	978
" 1859	985
" 1860	1416
" 1861	1752
Jan., 1862 ...	10	722	25	1130	331	555	2776
" 1863 ...	10	918	25	1387	386	587	3313
" 1864 ...	7	945	23	1372	406	583	3336

21. In conclusion, the Council repeat that they look forward with confidence to the increased usefulness of the Society. The progress of Horticulture on the Continent, and the more frequent intercourse resulting from the extension of railways, are silently changing the position of this Society. Numerous Horticultural Societies are now established all over the Continent, and if the Society wishes to maintain its position as the leading exponent of Horticulture in the world, and not to sink into the status of a mere provincial Society, it must not ignore the steps taken and the progress made by Continental Societies. The Council have, therefore, paid considerable attention to enlarging the circle of the Societies with which they are in friendly relation, and drawing closer the bonds of sympathy and friendship by which they are united. They are already in communication with twenty-seven foreign and colonial Societies, with which they exchange publications and mutual good offices; and the Council look upon the strengthening of these bonds of union as no unimportant part of their duty, and no small means towards the advancement of Horticulture.

FAILURE OF SOME OLD FRIENDS.

MR. ROBSON'S paper at page 75 seems to me suggestive of deep research and comparison amongst each other by gardeners. He says that latterly the *Calceolaria* has ceased to be depended upon as a good and certain bedding plant, on account of its dying off at various times; and adds—"Some years before the *Petunia* retired from active service the *Anagallis* had done so in a like manner," and "neither is regarded as the good useful bedder it was held to be some twenty years ago."

I think we may add to these instances the *Lobelia speciosa*, which has run out latterly in this country, and become very difficult to manage. I have taken the greatest pains with

it. Many years ago it used to come true from seed, and nothing could be more beautiful. Seed in a few years gave a very mixed result. I then obtained the truest specimens I could procure both in England and Ireland; but found it impossible to get a border that did not run to grass like *L. gracilis*. The new varieties of *Paxtoniana*, and I might say, or *Gordoniana*, had all the bushy dwarf character last year that the *speciosa* had formerly. Some trees, such as rare Pines, when propagated from cuttings seem never quite to lose the habit of a branch. Can it be that the constant propagation from cuttings has produced a branching habit in the *Lobelia*? We cannot afford to lose our best blue bedder; and I mean to try the effect this year of cramping the roots either in pots or in a shallow border. Mixing with Golden Chain or other ornamental-foliaged plants which require rich food seems inadmissible, which is a pity, with respect to our best yellow bedder the *Calceolaria*.

I suspect that the deep trenching and under-manuring which saves late Peas from mildew, might keep the *Calceo-*

laria longer in blossom; and planting thickly enough to be able to prune, so as to keep up a succession of shoots, ought to enable one to avoid the failure of blossom in September. As to the *Petunia*, of which I deplore the loss as much as Mr. Robson, and have long abandoned the use, is there no remedy?

If the new rose-coloured *Geraniums* enable us to find a substitute for the lovely beds of Shrubland Rose *Petunia* that we used to have (which I much doubt), what dark purple have we at all like some of the old *Petunias*?

I think that although comments on the most effective combinations in the bedding-out gardens have been made through the last year's Numbers of this Journal, it would be a great boon to those who are now laying their plans for the coming season if you were to publish a *résumé*, not of the plans, but of the combinations of colours and plants which were reported upon by your best judges as having proved most effective last season.—CHARLES W. HAMILTON, *Hamwood*.

FLOWER-GARDEN PLANTING.

THE chief difficulty to contend with in planting my garden is to avoid the centre set of beds interfering with and overpowering the two end sets. I have generally made the two end sets of beds to correspond pretty closely one with the other, although not actually using the same flowers. For instance: Where I have used *Lobelia* in one set of beds I have put Purple King *Verbena* in the other; *Gazania* taking

the place of *Calceolaria*, Flower of the Day *Geranium* that of *Mangles'* or *Alma*, &c. One point concerning which I want to invite the opinion of your correspondents is, whether the beds ought to be planted in sets of four, thus: 2, 3, 4, 5; 8, 9, 10, 11; 14, 16, 18, 20; 15, 17, 19, 21; or in pairs of beds, as 2 and 4, 3 and 5, 14 and 18, 15 and 19, &c.

The beds last year were planted—

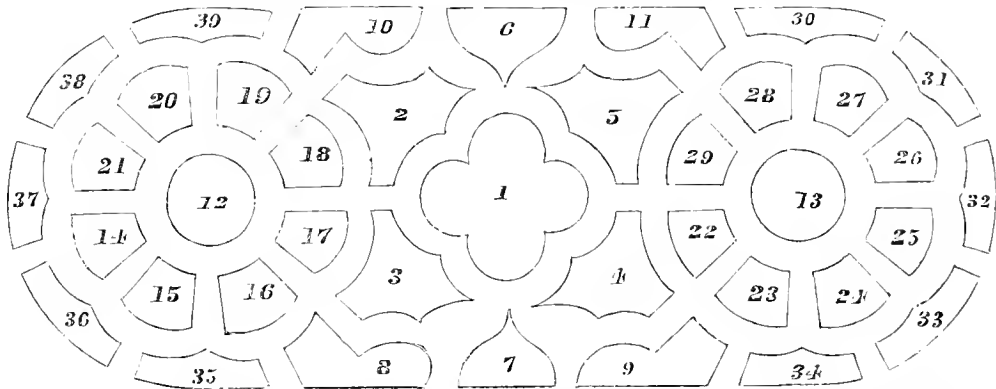

- | | | | |
|--|--|---|--|
| <p>1, Outside row, <i>Cerastium</i>.
2nd row, Purple King <i>Verbena</i>.
Points of the quatrefoil, Yellow <i>Calceolaria</i>.
Centre, <i>Fuchsia</i> standard.
1 row <i>Calceolaria</i> sparkler.
2 rows Flower of the Day <i>Geranium</i>.
1 ditto scarlet <i>Zinnia</i>.
2, 4, <i>Tropæolum</i> Crystal Palace; edge, Variegated <i>Arabis</i>.</p> | <p>3, 5, <i>Phlox Drummondii</i>; edge, <i>Geranium Mangles'</i> Variegated.
6, 7, <i>Geranium</i> Trentham Rose; edge <i>Lobelia speciosa</i>.
8, 11, <i>Verbena</i> Mrs. Holford; edge, <i>Lady V. Scott</i> and Miss Trotter.
9, 10, Mixed <i>Verbenas</i>.
12, 13, <i>Saponaria</i>.
14, 18—14, <i>Alma</i> and <i>Bijou</i>; 18, Mountain of Light.</p> | <p>15, 19, <i>Calceolaria angustifolia</i>.
16, 20, <i>Lobelia speciosa</i>.
17, 21—17, <i>Verbena</i> <i>Lady V. Scott</i>; 21, Firefly.
22, 26, <i>Geranium</i> Flower of the Day.
23, 27, Yellow <i>Calceolaria</i>.
24, 28, <i>Verbena</i> Purple King; edge, <i>Mangles'</i> Variegated <i>Geranium</i>.
25, 29, <i>Gazania</i>.</p> | <p>30, 34, 35, 39—<i>Petunias</i>. 30, <i>Lady Ellesmere</i>; 34, <i>Enterby</i>; 35, <i>Eliza Mathieu</i>; 39, <i>Madame Jacotot</i>.
31, 36, <i>Geranium</i> <i>Christine</i>; edge, <i>Sedum carnum</i> variegatum.
32, 37, <i>Calceolaria</i>.
33, <i>Crystal Palace</i> Scarlet <i>Geranium</i>; edge, <i>Sedum</i>.
38, <i>Geraniums</i> Punch and Little David; edge, <i>Sedum</i>.</p> |
|--|--|---|--|

I have made a plan for this year, but should like to have an expression of opinion upon the plan of last year, so as to be able to compare notes with my own. The centre bed No. 1 was planted with two rows round the edge, *Cerastium tomentosum* and Purple King *Verbena*; then, beginning from the centre, a tall *Fuchsia* tied up as a standard, a row of Sparkler *Calceolaria*, two rows of Flower of the Day, then a row of scarlet *Zinnia*, and the space left between the row of *Zinnia* and Purple King at the points of the quatrefoil filled with *Calceolaria canariensis*. All the walks are grass, of a uniform width, and easily mown by a twelve-inch hand lawn-mowing machine. Immediately round the set of beds is a broad grass walk about 9 feet wide. Then on the north side is a broad gravel walk next to the house, with a border of flowers between the walk and the house, generally planted as a ribbon-border with three rows of flowers. Last year it was *Lobelia speciosa*, Golden Chain, and the back row, mixed plants of *Calceolarias* and *Geraniums*. The centre of the garden faces the drawing-room window, and is due south from the house. On the other side of the grass walk is a

raised border sloping towards the house, the garden having been originally levelled out of a sloping field. This border is of a uniform width of about 11 feet, with a low trelliswork of larch covered with *Roses*; this border and trelliswork go round the east end of the garden as well. The other, the west end, is bounded by a gravel walk leading to a rockery and shrubbery. The broad border of flowers sloping towards the house is generally planted as a ribbon-border, but chiefly with annuals, such as *Sajonaria*, Carter's Tom Thumb *Nasturtium*, *Ageratum*, and *Petunias* (treated as annuals), *Asters*, *Stocks*, &c. I may state that the soil is a rich light loam, very suitable for *Verbenas* and *Calceolarias*, but *Geraniums* generally go too much to leaf; and consequently the Variegated class of *Geraniums* do better than Tom Thumb, Trentham Rose, &c., though the last is, as a rule, the best flowering *Geranium* of any in this soil.—X. Y. Z.

[We can easily fancy that the garden will look very well from the gravel walk, and better still from the drawing-room windows, as the colours will be reflected back from the sloping border and the fence of *Roses*. So far as making

and whatever nailing is left undone must be finished immediately. See that newly-planted trees are properly staked and mulched, and after high winds it is necessary to look round them and press the earth gently round the base of the stems.

STOVE.

Some of the plants which have been blooming for some weeks and which are exhausted, should be cut back and removed to a moderate heat for slow breaking, such as the *Euphorbia jacquiniæflora*, *Gesnera lateritia*, *Geissomeria longiflora*, *Eranthemum pulchellum*, *Justicias*, *Poinsettia pulcherrima*, and others; when breaking, which will be in about three weeks, they should be shaken out and repotted in fibry turfy loam, coarse sand, and a good portion of charcoal, in which last all these plants delight.

GREENHOUSE AND CONSERVATORY.

Stop any rank-growing shoots that are taking the lead on the *Camellias* that are done blooming. A general dressing of the climbers should take place immediately. Where it is desirable that they should bloom late in the autumn, it will be advisable to prune late, even after the buds have commenced growing, on the same principle that the Moss and other *Roses* are successfully retarded by such a course. Some of the forward *Cinerarias* and *Pelargoniums* may be shifted as requisite, as soon as the blooming habit is sufficiently brought on.

FORCING-PIT.

Continue to introduce plants of *Hydrangeas*, *Roses* in variety, *Pinks*, *Carnations*, *Rhododendrons*, *Kalmias*, *Ledums*, *Pelargoniums*, *Heliotropes*, *Azaleas*, &c. Shake out another batch of your best last year's young *Fuchsias*, *Erythrinums*, and *Salvia patens*, and place them in bottom heat. Sow *Balsams*, *Cockscombs*, *Amaranths*, &c.

PITS AND FRAMES.

Those who have not yet attended to the propagation of plants for bedding-out, must now begin with all possible speed to put in cuttings of *Salvias*, *Petunias*, *Fuchsias*, *Verbenas*, *Scarlet Geraniums*, *Lobelias*, &c., so as to have good plants for bedding-out in May. W. KEANE.

DOINGS OF THE LAST WEEK.

KITCHEN GARDEN.

As soon as the frost gave way, and the ground was dry, sowed *Dickson's Favourite Pea*, and *Mazagan* and other *Broad Beans* out of doors. Sowed also *Beans* and *Peas*, chiefly *Mazagan* and *Sangster's No. 1*, on turves, to be transplanted when well forwarded. The turves were cut in strips 4 inches wide and 2½ inches thick, and a groove 1 inch deep cut out in the centre. The turves were placed on a bed of leaves just a little warm, with 2 or 3 inches of rotten leaves between the leaves and the turves, into which the roots might run. We have employed leaves because we could not well use anything else at the time; but we would have preferred half-circular drain-tiles, with a piece of rotten dung stuck in the ends to keep in the soil, or even wooden boxes if we had them at liberty, as, when planted out, there would be nothing to interfere with the free growth of the plants. We have succeeded very well with turves, but in peculiar seasons the haulm of the *Peas* near the turf, if the latter is at all stiff in consistence, is apt to become hidebound; and though there will be a good show of *Peas* at first, the gathering is not likely to be so continuous as when the plants have nothing to check their luxuriant development. However managed, these transplanted *Peas* are likely to come sooner into bloom and pod, merely from the check given in transplanting. Such plants follow a natural law, by which the excess of luxuriance is ever opposed to the excess of fruitfulness. If the check given to mere growth is too great, then healthy continued fruitfulness is also lessened. Such *Peas* and *Beans*, therefore, require to be well hardened off before planting out, and to receive a little protection afterwards from evergreen boughs, &c. When that can be given them, *Peas* planted out in March from seeds sown from the middle of February will generally beat those sown in autumn, and the protection of them from slugs, birds, mice, and rats during the winter is avoided. When, with autumn-sown rows, we have had them very luxuriant about the

middle of March, we hastened their fruitfulness by inserting the spade obliquely as deep as it would go, so as to cut the roots on one side, and prevented flagging by running a little water along the rows.

Transplanted *Kidney Beans* and sowed more. The *Newington* is a good one for cooking whole, when the pods are some 3 inches in length. By transplanting at this season room is saved, and extra fruitfulness secured. After this it will be best to sow in beds or pots, and nip out the stem when it makes its first running leaf, which will make the plants more dwarf and continuously fruitful. In early winter we used to sow and plant rather thickly, and not stop; and thus we obtained an earlier produce, but not so much of it. Gave abundance of air on mild days to *Potatoes*, *Radishes*, *Asparagus*, *Lettuces*, &c., and planted more *Potatoes* under cover, and have a good many moving nicely now in pots, and which will require planting ere long. Those growing in large pots are doing very well. Some that were shut up in the cold weather became rather lanky, and had the terminal buds of the shoots nipped out, to prevent them growing too tall for the glass. Kept up successions of *Radishes*, *Sea-kale*, *Rhubarb*, and *Mushrooms*. For constant supply, we are still more convinced that the small-bed system for *Mushrooms* is the best. There are two matters about *Mushrooms* we would here allude to. The first is that some *artists* of the kitchen prefer having button *Mushrooms* under their own care—that is, prefer receiving a lot at a time and preserving them in their own way, and going to their store when they like. We suppose this would not do for everything; but if more generally adopted it might save many an annoyance; for, when they are required it is unpleasant not to be able to send in a good handful of buttons, when you could easily send a bushel of large *Mushrooms*. The other matter is very thick fleshy *Mushrooms*. We some time ago stated how, by a surfacing of cowdung, the *Mushrooms* came too thickfleshed to be easily cooked, and we rather think we are approaching the same condition again by another process, at least the man who has charge of the *Mushroom-beds* thinks that is the reason for the thickness as well as the extra fruitfulness. When putting on the soil, not too damp, he watered with a strong decoction of sheepdung that had been kept in a barrel, before squeezing and heating down the soil. Pulled a little earth to *Cabbage* plants. Dug and trenched as convenient. It is time to sow a little *Celery* and *Cauliflower* seed, either on a slight hotbed, or in pans and boxes, where there is a little heat. Temperature for *Cucumbers* from 60° to 68° at night, fully 70° during the day; and if air is given early, the heat may rise to 80° or 85° by sun heat. A few *Chilis* and *Tomatoes* should also be sown, and sweet herbs, as *Basil* and *Marjoram*, if wanted early.

FRUIT GARDEN.

We have some trees still to plant and transplant, but the weather has not been suitable for doing much in that way. Proceeded with pruning small fruit, and dredging them with the mixture described lately to keep the birds from the buds. Has any one tried *nux vomica* in moderation? but that would kill the birds if used strong. Beginners, in using mixtures, should beware how they are made up. Lime and soot, and sometimes *nux vomica*, are frequently parts of a composition, and if mixed cool and used sparingly they will do no harm; but if boiled together, though used cool, we have known serious consequences ensue. For instance: a very good paint for many fruit trees may be formed by boiling a quarter of a pound of tobacco in a gallon of water, straining it, and when that water is nearly cool mixing it with 1 lb. of lime, 1 lb. of sulphur, 1 lb. of soot, and enough of clay and more water to make a nice paint of 2½ gallons. Boil all these together, and use when cool, and unless soon washed off we would be afraid that any plant would not be of much use afterwards. When 1 lb. of lime, fresh, and 1 lb. of sulphur are boiled in a gallon of water, and the clear liquid poured off and put away for use, we should not think of using it for syringing a growing plant with unless diluted with at least a hundred times its bulk of water. Of course plants in a state of rest, as deciduous fruit trees in winter, are less easily injured; but even then such an acrid combination would be dangerous. We just throw out the hint because many of the different effects of paints, &c., for destroying insects may be somewhat owing to the modes in

which they are applied. The hotter such mixtures are used the more certain will they be, if not to enclose more thoroughly, at least to kill, the eggs of insects which the eye cannot see; but the more likely also will they be to injure the bark and youngest layer of wood: hence, as a general rule, we dislike to use such applications much hotter than new milk. As an example we might refer to tobacco smoke. Used in moderation, and the smoke presented cool, it will kill all sorts of green fly. Let the smoke be at all hot, and you will thoroughly and quickly kill the insects; but if the leaves are at all tender, you will blotch and kill them likewise. Tobacco paper, from the variety of materials of which it is generally composed, requires even more care in this respect.

Pruned most of the trees in orchard-house. Discovered no insects; but, to make as sure as possible, washed the trees in pots and against the walls with soap water and a brush. Washed also the wall down, and then whitewashed it with quicklime, toned down sufficiently dark with a mixture of blueblack to lessen the reflection of heat and light from the wall. This sticks so well that hardly any of the last year's application would come off when scrubbed with soap and water. We might have left it alone, as it looked clean, but we wanted to dislodge or smother up every insect egg, if there should be any. When all is done we will take away at least an inch of the surface soil, and sprinkle that with hot water, before covering with fresh soil. We are now painting the trees as the buds are swelling. We have no great faith in any particular paint, provided it will smother up and thus kill all insects' eggs. For many purposes clay and sulphur are as good as anything. This season we are using for Peaches, &c., the following:—Half a pound of shag tobacco, boiled in a gallon of water for twenty minutes and then strained; 2½ lbs. of flowers of sulphur; about the same of lime and soot, each made into a paste before mixing cool; nearly 2 lbs. of soft soap, melted with the tobacco water. To these were added enough of thin clay paint to make eight gallons altogether. We would have added a pound of glue, melted, only we did not have it by us. The soap and the clay make it stick very well. The lime was used chiefly to lighten the mixture a little, which will keep the buds more backward than if the colour had been darker; and, as said the other week, we would rather have them as backward in opening as possible without the trouble of shading.

Gave a little water to trees in pots that were dry, as letting the roots become too dry, and then giving them a good soaking at once, is apt to throw the buds off. Removed Strawberry-pots from the floor of the orchard-house, where they were in the way. A few of them had also become rather dry, and this is as injurious to the fruit-buds as keeping the plants too wet. Moved Strawberry-pots from frames to shelves in houses; some on moss, others on turf, and others in pans, where a little drip would be injurious. Removed plants done fruiting; and as it is rather early to keep them, turned them to the rubbish heap, that the pots might be employed for other purposes, as just now we could use many thousands if we had them. Gave a little manure water to the pots where the fruit was swelling, and in sunny hours drew a dry feather among the flowers of plants in blossom, and gave all the air possible, according to the weather. For Strawberries alone, and Peach trees alone, in bloom, fire heat is most wanted in dull days, in order to give air without reducing the temperature. In such weather fresh air is more necessary than even in bright sunshine. If the sunshine is attended by a frosty wind, we give air early but sparingly, and the sun heat will enable us to dispense with fire heat during the day. Night temperature for Peaches and Strawberries in bloom from 50° to 55°, with a gradual rise in sunshine to 70°, 75°, or 80°. Strawberries, when swelling, will bear a higher temperature; but the higher the temperature, and the closer the atmosphere, the less will they be distinguished for flavour. To heighten flavour, no manure water should be given after gathering; and if the sun shines on them in a dry air all the better.

Melons in pots should have a medium temperature of 68° to 70°. Those in beds or pits will enjoy a bottom heat of 75° to 80°, and a night temperature averaging 65°; day temperature from 70° to 75°, and in bright sunshine from 75°

to 85°. Vines breaking may be syringed two or three times a-day. Those coming into bloom with roots out of doors should have the roots carefully protected, a few hot leaves near the soil will keep all right. About a foot of leaves, or fern, or litter, put on early in the autumn, will keep the ground hot enough in general circumstances; but a little more at flowering and setting time will be useful. Vines in bloom should have from 65° to 70° at night, with a rise from sun heat during the day. Vines breaking and growing should average from 55° to 60° at night; 65° at night is high enough for Vines at all times, unless when setting, with the exception of Muscats, Black Damascus, &c., which will bear 70°, or even more. We have, however, had splendid Muscats that, except when in bloom, were never kept higher than 65° at night, but air being given early in the morning, the houses would rise to 85°, or more, during the day.

Figs in pots rarely do well as respects the first crop, unless the pots are plunged in the ground, or supplied with some vessel to stand in, so that the soil shall never be very dry. Once let such soil be thoroughly dry, and the young fruit will drop off to a certainty. The same result will follow if the pots stand long in stagnant moisture. Much water, therefore, should never be in the pan, but it would be well to have an eighth of an inch or so to prevent casualties. When planted out, Figs should have little soil, and be well drained, and then however liberally watered the water will never remain long about the roots. When at rest the soil should be rather dry. If very dry the young fruit will be apt to drop. When the tops begin to move it is best to make holes in the bed or border, and fill these with water first, so that all the soil shall be well moistened in a fortnight or three weeks, instead of doing it all at once. Where the stumping system has not been adhered to in summer, and the bare shoots are now from 6 to 12 inches long, it is a good plan to cut through crosswise the green terminal bud about half way from its apex to its base. The check to mere growth thus given has a helping influence on the young fruits that come from the nodes or joints behind. Thus the cut or pricked terminal bud will, instead of one shoot, throw out several, and the most desirable of these can be retained, and pinched-in, as deemed necessary, for the second crop. We generally prefer doing this after at least half a dozen joints are made, for if done sooner in many cases the joints will show shoots instead of fruit. For out-door trees against walls where only one crop can be obtained, it is best to secure stubby, short-jointed shoots, and merely pinch or cut through the terminal bud in the spring, and select the shoots that come from it for the next season.

ORNAMENTAL DEPARTMENT.

Much the same as last week.—R. F.

TRADE CATALOGUES RECEIVED.

F. Boshell, 86, High Street, Borough, London. *Catalogue of Vegetable, Garden, and Agricultural Seeds, &c.*

Timothy Bridgen, 52, King William Street, City. *Select List of Flower, Vegetable, Agricultural, Tree, Shrub, Ornamental Fruit and Foliage Plant Seeds.*

S. Stafford, Hyde, near Manchester.—*Catalogue of Hard-wooded Greenhouse Plants, Store Plants, Palms, Orchids, and Ferns. Catalogue of Forest and Fruit Trees, Shrubs, &c.*

COVENT GARDEN MARKET.—FEB. 20.

Notwithstanding the frost which has again set in, the supply of all kinds of vegetables in season continues unusually good, and importations from abroad of Lettuce, Endive, &c., have been steadily kept up. Of Potatoes there have been heavy arrivals, but prices have advanced. Old Grapes are now scarce, and the new Black Hamburgs are bringing from 20s. to 30s. per lb. Flowers are less plentiful and consist of the same kinds as reported last week.

FRUIT.

	s.	d.	s.	d.		s.	d.	s.	d.
Apples.....	½	sieve	2	0	to 4	0	0	0	0
Apricots.....	doz.	0	0	0	0	0	0	0	0
Figs.....	doz.	0	0	0	0	0	0	0	0
Filberts & Nuts	100 lbs.	0	0	0	0	0	0	0	0
Grapes, Hothouse.	..lb.	10	0	15	0	0	0	0	0
Foreign.....	1	0	2	0	0	0	0	0	0
Muscats.....	0	0	20	0	0	0	0	0	0
Lenons.....	100	4	0	10	0	0	0	0	0
Melons.....	each	3	0	5	0	0	0	0	0
Mulberries.....	quart	0	0	0	0	0	0	0	0
Nectarines.....	doz.	0	0	0	0	0	0	0	0
Oranges.....	100	4	0	10	0	0	0	0	0
Peaches.....	doz.	0	0	0	0	0	0	0	0
Pears.....	doz.	8	0	12	0	0	0	0	0
dessert.....	½	sieve	6	0	10	0	0	0	0
Plac Apples.....	..lb.	6	0	10	0	0	0	0	0
Potnegrammes.....	each	0	0	0	0	0	0	0	0
Walnuts.....	..bush.	14	6	20	0	0	0	0	0

VEGETABLES.

	s.	d.	s.	d.		s.	d.	s.	d.
Asparagus bundle	10	0	15	0	Leeks..... bunch	0	4	0	8
Beans, Broad..... bush.	0	0	0	0	Lettuce..... doz.	1	0	2	0
Kidney.....100	2	6	4	0	Mushrooms pottle	1	0	2	0
Beet, Red..... doz.	1	0	1	6	Must. & Cress, punnet	0	2	0	4
Broccoli..... bundle	0	9	2	0	Onions bushel	3	6	6	0
Brussels Sprout ^g sieve	1	6	2	6	pickling quart	0	6	6	8
Cabbage doz.	0	0	0	0	Parsley..... bunch	0	4	0	0
Capsicums 100	0	0	0	0	Parsnips doz.	0	9	1	0
Carrots bunch	0	6	0	0	Peas..... bush.	0	0	0	0
Cauliflower doz.	3	0	6	0	Potatoes sack	6	0	9	0
Celery bundle	1	6	2	0	Radiash doz. bunches	0	0	0	0
Cucumbers each	2	0	5	0	Rhubarb bundles	1	0	1	6
Endive score	1	3	2	6	Savoys.....per doz.	2	0	3	0
Fennel bunch	0	3	0	0	Sea-kale basket	1	6	2	6
Garlic and Shallots, lb.	0	8	0	0	Spinach.....sieve	3	6	4	0
Herbs bunch	0	3	0	0	Tomatoes ^g sieve	0	0	0	0
Horseradish ... bundle	1	6	4	0	Turnipsbunch	0	4	0	6

TO CORRESPONDENTS.

* * We request that no one will write privately to the departmental writers of the "Journal of Horticulture, Cottage Gardener, and Country Gentleman." By so doing they are subjected to unjustifiable trouble and expense. All communications should therefore be addressed solely to The Editors of the Journal of Horticulture, &c., 162, Fleet Street, London, E.C.

N.B.—Many questions must remain unanswered until next week.

STOVE FOR SMALL GREENHOUSE (M. S.).—It is quite true that with the great care you bestowed upon it, the stove you name might be used to exclude frost without apparently injuring the plants; but it is, like all fine-less stoves, too liable to hurt plants for us to venture to promote its use.

LOCERNE SEED (G. B. S.).—Any of the principal seedsmen in London could supply you.

PEAR-TREE PRUNING (J. R. W.).—You will find Mr. Errington's directions in No. 17 of our First Series, page 178. He says—"At the winter pruning we examine those shoots which had been tied down to the leaders in July, and reserving a choice spruiking, we tie them down, pruning all the rest away."

POINSETTIA PULCHERRIMA ALBA.—We are informed by Mr. R. Parker, of the Exotic Nursery, Tooting, Surrey, that he can supply any reasonable number of this plant, which some of our correspondents state they cannot procure.

IRON FOUNTAIN CORRODING (E. H.).—We have found genuine red lead paint a good substance for coating iron exposed to wet. We find it stand wet the longest, and the iron corrodes less than when coated with other light paints that have nothing in them, except oil, likely to prevent corrosion. We have also used black varnish with advantage; but a good preventive to the corroding of iron exposed to wet is much wanted. We know of no lasting remedy; but some of our correspondents may be in a position to point out a good substance for coating iron to prevent corrosion, and such would be a boon to horticulturists.

GAS HEATING A SMALL GREENHOUSE (A.).—No wonder that one jet of gas does not heat it sufficiently. Have a circle of jets, twenty at the least, for you can easily regulate the heat by keeping the flame low by means of the tap on the service-pipe. Have the chimney at the top of your "drum," and its bottom quite open to admit air to support the combustion.

EPACRIS CULTURE (T. W. Johnson).—There is no separate publication on the subject; but there is a very full essay on the cultivation of the genus by Mr. Fish, in No. 93 of the present Series of this Journal.

INDIAN FERNS (E. L. A.).—We are not aware of any separate work upon the Ferns of British India.

BLIND FOR GREENHOUSE (M. H. R.).—We have found no better material for this purpose than tiffany and bunting. Thin calico and "harden" we have used, but we prefer the former, as it is light, and does not make the house too dark, but dark enough for shading purposes. Tiffany can be had of various strengths—that termed No. 1 being the best for greenhouse, whilst Ferns and Orchids need a thicker shading. We therefore use No. 3. We prefer the blind on the outside, and, except for Ferns, it should be so fixed that it can be drawn up in dull weather, and only let down in bright sunny weather. For Ferns it may be fixed on the 1st of April, and remain permanently on until October, when it should be removed for the winter. They are made by sewing several widths together to the required length, and then nailing one and to a lath, and nailing that fast to the ridge tree at the top of the house. The lower end is then fastened with tacks to a roller. A pulley is placed at one end at the top of the house, and through it a cord is drawn and fastened to the roller at the end, where a runner is placed, and the cord is then lapped several times round the runner so that in unrolling the blind will be at the top of the house when the cord on the runner is run off. In "Greenhouses for the Many," page 11, a full description of a greenhouse blind will be found; and some illustrations at page 495, of No. 143, Vol. V., New Series, will assist in enabling you to understand what is meant, and which is more difficult to describe than work. We never heard of "The Persian flower that has been so much used last Christmas in the decoration of the London churches." We shall be obliged by any one sending us the name.

GERANIUMS AND FUCHSIAS IN A CELLAR (Young Gardener).—If you have room in your greenhouse, it would be better to place in it those now growing for a few weeks until the weather becomes warmer, when they might be placed in a cold frame. You must not rub the blenched shoots off or the plants may become blind. They should be potted when brought to the light, watered sparingly until growth takes place, when they should be well supplied with water. The Fuchsias require the same treatment.

GOLDEN YEW, PROPAGATING AND GRAFTING (W. B.).—Yews of all kinds are most readily increased by sowing the seeds as soon as ripe. The Golden Yew, and, in fact, all the apiecea, may be raised from cuttings. The best times are April and August. They strike if made from one or two years growth. They should be inserted in a shady border, and if covered with a hand or bell-glass, or a frame, they root with greater facility. Yews and most Coniferae may also be increased by grafting. This is best performed when the stocks are beginning to grow. The grafts should be put on near the ground, and if the union be covered with earth in the shape of a mound the operation is more certain. Tongue or whip grafting is the preferable method. We have not tried grafting Golden Yew on the common Yew at any distance from the ground. We should certainly try to graft some this summer, performing the operation just when the stock commences growth, and putting on the scion by side-grafting, with a part of the shoot or scion left long enough below the graft to reach a bottle containing water. The water in the bottle would be likely to keep the scion fresh until the graft united with the stock, when the part left might be cut off closely. The difficulty in grafting evergreens is to keep the scion fresh until it unite with the stock. Some moss placed on the clay and kept moist assists in securing a speedy union.

JAPANESE CONIFER SEEDS (Sciadopitys).—Your plan of sowing them in sandy loam in pots, and placing them in a cold frame, will answer perfectly. The pronunciation of Sciadopitys is Si-a-dóp-i-tia. It is said to be perfectly hardy, but we have no experience in the matter. We think it would be preferable to plunge the pot in a nursery-border for another season, and get it stronger before finally planting out.

PELAGONIUM FROSTED (Idem).—If you find the pots full of roots, shift at once into a larger size, but let it be one only a trifle larger. Place them in a little heat, so as to induce the production of new roots; but do not keep them in heat so that the shoots become weak and drawn. Remove them back to the greenhouse, and give them the lightest and airiest situation it affords. We think your plants will flower, though late, and be finer than you anticipate.

CYANOPHYLLUM MAGNIFICUM PROPAGATING (An Old Reader).—This plant increases readily by taking the young shoots when about 6 inches long, or with three joints, cutting the lower end immediately below the last joint, and taking off the lowest pair of leaves. The cutting is then inserted in a compost of peat and turfy loam in equal parts, with an equal mass of silver sand. Use pots sufficiently large to admit of the cuttings being inserted up to within half an inch of the second pair of leaves or joints, and plunge in a hotbed of from 75° to 85°, and cover with a bell-glass. The soil about the cuttings should be kept constantly moist, but not wet. They will be well rooted in about a month, or from that to six weeks after putting in. You may cut your old plant down, striking the top, and this will induce side shoots, and these when of sufficient strength will each make a cutting.

CUCUMBER AND MELON-HOUSE CONSTRUCTING (C. P.).—Your mode of making the bed is right, and will answer well for securing a good bottom heat; but you will need extra pipes far top heat—two four-inch pipes if the house is to be used in summer only, and four if Cucumbers are to be grown in winter, and the pipes should be placed as near the front of the house as practicable. The soil over the rubble should be 1 foot in depth. A wire trellis should be provided for the Vines to run upon, and be fixed 1 foot from the glass. Back ventilation will be sufficient; but should the atmosphere become too warm, front ventilation may be given. We fear a bed at the back will not answer, for the plants there would be too far from the light, and would consequently become drawn and weak.

VINERY ON AN EAST ASPECT (Charles Brandon).—Providing your house be heated and glazed with large panes of glass, we see no reason why you should not grow Grapes profitably in it. If unheated, we fear the sun would not raise the temperature sufficiently to be suitable for the growth and perfection of Grapes. Grapes can be grown in eastern aspects in perfection in heated houses; but we do not know of any person having succeeded in obtaining fine ripe Grapes in such an aspect with unheated houses. Our conviction is that you can grow Grapes profitably in a heated house, though the aspect be east, only you must provide abundant light and ample ventilation.

FLOWER-GARDEN PLAN (H. B. H.).—You might match, and yet have as much variety, by having colours of the same shade opposite to each other, though different things. In the system you have adopted we can suggest no improvement except the above; but for such a scirell it would be an improvement to have a narrow edging inside the Yew, all round, of Cerastium tomentosum. It would give a finished setting to the whole.

LIME BEFORE SOWING GRASS (A Lady Reader).—The plot intended to be sown with Grass seeds would be much improved by a dressing of lime. The lime should be applied in March, and harrowed or raked in, prior to sowing the Grasses. Two tons will be sufficient. Three bushels of prepared lawn seeds is the proper quantity for an acre.

VARIOUS (J. J. W.).—You ask too many questions. In pruning Fig trees the main point is to cut out the old, and supply its place with young wood. They should not be spurred like espalier trees. Frost will not break glass unless the squares are put in too tightly or the laps unputted. The laps of the glass should be putted, and it is better to let the squares fit loosely. The best time to cut a Holly hedge is after the growth is made. Your hedge should have the sides trimmed a little in May. Box trees do not need manure of any kind, especially those that are unhealthy. The Box will thrive in any soil, but does badly in smoky towns. We do not know what Checkens are. Apply Gishurst compound at the rate of 5 ozs. to the gallon of water, by means of a brush to the branches of the Beurre Rance Pear trees, and it will destroy the scale. One man to an acre of pleasure or kitchen garden is the average allowance, but it depends on circumstances. We should say six men would not be too many for your garden. Twenty-four bushels of seed Potatoes are considered sufficient to plant an acre of ground; but of the earlier thirty-six bushels.

WORMS IN HOTBED (E. S. C.).—You may safely place a layer of salt between the manure and the coal ashes; but you must not expect roots to live when they come in contact with the salt. We have found that nothing is so disliked by worms as quicklime, either placed an inch thick, or occasionally sprinkled on the surface. A stone of lime put in a hoghead containing fifty gallons of water, well stirred, and allowed to stand forty-eight hours, makes a liquid that worms do not like. If it be poured with a rose watering-pot on ground where worms are troublesome, it will bring them to the surface.

MEALY BUG (*A Subscriber*).—We have found nothing so effectual against this pest as placing the plants in a pit where the atmosphere is surcharged with ammonia from fermenting stable-mannure. When this was not at hand we have syringed the plants with water at 160° if the leaves were firm in texture, or 140° if thin. This, repeated whenever the insects show themselves, is a cheap and effectual remedy. Next to it we have found the finger and thumb to be very serviceable, especially when supplemented with a syringing with soot water heated to 140°.

HEATING A CUCUMBER-HOUSE (*J. W. Price*).—For a Cucumber-house, 16 feet by 10, the best plan of heating would be to have a pit on each side, a walk in the middle, and two pipes below each pit for bottom heat, and two for top heat. The cheapest plan would be to take a flue all round such pits in a chamber, bed above, and slides from chamber to let heat out, and means for mastering such heat. If so done the first two yards of flue should be brick on bed. Perhaps a still cheaper plan would be merely to have the flue, and grow the Cucumbers in pots or boxes put on the top of it. It is very rarely we can combine the cheapest and the best.

PAINTING A GREENHOUSE (*A Market Gardener*).—When your wood is pretty dry, the best thing you can use is anti-corrosion paint, one good coat. When moist, as you put it on, you might throw on as much dry sand as it would take outside, and your wood would then look like stone. It would not be desirable to do the same inside. We have no faith in your several coats of whitewash outside, even though you put glue in the last coat; and inside it would always be coming off. We question very much if the inside would not be better without anything for a year or two, as it is fresh from the saw, and painting such woods is often the best way to rot them. If the anti-corrosion paint is too expensive for the inside, and you dislike the appearance of the wood, we would use a wash from fresh-slaked lime in preference to anything else; and if that be too white for the back wall, tone it down with blue or lampblack (see "Doings of the Last Week"). To keep out the frost a small iron stove, with a smoke-pipe through the roof, costing altogether about 50s., ought to suit you. It will be best to have the smoke-pipe from one side, a flat head for the stove, and then you can have an evaporating-pan on it.

PILON FRONDOSA (*A Subscriber*).—Mr. Earley says that he obtained it of Messrs. Henderson & Co, Pine Apple Place, Edgware Road; but as our correspondent resides in the vicinity of Dublin, we may add that it is procurable at the Messrs. Garaway & Co, Durdham Down, Bristol. Mr. Earley says that rough stones 4 or 6 inches in diameter must be placed firmly down upon the surface of the freshly-prepared soil, after that a little better prepared soil between and over the stones, the object in view being to keep them moderately dry during the damper winter months, and to admit of the roots running down freely into the small crevices formed by the stones. The little space planted with it, as before described, should be planted pretty thickly.

FLOWER GARDEN PLANTING (*S. B.*).—Much of the beauty of such a group will consist in the heights of the beds, the centre being a dial, with a border round it, then 4½ feet of grass, and then eight beds, in four crossed pairs, thus—Scarlet Geraniums, blue Lobelia, yellow Calceolaria, Purple King Verbena, which will look very well, only the Lobelia-bed must be the height of the others. Then follow 4½ feet of grass, and other eight outer beds in the circle, being as it were the continuation of the eight spokes of a wheel. These are also planted in pairs; but the singularity of the planting is that these outer beds of the spokes are the same as the inner beds, only mixed with white. For instance, opposite Scarlet Geraniums we have Flower of the Day; opposite blue Lobelia, blue Lobelia and Alyssum; opposite Calceolaria, the same and Cineraria maritima, mixed; and opposite Purple King, Purple King again, mixed with Alyssum. No doubt such an arrangement will look well; but we hardly see the reason for making two rings of beds instead of one for such a style of shading light. Most people would prefer contrasting the colours in the different rings of beds, thus—5, blue Lobelia, &c.; 6, Flower of the Day; 7, Purple King, &c.; 8, Calceolaria, &c.

BOILER REQUIRING NO SITTING.—At page 139 you mention a boiler as above in Kent. If your correspondent will communicate with Mr. Weeks, ironmonger and smith, Dartford, he will hear of the boilers he wishes for. One here is doing efficient work in heating coils of pipe in house and the conservatory, which stands in an exposed situation. The boiler is not expensive, and was supplied two years since by him.—KINGSFIELD.

VARIETY OF OAK (*J. Witter*).—It is a subvariety of the Lucombe Oak, apparently that called heterophylla, which, like most of the others, is nearly evergreen.

GLASS-CASE HEATING (*E. M. W.*).—An oil lamp, as you have found, is not only a troublesome and dirty, but an inefficient source of heating the hot-water tank. We employ jets of gas for heating a plant case. This is effective; but if you cannot use gas, employ three or four night lights, and put a woollen cover over the case at night.

CINERARIA SEEDLINGS (*W. Richardson*).—They have no merit as exhibition flowers. They are pretty, but we see little difference in them as common pot flowers.

RED-FLESHED PEAR (*Hortus*).—The only Pear which we remember having red flesh when ripe is the Sanguinole.

NAMES OF PLANTS (*A Young Gardener*).—Clematis balearica. (*T. B.*).—1, Pultenaea subumbellata; 2, Pultenaea stricta apparently; 3, Convolvulus cneorum; 4, Hardenbergia monophylla. (*M. D.*).—Ornithogalum scilloides. (*G. D.*).—1, Niphobolus lingua; 2, Gymnogramma ochracea; 3, Adiantum pubescens; 4, Adiantum assimile. (*A. W. Wills*).—No. 1 is Murraya exotica, L., an East Indian plant; but introduced into and common in some of the West Indian Islands; and No. 2 is Palmsia aculeatus, Lam., one of the plants to which the name "Christ's Thorn" is given, from the supposition that it afforded the "Crown of Thorns." It is a common Mediterranean plant, and in Asia extends to as far east as the Pnjab. No doubt its prickly flexible branches might be easily plaited into a crown; and as it is a common hedge plant in Syria, it was very probably the plant used. The French call the shrub *Porte-chapeau*, from the fruit being hemispherical at the base, and expanded at the top into a broad thin horizontal rim, like a head with a broad-brimmed hat on. (*P. H. G.*).—The three leguminous seeds are unrecognisable, and are quite likely to be common Pulses, not worth house room. No. 3 is a Cucurbitacea, possibly a Momordica. Very likely it bears a pretty Gourd like the *M. balsamina* grown in hothouses.

POULTRY, BEE, and HOUSEHOLD CHRONICLE.

MANAGEMENT OF WATER FOWLS.

"A WILTSHIRE RECTOR" has censed me to take pen in hand—words seem to flow so kindly from him that I am disposed to follow his example, and put some of my experiences on paper. I cannot say so much for poultry as he can, his experience therein is far greater than my own, but I can detail that which has been the source of great enjoyment to me, and which still retains its charm after years of experience. I also feel how much of pleasure there may be if we all communicate through your paper, one to the other, our enjoyments and our experiences in these interesting and simple amusements.

My hobby for a long time has been Water Fowl; and as I believe many persons who have the same taste are prevented from indulging in it by the idea that it must involve a great expense, I have determined to note down my proceedings.

Neither a lake nor a river is required, nor a very large nor deep pond. I have in my garden a piece of water about 14 yards long by 4 broad. When I first took to Wild Fowl, it had sloping grass banks on every side. The consequence was, my Ducks were often drowned. It may sound strange to drown a Duck, and still more so to drown one in such a small pond, but a Duck will drown as readily as a fowl under certain circumstances; and as I wish to put my ideas in a friendly and chatty way before my readers, I may as well give my theory as I go. Ducks swim so long as the outer feathers are firm, close, and well oiled. The down between the feather and the skin remains dry, warm, and light; but when from any cause this down becomes wet, cold, and heavy, the bird does not sink, but is like a water-logged vessel—it floats about on the water, getting gradually deeper and deeper in it, till at last its head droops under the surface, and the body floats about with just the back above the water.

I am quite unable to give any guess at the age of Ducks, or the period in their lives when it may be said of them "It cannot be expected they should last much longer." They are gifted with tolerable longevity. I know an instance of a pair of Dun birds breeding after being fifteen years on a piece of water. Of course they die sometimes of disease or of old age, but with painstaking death will seldom occur. They sometimes quarrel, and then the beaten bird gets drowned unless it can escape. It cannot if the banks are steep or beetling: every time the beaten bird tries to escape to land, which it always seeks to do, the victor pursues it and pulls it down. An outlet must be provided, and the proper way is to cut at each side of the pond, through the bank, a slant that comes rather below the level of the water at its end. This will form a shallow 2 or 3 feet in length, and any bird by its means can readily leave the water. If, further, it is well gravelled it forms a secure, very useful as a feeding-place. If Ducks are fed in deep water much of the food is lost by sinking to the bottom.—B.

(To be continued.)

A LAST WORD ON THE BIRMINGHAM DIFFICULTY.

As I was the first, at all events without a *nom de guerre*, to write to you about the Birmingham difficulty, I am entitled to a last word.

Mr. J. H. Smith, one of the Judges at Birmingham, has with a certain amount of self-complacency offered to assist at the "funeral obsequies" of this protracted discussion, and he addresses this epitaph, "*Parturiant montes, nascitur ridiculus mus.*" If Mr. Smith had left the matter here, I might have been content to bury the discussion, although I disagree with him on many points; but in the following Number he disinterred the poor mouse and gave it another tossing. The result of the inquiry has been far from satisfactory I confess, but the question which is involved in it, and which by a consequence is assailed in the sneer implied by this quotation, is neither ridiculous nor small. If Mr. Smith thinks the quotation is applicable to the result, he is taking advantage of honesty foiled by knavery; if he thinks

it is applicable to the question at issue, I have nothing more to say to him either as a judge or in any other capacity. As I understand the matter, the question is between Mr. Hindson, Mr. Williams, and the public, and except by a generous but not successful interference Mr. Smith has nothing to do with it.

Whatever may be allowed in some shows with regard to hiring and borrowing fowls for exhibition, I, for one, protest against it, and will never enter a bird that is not *bona fide* my own property. Poultry exhibitions, I presume, should be of birds and not of purses, of skill and not of pay. I fear that the groans now nearly forgotten of your correspondent "SMALL FRY," with regard to the almost hopeless chance of small exhibitors, have more of truth than he got credit for.

Mr. Smith's last letter contains another sneer and as many anomalies as his other communications. He is not an able counsel, and would if possible damage his cause. I must apply to him the "short and homely" words used by Lord Derby the other day on our foreign policy, for the whole of Mr. Smith's correspondence may be summed up in the words "meddle and muddle."

Let the matter now be buried as Mr. Smith wished, but without his epitaph, for no amount of writing will clear up this questionable transaction; and nothing will satisfy the public but that the facts of Williams v. Hindson be made clear to them by the Birmingham Committee, and that a direct answer be given to the question put some time since, "Whether collectively or individually they broke faith in the matter of the Birmingham ten-shilling day."—GEORGE MANNING.

MANY besides myself, I daresay, have made the discovery that it is much easier to enter into a controversy than to get out of it again. The first step is clearly the "*facilis descensus Averni*," and the difficulty of extrication is hardly too forcibly expressed by "*vestigia nulla retrorsum*."

I thought nothing would have induced me to trouble you with another word; but the letter of Mr. Hewitt, in your Journal last week, seems to charge me with an unjustifiable misconstruction of some remarks of his, to which I referred in my last communication.

Now, nothing could possibly be more remote from my wishes than any such intention as this. Even if Mr. Hewitt can give me credit for no better motives than those which spring from ordinary prudence, he must see from the part I took in the recent controversy, that I could have no desire, needlessly, to attach the weight of his name and position to the insinuations which I thought his words conveyed.

The remarks which are the origin of this misunderstanding occur in the concluding paragraphs of a recent communication of Mr. Hewitt's on the marking of Game fowls. I read them with pain and regret, believing they were calculated to suggest the inference of which I complained.

But I admit Mr. Hewitt's right to be the interpreter of his own language and intentions; and as I understand him to repudiate all intention to suggest the inference I referred to, I gladly accept his disavowal as perfectly conclusive, and, had I known of it before, the remarks which seem to have annoyed him would not have been written.

Under other circumstances I might myself have had some complaints to make against Mr. Hewitt's letter; but as it was evidently written under feelings of resentment, I will console myself by the reflection that the words of an angry man are generally worse than his thoughts.—J. H. SMITH.

NEW VARIETIES OF PIGEONS.—In a recent Number of THE JOURNAL OF HORTICULTURE I noticed the names Satinettes, Brunswicks, and Icelanders. May I again ask the breeders or exhibitors of these Pigeons for a description of them? as I do not know any varieties by those titles, and am in ignorance if they are really new varieties or only old friends with fresh names. May I again repeat my request for an account of those Pigeons called Neapolitans? And if any of your numerous readers can help me to any information respecting the Indian Lowtan or Ground Tumbler, or what sort it is that the natives of India use for high-flying, it will much oblige.—B. P. BRENT.

BIRMINGHAM DISQUALIFICATIONS. TRIMMING GAME FOWLS.

I HAVE been expecting some of your contributors to notice Mr. Smith's defence of his colleague, Mr. Hindson, as to his having at some shows exhibited borrowed birds as his own. What are we to expect now when a Judge positively upholds such a practice? How is the honest exhibitor to act? To me it appears simply an act of extreme dishonesty—acting, in fact, a lie—giving the prizes as a premium for the sharpest practice. If such dishonesty is sanctioned by the promoters of shows, there is an end to one of the great pleasures of winning—viz., knowing that they are your own birds.

Somewhat bordering on dishonesty, "Our Letter Box" of February 9th contained a reply to "C. C." on trimming Game cocks that perfectly staggered me. I can understand that it may be quite fair to pull out a single stray feather, but that "the removal of every feather and hair from the crown and face is very desirable," and, according to your reply, quite "legitimate," distances me.

To this I would simply say, If this is allowable in Game, why disqualify, as has been done for the same amount of trimming, nay, a less amount, in Spanish, where such a clean look is equally desirable? Allow it in Game, and the equity of refusing it to other breeds is certainly questionable. I apprehend the process to the poor fowls is none the pleasanter because sanctioned by authority; and if some strains are finer in the feather, and, therefore, better, it is depriving them of an advantage in the competition which they enjoy naturally, and for which they ought to receive a certain amount of favour in the eyes of the Judge.—Y. B. A. Z.

[Game cocks are an exception to the rule forbidding trimming. They are to be exhibited in the condition they would be if intended to contend in the cock-pit: hence the comb is dubbed, and all superfluous hairs, &c., removed from the head.]

IMPROVEMENTS IN POULTRY SHOWS.

SEVERAL letters have lately appeared in your pages suggesting improvements and reforms in the poultry world, and some with special reference to exhibitions. Amongst others "EGOMET," "Y. B. A. Z.," and "A COMPILER OF THE DARLINGTON SCHEDULE" will have done something towards rousing exhibitors from the state of apathy in which they have lately been sunk respecting the management, or, rather, mismanagement, of these pleasant *réunions*, and inducing them to adopt some decided measures in order that they may be placed upon a proper footing. My object is to offer a few suggestions in this direction, and to point out what my own experience has taught me are great obstacles to the extension and success of exhibitions, which are even at present a source of recreation and pleasure to many thousands of people, both exhibitors and visitors.

In the first place, I quite agree with your Darlington correspondent as to the necessity of fixing the amount of entrance fees with some reference to the amount of prizes offered. A case in point may be taken from the schedule of the last Birmingham Show. I might have made four entries in classes 1, 2, 7, and 8, the expense being £1 for the subscription and 10s. entrance fees; I might also have made entries in classes 33, 34, 39, and 40 at the same outlay; but in the first case prizes to the amount of £20 might have been won by my fowls, while in the latter the four first prizes only amount to £8. In one case the total amount of prizes offered in the four classes was £52, and in the other £12. I would also suggest that either higher prizes should be offered for Pigeons in proportion to those for fowls, or lower entrance fees demanded. This is always an attractive branch of an exhibition, and I am certain entries would be astonishingly multiplied if fees were reduced, even although the prizes were smaller.

Offering three prizes at least in each class, and more whenever possible, would be a step in the right direction. On looking over some recent prize lists I find that two prizes in each class are a general rule, and in many classes only one is offered. I think it would be much better policy instead of £1 and 10s. to say 15s., 10s., and 5s., though I would prefer adding 5s. to the entire amount, and making the first prize never less than £1.

The system of excluding all but annual subscribers from the Birmingham Show, and I believe others, is a bad one. Every effort should be made to extend and not to limit competition. Many hundreds of working men are possessed of a few fine and well-bred fowls and Pigeons, their names may frequently be found amongst the prizetakers at the local shows, and they are often desirous of entering for higher honours in the feathered kingdom. Suppose the case of a poor man who has a pair of Baldpates or Jacobins, which he believes to be the most perfect birds of the kind in the kingdom. His friends are of the same opinion, but "to make assurance doubly sure," he is willing to send his household pets to Birmingham. Not being able to raise "the needful," his friends offer to pay the entrance fee, which they suppose will be about double the 1s. 6d. paid for the same birds at their own Show, or, as Birmingham is such a great Show, possibly it may be 5s. This and carriage they will struggle hard to raise; but on inquiry their hopes are dashed to the ground by the receipt of the following intimation:—"14, None but donors, or subscribers of not less than £1 per annum will be entitled to compete for prizes. Exhibitors, in addition to their donation or subscription, will be charged 2s. 6d. for each pen of poultry, and 2s. 6d. for each pen of Pigeons. Exhibitors may enter as many pens of fowls or Pigeons as they wish, paying a subscription of £1 for each four pens of fowls, and £1 for each six pens of Pigeons in addition to the entrance fees." His birds are thus at once excluded from the competition, and his disappointment is none the less because he is told subscribers are supplied with free tickets of admission; for he is quite as likely to take a trip in Mr. Coxwell's balloon as to travel from Lancashire to the Birmingham Poultry Show, however much he might long for such a treat.

One case in point will illustrate, perhaps, still better how this rule works as far as Pigeons are concerned. A friend of mine, who has been tolerably successful at various provincial exhibitions, was desirous that his stock should have the opportunity of trying conclusions with the best birds at the last Birmingham Show. He thought of sending eight pens of Pigeons, and, of course, was quite willing, in addition to extra cost of carriage, &c., to pay a higher entrance fee than usual. Fancy his surprise on being informed that he must pay £3 for the privilege of sending his birds! or at the rate of 7s. 6d. per pair. If the object is to exclude all small exhibitors, and confine the entries at the great Show of the year to great people and owners of long purses, it answers its purpose admirably, and nothing more can be said; but if entries of good birds, whether the property of rich or poor, is the object in view, some other plan must be adopted than that of compelling the latter to pay 22s. for a single entry. Why not simply fix a certain amount to be paid for each entry without any subscription?

Many owners of poultry and Pigeons never enter their birds for exhibition, because they have not confidence in the Judges and judging, and this feeling largely prevails amongst those who do exhibit. It is seen that men of no note or standing in poultry matters beyond their own limited circle are appointed Judges. Decisions as opposite as light and darkness are given within a week respecting the same birds.

There are plenty of well-known men thoroughly qualified to act as Judges, who are known and respected from one end of the kingdom to the other, and on whose upright and impartial discharge of their duties exhibitors and owners could place perfect reliance. The engagement of first-class Judges, even at an increased cost, and the announcement of their names along with the schedule of prizes, would soon effect a large increase in the number of entries, and bring many new competitors into the field. Owners would then see who were to decide on the merits of their birds, and would not hesitate about entering them, knowing that these men are free from any influence but one—an earnest determination that the best birds shall win.

There is one drawback to the success and increase of poultry shows in the high rate of railway carriage. If some united effort were made, I think the leading railway companies might be induced to undertake to carry all fowls, &c., sent for exhibition, for a single fare, to and from the nearest station, as is occasionally done on some lines at present. If a general adoption of this rule cannot be secured, an active, energetic, and working Committee may often arrange with

the railway company to grant it in their individual case, and so greatly increase the success of their show. The mention of such a Committee reminds me that more care in the selection of committeemen would be an advantage to all parties concerned. The best men for the work, and who are willing to do the work, whether fanciers or not, should be appointed on committees, and their names laid before the public, as a guarantee of their responsibility and *bona fides*.—CHESHIRE.

CAUTION TO POULTRY-FANCIERS.

LAST Wednesday a person called upon me, representing himself to be Mr. Samuel Shaw, of Stainland, and endeavoured to obtain poultry on credit, and wanted to exchange some birds, which he promised to send; but would have taken mine along with him if I would have allowed him. When he was going away he wanted to borrow money, saying that he had no change, and nothing but a note and a cheque.

I have since seen Mr. Shaw, who informs me that his name is Henry Carter, of Holmfirth, nephew to the exhibitor of the same name.

In appearance he is rather stout, with sandy hair and whiskers; he wears a plaid cap and trousers and brown coat, and takes snuff. Height about 5 feet 9 inches.—CHAS. LISTER, *Bracken Hill, Mirfield.*

CRYSTAL PALACE BIRD SHOW.

It is again our pleasing duty to record the success of one of the most interesting of Exhibitions—viz., the Crystal Palace Show of British and Foreign Birds, which was thrown open to the public on Tuesday, the 16th inst.

When the inclemency of the season is taken into consideration we think that the Directors cannot be otherwise than gratified at having had a fine collection.

That this Show probably is second to none in the kingdom there can be no doubt, and we are glad to find that the untiring exertions of those on whom the arrangements and carrying out of the undertaking depended have been crowned with success. The number and excellence of the specimens exhibited proved that the interest taken in this annual Exhibition had not abated since the last display. The goodly condition of the representatives of our delightful little songsters could not but have been pleasing to those who admire them.

The British birds were more numerous and in finer feather and condition than on any previous occasion. The Blackbirds, Thrushes, Robins, Bullfinches, and Goldfinches far surpassed those exhibited at any former Show, and were also very superior classes. Among the British birds we noticed very unusual varieties of the Lark, the Linnet, and the Starling, the latter having a white throat.

The Foreign birds were not so strongly represented this time, but were nevertheless very fine in feather. A most exquisite specimen of the Blue Mountain Parrot was shown, and which deservedly obtained a first prize.

Among the birds which were not for competition we noticed two most superb specimens, called the Minor or Indian Crackle, which has the extraordinary power of imitating the human voice, excelling all other birds in that respect. They belonged to Colonel Abbott.

The Canaries were very beautiful and of excellent quality. The Lizard variety was very fine, as also that of the Variegated Norwich.

The Goldfinch Mules, too, were all that one could wish. Among the latter was an extraordinary specimen—black, with dark green wings.

The arrangement of the classes was admirably performed, and the parties on whom this duty devolved well deserve the thanks of the Judges.

The following is the list of awards:—

Noawien (Clear Yellow).—First and Third W., Walter, Hyde Street, Winchester. Second and Extra, F. Willis, St. Martin's-at-Oak, Norwich. Very Highly Commended, W. Walter; J. W. Price, Walnut Street, Derby; J. Judd, Newington Road, Surrey. Highly Commended, J. Harrison, St. George's Street, Canterbury; W. Barnes, Cannon Street, London; J. Judd; J. Patten, Club Row, Shoreditch; R. Mackley, Infirmary Road, Norwich. Commended, C. J. Aye, Olive Street, Sunderland; R. Mackley, Norwich. (The whole class commendable.)

NORWICH (Clear Yellow).—First and Extra, F. Willis, Norwich. Second, R. Mackley, Norwich. Very Highly Commended, W. Walter, Winchester; J. Pullen, Shore-ditch. Highly Commended, W. Walter; G. Harrison; J. Judd. Commended, J. W. Price, Derby. (A good class.)

NORWICH (Variegated or Marked).—First, W. Walter, Winchester. Second, J. Webster, Magdalen Street, Norwich. Very Highly Commended, C. J. Ayre, Sunderland; R. Mackley, Norwich. Highly Commended, W. Walter, Winchester; J. Judd, Newington Road. Commended, J. W. Price, Derby; F. Willis, Norwich; J. Judd, Newington Road.

NORWICH (Crested or any other Variety).—First, T. Banfather, St. Martin's-at-Oak. Second, J. Reeks, Crosby Row, Walsworth Road. Very Highly Commended, J. Reeks; T. Banfather; R. Mackley. Highly Commended, J. Reeks; J. Judd. Commended, R. Mackley.

BELGIAN (Clear Yellow).—First, W. Williams, Nottingham. Second, G. J. Barnesby, Abbey Street, Derby. Third, H. Marshall, Sand's House, near Durham. Very Highly Commended, J. Lingard, Old Street, Ashton-under-Lyne; G. Harding, Oldham Road, Ashton-under-Lyne. Highly Commended, T. Roper, Vice Terrace, York Road, Lambeth; C. Pinchen, Manor Place, Buckland, Fotsmouth. Commended, C. Nicholson, Fareham.

BELGIAN (Clear Buff).—First, T. Roper, Lambeth. (An extraordinary bird.) Second, W. Phillips, Old Basford, near Nottingham. Very Highly Commended, J. T. Wilson, Bristol. Highly Commended, G. Harding.

BELGIAN (Variegated or Marked).—First, W. Phillips, Old Basford. Second, W. Williams, Nottingham. Third, H. Marshall, Sand's House, near Durham. Commended, O. Nicholson, Fareham.

BELGIAN (Buff, Variegated, or Marked).—First, W. Phillips, Old Basford. Second, W. Williams, Nottingham. Very Highly Commended, O. Nicholson, Fareham. Commended, J. Bunday, Upper Wharf, Fareham.

BELGIAN (Crested or any other variety).—First, J. Lingard, Ashton-under-Lyne. Second, W. Phillips, Nottingham. (Class inferior.)

LONDON FANCY (Jonque).—First and Second, J. Waller, Tabernacle Walk, Finsbury. Very Highly Commended, W. Arthur, York Road, King's Cross.

LONDON FANCY (Mealy).—First, W. Arthur, York Road, King's Cross. Second, J. Waller, Tabernacle Walk, Finsbury. Very Highly Commended, W. Arthur; J. Waller. Highly Commended, J. Waller.

GERMAN (or any other variety except Norwich or Belgian).—First and Second, T. Newmarch, Old Street Road, London. Highly Commended, J. Pullen, Shore-ditch; T. Newmarch. Commended, T. Newmarch.

LIZARD (Golden-spangled).—First, J. Tarr, Thoruhill Place, Caledonian Road, Islington. Second, W. Phillips, Old Basford, Nottingham. Third, J. W. Price, Derby. Very Highly Commended, J. W. Price; J. Waller, Finsbury. Highly Commended, W. Williams, Nottingham; C. R. Baker, Spring Street, Lundport; W. De Blaquiere, Lansdowne Place West, Bath; J. Waller; L. Buxton, Sadler Gate, Derby; F. W. Fairbrass, Canterbury; C. J. Ayre, Sunderland. Commended, H. Marshall, Sand's House, near Durham; J. Tarr; J. Waller; E. W. Fairbrass. (Very superior class.)

LIZARD (Silver-spangled).—First, T. G. Hall, Bushford, Nottingham. Second, W. De Blaquiere, Lansdowne Place West, Bath. Very Highly Commended, J. Lingard, Ashton-under-Lyne; J. Waller, Finsbury; T. G. Hall. Highly Commended, J. W. Price, Derby; W. Williams, Nottingham; W. Smith, Star Street, Fiddington; J. Pullen, Shore-ditch; F. W. Fairbrass, Canterbury.

GOLDFINCH MULE (Jonque).—First, G. J. Barnesby, Abbey Street, Derby. Second, G. Crocker, Queen Street, Plymouth. Extra, W. H. Morgan, Lockyer Terrace, Plymouth. Very Highly Commended, W. Walter, Winchester; C. J. Ayre, Sunderland; T. G. Hall, Basford, Nottingham. Highly Commended, J. Doel, Union Arcade, Plymouth. Commended, T. Newmarch, Old Street Road, London.

GOLDFINCH MULES (Mealy).—First and Second, W. L. Chapman, Abingdon Terrace, Northampton. Extra, J. Doel, Union Arcade, Plymouth. Very Highly Commended, F. Hook, Amelia Street, Walworth Road; G. J. Barnesby, Abbey Street, Derby; H. Marshall, Sand's House, near Durham; W. Walter. Highly Commended, F. Hook.

CANARY MULES (Any other variety).—First, H. Marshall, Sand's House, near Durham. Second, R. Newmarch, Old Street Road, London. Very Highly Commended, J. Lingard, Old Street, Ashton-under-Lyne; H. Marshall. Commended, J. Judd, Newington Road; J. Lingard.

BRITISH BIRDS.

BULLFINCHES.—Prize, J. Judd, Newington Road. Extra, Miss C. Nicholson, West Street, Fareham. Very Highly Commended, A. P. Nicholson, West Street, Fareham; T. Newmarch, Old Street Road, London. Highly Commended, J. Judd; W. Walter, Winchester; J. Palmer, Penge. (A very fine class.)

CHAFINCHES.—Prize, Miss A. Nicholson, Portland Street, Fareham. Highly Commended, A. Herbert; Miss M. Simmonds, Chilcomb Rectory, Winchester; J. Crew, Plumstead.

GOLDFINCHES.—Prize, T. G. Hall, Basford, Nottingham. Extra, G. Harding, Oldham Road, Ashton-under-Lyne. Very Highly Commended, J. Judd, Newington Road; F. T. Smith, jun., Dulwich; J. Crew, Plumstead. Highly Commended, J. Judd; H. Marshall, Sand's House, near Durham; J. Page, Upper Norwood; J. Palmer, Penge. (A very fine class.)

LINNETS.—Prize, J. Judd, Newington Road. Extra, J. Waller, Finsbury. Very Highly Commended, H. V. Reid, Ewell; H. Jerrom, Upper Norwood. Highly Commended, J. Judd; Mrs. J. Chinery, Wooton, Hants.

SKYLARKS.—Prize, J. Judd, Newington Road. Highly Commended, W. Walter, Hide Street, Winchester.

WOODLARKS.—Prize, J. Judd, Newington Road. Highly Commended, W. Walter, Winchester.

ROBINS.—Prize and Highly Commended, J. Crew, Plumstead. Highly Commended, A. P. Nicholson, West Street, Fareham.

BLACKBIRDS.—Prize, W. Newman, Crystal Palace Hotel, Upper Norwood. Extra, C. W. Wass, Upper Norwood. Highly Commended, W. Walter, Winchester; E. P. Cuddon, Cadogan Terrace, Chelsea.

SONG TERZUSSES.—Prize, R. Simpson, Langham Place South, Camberwell New Road. Extra, E. Body, High Street, Portsmouth. Very Highly Commended, J. Gordon, Anerley; W. Smith; Master C. E. Hunt. Highly Commended, T. Simmonds, West Street, Fareham.

THRUSHES (Any other variety).—Prize, W. Walter, Winchester.

STARLINGS.—Prize, J. Judd, Newington Road. Highly Commended, W. Bicknell, Elbury Street, Belgravia; Miss L. Fisher, Ravencroft Lodge, Penge; J. Judd.

MAGPIES.—Prize, A. Herbert, Hamlet Road, Norwood.

JACKRAWS.—Prize, J. Mitchell, Gipsy Hill.

ANY OTHER VARIETY OF BRITISH BIRDS.—Prize, H. Marshall, Sand's House, near Durham (Pied Lark). Extra, J. Palmer, Heath Terrace, Penge

(Bramblefinch). Very Highly Commended, W. Walter. Highly Commended, Miss A. Nicholson, Portland Street, Fareham (Redpole); F. P. Cuddon, Chelsea (Mountain or Bramblefinch); S. F. & H. Wilkinson, Lam Park (Ring Doves); J. Palmer, Penge (Kestrel Hawk).

HYBRIDS OR MULES, EXCEPT CANARIES.—Prize, J. Collings, Union Street, Borough. (Aviary of twenty birds.)

BIRDS OF PASSAGE AND MIGRATORY BIRDS.

NIGHTINGALES.—Prize, R. Wing, Price's Buildings, Borough. **SISKIN OR ABERDEVINE**.—Prize and Very Highly Commended, J. Judd, Newington Road. Very Highly Commended, W. Walter, Winchester. Highly Commended, R. Simpson, Camberwell; W. L. Chapman, Abingdon Terrace, Northampton.

TITLARK OR TAKE PIPIT.—Prize, J. Judd, Newington Road. **ANY OTHER VARIETY**.—Prize and Highly Commended, C. L. Sutherland, Coombe Croydon (Cross between Migratory Turtle Dove and Collared Turtle Dove, Migratory Stock Dove).

FOREIGN BIRDS.

COCKATOOS.—Prize, Mrs. Emm, Queen's Arms, Watford Station. Second, J. Judd, Newington Road (Leatherer). Very Highly Commended, Mrs. A. Massey, Church Road, Upper Norwood (Australian Rose).

GREY PARROTS.—First, Mrs. Statbam, Penge. Second, J. Lingard. **ANY OTHER VARIETY EXCEPT GREYS**.—First, W. H. Westbrook, Upper Norwood. Second, H. H. Wilkinson, Sydenham Park. Third, J. Judd, Newington Road, Surrey.

LOVE BIRDS.—Prize, J. Judd, Newington Road, Surrey. **AUSTRALIAN**.—Prize, J. Waller, Finsbury. Very Highly Commended, J. Judd; W. Turquand, Upper Brook Street. Highly Commended, T. Newmarch, Old Street Road.

BENGAL.—Prize, Hon. F. G. Dutton, St. James's Place. Very Highly Commended, F. T. Smith, jun., Dulwich. Highly Commended, J. Rose. **KING PARROTS**.—Prize, Mrs. H. Cooper, New Wandsworth.

PENNYANT'S PARAKEETS.—Prize, Captain Payne, R.N., Upper Norwood. Very Highly Commended, J. Judd, Newington Road.

ROSEHILL PARAKEETS.—Prize, J. Potter, Bernondsey. **COCKATEALS**.—Prize, J. Judd. Highly Commended, T. Newmarch. **CORAL-NECKED SPARROWS**.—Prize, J. Judd. Very Highly Commended, T. Newmarch.

JAVA SPARROWS.—Prize, R. Mackley, Norwich. Very Highly Commended, J. Potter, Bernondsey.

INDIGO BLUE BIRDS.—Prize, J. Judd, Newington Road. **ANY VARIETY OF WAXBELLS EXCEPT ZEBRAS**.—Prize, W. Walter, Hyde Street, Winchester. Highly Commended, J. Rose, Norwich.

ANY VARIETY OF FOREIGN BIRDS.—First, J. Turquand, Upper Brook Street. Second, W. Walter, Winchester. Third, J. Judd, Newington Road. Very Highly Commended, W. Turquand; W. Walter; T. Newmarch.

GROUP OF FOREIGN BIRDS IN ONE CAGE OR AVIARY.—Prize, T. Newmarch, Old Street Road.

JUDGES.—*Canaries*.—Mr. T. Moore, and Mr. A. Willmore. *British and Foreign Birds*.—Mr. W. Goodwin.

FOUL BROOD.

MY experience of this disease was detailed at length in THE JOURNAL OF HORTICULTURE of the 21st July last, and following Numbers. I have, however, much pleasure in communicating the following additional particulars in reply to queries which have since been submitted to me by different correspondents.

Its appearance in my apiary dates only from the commencement of the breeding season in 1863, from which time the disease continued in some of my hives until breeding ceased in the autumn. I use only Woodbury frame-hives, and small bar-boxes for queen-rearing in the season. The latter are made entirely of unpainted wood; of the former some are wood (unpainted) and some straw, both kinds being protected by painted wooden roofs and outside cases. All have suffered equally, whether old stocks or swarms, whilst some of the diseased combs which infected my apiary were taken out of a common straw skep.

I am as unable to suggest a cause for the origin of foul brood among bees as I should be to tell how smallpox first originated in the human subject. So far as I can at present judge, its outbreak and diffusion appear to depend upon some specific contagion by which the bees, combs, propolis, or honey from a diseased stock, or the hive which it has occupied, may infect any number of others. Using only moveable-comb-hives I never resort to driving in my apiary, and I am quite satisfied that artificialising had nothing to do with the first outbreak of the disease, although it had the most pernicious effect afterwards in spreading it with preternatural celerity to every stock I possessed (about twenty) before I discovered what was really the matter with them. The disease was propagated as rapidly among my Ligurians as among common bees—in strong stocks as in weak ones.

My opinion that one foul cell would infect a whole hive and ultimately cause its entire ruin, is founded on observation of what takes place when infected bees are transferred from their old hive, and compelled to form new combs in a

pure habitation without the requisite intervention of several days of what has been termed "penal discipline and inanity" in an intermediate-hive. As brood is reared in the new combs, nearly all hatch out at first, with the exception of perhaps a few isolated cells; but this is quite sufficient—every foul cell remains foul, the infection spreads, and in course of time the new combs become as bad as the old ones. The insidious manner in which this fatal disease reappears is well calculated to baffle and deceive any but the most practised observer. In fact, I have myself been more than once deluded in this way, and I regret to say that my friend, "A RENFREWSHIRE BEE-KEEPER," paid the penalty of one of my mistakes by receiving a second Ligurian stock which I believed at the time to have been perfectly cured; but in which, as it turned out, the fatal virus had not been entirely eradicated. These bees had been transferred from their own to a hive of perfectly healthy combs and brood, but without what I afterwards found to be the essentially necessary intervention of several days probation in an intermediate-hive. It really requires an education of the eye to detect the first faint symptoms of the plague, which is thus merely delayed, not stayed altogether, whilst the activity and apparent prosperity of the doomed stock under these circumstances are often such as to render it apparently incredible that

"The fell disease which most subdues at length,
Grows with its growth, and strengthens with its strength."

On these facts and on these observations is founded my conviction that a single foul cell is sufficient in the long run to destroy the strongest stock of bees.

The stock which our Renfrewshire friend handed over to his neighbour on its return from Exeter, was so reduced in numbers from the want of a queen, combined with the fatal effect of the disease upon the brood, that I doubt if it would have rallied after, even if it had survived, the severe treatment which alone offered any chance of a permanent cure, since I have proved beyond question that, at any rate in confirmed cases (and these are all which I have had to deal with since I knew what was really the matter), simple excision of the whole of the combs and removing the bees into a clean hive is but a temporary palliative, and is powerless to do more than delay the final catastrophe. In two instances which have come to my knowledge—one, that of "G. F. B.," related in page 181 of the last volume of *THE JOURNAL OF HORTICULTURE*, and the other, that of "A RENFREWSHIRE BEE-KEEPER," recently detailed in its pages—the distemper spread to neighbouring hives, from a single infected colony sent in ignorance from my apiary.

The queen and bees of an infected stock do not appear in any way diseased. The first pursues her duty of oviposition to the very utmost of her power, often trespassing in her extremity on those parts of the combs which in a healthy colony are solely appropriated to storing honey; the latter work in all respects as diligently as others, and when strong in numbers carry in as much pollen as a healthy colony. My opinion, therefore, is that *foul brood is not a disease of the bees but of the brood*. Adult bees merely act as vehicles for the contagion. If they can be thoroughly freed from it and compelled to make new combs in a pure hive, the malady is at an end, unless the infection be again imported from some diseased stock.—A DEVONSHIRE BEE-KEEPER.

SUPERING STOCKS—AUTUMNAL FEEDING.

Last spring I bought two swarms, and on September 1st they weighed 30 lbs. and 28 lbs. respectively, and now they are strong and healthy. As they are common straw hives can I allow each to swarm once, then cut a hole in the top, and put a glass on? or should I cut a hole at once, and put a glass on? Supposing I did the latter, would it prevent my having a swarm? Is it always necessary to feed a stock in one of Neighbour's improved cottage-hives during the autumn?—DUMPLING.

[If you allow your stocks to swarm there is little chance of their filling supers afterwards. A glass capable of containing only from 5 to 8 lbs. if put on in April will not prevent, and probably not even delay, the issue of a swarm. The necessity for autumnal feeding depends upon the stock of food within the hive, not upon its construction. Other

things being equal therefore, bees domiciled in one of Neighbour's improved cottage-hives are not more likely than others to require feeding during autumn.]

OUR LETTER BOX.

BREEDING COCHIN CHINAS (Cochin).—Breed your chickens in April or May, if you want large birds, and do not spare the food when they are young. We believe Mr. Baily thinks rain water produces gapes in chickens.

MATING GAME FOWLS.—SPRUS OF DORKINGS (*Amateur*).—Mate a brown hen, with lighter breast, and yellow striped hackle, with your dark red, black-breasted Game cock. It is not necessary that a Dorking pullet should have spurs; but they often have them, even when very young, and it is no disqualification. It need not even be a disadvantage.

NEWLY-LAID EGGS MUSTY-FLAVOURED (G. C.).—Eggs are not naturally musty, nor is it possible they can be; but they will take before they are laid the flavour of any particular food. Thus, if a hen be fed on onions or malt, in both cases the eggs will have an obnoxious taste. If, when they are first laid, and while the shell is soft, they are laid in anything strong-smelling, they will acquire that smell or taste. As such are not natural, you must seek the cause, and remove it if it is a local one.

WHITE POWDER ON COCHIN-CHINAS' LEGS (Quero).—The appearance you mention is not uncommon in old birds, but it is seldom met with in young ones. We have never seen it in a bird less than eighteen months old. We have washed with soap and warm water, and rubbed with sulphur ointment successfully. As the cuticle of the legs is similarly affected in all old birds, and the disease seems to increase according to age, we attribute it to deficient circulation.

REARING EARLY DORKING CHICKENS (J. F. W.).—We are not friendly to stoves or hot-water pipes for chickens. We will endeavour to tell you what you should do to rear chickens at this time of the year. You should let the hen and chickens be under the rip or coop, in a sheltered place on the ground, but the ground should be covered with dry dust. There should also be plenty of dust outside for the chickens. No dust is so good as that which is found under a hayrick, as it is mixed with sea-s. The hen should never be at liberty at this time of year. The rip should be carefully covered up at night. The chickens should be fed the very last thing at night, and if by candlelight afterwards so much the better; and, above all, at day-break. They must be fed as soon as it is light enough for them to see to eat. Their food should be ground oats, mixed with milk, bread and milk, bread and beer, chopped egg, and cooked meat, especially fat, chopped very fine. The rip should be day and night so placed as to be protected from draughts. They must have dust to keep themselves free from parasites, of which many chickens die. The hen should be fed as well as the chickens, and allowed to eat as much as she will, because, during these long winter nights, everything depends on the warmth of her body, and that depends on her food. The chickens should have beer to drink instead of water, and be constantly fed a little at a time. This system will rear chickens.

DORKINGS (A. N. B.).—You may safely let the hens from which the feathers were taken run together. There is only a shade of difference between them, and both are Grey Dorkings. You will find it difficult to breed them much more alike; and if both run with the same cock you will not, if you have only colour for a guide, know one brood from the other.

QUANTITY OF FOOD (Waste Not).—Two-thirds of a gallon of corn should last a fowl seven days in confinement, but if at liberty less would do. It is difficult to lay down any rule. A fowl fresh from a hungry walk would eat more, and one from a pet run would eat less. The above should be the maximum average, and if other things are given the corn should be decreased.

WOODBURY-HIVES (Billey).—The queen bee is visible at all times on looking over the combs of a Woodbury frame-hive. Messrs. Neighbour and Sons, 149, Regent Street, and 127, Holborn, manufacture these, and all other kinds of hives, and will give all particulars as to price, &c., on application. Payne's improved cottage-hive is one of the cheapest and best for ordinary purposes.

OAT-CRUSHING MACHINE (F-d).—Apply to Messrs. Dray & Co., London Bridge.

DEATH OF GAME PULLET (Cecil).—We should think it was not death from paralysis or apoplexy; but as you did not open the head we cannot be certain. The clots of blood outside the breast were enough to cause death, and we do not think any treatment could have saved the bird's life.

ANDALUSIAN RABBITS (L. Eads).—We do not know who has any for sale. You had better advertise, stating how many you require.

WEST CUMBERLAND POULTRY SHOW (H. A. H.).—We do not know anything about this show.

POULTRY BOOK WITH COLOURED PLATES (G. Browne).—You can have a copy at our office for 25s. of Johnson & Wingfield's Poultry Book. It is out of print and scarce. There is no periodical such as your name.

EXTRA PRIZE FOR PARTRIDGE COCHIN-CHINAS (Fluffy).—You will see by an advertisement in our columns to-day that the subscription closes on the 1st of March.

ARTIFICIAL HATCHING (R. K.).—We know of no establishment for hatching, nor of any maker of the incubator. It was given up by every one who tried it, being found to be both troublesome and expensive. It hatched chickens with perfect success, but no care ever succeeded in rearing them.

RABBITS (A. M.).—The ears are measured from tip to tip. Breadth of ear is considered as well as length. We cannot reply to your query about weight, as you do not mention the variety; nor can we guess whether an advertisement would effect an exchange, but it is the best mode of trying.

PARROT WITH DISEASED TAIL (S. J. Fresson).—First scrape the edge of the horny substance which has formed at the bottom of the Parrot's back with a penknife, then lift it slightly up by patting a piece of silver wire or thread round the end, and with caustic touch the place underneath the substance, so as to burn it off. So long as the horny substance remains the bird will not be able to raise its tail.

DEATH OF A HIVE (N. F. W.).—There is little doubt that the death of the queen was the cause of the loss of your stock of bees.

ACCLIMATISATION OF BEES.—Mr. Woodbury informs us that Dr. A. Gertacker is a German, and that he merely wrote about acclimatizing bees more than twelve months after Mr. Woodbury had addressed himself to the subject. The American Journal to which we were indebted for the notice of Dr. Gertacker, alluded, but not specifically, to attempts at acclimatizing bees in the formerly United States, but, we believe, Mr. Woodbury is the only one making a similar attempt in Europe.

WEEKLY CALENDAR.

Day of M th	Day of Week.	MARCH 1-7, 1864.	Average Temperature near London.			Rain in last 37 years.	Sun Rises.		Moon Rises.		Moon's Age.	Clock before Sun.	Day of Year.			
			Day.	Night.	Mean.		m. h.	m. h.	m. h.	m. h.						
1	TU	Lungwort flowers.	47.5	34.0	40.7	14	46	af 6	39	af 5	28	1	0	10	61	
2	W	Wild Goose departs.	48.8	35.5	42.2	14	45	6	40	5	27	2	55	10	62	
3	TH	Pilewort flowers.	49.4	32.3	40.9	15	42	6	42	5	21	3	after.	24	12	17
4	F	Mistletoe flowers.	49.1	31.3	40.2	11	40	6	44	5	5	4	15	1	26	
5	S	Ash flowers.	48.4	31.7	40.0	10	38	6	45	5	45	4	34	2	27	
6	SUN	4TH OR MIDLENT SUNDAY.	48.7	32.5	40.6	14	36	6	47	5	16	5	59	3	28	
7	M	Spring commences.	49.4	32.8	41.1	13	33	6	49	5	47	5	23	3	29	

From observations taken near London during the last thirty-seven years, the average day temperature of the week is 48.7°, and its night temperature 32.9°. The greatest heat was 63°, on the 7th, 1859; and the lowest cold, 15°, on the 4th, 1852. The greatest fall of rain was 0.62 inch.

THE ROYAL HORTICULTURAL SOCIETY'S
ADJOURNED MEETING

AT SOUTH KENSINGTON.

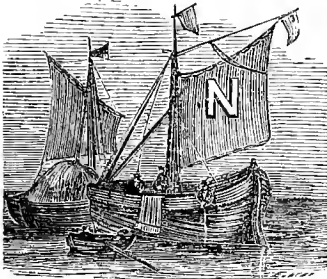

EVER before, in our day, have the horticultural body united so closely, or made so firm and decided a stand as they have recently done at the annual meeting of the Royal Horticultural Society. They conceived, rightly or wrongly, that the Council of the Society were about to enact mea-

sures inimical to the interests of horticulture, and the close serried ranks which presented themselves to protest against those measures might have induced a more successful administration to pause and reconsider their plan of future operations. This was not, as we heard whispered, a mere party movement, although, in the heat of argument, party spirit might have found utterance. The leaders of the movement were not the instigators of it, but merely the exponents of the horticulturists' views, and to them the horticultural world has contracted a deep debt of gratitude.

It is a fortunate circumstance when, even in a bloodless fray like that which recently took place at South Kensington, the contending parties retire from the field, each satisfied with the result of the contest. In the present case we sincerely believe that each has achieved a victory; and we gladly indulge the reasonable thought that neither is anxious to renew the combat. The Council have listened, weighed, and conceded what they doubtless considered just concessions, with a frankness and goodwill which should go far to disarm opposition; and horticulturists have retired with a praiseworthy generosity and moderation, satisfied with the results, so far as matters have at present gone. But we warn the Council that if they wish for the support of the horticultural body, Horticulture must be the chief end and aim of their labours; and we caution horticulturists, that if they wish their cause to prosper, they must here, as in other matters of business, look closely to it themselves.

Without attributing to the Council any ulterior views likely to prove disadvantageous to Horticulture (which if we had believed in we could hardly entertain after the distinct disclaimer put forth by a prominent member of that body), we yet think that Horticulture has not been so prominent an object with them as it should have been. This we attribute to no sinister designs, but rather to the weakness of the horticultural element in the Council, and which, consequently, found a difficulty in making itself heard and felt.

When the late lamented Prince Consort conceived the noble plan of uniting Horticulture with Architecture,

Sculpture, and Painting as sister arts, the idea was hailed with delight by the foremost and most intelligent of our horticulturists. The antecedents of the Prince were taken as a sufficient guarantee that the idea would be faithfully carried out. The wisest could not foresee that by his untimely death the fundamental idea would not only be rendered abortive but positively reversed—that Horticulture, invited as a sister, would be treated as a slave.

The gardens at South Kensington were to be the means of obtaining money whereby these arts should be united in a genial sisterhood, and find there and at Chiswick a comfortable home. But what are the facts? The gardens at Kensington have been an incubus rather than an aid; and whatever Architecture and Sculpture may have gained, Horticulture has gained absolutely nothing. Taking the most favourable view of the matter, we feel constrained to say that out-of-door gardening can never be fairly represented at Kensington; and this view, if we mistake not, will be endorsed by every practical horticulturist. When viewing the miserable-looking, soot-begrimed trees and plants growing (?) there the other day, we could not bring ourselves to believe that the Council ever seriously entertained the idea of tearing the flesh off the bones of grand old Chiswick to gratify the expensive habits of this audacious youngster. No: gardening as a whole can never be fairly represented at South Kensington. Not less utopian was the idea of whitening the skin of the blackamoor by the use of flannel and soap, entertained, imaginary or otherwise, by a set of *soi-disant* philanthropists, and so humourously described by the immortal Hood:—

"In spite of all the tubbing, rubbing, scrubbing,
The routing and the grubbing,
The blacks, confound them, were as black as ever."

And again, as a *dernier ressort* to avoid the consequences of failure—

"We've scrubbed the negroes till we've nearly killed 'em,
And finding that we cannot wash them white,
But still their nigritude offends the sight,
We mean to gild 'em."

It has been said, and doubtless with truth, that the gardens at Chiswick do not pay; but we ask, Were they ever expected to pay? For what purpose are the contributions of Fellows? Does the museum of the Geological Society pay? Is it not intended that both and other similar institutions should be schools for the nurture and development of their respective arts, aided by the contributions of those who take an interest in them? Let theoretical Horticulture and ornamental Gardening (so far as circumstances are suitable), have full sway at South Kensington; but the home of practical Gardening must be away from smoke and brick walls, whether at Chiswick or elsewhere.

It was remarked by a Fellow at the adjourned meeting that the Commissioners of the Exhibition of 1851 actually control the Society. This may be fortunate or unfortunate according to the nature of that control. We believe that their control is part and parcel of the charter, and we must take it as it is—we cannot alter it. The

only escape from this position would be to establish a new Society of Horticulture—a very grave step, which under present circumstances does not seem to us advisable. A fine garden, full of horticultural rarities, and with other manifest advantages, like that at Chiswick, should not be recklessly abandoned. It would take a lifetime to construct another, and we are not for forestalling the enterprise and industry of the rising generation.

Another remark reached us in the council-room (although we should hardly think it would be endorsed by the Council), highly derogatory to the profession. The utterer seemed to have gathered his ideas of gardens and horticulturists in general from the pages of Shakspeare or of Scott. Now Andrew Fairservice might represent the gardener of Scott's day—a quiet, harmless, industrious, undemonstrative man, with little in his head beyond gardening, and not enough in his pocket to take much interest in questions of business life. But times have changed. The gardeners and horticulturists of our day represent a large amount of intellect and capital, and these will always make themselves felt in a commercial country like England. Living amongst us is one horticulturist who has been knighted by our most gracious Sovereign, and another who is Lord Provost of Edinburgh (what would Andrew Fairservice have said to this?); and thousands or millions of money are now invested in gardening, in the place of former hundreds! It cannot be expected that the representatives of these will be content to act a subsidiary part in their own immediate walk of life.

A Horticultural Society, to be well governed, should be governed by a Council composed largely of horticulturists, amateur or professional. A Horticultural Society may exist in name without horticulturists, but practical horticulture, or first-class horticultural exhibitions, are impossible without them. With their aid are secured the support and active co-operation of that large class of Fellows residing in the country, who take a pride and pleasure in their parks and gardens, and who, in addition to their other and, perhaps, more important spheres of usefulness, contribute to the prosperity and happiness of the country as amateur horticulturists. Unless these classes are fairly represented, the Society is a mockery and a sham, and will deserve and meet with the neglect and contempt of those whom it professes to serve.—JUSTUS.

ANNUAL GARDEN FLOWERS.

By the term "annual" we mean a plant of one season's duration, and on the arrangement and cultivation of the many annuals employed in flower-garden decoration I propose to offer a few observations.

It is a pretty general opinion that the plants termed annuals are all very well in their places, but are not admissible in flower gardens for producing a brilliant display of bloom, and their precarious continuance in flower prevents their being employed in ribbon-borders, or in masses of one colour. Now, I hold this to be an erroneous opinion, and I hope to show that a most striking effect can be produced by the substitution of some annuals requiring no attention during one-half the year for some bedding plants requiring attendance all the year round; and if I might be allowed to call to my aid some of those neglected but good old herbaceous plants, needing no care but that which anybody would be qualified to render, I think a very fine display of flowers might be had, not only for three or four months, but at all seasons by the employment of annuals and hardy plants alone.

I do not wish to convey an impression that the present system of massing plants requiring protection in winter, or the planting of them in ribbon-borders or otherwise to produce an artistic effect, is a lavish expenditure that could well be dispensed with as unnecessary; but I do say that many places are made to look ridiculous by a total disregard of the architectural style and proportions of the mansion, in the arrangement and proportions of the flower garden.

How often do we see a garden with its geometrical outlines, its terraces, slopes, statuary, and formal shrubs, and the whole arranged so as to produce a most satisfactory effect, the removal of any one part of which would destroy the harmony and arrangement?

What is more unsuitably placed than an artistic flower garden in front of, or in close proximity to, a mean, patched, or piece-built residence? The garden, as a garden, when viewed individually, may be all that is desired, the design may be novel but symmetrical, the plants well arranged for producing an effective picture, but when viewed in connection with the mansion the contrast is too great to be pleasing to the eye, and an impression is left on the mind that the one or the other is out of place. A garden in close proximity to the mansion should be in accordance with the architectural appearance of the latter. If it be plain, the garden near it ought to be plain also, for nothing is a greater outrage on good taste than to make a garden superior to the mansion in its embellishments. The mansion should be surrounded by gardens that would lead any one to conclude they were appendages to the mansion, and not the mansion an inferior appendage to them.

But is no one to have an artistic garden because he has a residence of no architectural beauty? Quite the contrary; but let that garden be so situated that the eye can view it without anything near detracting from the pleasurable enjoyment of its artistic beauty and arrangement. Although Loudon wrote much on this and other subjects connected with the arrangement of gardens, with a view, as he said, of enabling gardeners to see things with the eye of an artist, yet I cannot discern that his writings on this subject have borne good fruit, but rather that they have produced ill results; for, in almost every place do we see flower gardens, beautiful in themselves, in front of residences which, as far as their architecture goes, might not inaptly be termed barns when compared with the extreme beauty of the flower garden. In many places do we see every inch of available surface converted into receptacles for bedding plants, affording a mere blaze of flower for four months out of the twelve, and being for the remainder of the year a barren wilderness; whilst those bulbs, herbaceous, alpine, and annual plants, with a goodly assortment of flowering shrubs, which combined make a garden interesting at all seasons (as it should be), are not considered worthy of a place within its precincts. There are, however, some lovers of gardening who are not so enamoured of King Croquet and his subjects as to despise the services of their old favourites and their numerous offspring; and to these, but with a view also of gaining converts, I will address myself.

To pass in review all the annuals worthy of a place in flower gardens would take up more space than could well be spared for the purpose; but having grown most of them, if not all, I will only name those most worthy of a place in gardens. Annuals for bedding purposes are few, yet a very fine display can be made with them.

HALF-HARDY.

<i>Ageratum mexicanum</i> , lavender or light blue, 15 inches.	rose, white eye; Queen Victoria, rose, white-striped.
<i>Cineraria maritima</i> , silver foliage.	<i>Calopsis carolinifolia</i> , crimson and yellow, 2 feet; <i>C. coronata</i> , orange, 1 foot.
<i>Lobelia speciosa</i> , blue, 9 inches; or small buds or edgings.	Stock (<i>Matthiola annua densiflora</i>), crimson, blue, violet, scarlet, rose, 1 foot.
<i>Tagetes patula</i> nana (Dwarf French Marigold); striped and yellow, 1 foot.	<i>Vernonia calenduleacea</i> , a hardy annual, but requires sowing in heat; yellow, 9 inches.
<i>Tagetes signata</i> pumila, yellow, 1 foot.	<i>Catechua scabierifolia</i> , yellow, 1 foot.
<i>Perilla nankinensis</i> , metallic dark brown foliage, 18 inches.	
<i>Phlox Drummondiana</i> alba; Leopoldiana,	

These, with those to follow, require sowing in March, except the Stocks, which are best not sown until April, and then they do not require one-half the "coddling" of the others. The soil most suitable for them I find to be composed of light turfy loam three-fourths, leaf mould one-fourth, with a liberal admixture of sand if the loam be deficient in that substance; the whole to be well mixed and chopped, or made fine with a spade. It should be in a moderately dry condition when used, and is best kept under cover a few days to dry and warm it prior to using it for sowing the seeds in. Having the seed-pots or pans clean inside as well as outside, pass the compost through a half-inch riddle, laying the lumps on one side. This compost is suitable for the largest seeds; but for the smaller, half of it should pass through a quarter-inch riddle or sieve. It is a good plan to sort the seeds, placing the largest in one lot, and the smallest in another by themselves; and in sowing to commence and go through with the largest seeds before

beginning to put in the others; for it very often happens when the seeds are sown as the packets come to hand that an oversight occurs, and the seeds are covered too deeply with soil, and the seedsman drops in for an undue scolding. More seeds perish through being covered too deeply with soil than from any other cause. The pots must each be well drained, say one large crock over the hole or holes, and a few smaller upon it or them; then place an inch of the riddings of the compost over the drainage, and fill the pot with compost to within an inch of the rim for large seeds, three-quarters for the smaller, and half an inch for the very small, as Lobelia. Level the compost, and sow the seed thinly on the surface, and cover with the finest compost to a thickness or depth equal to the diameter of the seed. Such seeds as those of Lobelia, Clintonia, &c., which are scarcely discernible, should not be covered with soil, but have a little silver sand sprinkled over them, just sufficient to prevent the first waterings carrying the seeds away.

A neat label should bear the name of each; and the pots being slightly watered through a fine rose, are to be placed on or plunged in a mild hotbed of 70° to 75°, and within a few inches of the glass. A dung-frame or a frame on a dung hotbed, or in a pit heated by hotwater pipes, is best for this purpose. The surface of the bed should be covered with sifted coal ashes or tanners' bark, and in this the pots should be plunged to the rim.

Water of the temperature of the frame should be applied with a fine syringe or fine-rosed watering-pot whenever the surface of the seed-pots indicates any symptoms of dryness; and, as a rule, the water should be applied in the morning. The temperature of the frame ought to range from 65° to 70° by night, and it may rise 10° to 15° with air and sun.

Air should be admitted early in the morning, even a little is better than none in dull weather, and the frame should be closed early in the afternoon. If the heat be mild the frame may be kept close until the plants appear; but after that an abundance of light and air, with close proximity to the glass, must be afforded, so as to keep the plants from becoming leggy or drawn whilst in the seed-leaf, or they will be of little value afterwards. The soil should at all times be kept moist, but no water ought to be given until the surface of the soil indicates dryness.

When the heat of the bed begins to decline, so that the night temperature falls below 60°, the frame should be covered with mats to keep in the heat; and on frosty nights, at any time, mats or a covering of some kind are necessary, so as to preserve the proper degree of heat within the frame. By the time that the heat of the dung is spent the plants will have made a pair of rough leaves; but, whether or not, when the plants are sufficiently large to handle they should be pricked-off into shallow boxes or pans about 3 inches deep; these are best about 1 foot wide, and 1 foot 6 inches long, as they are handy, and take up less room than round pans. If boxes are used a number of holes must be bored at the bottom to allow of superfluous water draining away.

The compost most suitable is turfy loam and leaf mould in equal parts, with a liberal admixture of sharp sand. This should be kept under cover a few days to warm, and after being chopped and broken with the spade, it may be passed through a half-inch sieve. About an inch of the riddings is placed at the bottom of the boxes or pans, and the pans are filled with the sifted compost. The plants are then taken out of the seed-pots carefully, and pricked-out with a dibber in rows an inch apart, and the same distance from plant to plant in the rows. A square foot will, therefore, contain 144 plants. They should be inserted in the soil quite up to the seed-leaves, as most annuals emit roots from below that part. The soil should be in a moderately moist condition when used, so as to cause no necessity for a heavy watering after the plants are pricked-out. Give a gentle watering, and place in the frame again, or in a house of any kind, with a gentle heat (60° to 65°) at night; but a frame is best, for the plants can be kept nearer the glass, and that, with air on at all favourable opportunities, is the immediate cause of stiff, strong, hardy plants. The frame should be kept rather close and shaded for a few days, until the plants recover the check consequent on pricking-out; and nothing is so conducive to their well-being as bedewing them overhead with aired water at the time of shutting-up the frame or house.

In about a fortnight after pricking-out, or six weeks from sowing, the plants will be nice bushy stuff, and will need copious supplies of water, and air on all favourable occasions. Those having the convenience of ainery will have no trouble in raising annuals—only place them in heat to forward them, or get them ready for pricking-out, when they may be potted singly or three or four into a 60-sized pot, or into boxes, and be placed in a position where they may have abundant air when necessary to harden them off, and light at all times.

The middle of March I have found the best time for sowing half-hardy annuals in the northern counties, for if sown earlier they are apt to become stunted, and I am certain that annuals cannot be kept growing too freely from the time of sowing until the flowers appear.

Ten-week Stocks I never could succeed with by sowing the seed in pots as for other half-hardy annuals. They invariably dauped-off at the surface, and in this way whole potsful would go in a day or two, and that without any apparent cause. My practice now is to make a bed of dung (frequently turned and sweetened) about 1 foot 6 inches high, and about 3 inches wider than the frame every way. The frame is then put on, and 4 inches of loam with a little leaf soil intermixed placed equally over the bed. The lights being put on, the heat is up in a few days, and a drill being drawn with the finger sufficiently deep to allow of the seed being covered lightly, the seed is sown thinly in the drills, which are 2 inches apart. A run with the hand over the drills is sufficient to cover the seeds. A slight watering follows the operation, but if the soil be wet the watering is omitted. If the heat in the bed is not more than 75°, the lights are drawn on close, and kept closed until the seeds appear, which usually takes place in a week from the time of sowing. Immediately the cotyledons show themselves, air is given by tilting the lights at the back. The atmosphere about the plants is thus kept cold and fresh, and the seed-leaves lie flat on the soil, or only a trifle above it. Air is freely given on all favourable opportunities, but no water until the soil presents unmistakable evidence of being dry, when a moderate watering is given, and then they are allowed to want more before they get any. After the true leaves appear the lights are drawn off in mild weather, but put on at night, and if frosts occur, a covering of mats is placed on the frame. After May-day the lights are let down in mild or fine weather, but drawn up at night when frosty, and kept on by day in frosty weather, and when heavy rains occur. Towards the end of May the plants are strong, with thick stems and large leaves, and not weak with wire-like stems and narrow leaves, as those invariably are which are sown in pots, and forwarded in a greenhouse or vinery.

(To be continued.)

G. ABBEY.

ROYAL HORTICULTURAL SOCIETY.

ON Tuesday, the 23rd ult., the adjourned meeting of the Fellows of this Society was held at South Kensington. Mr. J. J. Blandy, one of the Vice-Presidents, was in the chair; and there was a very numerous attendance of members.

The CHAIRMAN opened the meeting, and said he had been called upon to preside, but he should have wished that some one more acquainted with the proceedings of public meetings had been requested to take the chair. He would endeavour to do his duty properly, and he must ask their indulgence if he should make any error in conducting the proceedings. He was desirous of allowing the greatest possible latitude to those who would take part in the discussion; but he hoped they would not drift into anything contrary to the bye-laws of the Society. He could not be present at the last meeting, as he was detained in Paris. He had seen, however, from the journals, that the meeting was adjourned for the further consideration of a resolution for the approval and adoption of the report of the Council. The amendment to that motion upon which the meeting was adjourned, was, that the meeting be adjourned in order that the Council may have an opportunity of obtaining from Her Majesty's Commissioners of 1851 the terms upon which the proposed advance of £13,000 was to be made—whether, in all or part, as a gift or loan. A letter had been received from the Commissioners,

and would be read to the meeting; and he trusted that it would be considered satisfactory to the members upon that point. He might mention to the meeting that interest would only be charged upon a portion of the amount, and that the interest would not exceed £38 5s. [hear, hear]. That was a circumstance which must be deemed highly satisfactory to the Fellows [hear, hear]. A great deal appeared to have been said about there being no intention of carrying on the Society as originally intended, and that the Society was not promoting the science of Horticulture as they ought to do. He believed that they would hear, from various speakers on the present occasion, sufficient to satisfy the meeting on that point. With regard to the allegations that had been made as to the non-intention of the Council of carrying out the original objects of the Society, he might tell the meeting that the members of the Council had of themselves, at one time, subscribed £2000 to save the Society from absolute collapse [applause]. He thought, therefore, that they were entitled to some credit for endeavouring to prevent a sacrifice of those objects for which the Society was originally formed [hear, hear]. The Council had fully considered the subject, and they stated that they were fully prepared to carry out the suggestions shadowed forth at the previous meeting [hear, hear]. He would not detain them any longer, but would assure them that he would give every gentleman who wished to address them a fair chance of making any observations which he might be anxious to do, and of being heard and understood [hear, hear].

Mr. MURRAY, the Assistant Secretary, then read the following letter from the Royal Commissioners:—

“Palace of Westminster, February 13th, 1864.

“SIR,—In order to explain the terms upon which Her Majesty's Commissioners for the Exhibition of 1851 are willing to make the advance of a sum not exceeding £13,000 for the purposes of the Horticultural Gardens, as announced in my letter of the 6th inst., the Commissioners feel it necessary to revert shortly to the pecuniary relations now existing between themselves and the Royal Horticultural Society.

“Under the agreement of July 24th, 1860, Her Majesty's Commissioners advanced a sum of £50,000. By the 14th clause of that agreement, a rental of £2145 per annum is reserved to the Commissioners, this sum being the exact amount of interest paid by the Commissioners for the loan of the money laid out under the agreement by them on the gardens.

“In pursuance of a further agreement, dated March 1st, 1861, Her Majesty's Commissioners advanced a further sum of £5100, exclusive of a much larger sum expended by them on the Southern Arcades. By clause 4 of this agreement, the Commissioners are entitled by way of a rent to a sum of £216 15s. per annum, being after the rate of 4½ per cent., making the total rent or interest now payable to the Commissioners under both agreements amount to £2361 15s.

“The above rent is independent of the share of surplus profits secured to the Commissioners.

“With respect to the proposed expenditure of a sum not exceeding £13,000, I am directed to acquaint you, for the information of the Council of the Society, that it is the intention of Her Majesty's Commissioners to charge interest by way of rent on the sum of £4900 only.

“The Council will observe that this sum of £4900, added to the two sums of £50,000 and £5100 already alluded to, completes the amount of £60,000, the expenditure of which was contemplated by the above-mentioned agreement.

“Her Majesty's Commissioners have now much pleasure in proceeding to inform the Council of the Society that, having been recently enabled to pay off that portion of their mortgage debt which bore 4½ per cent interest, they are willing to reduce the rent or interest payable to them by the Society to 4 per cent., calculated upon the outlay of £60,000, being £2400 a year.

“The Council will therefore observe that Her Majesty's Commissioners make the advance of £13,000, with only a nominal addition to the rent at present payable by the Society.—I have the honour to be, Sir, your very obedient servant, EDGAR A. BOWRING.

“The Secretary to the Royal Horticultural Society.”

Mr. HARRY CHESTER then said, that, having been the mover of the resolution upon which the meeting had been

adjourned for a fortnight, he might be expected now to take a certain course, and express an opinion as to the result of the adjournment. He rejoiced to find that what had been said by the Commissioners was so very satisfactory [hear, hear], and he congratulated the meeting upon the very clear and conciliatory address which they had heard from their Chairman [hear, hear]. If anything unpleasant occurred on the last occasion he hoped it would now be avoided. Nothing was further from his mind than to say anything hurtful to the feelings of any gentleman, or to act discourteously towards the Council. It was better to employ their time in providing for a satisfactory future than in commenting upon an unsatisfactory past [applause]. He intended to move certain resolutions, and he hoped they would remove from the minds of the Fellows any wrong impressions they might have, so that they might be in that satisfactory condition of amity without which the Royal Horticultural Society could not be carried on [hear, hear]. Since the last meeting he had received many letters from Fellows containing certain opinions which appeared to prevail in their minds. He did not desire to take so prominent a part in the discussions but for those letters. By some it was considered that the report was not satisfactory with regard to the advance of the £13,000, and also that the Commissioners wished to take the gardens away from the Society. If such an opinion did exist it was the result of some ambiguous statements which had been made, and which could be cleared up. At the last meeting a question was raised as to whether the members of the Council were properly elected. Some of the members of the Society had taken counsel's opinion upon the point, and that opinion was to the effect that the proceedings were not valid. What might be the opinion of one lawyer was not the opinion of another; and if they were to wait until all lawyers agreed they would have no Council, and the Society would come to grief [hear, hear]. He agreed that there might have been a slight irregularity on the last occasion in the mode of election, but he thought there might be much confusion arising from the bye-laws of the Society. There appeared to be a doubt as to the proper mode of election—the Council said they were right, and the Fellows thought the elections were invalid—therefore, the best course to adopt would be to have the bye-laws revised. It would be a clear course to adopt that in future they should be revised [hear, hear], and he should submit a resolution to that effect. The question was raised by Mr. A. F. GODSON at the last meeting, and he knows best where he had his information from as to the five gentlemen who were retiring.

Mr. A. F. GODSON: I had the information from a gentleman who had it from each of the five gentlemen.

Mr. VEITCH: I never gave any information to any gentleman whatever.

Mr. CHESTER proceeded to contend that the question ought not now to be discussed. It was imagined on the last occasion that the matter was settled, and they left the room with the idea that they had done that which was valid and correct. If it was to be disputed, it should have been contested on that occasion, and not now. A revision of the bye-laws would remove all difficulties in future [hear, hear]. There were two other questions which had occupied his attention in consequence of what took place at the last meeting. They were—first, the state of the gardens at Chiswick; and, secondly, the gardens at South Kensington. He could not but feel sure that the Council must have satisfied themselves that a very large proportion of the Fellows of the Society were very much dissatisfied with the state of the gardens at Chiswick [loud cries of hear, hear]. He thought that upon the last occasion they did those gardens an injustice. They were then taken by surprise, and those who spoke of the gardens at Chiswick ought to have distinguished between the two parts of those gardens. They would all agree with him, that that part of the gardens where the experiments were tried and the kitchen garden was situated, could not be kept in a better condition [hear, hear]. That had nothing to do with the other part of the gardens. The poet had said—

“Where desolation saddens all the green.”

It was in that part of their beautiful gardens, where they used to hold their great *fêtes*, that the Council had allowed

that condition of desolation to arise. They were told at the last meeting that the Council had not the funds to keep those parts in better condition. One gentleman said they had not £10 a-year to spend on them. He repudiated that, as they ought to keep the whole of the gardens in good order [hear, hear]. The amount of money to be spent upon them is to be regulated by the Council. The resolution which he had to propose on that subject was as follows:—"That the whole, and not merely, as at present, a portion of the garden at Chiswick be kept up in good order; that increased facilities be afforded there for instruction in scientific and practical horticulture; and that the Council be requested to prepare a suitable scheme for effecting this object, and to submit their scheme to a general meeting of the Fellows as soon as may be." He felt that it was desirable that the gardens should be made available for the purposes of the education of the gardeners, as was originally intended. They must agree with him that it was desirable they should have a school of scientific and practical horticulture. But it had been suggested that the term "school" should not be used, as it might imply that a large outlay would be required to carry out anything like a collegiate institution. He had, therefore, framed his resolution in the words in which he had just read it to the meeting, and he hoped it would be unanimously passed [hear, hear]; for it was most desirable that the whole, and not merely, as at present, a portion of the gardens should be kept in good order, and that there should be increased facilities afforded for instruction in scientific and practical horticulture [hear, hear]. He felt so strongly on that point that he hoped the Council would deal with it as soon as possible, and bring before the Fellows a suitable scheme for effecting this object. It was with that view that he must say he felt bound to press his resolution to a decision [hear, hear].

The CHAIRMAN: It may save the time of the meeting to state that the Council have already passed a resolution upon that subject. The resolution was only passed to-day. It is as follows:—"That a Committee be appointed to consider how the present working of the gardens of Chiswick may be made to conduce to the improved education of gardeners, with instructions to frame a scheme, and the estimated cost for carrying it into effect, having reference especially to the experience of the past efforts of the Society in this direction. The names suggested to carry out the scheme were Mr. Chester, Sir W. Dilke, Mr. Fortune, Mr. J. Lee, Mr. Moore, Mr. W. Paul, Mr. Rivers, Mr. Veitch, Sir Joseph Paxton, with the President, Secretary, and Treasurer as *ex officio* members" [loud applause].

Mr. CHESTER said he was very much obliged to the Chairman for the interruption upon that point, and he would not say anything more upon the resolution he had intended to propose to the meeting [hear, hear]. Passing on to the next point he came to the gardens at South Kensington, and certainly a large amount of dissatisfaction was expressed at the last meeting as to the condition of those gardens. That had created dissatisfaction everywhere. He did not wish to blame the Council, but he wanted to impress upon those gentlemen the necessity of improving their condition, and he thought it would do good if the matter were still further pressed upon them [hear, hear]. It was necessary that the full and comprehensive scheme which had been laid down by their late lamented President should be carried out, and in that case there would be brought to the Society a large number of Life Fellows, and a large number of debenture creditors [hear, hear]. He thought they were obliged to carry out that scheme. Every large scheme with which the much-lamented Prince Consort was connected had suffered a great loss by his death, and the Royal Horticultural Society especially so [applause]. They must make the best of their position. He did not wish to impute sinister motives to the Council; he gave them great credit, especially as they had lost their "great head," and, in a lower degree, their "heads" also. With regard to the communication from Her Majesty's Commissioners, he thought it was not right that they should require £2000 to be expended upon the annexes; and he also objected to the plans for the opening of the arcades. It was a great mistake, but some thought it desirable. He should not oppose the report of the Council upon that point. Whatever the difference of opinion might be upon the advance offered by the Royal

Commissioners, he thought that it would be very unseemly to refuse it, and cause the Commissioners to be very chary as to how they offered the Society any assistance in future. He was sorry for the proposed expenditure of £2000 upon the annexes; but they now had £11,000 to expend in the improvement of the gardens at South Kensington, and he hoped that the Council would see that it was well laid out [hear, hear]. He thought that they should get rid of all unnecessary stonework, and what were termed works of art [hear, hear]. There was a great deal in the gardens that had no connection with them, and had no business theret. If they had busts of great horticulturists and botanists it would be a different thing. They might have the busts of such men as Dr. Lindley, of the Presidents, of the late Prince Consort, and the Duke of Buccleuch; but they should not have busts of men who had no connection with horticulture [hear, hear]. If they were to have works of art, let them have works of art; but some of the things in the gardens were perfectly hideous [laughter, and hear, hear]. The grounds, which were already ugly, were made uglier still by those things [hear, hear]; and in connection with that he objected to the payment of £500 a-year for the so-called works of art. He felt quite sure that if they followed out the original prospectus of the late Prince Consort, or if His Royal Highness had lived, the £500 would never have been allowed for works of art. It was said that they had not £10 to spend in improving the gardens at Chiswick. Would it not be better to spend the £10 for that purpose, and only devote £490 to the works of art? [laughter, and hear, hear.]

Sir WENTWORTH DILKE said he thought that some misapprehension existed as to the agreement between Her Majesty's Commissioners and the Council. It was not the fact that the Council had to pay the sum of £500 per annum for works of art. The object was to get together as large a quantity of sculpture as they possibly could, and as cheaply; and it was thought that the best plan was to get the sculptors to make exhibitions of their works of art at certain periods of the year. It was purely a pounds, shillings, and pence consideration, and the Commissioners had nothing to do with it. He was of opinion that there was also great misapprehension as to the motives of the Council in promoting the science of Horticulture. That was their great object [hear, hear]. There was another question upon which he wished to speak, and that was with regard to the lectures as proposed on the last occasion. The Council had passed resolutions upon that subject. It was intended to obtain the services of most eminent men to deliver lectures, and this arrangement would be found to give great satisfaction [hear, hear]. His friend Mr. Bateman, had promised to give them his experience with regard to cool Orchids [hear, hear]. There was one other point—he wished people would not mutter and murmur but speak out [hear, hear], and tell the Council what it was they wanted. All their suggestions would be duly considered, but if they were not made the Council could not guess what was wanted. The other day a letter containing some suggestions appeared in one of the journals, signed "An Old F.R.H.S.," a most valuable member. At the next meeting after that appeared, notice was given that the subject would be discussed at the next meeting. That was quick enough, surely! He wished Mr. Rivers had spoken to the Council himself. The Council were willing to adopt a dozen suggestions if they were made to them [hear, hear].

Mr. CHESTER was very glad to hear that the £500 per annum for works of art was a mistake. He objected to that part of the report of the Council in which they doubted the permanency of the occupancy of the gardens at South Kensington by the Society. He did not like them inviting the Commissioners of 1851 to abandon and modify their existing arrangements at the end of three years. The question was, whether the Council intended to go on with the Society, or whether they had any secret scheme at present unknown to the members of the Society. He hoped that, in adopting the report, the Council would carry out the scheme as originally laid down by their late President, both as regards Chiswick and South Kensington [hear, hear]. At the Kensington Road the approaches to the gardens were nothing more than miserable dog-holes, and resembled nothing so much as those old woodcuts of Bewick's of the places where the decoy ducks were put to lead the others in to have their

necks wrung [laughter]. Those who had read Pope would remember that he described the gardens quite happily. In one of his essays Pope says—

"'Tis all a labour'd quarry above ground,
Trees cut to statues, statues cut to trees."

But they might slightly alter those lines and say—

"Dust glares at dust, each fish-pond has its brother,
Each flight of steps leads only to another."

[great laughter]. He would conclude by moving the following resolution, and then if the Council did not object to it, he would submit one relative to the revision of the bye-laws:—"That the report of the Council be adopted, and that they be assured, and requested to assure Her Majesty's Commissioners, of the cordial support of the Fellows in realising as far as possible, both at Chiswick and at South Kensington, the comprehensive scheme for the Royal Horticultural Society, which scheme having been proposed by our lamented President the Prince Consort, accepted by the Commissioners, by our Society, and embodied in Her Majesty's charter and the agreements founded thereon, has already led to a large expenditure, and has induced great numbers of persons to become Fellows of the Society, Life Fellows, and debenture creditors." He could not say that all in that resolution was necessary, but it would, perhaps, be as well to submit it, as there was an opinion abroad that the Council had an intention of not carrying out the original scheme of the Society. He hoped in the course of his remarks that he had not said anything which had given offence to the Council. Nothing could be further from his intention, as he believed the Council deserved a great deal at the hands of the Fellows for what they had done [loud cheers]. He begged to move the resolution which he had read to the meeting.

Mr. HARWOOD HARWOOD: I beg to second that resolution; but as to the revision of the bye-laws, I do not wish to interfere with that.

The Hon. Judge DES BARRÉS said, before they passed that resolution they ought to consider the manner in which the Council had endeavoured to carry on this most important Society. The Council had more to perform than was generally believed. He thought they were under the greatest obligation to the Council, especially in this respect, for they had done their best, and turned everything to the greatest advantage. Everything tending to the prosperity of the Society had been adopted by them. He thought that they were very much indebted to the Council for bringing forward the correspondence between themselves and the Royal Commissioners, and especially the letter of the 13th of February, which they had heard that day, tending, as it did, to further the carrying-out of the original scheme of the Society [hear, hear]. Of course there was a class of Fellows who were anxious to make suggestions to the Council; but he thought they should be careful in what they brought forward, as the Council would adopt any valuable suggestion, and, therefore, it would only be creating confusion and a waste of time by bringing forward unnecessary matters. As had been stated by the Council, any Fellow could make a suggestion, and, if practicable, it would be carried out. As to the suggestion of the school at the Chiswick Garden, he asked them where they were going to get the money from? [hear, hear]. They talked of carrying out a school of Art, when they were not able to keep the gardens in ordinarily proper order [hear, hear]. The Royal Commissioners had placed every assistance in their power in the hands of the Council, and it was a most important thing that they should now see that the gardens were properly improved. The whole tendency of the acts of the Royal Commissioners appeared to be, that they were doing their best for the success of their property; and he should wish the Fellows to bear in mind that the Commissioners were only trustees of that property, and must act accordingly [hear, hear]. They had offered the Society an advance of the money—the £13,000—only a portion of which would bear interest, and that at a low rate. He thought it would be to the interests of the Society that these matters should be left in the hands of the Council [hear, hear]. He must say that it would have been better if the resolution had been somewhat shorter instead of a dissertation. He felt very well satisfied with the Council, and thanked them for what they had done [hear,

and signs of impatience, upon which the speaker resumed his seat].

Mr. A. F. GODSON said, that with regard to the observation of Mr. Veitch at an earlier period of the meeting, that he had not given any information to any gentleman as to his retirement from the Council, he would give Mr. Veitch the name of his informant in private. With regard to the gardens at Chiswick he thought that they had behaved most unfairly to them throughout. They had had 150,000 plants from Chiswick. Those plants were worth £1500. In the accounts he found that there was no statement of assets and liabilities given. It had been given in some previous years' reports, and he should recommend that it be given in future. All mention of it seemed to him to be carefully avoided. Another thing to which he would direct their attention was the state of the "Journal." Nothing could be more disgraceful to a society than the "Journal" which he held in his hands. It could not be bound up, and the postage for sending it about was double what it need be. He did not want to send it to his brother in India or China to let him know that "good white Turnips were to be got at such and such a place." When he compared the present style of the "Journal" to the "Transactions" which were published in 1843, he thought they ought to be ashamed of themselves to have such paltry trashy stuff. In addition to that there was a great loss upon the "Journal," which should be obviated, and a profit made by the sale of the copies alone [hear, hear]. He trusted that the Council would take the question of the state of the "Journal" into their serious consideration, for he was sure that the only use of the present "Journal" was to be put behind the fire [hear, hear, and laughter].

The CHAIRMAN then put the resolution, which was carried unanimously.

Mr. CHESTER proposed the next resolution, which was as follows:—"That the Council be requested to revise the bye-laws and to submit a draft of amended bye-laws to a general meeting of the Fellows as soon as possible." It must, he said, be evident to all that such a revision as that he proposed would be productive of a deal of good, and prevent much confusion, and, probably, unfriendly feeling in future. The report could not be carried out unless the bye-laws were revised. While he had this opportunity, he would refer to another matter, and that was in relation to the future election of the Council, whether the next vacancy should be filled under the present bye-laws or the revised ones, if they were to be revised according to his resolution. There was a strong feeling that in future elections they should select some of those men who might be called professional horticulturists. He sympathised with that feeling, for he thought there was not a sufficient representation in the Council of that valuable class. He took it for granted that there would be a vacancy in the Council before long, for he did not expect that Mr. Godson could sit there any longer, when he had stated that he stood alone in the Council. When that vacancy, therefore, occurred, he hoped they would select a gentleman belonging to the class of professional horticulturists to which he had referred [hear, hear]. They ought to have such men as Mr. Fortune, or Mr. William Paul, in the Council [hear, hear]. He hoped that the Council would not forget to look at the advantage of having such colleagues [hear, hear]. In conclusion he moved his resolution.

Sir ANDREW WAUGH having seconded the motion, Mr. JOHN SIDNEY SMITH said, with regard to the proposition that the bye-laws should be revised, he thought that such a step would be fraught with much trouble to the Council to make a general revision. Was there any necessity for a thorough revision of the bye-laws? If there was anything wrong it could be pointed out, and thus a large amount of unnecessary trouble would be saved the Council. As he agreed with nearly all that Mr. Chester had said, he regretted that he should have to oppose him on this motion. He would ask Mr. Chester to withdraw that resolution. Sir Wentworth Dilke had said that he objected to people murmuring and muttering, and said that they should speak out at once. He was sure that those suggestions so made would be adopted if they were pertinent. As a young member of the Society he made a suggestion on the last occasion that they should have a series of lectures in con-

nection with the objects of the Society, and he was very happy to hear from Sir W. Dilke that it was the intention of the Council to carry out the suggestion [hear, hear]. He thanked the Council for the very ready manner in which they had acted in that and other matters. His only objection was to the carrying of the resolution, and he, therefore hoped that Mr. Chester would excuse him and accede to his request to withdraw the motion.

Mr. CHESTER said that nothing was farther from his wishes than to do anything disagreeable to the Council. His aim was rather to meet their views and prevent confusion. If the Council wished it, he would withdraw the motion, but otherwise he must press it.

Several members of the Council said there was no objection to the resolution.

The CHAIRMAN said he would read the first of the bye-laws which related to their revision. It stated as follows:—"The new Charter provides that the Council, or any five or more of them, may make bye-laws, and from time to time vary, alter, or revoke bye-laws, and make such other bye-laws as they may think useful and expedient; but in order to be valid, such bye-laws must have been adopted, with or without amendments, at some general meeting of the Society; the votes on such bye-laws to be by open voting, or, upon the requisition of five Fellows, by ballot. In case of open voting, the majority binds the minority; the Chairman may vote, and in case of equality may give a casting vote; and in case of ballot (but not in case of open voting) two-thirds of the Fellows voting are necessary to pass a bye-law, or alteration or repeal of a bye-law."

The resolution was put and carried unanimously.

Mr. STRICKLAND, at some length, proceeded to address the meeting, but was very inaudible at the table. He said that it appeared to him that the chief conduct of the affairs of the Society was in the hands of the Expenses Committee. They had the absolute control of the expenditure of the Society in their hands, and yet that Committee was so constituted that one-half of its members were not connected with, or interested in, horticulture in any way whatever. If that was allowed to continue, sooner or later the fate of the Society must be apparent. He thought that the primary object of the Society was to carry out the practical portion of the science of Horticulture, and that could never be effected so long as persons who were not at all connected with, or interested in, the promotion of that science had the expenditure in their hands. No doubt that was at the bottom of all the dissatisfaction which existed in the Society. He did not doubt but that it was for the benefit of the Royal Commissioners—

The CHAIRMAN said that unless Mr. Strickland intended to conclude with a motion he was not in order [hear, hear].

Mr. STRICKLAND said that it was the very constitution of the Expenses Committee that regulated the operations of the Society; and he would move a resolution to the effect that such an arrangement would swamp the objects for which the Society was formed.

The CHAIRMAN said that the arrangement was according to the agreement upon which they had obtained their charter. The 15th clause of that agreement ran as follows:—"For the purpose of regulating the amount to be retained by the Society in each year for expenses, a Committee shall be appointed annually; which Committee shall consist of six persons, three of whom shall be appointed by the Commissioners, and three by the Society, and any three of such Committee shall form a quorum, so as one at least shall be a person appointed by the Commissioners, and one a person appointed by the Society. Seven days' notice of every meeting of the Committee shall be given in writing to each member of the Committee by a letter to be sent by the post. As vacancies may occur in each year by death, incapacity, or resignation, such vacancies may be filled up respectively by the Commissioners or the Society according as the original appointments were made by them respectively." It was plain that the arrangement was an integral portion of the charter, and, therefore, they must abide by it.

Sir WENTWORTH DILKE said there had never been any difficulty experienced in working the arrangement. When the Committee was formed it looked into what would be the probable demands for carrying on the gardens. In some years the expenditure might be £20,000, and it was

for the Council to estimate what the expenses would be, and if there was anything omitted the Society would have to pay it. With regard to the £200 which had been disallowed, that had not been included by themselves in going to the Expenses Committee. A meeting will be held next week for the estimates of the ensuing year to be submitted. All the members of the Committee are members of the Society, and he thought that many of them were debenture-holders. He might state that the expenditure during the year of the International Exhibition was £17,000, which was asked for in anticipation of the monies they would receive in consequence of the Exhibition; but the average expenditure asked for was only £10,000. If there was anything which was not put down in the estimate, the Society were responsible for it. The composition of the Expenses Committee was a matter of necessity. With regard to the state of the gardens, he might be permitted to state that they were not in so discreditable condition as had been pointed out. The practical part of the gardens at Chiswick was in as fine a state—indeed in a much finer condition, than it was under the old *régime*; in fact all the garden, except the 14 acres of grass, &c., was kept in very good order.

It was stated that the portrait of Dr. Lindley in the room had been subscribed for by the past and present members of the Council.

Mr. BATEMAN said that the guinea subscription for a testimonial to Dr. Lindley had reached £200, although so little publicity had been given to it. They had a splendid epergne now ready for presentation, and some additional subscriptions were needed. He hoped, therefore, that gentlemen who had not subscribed would do so before leaving the room.

Upon the motion of Major-General Sir ANDREW WAUGH, a cordial vote of thanks was passed to the Chairman, and the proceedings were brought to a close.

WINTERING BEDDING CALCEOLARIAS.

ALLOW me to give my testimony to the fact, that the keeping of bedding Calceolarias in cold pits and frames during severe winters is quite practicable in a less genial climate than that of Kent. Having done so for several years with entire success (but I need not detail the process, as it corresponds almost entirely with that often referred to by "R. F." in "Doings of the Last Week"), I venture to say that, had your correspondent in Ireland attended to the said directions, he would not now have to deplore the loss of his plants. Of course no practical man teaches that Calceolarias will bear frost to an unlimited extent in any stage of their existence, but particularly when in a growing state, as those of "Q. Q." must have been if put into a Cucumber-frame during August. Had he delayed this operation until October he would have found less difficulty in preserving them through the winter; although, had he covered them properly, I do not think that the dampness of the climate would have affected them, having known them to be covered up for ten or more days together, and none the worse of it.—L. G., *Bennell, Northumberland.*

At page 132 of THE JOURNAL OF HORTICULTURE, I notice an article from "Q. Q., *Ireland*," expressing a fear that Mr. Robson's advice on the protection of plants in cold frames may mislead the readers of this Journal in Ireland.

I have now been in Ireland four years, and can state from experience that Calceolarias have given greater satisfaction than ever I could obtain from them in England. For example, in 1859, when at Shrubland Park, nearly the whole of the Calceolarias went off in the manner Mr. Robson describes.

The way I manage them is this. In the first week of October I have the frames ready, selecting a dry position. I then place the frames on some bricks to afford a sufficient depth of soil and head-room for the plants as they grow. Round the bottom I place a little litter to keep the soil in, and then fill in to within 6 inches of the glass with old Cucumber and Melon-bed soil, with plenty of sand intermixed. On the top of this, I lay half an inch of river sand and put in the cuttings, keeping them close and dark till

they begin to root. I do not keep the mats on in dull periods, but only in bright weather, as I find that the cuttings never ought to flag, that being very much against their well-doing.

As soon as they begin to root I give them a little air, and increase it till, eventually, the lights are taken off on all occasions, except when frost and much rain occur.

With this treatment I never lose one cutting in a thousand; and all the covering they have is one mat next the glass, or shutters, with plenty of stable-litter on the top, not thrown on loosely, but laid on well and closely by the hands, as double the quantity laid on carelessly would be no more effectual.

I have this morning, February 22nd, been examining my cuttings after a severe night of 21° of frost, with only a mat and 9 inches of litter on the top of the frame, and all in a turf pit—(kinds, *Amplexicaulis*, *Prince of Orange*, *Aurea floribunda*, *Trentham Yellow*, *Prince Albert*, *Golden Cap*, *Sultan*, and *Gem*), and I find them perfectly safe, and looking as though 8° or 10° more of frost would not have reached them.—E. WELCH, *Palace Gardens, Armagh*.

P.S.—I think the cause of the *Calceolaria* doing better in Ireland than in England is the dampness of the climate.

THE ARNOTT'S STOVE.

From time to time I have read in this Journal complaints of the inefficiency of the Arnett's stove in keeping out the frost; and having myself constructed one and proved its efficiency during repeated severe frosts in this part of the country (Manchester), I will describe its construction.

It is placed inside the greenhouse, and is formed of fire-bricks, brick on flat or half brick thick, fire-clay being used instead of mortar. It is 1 foot 6 inches wide each way, outside measure; and 3 feet 6 inches high. The inside diameter of the fire is, consequently, 9 inches across each way.

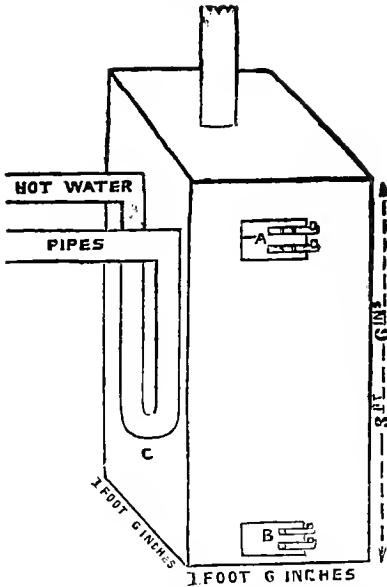

A is the supply-door made air-tight. It must be so to prevent any of the sulphurous gas from the burning fuel escaping into the house. It is placed 9 inches from the top of the stove, so that when you are supplying the stove the gas may ascend above the feed-door and pass up the chimney.

B is the ash-door for taking away the ashes. This door has a hole drilled through it with a small slide across the hole to enable me to regulate the draught so as to prevent the fire burning too quickly.

The furnace-bars are, as in D, the two projecting ends being built into the sides of the brickwork, so as to form a pivot or hinge for them to turn upon; and by placing a piece of iron, as in E, to support them in front, by removing

this the bars fall down in front, and any clinkers, &c., can be removed. The furnace-bars are placed above the level of the door n.

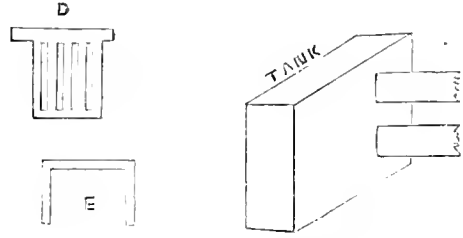

My chimney is formed of three-inch cast-iron rain-pipe, and is carried through the centre of the large tile which is placed on the top of the stove.

The advantage of the feed or supply-door being near the top of the stove is, that after the fire has burnt up you can fill the stove up to the top, and by a careful regulation of the draught at door B, the fire will burn eighteen hours without attention.

If such a stove is placed halfway along the front of such a house—say 20 feet long by 12 or 15 feet wide, it will be quite adequate to keep frost out and the plants slowly growing during the autumn and winter; and by passing some two-inch gas or steam-tubing down and up one side of the inside of the stove the temperature can be raised to that of a hothouse, and it forms one of the cheapest kinds of hot-water apparatus that can be constructed. There is no boiler required, simply the bend of the pipe C passing through the fire, which in the Arnett's stove is always of a bright red heat. The bend should have been represented inside the stove in the engraving. The two ends of the pipe join to an open tank.

I have had a stove of this description in use for some time, and have found it everything that can be desired. The fire burns from twelve to eighteen hours without attention, and the water is always at boiling heat in the pipes. I use the gas-house coke which must be broken small—the size of a walnut. The coke is only 5s. per ton in Liverpool, and a ton and a half will last me the winter and keep the fire constantly going from November to April.—M., *Liverpool*.

THE FLOWER GARDEN.

GERANIUMS.

THE Geranium section of flower-garden plants is now by far the most beautiful and important that we possess; and notwithstanding opinions which have been expressed to the contrary, I am one of those who think that within the last few years it has made wonderful advances in the way of improvement. The new shades of colour, and bold character of trusses in some varieties, have added fresh material of very great importance to the artists of the parterre; while for pot and vase culture for autumn decoration, some of the varieties of recent introduction stand unrivalled among soft-wood plants, whether it be under glass or in the balcony; and, not less important, many of them well managed rank among the most beautiful things for late autumn, as well as for winter and early spring decoration. For richly-marked foliage there are now some so highly coloured and picturesque that they rival even the prettiest products of tropical climes, and this latter class cannot fail to add an important feature in the future make-up of parterres. True, those who only see a good stare in a group of beds may fail to appreciate the tints that those Geraniums furnish, but, as a friend remarked not long ago, "there is more than a stare in a well-planted group of beds." There is in it one of the most delicate studies connected with a gardener's occupation; and if more attention had been paid to the soft and more delicate combinations, our parterres would not have been laid open to the many remarks which their scarlet and yellow fevers have perhaps justly deserved. It is not to be wondered at that the many jumbles of harsh colours too often met with, should have induced the opponents of our summer and autumn parterres to decry the whole system.

Gardeners have now, more largely than ever before, the

material for a superior order of things, and more particularly in the beautiful varieties of Geraniums that are now within every one's reach. From pure white, up through various shades of salmon, pink rose, cerise, orange scarlet, and scarlet of various depths and shades, this one section alone furnishes colour and style of bloom sufficient to make it worth while to have gardens specially set apart for it. Many important additions to it are soon to be made, among the most prominent of which are Lucy Grieve, White Tom Thumb, and a variegated Stella. It is to be hoped that the White Tom Thumb has a bold, dark horseshoe leaf, for such would help greatly to make a white truss most effective.

A great many of the more recently introduced varieties have passed through my hands; many have been discarded as not suitable to the soil and climate, and some of these, I observe from other reports, have done honour to their recommendations when placed under different circumstances. The following is my experience of some of the varieties on a deep rather light loamy soil, resting upon a gravelly subsoil, and in one of the driest districts of the kingdom.

Admiration.—A dwarf compact grower with horseshoe leaf; the flowers are of the richest scarlet, produced on strong stalks, in large bold trusses. Somewhat deficient in bloom in the early part of the season, but makes up by a profusion in autumn. Like many others it ought to be gone over about the beginning of August, and have all the points pinched out of the shoots. This has the effect of causing it to develop its blooms more boldly, and checks the growth of foliage. In pots this is one of the very best that I have seen of its class. In beds scarcely equal to Vivid, but being much more dwarf and compact, it can be used when Vivid cannot.

Amy.—Soft pink, marked with white in the upper petal; well-formed large truss, throwing its blooms well up above the foliage; abundant bloomer. This is a peculiarly soft shade of flower, and I think will take a high position. In pots it is splendid.

Augustina Nivelet.—Pale salmon, margined with white; large compact truss, lasting a very long time in perfection. Particularly valuable for pot culture.

Aurora.—Salmon, with white eye, and very dark horseshoe foliage. Has been discarded, other salmon varieties being preferred.

Baron Hugel.—Well-known variety. Has given place to Little David, as being much superior as a dwarf scarlet, and in all respects very fine.

British Flag.—Though a large bold globe variety, orange scarlet, and a strong grower, this did not prove equal to Glendinning's Scarlet and Prince of Wales of the same class.

Christine.—This esteemed rosy-pink variety has kept its position well, and in Scotland it seems more at home than in the south, where it has a great tendency to the production of seed. It is likely to be superseded by Helen Lindsay in all respects.

Comte de Moray.—Rosy scarlet, pretty; but loose and deficient in the truss. It has been discontinued as not being sufficiently effective.

François Desbois.—White, with pink centre. A very distinct delicate-looking flower; splendid for pot-culture, and though not extensively planted out here, yet it proved very fine in the borders last year. For soft combinations this will be a fine variety.

Lady of Lorretto.—Bright cherry colour, with white eye; centre of leaves yellowish green, belted with a copper-coloured zone; flowers and trusses large. Very fine for vases and pots. When planted out must have a poor dry soil, or it will grow too strong.

Lady Rokeby.—This variety has not come up to my expectations of it. Very good in a pot. Out-doors in the open border it does not flower sufficiently freely to make it valuable as a bedder. It is a pretty rosy scarlet.

Madame Chardine.—Salmon pink; immense trusses in great abundance. The finest of its class that I have seen either in pots or beds. The soil should not be rich, and, as recommended for Admiration, its tops should be pinched off. In autumn it is most splendid. I have had rows of it like a row of Hydrangeas.

Madame Vaucher.—White, with red stamens; fine truss;

dwarf compact habit. In pots it is unique. Last year it was very fine in beds here. It is peculiarly lively when edged with Purple King Verbena. If White Tom Thumb is better than this it will add a fine feature to our flower gardens, for fine white-flowering plants for beds are scarce.

Monsieur Paul l'Abbé.—Very superior, with salmon scarlet globular trusses in great abundance, and thrown up well above the foliage. I prefer this to Mons. Martin, which it much resembles.

Carminé Nosegay.—Did not prove worth growing here.

Imperial Crimson.—Very pretty. Cammine shaded with purple. Abundant bloomer. Compact and dwarf, but on account of the want of substance in the flowers it is so easily spoilt with moisture in autumn that it has been discontinued.

Stella.—What shall we say of this? It cannot be too highly recommended. No other of the Nosegay section that I have ever seen can equal or approach it. At one time I thought Triomphe de Paris was going to run the race in favour with this, but last year Stella proved far superior. A bed of this, last year particularly, was here perfectly wonderful from the abundance of immense trusses of bloom. It is a fine hardy variety, easily wintered and managed. Colour crimson, with dark horseshoe foliage.

Perfection.—Most brilliant scarlet; flowers and trusses large and well elevated above a fine, rich, dark green foliage. This I consider the best of its class, far surpassing Tom Thumb and Frogmore, or any other of that style that I have seen.

Prince of Wales.—Orange scarlet truss, very large and globular; most profuse bloomer. Well adapted for back lines and large beds.

Princess of Prussia.—Does no good out-doors here; but very fine as a pot variety. Out-doors the flowers, owing to their dark colour, turn very much, and it does not bloom profusely enough except in pots.

Rosy Queen.—Much like Christine, but rather lighter in colour and grows stronger. In dry seasons it is not so prone to seed as Christine, and in this respect it is more desirable and not inferior in any other point. In pots Christine has no chance whatever with it.

Rubens.—Dark rosy pink; flowers and trusses large; foliage beautifully and softly tinted. Suitable for large beds and back lines.

Rubens Improved.—Recently introduced, and not so much liked as the old Rubens.

Trentham Rose.—Salmon scarlet. Most wonderful bloomer. Perhaps no other Geranium of any other class has kept its place so well as this. I do not know of any of the same colour to surpass it.

Vivid.—Deep scarlet with small white eye; flowers very large and finely formed. Most abundant bloomer. This is altogether a magnificent bedding Geranium—quite a companion to Stella in a different class. It is grand in this locality. Fine for pots also.

Glendinning's Scarlet.—A most extraordinary Geranium for size of truss; orange scarlet with horseshoe leaf. In a dry season this is just like a bed of scarlet Hydrangeas, so large and bold are the trusses. Fine for back lines and very large beds.

Barnton Beauty.—Scarlet with large white eye. Resembles Vivid, but inferior to that fine variety.

Frogmore Improved.—Does no good here, though a fine variety in some localities.

Little David.—Cannot be too highly spoken of. Fine scarlet, very free bloomer, very dwarf, which makes it most suitable for small beds, front lines, and edgings.

Leoni.—Cherry colour. Resembles Lady of Lorretto, but is a little darker. A very fine pot variety, few better. Has not been sufficiently proved out-doors to form an opinion of its bedding qualities.

Herald of Spring.—A soft rosy scarlet; large well-formed flowers and truss. Most excellent pot variety, but does not bloom very freely planted out.

Emperor of the French.—Orange scarlet; very neat, compact grower; leaves beautifully zoned. Fine pot variety.

Victor Emmanuel.—The largest truss of any of the recently sent-out ones. Bright scarlet, and splendid in pots. Not yet proved it planted out.

Triomphe de Paris.—In the way of *Stella*, but not so good as that variety.

Lord Palmerston.—A dwarf, compact-growing Nosegay variety, with immense trusses of purplish blooms. I have not proved this in beds yet, but will do so this season, and have great hope of its proving a first-class kind.

HeLEN Lindsay.—This is a deep pink variety like *Christine*, but much superior both in colour, truss, habit, and foliage, and will, I have no doubt, prove the best of its class yet out. In pots I have seen nothing in its way to approach it.

Spread Eagle and *Merrimac* are two varieties that I have not had so much experience of as to be able to give an opinion of them. They are very pretty in pots.

I will now turn to the variegated section, among which are some varieties of great excellence; and some of the more recently introduced sorts are really so pretty in pots, that should they fail to prove all that is expected of them in beds, they must still be looked upon as very desirable acquisitions.

Argus.—Flowers bright scarlet, large trusses; leaves green centre, with dark zone margined with pinky white. This, though a free-flowering variety and a good grower, is too dull in the leaf to be effective.

Bijou.—This is a beautiful and most useful variety, having large margins of silvery white to the leaves. Is a vigorous grower, and blooms with great profusion, which in conjunction with a robust constitution renders it a most useful sort. We plant two thousand of this.

Countess of Warwick.—This is a good old sort, and still a favourite. There is, however, a dullness about the foliage which makes it only a second-rate variety.

Cloth of Gold.—This is Golden Chain magnified, with much larger and smoother leaves, with flowers precisely like Tom Thumb, more vigorous than Golden Chain, and having a more robust constitution. In places where Golden Chain does not thrive I would recommend a trial of this. It is in all respects first-rate.

Flower of Spring.—This is a great favourite. It is the best variety I know for growing as edgings to the dark-zoned varieties, as it has a peculiarly soft lovely appearance from the flatness of the leaves, and their extra broad margin of white. The flowers are a bright cerise. This is a very fine bedder.

Golden Yase.—Leaves green, with a dark zone surrounded with a broad margin of yellow; flowers cherry red. This, though lovely, is now completely eclipsed by the gorgeous *Mrs. Pollock*.

Hendersoni.—Leaves broadly margined with silvery white; flowers bright scarlet; trusses large, and produced in great abundance. The habit is stiff and compact. I consider this a great improvement on *Alma* and *Annie*, and one of the very best.

Meteor.—A very dwarf and compact grower. Flowers vivid scarlet. For edgings and small beds it is good, and is very fine in pots, but not so generally useful a variety as *Hendersoni*.

Mrs. Pollock.—This is the most striking and picturesque *Geranium* yet out. If it never flowered its foliage is so lovely that it could not fail to please; but it has, in conjunction with fine foliage, a fine truss of scarlet bloom. In the leaf there are zones of beautiful bronzy red, bright crimson, green, and gold. It is a fine, free grower, and cannot fail to be a plant that will be generally and largely grown both in pots and beds.

Queen of Queens.—This is one of the few gems recently sent out, and is well named, for it is a queen among dwarf variegated *Geraniums*. The leaves are margined with a broad belt of clear white. The habit is dwarf and dense, and the amount of bloom, of the deepest scarlet, it produces is perfectly wonderful. We had it planted out last year, and look for great results from it.

Silver Chain.—This is the same as another variety grown here as *Mary Ann*. The habit is sturdy and compact; foliage beautiful; blooms cerise.

Golice Fleece.—Discarded as being so much inferior to *Cloth of Gold*.

The Bouquet.—Worthless here.

Variiegated Stella.—This is a sport from *Beaton's Crimson Stella*. The foliage is splendidly variegated, whiter than *Bijou*. Blooms, of course, the same colour as *Stella*, in im-

mense trusses. Both in pots and planted out this is a glorious variety, and will add a feature to flower gardens.

Sunset.—Very much like *Mrs. Pollock*. The bloom is inferior, but the foliage is about the same; but it is a more tender sort.

D. THOMSON.

SHRUBBY CALCEOLARIA.

(Concluded from page 97.)

In the latter part of May or beginning of June move the plants to their final quarters. It will only be necessary to take the soil out at one end of the bed to the depth of about 6 inches, and then thrusting the spade under them 6 inches below the surface, the plants will be raised with square balls 6 inches on the side. The beds in which they are to be planted should have been dug deeply during the previous autumn, and laid up rather roughly for the winter. In the spring following they should be dug or forked, and a few inches of vegetable or fresh mould worked in. If, however, the beds have been occupied with early-flowering plants or bulbs, some fresh soil should be added, and they should then be forked over and the soil broken. In those beds plant at 1 foot from the outside, and allow the same distance from plant to plant, arranging them in quincunx fashion. Water copiously and shade for a few days if the weather be dry and hot, and gently sprinkle the plants overhead towards night, which will restore the loss their leaves experience in the day time, when they have not roots sufficient to collect nutriment to supply the wants of the leaves. However, plants raised in this way rarely experience any check from transplantation, for having a multiplicity of fibres they soon leave the ball and pass into the new soil, and do in a week what it takes plants from pots a month to accomplish.

When the plants are established in their new quarters, if you are desirous to attain several objects at once, give a thorough soaking with water, and then cover the surface of the beds with cocoa-nut dust, which will prevent evaporation from the soil, improve the appearance of the beds—for red always contrasts well with green foliage—and by autumn become a manure, which, if neatly forked in, will be very suitable for growing anything in. Two inches of this covering will save an immense amount of labour; and about an inch of old Mushroom-bed manure spread on the beds answers the same purpose. They both decompose, emit ammonia, form humus, absorb moisture because porous like a sponge, and keep the plants cool, from being non-conductors of heat. After this the plants will need regulating occasionally, trimming off irregular and gross growths and spent blooms, and watering in dry weather. All this trouble to raise one of *King Croquet's* subjects! Well, it really is fatiguing, but not half so much so to carry out as narrate. There are many other ways of raising *Calceolarias* for the flower garden. Of these I will describe two.

Prepare some cutting or seed-pans 3 or 4 inches deep, allowing an inch of drainage, and then fill with a compost of loam and leaf mould in equal parts, with an admixture of one-sixth of silver sand. Insert the cuttings as near each other as possible without cramming them in so closely that the leaves lie one upon the other. In that case they would damp. Give a slight sprinkling of water to settle the soil about the cuttings, and place in a corner of the greenhouse which must have the air rather moist but not wet, and ventilation must not be given in that part, nor should the sun be allowed to shine so powerfully upon them as to cause them to flag. They will strike in about six weeks, when they may be removed to a dry cool part of the greenhouse and kept near the glass, giving them water sufficient to preserve them in a healthy state. The cuttings may be put in from the middle of September until the latter part of October. Some pot the cuttings immediately after they have struck, but that is only so much labour and room thrown away. The plants will keep just as well in their cutting-pots until the February or March of next year, when they are to be potted into 48-sized pots in a compost of loam and leaf mould in equal parts, with a sprinkling of sand. The plants are to be watered sparingly until growth commences, keeping the air closer and moister for a few days to encourage the formation of roots, afterwards they

are to be well supplied with water at the root, giving all the air possible, placing them near the glass, and syringing them occasionally in dull periods, and morning and evening in fine weather. The less fire heat applied the less subject are these plants to the attacks of green fly, all the heat required being to dry up damp, to cause a circulation of air, and to keep the temperature between 35° and 45°.

In April the plants should be potted into 32-sized pots in the same compost as before, and if they have been duly attended to they should be shifted into 24's or six-inch pots by the beginning of May. People complain of Calceolarias dying off and going back after being planted out; and well they may, when we consider that for two months, and oftener for six, the roots have been cramped in small pots, demanding nothing short of an inch of rainfall daily to supply their wants. In addition to this we have the water poured on the stem, which is not the proper treatment for softwooded plants. When such plants are turned out they take to the situation very badly, they feel the cold of the soil, the loss of the daily watering, and the spongioses receive so sudden a check that they remain inactive for weeks if they do not altogether perish; the leaves for the greater part turn yellow, and some plants die off altogether, canker having attacked them. More deaths result from cramping plants in small pots than from all the diseases to which Calceolarias are liable. Cramping is injurious to free growth, and plants subjected to it rarely grow freely afterwards.

Another way is to plunge some plants in six or nine-inch pots quite up to the rim in the open border in summer, and to take them up in the autumn, remove all roots that push outside the pots, and after washing the latter to place them in the greenhouse. The plants will grow freely in a temperature of 45° as a minimum, and 55° as a maximum, and by February they will afford a number of cuttings. These are to be taken off about the middle of that month, inserted in pans or pots as described before, and the pots placed in the warmest part of the house, covering them with a bell-glass. Shade from bright sun by a paper or some such covering. The cuttings will strike freely without bottom heat—in fact, better without than with it. Those who can command the moist atmosphere of a propagating-house will not hesitate to put the cuttings in there, and so obtain a plant in a few days. Any leaves affected with damp are to be removed, as they would, if allowed to remain, destroy the cutting. When the cuttings are rooted they are to be potted into 60-sized pots, and kept close for a few days until fresh roots are formed, when they should be gradually hardened-off and removed to a light airy place in a pit, frame, or greenhouse. If there be such a convenience as a frame, by all means plant them in it, the trouble of watering will be diminished, and the certainty of their doing well after planting out will be increased fourfold. If on the other hand it is impossible to do this, shift them into 32-sized pots in April and plant out in May, in cloudy weather if possible.

2nd, *For the Conservatory or Greenhouse.*—Select in March some of the most forward and best plants from the autumn-struck cuttings, and pot them into 24's, assuming them to have been in 32-sized pots. Place on a shelf near the glass, and as the shoots grow nip out the leaders of the upper shoots, pegging the lowest down so as to feather the plant down to the pot. A month after this pot into 18's, using a compost of loam from turves one half, and leaf mould and cowdung two years old, in equal proportions, the other half, chopping the whole somewhat small with the spade, but not sifting it, and add a liberal sprinkling of silver sand. Provide good drainage. After potting give a moderate watering; place the plants in a pit, near the glass, syringing them lightly morning and evening; and keep cool, and admit abundance of light and air, without exposing them to currents of air or to frost. Fumigate on the first appearance of green fly, and keep duly supplied with water at the root. In May transfer them to 12's, and plant them out, or rather plunge the pots in the open border. Some of the plants, however, are to be placed in the frame, and attended to as before, air being freely given them, and the irregular and gross growths stopped or removed; these will flower in July and August, and will make quite a rich display in the conservatory. If the plants have been kept cool and well ventilated no sticks will be necessary; but if they are required, put them in so that from a casual observer they may be hidden by the foliage.

The plants in the borders are to be duly supplied with water, and the flower-stems removed as fast as they appear. In the latter part of September take the plants up, and place them in a close frame, and shade from bright sun for a few days. When they have recovered the check consequent on taking up, pot into No. 6-sized pots, in the compost mentioned before, securing perfect drainage, and place them near the glass in a cool airy part of the greenhouse. Water sparingly during the winter, and pick off all decayed leaves. Peg down the lowest shoots, and regulate the others with sticks if it cannot be done without, so as to admit air and light equally to all parts of the plant. Weak or otherwise useless parts are to be removed. In February shift into No. 4-pots, and after this sprinkle with water from a fine-rosed syringe. Continue to peg down, and tie out the shoots as the plants advance in growth. By the middle of April we may expect the appearance of the flower-stems, and even before that time some will be seen, but all straggling blooms are to be nipped off prior to the middle of April. After this, water twice a-week with guano water, 1 oz. of guano dissolved in a gallon of soft water. By May we shall have plants little less than 3 feet through, 2 feet high, and when well flowered, producing from fifty to a hundred flower-heads, each of these having nearly fifty blooms. Talk about "nothing like Geraniums for making a show," why one of these Calceolarias would not be eclipsed if placed beside one of the very finest show Geraniums.

Shrubby Calceolarias are raised from seed to obtain new varieties, they being treated in the same way as lately described for herbaceous Calceolarias, only the seed is sown in the spring.

There is also a new race of Calceolarias which have sprung from a cross between the herbaceous and shrubby species. They have a half-shrubby habit, and are neither one thing nor the other, and for my part I think little of them, for they are of bad habit, and the flowers are far from being of a good form. They require the same treatment as the herbaceous section.

The following is a list of some of the best sorts; those marked with an asterisk being the best for bedding purposes. The others make handsome pot plants:—

- **Angustifolia globosa* or *A. superba*, bright primrose, dwarf habit, and excellent bedder.
- Aebbar, yellow ground with brown blotch.
- **Amplexicaulis*, lemon or straw colour; only suitable for large beds.
- Aurea floribunda*, dwarf and compact habit, trusses large, of a bright orange yellow colour. Makes a fine bed.
- **Canariensis*, bright canary yellow, flowers large, produced in large compact heads; habit dwarf and compact. Very fine.
- **Cloth of Gold*, bright golden yellow, very dwarf, compact trusses, and very free blooming.
- Etna*, crimson tinted with scarlet. Extra fine for pots, making also a good bed.
- Gem*, orange brown, yellow belt. Fine for pots.
- Comet*, bright bronzy crimson. Best for pots.
- Firefly*, intense orange scarlet, habit dwarf, flowers large but not of the largest size, free-blooming.
- Magnificent*, large deep orange flowers, borne on short flower-stalks. Dwarf and dense habit.
- Magnificent* (old variety), rich crimson, yellow cap. Large and fine flower.
- Magnificent* (Henderson's), crimson. Large and fine. What trouble such a similarity of names causes!
- Masterpiece*, large, crimson, extra fine; habit good, and free-blooming.
- **Integrifolia*, small flowers in large trusses; habit dwarf, free-blooming, foliage small.
- Prince Louis of Hesse*, rich crimson, very dwarf, and profuse-blooming. Flowers rather small but very showy.
- Princess Alexandra*, rich orange buff, dwarf and free-blooming. Quite a novelty in the way of colour.
- **Kentish Hero*, orange buff. Free and effective.
- Novelty*, the first bedding variety that can boast of being a good-shaped flower, straw colour, habit dwarf and compact.
- **Kayi*, a good old dwarf early yellow.
- **Prince of Orange*, bright orange brown, fading to light orange; habit very dwarf. An immense bloomer, therefore fine bedder.
- Sparkler*, crimson brown, bright yellow cap. A very handsome variety.
- **Victor Emmanuel*, fine scarlet, faintly spotted with crimson, habit good. Extra good for pots or beds.
- **Yellow Gem*, fine yellow. Dwarf and free.
- **Yellow Prince of Orange*, very bright yellow, and dwarf. Fine bedder.
- **Sulphurea splendens*, fine form, bright yellow, good habit.
- **Beauty of Montreal*, bright crimson, small flower, but effective for bedding.
- Leopard*, straw yellow, densely spotted with maroon.
- Sultan*, a tall but fine crimson.
- Lord Clyde*, et ret, quite a novel colour. Dwarf and compact.
- Sunset*, yellow, blotched and spotted with brown. Very showy.

G. ABBEY.

MUSSETT'S APPARATUS.—*A. L. C.* would be obliged if any one could give her, from his own experience, some informa-

tion respecting Mussett's portable hot-water apparatus. Is it effectual not only for merely keeping out frost, but for forcing purposes?

TRAPS FOR MICE.

I AM rather surprised that Mr. Robson recommends the figure-4 trap as the best trap for mice. It is very good no doubt, but the labour of resetting it after each capture is

considerable, whereas the old Devonshire plan, which we adopt and which is by far the best I have ever seen, requires but little attention. After we have sown our Peas, two or three 10 or 12-inch flower pots with the bottoms well stopped with clay, or better still made without holes, are plunged between the rows, filled half full of water, and well greased inside about 2 inches below the rim. In this way I often catch a dozen in one pot without the least trouble, except adding fresh grease when the old is eaten away.—JAMES HARRIS, *Gardener, Machen Rectory, Newport, Mon.*

PUTTERIDGE BURY.

(Continued from page 115.)

THE position of the avenue of beds will be seen from the outline plan, page 114, only the avenue is straight for more than half its length at the east end, instead of being bent so

soon as shown. The walk opposite the beds is flanked with vases. The grass between the beds is more than 20 feet wide.

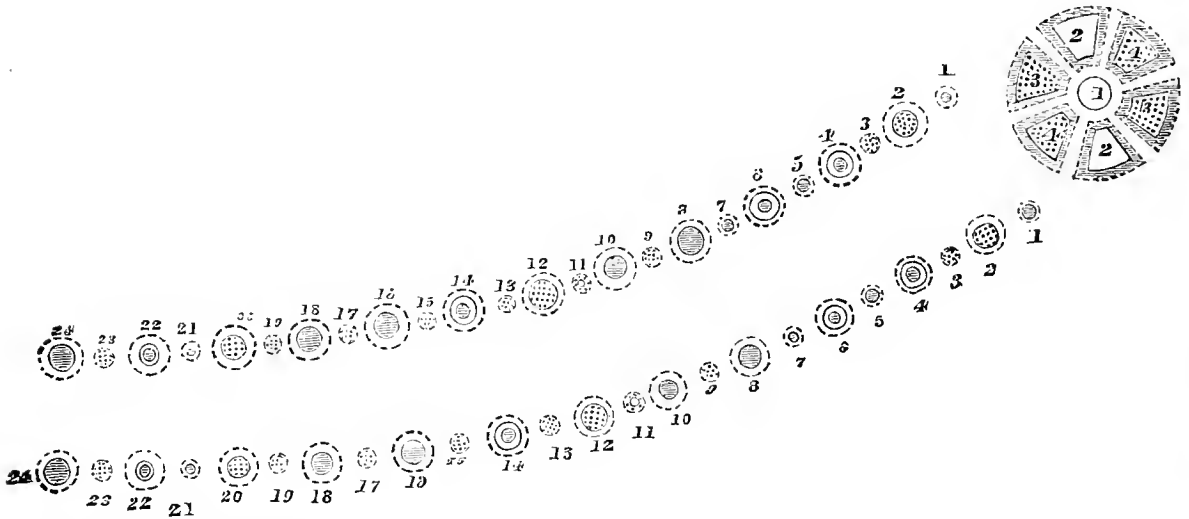

We now give this bed-avenue more in detail. There are twenty-four beds on each side, twelve large and twelve small. The large are fully 10 feet in diameter of circle, the less ones are from 5 to 6 feet in diameter. These were all planted in the pyramidal style. The beds were considerably raised, but the height in the centre was mostly owing to taller and larger plants being used for the centre. The height of the pyramids from the grass ranged from 5 to 10 or more feet, the lowest pyramids being at each end, and the tallest in the centre of the avenue. The opposite beds were planted alike. Most of them had several rings of colour quite distinct, and yet close to each other. In some cases different kinds of Verbenas, Lobelias, Alyssum, &c., had been used as ground colour, so that if an inch or two of a break should occur, it would be covered by a sprig or two of these things. These fine pyramids made a good contrast to the more level planting in other places.

Beginning at the west end next the beds with chains of Roses over them, the following is the arrangement of planting, the plants first named being the centre of the pair of beds, and the last named the edging. The first named is a small circle, and the second and the last are large circles:—

- | | |
|--|--|
| <p>1, Large mass of Belle de Florence Rose, edged and festooned with Pearl Nasturtium.</p> <p>2, White Fuchsia, Boule de Feu Geranium, Golden Chain ditto, Lady Plymouth ditto, with a few sprigs of Variegated Alyssum. Very rich.</p> <p>3, Large Pink Geranium Perfection, white-leaved Geranium and Perilla mixed, Forget-me-not, and Enothera prostrata.</p> <p>4, Fuchsia Banks's Glory, Calceolaria Mrs. Booth (rich blotched),</p> | <p>Calceolaria Robert Burns (like Prince of Orange), Calceolaria, Yellow Prince of Orange, edged with Forget-me-not and Lobelia.</p> <p>5, Acacia, Red Rover Geranium, and dark Indian Pink.</p> <p>6, Pink Nosegay Geranium, Salmon Nosegay ditto, Mrs. Colville ditto (purple), Old Scarlet Variegated, Hackness ditto, and Golden Chain ditto.</p> <p>7, Ricinus Obermanni, Dark Heliotrope, and Verbena venosa mixed, and Gazania splendens.</p> |
|--|--|

- | | |
|---|---|
| <p>8, Cassia corymbosa, Rubens Geranium, Cineraria maritima dotted with Alyssum.</p> <p>9, Rose Belle de Florence, and Eclipse Nasturtium.</p> <p>10, Brugmansia suaveolens, Salvia fulgens, Ageratum mexicanum (tall), Calceolaria amplexicaulis, dotted with Amaranthus melancholicus, Calceolaria Prince of Orange (yellow), Lobelia speciosa and Variegated Alyssum.</p> <p>11, White-coloured Fuchsia, Calceolaria Crimson King, Verbena venosa, and Enothera prostrata.</p> <p>12, Geranium Excellence, Golden Chain ditto with flowers off, Forget-me-not, and Verbena pulchella.</p> <p>13, Ricinus Obermanni, with Verbena Surprise growing through it, Amaranthus melancholicus and Mangelsii Geranium mixed, skirted with Verbena Manetti.</p> <p>14, Large Fuchsia (dark), Mrs. Colville Geranium, Jackson's Variegated, Scarlet Nosegay Geranium, Old Scarlet Variegated, Hackness ditto, and Golden Chain.</p> <p>15, Cassia corymbosa, Geranium Red Rover, and Gnaphalium labatum.</p> | <p>16, Brugmansia Knightii, Salvia fulgens, Ageratum, Calceolaria amplexicaulis, Calceolaria Aurea floribunda, and blue Lobelia.</p> <p>17, Rose Belle de Florence, old strong variegated Verbena, and Cerasium tomentosum.</p> <p>18, Cassia corymbosa, Calceolaria amplexicaulis entwined, Scarlet Geranium, Cineraria maritima, dotted with Variegated Alyssum.</p> <p>19, Ricinus, Cannas, Heliotrope, and Tropaeolum elegans.</p> <p>20, Large Pink Geranium, Cerise Unique ditto, Flower of the Day ditto, and Verbena Manetti.</p> <p>21, Crimson Unique Geranium, and Gazania splendens.</p> <p>22, Fuchsia Banks's Glory, purple Pentstemon, purple Calceolaria, Prince of Orange Calceolaria, Aurea floribunda ditto, and Verbena pulchella.</p> <p>23, Acacia (fine foliage), Maurandya entwined with it, Geranium Sidonia, and Verbena pulchella for edging and covering ground below Geraniums and peeping between them.</p> <p>24, Light Fuchsias, light Pentstemon, Scarlet Globe Geranium, Bijou ditto, Cloth of Gold ditto, and Nyctelia selaginoides.</p> |
|---|---|

The opposite twenty-four were exactly the same. The planting of the circle at the end of the avenue was as follows:—

- | | |
|---|--|
| <p>1, Pyrethrum grandiflorum, edged with red Nasturtium.</p> <p>2, 2 Mrs. Helford Verbens, edged with Mrs. Mildmay Verbena.</p> | <p>3, 3, Purple King Verbena, edged with Aurea floribunda Calceolaria</p> <p>4, 4, Lobelia Linton, edged with Manetti Verbena.</p> |
|---|--|

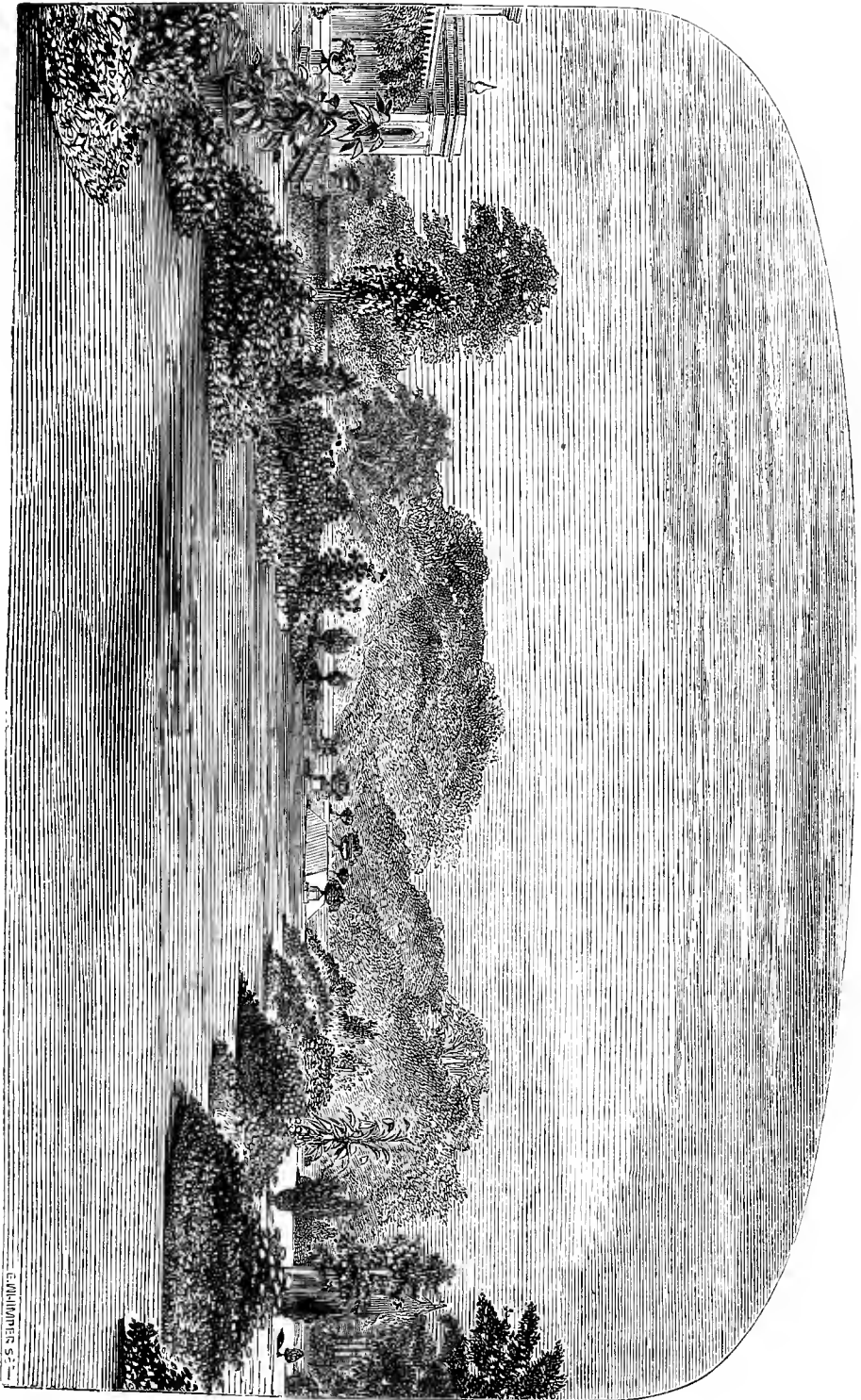

View of Avenue.

The above engraving represents a portion of the east end of the bed-avenue, the back of the spectator being to the west.

E. MILLNER S.C.

A BORDER RAID.

I SHOULD like now to say a few words upon the subject of planting flower-beds and borders, noticing the different opinions that have been expressed in this Journal, and giving my own views upon this very interesting subject. I would approach this discussion in the best possible spirit, and if the knight (Church militant, for once and once only) must tilt, I would wish him to enter the lists mounted on that worthy steed, "good nature," and having at his side a sword of good temper. As our worthy commander-in-chief has it, "Touch the shield with the blunt end of the lance merely," for it would give me, as it would give him, pain, if it were touched with the sharp end, indicative of mortal combat. My aim is far other than sharp writing or fault-finding. I will not trust sore at my adversaries, or rather and far better, friends who take other views. None shall stand over the corpse of one, and moralising say—

"Alas! the pity,
Here lies F. Chitty."

Nor will it be necessary for me to telegraph to the relations of another—

"Haste and see,
Thomson dee (D.)."

In spite of our little differences, there is a great oneness among us as writers in this Journal; who can doubt it? Thus we all love flowers, and we all wish to uphold the character of this periodical for gentlemanliness. We chiefly differ as to the way of making the best of our favourites—whether in this way or that way they look to the greatest advantage; or at most we differ as to our love of one class of plants, or whether our hearts take in all kinds.

I was reading the other evening, Mr. D. Thomson's pleasant paper entitled "The Flower Garden" (January 26th, page 70), and having done so, I next turned to my own little jottings on the bedding and border subject. Upon re-reading "King Croquet," and "Give us Back our Flower Borders," I see that amid a good deal of harmless banter (I love a timely joke), I took this position, that in *small* gardens it would be better not to fritter away a whole lawn in beds; still less was it desirable that the borders should, as is often the case, be wholly filled with bedding plants, all others having been given up—actually, as I have known them to be, barrowed off to the rubbish-heap. I then instanced a properly (so I thought, and still in a great degree think) planted border, and sure I am that a well-arranged mixed border is very interesting. I owned my great admiration of bedding plants in their proper places. I noticed the charming regularity and delightful order, extending over the whole year, of the blooming of border plants, some at one time, some at another, quoting a portion of Thomson's "Spring," in proof; other feelings also coming into play, association with friends absent or departed, and permanency, hence love, of each plant. To talk of the trouble of keeping, and room required for bedders, I know gardeners who are "bothered" for want of room. I still agree with what I wrote last autumn, but perhaps would add, Give us back the *best* of our old border plants.

But my scientific gardening friends, workers of hand and head, I presume not to your professional knowledge or skill, but I stand before you as a representative of that large class who love a garden, understanding, to a degree at least, flowers, and mixing a good deal with the employers of gardeners. As the representative of this class, I would also be the interpreter of their feelings. Now, I have seen during the last few years what I have been very sorry to be forced to see—a falling-off in the love of their gardens in many ladies and gentlemen.

The bedding system, at first a charming surprise—novelties always charm—and being very beautiful for some four or five months in the year, is now known, and its repetition year after year is possibly wearisome. A wet or bad season has, I do believe, made people grow almost indifferent. The love of Roses, in which there is novelty if not progress, has increased, while the love of bedding plants has diminished. The yawning observation, "The Geraniums are not so good this year," answered by, "Ah! indeed, well very much the same I fancied." Indifference, indifference, for long ago all rapture has come to an end.

The reviewer of Mr. Fleming's book (page 39, January

12th, 1864), has thus put the case very fairly. "There are two growing feelings as respects flower gardening of the present day:—First, that the throwing the whole strength of ornament into the summer and autumn months has been robbing the other months of their due attention; and, secondly, a yearning desire to see more made of the old herbaceous plants that were huddled out of sight to make way for their, perhaps, gayer but not more beautiful rivals." I think, too, the bedding system, pure and simple, would never have held on its way, unchallenged, for so long a time, but for the fact that bedding plants are in perfection when our Peers and M.P.'s return to their country residences; and English people are such imitators, that what Lords and M.P.'s do must be the thing for Squire Stayathome, Parson Fixture, Dr. Gallipot, and even for Mr. Hoggins the retired grocer, not considering that all these worthy people are brought face to face with their gardens from January 1st to December 31st.

Again: I would say intensely beautiful as beds are—many a time have I gazed upon them, even a quarter of a mile distant, and even there thought them very gems of the earth, rising from the close-shaven lawn, catching and gladdening the eye with their beauty—still, gay colour is not the only object in gardens. The uncivilised negro girl delights in a red cotton handkerchief; the English lady asks for something less gaudy and more refined for her head-covering. Nature even in South America does not, as we might imagine, dazzle the eye; but then we ask for more than colour, we ask for perfume. Great as is the gain to the gardener, by having performed for many years work of hand and head, yet there is always a danger in a mere professional view, and all have their prejudices; some have trade considerations as well. If a sudden decrease in demand of bedding plants come on this year, what would the nurserymen say? With all respect for the professional man, I like also an opinion from another stand-point. I cannot for one moment allow that it is a gain to gaze upon mould for some months; no sense of clearness may be caused, indeed, by the approach of night, but a garden should be a perpetual day, a day to gladden at all times. It is the gardener's highest triumph, by a perpetuity of bloom, to have a perpetual summer. He must cruise against the seasons, must fight a stout battle, against Nature, and endeavour to banish all seasons, save spring and summer, and never rest until he can present flowers to the eye every day of every year.

I hold that it would be a noble feat if the writers of this Journal, the hand-and-head men, and we, extra-professionals, who merely pursue gardening as a source of gratification and pleasure, could inaugurate a new style of planting for parts of the garden. Progress is always needed, sameness palls the taste. I grieve to find that neither mistress nor young ladies show any compunction at sweeping away whole lawnsful of beds to make room for King Croquet, as they would have done seven years ago; but they have found the bedding plants give them less and less pleasure, so they part from them without pain. In Scotland the servants used to bargain that they should not have even salmon more than four days a-week. Sameness must tire. What I would say in regard to beds is this—on most lawns there will be fewer, let them be all the better, greater care, if possible, taken with them. They will be a cluster of glowing gems, a brilliant picture toned down by the greater space of lawn: hence they will be more beautiful than ever.

As to the borders, I grasp heartily at the idea conveyed in the expression, "It would be better to modify the old style, and adapt it to the times in which we live." Gardeners do your best, you know the habits of all plants; gentlemen can point out the want, it is for gardeners to supply it. Something new in the way of planting would make a reputation.

If the best plants were called from the old border varieties, and new ones added, the sight of old friends would be greeted warmly; and new friends, of some people, are always welcomed, and both together would be solid "pleasant company."

Lastly, I would hope that no kind of plants will be permitted to become extinct, or so rare as to have to be imported. It is surely a monstrous thing to cease to cultivate

any flower. The advance made in spring gardening is a wholesome sign, and brings prominently before us some old favourites.

I now take leave of this subject, and beg to shake hands, in type, with my friends who have taken a different view to my own, and some future day I hope to say a few words upon the legitimate connection between sentiment and flowers.—WILTSHIRE RECTOR.

FLOWERS OF THE PAST SEASON.

BEDDING GERANIUMS.

THE taste for "bedding-out" plants has led to a great deal of attention being paid to the culture and increase of Scarlet Geraniums, as they are called, although white and pink flowers come under that head now-a-days. Many hybridisers have engaged in supplying the demand; and so easily are they seeded that the number of sorts is legion; while the difficulty has been made greater of growing a good selection, from the fact of the same sort having been sent out under different names, or, what is just as likely, it has been obtained in different places at the same time. In giving, then, a few notes as to those which more especially came under my own notice last season, I shall state my own opinion as to the most desirable sorts for general growth. I have seen a *parterre* formed entirely of Geraniums of various kinds and colours; and although this may be perhaps a questionable matter, yet where so many tastes have to be considered, the greater the variety to choose from the greater the utility, though this will be considerably hindered by a too great similarity. It may be said that in these notes I am a little too late, that we want reliable information as to the kinds coming out and not as to those that are past. I do not think so, for it is impossible to give reliable information on untried flowers. Look at the great Snowball-White Tom Thumb controversy, for a proof of this. When the plants come before the general public they will be able to judge as to their merits. I may, perhaps, here add that I saw in Paris last year what seemed to me a very superior white—Madame Barillet, to be let out, I believe, this spring by Kougère-Chauvière; and I think, too, that the multitude buy not the very newest but those which have come down a little in price, so as to be more within their reach.

I received last year a goodly supply from Messrs. Henderson, of the Wellington Nursery, and Mr. Bull, of Chelsea; and my own opinion of them was seconded and thirded by my friend and neighbour Mr. Banks and his gardener. Thus did we endeavour to arrive at some tolerably fair decision concerning them. Of the others which came out last year I cannot pronounce, having only seen them in other places.

MESSRS. E. G. HENDERSON & SON.

VARIEGATED-LEAVED VARIETIES.

Mrs. Pollock.—Oh, this is two years old! Yes, but its price has been so high as to virtually exclude it from growth; while last season it came out at a lower price and many grew it. Having now tried it for two years I have no hesitation in advising all who have a garden to grow it. It has done well with me both in wet and cold summers, and is a very attractive-foliaged plant.

Goldfinch.—Something in the same way, but not so good or vigorous in habit. It seems to me to have too much of the *Mrs. Milford* blood in it, and the foliage has not the brightness which characterises some of this section.

Kenilworth.—A very dwarf silver tricoloured variety. The flowers are scarlet, and the habit distinct.

Rosette.—This has pretty pink flowers. The pink marking in the leaves only shows in a young state. It is dwarf in habit, and suitable for vases.

The Empress.—Another dwarf variety. One can hardly say it has tricoloured foliage, as it is only in its young state that it has that character; and all these silver tricoloured-foliaged varieties are more suitable for in-door cultivation than for beds.

PLAIN-FOLIAGED VARIETIES.

Ossian.—This is one of the last, and to my mind the best of poor Donald Beaton's seedlings. He seems to have succeeded in throwing the tint of some of the Nosegays into

Punch, and thus to have obtained this plant. Its habit is similar to that variety, but not so tall. The colour is orange scarlet with a decided shade of purple in it, very similar to the old *Pelargonium* known years and years ago as *Dennis's Perfection*. I do not think any one will be disappointed in growing this flower on my poor recommendation. It is the most distinct of its class that I have seen of late.

Sir William Wallace.—Rosy cerise colour. Habit good, but no very great advance on kinds of the same shade of colour.

Madame Rudersdorff.—This is one of those new French varieties in the style of *François Desbois* and *Henri de Beaudot*, in which the flowers are a bright salmon margined with white. Habit of growth good and not too vigorous; nor are the flowers, as might have been feared, easily affected by rain. It stood well in my little garden, and was much admired.

Diadem.—Another somewhat similar variety. Dark zone leaf; the colour somewhat lighter than the previous one, but very good.

MR. W. BULL.

Mr. Bull is so well known as a caterer of novelties, that we expect to find him entering the lists for all sorts of things, from the newest Orchids down to the latest *Antirrhinums*; and so in this department of scarlet Geraniums we must expect that he would be a competitor. He had selected from many thousand seedlings (so he told me) the varieties sent out last year, some of them being very meritorious; and I am therefore not unprepared to find him stating that he has now a set far in advance of any that he has before sent out, and some of them novel in colour. I have, however, only to do with those which I have seen; and must again repeat that the opinions are not merely what I have thought of them, but of other good judges also who have seen them growing in my garden.

Visitor.—Bright salmon rose; pip large; truss well formed. A good variety, of free-flowering and tolerably dwarf habit.

Caroline.—Like *Herald of Spring*, and no improvement on it.

Alfred.—A very bright scarlet. Free-flowering in habit. Foliage good.

Commissioner.—A good bright scarlet flower, of good form and substance. Dwarf in habit and free in flowering. Likely to be a desirable sort.

Nora.—Not free enough in flowering to be of any use.

Persian.—The same may be said of this.

Editor.—Very free; bright scarlet flower; foliage quite plain. A good variety.

Coral.—Plain foliage; truss very large and full, bright scarlet; pips round and of good substance. Altogether an excellent variety.

Fairy.—Too light.

Softness.—Washy.

Climax.—Very free-flowering, light scarlet, and in other respects desirable.

Rosamond.—Salmon-coloured flowers. Dwarf in habit, and free-flowering.

Enchantress.—Salmon; large, well-formed pip; truss large also; foliage with a very beautiful dark horseshoe. A desirable variety, in fact better than any I have seen in the same style.

Bonnie Dundee.—Very dark salmon; foliage good, and truss large.

Viceroy.—Too gross in habit and too scanty in flowering to be of any use.

There may have been others sent out by other growers as good as these; but as I have not seen them I cannot venture to give an opinion. And now let me add the names of those which I consider amply sufficient for all purposes. I have marked with an asterisk those best suited for bedding purposes.

**Herald of Spring.*

**Ossian.*

**M. Martia.*

**Perfection* (called also *Attraction*, *Boué de Feu*, and *Crystal Palace Scarlet*).

**Punch.*

**Christine.*

**Diadem.*

**Madame Rudersdorff.*

**Paul Pabbé.*

**Prince of Hesse.*

**Madame Vaucher.*

**Rosette.*

**Cloth of Gold.*

**Flower of Spring.*

**Bijou.*

**Golden Chain.*

**Jane.*

**Mrs. Pollock.*

**Hôtel de Cluny.*

**Pectinata.*

**Countess.*

**Diadem.*

**Commissioner.*

**Enchantress.*

—D., Deal.

WORK FOR THE WEEK.

KITCHEN GARDEN.

SHOULD the weather prove fine, and the ground be found in a condition suitable for sowing (when it crumbles beneath the tread it may be said to be so), the following principal sowings may be made: *Beans* (*Broad*), when sowing these and Peas, if there is any fear of their being attacked by the wireworm, it is an excellent plan, after they are sown in drills, and previous to covering them in, to water them well with spirits of tar diluted with water, in the proportion of one pint to six gallons of water. It is also found that mice do not take to them so readily when they are thus treated. Advancing crops of the same to have more earth drawn to them, and some branches of spruce fir or other such sheltering material stuck in on the windward side. *Borecole*, make small sowings of this, and also of Brussels Sprouts. *Carrots*, sow; the most profitable for small families are the Scarlet Short Horn, and the Short Orange or Intermediate. A few of the Long Red may be added, as they keep somewhat better. *Cauliflowers*, prepare a sheltered border for sowing a small crop. *Leeks*, sow for a main crop in the open ground, but to have them fine they should be sown under glass in a little heat, and afterwards pricked out. *Onions*, sow the main crops; the most useful kinds for general use are the White Spanish or Portugal, Strasburgh, or White Globe, with a few of James's Keeping for late use. Underground Onions, as recommended to be planted some time ago, are useful for affording bulbs till the general crop is ready, and the true Silver-skin for pickling. The autumn-sown plants to be transferred to a warm, rich border to furnish an early supply, and at the same time a few of the smallest bulbs of last year for the same purpose. *Parsnips*, sow in drills a foot apart for a main crop. *Rhubarb*, protect the crowns by placing straw over them. *Spinach*, sow a few more rows. Winter Spinach and Parsley will be much improved by a dressing of soot on the first wet day. *Sea-kale*, the crowns in the open ground should be earthed up to blanch. When the soil is sandy and light, it may serve, but should be broken fine before placing over the crowns, that the heads may not grow crooked. On heavy soils old tan, decayed leaves, or coal ashes may be used for blanching.

FLOWER GARDEN.

Mowing and dressing lawns will soon require attention. Lawns or portions of them having a hungry, sandy soil, and liable in the summer to burn, should have a slight dressing of some kind every spring; even common soil will benefit them, as it induces another tier, if we may be allowed the term, of surface roots, of course increasing their number. However, a dressing of marly or clayey soil in a highly pulverised state would obviate the tendency to burn. Superfluous suckers of Roses, Lilacs, &c., may be removed and planted out for successional stock, and the old stools of Roses well top-dressed. All trained trees and plants should receive attention. March winds are often destructive when the precaution of renewing old stakes and strings rotted by the damps of winter is neglected. A pretty floral effect may be obtained at an early season with Narcissus, Hyacinths, and Heartsease, which may be planted for the purpose now. Anemones, and the single Wallflowers, last summer's seedlings, will shortly bloom; and in large masses, as in the Green and other parks around London, the perfume is agreeable, and the effect delightful. Plant Lily of the Valley where requisite. Get out Carnations, Pinks, Picotees, Sweet Williams, Canterbury Bells, Lychnis, Aquilegias, &c. Sow Wind Anemones for autumn-flowering, and attend carefully to the sowing of hardy annuals, placing inverted pots over them where liable to be injured. Do not forget Mignonette and Sweet Peas.

FRUIT GARDEN.

We must now begin to look for the opening blossom, and be ready on the first emergency to afford protection; Haythorn's hexagon netting, stout straw ropes stretched upon poles, or branches of spruce fir 8 or 10 feet long, the largest end being fastened to the coping of the wall, are amongst the available materials for the purpose. For the destruction of the larva of the caterpillar which was so injurious to the Currant and Gooseberry trees last season, now is a good time to rake away the earth from their stems, and to dress them with quicklime, soot, and wood ashes, return-

ing the earth as soon as it is performed. Prevention is better than cure, and this will save much hand-picking by-and-by.

GREENHOUSE AND CONSERVATORY.

The weather having become milder, fire heat may be dispensed with for hardwooded greenhouse plants, unless the night temperature fall below 36°. At this time, however, and for a few weeks to come, let the necessary waterings and cleaning be done sufficiently early in the day for the air of the house to become sufficiently dry before evening, when less danger will arise to the plants by a low night temperature than when they are exposed to it surrounded with a damp atmosphere. Pelargoniums, herbaceous Calceolarias, and similar plants of soft growth, to be kept in a night temperature of 45°, which may be increased a few degrees if the plants are wanted to bloom early. Keep them near the glass and at a sufficient distance apart to admit the light freely to their lower leaves, which otherwise will turn sickly and fall off. The Camellias intended for blooming late in the autumn should now be forced into wood, under a temperature of 60° to 65°. Shade is necessary while making their young wood. Those exhausted with flowering to be cut back and removed to a cool greenhouse for about three weeks. The same practice will do for the Indian Azaleas. If forced into wood now they will bloom in the course of November and December. Heaths may now be shifted, use abundance of drainage and sandy heath soil full of fibres. The ball must be thoroughly moist before shifting, for if perfectly dry no after-watering can bring it right. Pot Cape or other bulbs as soon as the foliage is getting strong, chiefly in loam, leaf mould, and sand. Take a portion of the Epacris into a gentle heat as soon as they have done blooming. By starting them into growth about this time and having their wood ripened early, they will be in full blossom in November, at which season their flowers retain their beauty much longer than after the sun becomes powerful in the spring. Proceed as diligently as possible with the repotting of such of the hardwooded greenhouse plants as require it, so as to afford them time to make a vigorous growth. Be careful, however, before potting to have the ball in a nice moist state, and avoid giving large shifts to weakly growers.

STOVE AND FORCING-PIT.

See that the plants in these structures sustain no check. Increase the temperature gradually, a degree or two every week, and take care to shut-up with 10° or 15° of sun heat on clear days. Keep a moist growing atmosphere, and look well to the watering and potting of such plants as require it.

PITS AND FRAMES.

One of these structures may be prepared with ashes for the reception of the thinnings of the greenhouse. Many of the hardwooded plants may be removed here and matted-up at night. This will make way for the increasing size and number of Pelargoniums, Cinerarias, Fuchsias, &c. Continue sowing tender annuals in heat. Pot struck cuttings, and exclude cold winds.
W. KEANE.

DOINGS OF THE LAST WEEK.

KITCHEN GARDEN.

WORK much the same as last week. Finished raking tree leaves, turned up and reversed the ridges of ground previously ridged up, and took up several beds of Celery, lifting the plants with a ball, and placing them closely together in an open shed, with old Mushroom-dung and earth between the plants, as high up as they were previously blanched, after giving a little water at the roots. By this means the Celery will occupy little space, and we have trenched and ridged up the ground crosswise, so that what little dung was left below the Celery could be equally spread along the surface of the ridges. We gave a pretty fair dressing for the Celery plants, but we find they have left little of it behind them. After such frosts, this lifting and storing does much to prevent damping. Our Celery this season has not been distinguished for size, but it has been very sweet, and not a head was lost from bolting, rotting, or otherwise. Sowed Celery seed, Chilis, and a few Love Apples, &c. The weather has been troublesome as regards

all vegetables under glass, the great want being light, and sufficient heat, and pure air. We have refrained from making a fresh bit of a Mushroom-bed in the Mushroom-house, as the weather was too cold for the door being opened so long as would have been necessary to have removed the worn-out bed, though the old materials are wanted for other purposes, as potting Fuchsias, &c. A cold stream of air over a bed exposed in full bearing, is apt to make the Mushroom-tough and leathery.

FRUIT GARDEN.

Moved a few Peach trees, and made preparations for planting a few more, as wheeling could be well done in the frosty mornings. The frost will do good by keeping crops and fruit-tree buds back. Finished painting all the trees in orchard-house, with the mixture mentioned last week; and here we find we made a mistake in omitting to mention that a pound of white hellebore went along with the other materials, to make rather more than eight gallons of this mixture. That and the tobacco water would be rather distasteful to insects; but for merely shutting up any eggs of insects it might be left out, the clay and the sulphur are about as good as anything. In pruning, though looking very carefully, we did not see a trace of an insect. The buds thus painted over are just beginning to move, and when about half open we will be inclined to smoke again, whether we see any traces of insects or not. We used pretty well to laugh at the bugbear of insects in-doors, until this brown beetle troubled us for the two years past. If one fat one escapes to produce a string of young ones, there will be endless trouble. We ought never to wait to see a second. The supposed ruin caused by smoking, washing, &c., is often owing rather to the plants being injured by the hosts of insects before the means of cleansing them are resorted to. Just fancy one of the gardeners of the olden time passing his Cucumbers day after day, and seeing nothing much the matter until every leaf on the lower side was encrusted with insects. Then, smoking and drenching are little better than labour and money thrown away. The most satisfactory plan would be to burn the whole of the plants, burn sulphur in the frame, remove the soil, whitewash all the brick and woodwork, make a fresh commencement, and look sharply for the first insect. Not long ago we were told of a wash which had thoroughly cleared the plants in a stove, and by one washing, too, though previously they had taken such firm possession that one could not walk along the house without having his clothes soiled by them. We presume we looked a little incredulous, as we were repeatedly assured of the reality of the fact. We have no doubt that our informant believed thoroughly what he said. But we also know that, long before plants could be so much infested, every chink and cranny in the pots, in the soil, in the walls, the woodwork, &c., would be well stored with young bugs, and myriads of their eggs, and that no mere single washing to the plants would remove the evil. Not only here do we realise the truth of the proverb, "A stitch in time saves nine," but when plants are so much affected as to need the nine applications, it will often be most economical to give none at all, but consign plants and insects to one common destruction.

The weather with us has been so dull and sunless, that Peaches and Strawberries in bloom do not set so well and quickly as usual; but most likely this will save some trouble in thinning, as generally they set too thickly. For general particulars see last week. Went for the last time over the old Grapes, now rather shrivelled.

ORNAMENTAL DEPARTMENT.

We could do little out of doors except turn over beds and borders that had been previously dug and ridged, in order that the frost might shatter and sweeten the soil. The snow has been too slight to prevent such work, as we think it injurious to turn down to any depth either frosted earth or snow. We wish we had a good fall of snow or rain, as water is rather scarce with us, and this is uncommon at the present season. Fresh planting shrubs should now be finished as early as possible, and if large they may require some extra watering and syringing in warm weather in summer. The ground with us has not been in a suitable state for doing anything among herbaceous plants. Pinks turned out should have the soil firmed against the stems,

and a little fresh soil and lime laid against them, which will protect them, and help to keep slugs at a distance. Pansies, Picotees, and Carnations intended to bloom in pots, should now be potted in good fresh soil; and if the roots in the small pots are much interlaced they should be gently disentangled, as strong blooming depends much on vigorous growth before the flower-stem shows. Perpetual, tree, or winter-blooming Carnations, if now in small pots, should have the central bud nipped out, and be either repotted, or, what is better, planted out in the middle of next month in fresh turfy soil in a border, and be taken up and repotted in August or September. Auriculas should have all the air and light possible, and if mild weather be anticipated, give water carefully, and in a fortnight or so remove the surface soil carefully down to the upper roots, and dress with rich compost, in which old sweet cowdung should form the chief part. Stuck some green branches among Hollyhocks that were turned out in a border from a striking last summer and autumn. The old plants seem all right in the front of shrubberies, with each its little mound of burned earth and charred rubbish.

Gave all the air possible to the Calceolaria-bed, as the plants are now a perfect thicket, hardly a cutting put in in the autumn having missed, and we are as yet afraid to trust them in earth pits without any glass over them. Partly to this hardness, and no starting in pots, we attribute the fact that nothing with us beats Calceolarias for blooming. We are sorry that Mr. Hamilton, of Hamwood, and Mr. Robson, find them so uncertain as to blooming in autumn. At Linton they grow with great luxuriance at that time, but do not bloom enough, and we know the plants receive little coddling there in winter or spring. We have just put in a good number of cuttings of Calceolaria amplexicaulis, using semicircular drain-tiles for the purpose, and setting them in a mild hotbed. We could put in a multitude of others had we room. We allude to the Amplexicaulis just now for the purpose of saying that we never like topping that kind after the middle of March. There is no other Calceolaria that has the same rich creamy yellow. Most people complain of its lateness, but this arises chiefly from late topping. If the shoots are little topped after this they will bloom early.

We had intended saying something on propagating bedding plants, but beg instead to refer to the article by Mr. Thomson last week. What he says about hardening-off is of great importance. With some people hardening and killing-off are very nearly the same thing. All such changes should be effected gradually, as it is much better to prevent rather than to retrieve a mishap. The young man who becomes careful in this respect will also know so much of the evils of sudden changes, that it is hoped he may escape the pains and penalties to which so many old gardeners are subjected. We also adopt the wooden-box system to a considerable extent; but being near the pleasure grounds we also turn-out plants as soon as possible into temporary beds, and raise and pack them in such boxes to be taken to the beds. By this planting we save a vast deal of watering. When Verbenas and such plants are struck in drain-tiles, old spouting, &c., we do not transplant the struck cuttings into temporary beds separately, but in lumps or whole tilesful, and this keeps the roots near at home. It is always a good sign when a man does the best according to circumstances; and this is one of the advantages derived from a free interchange of opinion and practice.

Moved most of the cuttings that were struck in a deep pit into a cooler place, and put some hot tree leaves in the bed to raise it higher, as we noticed a few of them inclined to draw. The cuttings will now be 2 feet from the glass at back, and 16 inches in front, and at that distance at present will rarely want any shading. Filled the space with Verbena cuttings that were previously smoked, as on close inspection a few green fly were seen. Turned a lot of Golden Chain, Cloth of Gold, Bijou, and other Geraniums established in small pots, into wooden boxes with roughish loam and leaf mould round them, and had the pots thoroughly washed in warm water, to be filled again with Stella, &c., which will be turned out in a similar manner. Watered Gloxinias beginning to push. Put in cuttings of Euphorbia jacquiniiflora, and Poinsettia pulcherrima. The first has a very fine effect when

planted out against the back wall of a stove. The Poinsettia we prefer to be dried before the cuttings are made. Young plants generally flower best. We have no doubt that there are many modes of treating it successfully. For fine large flowers, or rather floral leaves, on comparatively stubby plants, we used to stop none after June, or even May, and gave all the sun possible, with diminished water, but not so as to distress the plants, in September and October, which arrested extension and caused the flower-buds to form earlier.—R. F.

COVENT GARDEN MARKET.—FEB. 27.

The supply of all kinds of out-door produce in season continues good. Fruit, however, is becoming scarce, except Pine Apples, which are sufficient for the demand, and Oranges and Lemons, which are plentiful, the latter especially so. Old Grapes are now very scarce; they now chiefly consist of Barbarossa, of which good samples are still to be had. New Black Hamburgs are also to be obtained at from 20s. to 30s. per lb. Spanish Melons are now over. Apples and Pears consist of the same kinds as those mentioned in previous reports. Of French salads, consisting of Cabbage and Cos Lettuces, Endive, Radishes, and *Barbe de capucin*, there is a good supply. Cut flowers principally consist of Tulips, Hyacinths, Narcissus, Cyclamens, Cinerarias, Pelargoniums, Camellias, Roses, and Snowdrops.

FRUIT.

	s.	d.	s.	d.		s.	d.	s.	d.
Apples..... $\frac{3}{4}$ sieve	2	0	to	4	Mulberries.....quart	0	0	to	0
Apricots.....doz.	0	0	0	0	Nectarines.....doz.	0	0	0	0
Figs.....doz.	0	0	0	0	Oranges.....100	4	0	10	0
Filberts & Nuts 100 lbs.	0	0	0	0	Peaches.....doz.	0	0	0	0
Grapes, Hothouse...lb.	15	0	20	0	Pears.....bush.	8	0	12	0
Foreign.....	1	6	2	0	dessert..... $\frac{1}{2}$ sieve	6	0	10	0
Muscats.....	0	0	0	0	Pine Apples.....lb.	6	0	10	0
Lemons.....100	4	0	10	0	Pomegranates.....each	0	0	0	0
Melons..... each	0	0	0	0	Walnuts.....bush.	14	6	20	0

VEGETABLES.

	s.	d.	s.	d.		s.	d.	s.	d.
Asparagus..... bundle	10	0	to	15	0	0	4	0	0
Beans, Broad..... bsh.	0	0	0	0	Lettuce.....doz.	1	0	2	0
Kidney.....100	2	0	3	0	Mushrooms.....puttle	1	0	2	0
Beet, Red.....doz.	1	0	1	6	Mustd. & Cress, punnet	0	2	0	4
Broccoli..... bundle	0	7	2	0	Onions.....bushet	3	6	6	0
Brussels Sprouts $\frac{1}{2}$ sieve	1	6	2	6	pickling..... quart	0	6	0	8
Cabbage.....doz.	0	0	0	0	Farsley.....bunch	4	0	0	0
Casciums.....100	0	0	0	0	Parsnips.....doz.	0	9	1	0
Carrots.....bunch	0	6	0	0	Peas.....bush.	0	0	0	0
Caulliflower.....doz.	4	0	8	0	Potatoes.....sack	6	0	9	0
Celery.....bundle	1	6	2	0	Radishes doz. bunches	0	0	0	0
Cucumbers.....each	2	0	5	0	Rhubarb.....bundle	1	0	1	6
Endive.....scafe	1	3	2	0	Savoy.....doz.	2	0	3	0
Fennel.....bunch	0	3	0	0	Sea-kale.....basket	1	6	2	6
Garlic and Shallots, lb.	0	8	0	0	Spinach.....sieve	2	6	4	0
Herbs.....bunch	0	3	0	0	Tomatoes.....sieve	0	0	0	0
Horseradish... bundle	1	6	4	0	Turnips.....bunch	0	4	0	0

TO CORRESPONDENTS.

* * * We request that no one will write privately to the departmental writers of the "Journal of Horticulture, Cottage Gardener, and Country Gentleman." By so doing they are subjected to unjustifiable trouble and expense. All communications should therefore be addressed solely to *The Editors of the Journal of Horticulture, &c.*, 162, Fleet Street, London, E.C.

We also request that correspondents will not mix up on the same sheet questions relating to Gardening and those on Poultry and Bee subjects, if they expect to get them answered promptly and conveniently, but write them on separate communications. Also never to send more than two or three questions at once.

N.B.—Many questions must remain unanswered until next week.

POTTING CAMELLIAS (*A Constant Subscriber*).—Of the compost you name the ingredients are—three parts of turfy loam, good; one part manure from Melon-frame, poison; one part leaf mould, well; with a little sea sand, bad. The most suitable soil for the Camellia is, sandy peat three-fourths, and one-fourth turfy loam, with a liberal admixture of silver sand. In the absence of this you may safely employ turfy loam three-fourths, one-fourth well-rotted leaf mould, adding a liberal supply of river sand. Your compost will, therefore, do, if you omit the manure and sea sand; but the plants will not do so well as in a proper compost. You will find some notes on annuals suitable for your purpose in another column, and more will appear shortly.

TWELVE VERBENAS FOR POT CULTURE (*Idem*).—White Lady, Foxhunter, Lord Leigh, Admiral Mitford, Firedy, Mrs. Holford, Sultana, Queen, Lord Craven, Sirlata perfecta, Coronet, and L'Avenir de Balnet.

TWELVE VERBENAS FOR CUT BLOOM (*Idem*).—Effic Deans, Nora, Peep o'Day, Kosatie, Stella, The Bride, Favourite, Foxhunter, Lord Craven, Ariosto Improved, Marie Antoinette, and The Warrior.

EVERGREENS (*A Subscriber, Limerick*).—All the evergreens you name will endure ordinary winters in your garden-borders in Scotland.

EASTER BEURÉ PEAR (*A Subscriber*).—It is very capricious in ripening. Gather in the middle of October those produced on your west wall.

ALPINE STRAWBERRY (*Fruit-eater*).—Triomphe de Hollande Alpine Strawberry most probably would not come true from seed. It must be propagated by runners like the common varieties of Strawberry.

PRESERVING PEAS FROM MICE (*A Sufferer*).—The most effective preventive is an inch in depth, and 6 inches in width, of coal ashes, very finely sifted, placed over the rows. Red lead is a poison, and if the rats eat it they will probably not revisit you.

FLOWERING PLANTS FOR BASKETS (*De Fair*).—Hanging-baskets for plants are best made to hold a fair amount of earth, and they are to be covered with moss (sphagnum is best) inside, so as to retain the soil. The basket should be lined with spagnum to a depth of half an inch at the bottom and up the sides, and when this is done the soil required for the kind is put in, and the plant planted. *Convolvulus mauritanicus*, a fine porcelain blue, requiring a compost of turfy loam half, sandy peat or leaf mould the remainder, with a liberal admixture of silver sand; *C. cantabricus*, rosy purple; and its variety *C. cantabricus stellatus novus*, pink, with a white star in the centre, are handsome plants for baskets, requiring the same soil as the first; *Nierembergia gracilis*, white, veined with lilac; *N. intermedia*, crimson, requiring the same soil as the *Convolvulus*; *Tropeolum minus coccineum*, orange scarlet, growing well in loam and leaf mould in equal parts. Most of the *Tropeolums* are fine in baskets. *Thunbergia alata*, orange, brown eye; *T. alata alba*, brown eye. Both require rich loamy soil. *Achimenes*, *Petalias*, *Torenia asiatica*, and the double orange and scarlet *Nasturtiums*, are very fine in baskets.

THREE TRAILING PLANTS FOR HANGING-BASKETS (*W. E. H.*).—*Convolvulus cantabricus*, *Nierembergia gracilis*, and *Tropeolum Comet*.

MUSHROOMS (*J. C.*).—The specimen sent is of the common Mushroom, and consequently edible.

KEEPING CARROTS (*W. H.*).—We have kept Carrots for months in good condition by cutting a slice off the crown, so that they could not sprout. The price per ton for taking up depends upon too many local circumstances for us to give a reply. Woodfall's "Landlord and Tenant" is a book that may suit you.

FELNS FOR BASKETS (*J. J. J.*).—You will find full information in our next Number we hope.

BEGONIAS (*A Novice*).—In No. 55 of our present Series you will find all the information you ask for. You can have it free by post from our office for four postage stamps.

TREES TO FORM A HIGH SCREEN (*A Subscriber*).—As the trees you propose planting are to have a frontage of shrubs, we would not by any means plant a Weeping Ash behind them. If we were limited to the space you mention, 82 feet, we would simply plant one kind of tree only, or say two, which might be Birch and Purple Beech alternately. It would, however, be advisable to ascertain what trees thrive best in the neighbourhood; and if quick growth, &c., be important, be guided by existing examples. Poplars of the Black Italian and Lombardy species quickly rise up in places where they thrive and do not spread like Lime and Horse Chestnut, so as to overhang adjoining shrubs; both of them are also fast-growing trees. As a general rule single rows of evergreen Firs do not succeed well, but most deciduous trees will answer. The Thorn, Laburnum, and Irish Yew, are more proper adjuncts to the shrubbery than suitable trees for a high terrace. In a situation like yours, with mixed shrubs as a foreground, the sky line ought to be next studied; and if diversity be advisable, let those you plant differ from those in adjoining positions, and this in all likelihood may be done as well with one or two kinds as with twenty.

DOUBLE VIOLETS (*C. D.*).—Double Violets usually do better on a stiff than on a light soil, the best beds we have seen being on such a soil. Their culture is simple enough. Dig or rather trench the ground at least 18 inches deep, but it would be better 2 feet, working in some dung about the middle, and in damp weather in May take off the rooted runners or side-layers, which may have been previously encouraged to root by having fine-sifted sandy soil spread amongst and partly over them, and place in rows 18 inches apart or even more, and somewhat less in the row. Remove side-runners as they appear, the same as you would those of Strawberries, and if red spider appear dust well with sulphur and soot mixed. If the season be a dry one, a good watering will be beneficial. We have no doubt that you will be rewarded with a fine crop of beautiful bloom in due time.

NAMES OF PLANTS (*X. F.*).—1 is probably *Cupressus sempervirens*; 2 is not *Astrapama Wallichii*, nor do we recognise it from the single leaf sent; 3, *Selaginella Martensii*; 4, *Selaginella denticulata*; 5, appears to be a young frond of *Asplenium Fabianum*. (*An Old Subscriber, G. D.*)—*Gomphocarpus fruticosus*, a greenhouse plant, requiring a soil composed of two parts sandy loam and one part fibry peat. (*C. D.*)—*Sphaerocoma fragrans*.

POULTRY, BEE, and HOUSEHOLD CHRONICLE.

MANAGEMENT OF WATER FOWL.

(Continued from page 160.)

WITH wild fowl as with other pets, overfeeding is a great evil. Heavy, fat birds dose listlessly on the water, or squat on the grassy bank and will hardly move, while the sufficiently but moderately fed flutter along the surface to the accustomed feeding-place the moment I am seen basket in hand. Then comes one of my pleasures. They scramble after the pieces of bread thrown upon the surface till it is alive with them; and when the water is clear the Red-headed Pochard may be seen swimming under water after the pieces that sink. Many a happy hour I spend in a small summer-house that overlooks my pond and my favourites. The water is enclosed by a wattle fence, as I have long found out Ducks will not only not remain tame if they have the semblance of liberty, but they will become wild if they

have scope or the means of hiding. There is very little covert on my pond; but I have encouraged some flags and rushes at one spot. These are duly appreciated. Being thoroughly pinioned they cannot fly, and I am, therefore, secure; accidents or the acts of Ducks' foes excepted. I am very particular in seeing that they are sufficiently pinioned. The pinion, according to the generally received opinion, is that which is also termed the flight, and is composed of five feathers. When these are removed the bird can fly almost as well without it as with it. This flight, or these five feathers, grow from the last joint of the wing; below this and nearer to the body is another joint, this is not enough. Below this will be found the spur of the wing, an exceedingly hard and pointed bone projecting from the third joint. If a sharp knife be put under this spur, with the edge resting on the wing, and the back of it be struck a good tap with a stout stick, the operation is complete. The amputated part flies off, the wound is protected by the spur, and the bird being thrown into the water the cold application stays the bleeding. It feeds immediately, and except that its flying is spoiled, it is not in any way affected by the operation. I forgot to say the pinion must rest on a post or the corner of a stool or table when the operation takes place. Two persons are necessary. The real operator holds the bird by the wing firmly close to the body with the left hand, and also keeps the wing fully spread out by placing the thumb behind the principal joint in the middle of the wing. The right hand holds the knife so lightly on the wing that it does not hurt the bird nor cause it to struggle, and the blow being given the operation is complete. By way of warning, I advise a judicious choice of the person who strikes the blow. The knuckles of the right hand of the operator are in dangerous proximity to the back of the knife, and if the stick used as a mallet be a long one, and the blow awkwardly struck, it often descends on the knuckles instead of the weapon. My eyes even now flash fire at the recollection of it.

I have the beautiful Carolina Duck, with its variegated crest, its white-spotted ruddy breast, its delicately-barred sides, rich with metallic lustre, its red eye and bill; the jolly-looking Red-headed Pochard, with its red head and neck, black breast, grey body, and red eye; the Black-headed with its graceful crest and sharp-cut division of black and white plumage, with unique colour and gloss of head, set off by the bright golden eye; the many-coloured Shoveller, with his curious bill; the pretty little Teal, only thought little of because he is common; the Garganey Teal, substituting a white for the azure stripe on the head of the common, and having its beautiful blue and white streamers; the graceful Pintail, with its taper neck striped with white, and its long tail; the cheerful Widgeon, with his white-patched wing, and merry-looking head; the grave tortoiseshell-coloured Sheldrake, with his red bill. All these I have, and save the Carolinas, they are the cheap sorts within the reach of every one. I covet the Mandarins, but I cannot afford them. They all knew me, and I never tire of watching them; but if there be a time when I take more than ordinary interest in them, it is on a summer's evening after a very hot day. Even in a small place like that I have, and although they are comparatively tame, they are yet true to instinct. They hide as much as possible during the day, and they feed at night. So, in a state of nature, flocks of Ducks are seen asleep on the water in the midst of a large lake. They can see the approach of danger on any side; but at night they come inland to feed. Half an hour before twilight all my birds are on the *qui vive*. They rouse up from their sleepy state, they search every corner, they chase every insect, they thrust their bills into every hole. I sit in the arbour with my pets, a retriever, a terrier, very often a sandy cat, and last, not least, two little girls. One is fond of everything that has life; the other does not know a Sheldrake from a Blackbird.

The little girl who is an amateur carries the basket, and it contains odd scraps of bread. The Ducks are holding their conversation. None but those who have noticed it are aware of the continual cackle or calling of wild fowl, and it is not addressed at random, but to each other. While they are scattered about on the water, one at one end will start across to the other, and commence an animated conversation, accompanied by strange "bobblings around," and curious antics; others will join at once.

The Carolina Drake sets out his feathers and drives on the water like a Swan. The Widgeon throws up his head and whistles as he goes. When all are fully occupied, we throw in a few pieces of bread, then comes the scramble. The pieces are purposely large, and thrown one by one. As soon as one is secured, the fortunate possessor is chased by every other bird, and what with losses by the way, and open robbery by nibbling, seldom secures more than the morsel held in the bill. This is kept up so long as the bread lasts, and then a few grains of corn are thrown in, and the dun birds and tufted Ducks dive for them, and at last the birds leave the water and come up to our feet to pick up the crumbs that have fallen.

These Ducks know every member of my family. They are never ill or out of condition. They cost little to keep, and are an endless amusement. There is one drawback—they do not breed, at least not with me.

Some years since a friend of mine had some Teal and some Sheldrakes given to him. He had no pond in his garden, and, therefore, put them in his rickyard where there was a piece of water. The Sheldrakes bred at once, and being unable to burrow (the Burrow Duck) in the clayey soil, they did so into a hayrick, where they laid and hatched. The Teal did the same in a small patch of rushes. This was singular, as many try for years and never succeed in breeding a bird.—B.

EXHIBITING FOWLS NOT BELONGING TO THE EXHIBITOR.

SOLEMNLY against my will I have come to the conclusion that it is desirable to address myself to you once more. I saw in your Journal a day or two ago certain misconstructions of some remarks of mine on the exhibition rule as to ownership, which if not corrected may swell, perhaps, to the dimensions of the recent controversy. I write with the disadvantage of not having your Journal at hand to refer to, and I am unable to recall to my recollection any passage which would justify the interpretation which has been put upon it. I will, therefore, make a statement which I hope will put the matter in a clear and satisfactory light. Originally, I believe, the rule as to ownership was adopted at all the exhibitions, but practically it was found the rule could not be enforced, in consequence of the difficulty of detection.

The Birmingham Committee, and I believe many others, decided, I think some years ago, to withdraw the rule; and, if I am not misinformed, they did so for the purpose of extending to all exhibitors the privileges which they could not prevent an unscrupulous minority assuming for themselves. It may still be more magnanimous for exhibitors to rely on their own resources, and disclaim all assistance from others; but whether they are bound to do so in cases where the rule is cancelled, is a question of causticity I am not called upon to decide. At those exhibitions where the rule is still retained, it is manifestly an unscrupulous and dishonourable act to exhibit birds of which the exhibitor is not the real and *bonâ fide* owner.—J. H. SMITH.

[The former remark made by Mr. Smith will be found at page 104 of our present volume, and is as follows:—"If I am not greatly mistaken, the rule as to ownership has been rescinded long ago, on the ground that practically it was found to handicap the scrupulous for the benefit of the unscrupulous exhibitor. At any rate the practice of hiring or borrowing birds for exhibition is, I believe, quite notorious; and if 'EGOMET' stigmatises as unscrupulous all exhibitors who are not the absolute owners of the birds which are shown in their names, he is casting his net very wide, and would, I imagine, be astonished at the magnitude of some of the fishes included in his haul."

We have omitted the conclusion of Mr. Smith's letter relative to Mr. Hindson, Mr. Williams, and the Game prize birds, because we have had many letters sent to us which evince beyond all denial such gross contradictions, that we find it less and less likely to arrive at the truth, and we think enough has been said to warn even the most dishonest from similar practices. We demur to the logic that because the unscrupulous will evade a rule, that, therefore, it should be rescinded. If such logic were sound then the rule against trimming should be abolished. The better course we con-

sider is to render the rule more stringent, and to require a certificate from some trustworthy party, that the fowls exhibited have been in the possession of the exhibitor for at least three months; and any one detected in evading the rule should have his name in connection with the attempted fraud published.]

EXHIBITING BORROWED FOWLS.

It was not my intention to have entered into the Birmingham Show Game-fowl controversy, but I think that Mr. J. H. Smith's letter in your Journal of the 2nd of February is calculated to do so much injury that I must trouble you with a few remarks. Mr. Smith assumes that it is not necessary that the fowls exhibited at a show should be the absolute property of the exhibitor. He says, also, if he is not greatly mistaken, that the rule as to ownership has been rescinded long ago.

Upon reference to the regulations of the last Birmingham Show I find, "The discovery of any false statement as to the ages of fowls, &c., will be followed by the exclusion of the exhibitors of such specimens thus improperly described from all future Exhibitions." Surely this must include exhibitors entering fowls not their own. What can be a grosser false statement? In the regulations of the last Crystal Palace Show I find, "All the specimens must be the *bona fide* property of the exhibitor."

Mr. Smith also states that he believes the practice of hiring or borrowing fowls for exhibition is quite notorious. If it be so, I trust the Committee of the Birmingham Show will at once take proceedings to prevent a repetition of such dishonest practices, and that in future they will have a definite rule upon the subject.

Let us for one moment consider the practical effect of allowing hiring or borrowing for exhibition. A has a pen of poultry which he has entered for a show; one of the hens is not quite so good as he could wish, but he is honest, and sends it. B has a pen of fowls not so good as A's, but he rejects his defective bird, hires, and thus beats A; wins the prize, and obtains a greater sale for his stock. C has a number of fowls all rubbish, but he hires all his birds for exhibition, gains prizes, advertises his birds and eggs, and defrauds the public.

I trust stringent measures will be taken to prevent such frauds.—W. H.

[We entirely agree with our correspondent. He who exhibits fowls as his own which belong, in truth, to another person deliberately acts a falsehood. Nor is that the only bad phase of the wrong. That exhibitor cheats any person who buys fowls from him, under the persuasion that those fowls are the relatives of the birds exhibited; and that exhibitor who wins prizes with birds not his own robs the owner of the pens next in merit. We write thus explicitly because we have seen those defend the practice from whom we expected sounder judgment; and because we would save poultry exhibitions from the consequences arising from such suspected dishonesty.]

PRACTICAL BEE-KEEPING.

WITH no desire to depreciate the claims of real improvement, I lean to the opinion that a large portion of the knowledge promulgated by modern theorists on the subject of bee-hives and bee-management is comparatively useless, unless to the few who have long purses and time at command to devote to the superintendence of any but the simplest kind of hives.

During some years' experience I tried many of the modern devices; but, apart from all considerations of mere amusement, I returned to the conviction that nothing would supersede for popular use the economical straw hives of our forefathers, properly made as to form and size, under protection from weather, &c. Every experimental apiarian has his particular crochets; but setting aside mere fancy, I agree in opinion with such instructors of the masses as Payne and Golding, who, judging from their writings, preferred straw to any other material.

Of course I leave to the theorists all the merely artificial uses to which complicated hives are put; but these do not

concern more than one out of some hundreds who have no interest beyond mere utility, with neither time nor inclination to devote to troublesome operations, too often counter-acting the natural impulses of these interesting mechanics, if not fostering the diseases which have led to much recent acrimonious controversy. So far as I can perceive this has ended as it began; for, in the din of words, no one has as yet defined what the particular disorder, loosely called "foul brood," if it be not dead putrid larvæ, really is.

But I have no desire to engross more of your valuable space beyond adding, that I am aware I am exposing myself to a harmless shot or two, as one progressing backwards, but that sort of thing is of little moment to—A UTILITARIAN.

REMOVING BEES.

I SHALL be moving at the end of May from my present house to one about 100 yards off, and I have, on a wooden bee-stand in my garden, three bee-hives, which I must remove at the same time. Will you tell me whether to move the stand during the morning or evening to prevent the bees flying back to the old garden? The new garden is on the same side of the road as the present one.—L. E.

[Bees should be removed in the evening when all have returned from their labours. If in common hives, they should be secured by being tied up in cloths of open texture (cheese-cloth is the best), and carried carefully by hand. When the distance is short stocks will be much weakened by the return of bees to the old spot. This may be obviated by an intermediate transportation to a friend's garden not less than a mile and a half off. At the expiration of three or four weeks they may be safely introduced to their new location, and, if the affair has been properly managed, will rather benefit than otherwise by the excursion.]

PREMONITORY SYMPTOMS OF DYSENTERY.

YOUR correspondent "F. W." in page 143, says that for several days he had observed large drops of an orange-coloured substance on the alighting-board of his hives. Bees in a healthy hive void no excrement in the hive; and if they are prevented leaving it by a severe frost for any length of time, they will do so on the first opportunity that offers, and the excrement they void is of a fetid smell, and is that observed by "F. W."—T. S.

[Our correspondent's explanation is unquestionably correct. The appearance referred to may be deemed the first symptom of incipient dysentery arising from long confinement.]

EAST INDIAN BEES.

WE have received another letter from our correspondent near Myhere relative to the black and white bees of India. The following is an extract from the letter:—

"I hope you have not said anything in the Journal about these bees, for certainly I think the statements made to me are not to be relied upon.

"In the first place, we took a comb about four days ago, when the moon was about its first quarter, and there was not a particle of honey in it, but all the cells were full of larvæ in all stages of progress—some just coming out of the cells, others just formed, and many evidently hatching. According to the natives' ideas the combs ought to have been full of honey. We were somewhat disappointed, for we had watched the swarm for some time, and fully expected a harvest of honey.

"A second idea I have found to be very incorrect, to my cost! It's all very well to say that they don't sting, but I know that they do. One morning I went very boldly to look how large the comb of one swarm was, and, in order to see how they were getting on, I poked them aside with a stick, thinking them harmless! but, bless me, how I had to run! The little brutes came at me most ferociously, and one settling on my hand stung me. My topee (hat) and clothes were covered with them; but that on my hand fortunately was the only one which penetrated the skin, for my hand soon swelled considerably, and was very irritating. So, like little Paul, 'I don't believe that story,' about these bees not stinging."

DAIRY PRODUCE AND MANAGEMENT.

At a meeting of the Eye Farmers' Club, Mr. Horn read the following paper:—

It will be within our province this evening to review only those breeds most especially that belong to the class of dairy cows, which we may classify as follows:—the Yorkshire, Ayrshire, Alderney, and Suffolk. The Yorkshire being the largest and most numerous, we shall, therefore, take her first.

The Yorkshire cow, as we term her, is descended from the Holderness crossed with the Durham bull, but a different animal to the Teeswater or high-bred Shorthorn. They are held in high estimation in and around London for the quantity of milk they yield; and if well kept, at the same time making flesh for the butcher. An average cow of this breed for several months after calving yields 20 quarts a-day; while some have been known to yield 30 to 40 for months together. Some cows are supposed to yield from 4000 to 5000 during the year. It must be borne in mind that the food is of the most forcing description for the production of milk without regard to quality, brewers' grains being a *sine qua non*. These cows form all the dairies of the midland counties; their milk is not rich in cream, yet on rich pastures or high feeding this is more than counterbalanced in quantity, and making beef at the same time, as we have the testimony of Mr. Horsfall, Braley Hall, Yorkshire, who so explicitly described his mode of management in his papers to the Royal Agricultural Society's Journal—papers which I would strongly recommend every one interested in dairy management to peruse carefully.

I must next advert to the Ayrshire; and I believe, taken as a breed, they are the most select as to milking properties. Ayrshire being a dairy county, the breed has been cultivated with the greatest care, and selected by distinguishing points known only to the initiated; and I hesitate not to state that we have no other class of cows, taken as a breed, that will produce the quantity of milk for food consumed: hence the high estimation they are held in in cheese-making districts. I shall give you one illustration. We have one small cow in our dairy (of said breed), which is called Victoria, now well up in her teens; for one season (pasture in the meadows only), for three months she averaged twenty-six quarts a-day. We have records of much greater quantities than this; but she was a small cow, then only about 56 stones imperial live weight; so that every twenty-seven or twenty-eight days she produced her entire weight in milk—in short, she may be termed a milk-giving machine.

I now come to the Alderney or Channel Island cows, which in their own island are most valuable, both for the quantity and quality of butter they produce. They are not much in favour in the eastern counties in consequence of the high prices which have to be paid for them when in profit, and their comparatively small value to the butcher; and, moreover, our sharp east winds rather tell on their delicate constitution. When kept, it is mostly by private gentlemen for family use. They yield a fair quantity of milk, which is very rich in cream and produces excellent butter. In their own island they are reported to yield from 10 to 12 lbs. of butter a-week during the summer; that result is very seldom obtained in this district, unless under very favourable circumstances. In the west of England they are greater favourites than with us. However, W. Fisher Hobbs, Esq., of Boxted Lodge, has favoured me with the following account of two cows kept by him of the same breed. He writes as follows:—"At your request I send you a correct account of the produce of two cows (Alderneys), which I kept at my own residence, Boxted Lodge, in 1861. I had no other cows there during that time. You will observe that the produce from these two cows was kept separate from the period of their calving until the 12th of July. After that time the cream was mixed. The total produce of these cows in thirty-four weeks was 860 lbs., besides what cream was used in my house;" this being an average of 25½ lbs. for the two cows during the thirty-four weeks. You will observe Mr. Hobbs states that the milk was kept separate from the period of calving until the 12th of July. For fourteen weeks previous to this date, one cow averaged 17½ lbs., and one week 20 lbs. 1 oz., a quantity (for the length of time be it remarked), I am not aware has

ever been obtained from a cow of any other breed. So much for the Alderneys.

We shall now briefly refer to the Suffolk. There are many gentlemen in this room who are better qualified to give an account of the Suffolk cow than I am, from the short period that I have been amongst them, and I shall be glad to hear them this evening. However, we have records of a polled breed of cattle in Suffolk for about two hundred years, but of what shape or form we are left to surmise. In my opinion, at no distant period they have been crossed with the old Aberdeen, to which the best animals of the present day bear a striking resemblance. Blood red is now the favourite colour, with little or no white, unless the tips of the tails; but they have been so indiscriminately crossed latterly with all sorts of brutes which could be called bulls, that in consequence we have nearly lost the original stock. In short, since the dispersion of the late Sir E. Kerrison's stock, it has been difficult in this district to find pure animals to breed from; and I wish to impress upon my dairying friends that it is just as essential, in order to obtain good milkers, that the male should be descended from a good milking stock as the female. Most people are careful as to the milking properties of the cow they breed from for the dairy, but the bull is seldom taken into consideration; and it somewhat surprises me, considering the haphazard manner in which they have been bred, how the Suffolk cows have still kept the milking properties for which they are justly celebrated. We have obtained 24 quarts a-day from a Suffolk cow when in full profit, and I presume my dairying friends will not term them useful unless they yield from 18 to 20 quarts a-day when in full profit. They are better adapted for the arid climate, rough and badly-farmed pastures of the eastern counties than any other breed. They yield a good quantity of milk, and when properly fed their milk is pretty rich in butter. Taken as a breed, their skins are coarser than either the Shorthorn or Ayrshire; in consequence, they are not so sensitive of flies; and, moreover, being without horns, they are more suitable when in yards. Likewise, they are favourites with the Society for the Prevention of Cruelty to Animals, as they cannot inflict severe torture on each other; and when crossed with a proper Shorthorn bull, produce a good animal for fattening purposes. And, further, we have the testimony of Mrs. Rainer, Thorpe, confirmed by other eye-witnesses, of her polled cow producing in one week 19 lbs. 15 ozs. of butter, and for weeks in succession 18 lbs. 12 ozs., and for nine months 11 lbs. 4 ozs. was the average. Mrs. Rainer had only this one cow; but, to use her own words, she "treated her like a child." Again, we have the late Mr. Lingwood's cow, at Brome, which produced 16 lbs. 4 ozs. in one week, and for weeks averaged 15 lbs. She was also a single cow, kept by a private gentleman. The late Mr. Pusey truly said, "Books will not teach farming, but if they describe the practices of the best farmers they will make men think, and show when to learn it."

We must next proceed to analyse the systems of converting the produce into money. The most profitable is when the milk can be sold sweet from the cow, which in most localities will sell for about 8d. per gallon: and if we take the general average of the Yorkshire cow, when well kept, as being about 800 gallons, then we find the produce will amount to something like £26 annually. In turning to our own country cows, they, on an average, may be supposed to yield 500 gallons, being about 2 gallons a-day for nine months. Supposing these 500 gallons to be sold at 1½d. per quart, we would then realise about £16 10s., which, with calf 10s., would make the result £17 per cow. When the milk cannot be sold, we must then convert the 500 gallons into cheese: then we should realise something over 500 lbs. of cheese, which at 6d. per lb. gives £12 10s., calf, and whey for pigs 30s., which would make £14 per cow. By converting the cream into butter and the partly skimmed milk into cheese, we would then realise 160 lbs. of good butter at 1s., and 300 lbs. of part skim milk cheese at 4d. per lb., which, with calf and whey at 30s., stands at £14 10s., and with proper management, producing a good article, the price of the produce may be raised, and these terms may be exceeded.

We shall now find how this tallies with other districts. In Dorset and some parts of Somerset it is customary for

dairymen to rent the cows from the farmer, the dairymen doing all labour, and the farmer providing cows and keep, for which the former pays for produce of cows, £9 10s. to £10 10s. The produce is mostly converted into butter and skim milk cheese in Dorset; while in Somerset some of the best Cheddar cheese is made, now worth 9d. per lb. A similar system prevails in the west of Scotland; but the produce is entirely converted into cheese, the cows are better kept, and the rents are higher, both to the farmer and dairyman. A late employer of mine rented a farm in the said district of 600 acres, his rent being £1200. He kept a dairy of 100 cows; and I have known his dairymen pay £12 for each cow, which covered the farmer's rent. The agreement was—the dairyman to do all labour attending the cows, unless some milking the farmer had to provide. Keep of cows was 1½ acre for each cow of good grass for summer; six tons of swedes and two bushels of beanmeal for each cow, with straw *ad libitum*. The dairyman would realise about 4½ cwt. of cheese from each cow, and when properly manufactured it would sell at about 70s. per cwt. The produce would run from 14 lbs. to 15 lbs. per cow.

I have, thus, gentlemen, endeavoured to bring under your notice the different systems that are practised in other districts. I have stated results which have been and may be realised with proper management; and one naturally begins to wonder why Suffolk, once so prominent in dairy management, is now getting into the shade; the complaints are loud and long that no dairymaids are to be found. Again, some maids maintain that there are no places for them to learn, as no one will take the trouble to teach them. But they are not easily taught who do not want to learn; and as crinolines and feathered caps are more in unison with nursery-maids, table-maids, and house-maids, the washing, scrubbing, working, rosy-cheeked dairy-maid of old is nowhere to be found; so if the dairy is left to the maid, the maid must have the boy to do it; and if left to the boy, to use a popular phrase, it soon must go to the dogs. We are told that cleanliness is next to godliness; and in no case is it more applicable than in dairy management. Morning and evening, Sunday and Saturday, twice a-day the dairy must be attended to; for, be it remembered, it is only a first-class article which commands attention in the market.

We now come to the last branch of our subject, and one with which I doubt not, all of you are familiar—converting the cream into butter—a very simple, but at certain seasons, with certain feeding, a very ticklish operation to make a first-class article. As we make a middling article, I shall give you an outline of the system we pursue. During the winter our cows are fed on roots and chaff in conjunction, the first part of the season on Scotch yellow turnips or swedes; after Christmas on mangolds. Those in full profit receive about 4 to 5 lbs. of cake or corn in addition. It is when fed on roots that the care and experience of the dairymaid are put to the test to produce a good article. Our dairy people maintain that if we send the milk into the dairy free from taint they will produce butter agreeable to the palate; therefore, when the cows are on roots we invariably use a small quantity of saltpetre put into the milk warm from the cow, in order to dispel any effluvia the roots may produce. Care must be taken not to use too much; if so the butter will taste rancid—say an ounce to every 30 gallons.

We shall now go into the dairy, and, to use an Irishism, we do not allow the butter to spoil before it is made—that is, stale vessels taint the milk, or stale milk taints the cream, and tainted cream will not produce first-class butter; and as our object is quality before quantity, our customers being rather fastidious in taste, we must endeavour to produce a sweet article. The milk is first creamed at twenty-four hours, and again at thirty-six; in so doing, both milk and cream keep sweeter than if only once creamed at thirty-six. We churn thrice a-week. We use no artificial colouring. Our spare butter goes to a “west-end miss,” at prices varying from 14d. to 17d. per lb. There are many ifs and ands in order to make good butter where cows are fed on roots; but the dairymaid claims them as her knowledge of the art, and which would be tedious to describe. Gentlemen's dairies are in unison with “home farms,” neither are proverbial for large profits. However, while our injunctions are to produce a first-class article, we at the

same time have an eye to profit. Our dairy of milk cows consists of 24, and they cost us for dairying and attendance 24s., or 1s. a-head per week; and on examining our dairy-book for 1862, after deducting the said labour, I find a credit of £10 standing for each cow. Be it remembered, we wean a calf for each cow in addition.

In the foregoing observations I have endeavoured to bring under your notice the breeds of cows best adapted for dairy purposes. Thus we find the Yorkshire the favourite, where pastures are rich and quantity required; and again, in the western part of our island, where cheese-making prevails, we find the Ayrshire the universal favourite; and when only cream and butter are required, we find the Alderney in esteem. It is said “Ireland for the Irish,” and we must say, “The Suffolk cow for Suffolk;” for after a trial of all the breeds I have named, it is found by experiment in our establishment that they are the cows best adapted for the district. There is no doubt many of you have exceeded our small profits; but it may be equally true that on some farms, from want of care and attention in the management of produce and stock, they have not been obtained.

And now in conclusion, I would advise my dairying friends to endeavour to improve our stock of Suffolk cows, and to be a little more careful in the choice and selection of bulls, endeavouring to obtain them from good milking stock. Even now they are, and with care and attention they might be made, a very valuable animal for the district. I have generally treated the subject with reference to the soil and climate of this country. With more rain, less easterly winds, pastures naturally richer and better farmed, other breeds might be found better suited than the Red Polls.—(North British Agriculturist.)

RHODODENDRON PONTICUM POISONOUS.

HAVING observed in your Journal No. 150, page 116, that information was requested as to the poisonous qualities of any of our ornamental shrubs, I expected that before your last issue *Rhododendron ponticum* would have been pointed out to you as poisonous. As its effects do not appear to have been noticed by your ordinary correspondents, I now beg to offer you my experience of this shrub.

Six years ago some of my sheep broke into a wood where *R. ponticum* had been planted for cover, and on that occasion three ewes died. This year the same thing again occurred, and ten sheep showed symptoms of poisoning. Immediately it was observed, milk, in doses of a gill, was poured down their throat, and this produced vomiting, in the course of which the *rhododendron* leaves were brought up. The dose of milk was repeated several times, and nine out of the ten recovered. The other one died because the milk had not acted as a sufficiently strong emetic, a number of the leaves being found in the stomach.

I do not know whether other *rhododendrons* than *ponticum* are poisonous or not; but I should judge that the poison if it exists must be much less virulent in them, since rabbits, which, as is well known, never touch *ponticum*, eat the finer kinds with impunity.—A NORTHERN SUBSCRIBER.

OUR LETTER BOX.

ARTIFICIAL HATCHING (*Oaths*).—Cittello and Minasi published pamphlets on the subject, and Reaumur a work in French, but they are all out of print. If you buy No. 321 of the first series of this Journal you will find directions on the subject.

CRÈME CHÈRE FOWLS (*D. A.*).—Apply to Mr. Baily, 113, Mount Street, Grosvenor Square.

WHITE DORKINGS (*H. M. F.*).—Refer to our reports of shows, and write to those who took prizes or are commended. We fear that a coffee-mill would not bruise oats, but if you try it you will have the proof at once.

CUCHIN-CHINA EGGS NOT HATCHING (*An Old Subscriber*).—As there were embryo chicks in them they evidently were chilled during the recently severe weather. Probably you put too many eggs under the hen for her to keep the whole sufficiently warm. Nine is the largest number to be placed under a hen in winter, and many poultry-keepers use a still less number at that season.

FOUL BROOD (*T. S.*).—This has been defined to be, as its name implies, a disease which attacks the young larvae in their various stages of development. At first only a few die, but as these putrefy in their cells the infection spreads, until very few bees arrive at maturity, and the stock dwindles and ultimately perishes.

WEEKLY CALENDAR.

Day of M th Week.		MARCH 8-14, 1864.	Average Temperature near London.			Rain in last 37 years.	Sun Rises.	Sun Sets.	Moon Rises.	Moon Sets.	Moon's Age.	Clock before Sun.	Day of Year.
			Day.	Night.	Mean.	Days.	m. h.	m. h.	m. h.	m. h.		m. s.	
8	Tu	Violet flowers.	49.7	31.9	43.3	14	31 af 6	51 af 5	13 6	46 6	1	10 53	65
9	W	Apricot flowers.	49.9	31.4	40.6	10	29 6	52 5	40 6	7 8	2	10 58	68
10	Th	PRINCE OF WALES MARRIED, 1863.	50.2	31.7	40.9	13	27 6	54 5	7 7	27 9	2	10 22	70
11	F	Gooseberry foliage.	49.5	32.3	40.9	15	25 6	56 5	36 7	42 10	3	10 6	71
12	S	Daffodil flowers.	50.7	32.5	41.6	18	22 6	58 5	10 8	50 11	4	9 50	72
13	Sun	5 SUNDAY IN LENT.	50.7	34.5	42.6	14	20 6	59 5	50 8	morn.	5	9 33	73
14	M	Celstoot flowers.	51.2	35.2	43.2	16	18 6	0 6	35 9	53 0	6	9 16	74

From observations taken near London during the last thirty-seven years, the average day temperature of the week is 50.2°, and its night temperature 32.8°. The greatest heat was 67°, on the 10th, 1826; and 12th, 1841; and the lowest cold, 7°, on the 10th, 1847. The greatest fall of rain was 0.70 inch.

FERNS FOR BASKETS.



HERE it possible to add more popularity to these gems of the vegetable kingdom, I would willingly devote much of my leisure to an advocacy of their merits; but their beauty and graceful form have already won for them a large share of public patronage, and extended the area of the horticulturist's pleasures. Some of them, however, are grown in positions which hide fully one-half of their

beauties. For instance: the beauty of some consists in their roots being seen as well as their fronds. *Sitobium davallioides* in a pot has no charms beyond its graceful fronds; but planted out near an overhanging rock so that its rhizomes can run over the rock, which it will do, it has the appearance of a beautiful *Rhipsalis* seeking the ground from a height of several feet; and all along these rhizomes the fronds rise elegantly and overshadow the sources from which they spring. Then that curious plant the Staghorn Fern (*Platyceerium alcicorne*), is lost in a pot, its beauties being unseen. But I must not waste space; though the inquiries of a correspondent, "J. J. J.," have led me to descant at some length on my favourites.

The Ferns most suitable for baskets are those with creeping stems (rhizomes), of dwarf habit, and with pendant fronds. The most suitable soil I have found to be cocoa-nut dust when a year or two old. Prior to the introduction of this I employed turfy brown peat one-half, turfy yellow loam one-fourth, and pieces of sandstone one-fourth, the latter the size of a walnut, the whole chopped up with a spade but not sifted, and well mixed. When the cocoa dust was used a liberal admixture of silver sand was added, but silica of any kind will do. Silica in some shape or other I believe to be essential for Ferns, and I therefore recommend a liberal use of sand or stone in the ingredients of the compost for Ferns of any kind, except for such as require chalk.

I have found no baskets so suitable as those from 6 to 9 inches deep, and from 6 inches to 2 feet in diameter, made in the shape of a half-circle. It is immaterial, however, what shape the baskets are if not too deep, and they should be made to hold a fair amount of compost. For small baskets or for suspending in Wardian cases nothing is so suitable as the half of a cocoa-nut shell. Wood baskets I do not like: they rot so soon, and generate such a quantity of fungus, that the roots of the Ferns do not grow in them, and it is not pleasant to see an otherwise-beautiful basket disfigured by a crop of fungi. Copper baskets are the most expensive and durable, but not the best; for copper soon becomes of a foul blue colour, and no Fern root can live near it.

Wire baskets painted answer well for a time; but the paint perishes, the iron is soon corroded through, and they are then useless. The best baskets that I have used were made of wire, and were galvanised after being made. Any wire-worker can make these baskets; but they should not be made of galvanised wire, or, if they are, the chains and everything should be galvanised afterwards. I do not know whether these baskets are more durable than those made of copper wire, but we have some that are no worse at the end of five years. The baskets in my opinion look the best when made as simple as possible, for no art can outstrip nature, and a fine basket with a sorry plant in it is a most unpleasant object. Baskets are sometimes made of such fantastic shapes that the cultivator is puzzled to know how to get a plant to grow in them. As specimens of the wire-worker's art they are undoubtedly fine; but like some very artistic conservatories, they kill plants which grow well under more suitable circumstances.

The basket or baskets to be filled being in readiness, a quantity of fresh sphagnum should be provided, but that which is dried will do, only the dust must be sifted from it. Fresh, however, is best, as it is very nice to have the baskets covered with live moss for a time until the plants have grown considerably. Place a layer of sphagnum about half an inch thick at the bottom of the basket and up the sides, pressing it firmly, so that it may have the appearance of a well-made fowl's nest. Put in some of the compost in the basket, and introduce the plant, so that the crown may be a trifle higher than the edges of the basket, and put the soil rather firmly round it. A layer of sphagnum on the soil, made fast with copper wire, will materially add to the appearance, and prevent the soil being washed out in watering. When planted, my practice is to dip them overhead in a cistern of water of the temperature of the house required for the species, and then hang them up in their final situations, not nearer to the glass than 18 inches, reckoning from the fronds. In case a cistern should not be at hand the basket should be watered until the water runs freely from the bottom.

The plants will only need due attention as to water, to give which the cultivator must examine the upper surface of the basket; for it very commonly happens that the under side is moist, whilst the upper surface, where the majority of the roots are, is dry. The soil should at all times be kept moist, but double the quantity ought to be given when the plants are growing as compared with what they receive when at rest. The best way to water plants in baskets is to take them down and dip the basket in a cistern of water of the same temperature as the house.

Cocoa-nut baskets only need holes to be drilled in them for the wires to hang them up by, and the Ferns may be planted in them like any other plant. If the Ferns have creeping rhizomes these should not be buried in the soil, but be pegged down and distributed over the surface, so that they may the sooner reach the outside of the nut, to which the roots will cling, and over which the

rhizomes will creep, having a beautiful appearance. I may mention that the shell of the cocoa-nut makes capital baskets for small Orchids and Ferns. Suppose we have two nuts in the shell. If we cut one down lengthwise on two opposite sides we have two baskets, representing the half of an ellipse, or boat-like baskets; and if the other be cut in the middle we have two halves of an ellipse, but egg-shaped. Now these make good and tolerably durable baskets for small-growing Orchids and Ferns, and both grow well in them, which is a point of some importance.

The finest object that I have yet seen was a pot of *Platy-cerium alaicorne* suspended from the roof of a conservatory. The plant was in a perforated pot, such as is used for growing Hyacinths to produce a pyramid. The plant had been potted in the usual way, but some visitor told the gardener that it wanted to be on a block of wood with the back to the glass to be seen to advantage. The gardener had not the wood or not the inclination, but determined to profit by the advice. A piece of strong wire was run through the lowest perforations in the pot, and hung to the roof with the plant downwards—in reality upside down. Well, it grew amazingly; and when I saw it the pot was entirely hidden by the sterile fronds, and the fertile extended all round to a length of 2 feet. I have tried *Platy-cerium stemmaria* in this way, and have succeeded admirably; but *P. grande* did very indifferently, and that, I think, because it does not form young plants along the roots like *P. alaicorne* and *P. stemmaria*. *P. biforme* I have not tried, because I could not obtain it in sufficient quantity to warrant my doing so.

For suspending in small baskets in Wardian cases it is advisable to have such plants as quickly fill them, and all baskets should have plants in them proportionate to their size. I will therefore name a few suitable for baskets of various sizes, according to the diameter.

SIX-INCH OR LESS BASKETS.

- | | |
|--|--|
| <i>Lomaria alpina</i> , G. W. 4 in. | <i>Goniophlebium rhagadiolepis</i> (Pleopeltis pinnatifida), G. W. 3 in. |
| <i>Adiantum capillus-Veneris</i> , G. W. 6 in. | <i>Nipholobos ligua</i> , G. W. 9 in. |
| <i>Asplenium flabellifolium</i> , G. W. 6 in. | <i>N. pertusum</i> , G. W. 6 in. |
| <i>A. pinnatifidum</i> , G. W. 6 in. | <i>N. rupestris</i> , G. W. 3 in. |
| <i>Campsooros rhizophyllus</i> , G. W. 6 in. | <i>Polypodium rugulosum</i> , G. W. 9 in. |
| <i>Cheilanthes Sieberi</i> , G. 9 in. | <i>Pleopeltis stigmatica</i> , G. W. 6 in. |
| <i>Davallia pentaphylla</i> , G. W. 9 in. | <i>P. squamulosa</i> , G. W. 3 in. |
| | <i>P. (Drynaria) pustulata</i> , G. W. 9 in. |

Of Mosses—

- | | |
|----------------------------------|---------------------------------------|
| <i>Selaginella densa</i> , G. W. | <i>Selaginella flabellata</i> , G. W. |
| <i>S. obtusa</i> , G. W. | <i>S. uliginosa</i> , G. W. |

ONE-FOOT BASKETS, OR LARGER.

- | | |
|---|---|
| <i>Adiantum æthiopicum</i> , G. W. 9 in. | <i>Goniophlebium subpetiolatum</i> , S. 2-3 ft. |
| <i>A. caudatum</i> , S. 9 in. | <i>G. subauriculatum</i> , S. 6 ft. (This is the finest drooping Fern known. I have had it with fronds 8 ft. long.) |
| <i>A. setulosum</i> , G. W. 6 in. | <i>Goniophlebium fraxinifolium</i> , S. 1 ft. (Does moderately well in a greenhouse.) |
| <i>Cheilanthes chlorophylla</i> , G. 2-3 ft. | <i>G. loriceum</i> , S. W. 1 ft. |
| <i>Drynaria quercifolia</i> , S. 2-3 ft. | <i>Nephrolepis davallioides</i> , S. 3-4 ft. |
| <i>D. diversifolia</i> , G. 1½-2 ft. | <i>N. exaltata</i> , G. 3-5 ft. |
| <i>Davallia canariensis</i> (Hare's-foot Fern), G. W. 1 ft. ("J. J. J.," at whose request we write on this subject, will prepare the basket, and plant a strong plant of this kind in it as directed for the others.) | <i>Pleopeltis pbymatodes</i> , S. 1½ ft. |
| <i>Davallia pentaphylla</i> , G. W. 9 in. | <i>Pteris scaberrima</i> , G. 1 ft. |
| <i>D. dissecta</i> , G. 1 ft. | <i>Platy-cerium alaicorne</i> , G. 2 ft. |
| <i>D. bullata</i> (deciduous), G. 6 in. | <i>Selaginella casica</i> , G. W. |

G, greenhouse; S, stove; W, kinds that do well in Wardian cases. The figures relate to the height in feet which each kind attains.

GEORGE ABBEY.

LARGE VINERIES VERSUS SMALL VINERIES.

ALMOST everything connected with fruit-culture has of late come in for considerable discussion. Warm controversy has been freely entered into about some of the points and theories advanced.

At the present moment the orchard-house controversy rages the most loud and furious, and the veteran champion of pot-fruit-culture stands ever ready with his sledge hammer to pound any who dare oppose his pet system. Doctors or divines may mingle in the fray, but it is all the same to him; he is ever ready to defend and crush with the skill and energy of a Fabius all who dare be arrayed against him.

Of late years, too, every conceivable point of arrangement connected with the cultivation of Grapes has been elaborately discussed; and it cannot fail to have occurred to those most ignorant of the state of English horticulture that the cultivation of Peaches and Grapes has attained an importance

which points them out as pre-eminent among those fruits which require the aids of glass and artificial heat to bring them to perfection. This is, perhaps, more applicable to the Grape than any other fruit. If the Pine Apple can legitimately claim to be the king of fruits, who will object to let the Grape sit beside it upon Pomona's throne? Hence it is that everything connected with vineries from their foundations upwards through bottom heat, drainage, soil, aspect, and shape, the description of glass and other materials of which vineries are constructed, the best modes of heating and ventilating them—in short, everything that can be named, except their size, has been the subject of discussion. Size alone seems to have been considered a matter of very little or no importance, judging from the silence of the horticultural press on the matter; at all events, I have no recollection of seeing the matter either brought forward as one of importance, or of any discussion having ever taken place concerning it. This is not the first time that I have ventured to call attention to this matter, and after long observation and a considerable amount of experience with different sized vineries, I am more than ever convinced that the size or the volume of air enclosed is a matter of paramount importance, and that generally speaking vineries from the "curate's vinery" upwards would answer their purpose vastly better if they were more roomy and lofty. The size of glass houses erected for the cultivation of the Vine is (perhaps to some extent necessarily), decided by taste and circumstances apart altogether from the consideration of what mere size or room has to do with the requirements and well-being of the Vine.

It has been my lot within the last fifteen years to have had to manage Vines and produce Grapes under as great a variety of circumstances as has fallen to the lot of many gardeners in that period. I have had Vines in plant-stoves, over a general collection of stove plants, in greenhouses of various dimensions, in mere glass screens not more than 9 feet high, and not more than 5 feet wide at their widest part, and in vineries of much larger and more desirable dimensions. Like most others I have also had the opportunity of watching the planting and growth of Vines in houses greatly above the common or average run of vineries, and I have come to the conclusion that in by far the majority of cases Vines would thrive much better, and bear heavier and better crops of fruit with impunity in large houses, that is, houses that are more lofty and enclosing a greater volume of air, than in those which are of small dimensions.

It is an established fact in gardening that, in a general way, the more nearly the rules of nature are approached the more likely is success to be the result. Probably this applies with greater force to the matters of air and its temperature, in conjunction with light, than to any other conditions which the cultivator has it in his power to apply and control. If harmony with the nature and requirements of a plant should be our guide in its successful cultivation, surely, apart from any observation and experience, it must be very incongruous to envelope the Vine in glass cases of such small dimensions as are yet the majority of vineries, which are much more in keeping with the requirements of plants that are most at home in the dank stagnant air of the jungle. To confine the Vine—a plant which is most at home and thrives best on the breezy slopes and in the clear skies of continental and eastern countries—in a sort of black hole of Calcutta, with its leaves very often in actual contact with the glass and timber of the roof, where it is at one time subject to a damp stagnant atmosphere, together with all the sudden fluctuations of temperature which, in spite of the utmost watchfulness, is consequent on there being only a very small volume of confined and artificially heated air, must be termed anything but the nearest possible approach to natural circumstances.

It may be argued that such a state of things in small houses can be overcome and properly regulated by the combined appliances of an effectual heating apparatus and an ingenious mode of ventilation. Doubtless the evils now in question may be overcome or modified by great and assiduous attention; but it is not in the nature of things that the atmosphere of a low and narrow structure can be regulated with such precision as that of a larger—at least, such is my own experience; and I think that any attempt to explain

the reasons why small enclosures of an artificial atmosphere are far more at the mercy of every external influence would, to all experienced in the management of hothouses, be a work of supererogation. It is as easy to understand how a small volume of confined air is more suddenly cooled down and heated up by different changes in sun and wind from without, as it is to understand how a thin sheet of hot iron cools more rapidly than a thick one. It is simply because the radiating surface is larger in proportion to the amount or body of heat to be given off in the one case than in the other. To expect a fireman to range the temperature of a house only 5 feet wide with the same steadiness that could be attainable in one twice or thrice the width would be most unreasonable: hence in early forcing, particularly, this point alone becomes one of great moment, and greatly dependant on the size of the forcing-house, yet it is not to my mind by any means the most important of the considerations that would lead me to prefer a larger and more roomy vinery. When it comes to be considered that Vines are shut up for a great length of time in a small house, it is not difficult to suppose that, robbing as they do the atmosphere of gases which support vegetable life, or food, and charging it with others detrimental to its well-being, it would fare far better with Vines were they treated to a larger volume of air and a greater diffusion of light.

Then there is the nearness to the glass at which, as a matter of necessity in many cases, Vines must be trained in low and narrow houses, and which increases the evils arising from the other objections already named. No proper current of air can pass along between the surface of the foliage and the glass, while frost and scorching are far more likely to occur.

I could give many instances where the size of the vinery has wonderfully influenced the condition and progress of Vines, but will only refer to one or two which, I think, must have very forcibly struck others who have observed them as well as myself. I will first refer to a very large lofty vinery in the centre of the forcing range at Wrotham Park, in Middlesex, one of the finest old ranges of houses anywhere to be met with. The vinery in question, to the best of my recollection, is about 24 feet wide, 18 feet or more in height at the back, and 7 or 8 feet high at the front. Let any one go there and examine a set of Vines that were planted some thirteen years ago, and say if there are any in the same range in lower houses and of the same age, or even older, that can approach them for size and vigour—at least, there were none when I saw them last in 1861. Then there is a similar lean-to vinery in the nursery of Mr. Kay, at Finchley, five miles nearer London; there are to be seen the most wonderful Vines of their age for strength and heavy crops of fine Grapes that can well be conceived. Then north of the Tweed I may instance some vineries of more than usual loftiness and width in one of the most magnificent blocks of glass in the kingdom in the gardens of Floors Castle. In these are Vines that are wonderfully strong of their age. The houses are 20 wide and 8 feet high at their lowest point in the roof. Without multiplying examples it would, perhaps, not be fair towards the poor old lady at Chiswick, the Royal Horticultural Society, not to name the large iron conservatory, now a vinery. The Vines in this house, though I have not seen them since a few years after they were planted, are, from all accounts, a houseful of Vines that do the Chiswick Gardens credit. It would be interesting to know if ever Vines at Chiswick in smaller houses have attained such vigour and borne such crops. I was impressed with the superiority of large houses long before this conservatory was turned into a vinery, and when at Chiswick one day, shortly after it was decided to turn it to a different purpose from its original one, I replied to a question carelessly put to me by my late friend Mr. McEwen, that I would turn it into a vinery, and plant a collection of Vines. Whether this had anything to do with its present use I know nor care not.

These are some of the practical examples that I would urge in favour of a larger rafter and a loftier house for Vines than are generally in use. The worst of it is, that some are not content with having their forcing-houses low and squat, but must burrow into the earth besides, as the next greatest evil to be inflicted on plants that like a high and dry elevation. I have often thought that I should like to see a

summer vinery with front lights something like perforated zinc, with a similar mode of ventilation at the top of the house. This, in the dog days, would give all the advantages of an open air atmosphere, without the disadvantage consequent on an opening here and there causing cross and violent currents of air.

Perhaps some may be ready to object to larger houses on the score of expense and extra heating power, but the building of a vinery some 3 or 4 feet higher at back and front, in these days of cheap glass and wood, would not involve much extra expense, nor render necessary much more heating power, while in other respects that might be named economy would result from the arrangement I am advocating. I should very much like to hear the opinion of others on the subject.—D. THOMSON.

THE ROYAL HORTICULTURAL SOCIETY.

POOR old Chiswick! It is to be hoped that another flash in the pan is not being let off to deceive horticulturists by forming a new Committee to report what can be done with it. After four or five years' blundering with the concern at South Kensington, and spending all the Society's money in making a gigantic tea garden, the Council now fall back upon the very thing which they ought to have done at the first—that is, if the advancement of horticulture had been their aim.

From the late proceedings of the Council there is still reason for fearing that the South Kensington Garden will ultimately merge into an adjunct of the Royal Commissioners, by forming a grand architectural feature on their estate, and be partly under their control. There is reason also to fear that, although things are bad enough now, worse are yet to come. The sooner, therefore, that the Horticultural portion of the members combine to save Chiswick, and give the dear old place another fair start, the better.

The forming of the new Committee is a step in the right direction, and, from the names recorded as on it, some of the men are of the right stamp, and will do their duty if not unduly interfered with by the powers that be. Who knows but that another Paxton may again be tutored at Chiswick in the new "school of horticulture" about to be revived under their auspices.

In the schedule of the Society's exhibition this year there is a lamentable amount of omissions and commissions in the prizes to be awarded, showing the want of practical men in the Council. What can be more foreign to the objects of a horticultural society than giving prizes to military bands, unless it be to bring a few more pounds into the exchequer? The changing every year the size of pots of exhibition plants, and of plants likewise, are sources of great annoyance to exhibitors. So is the giving of prizes to particular varieties of fruits, thus stamping them as the best in their several classes, whilst a gardener may have some very fine White or Black Grapes, Peaches, and Nectarines, of other varieties, ripe at the time, and not be able to exhibit them. The Strawberry feast is one of the most original ideas yet entertained by the Council; and I, for one, must pity the partakers, for the state of the fruit on the second day will be something to look at, unless fresh supplies are furnished from the growers. If the Strawberry feast is to be an accepted fact, and held annually, I would humbly suggest to the Council to get a sunny sloping bank at Chiswick prepared for growing Strawberries, and to keep a few milk cows to furnish cream. They would then have the fruit in perfection, and show what Chiswick could do to minister to the wants of the cockney fruit-gourmands of the Society. The medals for the best collections of British plants, and for new species, are great mistakes, for there is quite enough of reckless destruction of our rarest wild plants already, without being encouraged by horticultural societies.

We do not see the Royal Botanic Society in the Park resorting to any expedients unconnected with horticulture and its advancement. Under judicious management that Society keeps the even tenor of its way, and its exhibitions are worth looking at, for exhibitors can depend upon the schedules it issues each year being suitable for the season, and for the plants and fruits then exhibited.

It is impossible to say to what objects the funds of the Royal Horticultural Society may be now applied after the specimens we have seen in their schedules this year. Perhaps they may give a medal for the discovery of a "Moa" in New Zealand, or one for a sample of the fossil bones of the "Dodo" from the Mauritius. There is one subject that would be well worthy of the attention of the Council—viz., to award prizes for the best essays on the antiquity of gardening, as seen by the broken remains of tools and flower-pots now to be found in the Chiswick drift.

The graphic report which was given in THE JOURNAL OF HORTICULTURE of the late anniversary meeting of the Society, furnished us country Fellows with some amusement, as well as matter for serious consideration respecting the position the Society now occupies. The mustering of the forces of the Horticulturists, and the hot haste with which the Museum party sent out for fresh recruits to strengthen their position, must have been as good as a play or mimic battle, and suggests a parody on the lines in "Marmion"—

"Charge, Chester, charge! On, Godson, on!
Stop the schemes of Dilke and Clutton!"

—A COUNTRY MEMBER OF THE ROYAL HORTICULTURAL SOCIETY.

THE ORCHARD-HOUSE CONTROVERSY.

I AM sorry that Mr. Rivers is annoyed, and that he should have written in the manner in which he has done; for it is surely unseemly in one who has never hesitated to express his opinions very freely and strongly to be angry with those who, like myself, desire to give an independent testimony on the merits of anything in which many persons are interested. Had I personally attacked Mr. Rivers, or imputed mercenary motives to his advocacy of orchard-houses, it might have been different; but such a thing was farthest from my thoughts. I, of course, thoroughly believe that he is convinced of the entire and complete success of his orchard-houses. I know how much horticulture owes to him, and I have too great a value for enthusiasm to be angry with those who possess it. Nay, more; I do remember that not many years ago I was a visitor to Sawbridgeworth, and received from its owner's hands a hospitality which (notwithstanding that he says he does not want to see me there again), I believe that I should again receive were I to go even to spy out the orchard-houses, for I am perfectly aware that Mr. Rivers's "growl is worse than his bite;" and although when he wrote that article he would probably have liked to have got me into one of his houses and fumigated me with sulphur and tobacco, yet I am sure that when I meet him, as I hope to do next week, he will have forgotten all about it, and be ready to regard the "quiet-minded clergyman" as a labourer in the same field, even though "only a florist."

What, then, is the "head and front of my offending?"

1. That I have given a definition of "orchard-house," which, although you have endorsed, he pronounces to be wrong, because he says it is so.

2. That I am only a florist, and ought not, therefore, to write about anything so philosophical and scientific as fruit-culture.

3. That I have given an unfavourable opinion on orchard-house-culture, and that I had no right to do so, as, independently of my opinion being worth nothing, it is opposed to facts.

4. That I had detailed what he calls gossip of the shop.

Let me take these *seriatim*.

1. I said that the term "orchard-house" excluded the idea of fire heat; and that when we are told of the successes of orchard-houses it is misleading the public when we find that flues or hot water is employed in them. Without arguing this point, I will do what is quite as effectual—appeal from "Philip drunk to Philip sober." I have before me Mr. Rivers's "Orchard-house," 6th edition, published in 1857, and in it I find the following. In the calendar (I naturally looked to see what his plan was for the winter months), for December, "If at any time this [the thermometer] denotes a night temperature of 20°, some dry hay or litter should be placed among and on the pots to 6 inches above the surface; this will keep their roots from injury by frost." In April

pans of charcoal are recommended, but nothing is said of a fire; in the builder's estimate no provision whatever is made for either flue or boiler; and where, as in page 21, he entertains the notion of a heated house, he repudiates the idea of its being an orchard-house, but calls it "a fruit conservatory," and asserts that fire heat, if ever applied, ought only to be for "forcing the fruit." I maintain, then, that both the Editors and myself were right in saying that the necessarily expensive building in which provision is made for heat, either by a flue or hot water, is not, nay, was not, by Mr. Rivers in 1857 (whatever it may be now), regarded as "an orchard-house."

2. I am somewhat surprised that Mr. Rivers should have descended to the language he has used on this point. My necessities, and not my inclination, have made me more of a florist than of a general horticulturist; but he will pardon me for saying that I believe it requires as much care, forethought, and knowledge of the principles of horticulture to grow florists' flowers as hardy fruits. If, indeed, it is only restless minds who can really cultivate fruit trees in pots, I had rather leave them alone and settle down with a "quiet mind" amongst my Auriculas and Roses. I can well imagine some first-rate Orchid-grower or plantsman ridiculing the idea of Mr. Rivers's high estimation of fruit-culture, for there I do believe the skill, experience, and knowledge of a man of first-rate abilities are required; and as he walked through his orchard-houses and heard him expatiating on his success, I fancy his thought would be, "Ah! well enough for elderly gentlemen and country 'Hodges;' but you don't call that horticulture, do you?"

3. The facts are simply these: It has fallen to my lot, as a clergyman, that I am frequently called from home on matters purely connected with my calling, and that in my wanderings I take the opportunity of visiting, as I can, all gardens, great or small, that come within my limits; that I am quite as much interested in the plants, fruits, or vegetables I see, as by florists' flowers; that I am in the habit of "taking notes" of what I see, having learned to go through the world with my eyes and ears open; and that I have been anxious to obtain, amongst other things connected with horticulture, information about orchard-house culture. I had no opinions formed on the subject (nay, the idea rather commended itself to my fancy); but from all whom I happened to converse with, and in all the places that I visited, I found that orchard-houses were considered a failure. I had seen houses 70 or 80 feet long, built for the purpose, converted into conservatories; others on which £300 had been expended by a nurseryman, which have never paid one-half per cent. on his outlay; and one unvarying testimony was given. I may have been unfortunate in not hitting upon the successful growers, but that was my misfortune; and I therefore felt that it was but right that one should express the result of one's experience. I am told that the system is successful; and I can only say that when I see an orchard-house fulfilling its promise—when I see fruit, I will not say as good, but even half as good, as those grown upon a wall—I shall gladly chronicle it; and if these results are general, shall gladly acknowledge that I am in the wrong. Meanwhile, I must be permitted to have my opinion. I have said that the results at Sawbridgeworth are not to be taken as a fair sample, because if the thing can be done, it will be done there, and to that I must still hold.

4. With regard to this charge, Mr. Rivers must excuse me for saying that, although we may honour him as a horticulturist, we cannot submit to him as an *orbiter elegantium*, or as to what constitutes that which is becoming a gentleman or not. I might pass this over in silence, but my silence might be misapprehended; and so I would desire to say that "gossip," to my mind, conveys the notion of "idle tales" concerning the characters, motives, and conduct of individuals, and not of conversation touching a subject of general interest; that the nurseryman of whom I spoke stands quite as high in the opinion of the horticultural world as Mr. Rivers, though his modesty does not permit him to bring himself before the public; and that our conversation had nothing whatever to do with personal character, but with the success or failure of a particular system. Might I not turn round, too, on Mr. Rivers, and ask him, when he records the opinions of his friend Professor —, or Mr. —, in favour of orchard-house culture, whether he,

too, is not retailing gossip? But surely all this is very idle talk. To obtain the opinions and views of others, to record them where we have the permission to do so for the benefit of others, is a duty laid upon us; and when it does not affect the personal character or standing of any one, I shall, despite of Mr. Rivers's reproof, still do so.

Another season is rapidly coming on us. I hope to have opportunities of visiting various localities in these southern counties; and I shall certainly more than ever be on the look-out for orchard-houses, and shall not fail honestly to record what I see and hear.—D., Deal.

THE LOBELIA SPECIOSA AND ITS FAILURES.

I AM not surprised to hear of the failure or partial failure of this most important ornament to the parterre, and I fear the letter of Mr. Hamilton, at page 153, will find many respondents in this country; perhaps, however, the evil complained of may be met with a more certain preventive than that which failed to retain us the services of the *Petunia* and *Anagallis*. The latter of these has in a great measure passed into oblivion, while the former in most parts of the country is only met with in a seedling form, and, of course, in that state presenting a mixture of colour. However, we must endeavour to retain the *Lobelia*, which I confess I had some doubts of doing in the hot summer of 1858 and 1859, the plants of *L. speciosa* which I had at that time dying off in many instances before the end of the season, so that the following year I resorted to an older and more robust variety, though much inferior in point of colour. In the last two seasons, however, the *Lobelia* has done better here than before. Whether this has arisen from some difference in the atmosphere, or some other cause, I am unable to say. I have partly attributed it to obtaining a variety possessing greater vital powers, as I depend mostly on cuttings for a supply; but every year I have a quantity of seedlings, which, I need hardly say, are more robust than the cutting plants, but flower a little later, are less erect in habit, and in most cases of a paler blue. I am convinced this plant does not flower in all places alike. Even cuttings from an individual plant degenerate when transported to some soils; and it is possible, though I have not proved it, that an improvement takes place when they are removed to a soil of an opposite character, the improvement or the contrary here alluded to being in the colour of the flower. Now, though this is by no means so strikingly exemplified as in the case of the *Hydrangea*, it is nevertheless in my opinion owing to the same cause—the absence or presence of iron in the soil. The best specimens of *L. speciosa* that I have ever seen were grown on soils which I know possessed that element in a certain condition, while cuttings taken from that plant and grown in a soil of an opposite character lost colour, if I may employ the term; and, as such a soil is the one we have here, I can only attribute to that circumstance the lack of depth of clear dark blue which I sometimes meet with elsewhere. The endurance of the plant, however, depends, I believe, on other things; and it would be well to consider whether some of the causes which threaten to lessen the value of this plant as a bedder cannot in some way be remedied.

Most likely if the original home of the parent of *Lobelia speciosa* were to be discovered it would be found to be some damp situation, possibly a morass: consequently we need not be surprised if it occasionally succumbs in the dry calcareous soils it is often planted in. That it requires any shade I have much doubt; there are plenty of swampy places fully exposed to the sun's rays, and very likely it may have occupied such a position. Moisture, however, is evidently a requisite: hence the failures in dry seasons, and the comparatively better growth which it makes in wet seasons or situations than in dry ones. But I am not certain whether the swamp or wet hill side may have been its home, and there is a wide difference in the two places: the one rests on stagnant water more or less impregnated with foreign matter, while the other has its moisture either fresh from the clouds, or, if in the form of a spring, supplied fresh and fresh every minute. Now such a condition rarely exists in the way the plant is grown with us; neither is it likely that with us the plant would require so much water as it receives

in a country possessing a much hotter and brighter summer; still we may fairly infer (which I certainly do) that it requires a good deal of water to do well, and the lack of this, after supporting a heavy crop of flowers, may, in conjunction with other reasons given below, account for the losses occasionally met with in beds of this plant.

As the varieties of dwarf *Lobelia* originating in the species *erinus*, *ramosa*, and others, seem to run into each other when reproduced from seed, so as to render the parentage difficult to ascertain, have we not a right to suppose that in like manner the admixture of the annual one has imported much of its character into that of the hybrids? *L. ramosa* is mostly treated as an annual; and though, like some others, it may be kept through the winter, it is by no means to be inferred that it will ever become the enduring perennial plant which we might wish it to be; but when allowed to flower continually, and, perhaps, ripen seed, the purpose Nature intended it to perform being completed, it is likely enough to die and be succeeded by its progeny. Now, in the cultivated condition the plant has undergone considerable change; and I believe I am right in saying that *L. speciosa* is merely a variety of some of the species that may have gone through various transformations. Assuming *speciosa* to be a variety having the property of reproducing itself with a greater or less degree of certainty, or of coming the same as its parent, still the greater the advance in improvement to which a successful cultivation is carried, the greater is the likelihood of the seedlings being inferior or more nearly approaching the condition of the parent; and it would certainly appear that a succession of plants from seed would in the end return to the normal condition of the original. As there are hopes of now and then obtaining a good variety possessing the requisite colour, habit, and perennial condition likely to prolong itself and afford an inexhaustible source of multiplying the kind by cuttings, it becomes a matter of consequence to make the most of such a plant when it turns up. It would be well, if those who rear a large stock of seedlings every year would preserve such as possess the required qualifications, and retain them in cultivation only one or two years, by which time it is to be supposed another seedling may have taken the place of that previously cultivated, and the result will most likely be that we shall hear of fewer failures than before, and possibly a further improvement in the colour, habit, and general character of the plant; for assuming the plant to be something of a hybrid, partaking more or less of a biennial nature, we may justly infer that it will require moving oftener than one having a more decidedly perennial parentage.

I am inclined to attribute the losses frequently met with in the *Lobelia* more to the causes above stated than to anything else, and am the rather inclined to believe so from the fact of so many plants that have been grown in pots during the summer dying off in autumn. So prevalent is this, that I am far from certain that the best mode of culture has as yet been found out. In my own case I admit that each year induces a change. Some seasons I have been tolerably successful in keeping plants over the winter by cutting off all their flower-stems in September or before, and especially from plants that were in pots; but, somehow, most of the plants so treated died in the past January, so that I should have been short of stock had not a good batch of slips or cuttings been put in boxes early in December, and these, kept in a cold pit, have all grown and promise well. I think the *Lobelia* requires to be kept cool and certainly not too dry; and even pans or boxes of seed vegetate almost if not quite as well in a cool moist place as in a warm one, for in the autumn it happened that two beds of *Lobelias* in a garden that was intended to be altered were allowed to remain undisturbed until Christmas, when it was discovered that the whole of the ground was thickly covered with young plants that had been sown and germinated there. Several of them had half a dozen or more leaves, but the bulk were merely in the seed-leaf. By paring the surface we secured a pan or two for a trial, but as we have depended more on cuttings than on seedlings, we did not save many.

No plant that I am acquainted with grows more freely from cuttings than does the *Lobelia*, and with the exception of variegated *Geraniums* none is more popular at the present time. I hope it will not follow the *Petunia* and *Anagallis*

until a substitute equal if not better than itself is furnished in its place. I have long thought that the *Nierembergia* might be altered and improved; and if we could but give it the rich blue of the *Nemophila*, to which its flowers have a resemblance in shape, we might then congratulate ourselves on having secured a desideratum. Flowers of a bright blue like the *Salvia patens* and some others are far from plentiful in the flower garden, and we cannot afford to lose any: therefore, I willingly throw in my mite of information on the subject of the *Lobelia*, and hope others will accept Mr. Hamilton's invitation to compare notes on it, and I trust your pages will contain other cases suggestive either of improvement or, at least, pointing out the way to arrest the failures we are threatened with in this lovely plant.

J. ROBSON.

HOLLIES DECAYING.

In a large wood, forming part of the pleasure grounds here, the Holly is almost the weed of the soil. It is of all sizes—large, small, and seedlings.

Lately, I have observed that a great number of the Hollies are dying—none of the large ones, and, I think, few of the very small, but those which may be, perhaps, from 3 to 5 feet high.

I should feel much obliged to any of your correspondents who could offer me a suggestion as to the cause of the decay of these Hollies. In some merely a branch or two is affected, the rest of the plant being healthy. The soil of the wood is a rich alluvial one, gravel being underneath.

We are rather too much infested by rabbits, but the unhealthy state of the Hollies does not appear to arise from their having been injured by them.—*W. Merionethshire.*

[Not having seen a similar instance, and having no knowledge whether any alteration has been wrought in the state of the soil, so as to render it more wet, we cannot surmise the cause of this partial decay. If the decay is confined to the vicinity of the rabbits' burrows, we should consider them the cause of the mischief. We shall be obliged by any correspondent informing us if he has observed a similar decay, and, if so, whether its cause could be traced.]

ANNUAL GARDEN FLOWERS.

(Continued from page 167.)

HALF-HARDY ANNUALS.—To successfully cultivate these they are best sown on beds, as advised for Stocks, the last week in March being the proper time to prepare the bed, which will be ready for the seeds to be sown in the beginning of April. Asters, Zinnias, and all half-hardy annuals do better sown on beds than in pots; and nothing is gained by sowing them early, the plants being in that case delicate and dwindling, blooming soon, and never showing the plant in its true character. Of the annuals for bedding purposes, *Lobelia speciosa*, *Ageratum mexicanum*, and *Cineraria maritima* should be sown in the beginning of March, and be placed in a Cucumber-frame, and grown on until they are sufficiently large to handle, when they must be potted singly into small pots, or pricked-off into boxes, and grown on in a vinery, greenhouse, frame, or pit, until they become strong bushy plants, when they are to be hardened-off, so that they will bear transplanting to their final quarters by the last week in May.

In addition to the half-hardy annuals suitable for bedding purposes, there are some of those termed hardy that are far more tender than many of the half-hardy, especially the various Indian Cresses (*Nasturtium*), as *Tropæolum nanum*, var. *Tom Thumb Scarlet*, *Tom Thumb Beauty* (blotched), and *Tom Thumb Yellow*. These, with all of the *Tropæolums*, are more tender than any *Geranium*, a very slight frost indeed completely destroying them. I am aware that plants come from seed left in the ground from the previous year; but they rarely show themselves before May, and if the summer be cold they do not bloom until late—in fact they only commence flowering before the autumn rains and frosts completely spoil them. To obviate this it is advisable to sow them in pots, three or four seeds in a 48-sized pot, and bring them on in a cold frame, so as to have them well forward by the last week in May.

There are many half-hardy annuals that make effective beds, but which, from their erect habit or short continuance in bloom, are not to be recommended for bedding purposes, especially for forming masses of one colour. Some of them, however, are very effective in beds on lawns, though not suitable for an arrangement of beds; and these will be distinguished by an asterisk. Others make handsome pot plants, for the decoration of cool greenhouses and conservatories in autumn, and to supply blanks in beds or borders. These will be treated of at a future time, and for the present will be distinguished by the sign †.

SELECT HALF-HARDY ANNUALS.

- **Abronia umbellata*, rosy pink, 6 in.
- †*Acroclium roseum*, bright rose, 1 ft.
- A. *roseum album*, white, 1 ft.
- (Both Everlasting-Flowers of great beauty.)
- †*Alonsoa Warscewiczii*, scarlet, 1½ ft.
- †*Amaranthus melancholicus* ruber, bronzy crimson foliage, 2 ft. (This does very indifferently out-doors in the north, but for greenhouse decoration it is very desirable.)
- Antirrhinum*, vars., 2 ft. (These, when sown early, flower finely the first year.)
- *†*Asters*, numerous varieties, all handsome.
- Calandrinia umbellata*, crimson, 6 in.
- **Calopsis atropurpurea*, dark red, 3 ft.
- *C. *bicolor grandiflora*, yellow, 3 ft.
- *C. *bicolor nigra speciosa*, dark red, 3 ft.
- *C. *Drummondii*, yellow, 2 ft.
- *C. *Burrigii*, crimson and yellow, 3 ft.
- (These hardy annuals require sowing in heat to have them flower finely in the cold hilly districts of the north. They make very fine beds.)
- †*Clintonia elegans*, white and blue, 6 in.
- C. *putchella*, blue, white, and yellow, 6 in.
- Cuphea purpurea*, purple, 1 ft.
- *†C. *emineo*, scarlet & yellow, 1½ ft.
- *†C. *platycentra*, scarlet, white, and purple.
- *†C. *ocymoides*, purple, 2 ft.
- *†C. *strigillosa*, red and yellow, 1½ ft.
- (The last four are half-hardy perennials, flowering the first year if sown early.)
- †*Datura chlorantha flore pleno*, yellow, 1 ft.
- †D. *Wrightii*, white, 2 ft.
- *†*Delphinium formosum*, blue and white, 3 ft.
- *D. *Hendersoni*, blue and white, 3 ft. (Hardy perennials, flowering the first year if sown sufficiently early.)
- Dianthus chinensis* var., 1 ft.
- †D. *Headewigi*, various, 1 ft.
- †D. *hybridus flore pleno*, 1½ ft.
- †D. *laeinatus flore pleno*, 1½ ft.
- †D. *atropurpureus flore pleno*, 1½ ft. (Half-hardy perennials in the north, but hardy in some localities. Charming plants for early flowering in the greenhouse. They flower the first year.)
- †*Gallardia grandiflora*, crimson and yellow.
- *G. *picta*, crimson and yellow, 1 ft. (These are, respectively, very fine hardy and half-hardy perennials, flowering the first year.)
- Helichrysum bracteatum*, yellow, 1 ft.
- H. *compositum nanum*, red.
- H. *compositum maximum*, various, 2 ft.
- H. *macranthum*, white, 2 ft. (Everlasting-Flowers, of great beauty.)
- *†*Heliotropium*, vars. (Half-hardy perennials, flowering the first year if sown early.)
- Linaria bipartita* and vars., 1 ft.
- Linum grandiflorum rubrum*, 1 ft. (This was always poor with me, but it is one of the best annuals in cultivation.)
- *†*Lobelia erinus alba*, marmorata, and *Paxtoniana*, have white, and white and blue flowers respectively, 9 inches.
- L. *gracilis*, and its variety *alba*, 1 ft.
- L. *ramosa*, dark blue, 2 ft.
- *†*Lotus jacobæus*, ivory black, 1½ ft.
- Lupinus Hartwegii*, blue, 2 ft.; and varieties.
- L. *mutabilis*, blue and yellow, 4 ft.
- L. *Cruickshankii*, vars., 4 ft.
- L. *various*, 4 ft.
- Lychnis chalcidonica*, scarlet, 2 ft.
- L. *fulgens*, scarlet, 1½ ft.
- L. *Itaigama*, bright red, 2 ft. (The first of the last three is a hardy perennial; the last are half-hardy perennials, all flowering the first year if sown early.)
- †*Martynia fragrans*, purple, striped, 2 ft.
- †*Mesembryanthemum capitatum*, yellow.
- M. *pomeridianum* and *tricolor*. (These should be planted on rockwork in a sunny border.)
- *†*Mimulus cupreus*, scarlet and orange, 9 in.
- *†M. *hybridus maculosus*, various, 1 ft.
- *†M. *hybridus tigridioides*, various, 1 ft.
- *M. *moschata* (Musk), 9 in. (The last is a hardy perennial; the others are half-hardy perennials, flowering the first year.)
- Nemesia compacta*, vars., 9 in.
- N. *compacta alba*, white.
- N. *compacta insignis*, blue.
- *†*Nycteria capensis*, white, 9 in.
- *†*Ooothera historta Vetchii*, yellow and crimson. (The last two are suitable for edging.)
- *†*Ooothera Drummondii*, yellow, 2 ft.
- *†O. *Lamarckiana*, yellow, 3 ft.
- *†O. *missouriensis*, yellow, 3 ft. (The last three are hardy perennials, flowering the first year if sown early.)
- *†*Petunia*, vars., 2 ft.
- *†*Phlox Drummondii*, vars., 1 ft.
- Portulaca Thellusoni*, vars. (Require sandy peat and potsherds, and a dry situation, to do any good.)
- †*Rhodanthe maculata*, crimson and yellow, 1 ft.
- *R. *alba*, white.
- *R. *atrosanguinea*, crimson.
- *R. *Manglesii*, rose and yellow. (Everlasting-Flowers, of great beauty.)
- †*Salpiglossis Barclayana*, red, 2 ft.
- S. *Barclayana*, vars., 2 ft.
- Salvia coccinea*, scarlet, 2 ft.
- †*Schizanthus gracilis* Grahami, red and orange.
- *S. *retusus*, scarlet and orange, 2 ft.
- *S. *retusus albus*, white, 2 ft.
- Senecio elegans*, vars., 1½ ft.
- *†*Tagetes patula* (Frenck Marigold), vars., 1-2 ft.
- T. *erecta* (African Marigold), lemon and orange, 2 ft.
- *T. *signata*, yellow, 2 ft.
- *T. *tenifolia*, yellow, 2 ft.
- Tropæolum minus coccineum*, orange, 6 in. (The last is very suitable for edgings.)
- Zauscheria californica*, scarlet, 1 ft. (A half-hardy perennial, flowering the first year.)
- †*Zinnia elegans*, vars., 2 ft.
- †Z. *elegans* (double), 3 ft.

The above list contains all the half-hardy annuals that I have found worth growing. There may be others of merit, of which I shall be glad to hear through the medium of this Journal. I have included some of the most showy hardy

and half-hardy perennials because flowering the first year. These, if hardy, may be left where planted, and they flower much finer the second year. The half-hardy may be taken up on the approach of frost, and wintered in a greenhouse or frame from which frost is excluded.

For covering wire trellises, globes, &c., and to cover or train up pillars, or to plant in rustic baskets, some of the half-hardy annuals are serviceable, and of such the following is a list:—

Convolvulus aureus superbus, yellow, 6 ft.
Ipomœa bona nox, white, 10 ft.
I. Ferrandiana, blue, 10 ft.
I. purpurea, Burridge, &c., divers, 6 ft. Require sowing in a strong heat (80° to 85°).
Loasa aurantiaca, orange, 15 ft.
L. Herberti, scarlet, 6 ft.
Lophospermum scandens, purple, 10 ft.
L. Cliftoni, rose.
L. Hendersoni, rose.

(All for warm situations only.)

Maurandya Barclayana, vars., 6 ft. (Must have a sunny situation.)

Momordea elaternum, yellow, 6 ft.

Thunbergia alata, vars.

(Charming plants for training up pillars in the greenhouse, round sticks, or on a globe trellis in pots, and for covering trellises in warm situations in the flower garden.)

Tropœolum Lobbianum, numerous varieties, growing about 6 ft. high. (Handsome either trained on a wire trellis in pots, or trained up the rafters, pillars, &c., of the greenhouse; and no plants are finer in beds on lawns and in the borders. They should have a stake driven into the ground near them, to which they should be tied, or have a wire trellis in the shape of an upright cone placed over them at the time of planting.)

Tropœolum majus (Tall Nasturtium), crimson and orange. (Very fine plants, and the seeds, when well sized, but quite green, make excellent pickles. A row of these planted 2 feet apart, and trained to stakes 6 feet high, have so fine an appearance that it is very questionable whether as fine a show could be produced by any of the variegated ribbon-border plants.)

Tropœolum peregrinum (Canary Creeper), the cottagers' favourite, is one of the handsomest of plants. It must have light, and will not do crowded with other plants, and does best in sunny situations.

Now, annuals do not deserve any hard usage, they require to have as much care bestowed on them as any other plants. Water, air, and light, with a due regard not to keep them crowded nor standing too long in the seed-pot before they are pricked-off into pots or boxes, are points that must be attended to with discrimination.

I shall have more to say about annuals after awhile.—
 G. ABBEY.

BOILER WRONGLY FIXED—CUSTARD APPLE.

I HAVE the management of a conical boiler set solid on the furnace. The bottom of the boiler is 4 inches from the furnace-bars, and the flue passes out at the front, then a brick feather to cut the draught in half each way round the boiler. The flue round the boiler is about 4 inches wide, then brickwork about a foot thick. The boiler is 20 inches deep, and about the same across the bottom. It does not work satisfactorily. There are about 400 feet of three-inch pipes and 200 of four-inch pipes. There is a vinery with a flow and return pipe; also a forcing-pit with top and bottom heat. The pipes in the vinery are level with the top pipes in the pit. When they are all in operation neither the bottom pipes are warm nor the top pipes very hot, even with a good fire. The boiler is below any of the pipes. Sometimes I think it heated better before the feeding system was altered. It formerly warmed the water in the cistern, but not now. The feeding-pipes formerly entered the return-pipe near the boiler, but now they enter at the bottom of the boiler, with a bend in the pipe below the boiler, then up again.

Can you give me any information about the Custard Apple, of which I have some seeds?—H. H. W.

[We presume your boiler is fed from below, but we are left in doubt whether the top is open for such feeding, or if the top is close and also filled with water. If the top were open, and the fuel put in from above, the setting might do, as the draught on the outside would be of less consequence. If fed from below, like an ordinary furnace, the boiler is too near the furnace-bars, as that 4 inches is the only opening left for the heat to get out and go round the outsides of the boiler, and as that opening would be apt to be choked and stop the draught, which it would not be so likely to do if the boiler were raised 8 or 10 inches from the bars. The boiler itself, 20 inches in height, and about the same width across the bottom and so much less at the top, would have about 14 inches for fire-bars beneath it. This size

of boiler is scarcely large enough to heat to a high temperature, 400 feet of three-inch piping and 200 feet of four-inch piping; but we believe your boiler would do much more if set as above, or if set as you propose, not on fire-bricks, but on fire-lumps, some 6 to 8 inches above the bars, and the heat allowed to act on the inside and outside of the boiler, with a good damper on the flue or chimney, so as merely to have an inch or so of draught after the fire was burning freely. There must be, to heat freely, first, a good draught, which you cannot have if your fuel is 4 inches in height, and fills the space to the back of the boiler; and then, to secure the heat round the boiler, there must be a damper used to prevent the heat going up the chimney, instead of being mostly confined round the boiler.

When pipes are on different levels the valves or taps, or whatever is used, must be regulated so as to obtain the desired object. Have your air-pipes on the highest points of the low pipes for bottom heat. If you cannot raise the boiler, as indicated above, you must sink the furnace-bars.

The Custard Apple, of which you have received seeds from the West Indies, is no doubt an Anona, and, as you remark, the fruit is lozenged somewhat like a Pine Apple. The fruit is generally the size of two fists, green outside, and full of mucilaginous sweet flesh. There are a great number of species and varieties, however, and in many the fruit is not larger than an Orange or a Plum. Thus, *Anona muricata*, the Soursop, is a low tree, bearing large lobed fruit; *squamosa* and *reticulata* are tall trees, with smaller fruit, and lobed; *glabra*, also a tallish tree, has large fruit, but smooth, more like a pointed Apple; *palustris* is a shrubby plant, with fruit about the size of a Plum. The wood is so soft as to be used as cork by the natives. We think most likely you have *muricata* or *tripetala*; the Cherimoyer; *squamosa*, the Sweetsop; or *reticulata*, the netted. All these are strong-growing, and unless you can give them a good deal of room in a hot stove it will hardly be worth your while troubling yourself with raising the seeds. With limited room this is how we would proceed: Sow the seeds in a hotbed, pot off when up; select as many plants as wanted; keep potting-off until the plants are in large pots or boxes, and then grow in a stove, where the roots can have a little bottom heat, confining the roots in a brick pit or wooden box to prevent too vigorous growth, and giving the branches and shoots all the light possible. If you cannot do the most of this, the rearing of the plants will be labour lost.]

ROSE TREES ON THEIR OWN ROOTS.

WILL some of your correspondents well versed in Rose-culture furnish a list of such as do well on their own roots? Having a great aversion to worked plants, I have for some years been trying to have them on their own roots, and find some—as Jules Margottin, Caroline de Sansal, Souvenir de Reine d'Angleterre, Baronne Prevost, Alexandrine Bachmeteff, and others of that stamp—do remarkably well; while some, which in a worked condition resemble those named in their growth and other features, will not do so well, making scarcely any growth, and, after lingering on a year or two, dying. The soil I have them planted in is dry, but does not lack depth. I believe most of the Rose-growers of the present day prefer them growing on the Manetti stock; but I am more anxious to have them on their own bottom, and perhaps those who have succeeded with them in this way will report the kinds that do flower and thrive well when so grown. I am not sorry to find public opinion set in against standard Roses; and hope, if the kinds most admired can be grown on their own roots, to see an end of the difficulty in discriminating between portions of the stock and the worked plant, which, with inexperienced growers, not unfrequently ends in the total destruction of the latter. Some further remarks on the culture of the Rose on its own roots will be of great service to growers like me, whose admiration of this beautiful flower is the more increased by knowing that it does not owe any part of its merit to extraneous help.—F. N. P.

EXTRAORDINARY NARCISSUS.—I have a pot containing three bulbs of Queen of Yellows Narcissus; each bulb has sent up four stems, each of which sports nine to thirteen

flowers. The number of blooms at present is one hundred and eleven, and, you may believe me, the appearance is very handsome.—WELKNOY, *Liverpool*.

WINTERING BEDDING CALCEOLARIAS.

THE following successful mode of treating Calceolarias may, perhaps, be of service to "Q. Q., *Ireland*," and others.

On the 13th of October I put in about eight hundred cuttings of Calceolarias, consisting of the following sorts. The greater part were of *Aurea floribunda* and *Prince of Orange*; but there were some of *Spangler*, *Norma*, *Conqueror*, *Rubens*, *Giant Gold Cup*, *Victor Emmanuel*, *Etna*, and *King of Sardinia*, the last eight sorts being included as an experiment to ascertain if they would stand the same treatment as the others. They have done so perfectly.

Having two frames of two lights each that *Primulas* in pots and *Cinerarias* had stood in, the bottom being hard, I put in from 2 to 3 inches of soil which had been used for potting, and old mushroom-bed soil sifted not very fine, mixing in a considerable quantity of soot and lime. This compost was beaten smooth with a spade, and the cuttings were dibbled-in, not dropped in, as I find that plan does not answer, the worms pulling them up in the course of a day or two, and replanting them upside down. To prevent this I use the soot and lime, which, together with the hard bottom, have stopped that effectually.

The frames face north-east, having a high wall at the back, and are about 6 inches from it. They are made of one-inch deal, and are 22 inches deep at the back, and 11 inches deep in front, and have no protection whatever.

The cuttings were watered as soon as planted, and do not require any further watering whilst they remain in the frames. The lights are raised at the front, the wall preventing me doing so at the back, and they were never closed from that time till the first week in January. They then had a covering of mats, but not till the thermometer had indicated as low as 32°. The mats remained on till the 15th, the frost varying from 14° to 24° during that time. During the present month the frames were kept close for some time, and they had no covering except about an inch of snow. The soil inside was frozen quite hard.

When the thaw set in the lights were opened as usual, the snow being left on till it slid off, and the plants were none the worse. The lights are taken off on all favourable opportunities, and never closed night or day, nor will they be till frost sets in.

Again: Most of the plants have been stopped once, and some of them twice, and are nice and bushy. The losses will not be 5 per cent.

From the position of the frames it will be perceived that it is not the sunny situation usually chosen for the purpose but the reverse. Not a gleam of sun has shone on the cuttings since they were put in, the yard in which the frames stand being surrounded by walls and buildings that are somewhat sheltering. At the same time the experiment proves that the Calceolaria is capable of withstanding a great amount of frost if dry, the temperature being low before closing the frames; covering up more with the object of keeping it so than to exclude frost, and never uncovering again till some time after the thaw commences.

Such is the mode I find to answer, not in the genial climate of Kent, but in the more ungenial one of North Devonshire.—J. T. CREED, *Gardener to P. Sturcock, Esq.*

PROPAGATING BEDDING CALCEOLARIAS.

THE JOURNAL OF HORTICULTURE reaches me rather late, so that the letter of your correspondent, "Q. Q.," from Ireland, may have been already noticed. At the risk, however, of being behindhand, I will say a few words, with your permission, respecting the subject of it—viz., Calceolaria culture.

As an amateur writing for amateurs, I will confine myself to facts which I have proved by my own experience. The plan for propagating bedding Calceolarias which I have found perfectly successful for the last three years, is a modification of that repeatedly recommended in THE JOURNAL OF HORTICULTURE. To particularise this plan as pursued by me in the autumn of 1863, and its results as observable

at the present time:—towards the end of October I took cuttings from *Aurea floribunda* and *Kayi*, I believe principally the former, and planted them in a cold frame on a bed thus prepared—a moderately light compost, with an admixture of burnt rubbish and a sprinkling of silver sand, was put into the frame to the depth of about 6 inches. This compost being neither wet nor dry, was pressed down pretty closely and covered thickly with silver sand. Into it the cuttings, short, shrubby shoots, with their lower leaves removed, were dibbled in rows as close together as they could stand without being crowded.

Above ten dozen cuttings occupied but a small space, less than 3 feet square, in one compartment of a divided two-light frame. On previous occasions I have used a small frame for Calceolarias exclusively, and I think it the better plan; but it is quite immaterial on their account. The cuttings when planted were well watered, the water being applied between the rows; but they have had none since, though they may have caught a few drops from a sudden shower. For a few days after the cuttings were put in the light was kept over them; but air was not wholly excluded during that period, and was freely admitted throughout the winter when not actually frosty. In severe weather the frame was covered up not very carefully—not sufficiently so for its other occupants, many of which have perished. To-day (March 1st), the plants of Calceolaria are, without an exception, alive and vigorous. The greater part of them have been topped, and they will soon be wanting more room, which they will get in trenches under slight temporary shelter. By bedding-out time they will be bushes. We are within a few miles of the Mendip Hills, on a somewhat lower range.

I hope your correspondent will find this note useful another season. And, now, that I am writing to you once more, you will, perhaps, let me add a general hint as to the preservation of bedding plants by those whose "appliances and means" are limited.

There are some species which, with a little knowledge and management on the part of their cultivator, may be relied on for standing the trials of winter. I recommend the appropriation of one frame or pit to these rather than to those which are of doubtful endurance. Calceolarias, *Gazania splendens*, and *Alyssum variegatum*, I find will survive the cold, damp, and darkness that are fatal to so many others. Of course, such things as *Geraniums*, *Verbenas*, and *Lobelias* may be tried, and success will be in proportion to the skill and care bestowed on them; but, at the same time, it is well to know what we can depend on and need not buy in May; while from a good stock of such plants exchanges may be made, and expense materially diminished.—Geo. R. TAYLOR, *High Littleton Vicarage, Bristol*.

DOES SULPHUR KILL RED SPIDER?

I was rather troubled with red spider in my vineyard until I put flowers of sulphur in my evaporating-pans, and the pest disappeared.

When the fruit came towards maturity I ceased using the vapour bath; and some time afterwards, though too late to do injury, the spider re-appeared, but a heavy syringing freed me from it. I whitewash the walls every year, and into the whitewash I also put sulphur. I fear, however, that my vapour baths have somewhat injured my eyesight when thinning the bunches. This may be an error, and I should like to hear your opinion thereon.—St. OMER.

[We do not think the fumes from sulphur subjected to no higher temperature than that of a hot-water bath, can have any injurious effect upon the eyes.]

"P" in pages 150, 151, asks, Will sulphur destroy red spider? The undersigned cannot decide this. He can testify to the efficacy of soot applied to Strawberry plants affected with red spider. It is an instant and sure cure. Ammoniacal applications are repulsive to and destructive of insects. Years ago, as recorded in the "Florist," I visited and reviewed Mr. Tiley's (Bath) ninety thousand Roses. I then looked over his Strawberries. I perceived one sort almost annihilated by red spider—viz., Kitley's Goliath. After this, I went over my old friend Mr. Farquharson's

garden, at Langton, near here, and saw Goliath as much affected as at Mr. Tiley's. I determined to try an experiment. To enable me to do so, the "then" head gardener gave me some plants as red as if they had been "cayenned"—also some unaffected plants of Alice Maude. It was thought useless to plant them, but I remembered the words of the first Napoleon, "Impossible is not French." So I accepted the Goliaths covered with red spider, and planted them in highly manured and well tilled land; and having planted them, I sent my man for the soot of a recently-swept chimney, and covered the plants and ground with soot, till they were blacker than an African. I never saw more of the red spider. The plants became healthy, and bore fine crops for three years. This fine obtuse-coned Strawberry, which with Wonderful, long-coned, are both subject to white tips, is the best hardy sure-cropping supply for the Queen. Try it once more. Red spider drove it out. Drive out the red spider, and you will find it, though not equal to the Queen and Kitley's Carolina Superba, a very fine and good Strawberry. When healthy the foliage is strong and lanky.

As far as may be, let "P" try a strong dose of soot. Sulphur is, I think, more highly commended for garden miseries than is its due. Out of doors it is not by any means a sure cure for white fungus, commonly, but erroneously called mildew.—W. F. RADCLIFFE, *Rushton*.

Your correspondent "P." has again raised the question, Does sulphur kill red spider? Some years ago I endeavoured in your columns to awaken the gardening world from its delusion on this point, and to obtain the recognition of the fact, that sulphur in no form in which it is applicable had the slightest injurious effect upon the life of this insect. I founded this conclusion on the experience of many years, during which I tried the so-called remedy in almost every way recommended by the best treatises on gardening entirely without effect. Amongst my experiences I painted early in the season the back wall of a greenhouse, fully exposed to the sun, with a thick coat of sulphur and clay, and trained a number of plants closely to it. During the following summer when the sun shone the odour of the sulphur was very perceptible, yet the plants trained against the wall continued as before, the victims of the pest. I placed a pan of sulphur in a Melon-frame. Those shoots of the plants which were trained immediately over the pan became neither better nor worse than those in more distant parts of the frame, but remained in the same state as before the remedy was applied.

I placed a plant covered with the insect immediately over a basin of sulphur set on a hot flue. The following day I found the sulphur melted and the insects as lively as ever. The heat had not been sufficient to decompose the sulphur, or plant as well as insects would have been killed.

As a final experiment (and this completely satisfied me), I placed a Peach shoot infested with red spider on a pan of sulphur set on a warm flue and covered the whole with a bell-glass. After thirty-six hours I examined under a microscope the leaves of the shoot, by that time reduced to sapless tinder; I discovered that the majority of the insects had disappeared—gone, doubtless, in search of a more juicy pasturage. I found none dead, but several apparently in perfect health, hunting quickly about, evidently in the same search as their fellows before mentioned.

Now, it is obvious, that by no means in our power could we produce in a house an atmosphere so charged with the vapour of sulphur as that under the bell-glass. If this failed in the desired effect, how could we hope to succeed with the ordinary application of painting the pipes, &c.?

I have found syringing with soap and water as efficient; in fact, the same as with a solution of the Gishurst compound, this and other similar solutions suffocate such of the insects as they may reach, but their effect is only palliative, not remedial. Observation seems to show that the attack of red spider, though it aggravates the mischief, is more the result than the cause of disease. Apparently a perfectly healthy plant is distasteful to the insect; and if we wish to preserve our trees from its attacks, we must endeavour to obtain a healthy root-action by planting in a suitable soil and securing an efficient irrigation. Is it not found that

the pest is more prevalent on sandy and gravelly soils than on rich loams?—E. T., *Solihull*.

My opinion is, that if carefully and continually applied sulphur will kill this insect, and without injury to the leaves.

Last season, having had charge of a Peach-house which had become infested with this pest, and having heard of sulphur destroying it, I was induced to try it, but as no fire-heat was used, I was at a loss to decide in what form, as it was of no use to paint the pipes. I therefore put a small quantity in a bag, say a pound, placed this in a common watering-pot of hot water, let it stand till cool, and then syringed the trees with it early in the morning, and at shutting-up time, in sunny days. In dull weather I took the opportunity to keep the leaves constantly moist with the sulphur water, which was readily done, as the trees which were most infested were trained over a trellis.

The result was that the leaves were soon freed from living insects, and by continuing the syringing the eggs which were afterwards hatched were destroyed too, and before the fruit began to colour the trees were perfectly free.

As hot water was easily procured, this mode of application was very little trouble, as all I had to do was to take the bag out when the water was cold and place it in another pot. Of course in time the sulphur wanted renewing, but then it did for painting pipes afterwards. I do not attempt to state this as anything new, but simply as the result of my experience last season.—S. R.

HANGING-BASKETS.

As every little contribution to our favourite pursuit has a certain amount of value, I should just like to say a few words on this point. Of those who write on such subjects some make reference to one adaptation of them, and some to another. One thinks of the conservatory where they may prove an addition to the other means of decorating it that he has in view; another, perhaps, thinks of the large and noble hall which my lady likes to see decorated with her favourite flowers; while a third has some handsome drawing-room in which he wishes to place one; and so it happens that we, who are but minnows amongst tritons, have but little regard paid to our wants. Having made what I think a successful hit in this matter, I should like to mention it for the encouragement of others who may wish to try the same plan.

I received some time last year from Messrs. Barr & Sugden one of their Paxtonian baskets, which consists of an ornamental wire basket with an inner lining of tin or zinc. This is provided with a false bottom with holes, through which the water runs off into a receptacle at the bottom. This is supplied with a tap by which the surplus water can be turned off, and which is a great advantage. Well, I had tried various things with more or less success, but none of them satisfied me. It hangs in my sitting-room window fully exposed to the morning sun, so that I was afraid nothing in the shape of Ferns would answer. However, I determined to try; so, having emptied all out, I filled it again with cocoa-nut fibre, and planted in it a nice plant of *Adiantum cuneatum*. This was in August; it grew rapidly, and although exposed during the winter to the dust of the room and the influence of the gas, it has continued green and fresh. It is now throwing up fresh fronds, and will in the course of a few weeks completely fill the basket. Now, as the Maiden-hair is a general and deserved favourite, this maybe a hint that others may feel inclined to adopt. Before I tried it I thought the result would be a failure, and am, therefore, the more glad to chronicle a success.—D., *Deal*.

WELLINGTONIA GIGANTEA.—On the 30th of January I was present at the removal of a large *Wellingtonia gigantea* from Mr. Barron's old nursery, at Eivaston, to some new ground which he has purchased near the Borrowash station. It was removed with about three tons of soil; and there is little doubt but it will do well in its new situation. This, although not the tallest, is, perhaps, the handsomest and most perfect plant in the country. The habit of this fine specimen is so dense that several people can stand on the

opposite side without being seen. The dimensions are as follows:—Height, 14 feet; diameter of branches, 12 feet; circumference of stem, 4 feet 6 inches.—OBSERVER.

SAFETY COCK FOR HOT-WATER APPARATUS.

I LATELY fitted up a small stove with a coil of one-inch pipe inside of the fireplace, Perkins's system, as described by Mr. Fish. This is connected by flanges to a 3½-inch pipe, going round a lean-to house 15 feet long. At the highest point of the pipe I fitted a stop-cock to let off air and fill up the water that might leak, but it strikes me this cannot be free from the liability to explode if too strong a fire be put on. Would a communication with a tank ease the pressure, or do you think it is safe as it stands at present?—A WEST OF SCOTLAND SUBSCRIBER.

[If the tap you speak of serves the double purpose of letting off air and letting in water, there might be danger in such a small place, when a strong fire was used, if the tap were neglected; first, from the cold denser water, when there was no fire, sinking towards the fireplace and leaving a vacuum; and, secondly, from the heat in such circumstances when applied turning the water in the coil into steam. It would be safer to leave the tap open, and in connection with a cistern large enough to permit of the water expanding when heated, and still to have 2 or 3 inches over the tap when the water was cool. Such a cistern could be so constructed with a metal covering as to form a nice little propagating-bed. A few inches of the lid might be left moveable for putting in water, or even taking water out. Such a cistern might be made to suit a hand-glass over it, or, better still, a wooden box with a moveable glass top.

If you have any other mode of supplying the pipes and coil with water, such as a cistern and pipe, the simplest plan as respects air, would be to have an open gas-pipe instead of the tap, the gas-pipe rising, and the open end going outside of the house. So long as you keep your present arrangements, you must turn the tap often. For keeping the pipes full in such circumstances, there is nothing so simple as an open gas-pipe. The open cistern serves the same purpose, and keeps the pipes full of water.]

INFLAMMABLE GAS IN A DUNG HOTBED.

I wish to report the following strange and, to me, unaccountable circumstance as a caution to my brother gardeners how they approach their dung-beds with a light, and also to have it explained by yourself or some of your correspondents.

On the 12th of February I had a bed made of well-tempered horse and cow litter. On the 15th a three-light frame was mounted on it. The frame and lights had been lately painted, but were quite dry before being used. On the 16th the hills were put in for the Cucumbers, and about 3 inches of the mould put over the surface of the bed.

Feeling sure that a violent heat would not rise I put some pots of Verbeuas and other cuttings withinside in the front, a little back air being left on night and day. Finding the heat in it but 58°, I had it closed on the evening of the 21st, as a sharp frost was threatening. On going my rounds that night about half-past eleven, I thought I would see how the frame stood the severe frost to which it was then exposed.

Having ascended the steps at the back of the frame, I had no sooner brought the lamp a little inside it than the light was instantly extinguished, and the inside of the frame was lighted up with a bluish light. A blue flame, too, rose for about 2 feet high over the back of the frame through the upper light which I had pushed down a little in escaping from the flames. As it was my eyebrows were a little singed, and so was the wrist of the hand that held the lamp. The flame lasted for less than twenty seconds.

On the following day I found the Verbena and Hollyhock cuttings at the front of the end lights were singed considerably, whilst those in front of the light that was run down a little had escaped. Now I wish to ask what gas was this, and how did it get into the frame?

I am aware that some gardeners test the fitness of a hot-bed to receive plants by placing a lighted lamp inside the

frame, and if it continues to burn they ridge-out, but if it is extinguished they "wait a wee." This is guarding against an excess of ammonia, I presume, which, though it extinguishes flame, does not itself ignite. Light carburetted hydrogen, whilst it extinguishes flame, is said to burn with a pale yellow flame, but for which distinction I might have supposed it had got into my frame to play its tricks on me, as it does on many a nightly wanderer in our bottoms here. Carbonic acid is, I believe, produced by a fermenting dung-bed. It, too, extinguishes flame; but Johnston (my sole authority on the subject) is silent as to its being inflammable, so I presume it is not. I have asked myself, Could the turpentine used in the paint have given-off an inflammable gas? But I can scarcely entertain this notion, for there was not even a slight smell of turpentine in the frame.

I may mention that the Cucumbers were ridged-out on Monday the 23rd, and all goes on well. The bed is quite sweet, and so it ought to be after enduring such a fiery trial.—J. K., Arch Hall Gardens.

[We never heard before of such an occurrence; but we have no doubt that the gas which had accumulated in the closed frame was phosphorised hydrogen or sub-phosphuret of hydrogen. It is produced during the putrefaction of some animal and vegetable bodies. It has a slight garlic-like smell, and burns with a bluish flame, which pervades the whole vessel containing the gas. It is suggested as the probable origin of the *Ignis fatuus*, or will-o'-the-wisp.]

THE CAPER BUSH.

WE have been asked for some notes on the foreign plants, the products of which are commonly in domestic use, and we will occasionally render this information. It so happens that we have an illustration of the Caper Bush, so we will commence with this.

Capparis spinosa, the spined or common Caper shrub, is a native of walls and rocks in the South of Europe, and especially those near the seaside in the Ionian Islands. On it is founded the Natural Order Capparidæ, and it is included in the Polyandria Monogynia of Linnaeus.



"It is extensively cultivated in the south of Europe, particularly between Marseilles and Toulon, and in many parts of Italy; but it is from Sicily that the greatest supply is brought. The flower-buds form the capers so much used as a pickle and a sauce, but in some parts the fruit is also employed. In the early part of summer the plant begins to flower, and the flowers continue to appear successively till the beginning of winter. The young flower-buds are picked every morning, and as they are gathered they are put into vinegar and salt; and this operation continues for six months, as long as the plants are in a flowering state. When the season closes, the buds are sorted according to their size and colour, the smallest and greenest being the best; these are again put into vinegar, and then packed up for sale and

exportation. Capers are stimulant, antiscorbutic, and are much employed as a condiment, but the medicinal virtues of the plant reside in the root, which is slightly bitter, somewhat acrid and sour, and is diuretic.

"The Caper is, according to Dr. Royle, the Hyssop of Scripture (*esob* or *esof*), 'which springeth out of the wall,' of which Solomon spoke. It produces long trailing branches of sufficient length to be used as a stick, on which the sponge filled with vinegar was offered to our Saviour when on the cross. 'They filled a sponge with vinegar and put it upon hyssop,' says John (chap. xix. verse 29), and this accounts for the seeming discrepancy which some writers fancy they detect between John's and Matthew's account of the crucifixion, because the latter says they 'put it on a reed.' It is the same plant which was used by the children of Israel to sprinkle the blood on the doorposts at the institution of the Passover."—(*Hogg's Vegetable Kingdom.*)

Each bush yields annually about 1 lb. of buds for pickling. About 6000 lbs. in weight are imported into this country every year. They have been used as a culinary adjunct for more than three centuries, for Gerard in the reign of Queen Elizabeth speaks of them as common. He says "The knoppes [buds] of the floures before they open are those Capers, or sauce, that wee eat, which are gathered and preserved in pickle or salt. They stir up an appetite to meat. They are eaten boiled (the salt first washed off) with oil and vinegar, as other sallads be, and sometimes are boiled with meat."

BLUE HYDRANGEAS.

ALLOW me to furnish the following as supplementary to what appeared in THE JOURNAL OF HORTICULTURE on the above subject, a few weeks ago.

Under the steep brow of a hill in my parish, looking due north, stands a cottage on which the sun never shines for nearly three months in the year, and in its garden is a Hydrangea, which for the last twenty-five years at least has never borne any but blue flowers. Last summer it was a complete picture, having nearly twenty fine blooms upon it at the same time. Several cuttings have been taken from it at various times, all of which bore blue flowers.

The history of this plant, which I obtained from the cottager who lived in the cottage above thirty years, and who first planted the Hydrangea, is interesting.

About forty-five years ago a child of the above cottager, then ten years of age, picked up a flower in the road, where it had been thrown from a gentleman's garden, and took it home to her mother, who stuck it in the ground, not in the least thinking it would grow. It did grow, however, and in two or three years bore a pink flower. The cottagers were pleased with their pet, and for its special benefit gave it some horse-droppings, to keep the frost from the root, and to make it grow faster. "Presto!" The flowers were blue in the succeeding summer, and nought but blue flowers have grown on it since. I have seen it with blue flowers for the last three years, and have always greatly admired it.

I was mentioning the circumstance of the blue flowers to a lady friend of mine, who smiled at my ignorance, and said, "What! do you not know that plumbago applied to the root of pink-bearing Hydrangeas will make them bear blue flowers?" This was something new to me, and seemed feasible. But it will not help me to account for my friend under the hill becoming a turncoat through such an application to its root as I have mentioned. It is very hardy, too, never having received any attention during the many winters of its life.—T. R. DRAKE, *Fittleworth Vicarage.*

WORK FOR THE WEEK.

KITCHEN GARDEN.

WE have now arrived at a very important part of the season, and those who have not yet commenced to make proper preparation for their crops must now lose no time, as it is mainly upon that that their future success will depend. We may talk of artificial and other manures, of bad seasons and blights, but most certainly the grand secret lies in the proper preparation of the soil by deep cultivation and good drainage. Manure applied to land in an

unhealthy, ill-drained condition, is very frequently, through the sudden changes of our climate, the cause of disease, and, therefore, the crops become the prey of insects. *Asparagus*, if it was not done in the autumn, dress the beds with light decomposed manure, and fork them lightly over, taking care not to injure the crowns. Some persons apply salt at this time in the proportion of about 1 lb. to the square yard, but it is more advisable to postpone giving it until the cutting is over, and the plants are in a growing state, because they are then in the best condition to receive the benefit of the application, and the crowns are greatly strengthened for the following season. The beds intended for new plantations to be frequently turned, to be in readiness for planting the young roots as soon as they have started 2 or 3 inches in growth. *Artichokes (Globe)*, to be now dressed, superfluous shoots removed, and fresh plantations made if required. As this is generally a permanent crop, the ground should be well prepared by deep trenching, and a plentiful application of rich manure. *Cauliflowers*, give attention to the plants under hand-lights by surface-stirring and giving air on all suitable occasions; tilt the glasses on the side away from the wind in cold windy weather, and remove them entirely on the occurrence of genial showers. Do not let those in pans, or the young seedling plants that are now pricked-out, suffer from exposure to the cold north-east or east winds so generally prevalent at this period of the year. While the present favourable weather continues get all the principal crops of early summer vegetables attended to, whether it be the sowing of Peas and Beans, Radishes, Spinach, Onions, Leeks, Lettuces, or any of those respecting which instructions have lately been given, and which may have fallen into arrear on account of the late unfavourable weather. *Spinach*, when picking over the Winter sort, if the plants were left standing pretty thickly it is as well to remove every alternate one entirely, as it gives a greater facility for stirring the soil, and induces a larger growth in those left.

FLOWER GARDEN.

Cut in all coarse evergreens and shrubs before the buds become too much advanced. This is a good time to cut in Holly-hedges. Whatever ornamental planting still remains should be brought to a close as soon as possible, as planting done after this time very frequently requires much attention in watering, and that at the very busiest season of the year, especially if large plants are removed. Look over beds planted with bulbs, and where necessary stir the surface soil, to keep it open and mellow, and also to give it a fresh appearance. Let all grass edgings, the margins of lawns, &c., be rolled well preparatory to a general edging. This operation may be performed directly the ground has received a good soaking of rain. When edged the roller should be again passed up and down the edges several times in order to destroy the harshness of the line, and to make the grass incline gently to the walk. Sow *Auricula*, *Polyanthus*, *Ranunculus*, and *Pansy* seeds. Make up any deficiency which may occur in beds of the latter. Annual plants, such as *Ten-week Stocks*, *Mignonette*, *Balsams*, *Cockscombs*, *Amaranthus*, &c., should be sown on a slight hothead, and brought forward in pits. *Ranunculuses*, if not already planted, should be put in without further delay.

FRUIT GARDEN.

Where it is intended to head-down old trees for grafting, this should be done at once, and young stock should be grafted as speedily as circumstances will admit. All operations in this department should be completely finished, and nothing remains to be advised at present but to watch for the first occasion when the blossom will require protection. For the protection of the blossom any substance, which keeps off cold and admits air and insects freely, answers the purpose. The inverted shoots of spruce firs tied to the branches, strawbands, woollen netting, birch twigs interwoven amongst the branches, are the materials most commonly in use. Fruit trees in general appear to be well supplied with fruit-buds, and the recent cold weather has had the good effect of retarding the expansion of early bloom rather beyond the usual period, so that with favourable weather we may expect a bountiful supply of fruit.

GREENHOUSE AND CONSERVATORY.

If not already completed, proceed vigorously with the

shifting of specimen plants, and if they are well rooted and in good health, do not be afraid of giving them a liberal shift. Place the plants together after they are shifted, and keep that part of the house rather close and moist for a time until they begin to take root, after which they will require to be freely exposed. Apply water very sparingly at the root until the growth of the plant indicates that it has taken to the fresh soil. The employment of soil containing a considerable portion of decomposed vegetable fibre must obviously be most suitable to dwarf-growing plants, whose natural habit leads to the supposition that such soil, existing on the surface of the earth, must form, from its being readily available to them, their congenial and natural food. Climbers will soon want frequent attention. Prune off all superfluous shoots, stop or pinch out the points of luxuriant leaders in order to induce a flowering habit in those which produce blossoms from the axils of their leaves, and keep them neatly trained and tied. See that soft-wooded plants, as Pelargoniums, Cinerarias, herbaceous Calceolarias, &c., are allowed plenty of space, and that they are regularly supplied with water, and occasionally with clear weak manure water, and kept perfectly clear of insects. Give air freely to these on every favourable opportunity, but do not allow cold winds to blow over them and disfigure their foliage.

STOVE.

Increase moisture and temperature. Let 60° be the minimum temperature for the future, except the weather is very severe. Complete the shifting of all specimen plants here as soon as possible, and keep a sharp look-out for insects. Keep a brisk, growing, moist temperature during the day, and shut up early.

FORCING-PIT.

Continue to remove forced flowers the moment a bud begins to open. Stop the barren shoots of Perpetual Roses. These rob the blossom-buds. Take care that no plants suffer for want of water. This pit as well as the houses should be examined daily. Increase atmospheric moisture, and syringe on most afternoons. W. KEANE.

DOINGS OF THE LAST WEEK.

KITCHEN GARDEN.

THE weather has become much milder, but is still very foggy with drizzling showers, and this heavy ground is not in the best condition for working well. As the barometer still continues to fall, and the season is advancing, we sowed another lot of Longpod and Windsor Beans, and Perfection and Jeyes' Conqueror Peas; also two rows of Peas called Sebastopol, of which we heard wonderful accounts as to their prolific bearing. To prevent anything like potching the ground, we covered all these with coal ashes, which will also help to keep mice and other vermin from them. Gave more air to those Peas sown on turves under protection for transplanting. Sowed, also, more of Tom Thumb in boxes for a similar purpose, and gave plenty of air to those forwarded in pots. Sowed, also, Dwarf Kidney Beans in boxes for transplanting, as this economises room more than when sowing in pots at once, or even in beds in rows. After this time a hotbed of tree leaves with frames would grow Dwarf Kidney Beans well, if not transplanted before the middle or end of the month. Before March it requires much trouble to grow Kidney Beans with the heat from fermenting material alone. Prepared a piece of ground for Turnips and sowing some early vegetables; but the ground is still rather greasy to be laid down for Onions, Carrots, &c.; Parsnips should be put in without delay; but on ground at all heavy Onions will be soon enough sown by the middle of the month, and the main crop of Carrots by the 1st of April. Where there are no crops of Carrots and Turnips coming on under glass, it will be well to sow a piece of the Early Horn Carrot and White Dutch Turnip, or the American Red-top, on a warm border. If a little protection can be given to the Turnips they will tuber better, as a very little frost will cause them to bolt into flower-stems. As soon as the ground is drier will proceed with planting Potatoes now mostly sprung; but a few days will not be lost if the ground is more mellow and in better order. Where a warm position cannot be had and a glass spared to put over it, it would be

well to sow a little Cauliflower on a slight hotbed, for plants to come in after those saved over the winter. Where a continued succession is desired in a small space, it is a good plan to sow a pinch of seed rather thinly every three weeks up to the middle of July, and to sow for plants to stand over the winter in September. We have stirred up the earth amongst the Cauliflower plants under hand-lights, sprinkled the ground with soot, and left off the glasses when there was a mild drizzling rain. Our remaining stock has a protection of a few laurel boughs stuck round the plants, and the largest will be turned out as soon as the ground is a little drier. Our first crop of Radishes is nearly over. Gave them plenty of air and successions also. Some that have been sown between rows of Potatoes in frames will have a struggle to obtain enough of light. Those sown in beds in the open border will come in early if they are covered-up with straw or litter at night. We should have mentioned that the White Turnip Radish answers for many of the purposes for which early Turnips are most wanted and can be had much earlier, and as the leaves are small a great quantity can be pulled from a small space.

Put more Rhubarb and Sea-kale in the Mushroom-house. These, protected with close boxes and pots, and a little litter over them, will soon come fast enough out of doors. Cleared out a bed from the Mushroom-house, or nearly so; for, as it was the elevated bed, and the bottom sparrowed, and the bed below in bearing, if we had taken it out to the bottom the Mushrooms below would have been injured. At this piece we left a part of the old bed remaining, which also suits our command of horse-droppings. On the other half the bed below is just ready for spawning, and therefore what fell through the spars would do no harm; and here we emptied the bed. The spars of wood have openings of more than an inch between them, the spars being 2½ inches in width. On these spars turf was placed; then some spawn, and the prepared dung above, in the usual way. When thus done we have often had plentiful gatherings from the bottom as well as the top of the bed, the Mushrooms coming down freely between the spars. As horse-droppings are apt to be too wet at this season, the material used consisted of horse-droppings with about a third of dry short or chopped litter, and another third of very dry fibry loam, all being well mixed together.

Now is a good time to plant Horseradish; the smallest pieces will grow, but we think the crowns or tops of the plants are rather the best. The ground should be well trenched, and then make rows of holes 15 inches apart, and 6 inches in the row, the holes being from 15 to 18 inches deep, and drop a crown or a piece 2 inches long into the hole, and then fill the hole with ashes. Though Horseradish will remain a long time on the same ground, to have the sticks fleshy and good a plantation should be made frequently in fresh soil. The same may be said of Jerusalem Artichokes. We have known them remain in the same place for a score of years; but when they are much in demand they should be planted every year, like Potatoes, only allowing more space between the rows. Pheasants used to be very fond of them; and therefore they might be valuable in preserves. For Cucumbers, dung-beds, &c., see previous weeks.

FRUIT GARDEN.

A few heavy showers so washed our Pear trees, &c., from the lime and soot that the birds made sad havoc, and, as a last resort, we have been obliged to cover with nets dwarf Pear trees, the thinnings of the fruit from which we sent to the pigs last season. Even enthusiasts for the comfort of the feathered tribe would be apt to scratch their heads on observing the heart nipped out of every nice plump fruit-bud. Some people find strings of cotton, &c., effectual for keeping them away; but I am sorry to say our visitors seem to have been instructed in a wiser school. Even nets are no preservatives, but rather a temptation to them to exercise their inquisitive humps if a single opening is left. Apricots and Peaches will soon want securing and protecting out of doors. As a general rule, if the buds have plenty of air, the longer they are kept from opening the more likelihood will there be of a crop. When moveable protection is given it is well to keep it on during sunny days, and to expose on cool nights until the buds are nearly half open. This will keep the buds later, and the sun will not heat them so much against the

walls, and cause them to come into bloom before there is much heat in the soil at the roots. Nearly finished tying Peaches in orchard-houses, the buds moving but little as yet. Washed the trees again with thin paint, such as described the other week, where any places appeared as if rubbed off with the hand when tying. Disbudded a little in the Peach-house. Cut the remainder of the Grapes in late house with a piece of wood attached to the bunch; sharpened the pieces of wood to a point, and stuck them into turnips, and suspended the turnips in a dry place. Pruned the Vines, washed the stems, woodwork, stages, walls, &c., with soap and water, then painted the Vines with the mixture referred to in the last and previous weeks, and tied them all along the front of the house horizontally, so as to be out of the way till they break; altered the wires for training them to, which were too near the glass; and as soon as the floor and walls are thoroughly cleaned, will cram the whole space, shelves, stages, and floor, with bedding and other plants for a couple of months or so, taking out the hardiest first. Gave air to Vines breaking, and tied others farther advanced. Temperature much the same as detailed the other week. Potted-off Melon plants; drew a dry hand or a feather over Strawberries in bloom, and fear those ripening, even with air and keeping the soil rather dry, will not be of fine flavour, as we have scarcely seen the sun for a fortnight.

ORNAMENTAL DEPARTMENT.

Gave all the air possible to cold pits. Proceeded with putting in cuttings of Verbenas, Geraniums, Salvias, Ageratums, &c., using tiles, pots, old tin spouting, and wooden boxes. Put several hundreds of bedding plants, that were previously well rooted in small 60-pots, into moveable wooden boxes. Cleaned the pots and filled them with variegated Geraniums, to receive a little bottom heat from leaves, and when established to be turned out into boxes or beds, and the same course again proceeded with. We intended using pieces of turf, hollowed-out in the middle, instead of small pots, but we have not any quite fibry enough. Of course, in such a case, the turf would go to the beds with the plants. Prepared for shifting Fuchsias, Geraniums, &c. Pretty well emptied the vineries, breaking and coming on, of all the hardier plants. Will prepare for putting Calceolarias, &c., into earth pits before long; but would like the weather to be a little more settled. Will also turn out the common Geraniums in the same way, where a little protection can be given to them. Thinned-out Pelargoniums in Vine-houses, by taking large plants to the conservatory. Bulbs in small pots will require a good deal of water where fire heat is used. Other things being equal, bulbs, from Hyacinths to Crocuses, bloom rather the best when the pots are rather small and crammed with roots. A little manure water may then be given. It is as well withheld when particularly bright and clear colours are wanted in Hyacinths. When Hyacinths are grown in glasses, a few bits of charcoal in the water will keep the water sweet. Even then, however, it is well to change the water every three or four days, and replace with soft water at about 60°. There will be little difficulty now in keeping up a succession of bulbs with the help of a slight hotbed.

All shrubs as Weigelas, Deutzias, Lilacs, Kalmias, Rhododendrons, Azaleas, &c., are easily forced now, if started gradually at from 45° to 65°, and more especially if the roots have a bottom heat of 5° to 8° above the atmospheric temperature. Roses, to do well, should be started gradually; they do not like much bottom heat, but a nice regular heat, such as they would have when plunged in sawdust, would just suit them. Insects must be looked after. Azaleas and Rhododendrons, and Camellias finished blooming, should be kept growing in moist heat, to set their buds early for next winter. Heath, in greenhouse and conservatory, must now have abundance of air; Epacris, Croweas, &c., will do with much less. The first will now be mostly in bloom; and one advantage of the tribe is that they will grow in a house with softwooded plants, and be all right, when Ericas would be almost sure to be covered with mildew. Cinerarias, to bloom well and be free from insects, can scarcely be too cool and moist at bottom. Herbaceous Calceolarias do best when treated in the same way. If the pots stood on damp moss, and the temperature averaged from 40° to 45° at night, there would be little chance of green fly paying them a visit: hence, when in bloom in May, they will do better in a

shady house, or better still in a house with a north aspect, because there they will have light, and yet be comparatively cool. Not but the pretty colours will be as fine, or finer, in bright sunshine under glass, even if the temperature should be higher, if the roots are cool and moist. Let these become dry and hot, and we will guarantee that ere long the fly and the thrips will attack the plants in shoals.

FIRING.

We are just reminded of a promise to say something of the simplicities as respects the management of stoves, furnaces, boilers, &c. The first essential to success is suitability in materials. Not so long ago a poor fellow was nearly smothered in trying to light an iron stove. On examination it was found that the wood and the fuel were dripping wet, which made the damp chimney still damper, and this caused the smoke to come back instead of mounting the chimney. For all such stoves where the least back draught would be undesirable, the materials used for lighting the fire cannot be too dry—such as dry paper, dry shavings, and dry straw—to send a volume of heated air through the smoke-shaft. The wood for stoves should also be thoroughly dry, and the coke or coal used also dry and in rather small pieces, not much larger than walnuts. When forethought is used it is just as easy to have wood, &c., dry as otherwise.

The same rule applies to furnaces of all kinds, but in a less degree. Small handfuls of wood tied together are useful for this purpose, and most gardens supply enough from prunings and other sources, and the chopping and preparing them is a good job in a wet day. Where willows and string are uncomatable, a small band of straw is a good thing to tie these small bundles with; and a little bit of straw tied with each gives you all the materials for lighting at once, and if stood in an airy shed they will always be in good trim for use. Even with this care when flues are very long and have several turnings in a house, or through a back wall, and the flue is damp from disuse, the fire may refuse to draw nicely at first: hence, it is useful to have a moveable soot-door between the furnace and the chimney, and by opening that and having some dry material in the flue all will go on well and comfortably, as the heat there not only sends out the heavier air and warms the shaft, but acts like a pump-sucker in pulling up the heavier air near the furnace. When we had no such openings in the flue and were troubled by the want of draught, we have gone to the top of the chimney and lighted a wisp of straw and put it down there. Unless where flues are very long, such expedients need scarcely ever be resorted to if dry material is used for lighting.

Fuel.—For all iron or brick stoves that stand in plant-houses, the best fuel is clean cinders, or coke pretty well broken. Neither of these will clog the soot-pipe like coals. No fuel will be safe where there is no escape by a smoke-pipe. For furnaces in general anything may be burned. For making up fires a few ashes are often useful for banking-up furnaces the last thing at night. For setting the fire again, at first small coals are very useful—such as those called riddle-nuts. After that it matters not much what is burned, only the better the fuel the more the heat from it. When such things as ashes from the mansion are used and not much screened, they should be put on in a damp state. Of course, that will be after the fire is fairly lighted. When thus used nothing will be left of such ashes but a thin vitrified clinker. There is seldom any advantage in too small a furnace, if the heat from it goes freely into a flue, acts on a boiler, &c. If very large some heat would be lost, and the fuel burns better and gives out more heat when compactly placed instead of being sprawled over a large surface.

Regulating the Draught and the Amount of Heat.—In stoves and fires this is best and most safely done by means of the air admitted by the ash-pit-door through the grate-bars. The doors of iron stoves, and even furnace-doors, cannot be made to fit too tightly, and it always denotes imperfect management when they are seen much open. Thus, when lighting an iron or brick stove inside of the house, the ash-pit door should be open to secure a good draught through the bars. As soon as the fire is established, and fuel is added which you wish to burn slowly, the ash-pit-door should then be shut as well as the feeding-door. If the smoke-shaft is short and straight the fuel will get enough of air by that

means; if long or bent it will be necessary to have a small opening in the ashpit-door, though not often more than a quarter of an inch. The doors for common furnaces cannot often be kept so air-tight, and therefore an opening in the door is less necessary. A very small opening in the feeding-door above the fuel will greatly diminish the volume of smoke. When it is necessary to concentrate the heat about a stove, a furnace, or a boiler, a damper in the smoke-vent should also be provided. This damper must be used carefully when the stove or furnace stands in a house among plants. To avoid injury by the inexperienced in such cases, it would be well to have a common damper with a few small holes in it for draught; and then the damper should always be in, unless when the fire is being lighted. If the ashpit-door, however, is properly attended to, dampers will be of comparatively little use, unless when a furnace is used chiefly for heating a boiler. Then it is necessary to concentrate the heat from the fuel about the boiler. Instead of the unpleasant task of attempting to settle differences of view, let us tell how such a furnace should be managed. On lighting a fire pull out the damper, so as to give free vent. Clear the furnace-bars, and as soon as lighted shut the feeding-door, and open the ashpit-door. See that the ashpit is all clear. Place clinkers in one place, ashes and cinders in another to be wetted, and sweep the place round the furnace. If there is an old broom there it will all be done in a very short time. Never let the feeding-door be open unless when necessary for fuel, &c. We have known such doors stand open night and day, and as much fuel burnt in a day as would have served a week—a good idea for those who are generous enough to heat the atmosphere of their neighbourhood instead of the atmosphere of their houses. When the fire has fairly taken hold, put the damper in half way, and shut the ashpit-door. If it shuts very close, leave a quarter of an inch open. When the pipes and water are pretty hot, shut the damper farther in, so as to leave from a quarter to half an inch. As a general rule, then, after a good fireman has his fire established, he will have his furnace feeding-door, and his ashpit-door shut, and the damper pretty well in. Even if the fire goes out, and he wants no more heat, he will let well alone, because the opening of either of these would let cold air round his boiler; whilst economy says, Keep that cold air from it. True it may be necessary to open the feeding-door, and even take out the fire, or damp it with ashes when the heat is too strong—when, in fact, fuel is to be wasted; and this waste will take place with all haphazard stokers, who just make a fire as a matter of course, without any reference to present or anticipated circumstances. Such a thing will rarely occur with a thoughtful manager of furnaces. Shall we tell how he manages? Before he puts a fire on he examines the thermometer out of doors, looks to the heavens, and tries to prognosticate what the weather will be, goes into the house, notes the thermometer there, whether rising or falling, feels the pipes or flues with his hand, and forms an idea whether such heat will be sufficient, or if more is wanted, and then, and not till then, he goes to his furnace and does what is requisite. Such a man would never pitch on a barrowload of coals when a peck would be sufficient. We have known first-rate gardeners decline to take a young man merely because they saw how he mismanaged his furnaces.—R. F.

COVENT GARDEN MARKET.—MARCH 5.

The supply of Greens, such as Brussels Sprouts, Savoys, and the various Kales, continues good; but in Cornish Broccoli there is a falling off. A few Green Peas have come in from the continent, and importations of French salads, Carrots, and Radishes are well kept up. Old Hothouse Grapes are now nearly over, and the new are improving in quality, but are short in quantity. Pines are still sufficient for the demand. In Pears some good samples of Easter Beurré, Beurré Rance, and Ne Plus Meuris are still to be had. Apples mainly consist of Blenheim and American Newtown Pippins, Reinette Grise, and some nice Winter and Golden Pearmain. Cut flowers are the same as last week.

FRUIT.

	s.	d.	s.	d.		s.	d.	s.	d.
Apples.....	2	0	4	0	Mulberries.....	0	0	0	0
Apricots.....	0	0	0	0	Nectarines.....	0	0	0	0
Figs.....	0	0	0	0	Oranges.....	4	0	0	0
Filberts & Nuts 100 lbs.	0	0	0	0	Peaches.....	0	0	0	0
Grapes, Hothouse...lb.	20	0	30	0	Pears.....	8	0	12	0
Foreign.....	1	6	2	0	dessert.....	6	0	10	0
Muscats.....	0	0	0	0	lb.....	6	0	10	0
Lemons.....	4	0	10	0	Pine Apples.....	0	0	0	0
Melons.....	0	0	0	0	Pomegranates.....	0	0	0	0
					Walnuts.....	14	6	20	0

VEGETABLES.

	s.	d.	s.	d.		s.	d.	s.	d.
Asparagus.....	8	0	14	0	Leeks.....	0	4	0	0
Beans, Broad.....	0	0	0	0	Lettuce.....	1	0	2	0
Kidney.....	2	0	3	0	Mushrooms.....	1	0	2	0
Beet, Red.....	1	0	1	6	Must. & Cress, punnet	0	2	0	4
Broccoli.....	0	5	2	0	Onions.....	3	6	6	0
Brussels Sprouts ½ sieve	1	6	2	6	pickling.....	0	6	0	8
Cabbage.....	0	0	0	0	Parsley.....	0	4	0	0
Capsicums.....	1	0	0	0	Parsnips.....	0	9	1	0
Carrots.....	0	6	0	8	Peas.....	0	0	0	0
Caniflower.....	4	0	8	0	Potatoes.....	6	0	9	0
Culery.....	1	6	2	0	Radishes doz, bunches	0	0	0	0
Cucumbers.....	2	0	5	0	Rhubarb.....	1	0	1	6
Endive.....	1	3	2	6	Savoys.....	2	0	3	0
Fennel.....	0	3	0	0	Sea-kale.....	1	6	2	6
Garic and Shallots, lb.	0	8	0	0	Spinach.....	2	6	4	0
Herbs.....	0	3	0	0	Tomatoes.....	0	0	0	0
Horse-radish.....	1	6	4	0	Turnips.....	0	4	0	6

TRADE CATALOGUE RECEIVED.

H. Brown, 4, Commutation Row, Liverpool.—*Descriptive Catalogue of Select Vegetable and Flower Seeds. Select Catalogue of Roses.*

TO CORRESPONDENTS.

* * We request that no one will write privately to the departmental writers of the "Journal of Horticulture, Cottage Gardener, and Country Gentleman." By so doing they are subjected to unjustifiable trouble and expense. All communications should therefore be addressed solely to *The Editors of the Journal of Horticulture, &c.*, 162, Fleet Street, London, E.C.

We also request that correspondents will not mix up on the same sheet questions relating to Gardening and those on Poultry and Bee subjects, if they expect to get them answered promptly and conveniently, but write them on separate communications. Also never to send more than two or three questions at once.

N.B.—Many questions must remain unanswered until next week.

ORANGE TREES, REPOTTING (*J. L. C.*).—The best time to pot or retub Orange trees is in the spring, and the best compost, loam from rotted turves two-thirds, and well decomposed hotbed manure one-third. If the loam is stiff, a free admixture of river sand will be advantageous. Keep the Vines cool, but not exposed to frost, and no harm can possibly happen to them if not started until March.

CORRESPONDING (*Z. W.*).—No; we are always willing to answer inquiries.

CHRISTINE GERANIUM SPOTTED (*C. H. R.*).—This is the second case that has come under our notice. There is no trace of fungus on the leaves, and we can only attribute it to a deficiency of light and ventilation, and too humid an atmosphere. Dust the leaves with sulphur, and give more light and air. Drip from the roof would not cause the leaves to be dotted and blotched with silver; it would make them decay more quickly. Christine Geranium requires the same treatment as bedding Geraniums in general.

PINE-APPLE CULTURE (*F. Chilly*).—Our correspondent will find his queries fully answered in No. 27 of our new Series, page 9, and in the following Numbers.

DAPHNE ODORA DISEASED (*S. C. O.*).—The leaf fan enclosed looks as if affected by some parasitical fungus. Dust the leaves with fresh-slacked lime, taking care to have the leaves dry. See that the drainage is perfect, and that the soil about the roots is sweet. The plants are probably at some distance from the glass, and overshadowed by other plants. The roots are most likely unhealthy or destroyed by some cause, such as manure water, a rich soil, imperfect drainage, or an improper compost. Make the plants all right at the roots, and give abundant light and ventilation.

GISHURST COMPOUND, APPLYING (*A Constant Subscriber*).—Four ounces to the gallon of rain water for destroying thrips and aphids—that is, if the leaves are of a firm texture; but if the leaves are thin and soft a solution at the rate of 2 ozs. to the gallon of water is strong enough. It should be applied with the syringe, taking care to wet every part, and this should be allowed to dry on the plant, but it should be washed off the plants twenty-four hours after it is applied. For hugh and scale a solution made by dissolving 8 ozs. of Gishurst compound in a gallon of rain water should be applied with a brush to the stems of plants infested with scale, or into the joints and crevices of those infested with mealy bug. The leaves are to be washed with a sponge dipped in the solution, taking care to dislodge the insects, and being careful in washing not to bruise or break the leaves and stems. The Gishurst solution should be washed off, twelve hours after it is applied, by syringing the plant with water at 120°. Full directions are, or should be, sent with the compound.

CHRYSANTHEMUMS STOPPING (*Idem*).—The shoots are to be stopped when from 4 to 8 inches high. Stop the laterals when sufficiently grown, and so on until July, so as to produce even-shaped plants. The plants should not be stopped after July for early blooming, but those for later bloom may safely be stopped until the latter part of August.

AZALEAS IN HEAT AFTER FLOWERING (*Idem*).—Decidedly. Pot them, and place in a moist and rather shady atmosphere until the growth is made, when they should have abundant light, so that the buds may be perfectly formed. No place is better than ainery where forcing has been just commenced.

CARNATIONS AND FICOTREES (*D. C.*).—Apply to any of the principal florists who advertise in our columns.

GRAPES IN CAMELLIA-HOUSE, &c. (J. H.).—Black Hamburgs will be the best for such a house as you name. Camellias will stand, and be better when making their wood and forming their flower-buds, that degree of heat suitable for Black Hamburg Grapes—namely, a maximum temperature of 70° to 75° at night, with 10° or 15° more when shut up with sun heat. You will require four rows of four-inch pipes along the front and both ends of the house you describe.

OLEANDER TREATMENT (Rebecca Hey).—A temperature of from 65° to 70° is too warm for the Oleander, and must be very much too high for a conservatory, even if it be filled with stove plants in winter or at this season. Nerium Oleander being from the south of Europe, where it is found on the borders of rivulets, requires only a greenhouse temperature in winter. We advise you to have cuttings taken at once of the half-ripened shoots or such as are not old. Take them off with three joints, cutting them immediately below the lowest, and removing the lowest pair of leaves. The cuttings are then to be inserted singly in small pots and placed in a gentle heat of 70° to 80°, where they soon root. They will strike if placed in a bottle of water, but we prefer putting them in small pots at once in tarty loam one-half, and leaf mould one-fourth, with a liberal admixture of sand. The cuttings are potted as soon as the pot gets full of roots, and a fortnight afterwards the shoot is cut to three joints. This encourages side-shoots. When the shoots are a few inches in length the plants are shifted into larger pots (18's), and the soil kept wet. The plants are grown on in a vinery, and the pots placed in a saucer of water kept full. In July, or when the growth is made, the saucer is removed, but the plant is kept well supplied with water, and placed near the glass and in the full sun. This tends to ripen the wood, and the buds forming at the ends of the shoots. After August the soil is just kept moist, so that the leaves may not flag, and in October the plants are removed to a greenhouse, where they only receive water when the soil is dry. In April they are placed in a vinery at work, or in any light house with a gentle heat. When the buds begin to swell the pots are placed in saucers of water, and these are kept full until such time as the blooming is past and the growth made. After blooming the plants are pruned-in, and potted when the shoots have grown a couple of inches. This is our treatment of this plant. By comparing it with your own you will be best able to tell whether your plant is properly treated or not.

WOODLICE IN CUCUMBER AND MELON-FRAME (S. A. C.).—Your plan of placing some hay in a flower-pot to catch woodlice is a parallel case to the sportsman that took his gun and went out, leaving the powder and shot at home. Had you wrapped the hay loosely round a boiled potato, and placed it in a flower-pot, and then laid it on its side at night within the frame, you would have done terrible execution by going in the morning and shaking the hay over a pan of boiling water. As it was, you offered no inducement to the insects to enter the hay. Our plan is to wrap a boiled potato loosely in a little hay, place it in a flower-pot, and lay the pot on its side within the frame in the evening. In the morning we take a pan of boiling water and shake the hay over it, and the woodlice fall into the boiling water. The potato is then again wrapped up in the hay and placed within the frame at night. This plan persevered in will soon rid frames of woodlice. Two baited pots are enough for a one-light frame, one at back and another in front. A toad or two in frames will also be found very serviceable. We always have one in each frame, and sometimes two, and we have no trouble with woodlice. A lean toad weighing 1½ oz. we put in a frame last season on the 21st of March, and it grew so fast, and fattened so rapidly, that it could scarcely crawl about on Midsummer-day, when it weighed 6 ozs. 12 dwts. We make a practice of employing these animals largely for the destruction of woodlice, and have had them so tame that they would feed from the hand. We had in a fernery a frog which had lost the use of a leg for five years, and this gentle animal was always ready for its meal of worms, but woodlice it refused to take. We advise you to put a toad or two in your frame this season, and you will have no further trouble. The Bean straw could not have anything to do with the woodlice.

RUST ON GRAPES (A Three-years Subscriber).—The rust on your Grapes may be caused in various ways while the berries are young and the skin very tender. It is generally considered that it is caused by the berries coming in contact with the skin of the hands while thinning them, as well as by contact with the hair of the head, the oil from the skin and hair filling up the pores of the skin, and preventing the part of the berry so affected from swelling or expanding naturally. Cold currents of air, while in this young state, are said to, and may no doubt, be productive of the same effect; but by far the most common cause is rubbing the pipe with sulphur any time after the Grapes are coming into bloom till after they are stoned. This will produce it with a certainty, if the pipes are heated to make the fumes strong enough, with the object of keeping red spider in check. We know of no remedy after the berries are affected.

USE OF A GREENHOUSE WITHOUT HEAT (An Inquirer).—You can have nothing in your greenhouse that will not stand a pretty severe frost. The uses to which it may be applied under such circumstances must be limited to things that are perfectly hardy. We know of nothing that will make your house more interesting than some of the many hardy shrubs that fancy or taste might select. It will take much more money to make your greenhouse look respectable by furnishing it with hardy things, if you have them to buy, than would suffice to fit up a common stove in it, and so keep the frost out, and save many of the plants with which you furnish it in autumn; and a few shillings would suffice to put up a stove to keep the frost out of a small house.

GERANIUMS FOR BEDDING (Devoniansis).—Helen Lindsay and Lord Palmerston are two very fine Geraniums, of recent introduction, and have proved fine sorts under ordinary circumstances; but whether they will do well on your wet soil, in a cold late district, remains to be proved. They are, however, plants of a good hardy constitution, and unless your soil is very wet, we should say they will succeed. Lady Roxbury, we fear, will grow too strong to bloom well with you, unless you plunge it in pots instead of planting it out in the bed. Trentham Rose flowers well almost everywhere. Herald of Spring is not a very free-bloomer when planted out, but is fine in pots. Admiration is a very fine free-flowering sort. Crystal Palace Scarlet is so much like New Frognore in all respects that it matters little which of the two is grown. Doubtless it will do well in your heavy soil.

HEATING A GREENHOUSE (P.).—We think the heating will be quite sufficient, but you will need evaporating-pana on the top pipe (3). The improvements we would suggest would be to widen the path 3 or 4 inches, and to keep the glass at top a foot from the wall.

CYANOPHYLLUM MAGNIFICUM (E. P.).—Do not cut it down. At any rate, replot the plant into a large pot, giving it some nice sweet soil, and good drainage, and place in a moist, growing, warm stove temperature. Shade from very bright sun, and avoid syringing the leaves, and prevent drip falling upon them. Your plant is either cramped at the root, or the leaves cannot unfold through too low a temperature or a dry atmosphere.

RHOODODENDRON JAVANICUM (E. S., Hants).—This Rhododendron does well out of doors, or in cool greenhouses in summer, and needs only a cool house in winter. There is a coloured drawing and description of it in the fiftieth volume of "Paxton's Magazine."

SHELF OR PROPAGATING PURPOSES (E. P.).—We have no recollection of the circumstances in which the advice was given to reserve the top shelf of a greenhouse for propagating purposes. A good gardener will make any place suitable for such purposes; and such a place as a top shelf may be very suitable for Scarlet Geraniums in the autumn, and for succulents at any time. For general purposes, however, we should never think of comparing such a shelf with the advantages of a bark-bed. You should give more definite references.

DEFICIENT BOTTOM HEAT (J. E. Wallace).—So far as we can make out, you ought to have heat enough to sear and burn the roots of anything; and so we think we could secure for you were present. We see no necessity for the way you have placed your slates; they might have been level on the bars, and close or open, as it pleased you. We do not quite understand the broad openings at each end of your chamber; but we think that it is something owing to them, and the upright pipes from the chamber, that the heat gets into the house without passing through your plunging material. Stop these boards securely; plug up these pipes also securely; put 4 or 5 inches of sand or ashes on the slate, and then let us know if they do not get hot. You must remember that even then the surface of your plunging medium will be much the same temperature as the atmosphere of the house, unless you prevent radiation of heat by covering the plunging medium with glasses, &c. When once the plunging medium is hot enough, it is easy keeping it so by regulating the plugs and openings. Unless something of this is the cause, we confess ourselves nonplussed.

MOSS ON GRASS LAND (S. W. G.).—We fear it is almost too late in the season to do much to your grass land, as you mention having well harrowed it; but a dressing of lime—say three or four chaldrons per acre—would do good. But a more effectual way is to give the land a good dressing of compost, in which mould in large quantities is used—say twenty or twenty-five loads to the acre. Lay this on as early in the autumn as you can; of course taking care not to spoil any great quantity of grass feed. A good harrowing previously so as to tear up much of the moss will be of service. The dressing being put on in autumn gives it time to be well mellowed down in winter, during which it may be gone over with the brush or ring-harrow. We have found this the best remedy for mossy land; but after a lapse of years it is necessary to repeat it. Lime is good for a time, but it is quantity that kills, or rather overcomes, the moss.

SEASAND FOR CUTTINGS (J. C.).—We do not know the composition of the seasand on the Somersetshire coast; but if it is silicious, and thoroughly washed to remove the saline impregnations, it would probably answer.

YELLOW EVERLASTING-FLOWERS (Inquisitive).—The most common are *Helichrysum* (*Gnaphalium*) *arenarium* and *Stoechas*.

ORNAMENTAL GRASSES (J. B.).—No. 1 we do not recognise; 2, *Lagurus ovatus*; 3, *Briza maxima*; 4, *Airopsis pulchella*, or the top of some slender *Agrostis*. In addition are recommendable—*Avena sterilis*, *Bromus jubatus*, *Briza minor*, *Brizopyrum scitulum*, *Eragrostis abyssinica*, *Agrostis nebulosa*, *Lamarkia aurea*, *Setaria macrochaeta*, *Setaria auricoma*, *Panicum capillare*, and many more.

FLOWER-GARDEN PLAN (A. E. L.).—We think your centre, and the eight beds round it formed of four pairs, will look very nice. We do not think having the next ring of eight beds all planted alike would look so well, and more especially as the beds will be all one-sided. As you have commenced pairing we would continue it, either by crossing or having the figures opposite, even if you used the same materials. The four opposite 6, or crossed, of *Perilla* centre, row on each side of *Calceolaria*, and the edging all round of *Lobelia*. Then four, *Trentham Rose* for centre, *Perilla* or *Amaranthus* round, and the edging of *Alyssum* round. The rest as proposed.

PEAR TREES AT TRENTHAM (A Subscriber from the Beginning).—As far as we recollect, the Pear trees with many sorts at Trentham were grafted, the scions being shipped in at the sides of the branches at the usual time, and often with fruit-buds. Budding is best done in summer.

GRASS SEEDS FOR LAWN (P. P.).—You do not tell us whether your soil is heavy or light, nor whether the grass now growing on the lawn is coarse or objectionable, how then can we advise you with decision? We must suppose the soil of medium quality, and the grass not coarse; and if these data are correct, then we advise you to rake the lawn now, and sow it at the rate per acre of 8 lbs. Crested Dog's Tail (*Cynosurus cristatus*), and 4 lbs. Small Yellow Clover (*Trifolium minus*). You may prune your Roses now; but remember that different kinds require different pruning. You will find full directions in the "Garden Manual," which you can have free by post from our office for twenty postage stamps.

CAMELLIA (Ignoramus).—The emphasis is on the 6.

TEA PLANT, &c. (T. Daly).—You will require a stove to cultivate some of the plants you name. Write to any of the chief nurserymen who advertise in our columns. If you send a post-office order for 17s. 4d., with your address, you can have this Journal free by post for twelve months.

NAMES OF PLANTS (Orchidophilus).—1, *Grugru* nuts. These are not "nuts" in the true botanical sense, but the stones of certain Palm fruits. More than one species affords them, though generally they are obtained from *Arecocmia sclerocarpa* (Mart.), a very common West Indian Palm usually known as the "Macaw Palm," or in Guiana and Brazil, where it is equally common, by the names "Macoya," "Macahuba," &c. The perfect fruits are about the size of *Orlean Plum*, quite globular, smooth, and when fresh of an olive green colour. They have a thin woody rind, underneath which is a layer of fibrous gelatinous pulp or flesh surrounding the hard stone or "Grugru nut," and this again contains a single seed. The fruits of several species of the allied genus *Astrocaryum* also contain hard black or dark brown stones, which the natives of many parts of South America polish and carve into various rude forms, or use for the knobs of their knitting or weaving pins. 2, *Letterwood*, is the heartwood of an *Artocarpaceous* tree, *Brosimum Aubletii* (Poepp. et Endl.), formerly called *Piratinera*

guianensis by Anblot. It is a very beautifully-marked and extremely hard wood, but unfortunately is obtainable only in pieces of small size; for although the trunk attains a diameter of 2 or 3 feet, it does not afford a greater thickness of heartwood than 4 or 5 inches. Moreover it is very liable to flaws, which spoil its utility as a turnery wood. 3, *Supple Jacks*, are the thin flexible stems of climbing plants belonging to the genus *Paullinia*, and perhaps to *Sebania* also. Probably several species produce them in the different West Indian Islands. We have seen capital ones from *Paullinia curassavica* (Jacq.), one of the commonest Jamaica species. 4, The red seed brought from the West Indies is the seed of *Adenantha pavonina* (Linn.), a small East Indian tree affording a heartwood, which is one of the red sandal woods of India. It is not a native of any part of the western hemisphere, but was long ago introduced into Jamaica and other of the West Indian Islands, in some of which it has become so thoroughly naturalised, that persons not acquainted with its history would suppose it to be really indigenous. In Jamaica the seeds are known by the names "Circassian Beans," "Lady Cootie Beans," and "St. Vincent Beans." Their chief use in the west seems to be for stringing together and making various small ornamental articles, such as work-bags, horses' necklaces, bracelets, &c.; but in the east, in addition to this use, they are used by the native jewellers as weights, each, it is said (we will not vouch for the fact), weighing almost uniformly four grains.—A. S. (*J. B., Amateur*).—No one from a single flower can tell the name of a *Cineraria* or a common *Pelargonium*, the varieties being myriads, scarcely differing from each other. (*Thomas*).—1, *Abies* (or *Picea*) *Douglasii taxifolia*; 2, *Laminum maculatum*. Your *Grapes* are attacked by "the spot." Probably the roots of the Vines are too cold. (*J. W. C.*)—*Scilla fibrica*. Propagated by offsets of the bulbs, and succeeds in a light dry soil. The offsets may be planted in autumn. It is a hardy plant. (*G. D.*).—1, *Pteris crenata*; 2, *Pteris serrulata*; 3, *Lastrea acuminata*; 4, *Aspidium trifoliatum*. (*J. W., Melville*).—Specimens very insouciant. 1, not identified; 2, *Adiantum affine*; 3, *Pteris serrulata* apparently; 4, *Pteris hastata macrophylla*.

POULTRY, BEE, and HOUSEHOLD CHRONICLE.

NOTES BY A CROSS-GRAINED CONTRIBUTOR.

It is, as said by La Rochefoucauld, or La Bruyère, or La Somebody else, that "no man ever heard of the misfortune of a friend without a secret feeling of satisfaction." People deny this, and say as they used to say of clever, straightforward Thackeray, "It is painting us too black, and human nature is not so bad as it is made by these writers." Look within, good friend, and if the "accusing Byers" has occasion "to fly up to Heaven's chancery" every time we are guilty of the above, he will be backwards and forwards all day. How many console themselves under a misfortune by the reflection, they have only neighbour's fare? Are we quite sure when we profess to have only "justice and the good of the pursuit in view," in writing about malpractices at shows, that it is strictly true? Is there nothing personal in it—disappointment of self, jealousy of, or hatred to another? And, again, the desire to see all marks done away with. Moonshine all, my merrie masters. Do you recollect Rob Roy's leather purse? It was contrived so that if any one tried to open the lock a pistol exploded to the great danger if not injury of the thief; but the goodly freebooter forgot, when he prided himself on the security it afforded, that any sorry knife would divide the leather without risk or trouble. Just so. Marks on the eyelids, the beaks, the nostrils, *et hoc genus omne*, are guides for dishonest judges, or they are nothing. A German proverb says, "If you want to throw a stone at a dog, you can always find one;" and if an exhibitor and a judge are dishonest enough to play into each other's hands, what prevents one from giving the other the numbers of his pens? If they keep their counsel, detection is impossible and marks are unnecessary.

The success and pleasure of a poultry show depend entirely on the conviction entertained by exhibitors that the judges are men of integrity. Having them, let them be satisfied and support them, not damn them with silence, and seek to injure them with a shrug or a shake, but treat them as those who deserve well of their friends. There are some who have once or twice officiated as judges at small shows, and who, therefore, think they can speak with authority. Compared with experienced judges they are tyros; and when they put themselves in opposition to such as officiate at Birmingham, they always remind me of the guard of a coach many years ago. I had occasion to go into Norfolk by coach, the horses ran away and the coach was upset. I needed a conveyance and a guide to go some distance into the country on the morrow. The guard of the coach offered to provide the former, and act as the latter. He was a burly man, and he brought a very small pony. His manner was very civil and somewhat amusing in the morning; but he knew every one and stopped often. In the afternoon I could say as it is often said in police courts, "Couldn't say he were drunk,

your Worship, but he smelt strongly of beer." His speech was fast, his utterance thick, while he explained he had been sixteen years guard, and spilled three times, counting the night before. "He only wished he drove. He'd like to see the horses run away with him. Look'ye, sir, this is the way I'd serve 'em!" and with that he would pull the poor little tired pony from one side of the road to the other. "I have 'em under command. Look now!" The whip was applied till it caused a rickety spasmodic gallop. "Whoa!" shouted my Jehu, and pulled the poor little animal on its haunches. "There, I should keep 'em in hand." I mildly said I was satisfied, but ventured to remark there was a difference between four first-rate horses and a pony. A smile went across his face, when he said, "Ho, ho, sir! the difference is in the men."

The Game classes at Birmingham, compared with other shows, are the four horses to the pony. The coachman represents the practised judges, the three "spills" in sixteen years the mistakes that must occur in the "best regulated" shows, and the guard driving the pony is the section of the public looking on at the decisions, and explaining how they would have judged. Many, I do not say all, have little idea how different it is to judge judgments rather than large classes; and of the remainder, few know the difference between judging a local show (where the most partial reporter can only say, "The Game were not numerous, and it is evident exhibitors have something to learn in dubbing and matching. Nevertheless, if the legs had been alike, if the hens had matched the cocks, and the birds had been better, the Judge would have had more trouble"), and the array at Birmingham. Hundreds of pens without a glaring fault, and twenty alike almost to a point or a feather. Twenty thousand spectators would pass a pen of marked birds without seeing it, and nineteen of them would not find it unless it was shown to them. Do you shake your head? Did you ever search for Peewits' eggs? Guided by a practised hand, you soon spring a screaming bird, flying in curious figures. He says she has three eggs. He advances a few steps. "I can see them." "Where?" "There." "I can't see them." "Look." You walk about, and strain your eyes till a crunch under your foot tells you you have stepped into the nest. If you doubt, try. The two are very much alike.

I would much rather criticise the judgments of the judges than do their work for them.

SCHEDULES OF POULTRY SHOWS.

"A COMPILER OF THE DARLINGTON SCHEDULE," in your *Journal* of February 9th, very naturally defends his offspring. In my analysis of the Darlington Show entries I said that the schedule was very good, requiring simply increased prizes in some classes. About this point I can now speak practically, having received for a prize obtained there a few stamps, the carriage which the Darlington Committee had paid having swallowed up the remainder; consequently, the return journey left me woefully out of pocket, save in honour.

"A COMPILER" must not imagine that in giving my opinion that at Darlington the diminutive Bantam did not receive justice, therefore I am interested in these pigmies of the poultry line: far from it. I have endeavoured in my various analyses, in which he kindly says he has been interested, to point out certain breeds which are not, even at our leading shows, treated as they deserve. I have striven to do this impartially, though many of your readers could see the drift of my arguments. Indeed, I have advocated the diminishing of prizes offered to some breeds in which I am particularly interested.

But, "A COMPILER" asks, "Why should the prizes be increased if we can get a good show for prizes of £1?" Well, I reply, simply on the ground of justice; and I ask the winners of the second prizes, 10s., how much the prize was worth, deducting expenses. I presume that exhibitors in a small way (and I certainly speak for myself), like to believe that they will win, and they like to calculate that after this pleasure there will be a tangible something on the right side. I am certain that for distant exhibitors this was impossible, as regards the second prizes in many of the classes

at Darlington; neither do I think that the Bantam classes would have filled so well but for the silver cup. He rightly argues that the larger breeds, as more useful, should receive greater encouragement; but Bantam-breeders will tell him that they are not only ornamental but useful—that they are, though small, very nice on the table—and that for their size they, eating less, return as great a weight in eggs as some of their large brethren.

Nor can I agree with "A COMPILER," that the Darlington Committee received their very good entries of Bantams from all parts of the country. I should say that a very small proportion came from a long distance. Have I, or have I not, discovered the reason?

As to Malays, every true lover of poultry would consider any show of the proportions of Darlington incomplete without them. I hope "A COMPILER" will mark my words. All compilers of schedules ought to recollect that one of the great points in a good show is to have every breed represented; and that to the general public as well as to fanciers, a great charm is the variety of breeds.

Now, at Darlington, a Malay was absolutely unknown, actually unrepresented. A very old breed, a peculiarly distinct species of fowl, having characteristics common to no other breed was entirely absent.

Do compilers retort that there is the Any other variety class in which exhibitors can enter? You may call, but will they answer? The Darlington entries answer, No! Possibly Malay-breeders reason as I do with regard to Brahmans. When I receive a prize schedule I look for the Brahma class, and if it is absent, as a rule I should not give the show a second thought. If fair prizes are offered, then I reflect on the propriety of entering. Perhaps we are both agreed that we will not consign our pets to such Variety classes. From this rule I might exempt small and local shows which personally I might desire to help.

Moreover, all compilers of schedules ought to recollect, that as they gain largely on the entries of some breeds—to wit, Bantams at Darlington, they must be content to lose on others if they would make their show comprehensive of the different varieties of poultry. I do not consider that Crève Cœurs and Black Hamburgs are more deserving of separate classes than the Malay. The Malay is a true breed. My own experience of the Crève Cœur would class it as a degenerate Pele; whilst of Black Hamburgs, what shall I say? Well, I will say this, that one of the earliest and best pens of the sort I ever saw in a locality, now famous for prize specimens, had very respectable Minerca parents! The owner entered them in the Spanish class as Rose-combed Spanish, and received, of course, nothing, while an inferior pen of the so-called Black Hamburgs were prize birds in the Any other variety.

On the ground of purity, then, a class for the Malays! and then, perhaps, the Darlington public may see with pleasure birds that I lately saw in their several runs—birds that for plumage and condition would have added to the *clat* of any show.

I gave all credit, and, indeed, it is justly due, to the Darlington Committee for making the entries proportionate to the prizes offered. May some of the leading shows, the Crystal Palace for instance, be disposed to acknowledge their wrong doings and act in accordance with justice for the future!—Y. B. A. Z.

DOMESTIC FOWLS IN AMERICA.

THE variety of fowls which has been of late years most extensively disseminated throughout America is the large Asiatic, the original type of which is supposed to be the great Malay or Kulm fowl of India. In an article by D. S. Heffron, published in the "Report of the Department of Agriculture," it is said:—

"The stock of our large fowls called Shanghai, Cochinchina, Chittepung, Brahma, &c., came from the south-eastern part of Asia, in the vicinity of Shanghai, and hence the propriety of calling them all by the general name 'Shanghai' or 'Asiatic.' The first were brought to this country about forty years ago, and their descendants gave size and character to the fowls of a part of Eastern Pennsylvania, which have long been known in the New

York market and elsewhere by the name of the 'Bucks-County fowl.' But numerous importations that were made about twelve years ago awakened a new interest for large fowls, and they have since spread all over the country. Of these Asiatics, some have feathered shanks, some smooth; some have dark-coloured legs, some yellow, and others greenish; some have long legs, others short; most have single combs, while a few have combs more or less double. The plumage is of various colours."

The date which Mr. Heffron assigns to the first introduction of the large Asiatic fowls into Pennsylvania is too late. In 1851 the writer of this article learned from Mr. Adrian Cornell, of Bucks County, Pa., who was then upwards of seventy years of age, that the so-called "Bucks County" fowls had then been on his farm fifty years. We saw the stock, and having seen many other specimens of the kind in various places, of course readily identified them. Mr. Cornell's fowls were well known, and his son Adrian Cornell, jun., an enterprising farmer and poultry-breeder, kept up the old stock.

It is upwards of forty years since the large Asiatic fowls were known in Massachusetts. Before 1820 they were in the hands of various persons here, some of whom boasted that their "roosters" could, standing beside a flour barrel, eat corn from its upper head. Among this stock were specimens of all the varieties of plumage, and feathered and smooth legs, which have been seen in the later importations. Some exactly resembled the so-called "Brahmas," or "Brahma Poetras" of the present day—a name originated by a somewhat notorious individual ten or twelve years ago. The peculiar markings which characterise fowls thus called frequently appear in the common Shanghai, to which breed, of course, they really belong. It is true, however, that by careful selection from generation to generation, a tolerable uniformity of colour may be attained, and so it may be with any other colour.

Mr. Heffron says some of the Shanghai fowls have long legs and others short ones. This is true, although imported fowls are generally long-legged and rather gaunt-bodied. But their form seems generally to improve in this country, and where proper judgment is exercised in the selection of breeding-stock, the faults of shape may to a considerable extent be got rid of.

Mr. Heffron says the large Asiatics "are large feeders; have coarse-grained flesh, which becomes quite oily and rather rank-flavoured in old fowls." All who are familiar with these fowls know that these are prominent faults, and that they also produce but a small proportion of white meat compared with the dark. It is true, as we have intimated, that these defects may to a considerable degree be "bred out," but we have rarely seen this object properly accomplished without more or less departure from the original blood. The principal advantage of the breed has been in crossing the common stock of the country, sometimes improperly called "native." The cross-bred stock, if not carried beyond three-fourths Asiatic, is generally free to a good degree from the leading defects of that breed, while the size and laying tendencies are increased.

It is not advisable to produce the largest fowls, as they are not so saleable in market. Dealers in dressed poultry tell us that they do not want fowls weighing over 5 lbs. each, as above this weight Turkeys are preferred. A gentleman remarked to us that he regarded a chicken weighing 6 or 7 lbs. or upwards as only a "poor Turkey."—(*Boston Cultivator*).

TRIMMING GAME FOWLS.

In your note to my communication on this subject you say, "They are to be exhibited in the condition they would be if intended to contend in the cock-pit." Have you not said more than you intended? Would any Game cock, however good in shape, condition, &c., be successful if presented to the Judge's eyes in "the condition" you have spoken of? I never yet saw the Game-breeder who dared to try it on. If your note holds good at all, why is not the beautiful tail docked, the flowing brilliant hackle shortened, the natural spur shortened, and then, as a compensation for all this barbarism, a steel spur attached?

You have certainly failed to convince me that it is legit-

mate to "trim" Game; and I repeat, "If some strains are finer in the feather (and this is undoubtedly true), and therefore better, it is depriving them of an advantage in the competition which they enjoy naturally." I should much like to know the opinion of Game-exhibitors on this point.—Y. B. A. Z.

[We certainly did not intend to include all the trimming adopted by cockfighters, but to confine it to the bird's head. Our columns are open for the expression of any one's opinion on the subject.]

NEW VARIETIES OF PIGEONS.

I would inform Mr. B. P. Brent that the Satinettes which I have exhibited so successfully are much smaller than a Turbit, and of about the same build. The head is round without cap, beak short; frilled down the breast. The head, neck, and breast white; wings spangled beautifully with black, on a deep flesh ground, with two transverse bars; flight-feathers inclining to black; tail black, with a spot of white about the size of a shilling on each feather, near the tip. Muff-legged, fine carriage, and a beautiful bird.

The Icelanders are of a silver colour on the head, neck, and breast; the wings are marked like a Pencilled Ham-burgh's, and the tail plain. In size and build they resemble the Dove-house Pigeon without warts.

The Blue Brunswick is a very showy bird. It is capped and peaked like a Trumpeter, the skull and peak or turn on, and the upper portion of the beak are white, lower portion of beak blue; and to be good, the line should just clear the eye and pass to the base of the crown, which, with the other portions of the bird, is blue. On the wings are two double bars, the more prominent one inclining to white, with a small black line running at the base of this bar. The tail has a black bar at the tips of the feathers.—HENRY YARDLEY, *Birmingham Market Hall.*

RECOLLECTIONS OF AN OLD FANCIER.—No. 1.

INTRODUCTION.

THE WHO, WHEN, AND WHERE.

BEING confined to the house with a sprain in some part of the foot, my wife's maiden sister says "it is gout, of course;" but her opinion is not to be trusted concerning anything relating to me, since the day I pointedly stated that I did not approve of marriage with a deceased wife's sister.

No, it is not gout, although there is a good deal of swelling and pain, and my grandfather died of it, so that I have a right to that aristocratic complaint. It is not gout, but a bruise or sprain, owing to the frosty ground. It is not gout, Miss Malicious—I dare call you so on paper, for I know you will not read this, as you sneeringly say that "flowers and fowls are never the hobbies of strong-minded people."

Well, bruise or sprain (not gout, mind), I am here in my study, and am debarred out-door exercise. In these, I will not say sad, circumstances, for nothing of that kind is sad, unless people are grumblers, I have been thinking of—following in thought, as it were—each event of very far gone years, not in penitential mood, although it is Lent, but, rather, looking back because of the pleasure it gave me.

Now, my boy, before you get to your Virgil, for it is past nine, just wheel round my writing-table, and set my chair so that my feet are to the fire, and I will lean on my stick till all is done. By the way, yes, do get that letter 'T' stool. How dare you call it "gout stool," you young rogue, All right, thank you; I am very fairly comfortable now. Next, go to my paper-drawer and bring me some Journal paper. Do not mistake: the thick with no lines is sermon paper, for it is durable, and my divinity will go down safely to my great-grandson; the thin, that flimsy stuff, on that you know I write to the county paper; the straw is for people I don't care care a straw about; the satin and ivory are for my lady friends. Mind the blue with lines is for "our Journal."

It is a foolish fancy, perhaps, but I like to associate my different correspondents with different kinds of paper. Rely

upon it, this plan assists thought. I am grave at once when I have sermon paper before me, but when a bit of this blue-lined gets into a blank sermon I almost forget myself, the lighter air being about to take the place of the graver strain. Blue-lined for "our Journal." I began with it, and I always use it—I feel I ought out of consideration for the eyes of my friends at 162, Fleet Street, for London offices are so dark. Pens, paper, all ready my boy, now sit down to your Virgil; but first remove from the table your "White's Selbourne," your "Wild Sports of the Highlands," and yesterday's "Journal," for though you are "Boy Naturalist," yet peeping for ever after Mr. Brent will not help Latin and Greek. Work while you work, that's the plan, lad, to succeed.

"Recollections of an Old Fancier." First, I would what I mean by the term "old," for nothing an author dislikes more than misconceptions regarding himself. I think the reader should know as much about the writer as will conduce to the former's understanding, and enjoying, or, at any rate, entering into the meaning and spirit of what is written. By the term "old," I do not mean that my recollections reach back to the days when George III. was king, for I was not even alive then. I have no remembrances either of those sad days when "the first gentleman of Europe," as George IV. was most improperly called, was upon the throne of these realms. I have only a faint recollection of the "sailor king's" days, and of nursery enthusiasm about

"The sea, the sea,
The wide and open sea."

Indeed of the times of "Billy who 'bated the tax on beer," I have little to say, they seem so dim, so far off. When our good Queen began to reign, I began properly speaking to live, for childhood is, after all, a very chrysalis condition; but the cricketing, skating, riding, reading boy, has a life, a life of erick and sensible enjoyment.

I must say that those of us who were boys in the pre-railway age possessed some advantages over those whose boyhood has been since that era; for though railways had been laid in some part of England when I was a boy, they were quite unknown in my part, so that such districts were almost what they were in the days of Queen Anne. Now everybody travels, and the whole of England, to use a schoolboy handy phrase, is "much of a muchness." Then one part was famed for one kind of sport, or for one breed of fowls, and hence there was a marked characteristic in each county, and in this there was an advantage, at least—it made certain points of special interest. Not that I am sentimental enough to think the past better than the present; but the individuality of a county is less marked, so that some features of interest are now gone.

I was, when a boy, a resident in that district in the east of England which lies near to the Wash, a part abounding with birds of a particular class. Thus I was perfectly familiar with Ruffs and Reeves, Plovers, Redshanks, and such-like. I grieve to say among that wild population of fennemen, badgers were drawn, bulls were baited, cocks were fought, though a careful training kept me not only out of these brutal sports, but filled me with detestation of them. I speak of things now past, education as well as legal enactments have for some years been equally opposed to sports of this barbarous character.

Perhaps, to make this sketch more complete, and my *nomis umbra* more graspable, I should add I was a country doctor's son, a doctor whose memory is still cherished in many a cottage in the bleak fen country, and in the water-mills beside the deep black fen drains. Why cherished? Because he did many a professional deed of kindness with the knowledge that he never could be paid for it, save paid by the blessings of the miserably poor people. I was not a village boy, but rather a town-village boy. A long, straggling, populous place was my birthplace—scarcely a town, yet numbering some thousands of inhabitants of the substantial farmer class. No squire lived in that cheerless country. The place had, too, a very large country district, with a house or water-mill, or farm, and groups of cottages every mile or so. Oh! the vast sweep of horizon, black flat earth, and such a sky! The poplars in front of a farm-house, with their stiff forms, alone broke the monotony of the view,

for the pollard willows at the edge of the drains were, though many, too low to catch the eye.

With my good father who loved all living things, horses and Game fowls especially, I was wont to ride my pony by the side of his stout cob. A carriage was almost an impossibility in those roads, green and rough in summer, but black and half-way up to the girths in winter. Peat, peat everywhere: hence a peculiar as well as an extensive district was made known to me from my earliest years, and I had many friends, especially among the humbler classes, who petted and gave their pets to the son of their kind doctor.

Who were my friends, what my pets, future Numbers shall show; as yet I have chatted to you, good reader, of the Who, When, and Where.—WILTSHIRE RECTOR.

BEE-KEEPING IN DEVON.—No. XXII.

A RETROSPECT AND AN EXAMINATION.

FROM the numerous inquiries which reach me from various quarters, the majority of which relate to subjects which have long ago been treated of in these pages, it is evident that there is a large and increasing body of readers of THE JOURNAL OF HORTICULTURE, who take great interest in apiarian matters, but who have not read and are not able to refer to articles in the back Numbers. For their information, therefore, I may state that, although I commenced bee-keeping so far back as the year 1840, I consider my career as a strictly scientific and experimental apiarian dates from 1859, when I succeeded in naturalising in this country the Ligurian species of honey bee. From this time my apiary has been emphatically an experimental one, and in contravention of the dictum that an experimental apiary can never be a prosperous one, it became and continued eminently prosperous and successful, until by the use of some infected combs, purchased in ignorance of the malady, and taken out of common straw hives, I introduced into it a disease, which, although unnoticed by most, and very imperfectly described by any English writers on the subject, turns out to be by no means uncommon in this country, whilst it is identical with "foul brood," well known and much dreaded both in Germany and America, as a fatal and virulently contagious scourge. From the commencement of the breeding season until the end of June, I failed in identifying the malady, but, believing it to arise from chilled brood, laboured hard to eradicate it by various means, whilst I attempted to strengthen my weak colonies by exchanging brood-combs with such as remained prosperous. The only result of these manipulations was spreading the disease with preternatural celerity, until at the end of June, when my eyes became opened to the true state of the case, I found I had not one healthy stock in my apiary, nearly every comb in every hive being a disgusting mass of foul brood.

I will not enter upon the various expedients I then resorted to with the view of extirpating this fell disease, all of which were duly chronicled in these pages at the time, but will briefly repeat the description of the only means by which I succeeded in effecting a radical cure, and for which I am indebted to the Germans. The bees and queen of an infected colony having been driven from their own domicile, must be placed in an intermediate-hive for four days,* during the whole of which period of penal discipline and inanity the queen must be kept imprisoned in a queen cage. At the end of this term they must again be transferred to a new domicile, in which they are permanently to remain, and which should, if possible, be furnished with a few pure combs. It is well even then to keep the queen confined for the first day or two until comb-building has commenced, and upon her release she will proceed to lay eggs, which, if the matter has been properly managed, will probably hatch into healthy brood. All honey from an infected hive should be carefully kept out of the reach of bees, the combs melted down, the hive itself burnt if a straw one—carefully scraped† if wood, and washed over with a saturated solution of chloride of lime, which in its turn may be washed off in a day or two with clean water.

After perusing the above brief description of the only remedy which I have found effectual, I fancy my readers

* Any combs made in this hive must be destroyed.

† The refuse scraped off should be scrupulously burnt.

will be disposed to concur with me in endorsing the German opinion, that except under very special circumstances it is unadvisable to attempt the doubtful cure of a foul-breeding stock, but far better to consign the bees to the brimstone pit, melt the combs, drain the honey, and let the proceeds go towards the purchase of a new stock; whilst the hive itself is either burnt or carefully purified as above recommended.

Thus much by way of retrospect; but in taking what I hope may be a final leave of foul brood, and the discussion which it has originated, I cannot refrain from again expressing a wish to shake hands with my antagonist over our little difference. I need scarcely say that I estimate Mr. Lowe's abilities as an apiarian writer very highly, and I should indeed regret if any mere difference of opinion should interrupt the friendly feeling which has heretofore subsisted between us.

Monday, the 29th February, being fine and mild, I devoted to the examination of my remaining stocks, with the view of ascertaining what mischief had resulted from the effects of a rather prolonged winter upon a number of colonies, few of which had their hives more than half filled with comb, and which were consequently but ill prepared to withstand it. The first five turned out all right, and my spirits rose as I viewed queen after queen in full health, and hive after hive containing more or less of what I believe to be perfectly healthy brood. In particular, the queen returned from our Renfrewshire friend was seen at the head of a populous colony which she bids fair rapidly to increase; but the sixth hive presented a far different scene—from this the queen had disappeared, and the disturbance produced by my examination exercised its usual effect in setting her forlorn subjects upon a hopeless search after their missing monarch. Next came the strong and healthy stock presented to me last autumn by my kind friend "J. E. B.," and which had been Ligurianised by the substitution of a young Italian for its hybrid queen. Here again disappointment awaited me; the bees and queen were indeed in good health, but the latter had failed in her matrimonial excursions, and her virgin state was evidenced by the number of young drones which the hive contained, as well as by the fact that every sealed cell containing brood was elongated, and had received that extremely convex covering peculiar to the cradles of the male sex among bees.

It would be tedious to particularise the examination of every hive. I may, therefore, sum up the result as follows:—Of nineteen stocks two were entirely defunct, three were queenless, and one was a drone-breeder, whilst thirteen possessed fertile queens, and more or less of apparently healthy brood; so far as I could perceive there was not a single foul cell. Of these thirteen surviving and perfect queens, ten are Ligurians. The monarchs of the three queenless stocks had succumbed, as I verily believe, to regicidal attacks by their own subjects, since comparatively few workers were defunct in either hive; whilst in one I found the sovereign but recently deceased lying just within the entrance. The instinct which prompts bees to these suicidal acts appears to me the most extraordinary, anomalous, and unaccountable of any which guide the actions of these wonderful little creatures.

The next day being also fine, I successfully united my three queenless stocks to their immediate neighbours in the manner described at the conclusion of my article in page 523 of the last volume of THE JOURNAL OF HORTICULTURE.

Such, then, is the present state of my apiary. Looking at the half-furnished condition of nearly all my hives, and the difficulties with which I had to contend in order to bring them into anything like a healthy state, I do not think I have much cause to complain. I have every reason to believe that I am free from foul brood, and if we are only blessed with a moderately favourable season I have little doubt that my apiary will once more attain its wonted prosperity.—A DEVONSHIRE BEE-KEEPER.

BEES IN LANARKSHIRE.—Notwithstanding the leafy and flowery December, bees have been greatly checked by the late frosts of January and February, consequently they did not appear sooner than the 26th of February, that being the first day on which they carried pollen, and being about

three weeks later than in the preceding year. From the mild weather which prevailed in December they are greatly reduced in weight but strong in numbers, so that feeding in many cases will have to be resorted to.—A LANARSHIRE BEE-KEEPER.

BEE-HIVES.

If "A UTILITARIAN" would order a hive-maker in his neighbourhood to work him a flat-topped live with a hole in the centre of its top about 3 or 4 inches in diameter, as hive No. 1; a capping-hive exactly the same shape as No. 1, only considerably smaller, as No. 2; with another capping-hive with a round top, as No. 3, a size less than No. 2, so that they can stand one upon another in the order of their numbers, he would then possess a hive he could work with ease, and one not open to the objections which he seems to harbour against those commonly used by experimentalists.

When used, bees must be lived into No. 1; when that is full No. 3 must be put on; and again when No. 3 is "chuck a block," it must be lifted up, and No. 2 placed between. In due time, if the season is favourable, either or both of these capping-hives may be removed, and when the honey season is over, or in the autumn, may be broken up or restored to the stock-hive should it be weakened too much from the deprivation to stand the winter.

With regard to the foul brood question, I desire also to have the matter determined satisfactorily whether it be an infectious disease or merely the result of chilled larvæ. Cannot we prevail upon the Editors to nominate a bee-master to settle this question for us? Let a subscription be raised to purchase the first swarm that can be obtained this season. Let this swarm be driven or destroyed from its hive (a new straw cottage one) after a week or fortnight's sojourn therein; then let this hive be placed where the brood will become perfectly chilled, and in a week's time, or more, be again filled with a strong first swarm. In due time the readers of THE JOURNAL OF HORTICULTURE may be informed of the result of this experiment—whether bees can, or cannot, remove dead and putrid larvæ, and whether Mr. Lowe's theory, or "A DEVONSHIRE BEE-KEEPER'S," be the better one to rely upon. That no shots, harmless or otherwise, may be fired on our territory, is the constant wish of—A HAMPSHIRE BEE-KEEPER.

GREEN YEW FATAL TO BULLOCKS.

This morning (February 22nd), a lot of young cattle (about two years old), belonging to the Earl of Carlisle, broke into a little shrubbery at Coneysthorpe, where there are a good many yew trees, and these showed plainly that the cattle had eaten of them. In about two hours afterwards two of the beasts died, and in less than six hours ten out of the fourteen were dead, and the remaining four looked more dead than alive. The veterinary surgeon arrived in time to save the four.

He (the surgeon), gave it at once as his opinion, that eating yew was the cause of death. I saw him open and examine the stomachs of eight of them, and found large quantities of yew in pieces from 1 to 8 and 9 inches in length, very little chewed, a few ivy leaves, and, in one of them, a small piece of *Arbor vitæ*. They swelled very much after they died.

I have had frequent opportunities of seeing the deer eat yew during the present storm, but have not seen any die from eating it, or which have been in any way affected.—GEORGE SUTHERLAND, *Castle Howard, York.*

SINCE I wrote you about yews, our veterinary surgeon called in last week, and told me that two lots of milk cows had died this winter, one in Lorton and the other in Buttermere, about ten miles from here, from eating yew clippings from the garden fence. He is a very intelligent man, and is quite of opinion that clippings which have lain some time are the most dangerous form in which yew can be taken. All the poison then seems concentrated, and some chemical change takes place which intensifies its power. I have seen

several animals eat a lot of foxglove plants, but we know what a dead leaf or two would do.—JACKSON GILBEANES.

THE COOKERY OF THE WORKING CLASSES.—"When we criticise the cookery of the poor man's wife, one item of consideration should be the many things she lacks. She has no *batterie de cuisine* from which to take at the moment the utensil most convenient for the thing in hand. Decent cooking apparatus for the very simplest dinner we can sit down to could not be bought for a working man's whole week's wages. She has no store-room or handy cupboard stocked with spices, flavourings, and condiments. Whatever her dish requires must come out of her not-over-filled pocket at the moment, and tax it at once with the full cost of the dinner, to the detriment of the fund required for many other things to the end of the week. I have often thought that at a poultry or flower show a plain, good, well-made, useful set of kitchen utensils would form a capital first prize in the cottager's class. It should begin with a large strong serviceable meat-kettle, followed by saucepans, or stewpans of various sizes, and include an American oven. A prize like this and others of nice home conveniences would be appreciated, and become very useful in aiding the good wife with her cookery. The want of good cooking apparatus often stands in the way of the housewife's willingness to make soups and stews, and many concoctions, which would very wholesomely and very pleasantly vary the monotony of fry and bake; and there is nothing better in the whole range of kitchen furniture than stewpans of convenient sizes, nor anything better fitted to the often-not-very-convenient fire-places of humble homes."—(Standard.)

OUR LETTER BOX.

POULTRY AND PIGEONRY DIARY (A. Prescott).—Our correspondent wishes to know where one can be purchased. We buy a cash book, and run it into additional columns for ourselves.

DORKINGS (T. H. Z.).—Any colour is correct except black or white. Grey is the most admired, and, therefore, most saleable. Double spurs are not only not signs of true breed, but they are objectionable.

BREEDING DUCKWINGED BANTAMS (*Bantam*).—We believe those who have told you to have recourse to the Black Reds to breed or keep up Duckwinged Bantams are right. If you can at any time secure a Duckwinged cock, the first cross from the Black Red, you may safely use him with Duckwinged hens, but you must be certain. For want of the cross you will lose the perfectly black breast, the black tail, and the copper saddle. They will wear out or become faulty. Duckwings are birds of colour, and therefore any defect is a disqualification. As it is very difficult to breed winning cocks and hens from the same strain, we advise you to put the Duckwinged cock to some hens, and a Black Red to others. These will not only probably keep you a winner, but the produce of the two runs intermixed will bring good colour and good birds.

PARROT HAVING FITS (S. G. A.).—Try a tepid bath once a-day, through the rose of a watering-pot, but do not make the bird too wet, and place it before a fire at a short distance from it to dry. Give it three peppercorns daily for a week or two; and, in addition to its usual food, chilis and hempseed, and bread soaked in water, squeezed dry, besides water to drink.

MACAW DISORDERED (E. S.).—The cause of your Macaw not throwing off the pens from the feathers is weakness. Place the bird in the sun when warm; and if you find the pen loose, you might try with a small soft brush to clear it off, but care must be taken not to irritate the leather so that it bleeds. Give it bread and milk for a short time, boiled rice, chilis, boiled Indian corn, hemp and canary seed, and discontinue the capsicums. If the looseness does not abate, try dry bread, cummed, and a pan of water with a small piece of chalk in it.

VERTIGO OR GIDDINESS IN A DOG (W. C.).—We cannot give a decisive answer, not knowing the dog's condition. The turning round for a length of time, and the drowsiness, indicate a pressure on the brain; and if this arises from fatness and constipation, a tablespoonful of a mixture of two of olive oil and one of castor oil given for two or three mornings successively, less animal food, and exercise, will be the best treatment. Your bookseller ought not to charge you more than 17s. 4d. for a year's supply of this Journal. We pay him a commission. You could have it for that sum if you send us a post-office order for the amount.

LONDON MARKETS.—MARCH 7.

POULTRY.

We are drifting into our spring supply, and Duckings, Guinea fowls, and Go-hogs tell of the disappearance of Game. All our winter poultry show, by their condition, they have had much to suffer from the weather.

	s.	d.	s.	d.	s.	d.	s.	d.
Large Fowls	3	6	to	4	0	0	0	0
Smaller do.	3	0	to	3	6	0	0	0
Chickens	2	0	to	2	3	0	0	0
Geese	6	6	to	7	0	1	4	1
Ducklings	3	0	to	3	6	0	8	0
Partridges	0	0	to	0	0	0	9	0
Pheasants	0	0	to	0	0	0	0	0
Guinea Fowls	2	6	to	3	0	0	0	0
Hares	0	0	to	0	0	0	0	0
Rabbits	1	4	to	1	5	0	8	0
Wild do.	0	8	to	0	9	0	9	0
Pigeons	0	9	to	0	10	0	0	0

WEEKLY CALENDAR.

Day of M'nth	Day of Week.	MARCH 15—21, 1864.	Average Temperature near London.			Rain in last 37 years.	Sun Rises.	Sun Sets.	Moon Rises.	Moon Sets.	Moon's Age.	Clock before Sun.	Day of Year.
			Day.	Night.	Mean.	Days.	m. h.	m. h.	m. h.	m. h.	m. s.	m. s.	
15	TU	Gnat and Red Ant appear.	51.0	34.4	42.2	17	15 af 6	3 af 6	27 10	47 1)	8 59	75
16	W	Woodcock last seen.	51.5	34.8	43.1	12	13 6	4 6	23 11	31 2	8	8 42	76
17	TH	Lilac foliates.	50.0	33.5	41.8	12	11 6	6 6	after.	8 3	9	8 24	77
18	F	PRINCESS LOUISA BORN, 1848.	50.4	33.5	42.0	11	9 6	8 6	26 1	39 8	10	8 6	78
19	S	Black Currant foliates.	51.3	34.0	42.7	12	6 6	9 6	29 2	5 4	11	7 48	79
20	SUN	PALM SUNDAY.	51.5	34.1	42.8	16	4 6	11 6	32 3	27 4	12	7 30	80
21	M	Sun's declination 0° 27' N.	51.0	32.9	42.0	17	2 6	13 6	36 4	49 4	13	7 12	81

From observations taken near London during the last thirty-seven years, the average day temperature of the week is 50.9°, and its night temperature 33.9°. The greatest heat was 67°, on the 15th, 1828, and 19th and 20th, 1836; and the lowest cold, 17°, on the 17th and 20th, 1845. The greatest fall of rain was 1.11 inch.

PLANTS WITH DARK FOLIAGE.

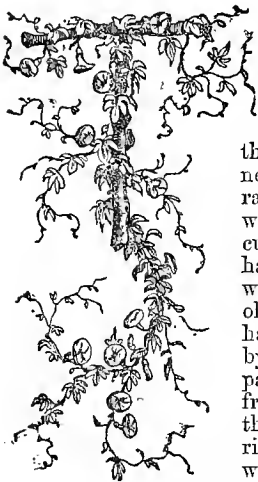

THE advent of Perilla was hailed as a great boon to the flower garden, as the demand for plants having striking foliage had set in with a vigour that has kept on increasing rather than diminishing, and calls for new plants having the same characteristic have been made far and wide. More recently the horticultural stores of the distant East have furnished us with another worthy rival to the Perilla; an old tenant of the kitchen garden has been arrayed in a garb not by any means unfitted for the parterre; while our hothouse friends have turned out of doors their surplus stock of one of the richest ornaments in the plant way which they have to grace the dinner table with. The respective

merits of these four plants have driven, in a great measure, another of a like hue out of the flower garden—the purple Orach; so that, although it may be right still to retain its name on the list, its utility as an ornament to the parterre is of so short duration, that it is only in places where the others will not thrive that it is now much cultivated. However, being a useful old servant, I will retain its name, and give it just such a character as its merits when compared with those of others seem to deserve. Neither is the list of bronze-coloured-foliaged plants by any means exhausted by the names above given, as an Oxalis is occasionally met with used as a low edging, of which the foliage is by no means deficient in that high colouring so much coveted; and a Trifolium of about similar growth is also used to advantage in like manner. Both of these plants present the ruddy brown hue which stamps them as different from the plants of ordinary green foliage; and where judiciously combined with other plants affording a suitable contrast they are by no means to be despised.

During a ramble in the past summer I saw these plants, as well as many others not usually met with in ordinary flower-gardening, used to great advantage in lines or edges to flower-beds in the Liverpool Botanic Garden—a place where I was glad to see flower-gardening was done as well as at any place I visited; and the character and extent of the grounds had been judiciously made use of to introduce into notice many plants not generally met with in ordinary gardens. Of these probably I may give a few notices hereafter; but I simply mention these two plants as partaking of the tint now under consideration, and at the same time I will also mention another, which has, I think, not been sufficiently cultivated yet—the *Ajuga orientalis*, the foliage of which presents a greater resemblance to the Perilla than that of any plant

I know. It is as hardy as a Dock, but, being of low growth, cannot well be employed for the same purposes as the Perilla. I will endeavour now separately to place their merits and failures in their true light before the reader.

PERILLA NANKINENSIS.—It is hardly to be expected that a plant differing so widely from anything we previously possessed, should be received into the flower garden with such widely different feelings as dislike and admiration even amongst those who assume to be master spirits in such matters of taste, for it is not unusual to meet with gardens kept in the highest state of efficiency, in so far as new and choice plants are concerned, whose owners would on no account tolerate the Perilla; while on the other hand the strong contrast it presents to the hues of the other occupants of the parterre renders it what some ladies would call charming, and many of the rougher sex express themselves delighted with it. Be this, however, as it may, there is no question but its cultivation has largely increased; and its adaptability to almost all soils and situations, including the very important qualification it has of submitting to any amount of amputation to keep it in companionship with its neighbours, enhances its usefulness in no small degree; and as it is amongst the first ornaments of the flower garden that come into use, it is one of the last to retire. A plant that does duty so well for five months or more ought, therefore, always to be spoken of with respect; and for my part I see no reason to find fault with it, excepting only on one point, and that I trust careful cultivation will remedy and perhaps improve. My fear is that the plant is degenerating, the colour not being so good in my opinion as it was when first introduced. Perhaps I may be wrong, but one of the principal objects of my now calling attention to ornamental-foliaged plants of this hue was to elicit from the flower-gardening world whether others were of the same opinion as myself; and if so, it would be well to take measures to restore it to its original condition again, or even, perhaps, to improve upon that.

I am not aware that the original form of this plant has been traced out; and assuming it to be an improved garden variety which a long series of years, under the skilful management of the cultivators of the Flowery land it is said to come from, may have brought to its present state of perfection, have we not every reason to suppose that, with a less careful attention in the way of weeding-out indifferently-coloured specimens amongst those intended for seed, we may return by degrees to the normal condition of the plant? Assuredly such will be the case; while if, on the other hand, the plant as originally introduced to this country was in the condition Nature first furnished it to the denizens of the Celestial Empire, we need hardly be surprised if the widely different climate of Britain cause that deterioration in colour which I fancy has taken place. Whichever of these two reasons be the cause, and it be shown that the plant is approaching to the green state, would it not be well to apply the remedy or preventive before the evil go too far? The process is

simple enough if it could only be impressed on those who have the duty to perform of saving the seed, which, it is needless to say, ought only to be saved from plants possessing the finest and best-coloured foliage. To do this is simply following the rule that has been laid down for ages with plants of other kinds. Vegetables of all kinds would speedily run into their weedy original condition if care in the selection of plants proper for seed were not unceasingly exercised, and why not expect the same thing with the *Perilla*?

I am partly led into the above observations on the *Perilla* from having noticed plants with different hues in the same plantation. Even the foliage differs, some plants having quite a plain leaf, others one very much curled at the edge, the curl amounting to a fringe. Now, as it would be advisable to improve rather than allow this plant to degenerate, the above hints may perhaps be of service to the seed-growers; and if they do not attend to the matter, as I have no doubt but they will, private growers will have to do so themselves, the same as they have done at times with other things which they have not been able to depend on as always genuine. With this request I must leave the matter in their hands, as they know quite well which are the plants most admired and suitable to save seed from.

Before, however, quitting this subject, I may relate that for winter decorative purposes this plant is useless; for last autumn I sowed a batch of seed of this, and also of *Amaranthus melancholicus*, and reared several plants, which I kept in heat, growing them on to try if they would assume anything like their summer garb, but they only attained a dirty pale hue, scarcely recognisable as belonging to the plants met with out-doors in August, although they had the best place that could be had under glass; they grew on pretty well, flowering and seeding, however, at a less size than usual, and were altogether plants differing widely from the summer-grown ones outside of the same species.

AMARANTHUS MELANCHOLICUS RUBER.—When I called attention to this plant in the autumn of 1862, as being likely to prove a great acquisition to the flower garden, I said no more in its favour than has been fully borne out; for when seen at its best it would be difficult to conceive anything really more beautiful, and at a particular time last summer, two long rows which we had of it were certainly the most admired object in the garden. Nevertheless, with all its beauties I fear I cannot recommend its general adoption excepting in very favourable situations, or in very hot seasons, as it cannot be called an early plant; neither is it a late one, for it succumbs to the autumn rains long before any of the *Geraniums*, or even before the *Coleus Verschaffelti* with which it is sometimes allied: therefore, to the inexperienced who have a series of beds to plant, forming in some respects a whole and compact figure, I would not advise this plant to be used, as it might create a great and fatal blank in the picture impossible to remedy at the time wanted. Nevertheless, in desultory planting where a failure is of less consequence, and where experiments are excusable, nay, even recommendable as affording variety, this plant is certainly deserving attention, and if the season should prove hot, it cannot fail to be one of the greatest attractions of the garden. Its delicate character would indicate that it must have come from the warmest districts in Japan, as many plants from India and the tropics endure the cold and wet of our early summer and autumn better than it does, although none seem to be more really at home during August and the early part of September. It is hardly necessary to say that it ought not to be planted out too soon, the middle of June being in many instances soon enough. It seeds freely when grown in pots, but from my experience of it in the past season it is of no use as a winter plant; but to those having a circular bed on grass in some favoured corner, a centre of this plant with an edging of *Centaurea* is, perhaps, as fine an object as can well be conceived; but for general purposes *Perilla* is unquestionably more to be depended upon, and, bearing cutting and trimming better, is preferable in all cases where certainty rather than experiment is the order of the day.

RED BEET.—Common and not very refined as this plant may appear, it has found its way nevertheless into the flower garden, and I by no means find fault with it there. Of course, only the variety with Beet-coloured foliage is admissible here; but when it is good its appearance is far from despicable—on

the contrary, in bright sunshine there is a glossiness on its leaves which the other dark-foliaged plants do not possess. As its culture is easy and we all know that its adaptability to all situations where flowers of any kind will grow is such as to insure its succeeding, perhaps the only drawback is that it cannot be got so easily as the *Perilla*; for by sowing it too soon it runs to seed, and nipping off each seed-stem as it rises is a tedious job, and the plant ceases to have that spreading foliage it has when grown without showing the flower-stems. In the north of England the Red Beet is oftener met with in flower gardening than about London; but I am told it is used in some few instances near the metropolis. If the foliage were somewhat smaller and less plain it would be better; but it is abundant enough, and rising all from the collar or crown of the plant there is little or no stem until it begin to run to seed, which it ought not to do. In places where *Perilla* will not succeed, a suitable variety of Beet may be tried, and will be found far from deficient in merit, and possibly may deserve a higher meed of praise than some more costly productions.

COLEUS VERSCHAFFELTI.—Some difference of opinion exists on this, the general impression, however, being that it is too delicate for all but very warm fine seasons. This is my opinion, and my experience with the plant last year confirmed it. If it would really grow and prosper out of doors, and assume the rich maroon it presents when in the hothouse, we should have nothing to wish for, as the plant possesses every qualification in the way of habit, adaptability to soils, &c. But when it is known that in ordinary seasons we must not expect it to look well except in the month of August or later, we are naturally unwilling to place it in the front rank of useful bedding plants; and the mere fact of its being a stove plant does not give it more claim to notice than the last-named plant has, which has been in our kitchen garden for a century or more; nevertheless, in fine hot seasons it may do better. One thing, however, I may say in its favour, it withstands the autumn cold and rain better than the *Amaranthus*, as a bed we had here, which was planted about the middle of May, and made scarcely any progress until August, except getting paler and more dirty-looking, took to growing then, and for a time looked well, and the plants withstood the cold until frost destroyed both them and the *Geraniums*. For general purposes, however, I would not by any means recommend it; but for experimental beds it may be used and may create a feeling in its favour; and if we have such seasons as enable the *Begonia*, or *Torenia asiatica*, *Pentas carnea*, and other stove plants to do out of doors, then we may expect this to succeed also. Probably one season in ten may afford a few weeks of this kind of weather, and when our prophets in such matters are better able to tell us than they are now when such a season may be expected it will be a good time to try these things. As it is, I fear that they can only be recommended to experiment upon, leaving the other more certain servants to do the work of the important beds.

PURPLE ORACH.—I cannot say I ever was successful with this, but I have not tried it much; its liability to run to seed, even when pinched back to struggle and put forth fresh stems, gave much trouble which its short-lived character did not by any means assist in compensating for. However, in some places it is much thought of, and I am told it does well in cool situations, and in such is a favourite; but since the other plants named above have been more plentiful this has fallen into disrepute. To those who still patronise it, I may say it is certainly liable to degenerate in point of colour, and is often met with of a pale washy pink colour. It is, however, not by any means to be despised when good, and when at its best leaves little to wish for; but its short duration detracts sadly from its value, and its popularity has been on the wane some time.

LOVE-LIES-BLEEDING AND PRINCE'S FEATHER.—Though not included in the list heading this article, these plants are certainly worthy of more attention than they often receive, the first-named being certainly a useful plant in many places, and it lasts the season better than almost any other annual I know of. It has, however, fallen into disuse in a great measure in the highly-dressed beds; but for surrounding clumps of shrubs, or where tall plants are grown, it is unquestionably useful, and deserves more attention than it often receives.

I by no means assert that the above exhausts the list of plants of this colour; on the contrary, I expect each year will bring to notice new ones, and it is not unlikely that the ensuing summer will find some one trying some of the *Dracenas* out of doors, which, if found to succeed, will drive many of their predecessors out of the field. Without particularising, I will only add that certainly, now the subject has gained so fast a hold on public attention, the remotest corner will be searched for novelties, and the public being more fastidious than formerly, a plant must possess more than an ordinary degree of merit to meet all that is required of it now-a-days. That such are forthcoming I have no doubt, but until something better does appear I am constrained to give the preference for general purposes to *Perilla*.

J. ROBSON.

TEMPERATURE OF VINE-BORDERS.

THE importance of warming Vine-borders for the supply of early Grapes, and for the proper ripening of tender varieties such as *Muscats*, has of late years assumed a practical form. Where vineries have been erected, especially in the gardens of the more wealthy, for the object of ripening Grapes early in spring, many of them have been supplied with hot-air chambers underneath the borders; and it may safely be assumed that all who are fortunate enough to possess such an advantage ought, all other things being equal, to out-distance those who have still to struggle against cold and ungenial borders. It is admitted by all, or nearly all, gardeners, who have to produce early Grapes from Vines the roots of which are in borders outside the vinery, that it is a desideratum to warm the border by some means, so as to overcome, to some extent at least, the great discrepancy which exists between the temperatures of the mediums in which the roots and leaves have to play their respective parts. It is easy to say that where the advantage of bottom heat from hot-air chambers directly underneath the border is not enjoyed, the next best thing is to have all, or nearly all, the roots in an inside border. But this, even admitting its correctness, does not meet the case of many who are compelled from circumstances to cut their earliest Grapes from Vines in the Pine-stove, or in company with something else which prevents the possibility of having even the smallest extent of border inside. On the other hand, it is a fact that if the border be made both inside and outside, and the Vines planted inside, three-fourths of the roots find their way into the outside border. Such, at least, has been my experience, and on this account some have questioned the utility of an inside border at all. To counteract this outward tendency of the roots, I have in some cases built up the arches for a year or two, and so compelled the Vines to take possession of the inside before being admitted to the outside; and I would strongly recommend the plan to those who have to force early without the advantage of a properly heated border. Our business at present is with Vines, the roots of which are of necessity all in outside borders with no means of applying heat to the soil from beneath. The method practised in the majority of cases is to cover the border shortly before forcing commences with stable-dung and leaves in a hot state. It may, perhaps, be justly questioned whether such an application, after the border has been exposed to the drenching rains and chilling winds of autumn, does much towards the end in view. At all events, it may be questioned whether this be the surest and least troublesome way of supplying warmth to the border. It appears after all very much like locking the door after the steed is stolen; and I have known very successful forcers abandon the application of fermenting material, and in its stead to merely cover the border with a tarpauling to throw off the rain.

One thing in connection with this practice must appear very evident to the most inexperienced—*i. e.*, that it is decidedly an error to leave the border totally and entirely exposed to all weather up, perhaps, to Christmas, and then to cover it with fermenting or any other material a week or a fortnight before forcing is commenced. Yet this is no uncommon practice. The well-known fact that in early autumn the temperature of the soil is higher than that of the atmosphere, ought to demonstrate how much more politic it would be to take the precaution of by some means prevent-

ing the radiation of that natural warmth, whether or not fermenting material be afterwards applied. Further, it even becomes a question whether, if this natural earth heat were properly taken care of, any application of material with the object of throwing warmth into the soil be at all necessary or beneficial. My own impression is, that it is not.

If the border were covered early in autumn with a foot in thickness of some dry, loose, nonconducting material—such as hay or straw, and over all a thatching of 8 or 9 inches of good wheat straw, so as to entirely ward off rain and prevent the escape of the heat, I am warranted from my own experience in saying that the temperature of the soil at mid-winter will be more than equal to that secured by the application of manure and leaves just before forcing commences, and a deal of dirty work will be avoided. In the winter of 1856 I tested a border which had been thus early covered in autumn, and found, in the first week of February, that a thermometer plunged into the middle of the border to the depth of 15 inches, quickly rose from 40° to 60°. Now, without entering into the question of how far heat applied from above will penetrate into a mass of wet, cold soil, it may be questioned whether, when such a temperature can be secured through the winter by merely taking care of the natural heat of autumn, it be worth while to have all the mess and labour of a heap of fermenting material. Of the two systems I think the former is quite efficient in securing the end in view, and has besides many other points to recommend it.

The question of how to induce Vines to make as many roots as possible in the inside border, is one of very great importance to those who have to ripen Grapes—say in April, and who at the same time have no means of bottom heat from beneath. That Vines start more kindly and mature their crops both better and more rapidly when the roots are warm and comfortable, is a fact which admits of no dispute. It is, therefore, of vast importance that all the roots from them should be under the same roof, secure from wind and weather, and acted on by the same temperature as that to which the Vines are subject. As has already been remarked, the tendency of the roots is to go outwards through the arches into the outside border, and every precaution and means should be adopted to induce them to multiply inside. There are many Vines now subjected to early forcing that have not at first had their roots confined to the inside border, and a coaxing system is the only one that can be applied to their case. There is a vinery here which was planted in 1860, and its present crop will be the third which it has ripened in April. The inside border, even up to the back wall, is one mass of active rootlets close to the surface of the soil, while the Vines have all along had the run of the outside border as well. There is no bottom heat from any appliance whatever, either outside or from beneath the border. I attribute the abundance of roots inside to the annual application of some light open soil over the surface of the border close to the roots, and over all a sufficient depth of hard wood leaves to keep up for several months a nice genial warmth, and more especially to the leaves being left on all the summer. By this means the roots are enticed upwards to the top layer of soil, and the leaves being left on all the summer there is no chance of the roots being checked, as might otherwise occur if the leaves were removed when the crop was cut. To this plentiful inside root-action I attribute the ease with which the Vines are started. In itself the vinery would by many be pronounced totally unfitted for early forcing, it being very flat and constructed after the fashion of the olden times with timbers fit for a frigate. Yet the Vines, though weak owing to their having been early forced from the very first year they were planted, always show plenty of fruit that colours well, which must be attributed to the amount of inside roots more than to anything else. I know of nothing that will entice roots in any direction required more quickly than a light, rich, open top-dressing, and the application of a bed of leaves sufficiently deep to moderately warm the dressing, and I would recommend the plan to all who are desirous of inducing their Vines to make more roots in inside borders.

The great expense which has been incurred in some cases in chambering below Vine-borders, and warming them by means of hot-water pipes, together with the very poor results in some cases, has done much to deter many from heating

Vine-borders. Nevertheless, the advantages of bottom heat from beneath is a great fact, especially in the case of early forcing, and in the proper cultivation of some of our tenderest and best sorts of Grapes. It is, however, by no means necessary to have borders expensively chambered underneath to heat them efficiently with hot-water pipes. It is only necessary to take out the bottom of the border a little deeper than would otherwise be required to lay the hot-water pipes, and then honeycomb them with bricks. This is much cheaper, and quite as efficient as any expensive chambering requiring to be all strongly paved over with expensive stone; and the amount of firing or piping needed to keep up a warmth in the soil is surprisingly small either way, and is all saved in time by the ease with which the Vines are started, as compared with those to which such an efficient mode of supplying bottom heat has not been applied.

In making a border for a Muscat-house here, I took the advantage of a pipe which ran through the border to another house, and connected it with a quantity of rough rubble in the bottom of the border. The result is, that the Muscat Vines are started with surprising ease, even at midwinter, and I find that they ripen their crops in nearly the same time as Hamburgs, to which no bottom heat is applied. They, moreover, attain to a pitch of amber colour which I cannot produce in houses without such aid. D. THOMSON.

ROSES IN THE SUBURBS AND THE PAST WINTER.

HARDINESS of constitution and power to withstand inclement weather are, undoubtedly, among the essential properties of Roses for general cultivation; but, till the past winter, there has been little opportunity of testing the merits, on these points, of the varieties introduced since 1861. It will, however, now scarcely be denied that they have undergone a satisfactory test, and that Roses that have passed unscathed through the atmospheric trials since Christmas may be considered capable of enduring the rigours of our ordinary winters. The first period of frost caught the plants almost in full growth, and the second again came upon them after an interval of moist open weather, the ground saturated, and the branches wet. Any one who bears in mind how much more deeply frost penetrates into wet than into dry soil, and how much more susceptible to its influences wet branches are than dry, will be able to realise the severity of the ordeal the new comers have passed through at last, and the valuable addition they form to our established favourites.

As far as my experiments extend, it may be laid down as an axiom that the finest Roses of 1861-62-63 are decidedly hardy—an opinion, I believe, corroborated by that of Mr. John Fraser, whose opportunities and authority few will dispute; and I have no doubt the same has been remarked by others of the leading nurserymen. It may happen that from fortuitous circumstances, all kinds have not behaved alike in every part and under every condition; but, as a general principle, recent acquisitions rival, if they do not surpass, older kinds in vigour and endurance.

I shall now proceed to remark upon the varieties that have fallen under my personal experience this winter. Of 1861, I find H. P.'s Colonel Cambrils, Terre Noire, Jean Bart, General Washington (is apt to split), B. Catherine Guillot, H. P. Duc de Cazes, are all hardy. Duc de Cazes is the best of these, for though Madame Furtado is, perhaps, the most perfect flower of the year, it is an unsatisfactory grower, and by no means suited for suburban rosarians.

1862 has been the most prolific season on record for sterling Roses. Mr. Rivers in his select list of seventy-seven of the choicest kinds, enumerates more than twenty introductions of the above-named year. Among them are Charles Lefebvre, François Lacharme, and Madame Charles Wood, three of the finest varieties in cultivation. All of these appear thoroughly hardy. The smooth Bourbon-looking wood of Charles Lefebvre, in particular, seems impervious to frost. Louise Darzins, Alphonse Damaizin, Madame Boutin, Madame Clemence Joigneaux (a splendid robust kind), Maurice Bernardin, Souvenir de Comte Cavour, Triomphe de Caen, Vicomte Vigier, Henriette Dubois, Prince Camille de Rohan, John Hopper, Notre Dame de Fourvières, are

likewise untouched. Maréchal Vaillant, L'Éblouissante, and Turenne, are, perhaps, a shade more tender, and also Monte Christo, a slender grower—that is, the shoots are more cut down, but the buds appear all right.

The novelties of 1863 must be chiefly judged by the behaviour of the dormant buds and stools from France; the comparatively few plants in the ground being early-grafted plants on the Manetti, hurried on to send out in the spring, and which, consequently, rarely thrive in the first season, though afterwards they succeed well. The following varieties appear to be as hardy as any kinds grown, and are, I suppose, the best of the year. H. P.'s Alfred de Rougemont, Baron A. de Rothschild, Le Baron Rothschild, Deuil de Prince Albert, Madame William Paul, Jean Goujon, Le Rhone, President Lincoln, Sœur des Anges, and Vainqueur de Goliath: most of these kinds are dark or high coloured, and of unusually robust and vigorous growth.

I have had a glimpse of the "*debutantes*" for 1864. B. Rev. Henry Dombain, I have already seen in flower at the Lea Bridge Road nurseries. It is pretty, bright, and promising, and, I should say, a free bloomer; every shoot out of some score or two of young grafted plants displaying a flower-bud. Others of the new kinds appear likely to turn out well, and Mr. J. Fraser's clever Rose foreman told me they never had a better lot. I may just remark, *en passant*, that these nurseries have passed entirely into the hands of Mr. John Fraser, under whom they are not likely to be conducted with less spirit than heretofore. Several acres have been added to the home ground, and a large plot has been taken in from "the Forest" as an additional outlying nursery, chiefly, I believe, for purposes of experiment. There is still time to put in Roses if done at once and with due precautions as to planting, the chief of which are to place the roots carefully in well prepared soil, with some fine leaf mould and loam immediately in contact with them, and a good deep mulching of warm manure above to encourage immediate root-action, not forgetting secure staking if standards.

I had a few excellent dwarfs in first-rate order from Messrs. W. Wood & Son (Maresfield, Sussex), a few days ago, so that I conclude the supply of fine plants at the first-rate nurseries, though late in the season, is not yet exhausted, except as to certain kinds sold out everywhere at the beginning of the season. I mention this, as I have often found that Roses planted when just on the move have taken better, and turned out more satisfactorily, than many put in earlier. Those, however, who do not complete their removals before the middle of the month will have to wait and furnish or replenish their Rose-beds with plants out of pots, if they wish for success.—W. D. PRIOR, *Homerton*.

ANNUALS FOR BEDDING.

IN ANSWER to "A LOVER OF FLOWERS," whose communication appeared in your Number of February 9th, I would state that, having for many years bedded-out a rather large flower garden with nothing but annuals, before I had a greenhouse or any means of wintering bedding-out plants, I can safely recommend the following, some of which were named in your answer to the inquiry:—

Tropæolum Tom Thumb (scarlet and yellow), *Petunias*, *Ageratum*, *Lobelia speciosa*, *Phlox Drummondii*, *Asters*, *Stocks*, *Zinnias*, *Linum kermesinum*, *Oenothera Drummondii* nana, *Saponaria* (pink and white), *Mesembryanthemum tricolor* (edging), *Perilla nankimensis*, *Amaranthus*, *Cineraria maritima*. All these are better sown in hotbeds and pricked-out; and where there is an opportunity, *Petunias*, *Phlox Drummondii*, *Amaranthus melancholicus* ruber, and *Lobelia speciosa* ought to be pricked-out into a slight hotbed covered with 4 or 5 inches of good soil, sufficiently tenacious to take up in balls. Such annuals as *Calliopsis*, *Eschscholtzia californica*, *Collinsia*, *Kaulfussia*, *Venus's Looking-glass*, and some few others, though very showy for a time, do not last long enough. *Silene pendula* may, however, be grown with advantage by sowing it early, and having a supply of *Saponaria calabrica* to take its place when it has done blooming. In the same way *Virginian Stock*, *Collinsia*, *Nemophila*, and *Alyssum maritimum* can be planted for early blooming, keeping back plants of *Asters*, *Petunias*, *Stocks*, *Lobelias*, or other late-flowering annuals to be trans-

planted from store-beds or pots to supply their places. I used to find Tom Thumb Nasturtiums, grown in pots and kept in a cool place, very useful for this purpose.

Numbers will bloom very early and well from seedlings, but require to have their seed-pods picked off as soon as the blooms are over, and very liberal watering if a dry summer, otherwise their time of flowering is very short. Pansies, if sown at once, will also make good beds and good blooming plants for late work.—X. Y. Z.

THE ROYAL HORTICULTURAL SOCIETY'S FIRST SPRING SHOW.—MARCH 9TH.

THE Society has had many a wet and cheerless show-day, but never for many years one on which the weather was so wretched as on this occasion. In the early morning it was difficult to say whether rain or snow predominated, but as the forenoon advanced a fall of half-melted snow took place, and continued with but little intermission till late in the afternoon. Everywhere there was slush, the roads, the foot-paths were covered with it, and even in the large conservatory it was there, for the snow sliding off the lofty arched roof broke the glass at the sides and fell through. Few who could stay at home would venture out on such a day, and the attendance of visitors was consequently very small, a fact which is more to be regretted because the display was unusually good, particularly the Hyacinths, which formed the principal feature.

As the Exhibition building is now being rapidly taken down to obtain a covered space, the Entrance-hall and the Council-room were temporarily fitted up for the Show, but owing to the communication with the adjoining arcade being open, the place was cold and draughty.

HYACINTHS were even finer than in previous years, and those which Messrs. Cutbush and Mr. William Paul exhibited in the class for eighteen distinct kinds, could hardly be surpassed. Here each put forth his best flowers, and the result was, that each received a first prize.

Messrs. Cutbush had of Reds, Macaulay, Princess Clothilde, Von Schiller, Florence Nightingale (very fine, dense spike), and Duke of Wellington. Of Blues, Laurens Koster, Argus (bright blue, with a distinct white eye, a very effective kind), Charles Dickens, Mimosa (very fine), and Bleu Aimable, (a splendid spike). Of Whites, Gigantea, Grandeur à Merveille, Mont Blanc, Seraphine, and Queen of the Netherlands; and of other classes, Haydn, lilac mauve; Ida, yellow; and General Havelock, a splendid black.

Mr. W. Paul exhibited of Reds, Howard, Macaulay, Von Schiller, and Princess Clothilde. Of Blues, Argus, Baron Von Tuyl, Charles Dickens, Grand Lilas, Mimosa, Marie (fine spike), Feruck Khan, which being very dark might, perhaps, more properly be classed as a black; and King of Blues (a new and beautiful dark blue). Of Whites, Mr. Paul's collection contained Snowball, a beautiful kind with large and fine bells; Mirandoline, and Queen of the Netherlands. Of other classes there were General Havelock, Ida, and Duc de Malakoff (fawn).

The only other competitor in the Nurserymen's Class was Mr. Treen, of Rugby, who received a third prize, and whose flowers were far behind the two splendid collections just referred to.

In addition to the above, Messrs. Cutbush and Mr. W. Paul contributed finely-grown collections, each consisting of about a hundred pots of the best varieties, and for which they respectively received extra first and second prizes.

In the Amateurs' Class for twelve Hyacinths of six kinds, Mr. Young, gardener to R. Barclay, Esq., Highgate, had some very fine flowers, the kinds shown being Von Schiller, Howard, Duke of Wellington, Mont Blanc, Grandeur à Merveille, and Charles Dickens (large and fine spike). Mr. A. Carr, gardener to B. Noakes, Esq., Highgate, was second; and Mr. G. Taylor, gardener to C. Hanbury, Esq., East Barnet, third.

In the next Class, 3, for six kinds, Messrs. Cutbush were first with Princess Clothilde (very close spike), Von Schiller, Florence Nightingale, Grandeur à Merveille, General Havelock, and Ida, all of which were fine examples. Mr. Young came in second with Grand Lilas, Argus, Solfaterre, Madame Van der Hoop, General Havelock, and Ida. Mr. W. Paul,

who was third, had among others, Lord Palmerston, a new and striking variety, clear blue, with a white eye, and which will, doubtless, be much sought after.

Hyacinths grown in windows, either in pots or glasses, formed the subject of competition in Class 4, where the best six came from Mrs. Noakes, of Highgate. These were in glasses, and were much the finest of those grown in this way; among them were excellent spikes of Von Schiller, Grand Lilas, and Macaulay. Mr. Young was second, and Miss Fortune, of Gluston Road, Brompton, third.

In the next Class, for six new kinds of 1863 and 1864, Messrs. Cutbush had the first prize, Mr. W. Paul the second, and Messrs. Barr & Sugden the third. In Messrs. Cutbush's six was Josephine, an intense crimson, the tube shaded with orange crimson; it is distinct in colour from any other kind, and is unquestionably of first-rate merit. Robert Fortune, reddish mauve, and having a large spike and bells, will also take a high rank. The others were Schwarzwald, a new black; Henrietta Elizabeth, delicate pale lilac, new and very attractive in colour; Queen of Denmark, bright rose shaded to crimson in the centre of the segment; and Die Jung Frau, white, with large bells. From Mr. W. Paul came King of Blues, a splendid dark blue, producing a very fine spike; Lord Palmerston, clear blue with a white eye, and of first-rate merit; Emma Livry, and L'Or d'Australie, both yellow; Alba Nova, white; and Leonidas, a bright blue, the outside of the tube approaching to cobalt. Messrs. Barr and Sugden received the third prize for King of Blues; Lady Morgan, crimson; Queen of Beauty, white; Dr. Lindley, mauve; Lord Shaftesbury, white flushed with pink; and Flag of Truce, striped rosy crimson.

TULIPS made a good display, but the competition was chiefly confined to Messrs. Cutbush and Paul, both of whom exhibited splendid examples of these highly-decorative spring flowers. Messrs. Cutbush, who took the first prize in the Nurserymen's Class for twelve pots of six kinds, had Fabiola, Vermilion Brilliant, Duc d'Arenberg, Keizerkroon, Cramoie Royale, and Florida; while Mr. W. Paul, who was second, had White and Yellow Pottebakker, Vermilion Brilliant, Keizerkroon, Couleur Cardinal, Proserpine, and Van der Neer. Messrs. Cutbush and Paul had also extra prizes in the Miscellaneous Class for numerous and fine collections of the same flower. Among the Amateurs' the best collection came from Mr. Young, Highgate; Mr. Taylor being second, and Mr. Carr third.

CROCUSES were also shown in large collections by Messrs. Cutbush and W. Paul, to whom first and second prizes were respectively awarded. Albion, Sir W. Scott, Bride of Lammermoor, Calypso, Lina, Prince Albert, Marie d'Ecosse, and Golden Yellow, were a few of the most striking. In the Amateurs' Class Mr. Young had the first prize.

MISCELLANEOUS.—There being little, and in some cases no competition in the remaining classes, it will be most convenient to include them all under this heading. The only exhibition of Amaryllis was from Mr. Parker, Tooting, who had Formosa, Johnson's psittacina, and Ackermann's pulcherrima, which were very brilliant. Of Epacris, though prizes were offered, it is surprising that none made their appearance. Of Lilies of the Valley, the only exhibitor was Mr. Bartlett, of Hammersmith; and of Chinese Primulas, the best came from Mr. T. Todman, gardener to R. Hudson, Esq., Clapham Common, and Messrs. Dobson, of Isleworth, who were second. In Camellias, Mr. W. Paul had first prize for a fine stand, and Mr. Treen, of Rugby, second. Messrs. Paul, Cheshunt, received an extra prize for pot Roses; and Mr. Bull, Chelsea, for new and rare plants, among which were included a finely-grown specimen of the curious *Cephalotus follicularis*, the Silver Palm of New Grenada (*Ceroxylon niveum*), *Asplenium rachirhizon*, *Adiantum cardiochlena*, Camellias, and Azaleas. The last-named were also shown in good bloom by Mr. Todman; and near them was a nice collection of *Narcissus* from Messrs. Cutbush.

By far the most interesting feature of the Show, however, was the green-leaved female Aucuba, loaded with a profusion of its orange-red fruits, and thus realising the expectations which were formed of it on the introduction of the male plant into this country. It came from Mr. Standish, of Ascot, who states that the fruit consists of one hard globular seed covered with a thin skin. When the male

plant becomes plentiful enough, there can be little doubt that the *Aucuba* will be planted as extensively for its ornamental fruit as it now is for the foliage. Mr. Standish also contributed a curious *Azalea* from Japan, having the petals cut into long narrow pink strips.

A SPRING Show! alas! what a day for it. The storm that raged in the Council-chamber a few days ago was nothing to the storm that raged without on this the first day of the new campaign of the Royal Horticultural Society; and, if an omen of the future, we might well despair. The whole of this season, so fertile in changes of temperature and disappointed hopes as to the departure of winter, has not witnessed a more unseasonable day than this was; and albeit the arrangements were excellent, displaying far more consideration for the comfort and convenience of the public than on any previous time since the revival of the exhibitions of the Society, yet never did one feel less inclined to look at flowers than in the cold wintry day that marked the Hyacinth Show;—to the Society, to the public, and to the exhibitors it was a loss: to the Society, because of the funds; to the public, as they missed thereby a great treat; and to the exhibitors, who, of course, hope to see their flowers admired and criticised.

Well, we must make the best of it, and take a few rough notes with a florist's eye of the principal objects of merit. With regard to Hyacinths, I do not think they were ever exhibited so fine, the principal points of interest being undoubtedly the various collections of Messrs. Cutbush and Paul; the former regaining the ground he lost last year, and coming off first in every encounter. More splendid flowers could not be; while it is but justice to Mr. Paul to say that he was not much behind, and in eighteens was considered by the Judges as equal to his competitor.

The class for New Hyacinths naturally attracted one's chief attention; and here some really meritorious flowers were staged. I may mention, as amongst the best there, *Robert Fortune*, a fine flower of great distinctness of colour; it was of a delicate mauve, with dark stripes of the same colour; the bells were small, but in considerable numbers, and the truss remarkably fine; altogether it was a very excellent flower. *Schwarzwald*, a dark purple flower, promised well. *Henrietta Elizabeth* was curious, a flower marked not unlike *Striata perfecta* Verbena, light lilac with dark stripe in it. *Queen of Denmark* was too small, and *Die Jung Frau* too large, having some of those large, thick, Mont Blanc bells, which, I do not think, form the best spike of Hyacinth. *Joséphine*, the last of the six, not the least, was a beautiful flower, the colour an intense orange scarlet, and the spike good. It will be noticed that all these are single flowers.

Amongst Mr. Paul's six *Alba Nova*, another of the large-bell class, and Sir Charles Napier, a large blue, seemed to be the most promising. In looking over the various stands the following caught my eye as fulfilling most what one looks for in a good Hyacinth. I will give them promiscuously from Mr. Cutbush's and Mr. W. Paul's stands:—*La Dame du Lac*, *Lina*, *Macaulay*, *Pelissier*, *Reine des Jacinthes*, *Robert Steiger*, *Solfaterre*, *Von Schiller*, *Princess Clothilde*: these were Single Reds. Of Whites there were *Gigantea*, *Grandeur à Merveille*, *Madame Van der Hoop*, *Mirandoline*, *Tubadora*, and *Mont Blanc*. In Single Lilacs *L'Unique* and *Haydn* were both good: while in Blues, *Argus*, *Baron Von Tuyll*, *Grand Lilas*, *Charles Dickens*, and *Marie* were excellent. In that intense dark shade of purple which is very nearly black *General Havelock* is undoubtedly A1; while *Von Humboldt* with its white eye is distinct and good. In Single Yellows *Duc de Malakoff* and *Ida* were the best and most generally shown.

I almost wonder that there are not more growers of the early Tulips. As decorative plants they are most effective; and it was only this day that in the wonderfully gay conservatory of Lord Leconfield's, at Petworth House, I noticed how gay they looked. There are some exquisite colours amongst them, although their shape is not up to the true florist's model. Amongst the best in Mr. Cutbush's very fine collection were *Bruin van Haarlem*, *Coleur Cardinal*, *Duc d'Artemberg*, *Marquis de Wessenrode*, *Pottebakker* (white), *Proserpine*, *Fabiola*, *Florida*, *Keizerkroon*, *Rose Luisante*, and *Roi Pepin*. Messrs. Paul & Son quite charmed the

few visitors there with half a dozen nice plants of the dear queen of flowers, well bloomed and, for the time of the year, excellent. They were—*Anna Alexieff*, *Triomphe de Paris*, *Madame Villermoz*, *Marquise de Foucauld*, *L'Enfant Trouvé*, and *Souvenir d'un Ami*. In cut blooms of *Camellias* there were only two stands. In Mr. W. Paul's I noticed *La Reine*, fine; *Princess Bacciochi*, dark red; and *Jubilee*, pink. As I know you have fuller notes of other matters I shall not add any further remarks.—D., *Deal*.

FLORAL COMMITTEE, *March 9*.—The first Meeting of the year was held on this day in the Council-room at South Kensington, and, it being a special Hyacinth Exhibition, a Sub-Committee was appointed to report on the plants sent for examination.

From Messrs. Veitch came *Gymnogramma* sp. Chili, a very handsome erect-growing Fern, with long, broad, finely-pinnate foliage, not unlike an *Adiantum*—first-class certificate; *Asplenium palmatum cristatum*, having the appearance of one of the *Scolopendrium* monstrosities, and which, when seen in better condition, will doubtless receive some notice; and *Lycopodium pubiflorum*, a hardy wall climber, which has stood the test of the three last winters. It produces dark purplish bell-shaped flowers, scattered over the branches, which bear but little foliage. This will be found a useful plant at this early season of the year. It received a second-class certificate. The same firm sent *Azalea Stella*, a very finely-formed, promising variety, with bright orange red flowers, the upper petal spotted on a purplish ground; but there were not sufficient flowers open to justify an award, which it will doubtless receive if shown again in better condition. Also *Rhododendron* sp. nova, *Moulmein*, producing large, white, loose, rough flowers, a plant of dwarf habit and useful for decorative purposes—commended; and a seedling *Dendrobium*, one of Mr. Dominy's raising, inferior to noble and moniliforme, which it somewhat resembled.

From Mr. Bull came *Gymnogramma plumaria* (?); *Lomaria cycadiflora*, exhibited by Messrs. Lee, 1861, a handsome tree Fern, known also as *L. gigantea*; *Chameranthemum reticulatum*, a dwarf fine-foliaged plant; *Lastrea erythrosora*, which received a second-class certificate in 1863, and which much resembles *L. opaca*, but is distinct, from the bright red sori; *Aspidium pinnatum*, better known as *Lastrea patens*; and *Pandanus furcatus*.

Mr. Short, Clewer Park, sent a small branch of *Pycnostachys urticifolia*, bearing terminal heads of dark blue flowers. If the habit of the plant were suitable for bedding purposes it might be useful.

From Mr. Todman came *Azalea Lord Derby*, flowers bright rose, deeply spotted on the shaded upper petal; not equal to many varieties of its class, still, as a decorative plant, very useful—it received a label of commendation; also, *Azalea rosea plena*, and a white variety.

Among the new Hyacinths the Committee selected four as worthy of special notice as distinct and good:—From Messrs. Cutbush, *Robert Fortune*, a very conspicuous flower, fine large spike, with pale lilac-striped bells on a whitish ground—first-class certificate; *Joséphine*, very bright vermilion, perhaps the brightest of its class, medium spike, very showy—second-class certificate; *Henrietta Elizabeth*, a pale silvery lilac, novel in colour, medium spike, very distinct—second-class certificate; and from Mr. Wm. Paul, *Lord Palmerston*, a light blue, with white centre, after the style of *Argus*, large spike, exhibited last season among the novelties, and much admired—first-class certificate.

Mr. Standish, Ascot, sent a fine specimen of the green-foliaged *Aucuba*, introduced from Japan by Mr. Fortune, a female plant, thickly studded with bright scarlet berries the size of sloes. This was considered the greatest novelty of the day. It is a most valuable addition to our present hardy shrubs, and will be found, being perfectly hardy, an indispensable plant for winter decoration. In addition to the first-class certificate awarded, to stamp its excellence and value, the Committee have recommended it to the notice of the Council as a plant worthy of the Society's Medal. Mr. Standish also exhibited a very singular specimen of an *Azalea* from Japan, with long strap-shaped pale rose petals, which seemed to be entwined among the narrow foliage. This was a botanical curiosity, and, when compared with

the modern florist's idea of a perfect well-formed Azalea, was very interesting.

Mr. Dobson sent five seedling Cinerarias, but none of them in advance of well-known varieties.

ORCHARD-HOUSES.

It is now six years since I became practically acquainted with orchard-houses, though well, I hope, let into the secret of cultivating trees in pots by a frequent perusal of Mr. Rivers's "Orchard-House" some time prior to becoming practically acquainted with them. I never doubted that fruit could be grown equally fine in pots as from trees planted out: in fact, I had seen trees so grown long ere the idea occurred to Mr. Rivers, and which has received so practical a solution at his hands. The idea of growing fruit trees in pots is not new, as any one may prove by a perusal of Abercrombie, and that it was practised by the gardening community long after his time I have not the least doubt; but in only one instance do I remember to have seen that system followed, and then only for the purpose of obtaining early fruit.

Mr. Paxton (now Sir Joseph) in the "Horticultural Register" for June, 1833, gives a very full description of a Cherry-house, with a section of the same, and from it we learn that the trees were planted out. In the same article are directions for the cultivation of the Cherry in pots and tubs, and that under various circumstances; so that the idea of growing fruit trees in pots was by no means new at that time, for Sir Joseph speaks or writes of it as a thing accomplished, and not prospectively.

Mr. Rivers, however, was the first to grow fruit trees in pots in a cool house without any artificial heat. He was the first to show that by the aid of a glass covering our climate might be made more suitable for the growth and perfection of some fruits, which without it were a precarious crop, and the cause of much annoyance to all concerned from their failing. He was the first to promulgate a practical code of regulations by which miniature fruit trees were to be formed and managed, and, I believe, first succeeded in bringing to perfection a greater variety of fruits in one house than any cultivator before him. His practical views and common-sense writing as embodied in his work, "The Orchard-House," have obtained for him many adherents to his system, and I doubt whether there is either a work on gardening that has reached so many editions in so short a time since the appearance of Abercrombie's "Every Man His Own Gardener," or a system that was ever more generally adopted than his of growing fruit trees in pots, in houses with little wood and large panes of glass.

The system, as a system, is in every way sound, because based on the strictest regard to the laws of Nature. It is a well-directed effort at assisting her, providing means to enable us to contend against the vicissitudes of a cold climate, and enabling us to bring to perfection some fruits which otherwise would not be enjoyed in anything like profusion.

Of all subjects that have engaged the attention of horticulturists, none have shown or brought out greater literary ability; but in the midst of this there has been too little of the simple desire for ascertaining the truth of the matter. I do not say that men who had no experience in growing trees in pots in orchard-houses have no right to offer an opinion on the subject; for those with eyes, and who travel about from place to place, and there see the practical working and results of the system, are fully entitled to give their impressions equally with those that manage them. There are some, however, that conceive a notion that a practice newly introduced is wrong, and they go about with a desire to find experience in harmony with their notion, more than to ascertain the merits or defects of the system.

Now, I have done a little in one of these ways myself. I shall not say which, but leave that to the reader. I have a house some 50 feet long, and 14 feet wide, and span-roofed. In the centre is a bed about 3 feet wide for Peaches and Nectarines, and a bed or border all round the inside of the house a yard wide. One side is occupied by Plums and Cherries, the other with Pears, and at one end are a Fig and four Apricots. A pathway 2½ feet wide runs round the house. The path is sunk in the ground, and the borders are

upheld by flagstones set on edge. The sides of the house are boarded with half-inch deals to a height of 4 feet, and then comes the glass roof. The second board from the glass opens by the means of hinges. The roof is formed of lights, which we had by us, so that there is a departure from the original. These lights, however, formed part of a house in which Peaches had been grown, and Grapes, too; so that it was reasonable to conclude, that what had answered for the growth of a certain thing would do so again under similar circumstances. It may be as well to state that the house was heated from which the lights were taken. We put up the house thus for about £13 7s., and the trees were had from various parties, for we experienced a difficulty in obtaining them. The trees cost £12 10s. They were in pots or potted, and were purchased in October.

We now come to the management. In every particular the directions given in Mr. Rivers's "Orchard-House" were followed, and the trees managed by my own hand. There was no fruit, except some Pears, and these were moderate fruit, and some Cherries. The trees being potted was considered the cause of failure. There was a fair amount of work with them, but no more than in any other house with plants in pots in it; and as for insects, I do not know that there was any more trouble with them than with plants in general. The trees were duly top-dressed in autumn, and put to rest, and the house crammed with Endive, which was very useful in the February following. During the summer some Strawberries had been prepared in pots, and these, put on a shelf, afforded some fine fruit in the following season. The trees were attended to as directed, and in spring we had a desperate attack of brown aphids. Smoking the house was of no avail, for the smoke could not be kept in, as the boards had shrunk so much with the dry weather, and as a last resource Gishurst compound was used. This killed the insects, and the bloom of some trees also, so that we had little fruit again, and the Peaches were as mealy as a stewing Pear in January. The Plums, however, were delicious. In autumn the aphids again attacked the trees, but a coating of Gishurst compound settled it. The wood, however, was not ripe, and it was plain our notion of an orchard-house was a failure.

After all we did not give in. We have enough smoke here to turn a white man black, and to remedy this evil some netting was procured and put over the ventilating openings. Hopes again all disappointed; but, not to be beaten, another move was tried—that was to plant the trees out. This, like many others, was a retrograde step. The wood ripened all the worse, and the fruit (and it was meagre), was as late as we might expect it from walls in a dull inclement season. From that time to this things have become worse, and it now seems a struggle between animal and vegetable existence; for the trees are no sooner clear of insects than they swarm with the pest again. The cause of failure must be due to two things—viz., the house or the management. The house was made according to the originator's directions, except the roof, which was formed of lights no darker than in houses of ten years' standing in general. They afforded sufficient light for the perfecting of Peaches and Vines when the space enclosed was heated, but not when the space was kept cold.

As for the management, it was such as the fifth edition of Rivers's "Orchard-House" gave directions for, and these were followed according to the best of my judgment. Peaches and Nectarines could not be grown in this house with more certainty of a crop than on walls without the protection of a glass covering. It was warm enough for Plums, but not for Figs, Peaches, Nectarines, or Vines. Our situation is high and exposed, and the ground slopes from the sun. The soil is a very strong loam, with a clay subsoil. Our mean annual temperature is about 47°. It is evident that the house did not raise the temperature sufficiently to produce the fruit said to be grown by the aid of orchard-houses. That it did increase the temperature considerably I am aware, and that to an extent of several degrees. By keeping a register of the highest and lowest temperatures, as shown by thermometers in the house, it was certain that the temperature, on an average, was 5° higher than that of the external air; but this augmentation was not sufficient to be suitable for the growth of the Peach and Nectarine. If it were not warm enough, why not heat it? That would make a forcing-house of it, and the name of "orchard-house" would be a misnomer.

We do not propose heating it, but to keep it as it is. I confess to having proposed a trial of the system on a small scale, with a view to test its merits and defects. Not answering expectations I put myself down as against the system in cold localities, but not against it where the Peach can be grown on walls, the Apricot on cottages, and Vines on house walls. There, I say, an orchard-house would obviate much of the uncertainty of obtaining a regular produce, and, besides being a pleasing recreation, would yield a fair amount of profit; but in cold localities like this, if you expect Peaches, Grapes, Apricots, and Nectarines from orchard-houses these must be heated, or nothing short of disappointment will attend your efforts as it has mine. Plums, Cherries, and Pears can be grown in them without artificial heat, and in that respect they are of value to occupiers of cold wet localities. The last three are a more certain crop; and a finer and higher-flavoured produce is secured by employing a glass house as a protection than by trusting to walls.

Turning from the subject as it affects oneself, I will state how my neighbours have fared with their orchard-houses. Within the last six years a number of these structures have sprung up round here, and all have had more or less of success and failure. By one and all it is said, "Orchard-houses are humbug." To grow Peaches and Nectarines we must have the houses heated. Were it that gardeners did not mind telling publicly of their failures, depend upon it we should soon get at the bottom of the subject. I have invited several gardeners to keep an account of the quantity of fruit gathered from the orchard-houses under their care; but although they promised to do so the returns are not forthcoming. I bespoke returns from six orchard-houses and the same number from the managers of Peach-houses, and the last only have come to hand. I know too well what human nature is, and I could tell what hindered the former giving up (for I have reason to know returns were made), their records, and what made the others so prompt in doing so. In all the houses in the north that I have seen, I never yet saw a crop of Peaches or Nectarines where the house was independent of a wall and unheated. At one place there were three orchard-houses side by side on the ridge-and-furrow principle. They were occupied by trees in pots, and the Pears and Plums were loaded with fruit, and I understood a good crop of Cherries had been gathered. The Peaches and Nectarines were a failure; but in a vinery close by were some Peach trees in pots carrying on an average three dozen fruits each, some of which measured 8 inches round, and these trees were taken at random from the orchard-houses aforementioned, and put in the vinery which was heated in the spring. Who can wonder that the proprietor of these houses has decided on heating his orchard-houses?

Another gardener of my acquaintance has an orchard-house with the trees in pots. He, too, obtained a plentiful crop of Pears, Plums (I never saw finer), Cherries, and Apples; but the Apricots, Peaches, and Nectarines were indifferent. In the vinery there were also some Nectarines in pots bearing a splendid crop of fruit. Who could be surprised at the owner heating one half of his orchard-house for Peaches and Nectarines, and devoting the other half unheated to Plums, Pears, Cherries, and Apples? A third failed when the house was unheated; but planting the trees out they did well, especially after the house was heated, but not so well that the proprietor could see he was getting a good return for his expenditure, for at his desire the house was converted into a vinery. I could multiply cases of this kind but will turn to another branch of the subject. My friend, a baronet's gardener, had a glass case erected against an ordinary garden wall, the fruit trees on which did not yield a crop oftener than once in seven years. He tells me he had a splendid crop from his one hundred yards of covered wall, and that without artificial heat. Again: another had a glass case put up against a Peach-wall, and the result was a good crop of fine fruit. "What do you term a good crop?" "Well, six trees, covering a space 100 feet long by 10, gave eighty-eight dozen." No heat again in this house, and a crop of fruit when the trees were uncovered could only be depended on once in four years. A third showed me a tree (Peach), protected by a glass covering, merely some old lights patched up, and on it I counted thirteen dozen of fruit, but these were not all, for the gardener cut me short by

saying there were twenty-one dozen upon it. It covered a space of 24 feet by 12. On the remainder of the wall there was a very fair crop, but the fruit were neither so fine nor so early as those in the glass case. I need not say no heat beyond that of the sun was enjoyed by this tree, and there is less reason to say the whole of the wall is to be covered with glass. More instances of casing walls with glass are at hand, in which Peaches and Nectarines have with certainty been obtained without any artificial heating. In orchard-houses about here these two last-named fruits are a precarious crop. One individual has had such a house three years, and he has had nothing for his trouble, because he grows nothing but Peaches and Nectarines, and they will not fruit until the house is heated: therefore, a flue is to be put round it. I think I may now sum up.

Orchard-houses in cold wet localities are useless, and do not enable us to grow Peaches and Nectarines without artificial heat. Glass-covered walls do; and for this reason I contend that a covered wall is far preferable to an unheated orchard-house for the growth of the Peach and Nectarine. I, therefore, beg to differ from the dictum of Mr. Pearson:—"The time will soon come when to build a wall uncovered with glass for the production of Peaches will be considered an absurdity. I have always recommended orchard-houses to be built in preference to covering walls," &c. What is the practical use of an orchard-house for the production of Peaches in a cold district? None at all, unless it be heated. Why not build a wall and cover it with a glass case? It affords good Peaches in cold districts without having to be at the expense of a heating apparatus, and an annual increase of wear and tear in addition to the first cost. It must be absurd to recommend a useless article, and speak disparagingly of walls, which are at once shelters for the remainder of the garden, and only needing the expense of a glass covering to render them all that is required for the production of Peaches. What would our gardens be without their walls? Put up glass houses instead of walls as shelters for our gardens! Why you might as well send for a lump of ice from the Wenham Lake Company and see if that would increase the temperature of your sitting-room, as expect glass houses in the place of walls to shield a garden from cutting winds, and be the agents in forming warm south borders, or a north one, in which to retard certain things required late. A writer not long ago made the remark in a contemporary that he had seen Cabbages blown out of a garden enclosed by ten-foot walls in Yorkshire, and to remedy this he recommended glass houses in the place of walls to shelter gardens. Did it ever occur to this gentleman that, if walls did not hinder Cabbages being blown over them, his glass houses would stand a likely chance of being taken up like an umbrella, and if he happened to be upon them he might obtain a cheap ride into an adjoining county? If walls are no protection, I am sure orchard-houses, unless made stronger than any I have seen, are the last things in the world to think of for affording protection to gardens. Every tub has enough to do to stand on its own bottom, and the less orchard-houses are kept from intruding into places where they have no right the more popular are they likely to become. I do not run down orchard-houses, they are very good in their place. Fine, large, well-flavoured fruit can be grown in them, as I have seen and tasted; but they are utterly valueless in cold districts for producing Peaches, Nectarines, or Apricots. They are a boon in those localities when heated, and of great service unheated for Plums, Pears, and the hardier fruits. G. ABBEY.

PREVENTING THE GOOSEBERRY CATERPILLAR.

On looking through your Journals of the last year I find in the Number for February 17th the question, Whether any of your readers know the effect of spent tanner's bark, or any other mode, of preventing Gooseberry caterpillars?

On further reference I find only two methods suggested—viz., soot and white hellebore; but I think if any of your readers would try the experiment of sowing Broad Beans between the rows of Gooseberry bushes, or as near them as convenient, they would not be troubled with this unwelcome visitor. My reason for thinking so is as follows:—Some

few years ago I occupied a small garden, adjoining others, and noticed that while my neighbours' bushes were greatly infested with the caterpillar, mine were perfectly free. I could in no way account for my exemption, but thought possibly it might arise from the close proximity of some Broad Beans; and in the following year I sowed some more near the same spot, and with similar results. The third year I, and those of my neighbours who adopted the precaution, were free, whilst others suffered.

I have no Gooseberry bushes in my present garden, so cannot speak of recent experience; but as the remedy, whether effective or not, is very simple, I offer it to such of your readers as may think it worth the trouble of trying.—
AMATEUR.

LARGE VINERIES VERSUS SMALL VINERIES.

I AM quite of Mr. Thomson's opinion in this matter; and, as he invites the opinion of others on the subject, I venture a few remarks, and will give the principal reasons why I consider large structures superior to small ones for the cultivation of the Grape.

I need not say anything about the natural habits or climate of the Grape Vine, as Mr. Thomson has already clearly shown that in its natural state it does not grow in a close, damp, confined atmosphere, but, on the contrary, in an exposed and open aspect, with plenty of dry fresh air floating about it. I will therefore commence with early vineries, as, in a general way, they are the smallest. I will divide the time occupied from when the Vines are started until the Grapes are ripe into three periods. First, then, I will take the period from starting the Vines till they come into bloom, and will suppose the Vines are to be started in the end of October or early part of November. Now, for five successive months, commencing with November, the amount of sun we get in England is not much, there being often many days together without any; the consequence, therefore, is that we have to depend almost entirely upon artificial heat for keeping up the proper temperature necessary for the well-doing of the Vines. Now, all gardeners who have had to produce early Grapes know how necessary it is that something like a uniform temperature with a moist atmosphere should be maintained while the Vines are in this stage of forcing; and I hold that these necessities can be more easily maintained, with more beneficial effects, in a large house than in a small one; and to illustrate it I will, as far as I am able, endeavour to point out the disadvantages I have found attending a small house for early forcing.

I believe the principal plea for small houses for early vineries is that they are more quickly heated than a large one. Granted such to be the case, is it not also a fact that they more quickly cool, just as hot water in a vessel containing five gallons will cool more rapidly than it would in one containing twenty gallons, because the bulk is so much smaller in the one instance than in the other? So, the air in a house holding only a small quantity must naturally cool more quickly than it would in a house holding four times the amount, and is therefore more liable to any sudden changes in the external atmosphere, and must involve almost constant attention, and constant firing, to keep up the required temperature; and this extra attention required is a disadvantage in more ways than one. For instance: it involves more labour by the person who has to attend to the firing of such a house, as well as the extra anxiety it gives the gardener himself, when he knows how any sudden change in the course of a night in the external atmosphere will affect the temperature of the house. Take, for instance, one of those changeable nights we frequently have in the months of November or December, and suppose the person attending to the fires should leave such a house at ten or eleven o'clock with the temperature all right, and the fire properly "banked" up, and perhaps before morning either the outside temperature has fallen several degrees, or else a rough wind may rise, and scarcely anything affects the temperature of a house more than wind. What is the consequence? Down comes the temperature of the house also; and when you enter the house in the morning the evil shows itself in the condensed moisture you see falling from all parts of the roof, and if the Vines are in leaf it will be hanging about

and dropping upon them, doing more damage than is often thought of at the time. Now, who can be blamed for this state of things? Certainly we cannot blame the person who attended to the fire; for young gardeners cannot be expected to be always able to foretell at night what the weather will be next morning.

Another and in my opinion a great disadvantage attending small houses is in giving air, particularly in early forcing, for, as I before stated, we have to depend so much on artificial heat in the absence of sun. Now, the want of sun naturally causes the external atmosphere to be such as to require great care in admitting air into a house when forcing is going on; and, on the other hand, the use of so much artificial heat makes it necessary that fresh air should be admitted, and that nearly constantly; and I maintain that unless the means of ventilation are very good indeed in a small house, there is a greater likelihood of cold draughts coming in contact with the Vines than there is in a large house, as there is not the space below the Vines for the fresh air to circulate and mix with the already heated atmosphere in the house before coming in contact with the Vines.

These, then, are, in my opinion, and what I have found to be, some of the principal disadvantages attendant on small vineries for early forcing, up to the period of the Vines coming in flower.

I will now take the period when the Vines are in flower and setting their fruit. I do not know that I need say much on this point, as the advantage of a large house in this instance speaks for itself, for all good Grape-growers know how beneficial a nice circulation of warm, dry, and pure fresh air is to the setting of the fruit, and they must also know how contrary are the effects of a close, damp, confined atmosphere, or cold draughts as well, while Grapes are in bloom. The latter are likely to rust the fruit, and the other to prevent the fruit setting at all.

I now come to the third period—namely, when the Grapes have arrived at maturity. The advantages derived from a large house in this instance—viz., the keeping of the fruit after it is ripe will, perhaps, be more applicable to late than early Vines, for it is seldom that early Grapes are required to hang long on the Vines, the demand upon them is generally too great for that; but while the fruit is colouring there is a great advantage in having fresh air constantly circulating about them, and in a small house it is a difficult matter to have this without admitting cutting draughts, which, although it may not materially affect the Grapes at that time, may be injurious to anything else that a gardener may be obliged to have in the house at the time. Such then, are some of the disadvantages of small houses for early forcing.

The advantages, therefore, which may be gained by larger houses for forcing Grapes than are very often used, may be summed up in a few words. In the first place they are not so liable to sudden changes as small houses are, consequently a more uniform temperature can be maintained when required. Secondly, a more constant and steady circulation of purer air can be kept up, which is more congenial to the habits of the Vine than a close, confined, and stagnant atmosphere, and particularly so when the Vines are in bloom; and thirdly, when the fruit has arrived at maturity a drier and clearer atmosphere can be depended upon with more certainty than in a low damp house; and this is a great consideration in late vineries where Grapes are required to hang for several months after they are ripe, and particularly where, as is very often the case, the house has to be crammed full of plants of various descriptions, which are not only feeding on the pure air contained in the house, but are constantly giving off an amount of moisture that in a small house is more likely to settle upon the Grapes before it has a chance of being carried off by circulation.

There is yet another reason why I think early vineries should be large and lofty. In most places where Strawberries are forced the early vinery is one of the principal places used for the purpose; for it is not every place that can boast of a house devoted to forcing Strawberries—I often wish I had one here—and every gardener who has had to produce early Strawberries knows how difficult it is to get them to set in dull weather when in the most favourable position. Much more so is it the case when he has only an

early vinery to use for the purpose, and that, perhaps, a small one. Now I am not going to say that in a large early vinery Strawberries would always set their fruit, but I am sure they would have a better chance of doing so than in a small one.

No vinery, in my opinion, should be less than 15 or 16 feet high at the back, the same in width, and about 4 feet high in front. Of course, the length can be carried to anything, and such a house as this would be all the better if it stood a foot or two above the ground level. That good Grapes can, and have been grown in small houses, no one can deny; but the question is, Cannot better be grown in a large house with more certainty of success, and with more pleasure than in a small? For how much more pleasant is it for ladies or gentlemen to walk through a fine, lofty, roomy house (particularly in these days of wide-spreading fashion, if I may use such a term), than to have to squeeze their way along a narrow walk through a house some 7 or 8 feet high, and as much wide, and, perhaps, the walk sunk a foot or two in the ground.

I have not seen the old conservatory at Chiswick since the year the Vines were planted, but I can quite imagine what a magnificent sight it must be when the Grapes are ripe, for few sights in gardening are more satisfactory to look at than a fine house of Grapes. All honour, then, to Mr. Thomson for the idea, whether his reply to Mr. McEwen led to the Vines being planted or not.

In conclusion, I will state that I do not think Vines only would be benefited by being grown in larger structures, but that nearly every description of fruit and plants would be the better for it; and as to the expense in heating, I believe a large house, where a high and uniform temperature has to be maintained, can be heated at as little expense as a small one, because when once a large body of air is heated, it retains the heat longer than a small body. But I find I have run on to a farther length than I intended when I commenced, and will finish by expressing a hope that the subject will be discussed by those who are more capable of doing so than myself, and that gardeners of long experience in Grape-growing will state their views.—J. H. MASON, *Stourton Castle Gardens.*

THE NEED FOR A WHITE BEDDING CALCEOLARIA.

I AM glad to see the subject of bedding Calceolarias taken up by your correspondents in the sister isle as well as by others in England; and in regard to the hardness of most of the ordinary varieties, I beg to correct what might appear asserting too much—that my article on the Calceolaria was written before the severe frost we had in the second week in January, so that the allusion to quantities of old plants withstanding the winter referred to those of the former year; and I may say the frost we had at the time mentioned being unaccompanied by snow, and so rapidly succeeding a long period of mild weather, when the plants were in a growing condition, proved too much for the old plants, which were entirely killed. This, however, was not of any consequence, as they had outgrown their proper proportion for the place they were in; but I also found that a batch of about four thousand plants of *C. Aurea floribunda* that were in a cold pit with no other covering but single lights, were much injured. They had grown a good deal since they were put in as cuttings, each plant, or nearly so, being knotted with flowers. Some other kinds that were near them had a wooden shutter placed over the lights, and took not the least harm, excepting *C. amplexicaulis* which is a little hurt; and a very little precaution, as a couple of mats thick, or such-like covering, would have saved the kind above-mentioned, which, as it is, is not seriously injured, and only a small proportion killed.

My purpose, however, is not to call attention to the hardness of the plant, nor yet to the fact of its now and then failing to supply us with flowers in the autumn months, which evil I fear arises from causes over which we have no control; but what I want to draw the attention of your readers to, is the want of a good white variety. Yes, a good white Calceolaria. Yellows and dark colours we have in abundance, and very good many of them are; but I want to see a good

white kind. More than once during the last twenty years this has been promised, and some eight or more years ago one was introduced, but its habit was bad, and it fell into disrepute. What I want is one having the habit and profuse-flowering qualities of *C. Aurea floribunda*, but with clear white flowers. Good white flowers are far from plentiful; perhaps the best pure white we have as a bedder is the Double Pyrethrum. Petunias are rarely or never white; and from what I have seen of Geraniums, they also fall short of what I want. Either the petals have a faint trace of flesh colour in them, or the stamens are another colour, or something else detracts from their merits. Verbenas have the same fault, and I never yet saw a Dahlia or a Rose that could be compared to the Camellia for purity in whiteness; but I am far from detracting from the merits of these valuable flowers. What I want florists and hybridisers to turn their attention to is colour not hitherto obtained in the plants in question; and if we could get a good white added to the other colours which we have in the Calceolaria, we would possess a gem which would place many who have not the means of wintering delicate plants in a position to enrich their gardens in a way they are not able to do at present. By degrees I trust this will be done, and whether it be so by gradually coaxing the now golden yellow kinds to fade into primrose or canary colour previous to becoming white, or whether the change be effected all at once, it is needless to say the plant will be acceptable in any way.—J. ROBSON.

AN AMATEUR'S HOT-WATER APPARATUS.

I STILL observe from time to time inquiries as to heating small structures, and I shall be glad if you will allow me to occupy a portion of your space with the results of my experience.

Although only an amateur, my plants have been one of my chief amusements for more than twenty years, during which time I have had to deal with numberless methods of heating; and as I hold with the saying that "If you want a thing well done you should do it yourself," I always made it a rule to understand the work from the beginning; and often have I been obliged on a winter's night, or rather morning, when returning from a party, to run down to my greenhouse to look after the fire. Under these circumstances, I am anxious to enable others to participate in the advantages of my present arrangement, as I have never found any system so generally efficient in its working. I will give at the end of this note a sketch of my houses and mode of heating, with the number of plants that I have under glass, which will of themselves be sufficient to enable many of your readers to judge of the work done; but before doing this, I will briefly mention what I consider the chief features of my plan.

First and foremost is the portability of the whole apparatus, gained by the use of the water-tight collar joints patented by Mr. Truss, of which I cannot speak in too high terms. The facilities that they afford to the gardener to obtain a temporary flow and return if required, to take out a defective piece if any flaw should be discovered, and to make any alterations that he may wish without the employment of skilled labour, must render them a great desideratum to practical working men, whilst the saving in expense will be of, perhaps, more than equal importance to the employers, more especially to those who only rent their premises, and might wish to be able to remove their garden structures. The whole of my pipes and houses can be removed at very short notice, without leaving a trace of their previous existence; and I do not believe that any portion of the apparatus would be in any way injured, with the exception of the collars and washers, some of which might require renewing. The boiler that I use is an upright one furnished by the same party, although, doubtless, any kind of boiler would do the work. I believe that the effective working of upright boilers mainly depends on the height and width of the fire-space. In mine it measures about 2 feet 6 inches by 1 foot 8 inches, and throughout the summer, from May to September, the boiler is almost entirely kept at work with the cinders from the house fires; during the past severe weather with hard forcing it consumed about a chaldron of coke in fifteen or sixteen days.

When the fire is made up at night about 11 p.m., it requires no further attention until the morning about seven or half-past, when there is often a good fire still burning, and the result is that in my houses, made of thin boards with glass sides and top, situated on a terrace on the top of a hill, and exposed on all sides to the wind, I have been able to maintain a temperature of 7° or 8° above freezing, whilst the thermometer outside registered 7°, or 25° below freezing-point.

I should not have ventured to trespass so much on your

space did I not know how much doubt and trouble are experienced before deciding on any particular mode of heating a plant-house for the first time, and the serious loss and disappointment caused when the plan adopted is found either defective or, at the best, unequal to the expectations formed of it. And now, on just leaving my little house full of flowers and their fragrance, and in which every plant appears to be thriving to its utmost, I shall be heartily glad if I can be the means of helping others to enjoy a like gratification.

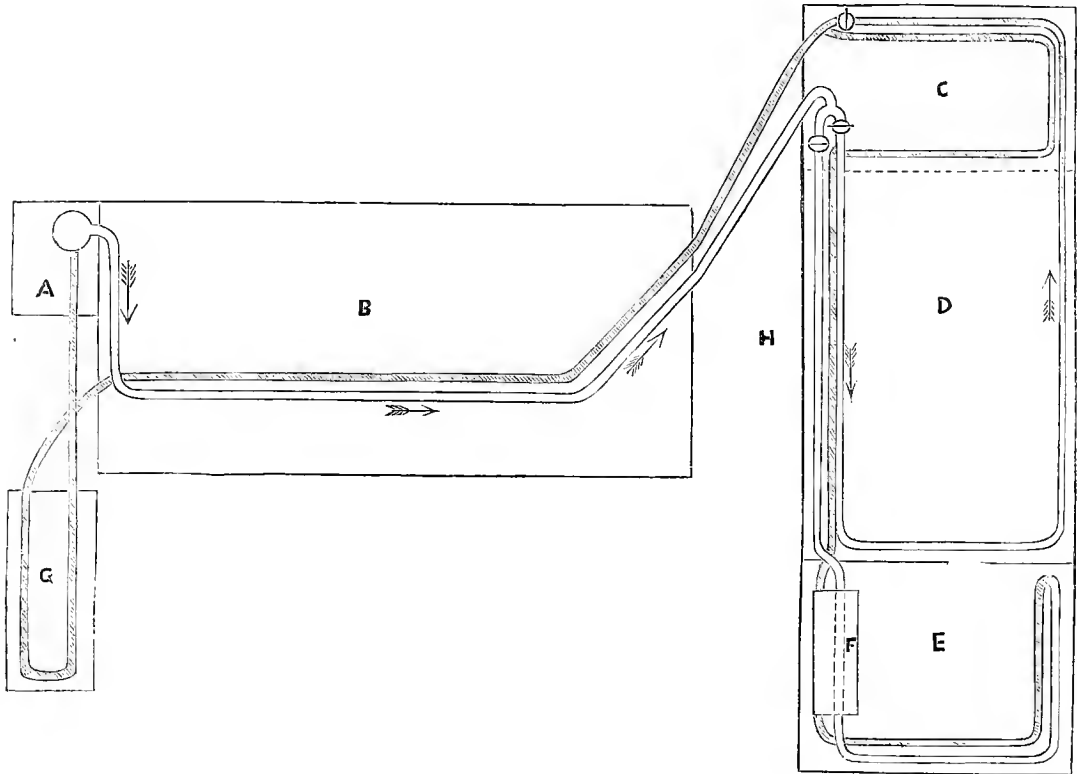

A Boiler house.
B Cold house.

C Cactus house, formed when required with a moveable partition at dotted line.

D Greenhouse.
E Stove.
F Propagating-tank.

G Open-air bottom-heat tank.
H Wall of terrace 12 feet high.
The return-pipes are slightly shaded.

The lower house B is a lean-to 28 by 10 feet, with ventilating sashes in the back wall, and intended to keep plants from frost. It contains, in addition to a quantity of bedding-out stuff, about four hundred plants, many of them specimens in large tubs and boxes more than 2 feet square. The upper house is 36 by 10 feet, with a two-foot shelf all round, thus giving the largest possible accommodation to ladies' dresses in the free centre. At the end marked c the return-pipe from the stove makes an extra turn, and by fixing up a moveable partition along the dotted line

I obtain a most genial temperature for large specimen Cacti whilst making their annual growth. The middle portion is now one mass of bloom, and there are in the whole length, including the stove, 510 plants, many of them in No. 1 and No. 2 pots. Should any of your readers wish for more definite information I shall be most happy to afford it, or they are freely welcome to call and inspect my arrangements by sending their cards to—C. M. MAJOR, *Cromwell House, Duppas Hill Terrace, Croydon.*

INFLAMMABLE GAS IN A HOTBED.

THOUGH the circumstances recorded by "J. K.," No. 154, are rare, yet they are not without precedent. In 1840 I saw a similar thing happen in a garden hotbed belonging to Dr. Holmes, of Linton, in Cambridgeshire.

As I was at that time studying chemistry, I there and then made some practical inquiry into the cause of the phenomenon. I collected several bell-jars of the gas, and after washing, &c., found the inflammable portion to be carbonic oxide, which burns with a lambent blue flame.

After all, there is nothing more strange in the event than

that it is not more frequently observed. The fact is, a portion of the bed had become almost hot enough to fire, and, like a heated haystack before it actually burst into flame, evolved carbonic oxide, a compound very generally generated when vegetable bodies are subjected to a destructive heat.—SEPTIMUS PIESSE, F.C.S., *Chiswick.*

[We are much obliged by this communication, for it is an answer based on experiment. The blue flame seen on the top of a clear coke fire arises from the burning of the carbonic oxide formed during the combustion of the coke.]

WEED VOLUNTEERS.

ONE hears of Rifle Volunteers in all parts of the country, but I do not suppose any of your readers ever hear of Weed Volunteers. Well, I beg to tell them that we have had such a corps here for eight years, and, if you will give me space in your practical Journal, I will tell you all about them.

In this neighbourhood there are many orchards, which invariably produce abundance of fruit, which is a sore temptation to many of the school-boys on their Saturday holidays; so it occurred to one of the ladies, that if some light employment could be found for them in the garden it would keep some of them out of harm's way—

“For Satan finds some mischief still
For idle hands to do.”

The thing was proposed to me; I was quite agreeable, and when it was intimated in school I shall not soon forget the forest of hands held up to be enrolled; four of the oldest and best-behaved were chosen to commence with, and next Saturday, when the garden bell rang after breakfast, in marched our new staff, each armed with an old knife, determined to deal death amongst the weeds. They were set to work on the walks, and by night it was surprising what a deal of execution had been done. As the season advanced some were set to work on the terraces of the flower garden, others in the kitchen garden to thin crops, but it was principally weeds anywhere and everywhere which they were to do battle against.

If a wet Saturday set in, and a lot of bedding plants are to be potted-off, it is surprising how many a good man at the bench can pot with such little fellows to crock pots, write or number labels, &c. Again: if a shortness of pegs is found towards the middle of summer, give them a lot of old brooms and a penny a-hundred, and the deficiency will soon be made up. In the midsummer holidays they work every day till dinner time, generally washing pots which are then empty by thousands. After dinner our little band is provided by their kind patroness with all the appliances for cricket, and are joined by the major part of the school, when they repair to some open green for the afternoon's game. When autumn comes, and weeds are becoming scarce, they are turned on to the lawn, armed with an old table-fork, to root out daisies, plantain, or whatever weeds are in the grass: the best way in this case is to pay so much per bushel according to the scarcity or plenty of weeds. At the age of fourteen they always leave us. Many go to the great nursery firms of Messrs. Veitch, Chelsea, and Osborne, of Fulham, where they find that their early training is beneficial.

I have only mentioned a few of the things which our boys do, but what I have said will, I hope, induce others to try what we have found to answer here; and I am quite sure most gardeners will be only too glad of the extra assistance rendered by their services. Our wages are 4*d.*, 5*d.*, and 6*d.* per day, depending on the industry each displays. Perhaps I may just mention that the girls are in like manner employed in the house to assist in the Saturday's cleaning, and this fits them for becoming useful domestic servants.—*J. Rust, Gardener to the Right Hon. L. Sullivan, Broom House, Fulham.*

TO PREVENT THE RAVAGES OF THE GOOSEBERRY CATERPILLAR.—It is a well-known fact that the Gooseberry caterpillar, larva of the Nematode or Gooseberry Saw Fly, is most destructive in light dry soils, where it reposes in comfort during the winter months. It is my misfortune to have to do with a soil of this kind, where caterpillars were notorious for their depredations. Nearly twenty years ago I adopted the by no means new, but very reasonable plan, of removing the soil round each plant for 3 or 4 inches in depth, and about 2 feet in diameter, and with the soil the chrysalis, the agents which supply the guests for the feast Nature provides in due season. The whole should be buried at least 18 inches or 2 feet in depth—the bottom of a deep trench will be found a convenient place—and fresh soil added in place of that which has been removed, which will assist in renovating the plants. If carefully done, this process need not be repeated oftener than every third or fourth year. Having long adopted this plan, I can confidently recommend it as being both economical and successful; and if any of the

numerous readers of your valuable Magazine are suffering from the ravages of the Gooseberry caterpillar, I would just say, Try it.—*ARCHIBALD FOWLER, Castle Kennedy, Stranraer. (West of Scotland Horticultural Magazine.)*

WORK FOR THE WEEK.

KITCHEN GARDEN.

THE late heavy falls of rain and snow have brought all out-door gardening operations to a complete standstill. As soon as fine, open, and sunny days arrive, there will be an accumulation of work to be attended to without delay. *Asparagus*, in favourable and early situations the beds may be slightly forked over; a little Lettuce seed may be sown upon them at the same time; also, sow *Asparagus* seed. *Broccoli*, make a sowing of the Early White for autumn use. *Cabbage*, transplant from the autumn-sown beds. Earth-up the early crops when the weather is favourable. *Cardoons*, a sowing may now be made if they are required early. *Cauliflowers*, as soon as they are thinned out to three plants under each hand-glass, loosen the soil about them, and draw it around the stems of the plants. *Cheevil* and *American Cress* may now be sown. *Leeks*, sow in a box or in a border for planting out, or sow where they are to remain. *Parsley*, a good sowing should now be made. Clean and loosen the soil between the rows sown last season. *Peas*, two or more crops of different kinds should be got in. *Knight's Marrow* is a fine-flavoured Pea, and also *Hairs' Dwarf Mammoth*. *Potatoes*, the main early crops to be planted as soon as the weather will permit. *Sea-kale*, beds may now be made. *Turnips*, make a sowing of Early Dutch, or Stone, or Covent Garden Snowball. The last is a very early and juicy sort, of excellent quality, small, and compact, and a fine variety for successive sowings.

FLOWER GARDEN.

When the weather has taken a favourable change any rearrangement necessary amongst the herbaceous plants to be made. Overgrown specimens of *Phloxes*, *Asters*, *Aconites*, *Rudbeckias*, *Pentstemons*, and *Monardas* to be gone over and reduced, and as many of them throw up too many flowering-shoots, it is advisable to thin them out, so as not only to obtain fine heads of bloom but increased strength in the remaining shoots, and to enable them to need less assistance from stakes. Sweep and thoroughly clean lawns, and give them a double rolling with a heavy roller to render the turf smooth and solid. This is sometimes put off until dry weather sets in, after which the roller makes comparatively little impression; whereas if done at once while the turf is in a wet spongy state, it will be greatly consolidated and improved for the season. If *Briars* are wanted for budding *Roses* on they should now be collected, trimmed, and planted in a reserve garden, or where they are wanted to stand for summer budding. All turfing, &c., should now be finished as soon as possible. Continue the pruning of shrubs, *Roses*, &c. Where bulbs are making their appearance the surface should be carefully loosened if the weather is dry and free from frost. *Tulips* considering the severe weather are looking well, still every precaution ought to be taken in order to insure a good bloom. Cover at night as usual. *Ranunculuses*, those who did not take advantage of a fine day or two about the 25th of February, have, of course, their collections still out of the ground. No time, however, ought to be lost if they are to be grown in proper season.

FRUIT GARDEN.

As regards fruit trees, operations recommended a month ago may be performed without being deemed out of season. Proceed with the grafting of *Plums*, *Cherries*, *Pear*, and *Apple* trees.

GREENHOUSE AND CONSERVATORY.

The continuance of winter and an almost totally obscured sun have had very injurious effects upon many valuable plants. When shifting plants it is generally recommended to use the soil in a rough state—that is, not sifted, but made fine by rubbing it through the hands, picking out the small stones, &c., and also to use plenty of drainage at the bottom. If plants were treated on the one-shift system—that is, removing them at once from a small to a very large pot, such drainage would be necessary to keep the mass of soil in a dry and healthy state, as it would otherwise

become sodden after waterings, before the roots had made much progress in acting upon it by absorption. But according to the general practice of shifting them from the size of pot in which they had been growing to the next larger size, so much drainage with a porous soil is unnecessary; and at this season in shifting plants at the approach of warm weather it is a disadvantage and an injury, because with such free drainage and rough porous soil the watering-pot must be in frequent use, and almost at the same time that the water is applied to the top of the pot it is seen or heard to fall out at the bottom. When plants are shifted in the autumn a porous soil is then more necessary to keep the roots in a dry healthy condition during the many dull and dreary weeks of winter; but now so much porosity is not necessary, and, therefore, this should be considered and acted upon during the spring and summer potting of plants. Fuchsias should now be making free growth in the warmest part of the house; to be syringed overhead every fine afternoon, stopped, if long-jointed, to form compact bushy plants; but if intended to be planted along the sides of walks, or as single specimen plants on grass, they should be grown with one main stem, from which the branches will spring all round, and thus they will form fine pyramidal specimens for pleasure-ground scenery. After the Camellias have done blooming examine the roots, and, if necessary, shift the plants, using equal parts of good turfy loam and peat, with the addition of a little sharp sand; to be placed in the warmest end of the greenhouse, and kept close and moist, both roots and tops, until they have set their flower-buds, when they may gradually be exposed and hardened-off by giving air more freely.

STOVE.

Proceed with the repotting of such plants as require it, and give all necessary attention to those in active growth. To secure strong short-jointed wood keep up a vigorous root-action, and let the plants occupy a place as close to the glass as possible. Specimens started early may require rearrangement. *Ixoras*, *Clerodendrons*, *Allamandas*, &c., that have become well rooted may be supplied occasionally with liquid manure, but to be given in a tepid state and not over-strong. Look sharply after mealy bugs and thrips.

FORCING-PIT.

This will now be found a useful structure for encouraging the growth for the young stock of various stove plants, such as *Ardisias*, *Brunfelsias*, *Clerodendrons*, *Echites*, *Euphorbias*, *Gardenias*, *Gesneras*, *Gloxinias*, *Gloriosas*, *Poinsettias*, *Thunbergias*, &c., the whole of which delight in a humid atmosphere with a nice bottom heat.

PITS AND FRAMES.

The cuttings of *Verbenas*, *Fuchsias*, *Petunias*, *Anagallis*, *Lobelias*, *Ageratums*, and other such half-hardy things to be put in now. They will strike in little more than a week if plunged in a sweet bottom heat of 75°. W. KEANE.

DOINGS OF THE LAST WEEK.

KITCHEN GARDEN.

THE seeds sown last week were scarcely in before we had a soaking rain, which, followed by fog and drizzle, has prevented operations in the open ground. On Wednesday we had a heavy fall of snow, which lay on ground previously soaked; and on Thursday morning a very sharp frost, which would have injured many things but for the covering of snow. We think it just as well that the weather has prevented us sowing the main crops of Onions, &c. There is little injury from frost to such seeds, or even young seedlings, when well up—the time of danger is just when the seeds are sprouting in the ground, and the seed-leaf has not appeared above ground: hence many seeds of half-hardy and tender annuals will remain uninjured in the ground all the winter, and will often come better in summer naturally than those we sow with care, because the frost has little power on them so long as they are in a dormant state, and the germination of the seed is not likely to take place until the ground is sufficiently heated as well as moistened. If the wet cold weather continue, it would be advisable for those with heavy cold soil to contend with, to sow Onions, Leeks, Lettuces, Cauliflowers, &c., under protection, and transplant for early crops. This will be better than tramp-

ling about on clogged wet soil. Such ground will have a tendency to keep stiff and cloggy all the season, and seeds covered by it are often so coated over with matter impetrable to air, that germination is next to impossible; and thus seeds are often blamed for not growing when the real fault lies with the sower. Waiting a week or ten days, to get the ground in a nice dry friable condition, is often in reality time gained. Through such grounds future rains will pass freely, and leave their virtues behind them, which potched and clogged land never will allow. All work connected with vegetables has consisted in keeping up a regular succession of forced or protected things, as mentioned in the previous week, the only novelty being Swedish Turnip-tops for the table, blanched yellow by placing some good tubers in a shady place in the Mushroom-house. If not more than one or two cuttings are taken from these, the tubers are but little injured, if the tops are not more than 6 to 7 inches in length. These make a very palatable and healthy dish, and may be had all the winter where Turnips are comestable. The Swede is the best for this purpose; the blanching in the dark removes the extra acidity of the Turnip-top, and leaves enough to tempt the appetite. We have received thanks from some farmers who have thus supplied themselves with these tops in winter, when other vegetables were scarce, by making a slight hotbed in a shed, covering it with earth, placing the Turnips in the earth, and a close wooden box over it. If they preferred the tops green, they opened the lid of the box during the day. One gentleman farmer has also managed to have a good supply of Mushrooms from a bed in an unused stall in a stable.

FRUIT GARDEN.

Very much the same as last week. A little sun on Thursday will keep the Strawberries in flavour and setting, and give a start to Melons, Cucumbers, &c. The snow on Wednesday having covered the orchard-house roof, we took the opportunity, merely as a matter of precaution, to smoke the house with bruised laurel leaves. Removed also some of the surface soil as the weather would permit, to be replaced with fresh after the dry places were watered; but dislike wheeling or moving soil in wet weather. Finished clearing out the late vinery. At the back of the house some Vines were planted, to relieve a little those planted in a border in front outside, which have long borne rather heavily. Scraped off the surface soil; watered, as the ground was very dry for keeping the Grapes, and top-dressed with cowdung and a surfacing of fresh soil, and then filled the floor, stages, shelves, &c., with bedding plants. Tied and regulated Vines in first house, disbudded Peaches, &c.

In our orchard-house there is a gravel path at the back, or within 15 inches of the back wall, which we have wished altered, and now will have it to our mind. Last season we were very scarce of water, and that path required a great deal, and even then the soil beneath it was kept moist with difficulty, so great was the radiation of heat and evaporation of moisture from it. Then we had frequently to prick the surface to give it a good soaking; and thus, however fantalising the crops, no one could walk through it comfortably for several days. As the most economical plan for a pathway which would afford a passage at all times, and permit of the soil beneath being open and moist, we are preparing narrow wooden trellises in seven-foot lengths, width 16 inches, formed of oak cross-pieces of that length, and 2½ inches square, for supporting five longitudinal pieces of deal 7 feet long, 2½ inches wide, and 1 inch thick. This will leave rather less than an inch between the pieces, so that the tiniest lady's slipper will run little chance of getting between them. These are very old-fashioned paths, but they are very useful, can be easily moved, the ground stirred, &c., and then placed in a line; they are also economical, if care is taken that arrangements are so made as not to have an inch of waste in the cutting of the timber.

In preparing for this, we have also altered the position of our iron stove, previously alluded to, by sinking it all the deeper in the ground, so that the smoke-pipe shall pass through to the back wall, beneath this wooden gangway, as previously it was some 18 inches above the gravel path, and it was necessary to step over it when at work, which was not pleasant at all times. To keep the earth from falling in round the stove, we have placed a brick on bed and on edge

so as to have a clear space all round the stove. If the iron stove should burn out, for it is now an old one, the cleared space will do nicely for placing a brick stove in. Not wishing to lose the length of this horizontal pipe that crosses the house to the chimney outside the back wall, and yet to secure a good draught, we raised the back of the stove so as to be 2 inches above the level, and the pipe sloping all the way, the draught is now very good, and can easily be regulated.

HEATING.

For all large affairs, and heating many places from one furnace, there is nothing like hot water. To heat small separate places, and yet show no means of heating, the simplest plan is to have a narrow flue, the cover of the flue to form part of the floor of the house. Where economy in heating such small separate places comes in as the first consideration, or when, even in a rather large lean-to house, it is wished merely to exclude frost in spring, then as to economy there is nothing equal to an iron or a brick stove inside the house, each having its appropriate smoke-funnel. No other plan will yield the same amount of heat from the same amount of fuel, so as to tell upon the temperature of the enclosed space.

We cannot help it, if our go-a-head friends call out about retrogression, vandalism, and all the rest of it. We only speak as we practically know. A gentleman told us lately, that acting on our advice he had a small six-inch flue taken round and beneath the paved floor of his little greenhouse, and the expense of the flue, furnace, and fuel for eight years has just been half the sum of the lowest tender he received for heating it with hot water. Another tells us he can do anything in his little lean-to house with an Arnott brick stove against the back wall, concealed by the sloping stage, and that he needs no regulator, except a moveable opening in the ashpit-door, and that from a large metal pan on the stove top, and some vessels of water near the side of the stove, he can have as moist an atmosphere as he pleases. To obtain moist as well as dry heat from such stoves, in other words, to get hotbeds as well as an increased atmospheric temperature, we have seen nothing, so far as the economical and useful are concerned, equal to the stove and small boiler of Mr. Rivers, except the plan represented at page 172, by "M.," of Liverpool. The distinguishing features of the stove of "M.," are the coiled pipes instead of a boiler, and the moveable grating, or sash-bars, first described, so far as we know, by Mr. Allen, in Vol. XXV., page 134. Were we building a brick stove to-morrow, we would have such a grating, and follow the plan of "M.," in having the feeding-door well raised. This will furnish the best answer we can give to some half dozen of inquirers, as to whether we think such a stove as "M.'s" would do for a lean-to of from 15 to 25 feet in length, and from 9 to 11 feet in width. No doubt it would in any ordinary circumstances, and under ordinary careful management.

We use the last three words advisedly, because we believe that many systems "cannot answer," because they cannot get a fair trial. We are not now alluding to the appliances in large establishments where the saving of labour may be the chief consideration, and where the turning of a tap or a valve may be nearly all that is required to give what is wanted in any one department, farther than to remark, that the very use of the thing may so blunt the faculty of attention, that for the want of moving the valves there may be dire havoc, either from extra heat or extra cold. We allude chiefly to those numbers of our readers who aim at doing much in little space, and who can better give their attention and a little labour than spend much money, even on the most improved system. We find many of these friends have a hankering after heating by hot water, as if that could do everything for them, and sad are their complaints that they can do nothing with the hot-water establishments, the charges being so enormous. Now, we have not a word to say against our hothouse-building or hothouse-heating establishments, quite the reverse, and in most large jobs that we have seen the workmanship and the expense were everything that was straightforward and honourable. But we do think that our heating men have until lately acted as if they thought it beneath them to do a little job for the enthusiastic amateur, for in many cases the price asked for a little job bore no proportion to that charged for a large one.

Now, however, even from our advertising pages amateurs may know for what they can have small houses heated; and if even that were too much, knowing the price of pipes, they might buy the pipes and form the joints with Portland cement, which will do admirably if not in direct contact with the fire. What we wish to do however, is to state the simple fact, that hot water will not do everything. Here we have a lamentation, "That for years I kept my plants nicely with an old flue; I had hot water last year and now all my plants are gone, the frost has got in." The truth is, the worthy man who helped at the furnace required experience to find out that when the fire went out, the pipes were not such a lasting reservoir of heat as the old flue.

Then as to the brick stove in a small house: its efficacy on such a morning as Thursday is not to be tested so much by the frost getting in as by the management given to it. But for the snow the frost that morning would have been likely to have produced havoc under glass, as well as in the open air. Though it snowed the whole of Wednesday, and, therefore, the atmosphere was cold, it was late at night before the thermometer fell to near the freezing-point. In such circumstances prudence would say, Put at least one sharp fire in your stove. But supposing that on looking out between 10 and 11 P.M., after we had put our slippers on, a combination of laziness and security from frost, owing to the hazy atmosphere, and the snow still falling, determined us not to trouble ourselves with the stove for that night, would we have any right to blame the inefficiency of the stove, because the plants on the front shelves had the earth about them pretty well as hard as cannon-balls, or if even the plants on the back stage had been in the same state but for the friendly covering of snow on the glass? We have already heard of instances of damage done where the friendly snow had been blown off the glass. We have heard of instances where the plants were frosted, where nothing was done until six or seven in the morning, and other instances where no fire was made at night, but where, there being some anxiety, there was a look out between four and five in the morning, and a fire put on immediately prevented all harm. Where such extreme watchfulness is too irksome, it is prudent to use a shovelful of coke or cinders, if not absolutely required at the time. A little fire will cause a circulation of air in the house, and make all comfortable, and will generally keep out all such sudden frosts as occurred on Thursday morning. Now, the simple principle we wish to convey is, that no system however good will make up for want of watchfulness and care, and these given, it need be said of no simple system, it cannot answer, unless a great deal too much is expected from it.

The seasonableness of these remarks must be the excuse for thus hurriedly making them here. We are just reminded of one great advantage we have not alluded to, as respects heating small greenhouses by means of a flue beneath the floor, the top of the flue forming part of the floor. A gentleman told us last winter that his flue is 5½ inches wide inside measure, covered first with thin tiles, and the joints crossed with brick on bed, and the floor thus formed of such bricks. He thought but little of no means of heating being observable; but he looked upon it as a luxury to walk round his house in cold muggy weather in winter and smoke his cigar, with the nice dry warm bricks beneath his feet, and the bricks were nice and comfortable some 15 inches from the cover of the flue.

ORNAMENTAL GARDENING.

Here, except in-door work, potting Fuchsias, Gloxinias, &c., we have done little. Care must be taken to have the soil in good order, and to let the plants have no check after potting. The weather being uncomfortable for out-door work, tender annuals have been sown, and lots of temporary clay pots for bedding stuff have been made, and numbers of Geraniums taken from boxes and planted separately in pieces of fibry turf 3½ inches square, with a large hole scooped out of the centre.—R. F.

TRADE CATALOGUES RECEIVED.

Bruce & Co., 52, King Street, Hamilton, Canada West. —*Descriptive Catalogue of Seeds for the Farm, Kitchen Garden, and Flower Garden, &c.*

Charles Turner, Royal Nurseries, Slough, and Salt Hill.—*General Spring Catalogue.*

John Salter, Versailles Nursery, William Street, Hammer-smith.—*Descriptive Catalogue of Chrysanthemums, Dahlias, Paeonies, Phloxes, &c.*

John Morse, Nurseries, Dursley, Gloucestershire.—*Catalogue of Cuttings of Dahlias, Chrysanthemums, Pelargoniums, Greenhouse and Store Plants, &c.*

COVENT GARDEN MARKET.—MARCH 12.

The supply of vegetables in season continues good; but Cornish Broccoli comes in less freely than in past weeks. Hothouse Grapes are sufficient for the demand, which has been brisk in the course of the week. Some very good Pines are now to be had. Apples and Pears consist of the same kinds as reported last week. Cut flowers are more plentiful, and chiefly consist of Orchids, Camellias, Roses, Pelargoniums, Cinerarias, Azaleas, Hyacinths, Tulips, Narcissus, and Violets.

FRUIT.

	s.	d.	s.	d.		s.	d.	s.	d.
Apples.....	1	0	4	0	Mulberries.....	quart	0	0	0
Apricots.....	doz.	0	0	0	Nectarines.....	doz.	0	0	0
Figs.....	doz.	0	0	0	Oranges.....	100	4	0	10
Filberts & Nuts 100 lbs.	20	0	0	0	Peaches.....	doz.	0	0	0
Grapes, Hothouse.....	lb.	20	0	30	Pears.....	bush.	8	0	12
Foreign.....		1	6	2	dessert.....	1/2	6	0	10
Muscats.....		0	0	0	Pine Apples.....	lb.	6	0	10
Lemons.....	100	4	0	10	Pomegranates.....	each	0	0	0
Melons.....	each	0	0	0	Walnuts.....	bush.	14	0	20

VEGETABLES.

	s.	d.	s.	d.		s.	d.	s.	d.	
Asparagus.....	bundle	8	0	14	0	Leeks.....	bunch	0	4	0
Benns, Broad.....	bush.	0	0	0	Lettuce.....	doz.	1	0	2	
Kidney.....	100	2	0	3	Mushrooms.....	potble	1	0	2	
Beet, Red.....	doz.	1	0	6	Must. & Cress, punnet	0	2	0	4	
Broccoli.....	doz.	0	7	2	Onions.....	bushel	3	6	0	
Brussels Sprouts 1/2 sieve	2	0	3	6	pickling.....	quart	0	6	0	
Cabbage.....	doz.	0	0	0	Parsley.....	bunch	0	4	0	
Capsicums.....	100	0	0	0	Parsnips.....	doz.	0	9	1	
Carrots.....	bunch	0	6	0	Peas.....	bush.	0	0	0	
Cauliflower.....	doz.	4	0	8	Potatoes.....	sack	6	0	9	
Celery.....	bundle	1	6	2	Radiishes doz. bunches	0	0	0	0	
Cucumbers.....	each	2	0	5	Rhubarb.....	bundle	1	0	6	
Endive.....	score	1	3	2	Savoys.....	doz.	2	0	3	
Fennel.....	bunch	0	3	0	Sea-kale.....	basket	1	6	2	
Garlic and Shallots, lb.	0	8	0	0	Spinach.....	sieve	2	6	4	
Herbs.....	bunch	0	3	0	Tomatoes.....	1/2 sieve	0	0	0	
Horseradish.....	bundle	1	6	4	Turnips.....	bunch	0	4	0	

TO CORRESPONDENTS.

** We request that no one will write privately to the departmental writers of the "Journal of Horticulture, Cottage Gardener, and Country Gentleman." By so doing they are subjected to unjustifiable trouble and expense. All communications should therefore be addressed solely to *The Editors of the Journal of Horticulture, &c.*, 162, Fleet Street, London, E.C.

We also request that correspondents will not mix up on the same sheet questions relating to Gardening and those on Poultry and Bee subjects, if they expect to get them answered promptly and conveniently, but write them on separate communications. Also never to send more than two or three questions at once.

N.B.—Many questions must remain unanswered until next week.

ENGRAVINGS (*W. M. B.*).—If you require the portrait of any particular fruit, flower, or vegetable, you must employ an artist to draw it, and an engraver to engrave it afterwards. If you send us a list of any you require we can tell you whether they can be purchased.

FOUNTAINS.—*C. H.* wishes to know where the table-fountains mentioned in Vol. XV., page 372 can be obtained.

MUSSETT'S HOT-WATER APPARATUS (*A Constant Subscriber*).—We have no information upon the subject except the following:—"I have 'Mussett's Portable Hot-water Apparatus' at work in a span-roofed house 10 by 20 feet, and for efficiency and economy nothing can be better. The house is at present filled with early-flowering plants; but I intend shortly to start Cucumbers, for the production of which I shall have no other artificial heat but that which dung and Mussett's Apparatus will give."—*J. Waters, Gardener, 2, Somerset Terrace, Wandsworth.*

BEGONIA LEAVES CRACKING (*Mallouin*).—The plants are kept very much too warm at this season: 50° to 55° is quite hot enough in winter even to have the foliage in fair condition. We think your plants are suffering from want of rest. They should be rested for at least three months at some season of the year, according as they are wanted to bloom, or their foliage to be in fine condition. This is effected by withholding water, and keeping them in a lower temperature and drier atmosphere. The cause of the leaves cracking is, we believe, an atmosphere too dry at one time and too moist at another. They are too dry at one time to properly form their leaves, and then gorged with nutriment, which causes the leaves to burst because the tissues are too small to contain the matter. The atmosphere should be constantly moist, and water kept off the foliage.

RIVINA HUMILIS CULTURE (*A Constant Reader*).—It is an evergreen under-shrub from the West Indies, and not spelt *Roscume*. The flowers are white, appearing at almost all periods of the year, and are succeeded by long racemes of bright red berries, and this renders it very useful for dinner-table decoration, especially as it can be grown in small pots. It is most readily increased by sowing the seed in spring in a stove on a gentle bottom heat. The seedlings are potted-off into small pots when large enough, and grown on in the stove, keeping them near the glass, so as to be sturdy. As the pots fill with roots they are potted into larger, an 18 or seven-inch pot being a convenient size to flower and fruit a specimen in. They require a warm greenhouse to winter safely, and should then be kept rather dry at the root. In spring they will require potting, shaking-off the old soil and reducing the ball considerably. Of course they must be potted into pots a size smaller. By May the pots will be full of roots, and the plants grown considerably, when they are potted in their fruiting-pots. After disrooting, it would materially assist root-action if the pots were plunged in a mild hotbed. The plants need abundant light and air, and the heat of a stove to have them fine. They do well, however, in summer in a vinery. A compost of turfy light loam three-fourths, leaf mould one-fourth, with a free admixture of sharp sand, suits them well. If standards are desired, they are easily obtained by rubbing-off the side shoots to the required height, and then stopping the leader to induce side shoots at the point desired, and stopping again until the head is formed, but not later than June if the plant is intended to become covered with its ornamental fruit in the autumn. We have them on eighteen-inch stems, with heads more than a foot through, in six-inch pots, and when clustered with their pretty drooping racemes of red berries they form nice ornaments for the dinner-table or decoration generally.

GARDEN PLANS (*A. X. A.*).—We have repeatedly stated that we never either furnish plans or plant them. It is impossible to do so without knowing the place. All that we undertake is to criticise the plans and planting submitted to us.

ONIONS FAILING (*J. W.*).—Dress the ground heavily with well decomposed manure and charred vegetable refuse. A dressing of rich heavy loam would materially improve your sandy soil for Onions. Sprinkle soot on the beds before sowing the seed, and rake it in with the seed. A dressing of lime would also be of service. When the Onions are ready for thinning, sprinkle dry soot over them, taking advantage of a dewy morning when they will be damp, and the soot will adhere to them. If you water the beds, apply guano water at the rate of 2ozs. to a gallon of water. We think you will then succeed with Onions on your soil—one of the worst for them.

NEAPOLITAN VIOLETS (*C. H.*).—They require air at all times, in fact, can never have too much. They require air when flowering the same as at any other time. Your soil is probably too rich, and that would give fine flowers, but not so profusely as if it had been less rich. We think your plants will have more blooms yet.

POINSETTIA PULCHERRIMA STOPPING (*B. B.*).—If you have a good heat you may stop the plants twice, but for blooming finely they should not be stopped after August.

SHEEP-DUNG (*W. H. Vevers*).—That taken from the intestines by butchers will answer quite well for making liquid manure and other gardening purposes. You can have the book you name free by post from our office if you enclose 3s. 10d. in postage stamps.

COVENT GARDEN MARKET (*H. P. R. K.*).—We cannot furnish the name you ask for.

REMOVING LARGE HOLLIES (*A. B.*).—The early part of June is the best time for removing them, and if moved with a good ball of earth about the roots they will scarcely show any symptoms of having been disturbed.

LONG CUCUMBERS (*A Brotherton Subscriber*).—Tell any seedsman who advertises in our columns what you require, and he will supply you.

HYACINTHS BLOOMED IN GLASSES (*B. B.*).—No treatment you can adopt will enable the bulbs to produce bloom next year. The most successful treatment is to cut down the flower-stem, and to plant the bulbs in pots, washing the soil in among the roots without injuring them, and keeping the soil well watered until the leaves begin to turn yellow. Next spring the bulbs may be planted in a sheltered border, and after another year they will probably produce bloom.

NAMES OF INSECTS.—(*B. Croydon*).—The grubs which attack your Ferns in pots immediately below the surface of the soil, are the larvae of one of the weevils, most probably *Othiorhynchus vastator*. The "fly" is a click-beetle, *Elster striatus*, the parent of the wireworm. We would recommend the plants to be repotted in soil carefully riddled through a sieve, and the old soil burnt.—*W.*

WATER-CRESS CULTURE (*Yorkshire*).—We know nothing about "Real Erfurt Water-cress," and never saw any superior to the English species of our brooks. No advantage arises from growing it from seed. The following is the mode of cultivating it:—The trenches in which they are grown are so prepared, that, as nearly as possible, a regular depth of 3 or 4 inches can be kept up. These trenches are 3 yards broad, and 87 yards long, and whenever one is to be planted the bottom is made quite firm and slightly sloping, so that the water which flows in at one end may run out at the other. If the bottom of the trench is not sufficiently moist, a small body of water is allowed to enter to soften it. The cresses are then divided into small sets or cuttings, with roots attached to them; and these are placed at the distance of 3 or 4 inches from each other. At the end of five or six days a slight dressing of well-decomposed cowdung is spread over all the plants, and this is pressed down by means of a heavy board, to which a long handle is obliquely fixed. The water is then raised to the depth of 2 or 3 inches, and never higher. Each trench is thus replanted annually, and furnishes twelve crops during the season. In the summer the cresses are gathered every fifteen or twenty days, but less frequently during winter; care is taken that at each gathering at least a third part of the bed is left untouched, so that neither the roots may be exhausted, nor the succeeding gathering delayed. After every cutting, a little decayed cowdung, in the proportion of two large barrowful to each trench, is spread over the naked plants, and this is beaten down by means of the rammer above mentioned. After the Water-cresses have been thus treated for a twelvemonth, the manure forms a tolerably thick layer at the bottom of the trench, and tends to raise its level. To restore it to its original level, all the refuse should be thrown out upon the borders which separate the trenches from each other. These borders may be planted with Artichokes, Cabbages, or Cauliflowers.

BOILER AND FLUE (W. Brooke).—You may do as you propose with the boiler, but it will be as troublesome as continuing the flue in the way we indicated, or it might go a part of the way and return to the same chimney as now; but we think you must have a deal of heat as it is. Do away with the damper in your flue entirely under the circumstances, or use it very carefully. Get a door for your ashpit by all means, and from an opening in that regulate your draught. See "Doings of the Last Week," pp. 199, 200.

COW-HOUSE AND VINERY COMBINED (F. C.).—We never advocated this combination, for the dust and other inconveniences we felt sure would frustrate the plan. Mr. Lawson, of Tiryddai, near Llandillo, tried the plan, but he came to grief and emigrated. We recommend you, as glass is now so cheap, to have a vinery separate from your cow-house. We shall be glad to see the photographs you mention. Are not the fowls White Cochins? We can show you a coloured drawing of these.

HEATING BY A CYLINDER BOILER (B. D.).—Such cylinder boilers are best when fed from the top; if not, the heat should go round the outside as well as inside. In either case the boiler should be from 3 to 6 feet below the pipes to be heated. We presume your pipes run at once on the level from the boiler to a cistern as large as the boiler at the other end. We can easily conceive the waste of fuel from the heat at once going up the chimney. Before making the proposed alterations, just lessen the opening at the top of the boiler by two-thirds, and put a close-fitting damper in the chimney, a couple of feet or so from the boiler, and, as soon as the fire is fairly burning, shut-in the damper, so as to leave about half an inch finally for draught. You will find this will cool the chimney and send the heat back on the boiler. Mend the ashpit-door also. See "Doings of the Last Week" a fortnight ago.

HEATING A PLANT-HOUSE (Lone Peak).—A middle-sized conical or saddle-back boiler will suit you. If otherwise suitable, it will be best to fix it at the end of the house, next the proposed vinery. We would have eight small ventilators at the apex of the roof. For eight sashes on each side you might have strong sash-bars. Use 21 oz. sheet, and in squares 13 inches long, by 9 or 11 in width, according as you had five or four rows of glass in a sash. For economy we would prefer a fixed roof, with a moveable sash 18 inches wide along the top, and ventilators also at the sides. A good arrangement for such a house would be $\frac{3}{4}$ feet beds all round, a path $\frac{2}{3}$ feet, and a bed or stage in centre 8 feet. To keep such a house secure would require two four-inch pipes all round. To force much, would require, in addition, two or three more down the middle. To give hotbed treatment you could either have the front or centre stages heated by pipes in a chamber beneath, and if confined in a chamber, with slides to let out the top heat.

DEFICIENT BOTTOM HEAT (T. E. Wallace).—As Lord Dandreaire would say, your case is just one of those that no fellow can understand. A few small openings next the pathway, near the bottom of the chamber, might be tried. If you can make the chamber so hot, and neither the bed nor the enclosed atmosphere can be made hot, there must be a means for the heat getting off somewhere. In such circumstances as you mention, and the pipes hot enough, with or without a chamber we have never found any difficulty. Try a close hand-light over your bed. We use a good deal for propagating, small boxes of wood, 6 inches deep in front, 9 inches deep at back, 18 inches square, and the sides sloped like those of a commoo frame. A slight frame holds a single square of glass for covering it, and when moisture condenses against its lower side we just reverse the glass top. Some of these little hot-roomless boxes over your bed would be useful, if you wished for more than 75° to 80° of bottom heat. We think there must be some little thing that has escaped notice. We would as soon have the slates solid and close as not, just as another correspondent finds the advantage of making slate close and firm over a tank, with the water some inches from it.

EPACRIS NOT FLOWERING (Wigan).—We think that the buds of the Epacris do not open owing to the plant's rude health of which you speak, and the wood not being ripened enough in the autumn. You can have the Number you mention by sending four postage-stamps; also covers for Vols. 15, 16, 17, 18, 19, 20, 21, 22, 23, 24, 25, 26, 27, 28, 29, 30, 31, 32, 33, 34, 35, 36, 37, 38, 39, 40, 41, 42, 43, 44, 45, 46, 47, 48, 49, 50, 51, 52, 53, 54, 55, 56, 57, 58, 59, 60, 61, 62, 63, 64, 65, 66, 67, 68, 69, 70, 71, 72, 73, 74, 75, 76, 77, 78, 79, 80, 81, 82, 83, 84, 85, 86, 87, 88, 89, 90, 91, 92, 93, 94, 95, 96, 97, 98, 99, 100. We have no covers to suit two volumes bound together.

RIBBON-BORDER (Idem).—You do not tell us whether your border is to be ridged, slopes one way, or is bordered by grass or gravel. We will suppose that it slopes one way. We should plant it with the flowers you name, as follows, beginning at the back:—Trentham Rose Geranium, Ageratum, Pentstemon, Feverfew and white Verbena, Tom Thumb Geranium, purple Verbena, Flower of the Day Geranium, Lobelia, Gazania. To have your scarlet Verbenas as a row you could mix them with Flower of the Day, or make a tenth row of it. Were the outside front box and gravel, then after Tom Thumb we would place Flower of the Day, with the flowers off, then purple Verbena, Gazania, and Lobelia.

SEEDLING CEROLENDONS (A. M.).—Take cuttings from the half-ripened shoots, and make plants of them, grow these on as you have done the seedlings, and they will most likely flower next year. Grow in rather light poor soil, give all the light possible, and keep them under rather than over-potted. The old plants should be kept cramped in small pots, and be repeatedly disrooted so as to take away most of their vigour. They cannot have too much light and sun in order that the wood may be well ripened.

AZALEAS DONE BLOOMING (Idem).—About a fortnight after blooming they should be repotted, giving but a very small shift—that is, just sufficient to let some fresh compost be put between the ball and the pot. The ball should not be disturbed, only the drainage being removed. Perfect drainage must be provided for in the new pot. Employ a compost formed of sandy brown peat three-fourths, and turfy yellow loam one-fourth, with a free admixture of silver sand. In potting the crown of the plant should be kept rather high. After potting place in a moist and rather shaded pit or house with a minimum temperature of 60°, and a rise by day of from 15° to 25°. They should be well syringed morning and evening until the growth is made, when the plants should have abundant light and air, with less moisture, until the buds are set, when they should be removed to a light, well-ventilated, cold house. In this situation they will need watering when necessary, and a little fire now and then to dry up damp and exclude frost. If you have a vinery just now starting that will be an admirable place for the Azaleas; for when the Grapes are ripening the Azaleas will have set their buds, and that is the time to remove them to a cool, light, well-ventilated greenhouse, where they should be wintered.

SMALL DEEP-BED RHUBARB (C. J. H.).—Either the Tobolek or the Elford (sometimes called Buck's) answers the description. Any nurseryman can supply them.

TROBOLUM (TURNER) NOT FLOWERING (G. P. S.).—We think your plants have been too highly excited by too much heat during the dull winter months, and that with, perhaps, little root-action. We have had plants that grew vigorously in winter, but when the days became longer and the light stronger, the slender shoots began dying off at the joints, and the flower-buds withered without expanding. We have invariably found such plants had but little root, and in some cases none at all. This we think is occasioned by potting the tubers late and growing them in a warm situation afterwards, and without sufficient light and air. The tubers should be potted before the waxy shoots rise from the crowns and be placed near the glass in a rather warm greenhouse, so that they may have all the light practicable, and air on all favourable opportunities. A temperature of from 45° to 50° is quite warm enough for them in winter. Very perfect drainage should be provided, for, should the soil at any time become too moist the roots perish and the flower-buds die, as in your case, especially when watered with cold water instead of that of the same temperature as the house. The soil should be kept dry rather than wet, but it should not be so dry as to cause the plants to turn yellow, nor so moist as to have the appearance of being very wet. In short, let it be healthfully moist.

TRAINING CUCUMBERS AND MELONS (C. P.).—You will need a trellis in your house to train them to. It should be fixed 1 foot from the glass and should cover the whole of the roof. One plant in the centre of each light, not under the rafters like a Vine, is sufficient to cover a tolerably large roof. The leading shoots should be trained up the centre of each light, and be allowed to grow a considerable length before they are stopped—say 3 feet on the sloping part of the roof. This will cause side shoots, and these are to be trained at an angle of 45° from the main stem, and stopped at a joint above the fruit. The shoots should not be left nearer than 1 foot. All which are superfluous are to be removed, and the shoots stopped at a joint beyond each fruit. A wire trellis is the best and most durable; but a wooden trellis will do if it is not made too strong to obstruct light. The fruit will require support, and this is best done by tying a piece of bast round it loosely and fastening the other end to the trellis. We are not acquainted with any small treatise on the subject.

FIGS IN POTS (J. H., Bow).—If the trees have some young shoots with embryo fruit near the bottom, we should certainly cut those shoots 4 feet in length down to 1 ft. 6 in. You must, however, bear in mind that all the shoots cut back will not afford a first crop of fruit. We advise you to shorten some of them considerably, but to leave a number of young shoots to provide for a crop. If you could obtain permission to have them cut down to within a foot or so of the ground, it would be the best plan in the end, for 4 feet of naked stem is worse than useless. In future stop them at the fifth leaf or joint, and be careful not to overcrowd the trees with wood. Keep the trees well syringed on the under side of the leaves, to keep down red spider, except when the fruit is ripening, and give good supplies of water to the roots. They require the lightest, warmest, and most airy situation. For further particulars consult "Hints on Orchard-Houses," by Mr. Pearson.

TRITELIA UNIFLORA (Idem).—This is an elegant little blue-flowering bulb from Buenos Ayres. It is almost, if not quite, hardy, but does well under greenhouse treatment. Keep it well supplied with water whilst flowering, and when the weather becomes warm, in the latter part of May, turn it out, plunging the pot in a dry sunny border. Take the pot up in September, and re-pot the plant, disturbing the ball as little as possible, taking care to secure good drainage. It does well wintered in a greenhouse near the glass. It usually flowers in June, and we should therefore fancy your plant has been kept rather warmer than is requisite. It will flower next year if not made weak by too much heat. We should like to know if any others of the Tritelias are in cultivation at present, especially the North American species.

BLACK HAMBURGH VINE LEAVES RUSTED (An Amateur).—The leaf enclosed appeared injured by some gas as that from fermenting materials. A current of cold air will also produce the same effect, and so will syringing the Vine with water holding lime in solution. There are, in fact, so many causes that will produce the condition apparent in the leaf you enclosed, that we are unable to assign a remedy without further particulars. State your case more fully, and we will gladly assist you.

DISAS (Orchidophilus).—The seven species you are promised from the Cape of Good Hope, unnamed and uncertain, we cannot at your want. We applied to one well versed in bulb-culture, and he replies:—"I never came across the Disas but once, many years ago, and have almost forgotten the particulars. One, I know, was prasinata, cornuta another: I had only two or three. They were little tubers, like those of an English Orchis, and grew rather kindly with slender thread-like leaves. They perished, as far as I recollect, during a long absence from home on my part—the common fate of delicate bulbs and tubers when the cut is away. I doubt if they resemble either in habit or beauty the splendid grandiflora, which shines—

'Velut inter ignes,
Luna minoris.'

Careful cold frame treatment will probably give the best chance. Drawings of some of the species may be found as follows:—D. bracteata, Bot. Reg. vol. iv, 324; D. cornuta, Bot. Mag., vol. lxx., 4091; D. ferruginea, Hooker Icones, plate 3, 214; D. grammifolia, vol. ii, Journal Science and Arts; D. longicorua, De la Marek Encyclop.; D. porrecta, Journal of Science and Arts; D. prasinata, Bot. Reg. 3, 210; D. puchella and scutellifera, spatulata (Bauer), Richard Tentamen, Florae Abyssinicae.—B. T. C.

NAMES OF PLANTS (T. R. Drake).—1, Dierbaum scoparium; 2, Hypnum purum; 3, H. proliferum; 4 and 8, H. praelongum; 5, H. eupressiforme; 6, H. triquetrum; 7, H. loreum; 9, H. rotundatum.

POULTRY, BEE, and HOUSEHOLD CHRONICLE.

MANAGEMENT OF EARLY CHICKENS.

EVEN in North America, where the belligerents seem disposed to realise the tale of the Kilkenny cats (more the pity), there is a pause during the winter. Drilling recruits, casting cannons, making gunpowder, and supplying depôts, fill up the period of inactivity, and enable the contending

hosts to be strong and well-appointed when the spring campaign opens. This is said to be a weary time for the men, the "winter of their discontent," and they long for the risks and excitement of active service. The master mind of the Duke of Wellington was aware of this, and knew that even the security and the comparative ease of the "lines" would pall on the minds of men accustomed to be on the stretch, and a pack of hounds was shipped to Portugal, and the meets advertised as regularly as those of the Quorn. Shows are now over, the winter has been a dreary one; snow, the poultry-breeder's *bête noire*, has covered the ground for days; hens have laid badly; sitters there have been none, and all seemed dark and dreary among the feathered tribes. But there is comfort: Rooks are building; birds are paired; they do not doubt there is a good time coming. Snow is a bitter nuisance while it lasts, but it feeds the springs, and we have been told, and we believe, that it is a powerful agent in renovating tainted ground. Well, then, while we write, the earth has put off her virgin's mantle, and everything is springing up. The surface is fresh, insect life begins to appear, herbage is putting up small blades, days are getting longer, nights shorter, the sun gains strength, and the fowls, crouching no longer in sheltered corners or filling every out-house where the door stood open, spread themselves abroad. The egg-basket will be daily better filled, and some that have persevered in laying, in spite of weather, will give unmistakable signs that they intend to rest, and to take on themselves the pleasures and responsibilities of maternity. Progress is the order of the day.

It is indisputable that new ground is an advantage to chickens: we do not mean by that moving from one farm to another; but it is an advantage to put hens and chickens, if possible, on a spot where none were reared last year. There will be bad weather yet; the wretched east winds and black-thorn winter have to come, and it is well now to settle what is to be done then. An empty barn is invaluable; we have one now full of chickens, and have not lost one. The flooring is hard and dry, covered with dust, dry road sand, and scrapings. Large sods of grass are cut and thrown in daily. If there is sun the chickens are allowed to run out and enjoy it; if there is not, the doors are open, but bars prevent their egress. At night not only is all closed, but the rips in which the hens are with the chickens are closed up. We feed on bread steeped in milk, sometimes on beer, on ground oats slaked with milk, and on boiled suet chopped very fine. They have beer and milk to drink. We have marked out the place where we intend to put them as soon as the weather permits. We always choose a slope, it is always dry, not only superficially but under the surface; the rain runs off, and if the hen scratches down several inches deep it is still dusty. If this can be found under a hedge so much the better; a shelter behind is a good thing. Chickens thrive wonderfully if the rips are put under hayricks, thrust as far back into them as possible; the dust and seeds that cover the ground some inches deep are capital for them. With these helps we look complacently even on easterly winds and morning frosts, on March winds and April showers. It is our drilling time; we look on our growing chickens, and "hail in our hearts the triumphs yet to come" when we gaze at one particular brood that came into being January 14th. There are few as early, and in most yards all the hens will be broody at once; and for that cause the season of dulness, so far as shows are concerned, will not be one of inactivity.

CONDITION, &c., IN GAME FOWLS.

As we have heard so much lately about Game, I think it not out of place to seek for information relative to the condition and tightness of feather that these birds are generally shown in. Now, I am led to believe, that condition is of the utmost importance, for if a bird be ever so good in points, yet faulty in this one feature, he is at once passed over by the judge. First, then, I would ask, What is meant by the term "condition," &c.? and, secondly, In any special manner of feeding, and kind of food is requisite for accomplishing this? This makes the Game classes most difficult to win in, as there are many exhibitors, who have been at it all their days and perfectly well understand the mystery, always competing with amateurs, and who carry off prizes solely from this

cause. Perhaps some old hand will be kind enough to put us amateurs up to the mystery, or at any rate start the subject, as I am sure it ought to receive as much discussion and attention as the Birmingham matters.—AMATEUR.

TRIMMING GAME FOWLS.

This question having been raised, I take the opportunity of saying a few words. That it is perfectly right and legitimate to trim the head of a Game cock for exhibition purposes—that is, to pull or shave all the feathers or hairs off the top of the head, under the jaws, throat, &c.—no one can attempt to deny; but anything beyond this, such as clipping or pulling the hackle, a very common practice, cannot but be denounced by every right-feeling or honest exhibitor. With regard to head-trimming, "Y. B. A. Z." will, I have no doubt, grant that it is in every way an immense improvement to the appearance of the bird; it shows his long snake-like head and his eyes to advantage, and gives a general appearance of "pluck." The long-flowing hackle has now quite given place to one of a moderate length, in fact, the thinner and shorter the better, as it shows the shoulder-points and the width across the back much more to advantage; and this being the fashion we see cause for the pulling system, as before mentioned, by the dishonest exhibitors, who are, I am sorry to see, much on the increase.

I was glad to find an instance of this dishonesty detected at the last Ulverston Show. It was in a pen of Black Game from Birmingham. The cock's hackle had been a little overdone, and, as my informant described, had been literally cut off by the handful; the pen was, as a matter of course, disqualified.—WESTMORLAND.

RELATIVE ENTRIES.

SEVERAL communications on the subject of the comparative entries of the various breeds of poultry have appeared in this Journal of late, and as that subject seems to be creating some attention I will offer a few remarks.

I would suggest that fashion has, undoubtedly, a great influence on the relative entries, much more, I think, than the value either of the breed or the prize offered. Each variety has its time; and if a sort, as for instance, Malays, or White-crested Blacks, is for the present out of fashion, I do not think that it should be excluded on that account. Spanish and Dorkings are at this time, perhaps, the most fashionable, and I agree with "Y. B. A. Z." that Dorkings, although receiving large prizes in competition, do not obtain their fair share." Why, I ask, should Dorkings be confined to one variety, while Game have four or more acknowledged in most shows? Surely it would only be fair to set apart separate classes for White, Silver-Grey, and Cuckoo Dorkings. The class for Coloured might still be retained for those competitors who think size all-important. Four varieties of Dorkings are no less than they deserve, and are no more than are awarded to Game, Shanghai, &c.

As to those aristocrats, the Spanish, why should they be restricted to one sable hue? Why should not Blue and White Spanish each have a class? I consider them quite as eligible as the four varieties of the rosy-combed breeds commonly called Hamburgs, not that I would curtail them, as I think them quite entitled to their classes.

Shanghais, I think, should always keep their four classes—namely, Partridge Brown, Buffs, Grey or Brahmas, and Whites. I consider that the so-called Brahmas have now become entitled to a separate class; but it would be too much to give them more, for they are only a variety of Shanghai, and however fashionable they may become, it would be unfair to other breeds to divide them again on such a score. The Partridge and Grouse, or Buff and Silver Cinnamon Shanghais would demand to be separated. Indeed, it would be far more just to give separate classes to the York and Lancaster Roses, *alias* Pheasants and Moonies, than to divide light and grey Shanghais.

Black Hamburgs are making for themselves a place, but ought not they to take rank as a fourth variety of Spanish? They certainly look like Rose-combed Spanish. The La Flèche might join them as Cupped-combed Spanish.

As to Crève Cœurs, they are the same breed as our White-crested Black fowls commonly called Black Polands, only with this difference—our crested breeds are in few hands, and their owners have bred them of marvellous beauty; still they have suffered rather in constitution and fertility, while the French breeders have looked to hardihood and fecundity, without taking notice of the fancy points. I have no doubt if the good qualities of these two extremes of the same breed could be combined the result would soon be a very fashionable and popular breed, and there would no longer be any complaint of empty classes.

But to return to the Dorking. May I ask, Why is the Dorking class to be made the repository of a medley of shape and colour? If justice is to be done to a good breed give them their due, and separate classes for White, Grey, Cuckoo, and other coloured Dorkings; not until then will the Dorkings obtain their right.

The same holds good of Spanish; let there be separate classes for Black, Blue, and White. Fashion is ever fickle, and, doubtless, some day the good qualities of the Malay and crested breeds will again find favour with that changeable goddess. Do not, therefore, blot out their places, but meet even justice to all. Our poultry shows should not descend to petty partialities.—B. P. BRENT.

OBTAINING HONEY FROM THE COMB.

WILL you inform me of an easier method of abstracting honey from the combs than that laid down by Huish? In his directions there are so many vessels used that I conceive there must also be a great waste of the honey, and having a friend who took a glass off last August, he finds a difficulty in taking the honey from the combs.

I would also ask, if it is too early for me to remove my hives from their winter quarters, as I am anxious to cleanse the floor-boards.—T. S.

[The mode of draining honey described by Huish is practicable only in the case of combs newly taken from the hive, and in which the honey retains its fluidity. A small quantity may be manipulated in this manner by the aid of a single sieve and an earthen pan. In the case of a super taken off last August every cell containing either pollen or brood (if any), should first be carefully removed, and the combs then put into a covered jar which must be stood in a saucepan or boiler of water and placed on the fire. This should boil just long enough to liquify both honey and wax, and when this has been accomplished the jar and its contents should be placed on one side to cool. When perfectly cold the wax may be removed in the form of a thin cake from the top of the honey, which will be found exceedingly pure and perfectly liquid underneath.

It is quite time to remove your bees from their winter quarters and give them their liberty if confined.]

PROPOSED EXPERIMENT WITH CHILLED BROOD.

PERMIT me to remind our Hampshire friend that Mr. J. P. Edwards related, in page 382 of the last Volume, an occurrence almost identical with his suggested experiment on chilled brood. Most experimental apiarists could, doubtless, narrate similar accidents and their results, and thus supply the required information. In particular I remember my esteemed friend, "B. & W.," relating to me an instance in which all the brood of a hive perished from putting the first swarm in the old stock's place, but I do not know what became of the combs. One thing is at any rate certain, that this misfortune did not produce foul brood in his apiary.—A DEVONSHIRE BEE-KEEPER.

THE LAST BEE-SEASON IN SHROPSHIRE.

THE following observations on the season of 1863 may, perhaps, interest some of your apiarian readers.

The early part of the year from the commencement of February was remarkably mild and dry, and bees where

they did not run short of provisions were in a forward condition. During the month of May a moderate quantity of honey was collected from the blossoms of various kinds of trees; but in the beginning of June the prospects of the honey harvest appeared very gloomy, as the pastures and clover were almost burnt up by the long-continued drought. Fortunately, about the middle of the month heavy rain set in and the ground was thoroughly saturated. The Dutch clover immediately sprang up and blossomed most profusely, affording first-rate pasturage until near the end of July, and rendering 1863 one of the best honey seasons on record.

The weather subsequently was, on the whole, unfavourable, and I found my hives lost at least from 5 to 6 lbs. each between the end of July and the middle of September. Those sent to the moors pretty well held their ground, some gaining 1 lb.

A few words on honeydew may, perhaps, not be out of place. Your esteemed correspondent, "B. & W.," seems to doubt if bees are much benefited by this secretion. I have frequently, indeed generally, found my bees busy about the common laurel at the end of spring, and have seen them collecting honeydew from little spots on the under side of the leaves. I have also on several occasions observed them busy upon beech trees when affected with honeydew.

Again: last summer, towards the middle of July, I observed that the bees were unusually active, but on examining the clover I could only see very few engaged upon it, and wondered what made the bees so busy. In the evening, walking out, on passing an oak tree I heard a loud humming, and looking up saw that the tree was covered with honeydew; and although I cannot say that I actually saw the bees at work upon the oak leaves, I consider that their absence from the clover, taken in conjunction with the humming in the oaks and the great activity of the bees, is strong negative evidence upon the subject.

In August, 1856, my bees were very busy until after the middle of the month, the oak trees at the same time abounding with honeydew, and this is fully a month later than the usual honey season in this district.

Once more: Golding affirms that he has seen a field of beans covered with bees before a single blossom had expanded, collecting honey from small spots on the leaves, and I have noticed them in like manner gathering honey from spots on the stems and leaves of vetches, leaving the blossoms untouched.—J. E. B.

RABBITS EATING RHODODENDRONS.

CAN you or any of your readers inform me how far, in their experience, the statement of "A NORTHERN SUBSCRIBER," in your Journal of the 1st inst. holds good—viz., that while rabbits will not, in the greatest scarcity of food, touch the Rhododendron ponticum, they will eat freely the hybrid and finer sorts? I am about to plant a quantity of hybrids, and an answer to my query is of some importance to me.—CLERICUS.

OUR LETTER BOX.

DISAPPOINTMENTS FROM BOUGHT EGGS (*Infelix*).—You have been very unfortunate, but as you do not tell us the variety, nor the seller, nor any particulars of the number of eggs placed under each hen, nor indeed any guiding particulars, it is quite impossible for us to form an opinion as to the cause of failure.

SPANGLED LIZARD CANARIES (*R. Goldfinch*).—Mr. Judd, Bird Fancier, near the Elephant and Castle, Newington Causeway, would give you, probably, the best information.

STRAYING POULTRY (*Cochin*).—Since the Judges have determined that a dog may be shot to save the hire he is courting, we see no reason why you might not shoot the poultry that invade your garden, fields, and hen-yard. The better way would be to give notice to the owners of the cocks which injure your crops and cross-breed with your poultry, that you will shoot them; after which, if the birds still trespass, shoot them and bury them. There is no need to wait for a month after notice given.

GOLDEN-SPANGLED HAMBURGHS (*H. W. D.*).—As the cock has a black breast, any change in the colour of his progeny must be from the hen. You should then choose his mates with very distinct markings and lightish breasts. There is a great difference in the breast and belly feathers of hens. Some are nearly black—do not choose them. Our impression is you will breed both black and spangled from him.

SHEEP.—A Subscriber, *Maindee*, wishes that "THE DOCTOR'S BOY" would write on the management of sheep as he did on the management of cows and pigs.

WEEKLY CALENDAR.

Day of M'nth	Day of Week.	MARCH 22-23, 1864.	Average Temperature near London.			Rain in last 37 years.	Sun Rises.	Sun Sets.	Moon Rises.	Moon Sets.	Moon's Age.	Clock before Sun.	Day of Year.
			Day.	Night.	Mean.	Days.	m. h.	m. h.	m. h.	m. h.	m. s.		
22	TU	Elm flowers.	50.4	34.5	42.5	15	0 at 6	14 at 6	42 5	10 5	14	6 54	82
23	W	Creeping Crowfoot flowers.	50.5	33.8	42.1	16	57 5	16 6	49 6	32 5	0	6 35	83
24	TH	Red Currant foliates.	50.8	32.2	41.5	13	55 5	18 6	55 7	52 5	16	6 17	84
25	F	LADY DAY. GOOD FRIDAY.	50.6	32.9	41.8	13	53 5	19 6	5 9	16 6	17	5 58	85
26	S	Periwinkle flowers.	51.9	32.5	42.2	14	50 5	21 6	13 10	45 6	18	5 39	86
27	SUN	EASTER SUNDAY.	54.0	34.6	44.3	13	48 5	23 6	18 11	19 7	19	5 21	87
28	M	EASTER MONDAY.	53.2	34.1	43.6	13	46 5	25 6	morn.	0 8	20	5 2	88

From observations taken near London during the last thirty-seven years, the average day temperature of the week is 51.6°, and its night temperature 33.5°. The greatest heat was 75°, on the 27th, 1850; and the lowest cold, 14°, on the 25th, 1850. The greatest fall of rain was 0.68 inch.

HARDY ANNUALS.



As a general rule these require to be sown where they are intended to bloom. Very early sowing should be avoided, for nothing is gained by doing so, but, on the contrary, a very indifferent display will be the result. Early in spring the ground is cold and often wet, and these conditions combined

sometimes destroy vitality, and under such circumstances the germination of the seeds committed to the soil is

always slow. It may happen that mild fine weather prevails in spring; and when the gardener takes advantage of this to sow the various kinds of hardy annuals early, the seeds of some come up in a few days, but others remain in the ground a long time, and in many cases do not germinate at all. All seeds require a certain degree of heat to germinate; below that point they will not do so, but when placed in contact with moisture the same chemical process takes place within the seed, from the absorption of water, as if the seed were being transformed into a plant. When the chemical elements of a seed are thus changed, without growth or germination taking place, its vitality is gone: hence the importance of keeping seeds dry whilst in a temperature unsuited to their germination. There is, probably, no subject on which we have so little information as the temperature necessary for the healthy development of different kinds of seeds. I think it is well worthy of the attention of horticulturists, especially those having time to devote to such matters, and the results of experiments would be highly interesting and useful.

The middle of April I have found to be the best time for sowing hardy annuals. The temperature of the ground is then raised considerably by the sun's rays, and there is less probability of the soil being saturated with moisture, or the seeds receiving a check through snow, frosty weather, or cold drenching rains. From the middle of April to the first week in May I consider the most advisable time of sowing, and if possible a moist period just succeeding dry weather should be chosen. When the air is dry seeds of all kinds do not germinate so well as in moist cloudy weather. If it were possible to know exactly when rain would fall after dry weather it would be well to sow the day before; for it is all the better to put in seeds when the ground can be worked without making it into mud. It is a well-known fact that seeds of all kinds germinate most rapidly in the autumn. The soil is then firm and close, holding water near the surface; the earth is also warmer, the air moister, and dews heavier, conditions every way suitable for germination; then, though the seeds may not be buried in the earth, the decaying leaves of the parents afford the darkness necessary for germination.

New seeds of all kinds are preferable to old for cer-

tainty of growth, for producing a stronger plant, and a larger amount of flower. New seeds are inferior to old for an early produce, and the certainty of obtaining seed and fruit from some exotics for which our climate is not sufficiently hot nor the summer long enough. New seed of all hardy annuals is decidedly preferable to old. It germinates sooner and with greater certainty; the plants are stronger, will bear more hardships, and produce finer flowers and in greater profusion.

The situation for all flowering plants should be open, but sheltered if possible from the north, west, and east winds. Borders if open to the north are cold, if to the west they are liable to strong currents of air or wind, and if to the east they expose the plants to the cold breezes that come from that quarter, in consequence of which the plants are very often stunted in growth, and flower prematurely. Gardens should be sheltered from all points except the south, and this can be done without blocking up views if a due regard is paid to the distribution of the trees and shrubs intended as shelter.

The next point to be attended to in the cultivation of annuals is to have the soil in a condition suitable for the germination of seeds, and the healthy development of the plants. How often do we see the borders only dug a few days before the seeds are sown, without any attention being paid to having the soil well pulverised, so that it will in the spring fall like so much flour after a shower of rain? The soil where annuals are intended to be grown should be dug deeply in the autumn, and left rather rough, so that air and frost may readily act upon it. A dressing of leaf mould dug in in the autumn is very beneficial. If the ground is at all heavy, it will be much improved by forking it over on dry frosty mornings. This may be considered troublesome, but it is only what all plants require in order to grow well, and annuals are either worth growing well or not at all. Just forking over borders in front of shrubs, and sowing annuals there without any further attention, is one of the best means of making them poor. They may grow and do well whilst young, and their wants small; but when these increase the soil is too firm for the roots to penetrate to any depth, or if they do the ground is already occupied by the roots of the shrubs, and very little food indeed remains for the annuals. I have heard them termed weeds, which they undoubtedly are as now for the most part cultivated; but bestow upon them the care necessary for their proper development, and they will in their season be found inferior to no bedding plant receiving double the amount of attention and expenditure.

In sowing, the surface should be well pulverised with the rake, and a little of the soil drawn to two points, so as to leave a space of the size required for the patch, which should not be more than 1 foot nor less than 6 inches across, and the patches should not be closer together than 1 foot in any direction. The seeds are best sown thinly in the centre of the patch, and more thickly round the edges. It is decidedly of advantage to sow the seed rather thickly, for birds are fond of

some, snails prey on the young leaves of others, and mis-haps of various kinds may thin them considerably. Whilst providing for a good patch it is advisable not to sow too thickly, though it is better to have to thin than resow or transplant. When sown very thickly it is hardly possible to thin the patches without injuring the remaining plants. When the seeds are sown draw the earth over them, covering them no deeper than their own diameter. It is better to cover thinly than deeply, for annuals do not require to be kept or placed in so much darkness as farinaceous seeds. It is sufficient if the seeds are just covered with soil, or kept in the dark, so that the chemical changes which take place in germination may go on. If the ground is dry, it is a good plan to water the patches, and cover them with inverted flower-pots, so as to secure uniform moisture in the soil, and obviate the necessity of repeated waterings. The sun's rays, consequently, will not bake or dry up the surface, and the pot will absorb heat by day, and radiate it at night, so that the seeds will not be roasted at one time, and frozen at the other. When the plants appear the pots should be removed, but they may be replaced with advantage on frosty nights, taking care to remove them by the time the soil is thawed.

Where the soil is of a tenacious nature, and at all rough at the time of sowing, it is a good practice to cover the seeds lightly with some light soil, which should be fine, or made so by sifting. Care should be taken in open soils to well pulverise them before sowing the seeds, for it not unfrequently happens that the seeds run down the openings, and are lost for that year at least, by being buried too deeply in the soil. Where any danger of this is apprehended, a small portion of sifted mould should be placed on the soil for the seed to be sown on. The seeds of some annuals are so small that it is scarcely possible to cover them too thinly, but none will take harm if covered to no greater depth than its own diameter.

When the seedlings are fairly up a ring of dry soot should be placed round each patch to prevent the nocturnal visits of slugs, which will in a single night devour a whole patch. If these pests are at all troublesome some fresh Cabbage leaves, laid at night near their haunts, and examined in the morning, will collect a great many; and if they be brushed off the leaf into a flower-pot, and a little salt sprinkled over them, they will not trouble the cultivator any more. This, repeated for several nights, will soon rid a garden of slugs. Where ducks are kept the slugs unsalted form one of their best-relished meals. Should the weather be dry the annuals should be watered, and the ground between the patches frequently stirred with a hoe; but a rake cannot be too little used, for the surface should never be made fine, so as to throw off rain into the hollows. On the contrary, it should give free access to air and moisture. The aim of the cultivator should be the well-being of his plants, and not that neatness which is secured at the expense of their healthy growth. The longer the soil is kept open the more satisfactory will be the results. When the plants are a few inches high they should be thinned, if too thick. Those which attain less than a foot in height should be thinned to at least an inch apart, and those growing to a greater height ought to be at least 2 or 3 inches clear of their neighbours. The thinnings may be planted to fill up vacant spaces, or to supply the place of failures. Showery weather is the best time for thinning annuals.

As the plants advance in growth care should be taken to stake such as require support, and to place wire trellises for climbers, or sticks for them to cling to, before the one be broken by the winds, or the other spoiled and leggy from creeping on the surface. In dry weather the borders should be well watered, and the surface between the patches frequently stirred to keep down weeds and keep the surface open; and this stirring is best done before the plants feel the effects of drought, or the surface becomes baked or smothered with weeds. It is too late to water annuals when they have become stunted in growth, and vain are surface-stirrings after this has taken place. They may, indeed, improve, but the best plan is to act so that there is little to wish for. When they are in flower they should, if the weather is dry, be well supplied with water. It will much prolong their period of bloom, the flowers will be larger, and the pleasure derived from them will be ten times

greater than when they are grown in places altogether unsuited to their proper development.

In sowing annuals due regard must be paid to the habit of each kind and the height which it attains. Those of trailing and dwarf-growing habit should be sown in front, and the others distributed at such distances from them as their heights may determine. Half the height which any variety grows to is the proper distance to leave between the patches or rows. The tallest should, of course, be sown at the back, and the height gradually diminished towards the front.

Although an early bloom is very desirable, this cannot be obtained by sowing early; at least if it is, the flowers are not worth the labour bestowed on them. An early bloom is best obtained from autumn sowing; but I have been in the habit of sowing some of the most showy annuals in 48-sized pots early in March, and plunging them in ashes on a slight hotbed to forward them, and when well up and established they are planted out. The contents of a few hundreds of such pots planted in April add materially to the gaiety of the herbaceous borders in June and July.

The following is a list of the best annuals, those marked with an asterisk making good beds, though not suitable for massing with others.

SELECT HARDY ANNUALS.

- Alyssum maritimum*, white, 6 in.
 **Aster tanacetifolius*, blue purple, habit dwarf and branching, flowering all the summer, 1 ft.
Atropis hortensis rubra, crimson purple leaves.
Bartonia aurea, golden yellow, 1½ ft.
Beta brasiliensis, ornamental-foliaged plant, well adapted for shrubberies and mixed borders, 3 ft. Some have broad silvery central ribs, margined with green; others crimson, rosy, and violet ribs, with contrasting coloured margins.
Bhrua capitatum, scarlet-fruited Strawberry-blight, 2 ft.
Calandrinia speciosa, deep crimson, 1 ft.
Calendula, vars., well adapted for town gardens, 1 ft.
 **Calliopsis atrosanguinea*, dark red.
 **C. Drummondii*, yellow and red, 2 ft.
 **C. speciosa*, rich maroon crimson, 3 ft.
 **C. nana lutea*, very dwarf, yellow.
Callirhoe pedata, rich rosy crimson, with white eye, 2½ ft.
C. pedata nana, rich purple crimson, 1 ft.
Campnula Lorei, blue, 1 ft.
C. pentagonia, purple, 9 in.
 **Candytuft*, Large White (*Iberis coronaria*), 1 ft.; Large-flowered White (*I. grandiflora alba*), effective, 1 ft.; New Dark Crimson, 1 ft.; White Sweet-scented (*I. odorata*), 1 ft.; Purple (*I. umbellata*), 1 ft.; Large White Rocket (*I. amara*), 1 ft. (These are the most useful of all flowering plants for the summer decoration of the flower garden.)
Chenopodium atriplicis, ornamental coloured foliage, fine for borders, 3 ft.
 **Chrysanthemum Burrigeanum*, white, yellow, and crimson, one of the finest annuals grown, 1½ ft.
 **C. coronarium*, New Dwarf Yellow very fine, of dwarf habit, and most profuse in blooming, 1½ ft.
 **Clarkia elegans*, vars., 1 ft. to 1½. (A bed of Clarkias, mixed or separate, is a fine sight. All the varieties are very ornamental.)
Collinsia bartsiifolia, purple, 9 in.
C. bartsiifolia alba, white, 9 in.
C. bicolor, purple and white, 1 ft.
C. bicolor candidissima, pure white, 1 ft.
C. grandiflora, purple, 1 ft.
 **C. multicolor*, crimson, lilac, and white, a neat branching variety, 1 ft.
Collomia coccinea, scarlet, 1 ft.
Convolvulus major, vars., climbers.
 **C. minor*, blue, purple, &c., 1 ft.
Cotula aurea, golden yellow, neat for small beds or margins, 6 in.
Delphinium cardiopetalon, blue, 1 ft.
- **Delphinium chinense*, rich blue; a very fine Larkspur, flowering the first year; of branching habit, 2 ft.
Erysimum arkansanum, pale yellow, 1½ ft.
 E. Peroff-kianum, orange.
Eschscholtzia californica, yellow, 1 ft.
 E. crocea, orange, 1 ft.
 E. crocea alba.
 E. tenuifolia, straw-coloured, 9 in.
Eucharidium grandiflorum, crimson, 1 ft.
Eatoca viscida, dark blue, 1 ft.
Gilia achilleifolia, blue, 1 ft.
G. laciniata, blue, 1½ ft.
G. nivalis, white, 9 in.
G. tricolor, three-coloured, 9 in.
Godetia roseo-alba, rose and white, 1½ ft. Var. Tom Thumb, white, with a rich rose blotch on each petal, fine.
 G. The Bride, white, with crimson ring, 1½ ft.
Helianthus argyrophyllus flore pleno, double yellow flowers, fine.
 H. macrophyllus giganteus, 6 ft.
 H. striatus flore pleno, 4 ft., fine.
 *Larkspur, Branching, blue, rose striped, and white, nice border plants, 2 ft.
 L. Dwarf Rocket, flowers various, 1½ ft.
 L. Dwarf Stock, 1 ft.; Hyacinth-flowered, 1 ft.; Pyramidal Rocket, 1½ ft.; Tall Stock-flowered, mixed, 1½ ft.
 (All the Larkspurs are fine in lines or groups.)
Lasthenia californica, yellow, 1 ft.
Lathyrus alatus (Winged Pea), scarlet.
 L. alatus luteus, yellow, 3 ft.
 L. magellanicus (Lord Anson's Pea), blue, 3 ft.; and L. magellanicus albus.
 L. orcutus (Sweet Pea), vars., 6 ft.
 L. tingianus (Langier Pea), red, 3 ft.
 (A row of Sweet Peas is a fine sight.)
Leptosphon androsaceus, lilac, 1 ft.
 L. densiflorus, purple, 1 ft.
 *L. hybridus, vars., 6 in.
 L. luteus, pale yellow, 9 in.
Limnanthes Douglasii, white and yellow, 1 ft.
 L. Douglasii alba, white, 1 ft.
Linsaria speciosa, purple shaded, 1 ft.
Linum grandiflorum, brilliant crimson, 1½ ft.
 *Love-lies-bleeding (*Amaranthus caudatus*), red, 2½ ft.
 *Lupinus luteus (Yellow Lupin), 1 ft.
 L. albo-coccineus, very fine, white, with rose spot on the base, 1½ ft.
 L. Dunnetti superbus, red, brown, and yellow, 2 ft.
 L. Hartwegi albus, splendid white, 2 ft.
 *L. Hartwegi eulestinus, light blue, shaded with rose, free blooming, 2 ft.

- **Lupinus Hartwegi* rubeo, purple and red, fine, one of the best, 2 ft.
- **L. hybridus nigricans*, rich violet, very showy, 2 ft.
- **L. Meuziesii*, fine yellow, 2 ft.
- **L. nanus*, blue and white, 1 ft.
- **L. nannus flore albo*, white, 1 ft.
- L. subcarneus*, rich blue, fine, 1½ ft.
- L. vastus*, lilac and white, 1½ ft.
- L. venustus tricolor*, purple, white and blue, pretty, 1½ ft.
- **Malope grandiflora* (trifida), bright crimson, fine, 3 ft.
- M. grandiflora alba*, white, 3 ft.
- Mignonette* (*Reseda odorata*), greenish yellow, 9 in.
- M. grandiflora*, large-flowered, fine, 1 ft.
- **Nolana atriplicifolia*, blue, white, and yellow, 6 in.
- **N. prostrata*, blue, 6 in.
- N. paradoxo violacea*, violet, 1 ft.
- Nemophila atemaria*, white spotted, 1 ft.
- **N. atemaria oculata*, white, rich dark spots, with lacinated margins, fine, 6 in.
- **N. insignis*, blue, a universal favourite, 9 in.
- N. insignis alba*, white, 9 in.
- N. insignis marginata*, blue, edged with white.
- N. maculata*, white, with large purple spots, 1 ft.
- Oxalis corniculata foliis atro-purpureis*, ornamental foliage, suitable for margins of beds, &c., 3 in.
- O. rosea*, bright rose, 9 in.
- Poppy*, *Carnation*, various coloured flowers, 2 ft.
- P.*, *Fimbriata*, various colours, 2 ft.
- P.*, *French*, fine, 2 ft. (A large bed of these is really splendid.)

- Poppy*, Double varieties, 2½ ft. (All are fine for borders or woodland walks in sunny situations.)
- Saponaria alba*, white, 9 in.
- S. calabrica*, pink, 9 in.
- **S. marginata*, pink, margined white, fine for beds.
- **Silene barbata*, rich pink, fine.
- **S. pendula*, rose, 1 ft.
- **S. rubella alba*, white, fine, 1 ft.
- Sphenogyne speciosa*, yellow, dark centre, 1 ft.
- Sweet Sultan* (*Centaurea moschata*), Purple, 2 ft.; White, 2 ft.; Yellow, 2 ft.
- Tropaeolum majus* (Tall Nasturtium), various, 6 ft.
- T. majus purpureum*, plum, with purple tint.
- T. nanum*, Tom Thumb. *Fars.*, Beauty, orange spotted; *Crimson*; *Crystal Palace Gem*, sulphur, with red spots; *Scarlet*; *Perl.* cream colour; *Yellow*; *Yellow Spotted*. (Charming plants for beds or borders.)
- T. peregrinum* (Canary Creeper), yellow, 10 ft.
- Venus's Looking-glass* (*Campanula speculum*), blue, 6 in.
- Venus's Navelwort* (*Omphalodesa linifolia*), white. (A nice plant for margins of beds.)
- Veronica sylvica*, blue and white. (Makes a good edging early in the season.)
- Virginian Stock* (*Malcolmia maritima*), red, 6 in.; white, 6 in.
- Viscaria oculata*, rose, with dark eye, 1 ft.
- **V. oculata nana coccinea*, deep rose, 6 in.; splendens, rosy-red, 6 in.

In the above list my endeavour has been to exclude those unworthy of a place in flower gardens. Some of those named do not succeed well in all soils, nor alike in all seasons; but they will well repay any trouble bestowed upon them.—GEORGE ABBEY.

In No. 154 Mr. G. Abbey gave a list of annuals which he has found worthy of cultivation, and he also expressed a wish that any one knowing of other kinds would name them. I therefore submit the following to his notice; and I believe that, if he give them all a fair trial, he will find not a few of them up to his standard of merit.

I jotted down the names entirely from memory, and no doubt I have omitted several good things; but, as the worth of a plant is to a great extent a matter of individual taste or opinion, I leave the list in the hands of the public, merely marking with an asterisk such as I consider really good.

- Adonis autumnalis*.
- Brachycome iberidifolia*.
- Centa turbinata*.
- **Centaureidum Drummondii*.
- **Chrysanthemum coronarium*.
- **Commelina coccinea*.
- Cryptostemma calendulaceum*.
- Caphea silioides*.
- **Datura carotacolon*.
- **Dimorphanthea pluvialis*.
- **Erysimum Peroffskianum*.
- Echscholtzia californica*.
- **Eucharidium concinnum*.
- **Fenzlia dianthiflora*.
- Gilia capitata*.
- G. tricolor*.
- **Heliopsis Sandfordii*.
- **Iberis umbellata*.
- **Ionopsidium aculea*.
- **Leptosiphon luteus*.
- L. densiflorus*.
- **Limnanthes Douglasii*.
- Lopezia coronata*.

- Madaria elegans*.
- Malcolmia maritima*.
- **Malva trifida*.
- M. trifida alba*.
- Moricandia arvensis*.
- Morina elegans*.
- Nigella damascena*.
- Nolana tenella*.
- Polygonum orientale*.
- **Santivaria procumbens*.
- **Saponaria calabrica*.
- S. calabrica alba*.
- Schizopetalon Walkeri*.
- Scyphanthus elegans*.
- Silene integrifolia*.
- **S. pendula*.
- Sperularia speculum*.
- Sphenogyne versicolor*.
- S. aconitifolia*.
- **Veronica sylvica*.
- Viscaria oculata*.
- **Wahlenbergia agrestis*.

—G. L.

THE DINNER-TABLE DECORATION PRIZES.

AMONGST the many subjects of discontent which the promulgation of the prizes offered by the Royal Horticultural Society has caused, it is satisfactory to be able to turn to one in which they have certainly given satisfaction, and that is by again offering prizes for dinner-table designs. Let the credit due be paid to the gentleman who has instituted and still supports these prizes, and who, in the

present season, has laid down some useful limits to the flights which Fancy in her caprices is wont to take.

I believe it is not too much to affirm, that at the Show of last June when the prizes so offered were competed for, nothing attracted so much attention. Ladies of rank as well as gardeners and others crowded to the tables containing the various designs, and all freely criticised the respective stands in accordance with the view each individual took of what constituted "the beautiful." Without, however, reviving the now long-since withered specimens of floral beauties or incongruities, it is almost needless to say that one or two examples were so generally disapproved of by the criticising public that they will not again appear. But amongst those respecting whose claims to attention various opinions were expressed, there were one or two examples which I trust hereafter may receive more notice than has been hitherto bestowed upon them; and as the judgment of last year seemed open to grave objections, and by the conditions laid down cannot be acted upon this season, I am not without hopes that one plain rule, strictly bordering on utility, which I have on more than one occasion urged in these pages, will eventually obtain a chief place.

On former occasions when I have given an opinion on this subject, I have urged that everything of an ornamental character put upon a dinner-table should be so low as to be under the line of vision between one person's countenance and that of another when seated at table; or, in a very few instances such things as candlesticks, lamps, and the like be of necessity higher than the point given, let them present as little obstruction as possible between the guests at table. This, however, is the department of another class of decoration; but once establish the rule that the present policy of making a tower up the centre of a dinner-table is bad, and a general cut down or rise up will be the result; for, notwithstanding all the advances the decorative arts have made in the last twenty years, those only promise to be of a permanent kind which embrace something of the character of utility. Even in the vagaries of the costume at the present day, utility has been more considered than of yore, especially by the rougher sex, and possibly the gentler one will say they also derive more comfort from the more space they now occupy; and I need hardly add, that the ardent purveyor of ornament in whatever form he may present it, is most anxious to add the term "useful" whenever he can do so, and even give it the prominent place.

As before stated, I therefore do not despair to see those beautiful designs of fruit and flowers which grace the dinner-table so much reduced as to come within the dimensions given above. To be more plain, let nothing be higher than 14 inches, measuring from the tablecloth; or if suspended do not let anything bulky approach nearer than 24 inches from the table, thereby leaving a clear space of 10 inches, and as much more as can be given, free of all obstruction.

In advocating this I am by no means insensible to the claims of flowers and other ornaments; but assuredly these can be seen as well and even better when below the eye than when on a level with it or above it. Most people, if not every one, reads with most comfort when the book or paper is below the eye, and in examining any object when more than ordinary observation is required, this is invariably the case if it can be managed so; besides which there are a greater number of flowers opening upwards than in a pendant direction, and fruits of all kinds present their most showy sides to the sun. More might be said to urge the validity of the position which I have taken, but it is needless to follow it up further. I hope in the present year, however, to hear of more examples embodying my views than last; and as the schedule very wisely prohibits birds and fishes, it is evident that the turn taken in the direction of utility has only to be pushed a little further, and all the top-heavy objects will topple over; and this is the less to be regretted in consequence of their fragile character giving in many cases a feeling of insecurity.

Before closing my notes on this subject I would remind the admiring public, or those who act as censors on such occasions as at the Show alluded to, that merely walking along and looking at the various designs is hardly a fair way of discerning their merits. The designs are or ought to be prepared to give the best possible effect to company seated at table, and not standing; and supposing a bulky

plant or bouquet in the centre of a long table, that screen alone hides several persons at the right hand of one end of the table from those who sit at the left of the other end; this assuredly is never meant to be the case at a social meal, besides which, however beautiful the design may be, it is questionable if any but those in immediate contact with it regard it otherwise than with indifference; whereas a well-selected stand of flowers of glowing colours that contrast well with the tablecloth is admired by all, and the nearer it approaches the tablecloth the better the contrast.

As an accompaniment to dinner-table decorations in the way alluded to, I will add that the cultivation of plants for the purpose has received much attention, and many are the claimants for distinction. Unfortunately, however, the necessity of showing them in small pots prevents a large number of flowering plants from competing; but in the class where foliage is the predominating feature the list of those available for the purpose is by no means a meagre one; but as I may return to this subject, I will only conclude by calling attention to the view I have given of the matter, and if any have objections to the laws I would lay down, let them state them at once, giving the reasons for their objections.

J. ROBSON.

STATICE PROFUSA CULTURE.

THE Statice family is one well worthy of more general attention than has hitherto been bestowed on it. Many of the varieties are most useful for conservatory and cool greenhouse decoration for several months in autumn, when blooming plants become rather scarce. They are also exceedingly useful for sitting-room stands and vases, more especially the one which my present object is to bring more prominently before your readers. There are many plants which are brought into notice and general cultivation with a bound, and which with an almost equal rapidity fall into the shade and are forgotten, except where collections of plants are the object instead of useful selections. They never deserved the characters with which they were brought under public notice. Other plants, again, raised by comparatively obscure individuals are at first treated with carelessness, and, perhaps, disregarded, though of sterling merit, but they slowly and surely work their way into general cultivation and favour, and ultimately become permanent tenants of almost every greenhouse or stove.

I have no fear of being contradicted by any one who is acquainted with the exceeding usefulness of *Statice profusa*, when I assert that it is one of the most useful pot plants that have been produced by hybridisation for the last ten or fifteen years. Its utility as a decorative plant cannot well be overestimated, nor is it likely to be fully appreciated for some years to come. As far as my taste and judgment goes it is unrivalled by any of the other members of the *Statice* family. It was raised by Mr. Rattray, late gardener at Saltoun Hall, and is a cross between *S. Holfordi* and *S. puberula*. It partakes of all the compactness of the latter, with a good share of the vigour of the former variety, is higher in colour than either, and yields an immense crop of bloom. An individual plant will continue in bloom from the beginning of August till the end of November in a greenhouse temperature. By keeping a few sets of plants in different stages there is no difficulty in having it in bloom every month in the year. It partakes of the hardness of *S. puberula*, and consequently keeps in health in a greenhouse temperature all the winter, although to grow it freely and quickly into large plants it likes an intermediate temperature during the spring months.

It has the additional recommendation of striking more freely from cuttings than many of the *Statice*. Cuttings made in the usual way, and placed in a gentle bottom heat about the end of July or beginning of August, root with certainty in from four to five weeks. I have sometimes cut a notch at the base of the small side shoots, and split them up a little, fixing a small wedge in the opening, and allowed the cuttings to remain on the parent plant till the wound healed or callused over, and then removed them to the propagating-pit, where they very soon emitted roots. When well rooted they are potted, if strong cuttings, into four-inch pots. They delight in a compost of two parts loam, one part peat, one part leaf mould, and one part silver sand. To obtain

large plants quickly they should be grown in the coolest part of the stove all the winter, where they will have a heat of from 55° to 60°, and they should be kept close to the glass. They are ready for a shift early in February, and will require an eight-inch pot, and the same soil as that already named, with a slight addition of old cowdung and pounded charcoal. In these pots they make fine flowering plants, forming a compact and dense head of bloom 20 inches to 2 feet across. If required for late-autumn blooming, the first flowers must be pinched off as they appear. The first that appear are, however, the finest heads of bloom. During the spring months after they have been shifted, they should be grown in a temperature of 60°, and be syringed overhead once or twice a-day. In a moderate degree of bottom heat their progress is still more rapid and vigorous; but bottom heat is by no means indispensable. As they throw up for bloom they should be hardened-off, and ultimately placed in a light, airy house, where they form beautiful objects among autumn-flowering plants.

After the flowering season is past the flower-spikes should be removed, and the plants must be wintered in the greenhouse. In spring they require to be turned out of their pots, the balls reduced, and potted into larger-sized pots. If a little bottom heat can be afforded them it will greatly assist them in making a fresh start. The size of plants desired must regulate the size of pot into which they are shifted for flowering. In twelve and thirteen-inch pots they make large plants with an enormous profusion of bloom, fully justifying the name the plant bears. Few plants are more subject to green fly at all seasons; and fumigation with tobacco must be often resorted to in order to keep them free from this pest.

So highly appreciated is this plant for decorative purposes, that it is grown by the dozen by those gardeners who have known it the longest. In some instances it has been planted out in summer, and has succeeded admirably. I would strongly recommend it to those who have much to do in the way of decoration with pot plants. D. THOMSON.

ROSES ON THEIR OWN ROOTS.

A DISTINGUISHED rosarian writing to the "Florist" some time ago, stated that if any amateur horticulturist took up a gardening periodical and found nothing in it about Roses, he or she would certainly lay it down with a feeling of disappointment or something akin to it. Now, if this is not exactly a truism, it expresses a very general sentiment—for an obvious reason: the Rose is everybody's flower, everybody admires it, and it is found in nearly every garden, public or private, from that of the peer to the peasant's. Tender and choice varieties may be seen in almost every conservatory of the wealthy. The old vigorous *Sempervirens*, *Félicité*, *White China*, and others cover the walls of the cottage; while the *Damask*, *Cabbage*, and *Moss*, are conspicuous in the tiny flower patches wherever one is permitted to exist. Very many, too, have their standards and "collection," and where the flower garden is an object of care and culture, the Rose forms an important item in its decoration. But the rosarian, however kindly he may look upon a Rose plant when he sees one, is far from satisfied with planting a number of varieties, more or less, and then leaving them to the care of Providence, excepting, perhaps, an occasional pruning. He soon discovers that they require attention to bring them to the perfection they are capable of attaining—in other words, they must be cultivated. Something about them, whether it be information on their culture, what new varieties are likely to turn out well, or, indeed, any Rose intelligence, is sure to be acceptable to a large number of the readers of any gardening journal. The readers of THE JOURNAL OF HORTICULTURE have not, for some weeks past, seen any articles on this favourite flower, but an inquiry by a correspondent in No. 154 has suggested the remarks which I am about to make, and which I hope may induce other rosarians to give their experience likewise.

I know of no flower more susceptible to differences of soil than the Rose, more especially the class of Hybrid *Perpetuals*. A very casual observer of the great Rose shows that have of late years been held at the Crystal Palace, and at the Royal Horticultural Society's Garden at Kensington, could not fail to notice how different the same kind appeared in

different boxes from different parts of the country. I have seen Roses in the greatest beauty with little aid from man, after they have been planted in soils so well adapted to them that they may be said to be almost indigenous there. I have also been so fortunate as to see them in the garden of the distinguished rosarian alluded to at the beginning of this article, where the soil is indeed anything but favourable, and where many contingencies adverse to Roses happen, but where every difficulty has been contended against with a perseverance and intelligence which have not failed to call forth the warmest admiration of all who have been there. I have seen them again, dragging out a brief and miserable existence most piteous to behold, where from neglect or other causes they have been suffered to pass a wretched time of it, without being able to produce a single flower fine enough to attract notice.

I am sanguine that Roses can be grown, even on poor soils, not good enough, it is true, for exhibition purposes, yet beautiful and attractive for the spot. I have here great difficulties to contend with; the soil is very light and sandy, the situation much exposed to winds, particularly from the north, north-east, and east; and my disappointments have been great and frequent. Many good varieties which flourish in soils favourable to Roses cannot exist here. There are many, probably, who, like myself, have had grievous mishaps, their soil being like mine very light; but let not such despair. A great deal depends upon the form which they adopt for their Roses—that is to say, whether on their own roots, on the Manetti, or on the briar; these are three most distinct modes of cultivation in use. Now it is evident that where one mode may succeed another may fail, and in some places all may succeed, or some better than another; but I know of no ordinary place where they all fail, unless by very perverse planting and selection of kinds. I have for some years past tried all three of these forms on many varieties, including Hybrid Perpetuals, Bourbons, Noisettes, Teas, Gallicas, and Hybrid Chinas.

Roses on their own roots take time to become strong plants, but much may be done to help them on. If the plants are obtained in pots from the nursery in the autumn, it is advisable to keep them so through the winter in a cold pit or frame till April, when they may be turned out and planted in the spot designed for them. In planting, I have found it useful to take out a few spits of earth, and fill the vacancy with about one half of turfy loam, and one half of heavy manure, chiefly night-soil that has been buried for some months, or pig manure when it can be obtained, mixing the two well together, and placing the plant in the middle, not too deep, and being careful that it is left firmly in the ground (I am speaking of light soils only). As the summer advances it will soon be apparent whether the plant will thrive. If it is a vigorous, healthy-growing kind it will send out strong shoots from the bottom. In dry weather water must be afforded and the surface mulched. Rain water is to be preferred; and manure water, not too strong, may be occasionally given while the plant is young. If in November the plants have made but little progress, it will be best to take them up, pot them, and keep in a pit or frame for the winter. Should they fail to grow in the succeeding summer after being again planted out as before, it may be concluded that the kind will not do. It is also to be noted, that good shoots of the first year's growth should be tied, to prevent injury by the wind.

None of the Hybrid Perpetuals naturally dwarf, or of only moderate habit, will flourish on their own roots in a light soil. They will live on for a year or two and then die. I have had many such, so that I no longer attempt to grow any in this way, but such as are of vigorous and robust constitution.

The following Hybrid Perpetuals may be depended on, when grown on their own roots, for light soils, and although I have not myself proved all of them, I can speak of them with confidence.

Light.—Caroline de Sansal, Duchesse d'Orleans, Mademoiselle Bonnaire. Madame Vidot is a failure here; and Louise Darzins and Sœur des Anges I have not yet proved.

Pink and Rose.—Baronne Prevost, Comtesse de Chabrilant, Anna Alexieff, Anna de Diesbach, Belle de Bourg-la-Reine, Glcire de Vitry (one of the best), Comte de Nantenil, La Ville de St. Denis, Madame Boll Madame de Cambacères,

William Griffiths, Souvenir de la Reine d'Angleterre, Victor Verdier.

Carmine and Crimson.—Baronne Hallez, John Hopper, Jules Margottin, Madame C. Crapelet, Madame Louise Carique, Triomphe de Paris, Triomphe de l'Exposition.

Scarlet and Purple Crimson.—Duchess of Norfolk, Eugène Appert, Géant des Batailles, Général Jacqueminot, Sénateur Vaisse, Lord Raglan, Lion des Combats, Triomphe des Beaux Arts. I have not yet proved Duc de Rohan, Maurice Bernardin, and others of recent introduction.

Dark.—Cardinal Patrizzi, Empereur de Maroc, and probably Prince Camille de Rohan.

Bourbons.—Acidalie, Souvenir de Malmaison, Madame Despres, Louise Odier, Sir Joseph Paxton, Docteur Berthet.—ADOLPHUS H. KENT, *Bletchingley, Surrey*.

ROYAL BOTANIC SOCIETY'S FIRST SPRING SHOW.—MARCH 19TH.

MORE fortunate than its predecessor at Kensington, this Show was favoured by one of the brightest of spring days. The display though small was good, and principally consisted of Hyacinths contributed by Messrs. Cutbush and W. Paul. The latter took the first prize in the Nurserymen's Class for twelve, with Argus, Marie, the beautiful new Lord Palmerston, King of Blues, Bloksberg, Von Schiller, Macaulay, Koh-i-Noor, Duc de Malakoff, Ida, Mont Blanc, and Snowball. Messrs. Cutbush, who were second, had Bleu Aimable, Argus, Baron Von Tuyl, Nimrod, Macaulay, Von Schiller, Florence Nightingale, Grandeur à Merveille, Mont Blanc, Seraphine, Ida, and the almost black General Have-lock. The spikes in both these collections were, almost without exception, remarkably fine, and the merits of the two stands very nearly equal. Both the above-named exhibitors showed, in addition, in the Miscellaneous Class, collections of one hundred, comprising nearly all the best kinds in cultivation. Here Mr. W. Paul again took the precedence; but Messrs. Cutbush ran him very closely. In their collection we noticed two new kinds, Josephine and Robert Fortune, described last week. Messrs. Barr & Sugden were the only other exhibitors in the Nurserymen's Class, and received the third prize.

Among Amateurs the best collection came from Mr. Young, gardener to R. Barclay, Esq., Highgate, in which were fine examples of Leonidas, Charles Dickens, Baron Von Tuyl, and other kinds already named. Mr. Carr, gardener to B. Noakes, Esq., Highgate, was second. Special prizes were also offered by Messrs. Cutbush for Amateurs' collections of twelve, for which Mr. Young and Mr. Carr were also the competitors.

In Camellias, the only collection in pots came from Mr. Young, who consequently took the prize. Among them were Alba plena and Baron de Proney (white), Imbricata rubra, and Woodsii.

In Cut Blooms Mr. W. Paul was first, Mr. Treen, of Rugby, second; and in the Amateurs' Class Mr. Todman, gardener to R. Hudson, Esq., Clapham Common, had a first prize. Among the varieties shown were beautiful examples of Alba plena, Eximia, Princess Bacchiuchi, Countess of Orkney (a charming sort), Rubens, and Ochroleuca.

Of Cyclamens, excellent pots were shown by Mr. Holland, gardener to R. Peake, Esq., Isleworth, and Mr. Wiggins, gardener to W. Beck, Esq., of the same place, and who stood in the prize list in the order in which they are named. Mr. Holland had also a remarkably fine single specimen—such, indeed, as is rarely seen. Messrs. E. G. Henderson likewise exhibited a numerous collection of Atkinsi and Persicum seedlings, for which a prize was awarded. Chinese Primroses were shown by Mr. Todman and Messrs. Dobson and Sons, and the Fern-leaved kinds by Messrs. Henderson. They were well grown, and of good colours, and their exhibitors all had a place in the prize list.

Of early Tulips, collections came from Messrs. Cutbush and W. Paul, consisting, for the most part, of the kinds shown at Kensington. Roi Pepin, Proserpine, Vermilion Brilliant, Yellow Prince, Fabiola, Tournesol, and New Yellow Tournesol (very large), were some of the most showy. Mr. W. Paul also exhibited Crocuses, of which David Rizzio, Sir W. Scott, Ida Pfeiffer, Albion, Marie d'Ecosse, and Mammoth, were a few of the best.

Amaryllids came from Mr. Parker, of Tooting, the most showy being *Ackermannii pulcherrima*; well grown *Lilies* of the Valley from Mr. Howard, of Ballham.

In Roses Messrs. Paul & Son had a good stand of cut blooms, among which were *Amiral Gravina*, *François Lacharme*, *Catherine Guillot*, *Professeur Koch*; and *Teas*, *Vicomtesse de Cazes* and *Devoniensis*; and the same firm had also some fine specimens in pots. *Victor Verdier* and *Jules Margottin* were in fine bloom; *Mesdames C. Wood* and *Julie Daran*, *Lord Canning*, *Souvenir de Comte Cavour*, *Teas*, *Louise de Savoie*, *President*, and *Madame de St. Joseph*, were also very good.

From Mr. Bull came a collection of flowering and fine-foliaged plants, among which were *Hebeclinium atrorubens*, a very good *Azalea Triumphans*, and the showy *Imantophyllum miniatum*; and collections of a similar nature were contributed by Mr. Treen and Mr. Cross. *Pourettia pungens*, with a spike of scarlet flowers, bright in colour, but not sufficiently developed, came from Messrs. F. & A. Smith; and from Mr. Hill, Keele Hall, some excellent old and new Grapes, consisting of *Lady Downes'* and *Black Barbarossa* of 1863, and *West's St. Peter's* and *Black Hamburg* of the present year. Certificates of merit were awarded to Mr. Bull for *Chameranthemum verbenaceum*, also for *Camellia Comte de Gomer*, a deep rose and white-striped kind, very full and fine—a first-class; to Messrs. Veitch for *Azalea Stella*, orange scarlet, spotted on a violet crimson ground on the upper petal; also for a white *Rhododendron* from Moulmein, already noticed at p. 212; to Messrs. F. & A. Smith for *Cinerarias Eliza*, bright crimson margin, with white ring round the disk, and *Flower of the Day*, deep mulberry, with narrow but distinct white ring; and to Mr. Wiggins for *Nonpariel*, broad bright crimson edge, and white ring. Several other seedlings were also shown by Messrs. Smith and Wiggins, but were not considered worthy of special notice.

ROYAL HORTICULTURAL SOCIETY.

If the observations and assertions of great men and philosophers are worthy of being received, we must look upon the science and art of horticulture as among the most important occupations that have engaged the attention of the human race. If a country's greatness and welfare be so largely dependant on the intelligent pursuit and development of agriculture, then we cannot do otherwise than place gardening in the front rank of all that is important to and connected with the productiveness of the soil; for most assuredly it has been the cradle of agriculture. The two are often called twin sisters. The one should be looked upon as the parent of the other; for it has been in the lap of gardening that agriculture, like a young Hercules, first tried its powers, and prepared like him to overrun the world, speedily clearing it of monsters, and bestowing on man the blessings of its civilising effects.

The recent efforts of modern mechanism to bend the powerful application of steam to the tillage of the soil must look for their reward chiefly from a deepened staple in the farm field, in imitation of what has long been practised in our garden quarters. If the productiveness of our fields is to be greatly increased, it must arise from learning and practising the lesson which shares so great a part in the success of the gardener. In fact, gardening may be justly regarded as another name for the perfection of rural or field culture.

Looking at horticulture in such a light as this, it becomes invested with an importance it would be difficult to over-estimate: hence a National Society, established with the express view of teaching how better to develop the resources of our gardens, is greatly to be desired. It is, however, a notorious and lamentable fact that the gardens which have been attempted by these societies with this end in view have, after a career of the most lavish expenditure, done little else besides get into debt, and ultimately, in some cases, die a natural death.

We need scarcely call attention to the enormous sums of money which have recently been raised and spent by the Royal Horticultural Society of London, with the commendable object of placing itself in a position worthy of so great and wealthy a country with its unrivalled private garden

establishments. It has had poured into its lap a very river of gold; it has shared the patronage of our gracious Queen, and every conceivable kind or form of encouragement has it received. What would be unreasonable to expect from a Society so highly favoured? It has had tributaries almost equal to that of Solomon when he made orchards, "delighted to dwell in gardens," and "planted the vineyard of Baalhaman."

The supporters of this Society have been dazzled now and again with a flourish of trumpets and the most flattering accounts of what has just been going to be done, while all are agreed that its most successful performance has been the spending of a revenue enough for a respectable principedom or kingdom. Some of our contemporaries have shown with great force the vast extravagance with which it has been attended, and shown at the same time that it has not been able to provide even a proper place for a flower show, in which plants and fruits could be either comfortably or effectively arranged. They have shown how a tent was attempted, but that the merciless element of wind blew it over, and that—ridiculous to tell—it has managed to get through £2000 or £3000 sterling for music alone in one season!

After such unprecedented extravagance the country which has supplied the funds has a right to look to the Council for something substantial in return. It certainly is nothing more than reasonable and right that in some one particular branch of gardening, at least, examples of culture or arrangement should be looked for. The mere holding of shows for flowers and fruit is all very well, but there are other societies which know how to do this part of the business of the Royal Horticultural Society much more effectively than it has yet deserved credit for. The gardens at Kensington have been the objects of the severest criticism, and we have no intention of dealing with that question. We would submit, however, that, as compared with the Royal Botanic Society's grounds in the Regent's Park, those at Kensington are a mere toy, while the other is allowed by all to be a masterpiece of beautiful and chaste design. In the Regent's Park you may fancy yourself a hundred miles from town; in the Kensington grounds brick and mortar hang an incubus on the mind, while the merest schoolboy might improve upon the whole concern with a compass and scale.

As far as taking the lead in gardening is concerned, it would appear, from a recent advertisement, that the Council are not ambitious of exerting themselves. They are more willing to make others pay into their treasury for the privilege of teaching the nation how to garden. They have advertised a portion of the grounds at Kensington to be let out in the allotment system to what they call responsible nurserymen (we thought all nurserymen were responsible), to be filled with bedding plants during the year 1864. Nurserymen are surely to be highly honoured that they are to be made to pay for doing what the Society has failed to do itself. This is quite a brilliant idea! The next step should be to let the privileges of cutting the grass to Messrs. Shanks, Green, & Co., in order that those mechanists might themselves be shaved for shaving the lawns of the fancy gardens at South Kensington! This would get the Council into a fair way of increasing their revenue, and at the same time decrease the work they have undertaken to do.

It is quite new to us that nurserymen are the most likely parties to be able to show the highest styles of flower-garden arrangements, or that this is a department that they have made their peculiar study. Judging from the attempts generally made in their own grounds, we should say that the very reverse is the case. However, we have great faith in the energy and skill of nurserymen in the accomplishment of any task that they propose to themselves. It is very questionable whether many of them will be silly enough to jump to such a ludicrous bait. If they do, it is to be hoped they will manage to treat the members to a little bloom and well-covered beds before they leave town in August.

This Society is altogether curious in its workings, and it would not be at all surprising if the scheme which the London papers have reported them to have in contemplation should be brought to maturity, and also advertised in due time. We refer to the offering of prizes for the most skillful performances of volunteer bands. The morning journals

surely took it upon themselves to prognosticate this as the next most likely thing which might be expected from this Society, on the principle that it is most difficult to divine what some parties may be expected to do next! £40 for a single prize to a volunteer band for the best performance of a quadrille or waltz! It is fortunate for the feelings of those to whom the munificent sum of 30s. has been awarded for a dish of Grapes ripened in January, that they find no mention of this burlesque in the Report just issued. It seems, however, that croquet and bowling clubs are to be encouraged for the "attraction and enjoyment" of Fellows. How would it do to engage a troop of Blondins and columbines, and so merge at once into the Cremonne style of doing things?

Reference has already been made to the thirty-shilling prize awarded to a dish of Grapes ripened in January. It would be instructive to our dull minds in the north to know why so paltry a sum is offered for Grapes ripened at such a season, when it is problematical whether there are more than half a dozen gardeners in the kingdom in a position to compete for it; while double the amount is offered for a dish of the same sort in July, when growers can count their Grapes by the hundredweight—still more instructive to know why flavour should be made the *only* test of merit in January, while at midsummer flavour is not taken the least account of, and the award guided entirely by appearance.

Altogether the workings of this Society are most novel. The Council tell the Fellows that £13,000 more are required to complete and beautify the toy gardens at Kensington, and the Fellows tell the Council that the real horticultural department at Chiswick is kept in a most "wretched" manner; another describes the state of affairs at Chiswick as "most disgraceful, and calculated to call forth the opprobrium of foreigners," and in this statement he is warmly supported by a large number of the Fellows. And yet, in the midst of the filth and weeds of Chiswick, the Council talk largely of being the exponents of horticulture in the world. It may be all very well and proper to "enlarge the circle of foreign societies with which they are in friendly relation," but better still would it be first to at least keep their garden tidy if they do fail to practically expound the important science in which they ought to take the lead. Unless there be a rapid turn in the tide of affairs, it is much to be feared, that if foreigners are to see high and advanced examples of horticulture, they must look somewhere else than amid what one of the Fellows describes as the "wretchedly kept" wilderness of Chiswick.

If such be the state of affairs at Chiswick, it would appear to be nothing better at Kensington, for in the discussion which followed the Report, the gardens there are described as resembling an "ill-planned and ill-kept cemetery." When is all this muddle, and mismanagement, and mispending of funds to come to an end? Would it not be much better to deliver up the whole concern at Kensington to the Commissioners of the Exhibition? And would the cause of horticulture not be much more benefited were Fellows to give more encouragement to local societies and leave such a water-logged concern to its fate?—(*Scottish Gardener.*)

LOBELIA SPECIOSA CULTURE.

In a communication from Mr. Robson on the *Lobelia speciosa* he stated that he thought the best mode of cultivating it had not been found out. I do not know whether my mode is the "best," but I have for a long time managed successfully according to the following plan.

With loam, peat, leaf mould, and sand, well mixed together, I fill boxes nearly full, add some fine-sifted peat and sand, and press evenly all over the boxes. I then sow the seeds, and with fine-sifted peat soil cover them lightly, settling all down with water from a brush. This is done at the beginning of June. I plunge the boxes in coal ashes, and put a little whitening on the glass, inside of the frame, to keep the rays of the sun off.

When strong enough to handle I prick out the seedlings, three together, in thumb-pots, and when done plunge the whole in coal ashes up to the rim. They remain there till October. All light-coloured and wiry-leaved seedlings are rooted out, and those only of the erect and true blue *Lobelia*

speciosa are retained. These, also, are trimmed off, and all flower-stems are cut closely in. They are then placed near the glass where air can be freely given.

I keep them in a cold place all the winter, free from frost and damp. At the end of March I shake them out, pot them singly into thumb-pots; cut back and place them in a mild hotbed till the pots are full of roots; I then harden them off, and plunge the pots in coal ashes under a frame.

By planting-out time they make nice close plants, and I can always depend on having them in great perfection by this plan. Spring-sown plants are not fitted for regular lines, and cuttings grow weak and straggling. I have grown the *Lobelia speciosa* each way, and find the plants repay all the trouble which has been taken with them when kept in the way I have stated. It will be the opinion of many that this method gives a great deal of unnecessary trouble; but if they try the plan they will find all that is required in *Lobelia speciosa* from year to year.—G. HOLLACKEY, *Gardener, Crofton Hall, Salop.*

FUCHSIA CULTURE.

THOUGH not so showy as many of our greenhouse plants, and though possessed of no sweetness, yet from the very time of its introduction few plants have become such favourites as the Fuchsia. It is ever welcome in the conservatory, and is generally to be met with in some form in the window of the humblest tenement. Its adaptability to very varied systems of treatment, its gracefulness, and the beauty of its flowers, have secured to it this general patronage.

There are two or three distinct modes of culture practised with this genus, each proving satisfactory in the end. For example: some grow their plants each season from very early or autumn-struck cuttings, whilst others prefer storing away the old plants of one season for the use of the next; but in advocating the latter of these modes, I will state some of the principal details of each.

In the first place, then, I will refer shortly to the manner in which plants are successfully grown from cuttings, though only advising those to follow this mode who have abundance of spare room, except when in possession of a new variety, and occasionally when it is necessary to recruit the old stock by additions of younger growth.

The cuttings should be struck in October, or early in November. Choose tolerably strong, well-matured wood, or shoots of the current season's growth, and such as have been well exposed to light and heat. As they will require whilst striking to be placed in a slightly-shaded and close atmosphere, it will be necessary to strike them as quickly as possible, otherwise their vigour will be greatly impaired by a too long deprivation of light and air. As soon as rooted pot them off singly into 60-sized pots, taking care not to injure the tender young roots found at their base. This can be performed the easier by placing not more than four cuttings in finely-sifted soil round the edges of a 48-pot.

Having been properly hardened off, place them in a light, airy situation in the greenhouse, to be properly watered and kept in a like position until about the second week in March, or a little earlier if the plants are vigorous and appear to require a shift, especially if large specimens are required. Then they should each have the leading bud pinched out to induce them to form side shoots, and when these are properly formed the plants should be encouraged, first by a little manure water, and afterwards by a shift into 32-sized pots. When shifted they should be removed into a higher temperature, with more moisture, &c.

It will be advantageous at the time of potting to tie the upper shoot to a stick, and as it advances it will then take the place of the leader previously pinched out.

A temperature commencing at 55°, and gradually advancing until the maximum of 70° or 75° is attained, slight shading being given in the middle of the day as the sun gains power, will suit them well. Pinch the side shoots back to about four distinct eyes each, but permit the shoots to become tolerably strong in each instance before this is done. Use the syringe frequently when the growths appear after each pinching-back, but sparingly immediately after pinching back.

When it is supposed that the roots have pretty freely

reached the sides of the pots, by which time the plant will have become a tolerably compact specimen, give another shift. The size of the pot must depend upon the time at which it is requisite to have the plant in flower, and the size of the plant; at any rate endeavour to so pot the plant as to have the last shift well filled with roots before flowering commences, when it will be necessary, as the first blooms expand, to gradually harden the plant off until able to endure the draughts of the greenhouse or conservatory.

The soil I think they do best in is a compost of one part of rather decayed turfy loam, one of sand, one of leaf mould, with a little sifted peat. I was once very successful with the Fuchsia, when potted in one part loam, and one of decayed heather, and with Cucumbers in boxes especially, laying the least decayed portion at the bottom in place of crocks, around which the roots clung amazingly. Was it attributable to any distinct properties which the heather possessed? During the whole period of flowering a little weak manure water applied often will be beneficial to them.

I omit purposely the practice followed in the growth of those huge specimens which have almost invariably been exhibited at our leading metropolitan shows. The groundwork in their case is furnished by cutting away at the base the entire growth of a strong plant of one year old, and afterwards encouraging but one shoot, which, aided by the mass of ready-formed roots at the bottom, makes a prodigious plant. I consider well-grown well-flowered specimens of smaller dimensions far more suitable to the generality of gardens, and, indeed, of greater merit generally than those monstrous half-standards formed as above.

I will now confine my remarks to a more general mode of practice in the growth of the Fuchsia—namely, keeping plants of last season's flowering for use the next season. When these have done flowering place them in a cool, dry situation, and if partly dark it does not matter; then by withholding all moisture from them they will soon shed all their leaves, which should be carefully removed. Leave the plants thus until about the middle of February, but in this be guided by the season at which they may be required to be in flower; then they should be properly potted and pruned, first cutting away all superfluous, misplaced, and decayed wood. In pruning it will not be necessary to leave more than two joints if well placed upon the wood formed last summer, excepting it be the best-placed shoot chosen for the leader, when a little judgment will be necessary in cutting it back to secure a proportionate top to the whole.

The pruning having been performed take the ball carefully out of the pot, remove the soil from around the roots, and pot the plants again, placing them in as small a sized pot as they can easily be put into without undue pressure.

The soil, half leaf mould, half sand, with a little sifted loam, must be properly placed around and between the roots so that no empty space may remain. To prevent this take hold of the plant firmly with one hand and continue to jerk it slightly up and down whilst you continue to supply loose soil with the other hand, after which stamp the pot gently down upon the bench.

The plants should then be placed for a time in any cool dry situation where they will receive light. The fresh soil in which they are potted should be moderately moist: consequently no water should be given until the soil is becoming dry, when it should receive a good soaking. The main object should now be to induce the plants to root as freely as possible, using at the same time every means to retard any corresponding activity in the stem, and thus prevent the pushing forth of the buds. By this means, if the rule is properly observed, the plant is enabled to collect strength for a vigorous growth.

The moment signs of activity are discernible in the buds expose the plants fully to the light. When well started give them successive shifts as they may require into a soil similar to that advised; previously adding, however, in this instance, as the plants increase in vigour, more loam and less leaf mould and sand. Give the necessary attention to pinching-back and to syringing, as these old plants will be especially benefited by having their matured wood kept soft with moisture.

As a climber, at least so trained to rafters in a conservatory or greenhouse, the Fuchsia forms a very pleasing artistic object; indeed in this position it would seem to be

quite at home. The good and useful old *Souvenir de Chiswick* does admirably when so grown. If planted out, plants are readily induced to grow tolerably early by giving them water in February and an occasional fresh supply until about midsummer, when, if water be altogether withheld, they will shed their leaves naturally, and, like Vines, remain dormant during winter.

As a bedding plant the Fuchsia has also figured in our gardens, the variety *Tom Thumb* having been used for that purpose, but I think the plant is not very applicable to our present system.

The Fuchsia is readily grown from seed, which should be sown in a pot or pan of finely sifted soil, covering it but very slightly, and making the surface even and firm by pressure with the bottom of another pot. Place the seed-pot in the full sun, and then take care to shade it by a piece of painted glass, brown paper, or other handy material whenever the sun shines too brightly, and carefully keep the soil moistened. A moderate temperature will be best. The seed does not at all times germinate very readily, taking sometimes from six to ten weeks to show signs of growth. The after-treatment varies little from that required by most tender greenhouse seedlings. Care should be taken, however, not to give them, under any circumstance, too large a shift during the first season.

I add a few of the varieties which I think have the merit of good habit, and average good blossoms combined.

Comet	Minnie Banks
Count Cavour	Fair Oriana
Lord Elcho	Senator
Lord Macaulay	Madame Cornelissen
La Crinoine	Princess Alice
Dr. Livingstone	Lord Clyde
Fairest of the Fair	Schiller
Little Bo-Peep	Flower of France
White Lady	Annie

—W. EARLEY, *Digswell*.

PREVENTING THE GOOSEBERRY CATERPILLAR.

SOME eight or ten years ago I obtained a complete victory over the Gooseberry caterpillar in my garden, by adopting a hint given in the then *COTTAGE GARDENER*, and covering the surface of the soil with spent tanner's bark or "tan," as it is usually called, to a depth of 2 or 3 inches. By adopting this precaution about this time for two or three seasons I entirely got rid of this pest, but, having neglected it during the past few years, the nuisance has returned. I have, therefore, just laid a thick coating of tan under my Gooseberry and Currant bushes, and doubt not that it will again prove a "perfect cure."—A DEVONSHIRE BEE-KEEPER.

PITS FORMED OF CONCRETE.

IN a recent Number Mr. Fish gave instructions respecting turf-pits, and I write not to find fault with him, or with anything that he has written, for I regard him as an authority, but to mention an idea that a much better pit might be made, at a trifling cost, of concrete, especially in some districts where the materials are cheap.

It may be doubted by some that such cannot be done, but I know of some cottages where the party-walls are of concrete. All that is necessary is that some boards should be placed on each side of the intended walls.

My first reason for thinking concrete pits would be better is that they would be more lasting. Secondly, there would not be the trouble of the grass and other weeds growing on the walls, and, if not constantly kept in check, darkening the pit and harbouring myriads of slugs, snails, &c. Thirdly, you might whitewash the inside, which would be preferable to the dark damp walls of turf. It may be objected by some that they have not room for pits of this sort, as, of course, they must be permanent to pay; but I see no difficulty in the matter, as they might be built so that a common box might be put on, and filled up with hot dung, previously prepared, for a hotbed, and the pit itself be entirely out of sight.

I would recommend drain-pipes to be placed in the walls, as they would help to keep the pit dry when used as a cold pit; and, on the other hand, when in use as a hotbed they

would communicate the heat from the outside lining to the inside bed, only in the last case I should say that a greater number of pipes would be required.

Where boxes are plentiful the pits might be made large enough to take a box inside with about 8 inches clear space all round, to be filled in winter with sawdust or dry tan, which would be much better than the trouble and the litter of putting a lining of cold dung.—JAMES GLASSCOCK, *Beddington Park*.

[Of what materials and in what proportions is the concrete made?—Eds. J. OF H.]

FRUIT TREES IN POTS.

As to the flavour of fruits grown in pots and in the open air, I tried the other day some Apples—Calville Blanche, St. Sauveur, Northern Spy, and Melon Apple—and established a jury of my children, who are the best judges in these matters; but they preferred unanimously those grown in pots. It was quite the same with Peaches and Nectarines last summer. But I confess that I turn out my pots into the open air for a month or two in summer in a sheltered place, and consider this to have a favourable influence on the colour and flavour of the fruits.

I am very much satisfied with the result of grafting Peaches, Nectarines, and Apricots on the Sloe for pot culture. The trees are of a healthy growth, and fine roots, and are more easily managed.—H. B.

PRUNING OF PYRAMIDAL PEACH TREES.

SOME few years since, being much charmed with the idea of cultivating the Peach tree as a pyramid (suggested, I think, by the gentleman who figuratively thrusts his horn into the little heaps of gossip collected by your friend "D.," and tosses them about to amuse himself), I commenced that description of culture by having some trees potted—*i. e.*, planted in pots—for that is the correct way to describe it—and others planted in the borders of my orchard-house. I am delighted with my perfect success in both modes of culture; and, as a matter of course, I have gained some experience which I am happy to communicate to those who, like myself, thoroughly enjoy the culture of fruit trees under glass.

I found pinching-in the young shoots of my pyramids in the first year of culture to answer perfectly. The second year it was equally so with the trees in pots—in short it continues so with them to this day. This is the fifth year of their culture, and I can see no reason why it should not go on for many years, for no method can be more beautiful and satisfactory. With my pyramids planted in the borders of my orchard-house I have had some little trouble, owing to their vigorous growth (in spite of occasional root-pruning), and constant "inclination of sap to the head."

When pruning them to-day I found their stems pretty well furnished with branches full of blossom-buds; but they are weakly and very unlike the crowns of the trees, which, from being pinched-in all the summer, are masses of well-ripened, robust, blossom-bearing shoots, by far too much crowded. I have, therefore, felt called upon to perform some desperate amputations with my strong, sharp, pruning-knife, done in this way: I have cut out the central or crown branches of every tree, so as to leave it with almost a flat head. This will tend to give the lower branches more strength, and the sun will have more access to the fruit. I have indeed reason to believe that with trees planted out in orchard-houses, either half-standards or standards, this open flat-headed style of pruning will be found the most eligible. I have tried another way, besides summer-pinching, to restrain the too vigorous growth of Peach trees planted out. This is described in the "Orchard-House," 11th edition, p. 82:—"In 1862, and again the past season, 1863, buds of some kinds of Peaches and Nectarines were much wanted for propagation. I therefore allowed some of the trees to make their first growth without being pinched. The shoots they made were most vigorous, many of them from 4 to 5 feet in length. About the middle of July these were all cut off to within 4 inches of their base. The trees were loaded with fruit, and I thought that this sudden

decapitation would put the crop in peril, and cause it either to cease to grow or drop off in its then immature state. To my surprise the fruit has grown to its full size and ripened well. The decapitated shoots have put forth numerous young shoots, which this day (August 30), have been pinched to within three and four leaves of their base, and the trees look as they did last autumn—healthy, promising, and capable of bearing a good crop next year. I observe that their growth seems much more under control than those planted in the same border that have been under pinching all the summer." I have slightly deviated from this method, and have pinched all but six or seven strong shoots, leaving them to grow without control. Their vigour is most remarkable, and they exhaust the tree of much superabundant sap. About the third week in July they are cut down to 5 or 6 inches; the buds at the base of each shoot break immediately, and form short spurs which ripen well during the autumn.

By this method my planted-out pyramidal Peaches and Nectarines have formed themselves into flat-headed half-standards, slightly feathered down their stems with branches rather weakly, still fruitful. These will in the end die off, and leave the trees half-standards with open heads inclined to horizontal growth. As far as I can see this is a most excellent mode of cultivating Peaches and Nectarines under glass. Among these trees, if there be sufficient room, trees in pots may be placed: and these, if pyramids, may be formed into perfect fruitful "cordons" by summer pinching.

I have to add something rather curious, and which I confess is at present a mystery. In 1860 and 61 the fruit from the trees in pots in the same house was much superior in flavour to that from the trees planted out. This I accounted for from the roots of the trees in pots being in a warmer medium surrounded by the heated air of the house. In 1862 the fruit from the trees planted out was decidedly superior to that from the potted trees; but to my surprise, in 1863, although we had a bright warm summer, it was just the reverse, for the fruit from the potted trees was infinitely richer than any gathered from the trees growing in the borders, and I felt at a loss to account for it.—D., *Devon*.

TOUGH SEA-KALE.

IT is not my intention to speak of the culture of that useful vegetable, Sea-kale, but only to offer a few remarks on the cause of its being sometimes tough, though dressed by an experienced cook. When this is the case the gardener is blamed, and he on his part very naturally thinks that the Sea-kale was not properly boiled. Both parties may maintain that they are right, though they may be equally ignorant of the real cause of the fault. Until lately I was so myself, but having paid some attention to the fibre of several plants, I was somewhat surprised to find so much of that useful material in Sea-kale. This may be easily perceived by the quantity of fibre in the stem of a Sea-kale leaf, which I have sent with this paper. I now consider that tough fibre is the sole cause of the complaint, and that the only remedy is to try as much as possible to have the fibre in Sea-kale brittle, by forcing less of the crop at one time, otherwise it will strengthen with age, although well secured both from light and air. Supposing the pulpy substance to be separated from a dish of such Kale, what remained would somewhat resemble a handful of wet tow; certainly not an agreeable mouthful.—J. WIGHTON.

[The bundle of fibres sent by Mr. Wighton are certainly most strikingly hard and tough.]

SULPHUR VERSUS RED SPIDER.

I HAVE tried the effect of sulphur on many occasions with a view to the destruction of red spider and have never found it effectual. Even if placed upon heated flues or mixed with hot lime, so as to injure the foliage of plants, the most that it has done is to stupefy the insects for a time, but they soon recover their vitality, as wasps do when exposed to the atmosphere after suffocation by gunpowder and sulphur.

I have also tried impure or unrectified naphtha, which

quickly destroys the insects brought into close contact with it; but it is injurious to vegetation, very disagreeable, and not effective in a large house or where the Vines are at a distance from the vessel which contains the spirit. Tobacco smoke is useless.

The only remedy known to myself is gas tar, and applied in the following way it will annihilate the pest. Cover about 18 inches square of the hottest part of the flue with the gas tar at night, and if the weather is cloudy keep the house closed the following day, if not, cover the roof with mats, and most of the insects will be destroyed, and if the flue is well heated the second night and the house kept shut up the next day they will be all killed, and the foliage of the Vine will not suffer. Another and, perhaps, a preferable plan is to put a small quantity of the gas tar on a slate or piece of iron, or in a vessel, as it can then be removed from the house when done with, and no smell will remain.

This remedy must not be used when the Grapes are nearly ripe, or their flavour will be affected.—NEMO.

ECONOMIC HEATING.

THE winter, now over I hope, has been, perhaps, one of the most trying that we have had for several years past; for, although it has not at any time been very severe, the absence of any sun for such a length of time, with a thick heavy atmosphere, made firing both night and day a necessity, and, no doubt, has caused many besides myself to study the economy of heating, particularly where fuel is expensive. I was led into considering and also trying to make a practical use of the system I am about to explain from the application of a friend whom I was particularly anxious to oblige. He was desirous of heating a greenhouse, and also to derive from the same fire by some contrivance sufficient heated air to supply a Turkish bath adjoining. This could only be accomplished by some modification of the Polmaise system, and knowing its successful working at Dropmore, I made application to Mr. Frost to allow me to take plans, which was not only readily granted, but Mr. Frost himself gave every explanation I could desire. These explanations, with the plans, I have much pleasure in placing at your disposal, if you consider them sufficiently interesting to the readers of your Journal.

It may be as well at once to state, that I feel convinced that it is utterly impossible to find any other system of heating more economical, and at the same time affording such a complete command of almost any amount of heat in the houses with a very small consumption of fuel.

One of the houses heated in this way is a large early vinery, the other a span-roofed plant-stove; they are both exactly on the same construction of flue, &c., and I have therefore sent a drawing of the stove as likely to be the most useful.

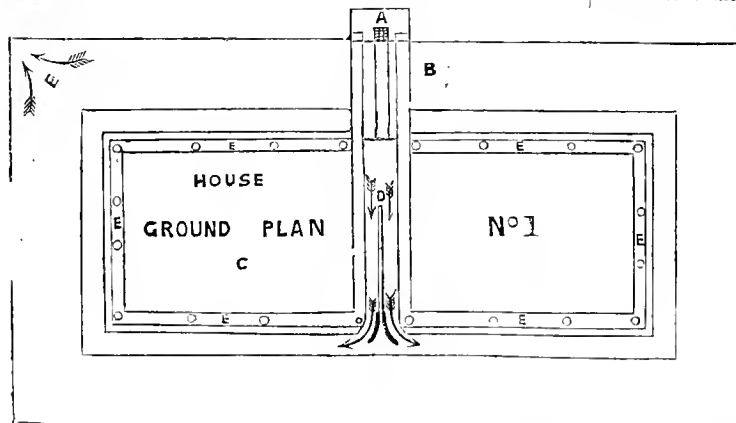

It will be seen by a reference to the ground plan No. 1 that a is the fire-hole, the flue passing under the path b, and under the pit c, in the middle of which a division is introduced at d; one half of the flue then goes one way, the other half taking the opposite way round, and both meeting

again at e, and dropping under the path, go outside into the chimney.

We will now commence again at A; and in the woodcut No. 2, on each side of the furnace-door, is shown on a level line with the grate a ventilator with either a slide or some



other contrivance to shut or reduce the air to be admitted at pleasure. This fireplace is outside, and, therefore, the air passing in is always pure; but although there is an advantage in this instance, there is no reason why it should prevent others from adopting other methods of securing the air pure where it does not, as in this case, exist. For example, the air may be brought from the outside of a shed, the top of a house—in fact, from anywhere most convenient; the fire will soon draw it in very forcibly.

No. 3 is the flue going right across the house, underneath the bed, from which it will be seen that the flue e, except at the bottom, is wholly surrounded by the air admitted by the ventilator shown in No. 2. This air as it passes along becomes thoroughly heated, and in this consists the economy. First, it will be readily admitted by any one who has put up flues that to carry this across the house as shown, would, in any case, be the best way to make the flue draw, because when hampered with a rise near the fire all draught is stopped. If this is admitted, we must also admit that all, or nearly so, of this heat is lost in the ground. Or suppose, for the sake of comparison, the flue to be raised to the level above the path b in plan No. 4, still the greatest amount of heat

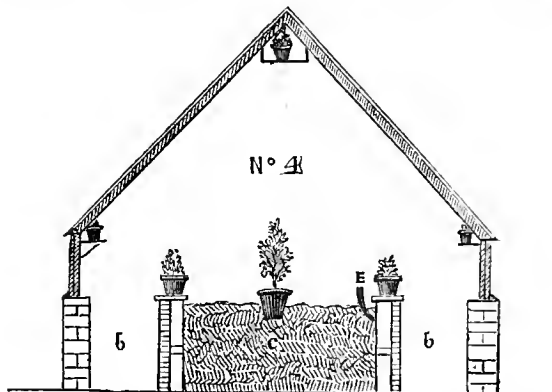

is buried underneath the path. All this heat is gathered up, so to speak, by the air that passes in round the path. Its effects I will explain by-and-by.

In the section of the house, No. 4, it will be seen that between the flue and the four-inch wall of the plunging-pit is a cavity—this is still the air-flue—and that e in plan No. 1 and this plan, No. 4, are the same. They consist of one-and-a-half-inch zinc pipes, and are each fitted at the top with plugs, which can be taken out or put in as required.

There is no doubt that many will say that to admit this dry hot air into the house will kill everything. But no such effect is occasioned, although the air from the pipes nearest the hot part of the flue is, in very cold weather when the fire is driven on a little extra, sufficiently hot to scorch a tender leaf; but the latter must be directly over the pipes to suffer. The air is soon dispersed without any

injury to the general plants in the house, which have all the healthy green appearance which the most fastidious could desire. They also consist of a sufficient variety to be a proof—Cucumbers, Pines, general stove plants, Dwarf Kidney Beans, Strawberries, small seedlings, &c.

Again: if the weather causes a brisk fire, the plugs nearest the fire may be left in, only taking those out where the air has further travelled; but this can scarcely occur, for the small amount of fire required makes the greatest caution necessary at all times to prevent the house becoming overheated. For example: if I do not mistake the date, on the 22nd of February, I found the thermometer outside at 12°, whilst, with a very small fire, the house was at 50°. Mr. Frost removed a few of the plugs, and in twenty minutes the house stood at 90°. The dry heat is also soon reduced by pouring water down one or two of the pipes.

Of course, this is Polmaise simplified; but I have no hesitation in saying that amateurs applying this system to their small houses would find that with a small fire and a shortened damper, the bricks once warm would only require attention once in twenty-four hours whatever severe weather might occur.

Again, for large orchard-houses, suppose we even say they enclose half an acre, if the tubes were carried up to the bottom of the rafters, the air rushing into this house would keep up a circulatory ventilation, and the amount of heat required in that air would be very small indeed to keep out any amount of frost.

Great care is necessary in making the fire part of the flue to prevent any smoke escaping into the air; also, as before mentioned, to make the dampers 2 or 3 inches shorter than the frame, so that the vent cannot at any time be entirely stopped.—F.

BULBS IN POTS.

ANY of your readers happy enough to possess an orchard-house, may make it "beautiful exceedingly" by doing as I have done. In November I had some large pots (11-inch), filled with loam and rotten manure, equal parts, to which I have added a little sand. In filling the pots the compost was made firm by ramming it with a blunt stout stick, and previous to filling some crocks or pieces of broken pots were placed at the bottom for drainage. When filled to two-thirds of their depth five Hyacinths were placed in each pot something after this manner—

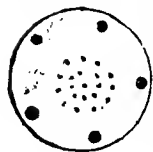

The edge of each bulb was about 1 inch from the inner edge of the pot. In the centre I placed a score or so of Crocuses (their position is shown by the small dots), and then the pots were filled nearly to the rim with the compost which was pressed down with the hand. The central group of Crocuses has been in bloom the last

month or so, and now that the Hyacinths are showing their grand spikes of flowers, the effect is quite charming. With some of the pots I have made a little variation, having planted the centres with some dwarf double and single Tulips. These will bloom about the same time as the Hyacinths, and I can see the effect of the whole will be very gay. It is, of course, too late to do all this now, but your readers must "make a note," and do it next autumn. Owing to the mild and most agreeable climate of an orchard-house, the bulbous flowers referred to continue in full beauty for weeks.—HYACINTHUS.

ALOCASIA METALLICA WITH MORE FLOWERS THAN LEAVES.

ALLOW me space in the columns of your Journal to offer a few remarks as to the management of the well-known and highly-esteemed *Alocasia metallica*.

Some ten days ago I had occasion to visit a few of the leading gardens in this neighbourhood, and at two places I observed a plant of the above, and was very much surprised to find the two plants running to flower and not producing foliage. One glance was sufficient to indicate that they were not properly potted, but if the following materials and mode of proceeding had been adopted the result would have been satisfactory. Select a good clean pot according to the size of the plant, allowing a liberal shift, crock fully one-third, but take great care not to throw the crocks in wholesale, as some gardeners do. Having that done break good fibry peat as large as eggs—say one-third, the same

quantity of good, fresh, fibry loam, and one-third sphagnum cut as short as you possibly can with a wool-shears. Add a lot of broken potsherds, mix well together, and if a little silver sand can be given so much the better. The compost must be rough and open. Place the plant about 2 inches lower than it was before; pot firmly; and the last inch of compost should be nearly all sphagnum, a little silver sand, and small potsherds mixed, this will encourage suckers to start. Place the plant, or plants, in a warm moist stove, syringing occasionally. Shade for a few days after potting if the sun is bright.—J. B. M., Co. Dublin.

PORTRAITS OF PLANTS, FLOWERS, AND FRUITS.

HELICHRYSUM MANNII (Mr. Mann's Helichrysum).—*Nat. ord.*, Compositæ. *Linn.*, Syngenesia superflua. Who does not even in his nursery days remember the "Yellow Everlasting" on the mantle-shelf? and Sir W. Hooker says that "the present noble species, if it can be retained in our gardens and increased, may revive the taste for the genus." It is a native of Fernando Po, and the Cameroon Mountains, at heights from 4000 to 13,000 feet above the sea's level. The numerous globose flowers, each an inch in diameter, are in a large corymb, the involucre or "everlasting" part is white tinged with green.—(*Bot. Mag.*, t. 5431.)

QUAMOCLIT NATIONIS (Mr. Nation's Quamoclit).—*Nat. ord.*, Convolvulaceæ. *Linn.*, Pentandria Monogynia. A tuberous-rooted perennial. A native of the Peruvian Cordillera. Flowers scarlet, stems run the whole length of the rafters of a greenhouse. "It may possibly bear our summers in the open air."—(*Ibid.*, t. 5432.)

SACCOLABIUM HARRISONIANUM (Mr. Harrison's Saccolabium).—*Nat. ord.*, Orchidaceæ. *Linn.*, Gynandria Monandria. Native of Pulo Penang, in the Chinese seas; imported by Messrs. Stuart & Low, of the Clapton Nursery. Flowers white.—(*Ibid.*, t. 5433.)

BEGONIA MANNII (Mr. Mann's Begonia).—*Nat. ord.*, Begoniaceæ. *Linn.*, Monœcia Polyandria. One of the Begonias with wingless flowers. Native of Fernando Po, at an elevation of about 1300 feet. Flowers rose-coloured.—(*Ibid.*, t. 5434.)

ADA AURANTIACA (Deep-orange-flowered Ada).—*Nat. ord.*, Orchidaceæ. *Linn.*, Gynandria Monogynia. Native of New Grenada, at an elevation of 8500 feet. Flowered in January.—(*Ibid.*, t. 5435.)

BARKERIA SKINNERI SUPERBA, a cool-house Orchid.—(*Floral Mag.*, pl. 185.)

POMPON CHRYSANTHEMUMS—*Firefly*, Anemone-flowered, bright orange scarlet; *Viola*, very double, violet lilac; *Lizzie Holmes*, very double, canary-coloured. All raised by Mr. Salter.—(*Ibid.*, pl. 186.)

COCCOSYPSILON DISCOLOR.—*Nat. ord.*, Rubiaceæ. *Linn.*, Tetrandria Monogynia. Introduced as long since as 1793, but now re-introduced to notice as a very effective plant for hanging-baskets. It is so employed at Farnham Castle and Dangstein. It is a native of the temperate mountains of St. Domingo and Jamaica. Its blue, berry-like flowers are in clusters on its creeping stems. We recommend it as a basket plant, and quote the following from the "Floral Magazine":—"We have been supplied, through the kindness of the Bishop of Winchester, with the following directions as to its cultivation, by Mr. Lawrence, his Lordship's intelligent gardener:—"It is," writes Mr. Lawrence, "as most of our most beautiful things are, very easily cultivated. I find from experience that during the summer months it will do better in a close greenhouse, near the glass, and fully exposed to the light and sun's rays than in a stove, as might be supposed from its being a native of the West Indies; but on the approach of autumn it requires more heat, both to bring its flowers and its beautiful ultramarine berries to perfection,—the latter lasting in their brilliancy during the whole winter. It will thrive during the winter in any house where heat is used, such as a Cucumber or Pine-pit, or intermediate-house. The propagation, also, is very easy, as it grows equally freely by seeds or cuttings. When planting it in the basket, I first line it with moss, then fill it up with an ordinary compost of loam, leaf mould, and sand; when the plant begins to grow freely, I peg the

shoots over the surface until it is thoroughly covered, then it will throw enough shoots over the edges to make a fine mass, otherwise it will look straggling and poor."—(*Ibid.*, pl. 187.)

HYBRID PINKS.—*Striatiflorus*, crimson flakes on rosy crimson ground; *Marie Paré*, white; *Rosette*, salmon pink.—(*Ibid.*, pl. 188.)

CHRYSANTHEMUMS.—*Prince Alfred*, pearly white tinged at the base with peach blossom; *Princess of Wales*, rosy purple—both first-class flowers, brought out by Mr. Salter.—(*Florist and Pomologist*, ii., p. 49.)

PEACH TREE CULTURE.

IN open-air Peach-culture many things have to be contended against, and, like many other things even in general practice amongst professional men, opinions differ very greatly upon this subject; and the more it is kept before the public, the more likelihood is there of this important subject being thoroughly ventilated. Ever since I made my first acquaintance with Peach-culture, which was in the north of Scotland, I have had a deep impression on my mind that atmospheric influences are to a very large degree at the bottom of all the failures to obtain good wood, without which, as the foundation of health and vigour, and consequently productiveness, no good results can be obtained.

Where I obtained my first lessons upon Peach-culture there was a Peach-house in the old style. A flue went round the house as the means of heating. Some trees were planted about a foot from the flue, in the front of the house; these were trained backwards upon a low trellis, which almost formed a quarter of a circle. A few riders were planted against the back wall; and overhead, under each rafter, was a single Vine-rod. I never knew this Peach-house come short of a very fair crop of Peaches, and it likewise yielded a very fair crop of Grapes. These trees never attempted to throw up suckers from their roots, and no doubt this arose from the healthy atmosphere in which the trees were kept. In the same garden there were a few Peach trees close by this house, without any glass protection. They were fastened to a trellis against the wall, and always presented a miserable look. Mildew seemed to be their constant companion, even with all the washings and syringings which were bestowed upon them, and yet their roots were active and healthy enough.

We have on record much about the attempts which have been made in this country in order to cultivate the Vine in the open air, sometimes as a profitable speculation, at other times as a private experiment. Well, the question is, Do results justify a continuance of this practice as regards the Vine? True, we have a few sorts of Vines which will, in favourable positions and in good seasons, yield some very creditable fruit; but because of this, who is there bold enough to advocate its general adoption as a means to supply the general demand for Grapes in private establishments, besides the ever-increasing demand which there is in London and elsewhere for hothouse Grapes?

Now, whether is the Peach tree or the Grape Vine a native of the warmest country? We are told the Peach is a native of Persia and its adjoining countries; and is not the present race of our most delicious and useful Grape Vines natives of countries much colder than the subtropic, hot, and often arid Persia? And yet it has been conceded long ago, if we are to have a regular supply of good Grapes, and worthy of the name, we must build houses on purpose for them—even admitting the greater encouragement which there is to do this, arising principally from the accommodating qualities to position and circumstances which the Vine, it may be, has over every other fruit-bearing tree.

It may be said, Even with glass you cannot extend the season of Peaches to one-half the length of time which the very good Grapes are to be had. There can be no serious objection upon this point, as of course there would not be a corresponding amount of expense. And, again, it is a very short-sighted policy and argument (if argument it may be called), to set a Peach-house down as not convertible to any other use than Peach-culture alone. Why, in the majority of gardens, especially where flower-gardening has been entered upon with zest, where can plants for flower-garden

decoration in summer be more conveniently sheltered and hardened-off, as it is termed, preparatory for their summer situation? While you are regulating your peachery as to air and moisture you are attending to the very things most conducive to the health and proper development of your flower garden, both agreeing well with the same treatment. I have no hesitation in saying it would soon repay any nobleman or gentleman in the course of a few years for the bringing forward and protection afforded to the flower-garden plants during the spring months, and this would more especially be the case where early effect is desirable. From a Peach-house eight or ten thousand good plants in three or four-inch pots, such as will start right away at once might be kept. I have said eight or ten thousand plants, but many establishments throughout the country will turn out from three to six times as many in number; and for want of proper convenience to bring these plants forward and to harden them off are obliged to resort to all manner of conceivable makeshifts. To do this in a well-arranged Peach-house would not be the least injurious to the Peach trees, as by the time the Peach trees were in full leaf these plants would have made their growth, and, again, many of them would be able to be placed out of doors in favourable positions.

I have spoken of Peach trees; although often presenting a very unpromising look, yet, when their roots have been examined, they generally are found pretty good. In a garden where I was some years ago, they had a row of very high Elm trees at about 6 yards off behind the wall. Before I went there they could not get the Peach trees to do well. I found those Elms had intruded their roots under the garden wall, and then rising up almost close by the wall to just under where the Peach tree roots were, and at other places in this border these Elm roots were in quite a net-like mass along just below where the spade dug down to; of course, no Peach tree could do well while situated so. I had all the roots of the Elms cut, and got some of the trees down at one end, but the other portion were not permitted to be thus dealt with.

I had some young Peach trees planted, and I kept lifting them every year during some time in winter for seven years. They had quite a web-like appearance of roots, nothing could be healthier. They had a very good border well drained. I covered or mulched their roots during the heat of summer, kept syringing them well, sometimes with weak tobacco water, and sometimes with weak manure water, whenever it was thought any of the small pest were likely to appear, but with all my care I was doomed to disappointment. I could obtain excellent roots, and by my lifting them I secured their being near to the surface, so they might derive as much atmospheric influence as possible, and thus assist, as far as could well be done, the early and well ripening of the young wood; but I am sorry to say I was often sadly grieved to witness all my care and anxiety of no avail, mildew and blister would sometimes in a few days lay fast hold upon several branches, then good-bye to fruitfulness. So long as I could manage to get any of the young trees to grow away pretty well, just so long would the stocks keep from throwing up suckers, and no longer. I tried some Peach trees in the same garden upon trellises at about 18 inches on the south side of the walk running in front of the Peach wall, and much the same results were obtained. One season, perhaps, they came off pretty well, but in general the next season following would make sad havoc upon them. Such disappointments and annoying results I have not yet witnessed take place under glass.—G. DAWSON.

"THE ILLUSTRATED BOUQUET."

PARTS 16 and 17 of this very beautiful serial are fully equal to their predecessors, and are creditable alike to the artist, Mrs. Withers, and the proprietors of the publication, Messrs. E. G. Henderson & Son, Wellington Road Nursery, St. John's Wood.

We can but glance over the contents. *Double dark-rosy Chinese Primrose*, beautiful, and its flowers available from November to the end of February. *Fuchsias*.—*Princess of Wales*, sepals coralline red, corolla violet blue; *Emblematic*, sepals crimson, corolla lavender blue; *Mademoiselle Tietjens*,

sepals white, corolla bright rose—all specially adapted for conservatory decoration. *New Bedding Pelargoniums*.—Madame Rudersdorff, salmon margined with white; Beauty, white with salmon centre; Alexandra, magenta-tinted rose. *New Pompon Dahlias*.—Fireball, orange scarlet; Meteor, golden yellow; German Daisy, shaded rose; Fairy Child, crimson with white tips; Crimson Dwarf, red crimson. These vary from 1½ to 2½ feet high. *New Isoras*.—Acuminata, white and fragrant; Crocata Superba, salmon red. *Alocasia Lowii*, now so well known by its glossy bronzy-green leaves, and large white nerves. *Early-flowering Bedding Tulips*.—A group accompanied by a very full list of them, classified according to their colours, with directions for their culture. *Methonica grandiflora* and *Plantii*, the first yellow and the second orange red. *Agapanthus umbellatus albiflorus*, white-flowered. *Dipladenia Houtteana*, flowers rose-coloured, and the whole plant slender and graceful, of twining habit, and suitable for pot culture in the stove.

WORK FOR THE WEEK.

KITCHEN GARDEN.

HAVE the edges of walks made good throughout; and the walks themselves, if the gravel is of a loose texture, should be turned and raked about in dry weather, for the destruction of weeds and moss. The operation of surface-stirring amongst advancing crops must be persevered in while the present dry weather continues. *Asparagus*, see that the ground is in readiness for this, as also for Sea-kale and Klubarb, which should be planted soon. These require a deep rich soil, which should be trenched 2 feet deep, with plenty of rotten manure well incorporated with the bottom spit. Indeed, the ground can hardly be made too rich, particularly for *Asparagus*. This, when planted in well prepared soil is very productive, yielding a vast quantity of fine, strong shoots every season; whereas if planted in poor, shallow soils, no after-attention in the way of surface-manuring and watering with manure water, will serve to secure first-rate heads, and it is so much esteemed in most families that the trouble or expense necessary to properly prepare the ground should not be complained of, particularly as beds well made last for many years. *Beans*, earth-up growing crops, and continue sowing for succession. *Broccoli*, as the time for sowing the principal crops of winter and spring sorts, and also Greens, is now at hand, select, if possible, an open piece of ground, rather poor than rich; let the seed be sown thinly, and when large enough to handle prick out on a similar soil. As the future growth of the Cabbage tribe depends much on not being drawn when young, some attention should be paid to this point when they are in a seedling state, for the best after-culture barely compensates for the first neglect. *Celery*, that sown early in boxes will soon want pricking-out. The old plan is very good—viz., some very rotten and mellow dung on a hard bottom. On this the plants, pricked-out 3 inches apart, will produce many fibres, and will remove with the trowel in balls with the most trifling amount of check. The chief reason why *Celery* “runs,” is when sudden luxuriance is succeeded by sudden checks. The buttoning of the Cauliflower is also most probably traceable to the same cause. *Capsicums*, pot off as soon as they are fit. *Herbs*, sow seeds of them and other vegetables that may have been omitted during former weeks. Remove all litter and weeds. Earth-up early crops, strewing a little soot about them to prevent the attacks of slugs. Protect recently-sown seed from the ravages of birds by a covering of nets or twine.

FLOWER GARDEN.

Now that the ground is sufficiently dry, hardy annuals may be sown, and if judiciously distributed about the pleasure ground they will materially aid in its embellishment. Lightly fork and rake the surface soil of herbaceous borders to prevent the growth of weeds, and to give them a fresh, neat appearance. Make new plantations of Russian double blue and double white Violets; for this purpose select the young runners, but give the preference to seedlings of the Russian Violets, they make stronger plants, and flower more abundantly than offsets. Remove all litter and covering that have been used for affording protection during the winter. Neatness should now be the order of the day.

Bring speedily to a close the laying-down of turf, and the planting of deciduous and evergreen shrubs.

FRUIT GARDEN.

The season for disbudding fruit trees is fast approaching. The importance of this operation is generally acknowledged, and upon its proper performance mainly depends the production of clean healthy wood of proper quality. Take, for instance, a single branch of the Peach tree: when it first starts in the spring, if in a healthy fruit-bearing condition, it will throw out probably fifty wood-buds; if the whole of these were left on, it is probable that some two or three of the leading shoots would take the lead, and, drawing all the nourishment to themselves, would become rank and over-luxuriant, whilst the remainder would be weak and the fruit small or abortive, hence the necessity and importance of disbudding. Supposing the trees to be operated upon to possess from eight to ten branches of young wood springing from the centre, the object proposed to be obtained is that the branches may not only elongate themselves to a greater circumference, but also produce healthy branches from the centre, and this is attained by removing at four different thinnings every shoot but the terminal one, and the one nearest the base on the upper side of the shoot; if this were done all at once, the trees would be injured, but from being done at intervals, the shoots to be left acquire sufficient strength to absorb all the nourishment the trees can give, and the sap being thus equally distributed, no shoot will be able to take to itself an undue amount.

GREENHOUSE AND CONSERVATORY.

During the continuance of cold easterly winds which we are now experiencing, air must be admitted with caution, opening the ventilators on the sheltered side of the house, and avoiding as much as possible the passage of cold drying currents over either plants in bloom or those commencing growth. Climbers beginning to push should after this time be frequently examined to prevent a confused growth; *Kenedyas*, if crowded, to have their shoots thinned. *Ipomoeas* and *Thunbergias* being subject to red spider should be well syringed to prevent that pest gaining ground. Continue a steady supply of heat and moisture to *Azaleas* out of flower. Shift and stake out *Cinerarias* and herbaceous *Calceolarias* as they advance. Shift *Camellias* out of flower, and keep them warm. Shift *Fuchsias* and thin the branches; put in cuttings of choice sorts. Heaths and New Holland plants to be regularly shifted as they advance, tie out and regulate the shoots. Propagate *Pelargoniums* for autumn flowering, shift them; stop and tie out the large plants.

STOVE.

Both heat and moisture may now be increased, and have shading in readiness to ward off sun-bursts which sometimes occur at this season. Shift *Achimenes*, *Gesneras*, *Begonias*, &c., and keep them in a moist warm situation; fumigate regularly, and use all means to check the increase of insects.

PITS AND FRAMES.

The cold store-pits will now be in readiness to receive those plants which have been wintered in other structures, such as late vinerias, &c.; the only protection they will require now will be a slight covering with mats or straw covers. Those who do not possess pits of this description should form some with other materials, such as turf, which makes a durable and excellent substitute, or a few boards may be nailed together, or some stakes driven firmly into the ground, and others nailed to them in a horizontal position, against which dry fern or straw should be placed. W. KEANE.

DOINGS OF THE LAST WEEK.

KITCHEN GARDEN.

THE weather having dried the ground a little, took the opportunity to sow part of the main crop of *Onions*, chiefly White Spanish. The ground which had been used for *Celery*-beds was well cross-trenched, so as to divide the dung in the bottom of the trench, was then ridged, north and south some weeks afterwards, and when frosted was turned over again. A few days before sowing the ground was levelled, slightly dug over, and when well mellowed on the surface was trodden and then raked; drills were drawn 1 inch deep, and 10 inches apart, and when sown the seeds were covered with

rather dry soil riddled. This came from beneath the potting-bench, and some soot and rather mild lime were mixed with it. This covering would not have been necessary if the ground had been dry enough for covering nicely; but it was rather wet and cloggy for the purpose, and in such a case the dry covering prevents the seeds being smothered up from air, whilst the moist ground beneath will give the seeds moisture enough to swell them, and bring on the germinating process. The sealing-up seeds, as it were, in wet, stiff soil, is one reason why many good seeds never germinate. Where such slight dry covering cannot be given, it is sound policy to wait until the ground is in first-rate order. There need be no particular hurry. Some of our best Onion crops were sown in the end of March. The back of a rake drawn over the ground left all in good order. A great point in good culture would be gained, especially in heavy land, if we would ever remember that in such land, when potted by working when wet, neither air nor water will pass freely through it for that season, whilst if worked dry the water from rains, however heavy, will pass freely through it, and leave its nourishing properties behind. Took the same opportunity to sow the main crop of Parsnips, and a piece of Early Horn Carrots. The *Parsnip* seeds were set in patches 7 inches apart, in rows 15 inches apart, and the Carrots a little thicker in the rows. We think the placing from three to five seeds in a patch permits of moving the soil about the young plants, and thinning them to one plant in a patch more easily than when they are sown regularly along the row. The Hollow-crowned and the Student Parsnip produce, perhaps, the largest roots, and these will come straight in old, rich garden soil, where Carrots, except the Early Short Horn, would be apt to come crooked and forked. This ground was trenched three spits deep, the poor soil at the bottom being brought to the top, ridged to make it mellow, and a lot of burnt clay and charred refuse thrown over it. This was in better order for sowing than the Onion ground, and, therefore, needed little extra dry stuff for covering.

Planted out some Potatoes that were previously sprung; also, a piece of autumn-sown Onions, besides the piece of Onions sown, planting them about 5 or 6 inches apart in the row. These are taken up carefully with all the roots possible, and are dibbled in so as to catch the roots, but scarcely a bit of the neck of the Onion. Thus treated they bulb much better than those left where they were sown. We have obtained large bulbs earlier by leaving the Onions where sown; but scraping the earth away from the necks. The transplanting, however, we consider the best plan. These sown early in September, owing to the mildness of the first part of the winter, are too large to do much good in the way of bulbing, but they will come in well for some time for some sorts of soup, for which bulbed Onions are seldom used, if young ones can be had, even if long necks. Sometimes when young Onions were scarce in winter, we have put large bulbs in a little heat, and as they grew stripped the scallions to the necessary size. We recollect a gentleman saying that he never tasted such beautiful Onions for salad, they were so sweet and mild. In such a case we do not think a little deception at all wrong. Started also the remainder of the *Shallots* not likely to be wanted for use. In such a case we take a well stirred piece of ground, firm it on the surface, draw shallow drills 10 inches apart—say half an inch deep, break the bulbs into their separate parts, fix them in the drills 4 inches apart with the thumb and fingers, and then cover the lower part of the bulb, and sprinkle over all with a little soot and lime to prevent worms, &c., pulling them out. So treated they will thrive on the stiffest ground.

Put more *Sea-kale* in the Mushroom-house, and placed some pots and boxes on some rows out of doors with a little litter over them, just to keep the frost from the pots. It may also be obtained very early without forcing, by placing mounds, 8 to 12 inches deep, of ashes, &c., over the crowns, and cutting the shoots when from 6 to 8 inches in length. When the ashes are thrown up a little they may want firming around the plant to prevent the light entering and greening the produce. Not but that the green heads, or green and white are not good, or even the green flowers a delicacy worthy of an epicure, but so long as the produce is preferred white, it must not be sent to table green. Put, also, some

Rhubarb-roots on the floor of a vinery, and will also put a hand-light over some to forward them out of doors, as otherwise the markets in the little towns round here would be inundated with Rhubarb from London and farther southwards before we should have it naturally many inches above the ground.

Gave abundance of air to early Potatoes, Peas, and Beans, some on turves for transplanting; run three cotton threads fastened to sticks 2 inches above the rows of Peas just coming through the ground, which seem as yet to frighten the birds from pulling them up. Saw some trace of mice, and sunk some pots half filled with water, and a little grease rubbed inside the pot an inch from the rim, as recommended by a correspondent the other week, but as yet have had no mice drowned. Perhaps the sight of the water has scared them. We have caught them the same way in houses, by sinking bell-glasses with a little water at the bottom, and slightly covered with scoured chaff.

FRUIT GARDEN.

Finished most of the pruning out of doors, and dug between the bushes in most of the small fruit-quarters. Those near a tanyard will find no plan better for keeping the caterpillars from Gooseberries, than placing a layer of fresh tan round the bushes; this seems to settle all the hordes in their incipient state of growth. In default of this, we have found it to be a good plan to scrape the soil all round the bushes 2 or 3 inches deep, into a ridge between the rows, fork over the ground thus scraped, and add a little more from the trench in the centre; if this scraped-off ridge is well buried, from 15 to 18 inches deep, it will pretty well settle all that may have life. Applied some thin paint made of clay, cowdung, soot, and lime, and laurel water, to help to keep the birds from the buds, and we shall be tempted to try threading the bushes over. Some Pear trees have pretty well had every bud picked off.

A lean-to orchard house did so well that we can hardly let well alone, but want to see how we could manage a few late Grapes planted out in it. We have therefore taken out a trench in front, nearly 4 feet wide, extra drained it, and filled with fresh soil, and will plant so thinly as not to interfere much with the standards, &c., on the floor of the house. With large squares of glass, and a common amount of sunshine, there need be no want of heat in summer and autumn, and provided air is given early, the strong heat will do little in the way of scorching or burning. In cold northern districts, we should decidedly prefer lean-to to span-roofed houses; but, in respect to both, we believe that much is yet to be learned by us as to making the sun do most of the heating work, whether we have a simple means of heating or not. We should certainly object to the name of orchard-house being retained, if supplied with any regular system of heating. Such a house is then a forcing-house, however constructed.

We are in hopes that we shall conquer the brown aphid or beetle this season, though it is yet too soon to say much about it. Relative to insects, a correspondent wishes to know why we put sulphur among clay paint for washing Vines, Peaches, &c., if we merely wish to clog up the eggs of insects; and he says that he has seen red spider as hearty and active among sulphur, &c., as if there was nothing on the shoots whatever. Well, we must say that so have we; and so far as the killing of insects is concerned, we do not believe that powdered sulphur has any effect whatever when at a temperature not higher than our common atmosphere. One use, however, of sulphur is that it is one of the best antidotes against all kinds of mildew, and even on this account it is worthy of a place in such mixtures. To act injuriously or unpleasantly on animal or insect life the fumes must be raised from sulphur by heat, and that heat must not approach the burning point of sulphur, or all vegetable life will likewise suffer: we should never like to have a higher heat given to it than 160° to 170° when it was at all fresh. Have hot-water pipes below rather than above that heat, and sulphur mixed with water at that temperature will send off fumes distasteful to all insect life. Thus it is that for warding off red spider the painting of the top of the back wall of a lean-to house and other parts directly exposed to the sun will do far more, in unison with a moist atmosphere, to keep off red spider than any painting of stems and leaves with the sulphur. Painting the back of

frames with a mixture of sulphur and a little soot and size will also be useful in keeping Melons and Cucumbers clean. When once the red spider gets hold it is very difficult to eradicate without injuring the crops. You may kill no end, but there will be fresh generations produced to mock you. We have sometimes thought that even burnt sulphur that settled the plants did not kill the insects; but in many cases closer inspection confirmed us in the opinion that most, if not all, of those we noticed alive had come into the world after the fumes of the sulphur had become weak. The vast numbers of the generations of these insects, thrips, aphides, &c., are frequently overlooked when we find fault with some general recipe not being effectual. First let green fly get a-head, and you may smoke and kill every one then alive, and yet in a few days you may have plenty more.

Washed a few shoots in Peach-house with quassia water, made by boiling a quarter of a pound of chips in a gallon of water, for killing a little green fly that had made its appearance. The same chips may be boiled several times. This liquor when used is as clear as pure water, and very bitter. At an eighth part of that strength it might be used moderately as a stomachic, and is supposed to form an ingredient in bitter beer, instead of an extra quantity of hops. We should think it as effectual for green fly as tobacco water weak, and not so unpleasant to handle. Disbudded Peaches, regulated Vines, shifted Strawberries in pots, &c.

ORNAMENTAL GARDEN.

Planted out a number of *Gladoli* that had begun to move, placing them in trenches about 6 inches deep, firming them in a layer of sand and leaf mould, and covering up carefully. Others will be planted as they shoot. In looking over the bulbs took off any small bits: if these are not larger than peas, and are set in shallow drills in the reserve ground, they will make tidy bulbs before the end of the season. Some changes and alterations in the pleasure ground must be delayed until the grass is firmer and drier. The same must also be the case as respects what remains to be done with herbaceous plants. As soon as time and weather permit will have all the edgings of beds, borders, and walks cut straight. This renders them easy to clip and cut for the season. No raw edging, however, should be long seen. Commence hardening-off all plants under protection as soon as possible. We are having a lot of prunings, &c., burning, so as to burn a lot of earth, clay, and char a lot of small rubbish. As soon as that is done and the ground is a little drier, we shall commence turning out our *Calceolarias* from the striking-pit into earth pits. We generally make up a heap of this burnt rubbish, leaf mould, and light loam, and it is thus made comfortably warm. When planting in rows we place a little of this along the rows and the roots, give a little warm water, and then finish with the common soil on the top. The little warmth sets the roots a-running directly.

Many are now in trouble how to thin their small houses of bedding plants, and perhaps have some scores of pots full of little cuttings all struck, for which they have no room were they to plant or pot singly, and yet they will occasion no end of bother if kept in pots as they are. The best plan under the circumstances is to water the pots well the day before, and then turn them out into a temporary bed with the balls pretty well entire, but surrounded with an inch or two of rough leaf mould and sandy loam. The roots will run nicely into this; and at planting-out time you may divide your plants, each well supplied with fresh roots, and demanding from this time to the middle of May a minimum of the attention they would have required when in pots. In mere cold temporary pits they will also do better than if planted out separately, as that might give too great a check just now. Of course all bedding plants thus turned out must be protected from frost. As often stated, but for the price, next to glass, the best thing is calico. Frigi domo is all very well, but it soon rots, and then it does not let so much light through as unbleached calico, as the brownest of it soon gets bleached, and in its natural state we believe it lasts longer than when dipped or steeped in some composition for preserving it. But for the appearance we believe we often paint wood to cause it to decay all the sooner.

We must get on with *Verbena* cuttings, thinning *Geraniums*, &c., as fast as we can, when other work will let us

get at them. Now, we could use more than double our conveniences and strength, and must cram a little, such as putting little pots on the surface soil of large ones. It was by such means and no end of attention and labour that our late lamented coadjutor, Mr. Beaton, filled the large flower garden at Shrubland, when the glass houses there were small in extent compared to what they are now. Will get *Dahlias* on the floor of a Peach-house or a vinery at work, to bring them a little earlier. A correspondent wishes to know how he can get a lot of dwarfs, crimson, yellow, and purple, as *Zelinda*, with the least trouble, and with no help but his greenhouse. Well, as fine rows as we ever saw were thus managed. The tubers were placed near the fire in the greenhouse, and covered slightly with leaf mould in the middle of March, and being damped with water at about 70°, soon began to push their buds and shoots. By the beginning of April the tubers were all cut up into pieces, each having a shoot an inch in length, or so, attached. A hard piece of ground was procured, an inch or two of leaf mould thrown on it, and the roots of the *Dahlias*, with one or more shoots each, were placed regularly over it from 3 to 5 inches apart, 6 or 7 inches of rough leaf mould and loam were then thrown over them, and by the middle of May the points of the *Dahlias* were appearing above the surface, and each lifted up with a ball of roots attached ready to go anywhere. Proceeded with shifting *Fuchsias*, greenhouse, and stove plants as we could get at them. Some of the *Fuchsias* just budding will go into the second vinery, some into the cold vinery, and others into the cold shed which can be shut up. From all the old soil will be mostly shaken away. If the soil had been dry the roots will be soaked before potting. This is better than watering much the new soil before the roots are running freely into it. In fine days extra evaporation from the young shoots is best prevented by a syringing, instead of much watering. A window gardener told us the other day his *Fuchsias* were moving, but all the young leaves dropped as soon as formed. The soil was waterlogged like a marsh. The plants ought to be turned out of their pots, the ball worked in a tub of water with the hands until all the earth is gone, the roots pulled through and stood five minutes in clear water, and then potted in much smaller pots, well drained, using sandy loam. In a week the new rootlets will be working and the new leaves stand up, with the help of a sprinkle of water from a clean hair brush in a sunny day, and in three weeks or a month the plants may get a larger pot and richer compost to bloom in. When plants have stood rather dry all the winter, but not so dry as to injure the plants, the soil will come away freely and not injure the roots. Even in their case dipping in water is better than saturating the new soil at first. The following as respects potting are essential to success:—See that the roots are moist, and if a ball is retained that the ball is moist before repotting. Give such plants a closer and a warmer atmosphere until growth is progressing freely, and neither over-water nor shade, if a skiff from the syringe will prevent flagging.—R. F.

TRADE CATALOGUE RECEIVED.

Ambroise Verschaffelt, Rue du Chaume, 50, Ghent, Belgium.—*Catalogue of New Plants, Stove and Greenhouse Plants.*

COVENT GARDEN MARKET.—MARCH 19.

In consequence of the fine weather the supply of vegetables is excellent, and the demand is also good. Greens are good and plentiful; *Radishea* have come in from Corwall, and consignments of Broccoli from the same quarter are kept up. White Paris Cos Lettuce of excellent quality are among the importations from France, and are bringing from 6s. to 8s. each. Endive, *Radishes*, &c., are also sent in sufficient quantity for the demand. Some good dessert *Pears* are still to be had, though both these and *Apples* are scarce. Forced *Strawberries* have begun to make their appearance. Cut flowers are the same as last week; some fine *Roses*, however, are new to be had.

FRUIT.

	s.	d.	s.	d.		s.	d.	s.	d.	
Apples..... ½ sieve	2	0	to	4	0	Nectarines.....	0	0	to	0
Apricots.....doz.	0	0	0	0	0	Oranges.....100	4	0	10	0
Figs.....doz.	0	0	0	0	0	Peaches.....	0	0	0	0
Filberts & Nuts 100 lbs.	0	0	0	0	0	Pears.....bush.	8	0	12	0
Grapes, Hothouse....lb.	15	0	25	0	0	dessert.....½ sieve	6	0	10	0
Foreign.....	1	6	2	0	0	Pine Apples.....lb.	6	0	10	0
Muscats.....	0	0	0	0	0	Pomegranates.....each	0	0	0	0
Lemons.....100	4	0	10	0	0	Strawberries.....oz.	1	6	2	6
Melons.....each	0	0	0	0	0	Walnuts.....bush.	14	6	20	0

VEGETABLES.

	s.	d.	s.	d.		s.	d.	s.	d.
Asparagus	8	0	14	0	Leeks	0	4	0	0
Beans, Broad	0	0	0	0	Lettuce	1	0	2	0
Kidney	100	2	0	3	Mushrooms	1	0	2	0
Beet, Red	1	0	1	6	Mustd. & Cress, punnet	0	2	0	4
Broccoli	0	2	2	0	Onions	4	0	7	0
Brussels Sprouts ½ sieve	2	0	3	6	pickling	0	6	0	8
Cabbage	0	0	0	0	Parsley	0	4	0	0
Capsicums	100	0	0	0	Parsnips	0	2	1	0
Carrots	0	6	0	8	Peas	0	0	0	0
Cauliflower	4	0	8	0	Potatoes	6	0	2	0
Celery	1	6	2	0	Radishes doz. bunches	0	6	0	9
Cucumbers	each	2	0	5	Rhubarb	1	0	1	6
Endive	score	1	3	2	Savoys	2	0	2	0
Fennel	bunch	0	3	0	Sea-kale	1	6	2	0
Garlic and Shallots, lb.	0	8	0	0	Spinach	2	6	4	0
Herbs	bunch	0	3	0	Tomatoes	½	0	0	0
Horseradish	bundle	1	6	4	Turnips	0	4	0	6

TO CORRESPONDENTS.

** We request that no one will write privately to the departmental writers of the "Journal of Horticulture, Cottage Gardener, and Country Gentleman." By so doing they are subjected to unjustifiable trouble and expense. All communications should therefore be addressed solely to *The Editors of the Journal of Horticulture, &c.*, 162, Fleet Street, London, E.C.

We also request that correspondents will not mix up on the same sheet questions relating to Gardening and those on Poultry and Bee subjects, if they expect to get them answered promptly and conveniently, but write them on separate communications. Also never to send more than two or three questions at once.

N.B.—Many questions must remain unanswered until next week.

NATIONAL ABRICULA SNOW (*H. C. Kingston*).—This is to be held at the Royal Botanic Society's Exhibition, on April 30th. Schednies and all particulars can be had on application to Mr. John Douglas, Davygate, York.

DILLSTONE'S EARLY PEA (*S. Libbey*).—It is a full week earlier than Daniel O'Rourke. We have no pods of it, but any London seedsman can supply you.

VEGETABLE KINONOM (*J. C.*).—Without any information relative to the audience, nor any as to your own acquirements, it is useless for us to advise you concerning a theme so vast.

GOLDEN HAMBURGH VINE FOR A STOCK (*J. H.*).—We have no faith in the Golden Hamburgh for a stock for any Grape. Consequently, if you have a Hamburgh growing on either side of it, we would recommend you to remove the Golden Hamburgh, and bring away a shoot from the Hamburgh, and inarch the Alicante on to it, putting green wood to green. If you have not a Hamburgh near the gap you want to fill up with Alicante, any other strong sort is preferable to Golden Hamburgh, but Black Hamburgh is the best.

GEOMETRIC FLOWER GARDENS (*A Recent Subscriber*).—In the back volumes of this Journal, and in "Flower Gardening for the Many" published at our office, there are more plans than can be found elsewhere. There is no especial work on such plans.

MISTLETOE PROPAGATION (*K. F., Amateur*).—It is not propagated by grafting but by the seed. This is inserted under a flap of the bark on the under side of the branch of an Apple tree. The flap is cut in this shape A, and the seed placed under it. No other attention is needed. Probably on most other trees, except those with resinous sap, the Mistletoe would thrive.

FLOWER-GARDEN PLAN (*T. H. M., Dover*).—We presume your beds are all on grass. As seen from the house there seems to be a want of balancing, and of ease and room, and very little connection between your centre of eight beds in a ring and those placed round them. No doubt they will look well when planted. Your four large clumps in the ring will look well, two pans planted with Tom Thumb Geranium, and Lobelia as edging, and two with yellow Calceolaria, and Perilla as edging. Of the four circles that separate these four larger beds from each other, we do not think the planting will please you, because, being mainly filled with dwarf Roses, these beds will look shabby from August, when the other beds are at their best. Of the various edgings you propose, we would do two of them with Flower of the Day, and two with Bijou Geranium, and place some of the same through the Roses; but do as you will the Roses will mar the late display. They would be much better placed in two of the outside clumps if there is no room for them elsewhere, such as at 15, which you could make into two or three smaller beds. The rest of the planting will do very well. In your proposed arrangement of 15 yellow Calceolaria would be better next the Ageratum, then a dark Calceolaria. If you adopted our suggestion then you might also alter the narrow ribbon-border thus:—Delphinium formosum, tall Scarlet Lobelia, Perilla, Flower of the Day next the grass. If your Calceolarias are sound and fresh, though not rooted, we would advise you taking them up and placing them in light sandy soil under a hand-light, or anything of that kind, and then you could give all the air you like to the plants that are struck; or if you have no glass to spare you might make a slight hutted, take the box and light from the Calceolarias, and defend them with mats, calico, or any other means on cold nights, and then your fresh bed would hold a lot more plants than your Calceolarias. A little heat below is as useful now as it is worse than useless in autumn.

LEMNA MINOR (*M. G.*).—This, commonly known as Duckweed, may be grown from seed, by sowing it on a piece of sphagnum merely made dirty with a compost of loam and peat, and kept near the surface. Plants can be had from almost all stagnant pools in summer, but we do not know where seed can be procured.

Various, &c. (*E. S.*).—You are right as to Perkins' heating; and, therefore, before the open-air pipe was thought about the small pipes in Perkins' system were made very strong for their size, so as to permit of a great amount of heat and pressure. All the best gardeners now, however, would rather have plenty of piping and the pipes not too hot. The very luxuriance of the Myrtles is the most likely reason why they do not bloom. If they have abundance of light and air, and heat in summer and autumn, they will be sure to bloom either on short, stumpy wood, or on shoots the growth of the present season. Perhaps the most Myrtles ever seen covered the front of the mansion of Mount Edgecumbe. They were spurred close in every spring, leaving only a bud or two of last year's wood, and the young shoots produced during summer were a mass of bloom. The want of flowering in pots is chiefly owing to want of sun and light.

MR. CHANSTON'S SYSTEM (*An Amateur Subscriber ab Initio*).—We have not seen the system of the architect you mention in operation, but have no doubt it will answer if properly attended to. Your arrangement would be right enough. Camellias, Acacias, &c., would do against the walls in the cool house, and Oranges, Lemons, Psidium, &c., in that of the warmer house. We shall be glad to be more explicit when we better know your wants.

REMOVING BEDDING PLANTS FROM A HOUSE (*A Subscriber*).—If the plants are strong they may be planted separately 3 inches apart in a bed composed, for 3 or 4 inches, of light turfy loam and leaf mould. If rather small we prefer turning them out in lumps, and then dividing as we plant out. These would be better if under glass coverings until the end of March. After that anything comatable would do, as calico, frigi-dome, mats, wooden or asphalt shutters at night. Read "Doings of the Last Week," and you will find much to suit you.

FAILURE OF VINES (*A Constant Reader*).—We think from your description that the failure is attributable to the inefficient heating of the house, and the cold condition of the border. In addition to placing some leaves and dung on the border, it should have been renewed before the heat declined. The flagging of the Vines with sun is attributable to the cold state of the border, and the low temperature kept in the house. Your heating apparatus must be woefully wrong, and the glazing of your house a specimen of bad workmanship. You must have these defects rectified before you can do any good with forcing Vines. We should train a young shoot from the bottom, and cut away the old cane, and so obtain a strong well-ripened cane before autumn.

TOBACCO SMOKE (*E. B., a Subscriber*).—It is injurious neither to young leaves of Vines nor to Peach blossoms, unless it comes in contact with them too hot, too densely, and for too long a time.

CARBONIC OXIDE (*J. K.*).—It is formed at low temperatures though not in such abundance as at high temperature, by fermenting vegetable matters.

KILLING TOWN EDGING (*A Subscriber*).—Salt, if applied thick, will assuredly kill grass. We know of nothing that will kill grass and not injure other things in close proximity to it. We cannot advise you better than to continue cutting the grass with edging-shears at intervals of a fortnight.

PRIMULA-SEED SOWING (*Idem*).—This is the proper time to sow seed to flower next spring. Any of the nurserymen who advertise in our columns will send you some really good seed, likely to produce fine plants and flowers, if you write to them and say none but good seed is wanted. You will have to pay rather dearer for it. Primulas thrive well in a compost of turfy loam and leaf mould in equal parts, with a liberal admixture of silver sand.

HYACINTHS DONE BLOOMING (*Idem*).—When the weather is more settled plant them out in the open borders, where they will flower next year, and enliven the garden in spring. There is no probability of their flowering finely next year in pots.

BOOK OF FERNS (*H. B.*).—There is no publication on the subject with coloured plates at the price you mention. Sir W. Hooker's "British Ferns," with sixty-six coloured plates, is two guineas. Mr. Moore's work on the subject and that published at our office have uncoloured plates.

FOONSIAS BREAKING WEARILY (*J. W.*).—Cut away the part above the growing-buds of your Sanspareil, and, if any of the shoots are long enough, put in some cuttings. We do not know why the plant should perish. Plunge it in bottom heat, and do not water except when really necessary. We should say the cuttings will be rooted by the time this appears in print. Gradually harden them off, and pot singly, growing them on in the greenhouse. Your fancy Geraniums will root in about a month or six weeks. They also should be potted singly when rooted and grown in a light, well-ventilated part of the greenhouse. A compost of turfy loam two-thirds, leaf mould one-third, with a free admixture of sand, will grow all well. The sorts you name are good.

PREPARING GROUNDS FOR PLANTING EVERGREENS (*A Subscriber*).—If you trench the ground, putting the turf at the bottom, it will need no further preparation. It should be trenched to a depth of 2 feet. If the ground is poor a liberal application of leaf mould or rotten vegetable matter would be of service. The ground should be drained prior to the planting. The Rhododendrons should have a bed prepared for them of peat, taking out the soil to a depth of 18 inches, and filling in with the compost above named. They should be well watered after planting, and this will bring them forward as much as anything. A mulching of leaf mould, or some such substance, will do more good than any manure. We advise you to keep manure away from them the first three years, but to be free with the watering-pot in dry weather. We do not think that you could have anything better than a bed of dwarf Roses between the Rhododendrons. *Berberis empetrifolia* would also answer well.

MELONS IN VINERY (*An Amateur*).—You will need some good rich and rather strong loam for your Melons, and it should be at least 10 inches in depth. You will require some rubble over the flue, and some reversed turves upon it, then the soil. We fear, however, that they will do no good; for they are not only subject to attacks of red spider, but the heat they require is more than is needed for Vines, and you could not grow both well. We should advise you to grow Figs in pots, or even Vines, which will do better than Melons. Melons can be grown in pots, but not successfully under Vines.

SOWING TROPICOLMUM ELEGANS (*M. G.*).—Sow in pots in a greenhouse, and grow in a cold frame until May; then plant out. It grows about 4 feet high when trained to a stake. It makes a good bed when pegged down, and is useful for planting in rustic baskets, &c.

DIONEA MUSCIPULA (W. E.).—It is not a native of Great Britain, and any specimen found out of a garden must have escaped from it. We wish you would write more briefly and use every-day words.

TROPICAL SEEDS (J. P.).—1, Barbadoes Pride, is *Poinciana pulcherrima*, probably the variety *lutea*, or yellow-flowering variety, from the West Indies. The flowers are sometimes beautifully variegated or spotted. It grows freely in any rich soil, and is an evergreen shrub. 2, Ochro (*Hibiscus esculentus*), is a stove annual, and grows freely in a rich loamy soil. It should be grown the same as a Kidney Bean, and it is the pods that are edible. 3, Christmas Pop, we do not know. 4, Guava, the common Guava of the West Indies, is *Psidium pyriferum*, and it thrives well in any description of rich soil. 5, Ipomoea—should sow the seeds in a strong heat, in loam and leaf mould. 6, Arnotta, is *Bixa orellana*, with pink flowers, and is a plant used in medicine. Requires the heat of a stove, and a compost of sandy peat, with a little loam. 7, Indian Creeper, is unknown to us. 8, Datura, sow in loamy soil, and place in a strong heat, 85° to 90°. 9, Four-o'Clock, is *Mirabilis dichotoma*, a fusiform-rooted perennial, growing well in loam and leaf mould; the seed to be sown in heat, and the plant to be grown in a greenhouse. 10, Pumpkin, grow in rich loam, and treat like a Cucumber. You say rightly they are West Indian, except 9, which is Mexican—one of the *Marvals* of Peru. Sow them all in a hothouse, and place in a hotbed if possible; and when up gradually harden-off and grow on, potting them singly when large enough, and so on, as necessary.

FERN SPORES (Idem).—Sow the spores from the Mauritius at once, as follows:—Drain a pot well, and fill it to within an inch of the rim with rough peat. Fill the remainder with fine soil, composed of peat two-thirds, loam one-third, and a free admixture of silver sand. Water so as to moisten the surface thoroughly, and whilst the surface is wet scatter the spores evenly over it. This done, place over them a bell-glass, which should fit and rest on the soil within the pot. The pot should then be placed in a saucer of water, kept full, and in a stove with a good heat. The pot should be shaded from sun and strong light. Be cautious about watering on the surface; but should it become dry it must be watered lightly through a fine rose. When the surface becomes green, tilt the glass a little on one side, and wipe the inside occasionally, still keeping the pot in a moist shady part of the stove, and taking care not to allow the surface to become dry under any circumstances. When the plants are sufficiently strong to bear handling, they should be prepared for potting-off by removing the glass by degrees, so that they may stand the somewhat drier atmosphere of the stove. They should at all times occupy the darkest and moistest part of the stove. The grass you enclosed is an *Isolepis*.

CINERARIA LEAVES INJURED (A Reader and Subscriber).—The leaves appear to us to have been frosted. They may, probably, have suffered for want of water; but as you say there is a trace of mildew upon the plants, that is sufficient to account for the present condition of the leaves. Dust the parts affected with sulphur, and admit air freely on all favourable opportunities, keeping the plants near the glass. We think the atmosphere of your house is much too moist and close, and that you did wrong to pot plants so near flowering. That alone would have a prejudicial effect on the flower, and for the future always have the pots full of roots when the plants are going to flower.

NAME OF APPLE (T. B.).—The Apple you have grown for the last thirty years, without being able to ascertain its name, we believe to be the London Pippin, but we could be more certain if we knew where and on what soil it is grown. If it is that variety it is one of our oldest, for in 1580 it is included in a list of Apples cultivated in Somersetshire. See Hogg's "British Pomology," The Apple, page 123.

NAMES OF PLANTS (Zeta).—Your Brazilian Orchid is *Notylia tridachne*. (*J. Pearson*).—1, Cornus, probably *sanguinea*; 2, some Cypress, probably *Cupressus lusitanica*. Both specimens are insufficient. Pinesapo is said to be Spanish, perhaps from pino and sapo. We never plant; we only criticise proposed planting. We cannot state positively about the Supplement. (*W. B.*).—*Acacia dasycarpa*. (*A Clerical Subscriber*).—After reading the description we guess the plant seen by the lady is *Petrea Stapelii*, or *P. volubilis*. (*J. S.*).—It is not safe to name Umbellifers from their leaves only. Yours appears to be the common *Anthriscus vulgaris*, or Wild Chervil, and if so is poisonous.

POULTRY, BEE, and HOUSEHOLD CHRONICLE.

POULTRY SHOWS.

APRIL 7th. ACCRINGTON. *Secs.*, Mr. J. Dugdale, Dutton Street. Entries close March 31st.
 MAY 26th and 27th. WOODBRIDGE. *Secs.*, Messrs. Dallenger and Whistock, Market Place.
 JUNE 13th to 17th, 1864. BATH AND WEST OF ENGLAND, and BRISTOL. *Steward*, S. Pitman, Esq., Bishops Hall Manor, Taunton. Entries close May 9th.
 JULY 14th and 15th. EASTERN COUNTIES. *Secs.*, Messrs. Ranson and Simpson, Stowmarket. Entries close July 1st.

GETTING GAME FOWLS INTO CONDITION.

I WILL, in reply to "AMATEUR'S" letter on this subject in last week's edition, endeavour to enlighten him on several of the points named.

There is no denying that condition is almost, if not quite, the first point. What is a Game cock in bad condition? In a pen he looks dull, loose in his feather, showing none of that brightness on the feather that a cock well up shows, and, as a matter of course, is not noticed by the Judge. Now take a bird well up in condition. He is hard and close in his feather, handles firm as a board, has a bright lustre on his feathers, a bright clear eye is red and healthy-looking about the head, and stands proudly and erect.

As regards feeding to obtain this condition, I am very

happy to inform "AMATEUR" of my method, which I have rarely, if ever, found to fail.

It is absolutely necessary that Game fowls have a good grass run. Three weeks before sending to the show I feed as soon as it is light in the morning, giving the birds good wheat. At noon I feed them on barley, and the last thing at night I feed them on oatmeal paste, made up with a little warmed ale, a few eggs being broken into it. This paste must be made quite firm. The birds will eat heartily of this. Feeding must occur regularly, care being taken not to miss a single meal.

I should not take the birds up, as is commonly done, a week or ten days before the show, but let them have the run of their walk till the night before sending; and I am fully convinced that, if the birds are in condition, they will show to a greater advantage in the pen than if they had been previously withdrawn from their grass run.

For the benefit of "AMATEUR" I have entered rather fully into details which will be "stale" to most exhibitors. I shall, nevertheless, be glad to see this question fully discussed.—WESTMORLAND.

ARCHANGEL PIGEONS.

I AM an old fancier of Pigeons, and an especial admirer of Archangels, and am extremely sorry to observe they have, with the exception of being allowed a place amongst the "roughs" in the "Any other variety," been hitherto entirely excluded from exhibitions. The Bath and West of England Society have, however, within the last year or two, had the good taste to open a special class for these lovely pets; and although at first, on account of their rarity, the entries were not numerous, still every succeeding year brings increased numbers of candidates into the field.

I hope stewards of poultry shows, who are now arranging their lists, will follow the good example of the Bath and West of England, and devote a class specially to Archangels, thereby giving fanciers an opportunity of exhibiting this lovely but hitherto neglected Pigeon.

Were the Crystal Palace and Birmingham Committees to adopt this course they would be astonished at the satisfactory way in which they would be supported.—E. M. PIERSON.

FOUL BROOD.

It is not, perhaps, necessary for me to make any further comment at present on the foul brood controversy. I am unwilling—indeed I am not in a position—to add anything material to what I have already said upon the subject. I have described foul brood as known and experienced by me; and all I can say is, that if there be any other kind of foul brood (as to which, perhaps, I may be accused of too great scepticism), I feel confident it has never found an entrance within the domains of any apiary with which I have been personally conversant.

I have again and again carefully perused the very graphic account furnished by Mr. Woodbury of the rise and progress of this evil in his apiary, with his opinions, comments, and treatment regarding it, as well as the details given by others who followed in the same track, and it must be admitted that there is much in the character of these communications calculated to produce a strong impression, and to stimulate reflection and investigation.

In my own case the considerations to which I have formerly alluded, and a review of the whole circumstances of the case, have outweighed all such impressions, and stamped the foul brood described by Mr. Woodbury as, in my estimation, the same with which I myself have been familiar. I was the more induced to take this view of the subject from the additional consideration, that the evil in question was promulgated not as a new disease, as "B. & W." has designated it—not as a foreign import introduced and propagated by means of the Ligurian bee, or any such agency, but as a home, wide-spread, indigenous disease, the hitherto unsuspected cause of the ruin of numerous apiaries throughout the land.

In thus viewing the case, I reflected how such a thing could be. Had my own knowledge of the bee been indeed so de-

fective, my powers of observation so lacking in acuteness, that an enemy so malignant in its character, so devastating in its ravages and effects, should lurk unnoticed like the cankerworm in the bud, or like a spirit of evil stalk unseen and unsuspected in the midst of our apiaries, working out slowly but surely the work of death? Moreover, how happened it that some of our eminent English authors should have been so mesmerised, so blinded, so unaccountably unobservant as not to notice it at all? This appeared to me a mystery, and so I reasoned; and so I have no doubt Mr. Taylor reasoned when he characterised it as an entirely artificial disease which never came within his observation.

In reference to Mr. Woodbury's remark in contravention of my statement, that an experimental apiary can never be a thoroughly prosperous one, I would remind him of the fact, that it is generally in such apiaries we find the frequent recurrence of such abnormal phenomena as drone-breeding virgin queens, and prolific workers, and such-like strange anomalies, which are but the precursors of ruin. And I would also further repeat as a sincere conviction deeply impressed upon my own mind, that as a general rule in whatever apiary the system of natural swarming is carefully and systematically excluded from the programme of proceedings, sooner or later—it may be months, or it may be years, according to circumstances and conditions—but the time will assuredly come when violated Nature will vindicate and assert her legitimate rights, by exhibiting throughout the apiary in the contravention of her laws, symptoms of physical disorder, exhaustion, and decay.

In giving forth my views upon this or any other subject, I need not say that I have no wish to provoke angry discussion, for differences of opinion however firmly supported, are not incompatible with the maintenance of sincere good feeling, and, therefore, it is with very great pleasure that I avail myself of this opportunity afforded me cordially to reciprocate the kindly sentiments to which Mr. Woodbury has given expression in his last article, and to assure him of my continued good wishes and high esteem.—J. LOVE.

[Here, then, ends our controversy; and I hope that in future whenever our opinions diverge, as happens to be the case with regard to the possible prosperity of an experimental apiary, we shall know how to "agree to differ, and differ without disagreeing." I have now only to add that I most warmly reciprocate Mr. Lowe's kind wishes, and beg to assure him that he is, and always has been, held in very high esteem by—A DEVONSHIRE BEE-KEEPER.]

CHILLED BROOD.

"I know it, my brother, I know it," but the question is, Will Mr. Lowe and his disciples be convinced from what has been already written that "foul brood" is a disease? "I trow not." Now, if I understand Mr. Lowe aright, he takes his main argument against one side from a belief that bees will not or cannot remove a mass of dead larvae. Let the experiment be fully tried and reported. Let the larvae be one mass of putrefaction before fresh bees are added to the deprived comb, and if this will not settle the question some other plan may be thought of. It is too expensive a job for a single apiarian to take in hand, but I should not object to subscribing 2s. 6d. or 5s. towards the purchase of a couple of swarms, if Mr. Johnson, or any one whom he may delegate, would undertake the experiment.—A HAMPSHIRE BEE-KEEPER.

DRONE-BREEDING QUEENS.

CAN my brother of Devon inform me whether, in the case of a drone-breeding queen (such as he describes as having been so lately discovered amongst his stock), male brood ever made their appearance outside the hive? I have often had hives with queens which did not breed, but I never remember seeing drones emerge from those hives in early spring. I have often read his article No. XXII. with much pleasure, and no one rejoices more that himself and apiary flourish than—A HAMPSHIRE BEE-KEEPER.

[The male offspring of my drone-breeding queen disport themselves outside their hive every fine day, and must have commenced doing so in February, since the first hint I had

of the actual state of affairs was finding a chilled drone on the alighting-board on the 29th of that month, before my examination commenced. On bringing this unfortunate into a warm room he recovered sufficiently to take wing and fly to the window. Is my Hampshire brother certain that he has really had hives with queens which did not breed? Were they not in reality altogether queenless? In all my experience I never met with a queen bee that did not breed more or less in the spring, either workers or drones, and a total absence of brood as spring advanced has only occurred when the queen herself has been wanting. I may be permitted in conclusion to assure him that his kind wishes are most heartily reciprocated by—A DEVONSHIRE-BEE-KEEPER.]

GOOD PRODUCE FROM AN ALDERNEY COW.

THE following is a good account to give of an Alderney cow which I purchased from Mr. Fowler, who imported her in 1852:—

My cow calved in August, 1851, and proved barren afterwards. She continued in milk until September, 1862, when unfortunately she broke her leg and was killed, much to the grief of my children. The first item of milk sold in my wife's housekeeping-book is August 13th, 1861, 1s. 6d; and the last is dated September 27th, 1862, milk, 2s., butter 14s. 4d. The sum total received during the sixty weeks as above is £19 14s. 7½d., or 6s. 6½d. per week; butter used in the house, say 1½ lb. per week, at 1s. per pound, £4 10s. Milk used, at the very least two quarts per week, at 4d., or 2s. 4d. per week, £7. This makes a sum total of £31 4s. 7½d., or 10s. 4½d. per week. Besides the above there was cream used, and we were never sparing of that, especially during summer time, and it was always used at tea-time. I think your readers will allow this is a good account for a cow twelve years old. At the best, and during the early summer, I have known 19 lbs. of butter made from her in one week.—HENRY L. ENSOR, *The Shrubbery, Woodville, Burton-on-Trent.*

OUR LETTER BOX.

LICE ON CHICKENS (R. S.).—We have no doubt the chickens die from the cause you assign, and there is no reason why they should suffer from it if you adopt proper means to keep them free from the unpleasant visitors. Unwashed warmth, cosy sitting-boxes and places, have much to answer for. Fleas and parasites never die from vermin, unless it is a very wet season, and there is no dusting-place to be found. One great reason for the immunity is, they sit on the ground. Hens should do the same. Pheasants do not have a bundle of straw turned round and round to make a nest, till they sit with only their heads visible; neither should hens. A little straw, in a slight hollow on the ground, is all that is necessary, and a sod at the bottom is an improvement. A coop or box turned over the hen protects her from interference or annoyance. Both hen and chickens require dust—indeed they cannot do without it. Coal-ashes are not so good as wood-ashes. The latter are as fine as flour, but the former are made up of tangible and sharp particles. Fine road dust is good. If the chickens have artificial flooring to run upon they should be moved. They should be on the ground in a dry place; and if this be done, and the dust supplied, there will be no more vermin.

EAST INDIAN DRAKE'S BILL (B. K.).—The bill of a black drake must not be bright yellow, and should be as dark as possible. It is generally like a yellow washed with soot. The drake's bill should be black. You may, if you will, bind parchment round the first six feathers of each wing tightly and sew it, or you may pass a thread through each of the feathers and tie them tightly. This is no injury to bird or feather, and prevents flight in a great measure.

PRICE OF FOWLS (A. K. C.).—If the birds were very young, they should have brought you a large price. From their weight we should fear they were too old for the London market. November and December birds weighing, being fattened, from 2 to 3 lbs. each, readily make 4s. each in London market. The imperative necessity for the London market is absolute youth; it covers many defects. To make good prices the age must be from twelve to eighteen weeks.

AUSTRALIAN GRASS PARROQUET (T. L.).—We cannot recommend any better treatment for the bird than what you are doing. Continue the bathing in warm water. Give a little hemp and hard-boiled egg with the ordinary seed.

LONDON MARKETS.—MARCH 21.

POULTRY.

The supply becomes less, and the demand increases; higher prices are the result.

	s.	d.	s.	d.		s.	d.	s.	d.
Large Fowls	4	0	to	4	Pheasants	0	0	to	0
Smaller do.	3	0	to	3	Guinea Fowls	2	6	to	3
Chickens	2	5	to	2	Hares	0	0	to	0
Geese	6	0	to	7	Rabbits	1	4	to	1
Ducklings	3	0	to	3	Wild do.	0	8	to	0
Partridges	0	0	to	0	Pigeons	0	6	to	0

WEEKLY CALENDAR.

Day of M th	Day of Week.	MARCH 29—APRIL 4, 1864.	Average Temperature near London.			Rain in last 37 years.	Sun Rises.	Sun Sets.	Moon Rises.	Moon Sets.	Moon's Age.	Clock before Sun.	Day of Year.
			Day.	Night.	Mean.	Days.	m. h.	m. h.	m. h.	m. h.	m. s.	m. s.	
29	TU	EASTER TUESDAY.	53.8	33.6	43.7	12	44 af 5	26 af 6	20 0	51 8	21	4 44	89
30	W	Gooseberry flowers.	53.6	34.6	44.1	16	41 5	28 6	15 1	51 9	○	4 26	90
31	TH	Horse Chestnut foliatea.	54.8	34.3	44.6	16	39 5	29 6	2 2	1 11	23	4 7	91
1	F	Ground Ivy flowers.	54.7	34.9	44.8	21	36 5	32 6	42 2	16 0	24	3 49	92
2	S	Peach foliatea.	55.3	36 5	45.9	20	34 5	33 6	16 3	35 1	25	3 31	93
3	SUN	LOW OR 1ST SUN. AFTER EASTERN.	56.6	35.3	46.0	13	32 5	35 6	15 3	55 2	26	3 13	94
4	M	Apricot and Cherry flower.	56.5	36.2	46.4	14	30 5	36 6	10 4	16 4	27	2 56	95

From observations taken near London during the last thirty-seven years, the average day temperature of the week is 55.0°, and its night temperature 35.1°. The greatest heat was 78°, on the 3rd, 1848; and the lowest cold, 16°, on the 1st, 1838. The greatest fall of rain was 1.19 inch.

THORNS, USEFUL AND ORNAMENTAL.

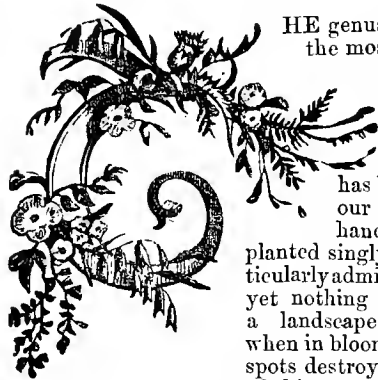

THE genus *Cratægus* is one of the most useful to the agriculturist of all the plants that are upon his holding; and so highly ornamental in character that it has been introduced into our gardens. Although handsome objects when planted singly on lawns, and particularly admired when in blossom, yet nothing is so distasteful to a landscape-painter, especially when in bloom, for the large white spots destroy the tone or keeping of his composition. However,

for thickening or diversifying open groves Thorns are invaluable, preventing an aggregation of naked stems being presented to the eye, which is apt to be the case in polished scenery. Passing over such matters for the present, allow me to treat of Thorns as hedge plants, or as objects of utility, and as decorative plants.

1ST, THORNS AS HEDGE PLANTS.—The White Thorn or Hawthorn (*Cratægus oxyacantha*), may be made to answer the purposes of a fence without giving shelter, as in dividing arable lands, or it may be made to afford shelter and a barrier against intruders. The one is accomplished by keeping the fence within prescribed limits by annual cutting, and the other by the same process, but at more distant intervals.

Haws, the fruit of this Thorn, should be gathered in the autumn, and may be sown at once; but it is preferable to pit them, as is done with Potatoes, only omitting the straw, and to cover them with soil only. In this position they remain twelve months, when they are to be sown in beds 4 feet wide, distributing them broadcast over the surface at about an inch apart. Throw out the alleys over the beds, covering the haws about an inch deep, and rake the surface roughly, but not smooth or very fine. Set a quantity of brick traps, for mice will come from far and near to devour the haws. Sowing may be done at any time from November until April if the ground is in good working order. Weeds should be removed as fast as they appear by hand-picking, hoes causing the wholesale destruction of the young plants.

Year-old, and not more than two-year-old, Quicks are usually planted in four-foot beds 6 inches from each edge of the bed, and 9 inches between the lines, with one-foot alleys between the beds. The Quicks are generally placed about 3 inches apart in the line. In these beds they remain until cleared for sale, no farther transplanting taking place, which is much to be regretted, as purchasers wanting Quicks 3 feet in height receive plants little better than stubbed-up, and are disappointed on finding

that strong Quicks neither make so fine a fence nor so rapidly as smaller plants at a less price. This is owing to the former having no root at all worthy of the name, whilst the latter have bushy roots, the result of transplanting. Quicks three years old are far preferable to those which are larger and older, and make a fence of more rapid growth, closer, and with a better bottom than Quicks that are a fence to begin with.

The planting of Quicks takes place from the middle of October and through the winter, in mild weather, until April; but the middle of March is quite late enough to plant. The usual practice in forming Quick hedges is to make the ditch first, throwing the soil that comes out on both sides, and making that side of the ditch on which the Quicks are to be planted more perpendicular or less sloping to the bottom than the opposite side. The nature of the land, however, in a great measure determines the slope necessary; for whilst some soils are so adhesive that the ditch may be cut with little slope or nearly perpendicular, others are so loose and friable that the first heavy rain causes the sides to fall into the ditch. A good width at top is not a bad allowance in making a ditch, irrespective of the nature of the soil, for then the scour of the water is more even on both sides than when the sides have a less slope, owing to the narrowness of the top. The width, top and bottom, and depth of a ditch vary according to the purpose which it is intended to serve, and according to the fall which the outlet allows. In some places the outlet does not allow of a ditch being cut; but I do not think there is any necessity for one-half the ditches in the country. All drains or ditches under 4 feet in depth do no good as drainers of the soil, but in many cases are worthless conduits for the surface water owing to the careless manner in which they are cleaned out, often not for years, and neglecting to do it properly even then, so that the ditch may drain itself dry. Instead of one-half, I am certain that three-fourths of the open drains in this country are only wasters of good lands that would, were drain-pipes put in their places, vastly increase the acreage of cultivated lands, and give more pasturage, an increased yield, and improved farming. Supposing the 47,250,000 acres of cultivated land in the United Kingdom to be divided into twelve-acre fields, the putting in of drain-pipes instead of keeping worthless ditches would give, presuming each ditch to be a yard wide, 447,634 acres of land; but instead of the hedge and ditch taking up 2 yards of a twelve-acre field, they take up on two sides of that field 4 yards, so that, were the ditch filled in, and the fence properly dressed, a saving of 3 yards on two sides of the field might then be effected, leaving a yard, which is ample for a fence of any kind. Now, providing half the ditches and fences for which there is no real necessity were cleared away, and hedgerow timber, alike worthless, confined to woods, I am persuaded that not a fraction less than 2,000,000 of acres of good laud would be economically reclaimed.

Irrespective of these matters there are a vast number of useless fences that require stubbing-up; and I may also

hint that there is no necessity to plant the fence crooked in the first place, nor to make a ditch unless drains falling into the old one need an outfall, and not even then if laying drain tiles or pipes will answer quite as well. In many cases nothing is needed but stubbing-up old fences and filling in old ditches, and so, by throwing two or more fields together, doing away with what are very often harbourers of weeds, the seeds of which are scattered far and near. In this way an increased acreage would be gained, as well as a good interest on the expense incurred.

However, setting such matters aside, my present subject is the formation of Thorn hedges. The making of ditches and planting of Quicks is mostly done by piecework, the price of which varies with the character of the land and the depth of the ditches. It is usual for the landlord to undertake all improvements of this kind himself. Posts and rails he mostly has by him in the shape of the thinnings of Larch and Spruce plantations. These are mostly prepared by his own men at regular wages, therefore no estimate of the cost can be given, for conveyance and other matters have to be taken into account. The posts are usually three-holed, the rails about 3 yards long, and the posts are set so that the first or lowest rail is 1 foot from the ground, and the others 1 foot apart, which, reckoning the thickness of the rails, leaves nine-inch openings between the rails. These posts and rails are placed 3 feet 6 inches from the fence, and, in some cases, at 4 feet from it; ditches 6 feet wide have no posts and rails on that side, therefore there are posts and rails on one side only, and these are set 4 feet from the Quicks, so that cattle may not nip the young shoots off. The Quicks are placed about 1 foot from the edge of the ditch, and eight plants are put in one yard. The Quicks should be 18 inches high, and be three or four years old, and they are purchasable at from 8s. to 15s. per thousand. The cost of making a ditch 6 feet wide at top, 1 foot at bottom, and 5 feet deep, is about 6s. 6d. per chain of 22 yards. Such drains are deep enough for land drainage purposes, and are the smallest open drain required. Nevertheless, there are open drains 3 feet wide at top, 6 inches at bottom, and 3 feet deep, which cost 3s. per chain in making. A four-foot drain can be cut, pipes laid, and filled in, for less than the amount necessary to cut a three-foot ditch; and instead of holding water half the year, and needing an annual clearing-out as in the case of a ditch, it would give something like half an acre of good land; and, if the drain were cut, not close to the fence, but in the place where it would be most wanted as a main for the arterial drainage, it would act as a drainer of the soil, and not be what all the shallow open drains are at present—retainers of surface water, feeding the natural subsoil water-channels, and making the land as wet again as it might be.

The ground in which the Quicks are to be planted should be dug a couple of spits wide and one deep, which, with the planting of the Quicks, is done at 8d. per chain. Posts and rails are set at 9d. per chain—for a six-foot ditch, on one side, 4 feet from the Quicks; and under 5 feet, on both sides of the hedge, those on the ditch side being placed close to the ditch, those on the hedge side 4 feet from it.

The fences are cleaned annually, the cleaning consisting in hoeing, or otherwise removing all weeds that interfere with the growth of the Quicks, and it is done at the rate of 1s. per chain. This cleaning is imperatively necessary to secure a good bottom, and the free growth of the fence. The work is best done in spring. The ditches are also cleaned out annually in early winter at the rate of 3d. per chain. The Quicks are allowed two years' free growth, when the sides are cut slightly, and the top cut off to 1 foot 6 inches high at 1d. per chain. In the following year the Quicks shoot vigorously, and are cut in the autumn, and the fence formed. It is cut so as to be 1 foot wide at bottom, and gradually reduced upwards to 10 inches wide at top.

Landlords mostly form fences for their tenants, and bear all expenses for three years, after which time the tenants are expected to attend to them. The cost of making a fence varies with the soil, the prices stated being those where the land was strong heavy clay, and therefore difficult to work. In four years from planting the hedge will be strong enough to resist cattle; but this also varies with the soil, &c., four years being the shortest time in which it is possible to form a good Thorn fence.

Fences when formed need trimming annually, and the ditches cleaning out. Very few people, however, do this. They allow the fences to grow into trees, and they cut off the top to "stake the huntsman's horse;" but the bottom of the fence is gone, and instead of the Thorns shooting afresh there they push very little below the place where cut off. Thus, for want of trimming and proper attendance hedges in many farming districts are nothing but land-improvers, and the dimensions they assume by the unchecked growth of Brambles and other plants is something wonderful. I know many farmers that chuckle over winning blue ribbons for cattle, and growing sixty bushels of Wheat per acre, whose fences and ditches have not been trimmed for years, nor a labourer been in their ditches for an equal period.

A fence 5 feet high is high enough for any purpose, and if it be trimmed annually it will remain a good fence for a generation; but when it once, from want of trimming, attains the size at which haws are produced, the fence is worth very little afterwards. It may shoot from the root if it be laid as such fences ought to be; but some parts will die, and then the farmer seeks to obtain a new fence by putting in branches of the old to repair it, which is making a rent wider, for weeds of all kinds spring up in the dead fence, and these very soon kill the live part, and the result is a fence alive here, dead there, the live portions appearing like bushes on a common. It would be better to replant such places with new Quicks, which properly tended would make good fences, and save an endless renewing of dead Thorn fences.

But we have a fence four years old which will need trimming, and how is it to be cut? Some say the shears are best, others prefer the slasher. Either will do; the one, however, is an implement more suited for a gardener's hands than the other, for most people work best with that to which they have become accustomed. Whatever instrument be used fences should not be cut until the year's growth is completed. Very strong fences may be cut in August and September, for such cutting limits root-action; but fences which are old cannot have too much encouragement to grow in summer, for every increase of top gives increase of root, so that by cutting the fence in autumn and winter greater food is stored up in the root—i.e., the root is stronger than the top, and that causes increased vigour of the head in the succeeding summer. The young shoots should be cut close, and the surface made even and regular, and not cut in and out, and the top should be as level as a bowling green. The fence may be of any shape, but it should be wide at the bottom in proportion to the width of the top, for it is easy to obtain growth at the top, but nothing short of cutting down can give growth at the bottom when it once becomes naked. Thorn hedges are most expeditiously cut by the slasher, and the very nice appearance such fences have when cut hogman-fashion and about 4 feet high, makes them ornaments to any estate. They are, however, too low for cattle, hedges, 5 feet high being better, for under them cattle seek shelter.

Fences that are thin at bottom can easily be made thicker by cutting them down, but this can only be done in arable lands. Such fences, however, may be cut close on one side one year, which will induce new shoots, and when these are sufficiently grown the other side may be cut, and the fence formed over again. Very old fences require laying, which is cutting the stems about 6 inches or from that to a foot from the bottom slantingly downwards three-parts through, and then bringing the top down to the required height, putting in stakes to keep the whole in its place, and finishing by binding the top of the stakes with hazels. The loose twigs are then triumphed off, and the fence will be good and neat for years to come.

In using the slasher the stroke should be upwards, for that cuts the branches off clean, whereas a downward cut leaves splits on the branch for several inches below the cut. The former mode of cutting keeps off the wet so that the wound soon heals over; but the other admits moisture so that the stem decays, in many cases fully 1 foot of the top dying, and this, unfortunately, a year or more after the new growth is made from it.

The branches of the Thorn of three years' growth make very good pea-sticks, and when firmly stuck in fields hinder

poachers from doing just as they please with partridges; they also make good firewood. In addition to these uses the White Thorn makes a very good stock for Pears on light soils. Pears crack and are otherwise very indifferent on sandy land, but when budded on White Thorns these defects are removed.

G. ABBEY.

(To be continued.)

FLOWERS OF THE PAST SEASON.

CHRYSANTHEMUMS.

As the growers of this flower (and they are, perhaps, more numerous than those of any other florists' flower), are now reminded by advertisers that the time for adding to their stock has arrived, it may be useful to say something as to the varieties which were sent out last year, and to mark those of them that are likely to be desirable acquisitions. With few exceptions they are to be found with Mr. Salter, of Hammersmith, as very few seedlings seem to come before the public save from his well-known establishment. In speaking of them I may as well state that the object for which I grow Chrysanthemums is not for exhibition but for the home stage, and that, having neither the time nor inclination to enter into the mysteries whereby those wonderfully large flowers are produced which we see at the metropolitan shows, I rather look to general effect, though at the same time one may make a tolerably shrewd guess as to what flowers will with care come out as good exhibition flowers. There must be a certain amount of fullness, or they will show a hollow centre; there must also be a breadth of petal, or the flower will look jagged and rough; and the incurved varieties are those which are especially desired for this purpose. Some of those in the following list I have seen at the exhibitions, and where that is the case I shall refer to them again. While the general notes that I have made are entirely from those which I have grown myself there may be other kinds equally good, and their exclusion from this list arises simply from the fact that I have not had them under my own eye.

LARGE FLOWERS.

Abbé Passaglia.—A shining amber, the petals broad and well incurved. It is, as Mr. Salter says, somewhat like Little Harry in shape though differing in colour, and also much larger. This I saw at the Islington Show, as also

Antonelli.—A bright salmon orange, well incurved, somewhat novel in colour. A well-habited plant.

Beverley.—A large blush white flower, well incurved, and of great depth; in fact, the deepest flower I know. It seems also to be very free, and is decidedly a first-rate variety. It was largely exhibited last season.

Cardinal Wiseman.—Those who admire those old flowers Bob and Julie Lagravère, will gladly welcome this addition. It is of the same character, early in flowering, brighter in colour, and very free. As a decorative plant it is especially valuable.

Cleopatra.—A well-incurved flower of a delicate blush white, and one of the freest-blooming varieties I am acquainted with. The plants that I had were literally a mass of flower.

Crasus.—A bright orange. A dwarf-growing plant, and most desirable for greenhouse cultivation, its bright colour making it very effective.

Duchess of Buckingham.—White, the centre of the flower having a sulphur tinge, and at times a slight tip to the petals. A very beautiful variety.

Her Majesty.—Well deserving of the title, for as a light flower it is one of the very finest, if not the finest flower in growth. In shape it cannot be excelled, and as its size is large, it forms one of the best exhibition flowers we have.

Jane.—Silvery blush, incurved, and has the peculiarity of blooming late. The habit of the plant is good, and although the flower is not large, it is a very free-flowering variety.

Lord Palmerston.—A distinct dark rosy red flower, sometimes coming with a tip. It seems to be somewhat inconstant, the flower not always filling up. It is, however, a fine variety.

Princess Alexandra.—Delicate lilac blush, and a very beautiful flower, very free in its habit of flowering, and most desirable.

Princess Louis of Hesse.—Rosy pink, incurved, dwarf in habit, and a good pot plant.

Queen Margaret.—A large anemone-formed flower, the guard petals rosy lilac, and broad, the centre well filled up with small florets of the same colour.

Talbot.—A well-incurved, rosy red flower, sometimes tipped with blush, large in size. It was exhibited freely at the Islington Show in November last.

Of the above, then, the cream I conceive to be, Antonelli, Beverley, Cleopatra, Her Majesty, Princess Alexandra, and Talbot, but I think that they are all well worth growing, and that they must displace some of the older varieties of the same colour.

POMPONES.

These have been for some years more limited in numbers than the larger-flowered varieties, but each year sees some desirable addition to those already in cultivation; and of the half dozen sent out by Mr. Salter last year, four of the number ought, I think, to be added to our collections.

Danaë.—A bright gold, medium-sized flower; very abundant bloomer, and very double. It makes an admirable plant.

Fairest of the Fair.—Lilac blush, with whitish tips; very distinct indeed when it comes in character, but like all tipped flowers it sometimes disappoints by not showing its peculiar character.

Helen Lindsay.—Blush white, very globular, early in blooming, and very free in habit.

Julia Englebach.—Bright yellow, tip of petals brown, very double, free-flowering. Excellent in habit, and a first-class plant.

Lilac Cedo Nulli.—Another sport of a very favourite flower. We have already had a white and golden sport, and this will, doubtless, be equally prized.

Mary Lind.—A peculiarly-shaded flower, the ground being blush, with a shade of purple on it. Very free-flowering.

Of these, then, Danaë, Julia Englebach, Fairest of the Fair, and Mary Lind, I consider to be decided acquisitions; and as Pompones are almost universally admired, I am glad to say that the present season has produced some fine flowers, which, with a large number of the large-flowered sorts, Mr. Salter, of Hammersmith, will let out immediately.

And here may I add a little item on another point? Most of those who ever make up a bouquet, know how attractive the Maiden-hair Ferns are for this purpose, but they also know how very soon they shrivel up and lose their beauty. Talking the other day with Mr. Jones, the intelligent gardener at Petworth House, he told me that if the fronds are gathered, placed between paper, and dried, they will retain their freshness, and may then be used in bouquets without any fear. It seems a hint on a small matter well worth noticing, and accordingly I give it here for the benefit of our fair bouquet-makers.—D., Deal.

FLOWER-GARDEN PLAN.

VARIETIES OF ARABIS—LOBELIA SPECIOSA CULTURE.

I AM much obliged for the insertion of my flower-garden plan (see page 154), and the remarks upon it; and as you expressed a wish to know how I decided, I send a plan of the way in which I am going to plant it this year. I have determined to try the method of planting it in groups of four, my chief difficulty being with Nos. 2, 3, 4, 5, which are rather large for highly-coloured self-beds when contrasted with the smaller beds at the two sides. I think I shall get over the difficulty, however, by filling them with mixed Verbenas, which in my opinion always form a very effective bed, and edging them with variegated Arabis.

By the way, your correspondents generally state that there are two varieties of this variegated-leaved Arabis, but in reality there are three. One, *Arabis lucida* variegata, as its name implies, has a shiny leaf, and the green is of a darker colour and contrasts better with the golden edge, and the other two are really sports from the *Arabis alpina*, to which they often return. In these the variegation is quite distinct, one being cream colour, about the shade of Flower of the Day; the other yellow, nearly the colour of Golden Chain. Some persons may say that they are the same plants only grown in different soils or different situations;

but I have them planted side by side, have struck them both in the same way, and yet can tell every cutting and plant apart at all times of the year; but in summer, especially, the foliage is most distinct. The cream-coloured variety I have had for nine or ten years; the golden variety is a more recent introduction, but is not *A. lucida variegata*. But now, to return to the beds, I propose to plant them as follows:—

- | | |
|--|---|
| 1, Centre, <i>Humea</i> , three plants;
2nd row <i>Ageratum</i> .
Tropaeolum Crystal Palace.
Edge, <i>Cerastium</i> , 1 foot. | 14, 16, 18, 20, <i>Tropaeolum e' gans</i> .
15, 17, 19, 21, <i>Lobelia speciosa</i> ; edge,
Golden Chain Geranium. |
| 2, 3, 4, 5, Mixed <i>Verbenas</i> ; edge,
<i>Arabis variegata</i> . | 22, 24, 26, 28, <i>Petunias</i> . |
| 6, 7, <i>Calceolaria</i> ; edge, blue <i>Lobelia</i> . | 23, 25, 27, 29, Purple King <i>Verbena</i> ;
edi e, <i>Mangles' Variegated Geranium</i> . |
| 8, 9, 10, 11, <i>Geraniums</i> Crystal
Palace and Little David; edge,
Bijou and Alma. | 30, 34, 35, 39, Mrs. Holford <i>Verbena</i> .
31, 33, 36, 38, <i>Gazania</i> ; edge, <i>Lobelia</i>
<i>Paxtoniana</i> . |
| 12 & 13, Centre, <i>Humea</i> , one plant;
<i>Calceolarias</i> . | 32, 37, <i>Trentham Rose Geranium</i> ;
edge, Flower of the Day. |

Ribbon-border next to the house—

- | | |
|---------------------------------------|-------------------------|
| 1, <i>Mesembryanthemum tricolor</i> . | 3, <i>Amaranthus</i> . |
| 2, <i>Bijou Geranium</i> . | 4, <i>Calceolaria</i> . |

Border round the garden reckoning from bottom—

- | | |
|---|--|
| 1, <i>Arabis variegata</i> and <i>Aubretia</i>
<i>purpurea</i> , plant for plant. | bottom and Tom Thumb <i>Nasturtium</i>
at the top. Circles filled
with Scarlet Geranium, <i>Ageratum</i> ,
<i>Christine, Calceolaria, Saponaria</i> , &c. |
| 2, <i>Pansies</i> , and seedlings from
Dean's Fancy <i>Pansies</i> . | 4, <i>Perilla nankinensis</i> and <i>Prince's</i>
<i>Feather</i> , plant for plant. |
| 3, Large circles, filled with bedding
plants, all edged alike with <i>Cerastium</i> .
The spaces between the
circles filled with <i>Lobelia</i> at the | 5, <i>Variegated Ribbon Grass</i> . |

The circles are to be just large enough for nineteen plants a foot apart every way—one in the centre, six at a radius of 1 foot, twelve at a radius of 2 feet from the centre. I have several plants, of which I have not enough for rows or larger beds, but which I want to try as self-beds—as *Calceolarias* Victor Emmanuel, Sparkler, Cloth of Gold, and I thought this might be a good plan to enable me to give them a trial in my soil.

I see that several of your correspondents complain of the *Lobelia speciosa* failing. Last year it did particularly well with me, except a few plants which were potted-off, and which did not do so well as those which had been pricked-off into a spent hotbed the same as that which I had used for striking *Verbenas*, and which all lifted with good balls, and never once flagged after bedding-out, though we had dry weather and cold nights, the thermometer three nights running being at 33°.

I attribute the failure of *Lobelia speciosa* in a great measure to striking cuttings from the points of the shoots which have begun to run to flower and are showing their flower-buds; these never make such good plants, flower with little or no leaf, dry up soon after flowering, and run to seed. All cuttings from *Lobelia speciosa* should be made from shoots with the broad leaf on; if ever the plant begins to show the narrower leaf which comes on the shoot when it is running up for flower, the ends ought to be stopped, and fresh shoots allowed to start from the roots to make cuttings from. *Lobelia* plants are very impatient of drought, and will not stand hardening-off in pots in the manner in which so many bedding-out plants are treated.

I am very glad to see in your pages an opposition raised to this hardening-off system, by which plants are too often checked in their growth, their roots dried up, and nearly a month lost in the garden. I am not an advocate for plants being taken out of a vinery or stove and planted out at once in the open air in the middle or end of May; but plenty of pot-room and moisture are necessary, and plants should be kept in a growing state up to the time of their being bedded-out, and the higher their state of growth the better they will stand it. A plant-house facing south without any fire heat for the last month, but with plenty of water and syringing, and sun *ad libitum*, is by far the best place to transplant bedding stuff from. I am speaking more especially of such things as *Verbenas*, *Geraniums*, *Tropaeolums*, *Ageratum*, &c. *Calceolarias*, *Gazanias*, and a few others do as well or better from cold frames and sod-pits as so often described in your pages. *Verbenas*, more especially, suffer from the hardening-off system. If ever they become dry at the roots, green fly, red spider, and all their attendant evils begin, and if plants have green fly or red spider on them when they are bedded-out they seldom, if ever, recover it. Last year my garden was at least a month

more forward than most in this neighbourhood, especially the *Verbenas*, which were planted out direct from the house where they had been grown after being struck in a hotbed, and they were never checked, except being stopped to make them bushy, from the day they were first potted-off; and although, as I have before said, for the first three nights they were out the thermometer was only 1° above the freezing-point, they never suffered in the least. I gave them each a trowelful of good manure (ashes, hen-manure, and well-rotted stable-manure mixed) at the roots, and a watering once a-week for the first three weeks, not at night, but in the morning, which I think is the best time for watering, as it prevents the beds from getting too hot in a scorching sun, and the evaporation from the beds keeps the leaves from flagging; whereas watering at night very often causes too great a chill if a cloudless night comes immediately after it.

Allow me to correct an error which appeared in a letter of mine in No. 155, upon bedding annuals. The word "numbers" in the last paragraph ought to have been "Mimulus." It was in answer to the question made by "A LOVER OF FLOWERS," whether *Mimulus* grown from seed would do to bed-out the same year.—X. Y. Z.

DESTROYING GOOSEBERRY CATERPILLARS.

I was to-day telling a friend the Broad Bean cure for Gooseberry caterpillar, as noticed in No. 155, when he informed me of an effectual remedy for this pest. It is 1½ lb. of soda and 1 lb. soft soap to 5 gallons of water, applied with a syringe; and he states that it is also a famous wash for Rose trees affected with green fly. I hope to test it this season; but am confident of my friend's veracity.

I have tried hellebore with success, and know others who have also done so. It is very extensively used in Scotland for this purpose; but it would be well to remind your readers that it is a virulent poison. A family in my native parish, in Scotland, nearly lost their lives last year through partaking of it in mistake for pepper.—GOOSEBERRY.

ORCHARD-HOUSES.

It would add to the interest of your correspondents' communications if they would in addition to their names give their places of abode. For instance: Mr. G. Abbey leaves us quite in the dark as to where he writes from. He says all the houses he has seen in the "north." I certainly infer it is not anywhere near the north pole, because he says he has smoke enough to turn a white man black; but from his account it appears to be a cold, wet, smoky district.* He says he can grow fine crops of Plums and Pears, the former, he says, were delicious. From his account I really think he has been quite as successful as he had a right to expect. A house only 14 feet wide, with sides 4 feet high, made of half-inch boards (these much shrunk), with sunk pathway, and covered in with old lights, in which the timber is probably out of all proportion to the glass, and under which he has a shelf for Strawberries, and this in a cold, wet, smoky district, with his plants dreadfully attacked with brown aphid, what could he expect? If his house had been built with glass sides to nearly the ground level, the house and paths above instead of below the surface of his cold wet soil, the construction such as would have enabled him to kill the aphid by fumigation before the blossoms expanded on his Peach trees, is it not possible he would be more satisfied with the result? If his climate requires it by all means let him heat his house, and if he get as good Peaches as others do without artificial heat he may (after the description we have had of the "north" he lives in, wherever that may be), be quite content, and need not mind whether his house is entitled to the name of orchard-house or not.

Mr. Abbey goes on to quote, not quite fairly I think, from my little book, "Hints on Orchard-Houses"—at least, the inference he draws from it is not quite fair; I never proposed to enclose a garden with glass houses in place of walls, or expected a glass house to protect an enclosed space. I said, and still think, that to build walls for the growth of Peaches uncovered with glass would be considered an absurdity.

* Bradford, Yorkshire.

But surely there are other fruits besides Peaches and Nectarines which would be the better for being trained to a wall. Pears on quince stocks, trained to one shoot like a Vine, will, I am inclined to think, soon be extensively planted. Many of our finer Apples are quite worth a wall, and are rarely produced of good quality without some protection. A gentleman, who has been very successful with an orchard-house from the first year, writes me word that his Apples are so good that it is worth having a house for them alone. If good walls were planted with Apples, Pears, Plums, and Cherries, would it not be better than trusting to Peaches and Nectarines in most localities? and in a decent neighbourhood is it not better to have a handsome wide house with a span-roof than a narrow covered wall to walk in? I do not say I might not cover a wall already furnished with fine bearing trees.—J. R. PEARSON, *Chilwell*.

IF "D. Deal," has never seen one of these houses in perfection, it would be, perhaps, worth his while to see one managed by Mr. C. Powell, gardener, Ticehurst, Sussex. The trees in this house bear large crops every year; in fact, I always remark that the larger the crop a tree produces one year, the larger it will be the next season. This year many of the trees will bear twenty dozen of Peaches and Nectarines, and no wall fruit has yet equalled them for flavour.

If one person can produce the finest crop of fruit in these houses without any difficulty, why should not others do the same? My gardener succeeded the first year in growing a very large and well-flavoured crop of Peaches, Nectarines, Apricots, and Plums, in pots.—A CONSTANT READER.

THE HORTICULTURAL SOCIETY.

WHAT is a horticultural society? It is sometimes necessary to ask, and therefore to answer, a foolish question. And there are conditions under which it becomes necessary to define very elementary notions. A horticultural society, one would think, is, or ought to be, an associated body for the encouragement of the cultivation of trees, fruits, and flowers. It ought to confine its work to the improvement of our woods and forests, our orchards, and our gardens. It ought to have a collection, scientific and ornamental, of exotic plants and trees. It ought to present a model of the best modes of cultivation in forcing-houses, stove-houses, and green-houses. It ought to ransack the world for new varieties of the vegetable creation, and it ought to include within the range of its efforts a scientific pursuit of botany. Further than this, and it is sufficiently far, a horticultural society cannot be expected to go. And, to do it only justice, till within these few years the Horticultural Society steadily pursued these objects. It is given to societies, as to men, to deserve, but not always to command, success; and it cannot be denied that the Horticultural Society was not a success. But its failure at Chiswick was mainly in proportion to the degree in which it deviated from its legitimate functions. The ruining expense at Chiswick was the *fêtes*. By a strange law, which Admiral Fitzroy has not investigated, it was as certain to rain on a Chiswick *fête* day as it was certain to be fine on a Queen's day. Meteorological laws, constant in nothing else, set themselves against the Chiswick *fêtes*. The consequences were disastrous; the funds fell off, the members dwindled away, and the Society tottered on the verge of bankruptcy. As with other folks in difficulties, retrenchment was the order of the day. The library and herbarium were sold, the town house was given up, the foreign collectors were dismissed, the Journal was abandoned, and the Society lost everything but its name. A gentleman in difficulties will catch at any pretext for keeping a position in the world. The Horticultural Society was not superior to the tempter, and the tempter came in Royal guise. The late Prince Consort had, as is well known, a plan for establishing all the Muses, and all the Sciences, and all the Arts, and all the Graces on one sacred site. An ornamental garden was wanted for aesthetic and artistic purposes. Given the garden, or given anything, the rest, it was thought, would be sure to follow. If you could get a centre fixed and settled, you must have some buildings or institutions to set off your centre. A middle implies and involves the extremities. So,

in the darkest hour of its poverty, the Horticultural Society was applied to. It was resolved to set the Society on its legs, not for its own sake, and not to further its chartered objects, but as something likely to be useful to the great South Kensington scheme.

Those who think that Royal patronage and Court favour are the highest objects for which public societies ought to live, are not to be blamed for having thrown themselves into the hands of the Commissioners of the 1851 Exhibition. And as far as the Horticultural Society was concerned, having nothing to lose, it lost nothing except honour and the very purpose for which it was founded. As to the arrangements entered into between the Society and the Commissioners, we do not pretend to explain, because we do not understand them. It will be enough generally to state that the Commissioners leased a large plot of the South Kensington estate to the Horticultural Society, on condition that both parties should expend large sums on buildings, most of which, strictly speaking, had nothing whatever to do with horticulture, and that the Society should lay out a garden which might be ornamental, but which laboured under the little difficulty that nothing would flourish there. Hence grew the arcades, and hence did not grow the trees which the Society planted, and the flowers which the Society sowed. But something grew, and that is a very pretty debt. As we understand the Society's position, it stands, or in a few weeks will stand, indebted to the Commissioners in the sum of £60,000, for which it is bound to pay £2400 a-year interest. This £60,000 has been or is to be sunk in the decorative arcades and other ornamental works, the Society having on its own part spent large sums in erecting greenhouses and in laying out the gardens. Whether the Society pays any rent for the gardens over and above the £2400 a-year we are not quite certain. It may be said, perhaps, that the Society, after all, has not made a bad bargain; because, although the Commissioners have a right of re-entrance if the £2400 interest is not paid, yet, the Society having no property, the loan of £60,000 is only fictitious, and has been advanced by the Commissioners on no security whatever. But the question is not whether the Horticultural Society has made a good financial bargain, but whether all these transactions with the Exhibition Commissioners come within the legitimate scope of the objects of the Society. We are prepared with an unhesitating negative. Not one shilling borrowed by the Horticultural Society from the Commissioners has been expended on the legitimate objects of horticulture. The subscriptions and entrance-fees of the two thousand members whom the Council claims to have acquired since it began to deal with South Kensington are absorbed for purposes which may be good or bad in themselves, but which are not connected with legitimate horticulture. The South Kensington Gardens may be very ornamental, though we own to a positive dislike to Mr. Nesfield's chalk beds and coal alleys and pounded-brick parterres. We think that his little ditches are mean and his ribbon-beds barbarous. But let this pass. In a garden—that is, in a horticultural society's garden—we want to see things grow and flourish. At Kew and Chiswick trees and flowers grow; at Brompton they do not. No doubt it is a great thing to get something of a garden in the midst of London smoke. The flowers in Hyde Park, and in the Regent's Park and the Green Park, are a triumph of the art of gardening under difficulties. So is the Temple Garden; but nobody would think of quoting these as instances of what a healthy flourishing garden should be, especially a horticultural society's garden. It would doubtless be a benefit to the public if the Horticultural Society were to take Lincoln's Inn Fields or Finsbury Square in hand; but these are not the sites for the model Paradise of the model Society of England. If anybody wants to see a melancholy sight, let him look at the starved, stunted, soot-begrimed Conifers at South Kensington; and if he is a member (or, as it is sonorously termed, a Fellow), of the Horticultural Society, let him ponder in his mind whether for such cultivation as this—a cultivation which every year with its increasing buildings makes worse—his subscription is well laid out. The Council, with a laudable zeal to "increase the enjoyment of the Fellows and the attractions of the gardens," have just announced the formation of independent clubs for croquet and bowls. The same reasons will probably lead to

the introduction of an *estaminet* and smoking-saloon; and the promised Evening Meetings are almost certain to develop into music and dancing, fireworks and the tight-rope. For ourselves, we do not pretend to be purists. The aristocratic world has long been hankering after a *Cremorne* of a genteel kind. The arcades present remarkable facilities for the matrimonial market, and for other pursuits cultivated in fashionable life. A *Jardin Mabille* under the patronage of a chartered Society and Royal Commissioners will eclipse not only *Vauxhall*, but the traditional glories, and traditional other things, of *Ranelagh*; but the question remains—Is this Horticulture?

There are at least some people who are answering this question, pertinent or impertinent as it may be. The Council, as they admit, "are still at the commencement of an experiment"—that experiment being to maintain a fashionable lounge, under the pretence of encouraging horticulture. They have built arcades, they have erected memorials and monuments, they are encouraging the scientific pursuit of bowls and croquet, they spend some money on prizes which read like a recurring decimal, and, somehow or other, seem always to be taken by the same market gardeners. The Horticultural Society's prizes are as good as an annuity to Mr. Turner of Slough, and to Mr. Lane of Berkhamstead, and to Mr. Paul of Cheshunt; and in order further to identify themselves with tradesmen, the Council propose to set apart, as "exhibition grounds of bedding plants to be let out to respectable nurserymen and florists," portions of the Kensington garden. That is to say, they intend to lease off their gardens as advertising-boards, just as Messrs. Mappin line the foot-boards of the *Hanson* cabs. But we ask again, Is all this Horticulture? Some recent circumstances seem to show that horticulturists at any rate are beginning both to ask and to answer this question. At the February election, in the place of Lord Ducie and Dr. Lindley (resigned), and Mr. James Veitch, there was elected, among others not known to horticulture, Henry Cole, Esq., C.B. The exchange from Dr. Lindley resigned to Mr. Henry Cole is very significant. The horticulturist and botanist of European fame cuts the Royal Horticultural Society, and the presiding genius of South Kensington jobbery reigns in his stead. Again, we find that Dr. Hogg, a scientific gentleman of great practical attainments, forwarded last month his resignation of the office of Secretary to the Fruit Committee of the Horticultural Society, on the avowed ground "that some other object than the advancement of horticulture is that which a ruling majority of the late and present Councils have in view;" and, therefore, he gives up an office accepted "under the impression that the Council intended to maintain and develop the horticultural character of the Society." Dr. Lindley and Dr. Hogg are practical men, tried and valued horticulturists. This is their opinion of the present objects of the Council. Of course, if ladies and gentlemen are to be found ready and willing to spend their money on grounds close to *Rotten Row*, where they can exhibit spring bonnets, polished boots, and their skill at croquet, with its connected pursuits of flirtation and every other 'ation, the £60,000 gardens at *Brompton* are a very good site for these noble purposes. Love deities have always had their votaries in gardens. But people who wish to encourage science will not cease to regret that the Horticultural Society has gone to Court, and has admitted Henry Cole, Esq., C.B., on its Council.—(From the *Saturday Review*.)

ORCHARD-HOUSES AT SAWBRIDGEWORTH.

The orchard-houses at *Sawbridgeworth* are now in their glory; and those who are desirous of forming an opinion as to the advantage to be derived from this system of fruit culture, should seize the present opportunity of seeing the first stage of the process, and judging as to whether it is a success or not. For our own part we believe that it is the only way by which Peaches, Nectarines, and Apricots can be grown in this country with any degree of security, or with any assurance of a crop, short of the usual systems of fruit-forcing; and all that has been for so many years said of the difficulties attending it, must have been gained from cases in which the required amount of skill has been deficient.

When we see venerable old Apricot trees, luxuriant even under their weight of years, covered with masses of bloom; and when we consider that these same trees have occupied the same pots for a period of ten years, we cannot but admire the beauty and advantage of the system. In one of the largest of the orchard-houses, which is 100 feet long by 24 wide, there is a perfect forest of Peaches, Nectarines, and Apricots in full bloom, while many of the last-named have already set their fruit, and are perfectly safe and uninjured by the severe frost of 11°, to which those out-of-doors were subjected on Thursday last. How many of these have escaped? and what prospect of a crop of fruit is there from those that have been exposed to such a trial? We would advise all who are fruit-growers to take the present opportunity of visiting Mr. Rivers's nurseries, and of forming an opinion for themselves as to what may be done, and how easily, in this, one of the most captivating branches of horticulture.

FERNS HARDY AND EXOTIC.

HOW TO RAISE THEM.

In 32-sized pots well cleaned and crocked, place on the surface of these crocks a thin layer of the siftings of peat, if wholly fibrous all the better, with another layer of well-sifted peat. Upon these two layers of peat place some small lumps of very fibry yellow loam; but first, after they are broken into unequal pieces of the proper size, place them one thick in a sieve, pour water from a rose over them, turn them over, and again water, until all small detached particles have been washed off the lumps. When dry enough to handle place them in the pots, leaving the surface as irregular as possible, then place them aside for a day or two until they become tolerably dry.

Gather a frond of each Fern you wish to propagate, placing each in a sheet of paper, naming, and carefully folding it up, the whole to be put in a dry place for two or three days. Rub each frond well upon the paper, throw the roughest refuse away, and sow the particles left evenly over the irregular surface of the soil. In doing this care should be taken that no wind enter, otherwise the sporules may be blown aside. When sown give one slight sprinkling with water, and place a sheet of glass over the top of each pot. Put each pot in a pan, and place it in a temperature of about 70° in a shady situation. In a day or two fill the pans with water, afterwards never let them remain any length of time without being replenished.

The pieces of glass are essential to the proper growth of the seedlings, and should be used, even if a good supply of bell or other glasses may be at hand, and there should be just a sufficiency of space between the piece of glass and the pot to admit the outer air in sufficient quantity without robbing the soil of moisture. Keep the glass clean, and this with an occasional weeding, and washing the exterior of the pots should they become green, is all that will be requisite for nine or twelve months, by which time the young Ferns should be of some size.

As soon as they are sufficiently large to handle (over-anxiety in potting them too soon is fatal to them), prepare a compost of peat, leaf mould, and sand, and a good sprinkling of potsherds broken very small. Should you not have a house of a proper temperature for them when potted off, they will be greatly assisted by being placed under common hand-lights. Perhaps it may be best under all circumstances to remove the glass from the pot when the second and third fronds show pretty generally. Soon after this let the pots be taken out of the pans, placed at the coolest end of the house, and gently watered overhead.

Though I have fixed the temperature at about 70° as being the best and most effectual one, yet most greenhouse and British Ferns will come up in a much cooler situation, though all will stand a high temperature. I have at the present time fronds of *Gymnogramma orchreica*, *Platyloma rotundifolia*, *Pteris tremula*, and *Gymnogramma tartarica*, growing out of a brick wall, which supports the front of a small stove, wholly exposed to external weather, and yet while I write they are pushing forth fresh fronds. They have fronds some of them sufficiently large to place around a moderate-sized hand-bouquet.

Some of our rarer exotic kinds are very difficult to treat so as to succeed in raising young plants, though they will all grow under treatment as above until they attain a certain size. Among this class I find the *Platynerium grande*. The difficulty may often be overcome by procuring some of the oldest and most decayed substance from a plant of *P. alci-corne*, and well mixing it with a little peat and loam. Where successful leave the plants in the pot until they are quite strong, and seem to require removing. — Wm. EARLEY, *Digswell*.

MESSRS. CUTBUSH'S HYACINTH SHOW.

FINE as Messrs. Cutbush's Hyacinth Exhibition always is, that of the present year surpasses their previous displays. Some of the spikes are of marvellous dimensions, one measured $9\frac{1}{2}$ inches in height by 11 in circumference, and there are many others little, if at all, inferior in size. As usual the Hyacinths are ranged along the front of the house; Tulips and pot Roses fill one end, whilst at the back a bank of flowering plants, consisting of Roses, Azaleas, Heaths, Epacris, Cytisus, Dielytra, Cinerarias, Mignonette, &c., has a gay appearance.

Selection and note collection is the order of the day, and, therefore, out of the multitude of varieties which Messrs. Cutbush place before the public we have picked out a limited number of those which appear to be possessed of the highest merit, adding some others which are highly to be recommended.

Single Reds.—Macaulay, Von Schiller, Princess Clothilde, Florence Nightingale, Pélissier, Solfaterre. Next in merit Cavaignac, Howard, Mrs. Beecher Stowe, La Dame du Lac, Princess Charlotte, Queen Victoria, to which may be added Amy and Robert Steiger.

Double Reds.—Duke of Wellington and Koh-i-Noor. Noble par Mérite also very fine; Susannah Maria, good salmon rose.

Single Blue.—Argus, Charles Dickens, Blue Aimable, Grand Lilas, Marie. Next in merit Leonidas, Baron von Tuyll, Pieneman, Couronne de Celle.

Double Blue.—Laurens Koster and Van Speyk. Sir Colin Campbell, Comte de St. Priest, and Bloksberg, also very fine.

Single White.—Emmeline (beautiful blush), Gigantea, Grandeur à Merveille, Madame Van der Hoop, Snowball, Queen of the Netherlands. Elfrida, Alba Maxima, Miss Burdett Coutts (very large bells of great substance), Seraphine, Paix de l'Europe are also of high merit.

Double White.—Sir Bulwer Lytton and Prince of Waterloo. La Tour d'Auvergne is also excellent.

Single Black.—General Havelock and Von Humboldt are the finest. Mimosa and Prince Albert are also fine and less expensive.

Single Yellow.—Ida and Duc de Malakoff appear to be the best. Aurora and Heroine are also very good.

For a lilac mauve Haydn should be in every collection; its colour is most beautiful.

Among new varieties Robert Fortune and Josephine have already been noticed in our pages as taking a very high place. Thorwaldsen, with very large bells of great substance and fine outline, blue suffused with lilac, is very striking. Mademoiselle Rachel is a fine new yellow. La Jeunesse is a very pretty pale lilac, and Fanny, another pale lilac, has large bells and a fine spike. Admiral Coligny may also be noticed as a fine azure blue; and Lamplighter, which has improved in the size of its spike since last year, is conspicuous from its white eye contrasting with its otherwise dark colour.

The early Tulips when we saw them were in splendid condition, and are evidently deserving of more extended cultivation, on account of their highly decorative character. The best were Cottage Maid, rosy pink, bordered with white; Proserpine; Cramoisie Royal; Duc d'Arenberg; Vermilion Brilliant; White Pottebakker; Fabiola; Roi Pépin, pure white and crimson; Monument, bright crimson; Keizerkroon; Tournesol, and Yellow Tournesol. Couleur Cardinal, scarlet; Rouge Luisante, deep rose; Marquis de Wessenrode, Bizard Pronkert, yellow and red; Florida, purplish violet; Imperator, double crimson, and several others were also well deserving of mention.

The Exhibition will continue till the third week in April; but we would recommend those interested in Hyacinths to lose no time in visiting it, as most of the flowers are now in perfection.

DECORATING VILLA GARDENS WITHOUT PLANTING DECIDUOUS TREES.

Why should not a suburban garden in winter present a comfortable and well-furnished appearance? But this cannot be given so well by deciduous trees and shrubs as by evergreens.

If there were but few evergreens, and we were, therefore, obliged to use whatever could be had, there might be some show of reason for planting so many tall Poplars and other strong-growing trees. Surely it cannot be that English families are afraid of their neighbours seeing over and beyond the next gardens to their own; but the possibility of doing so is to a certain degree done away with where the situation is almost a dead level, by the unneighbourly practice of planting trees which are better adapted for park or forest scenery, than for the confined space of a villa garden. By way of illustrating what I mean, I will state what I have seen adopted in a somewhat fashionable neighbourhood for villa residences. Most of the gardens are small—from a quarter to half an acre in extent; some may be more, but the majority are of the size which I have stated.

Many of the divisions between these gardens are of strong iron wire, almost completely hidden by the evergreen shrubs which are planted against it. This partly prevents the cramped appearance which the limited extent of the ground would otherwise give. When a wall is used and deciduous trees are planted close to it, of course, evergreens cannot maintain their proper character, and, as a consequence, the boundaries of the little garden have a mean, naked, anything but cheerful appearance; but in the gardens to which I refer nothing of this kind is detected. Sweet Bay, Laurustinus, common and Portugal Laurels, Evergreen Oak, Phillyreas, Hollies of sorts, tree Box, Arbutuses, and sometimes Arbor Vitæ are planted. I may observe that many of these, with careful and judicious handling, can be pruned and kept to almost any shape suitable for villa garden decoration.

Whilst I am passing some of these cottage and villa gardens in winter, I often think how charming and comfortable they appear, although they may not have any gay-coloured flowers in their beds and borders, and, of course, these are not looked for in winter; but from the absence of tall deciduous trees and shrubs they have a good deal of the appearance of a winter garden. In some instances the Laurustinus is pretty largely used, and when this shrub is pruned at the proper time it will grow again and ripen its wood and produce its charming clusters of flowers in the following season. When this shrub succeeds well it will soon grow sufficiently high for any purpose for which it may in ordinary cases be required in villa gardens. In the gardens to which I have referred, you will not see corners here and there of sickly-looking grass struggling for an existence, as is too often the case under deciduous trees. Most of the shrubs which I have named will, in ordinary cases, soon grow quite high enough, if desired, to screen the one garden-promenade from being seen by the next-door neighbours; but to my mind no deciduous trees in these small gardens can ever give that charm during the long winter months which those evergreens will do when well managed.

I had almost forgotten to name the *Aucuba japonica* with its pleasing green and yellow-blotched leaves, and a few others which will readily occur to many persons. However, I must not forget the *Cotoneaster microphylla*, a very hardy plant, and one, too, which of late years I see is being made use of, and which is, in many cases, very ornamental.

Now with the aid of the evergreens which I have here enumerated, a nice selection and variety of foliage may be had. These judiciously arranged and well attended to, along with good grass, good yellow gravel, and fresh-dug beds and borders, give to a villa garden even in winter a comfortable and pleasing aspect, which no amount of tall Poplars, Limes, and Elms can ever produce. I would advise all persons who may be interested in these matters, whenever they are passing any of these villa residences to observe and note for

themselves the different characters which are to be seen in different neighbourhoods, then let them compare these at different seasons of the year, and take them as representing the whole round of our seasons.

I have already remarked that I know some of these gardens where the dividing fence is iron, in some it is of strong wire, in others of upright iron pallisades hidden amongst the shrubs, which assist in removing the too often stiff and formal outline; but, of course, here one must always expect to meet with stiffness to a certain degree—the confined space necessitates this.

The shrubs which I have here spoken of, with the exception of two or three, will bear cutting and keeping in formal outlines, but always, if possible, let them be cut-in at the proper time. By this I mean they should be cut-in about the early part of the summer, just allowing them sufficient time to make a little young wood before autumn sets in, which greatly relieves their stiff outline. Some of these shrubs, I know, are so managed that they never grow beyond 3 or 4 feet high; but, of course, they may be allowed to grow to 6, 8, or 10 feet, or even more just as the position may render advisable.

I have often thought how very graceful the Deodar Cedar looks, even while in its young state, upon a small piece of grass. Plants of it are now by no means dear, and a more beautiful and graceful evergreen can scarcely be found. For adorning the outlines of a border, or even as single specimens upon the grass, whether in small or large gardens, I also would strongly recommend *Rhus cotinus* and *Euonymus japonica*, the former for its beautiful plumage-like clusters of half feather-like flowers, which it produces, and which hang upon it in the latter part of summer and autumn. The *Euonymus* may be had with both green and lightly-spotted foliage, and bears cutting-in remarkably well. *Garrya elliptica*, from its very graceful clusters of pendant catkins, which are generally produced in great profusion, offers a pleasing contrast amongst other things, and is likewise suitable as a single specimen. Nothing is better as a variety than a few Yews—the common Yew, the Irish Yew, and the Golden Yew, together with a few of the Variegated Hollies. The nearly white-leaved section, and the yellow or golden-leaved section, as well as many of the green-leaved kinds, are all in their way very ornamental, and afford a beautiful variety.—G. DAWSON.

THE DUCHESS OF BUCCLEUCH GRAPE.

BEING at Dalkeith a few days ago, and having an hour to spare, I embraced the opportunity of calling at the Palace Gardens there. I was fortunate in finding Mr. Thomson at home, and still more so by seeing this new variety of Grape in an early stage of growth. I was shown into a lean-to house, where there are a number of plants of it fruiting in pots. There are also some Black Hamburgs in the same house, but entirely eclipsed by the Duchess. On entering the house I was truly delighted, nay, astonished, by the profusion of bunches showing upon these young Vines. The rods are about 8 feet long, good stout Vines, though not extra strong, they having been grown under the shade of Vines last year, consequently not so well matured as they would have been under more favourable circumstances; nevertheless many of the shoots are showing large bunches at the third and on to the fifth leaf, proving to a certainty its free-bearing character as an early Grape. I had the curiosity to measure some of the bunches, which, though not yet in flower, measured 14 inches in length exclusive of the stalk; bunches tapering, lightly shouldered. Some idea may be formed as to what they will be when fully grown, and this, be it recollected, from pot Vines, and started on the 1st of January last. I had also the pleasure of seeing it in another house a stage later, but here they are planted out. The bunches were just showing, and the buds had the appearance of being literally packed with bunches, indicating still more fully the free-bearing character of this new Grape. The flavour partakes of that fine Grape *Chasselas Musqué*, which is the parent crossed with *Muscata*, but free from the cracking nature of that variety. It was exhibited last year at Kelso, where it carried off the first prize for the best-flavoured Grape from all comers.

I would thus early in the season draw attention to this new Grape, that one and all may observe and judge for themselves, as I understand it is to be sent out in the autumn of the present year; and amongst the many new Grapes of recent introduction I am convinced the Duchess will secure a place in the foremost rank. Trusting you will give this a corner in your valuable Journal.—A. ANDERSON, *Oxenford Castle*.

REPAIRING TOOLS.

By good management the labour of repairing tools is much lessened. Selecting the strongest and best made, and using them with reasonable caution, breakages would rarely occur. We do not mean to say that tools could be as perfectly constructed as Dr. Holmes' "One-horse Chaise," which lasted a hundred years, and then fell to pieces in a moment at every part, so perfectly was its strength equalised throughout; but a careful selection from the best manufacturers will prevent many of the accidents which happen to implements and machines made by bunglers. Repairing forms a considerable part of every business. Some of this may be done at home with little trouble. In other cases it is best to employ at once a mechanic, especially for repairing all large articles, such as thrashing machines, waggons, ploughs, &c. A little skill will often be very useful, however, in winter, and on stormy days, in repairing smaller tools and implements, and for this purpose a supply of proper materials should always be at hand. One of the most useful articles is copper wire. It should be kept of different sizes. It is one of the strongest metals, except iron, does not rust through, and is almost as flexible as leather, allowing it to press closely and fit the parts, and twisting in a close coil. Wherever portions of wooden tools are split, a few bands of copper wire will effect a substantial repair in a few minutes. Next to copper wire, in value, are strips of sheet copper. These are very useful on larger pieces of wood, split plank, or split timber. Lay the strips of copper across the fracture, or pass them around in the form of bands, and then secure them to their places by driving in small nails, and great strength will be imparted. If the wood is very hard the points of the nails should be dipped in grease, which will cause them to drive freely.

When copper wire cannot be had, very strong bands may be placed around fractured rods of wood as follows:—Procure the smallest-sized annealed iron wire (not much larger than horsehair, which, although so small, is very strong), and use it so as to form a neat band around the fractured rod; then heat the wire in the flame of a lamp, turning it over, so as to warm every part alike, and then apply a stick of burning sealing-wax to the band, afterwards heating and melting the wax thoroughly into the wire by turning it in the flame. The iron and wax thus become thoroughly incorporated together, and form an exceedingly hard, strong, and durable band. This is an excellent mode for mending canes, umbrellas, &c.

Prepared glue is a very useful substance to keep on hand for mending all small wooden tools and vessels. It is easily made by dissolving good glue in alcohol in a large-mouthed bottle. In a few days the glue will be perfectly diffused through the alcohol, and the mixture ready for use. If too thick add more alcohol; if too thin allow it to evaporate.—(*American Country Gentleman*).

PUTTERIDGE BURY.

(Concluded from page 176.)

NEARLY opposite the chain-beds of climbing Roses on the other side of the walk, and sheltered from the west wind by three fine specimens of Elms, is a circular group, extremely simple as to figure, but very beautiful as to planting. The centre circle has a plant of Scarlet Geranium in the centre, 8 feet high. The other eight beds round it had each a plant in the centre of Pearl of England Fuchsia, from 5 to 6 feet in height. The four large outside beds had each a large Scarlet Geranium in the centre, 4 feet high, these plants having been in the same pots about sixteen or more years, and near each end a dark Fuchsia about 5½ feet high.

The four smaller outside figures had each a Honeysuckle | Nasturtium. The accompanying engraving shows the out-
in the centre, and this in autumn is covered with the canary | line of the beds in this group and the planting.

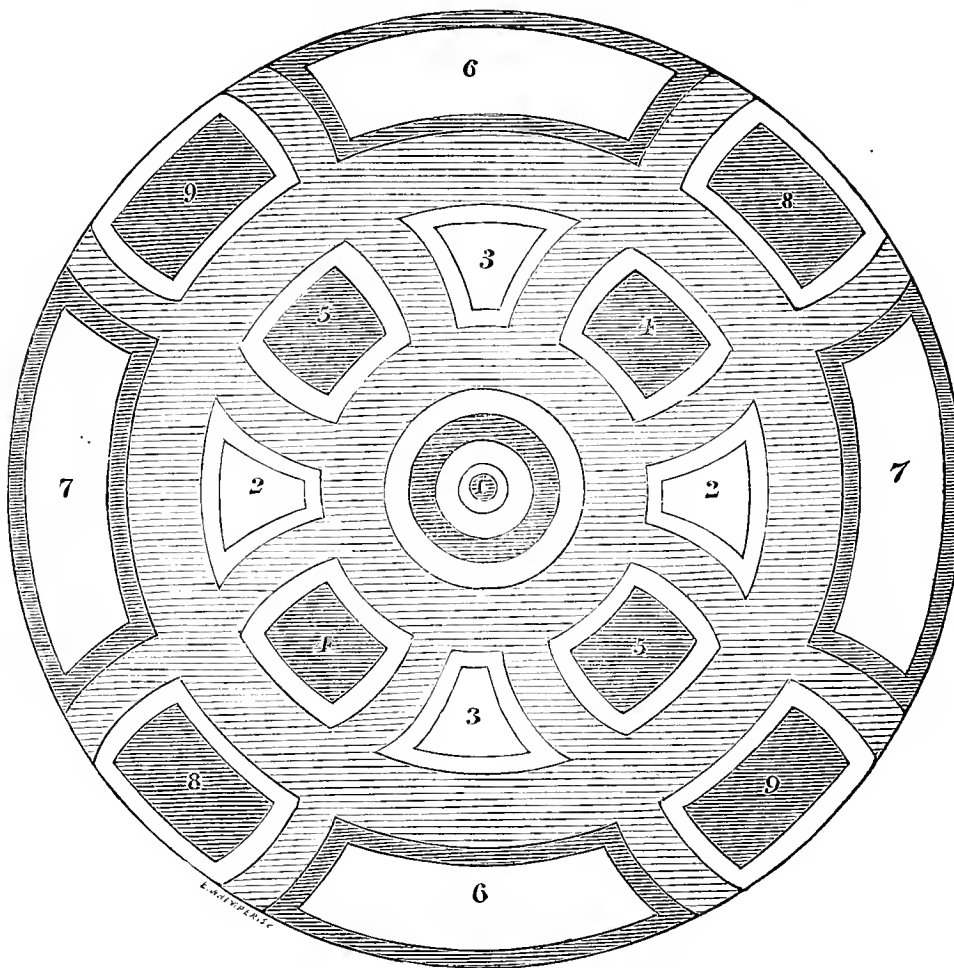

- | | | | | | | | | |
|--|--------------------------------------|------------------------------------|--|--|---|--|--|--|
| 1, Defiance Geranium; England's Glory Fuchsia; Madame Vaucher Geranium and Mrs. Holford Verbena mixed; Lobelia speciosa; edging, Cerastium tomentosum. | 2, Christine Geranium; edging, Alma. | 3, Rubens Geranium; edging, Bijou. | 4, Stella Geranium; edging, Cloth of Gold. | 5, Boule de Feu Geranium; edging, Cloth of Gold. | 6, Aurea floribunda Calceolaria; edging, Charlwoodii Verbena. | 7, Aurantia floribunda Calceolaria; edging, Purple King Verbena. | 8, Very dark seedling Petunia; edging, Tropæolum Triomphe de Hyères. | 9, Countess of Spencer Petunia; edging, Tropæolum elegans. |
|--|--------------------------------------|------------------------------------|--|--|---|--|--|--|

Between this group and the ribbon-borders there is a nice piece of lawn with single shrubs, &c., on it.

The border next the wall is about 330 feet long and 14 feet wide. The wall is covered with Roses, Ceanothuses, &c. A space has to be left between the wall and the front row in the border. It was planted so as to slope to the walk in front, from which it is separated by 18 inches of verge. This year this border was planted in straight lines. We may mention that the beds and borders are generally cropped differently every year. There were eight lines, beginning at the verge—1, *Cineraria maritima*; 2, Brilliant Geranium; 3, *Calceolaria Aurantia multiflora*; 4, *Perilla nankinensis*; 5, *Pyrethrum grandiflorum*; 6, *Trentham Rose Geranium*; 7, tall *Ageratum*; 8, *Salvia fulgens*. The opposite border is a little shorter on account of the shade of the Elm trees, and was made double to face both ways, so that next the walk there was a sloping bank of flowers on each side down to it. The planting was the same, the *Salvia* being the centre row, and then each side alike. In this border there were pillars along the centre, some 18 feet apart, connected with festoon chains for creepers. Last year these borders were curved in various forms. The walk being straight the lines were seen distinctly and yet were close to each other from

end to end, and there did not seem to be a plant wanting. Mr. Fish, however, told us of a failure though not noticed. In fact, owing to the inability to give water in the dry weather, the *Pyrethrum*, beautiful at first, had failed or not at all equalled the others. We saw only seven rows instead of eight, as the *Perilla* and *Trentham Rose* were made to meet over the *Pyrethrum*. Mr. Fish, however, thought the border was not so fine without the white *Feverfew*. The season before it did remarkably well.

We might go on describing ribbons and groups in front of shrubberies, in which fine effects are produced by extreme simplicity in planting and the use of common materials, but must conclude, merely mentioning Dahlias, Hollyhocks fronted with dwarf Dahlias, the total absence of weeds and littering leaves, the beautiful condition of the walks, and the fruit trees, both in houses and out of doors, loaded with fruit.

Though we did not go through the village of Lilley, we saw enough of the cottages on each side of Putteridge, to know from their appearance where the property of Colonel Sowerby commenced, cottages in which neatness, comfort, and picturesque effect were studied, rather than any remunerative per-centage in the shape of rent.

POTATO SEEDLINGS.

A GENTLEMAN signing himself "John Ward," and writing to the *Yorkshire Gazette*, gives the following recipe as an antidote to the Potato disease:—"Procure as many Potato-apples as you can get, dry them in the sun a few minutes, cast out all the bruised ones, place them in strong earthen jars or boxes, and bury them deep in the earth, secure from frost. In spring have ready a plot of ground the same as you would prepare for Onions. Sow the Potato-apples thinly on the ground, covering them thinly with fine rich soil. Prepare a second plot of ground, and when the plants are strong enough to pull up without breaking, transplant them into your prepared ground, as they spring up in myriads and are liable to become entangled. Have your ground ready in the usual way, and when the plants are strong dibble them in, not too deep, taking care they get at the manure at once. When they have begun to grow a top-dressing of diluted liquid manure is the best thing that can be applied.

"The result is curious and gratifying. The plants grow strong and vigorous; they flower, apple, and potato; and are ready for taking up quite as soon as those produced in the usual way. You will have three or four distinct specimens of new varieties, a better crop, one-fifth heavier in weight, a fine clear skin and shapely appearance, and, in fact, quite a new and regenerated vegetable."

Now, I have always understood that the tubers of Potatoes grown from seed do not come to perfection for three years, and I am not the only amateur who holds that opinion. But I may be wrong. I shall take it as a favour if you will let us know the effect of sowing the seed of the Potato-apple as far as regards the time the tubers require to mature. I do not dispute the assertion of Mr. Ward as to the sowing of the seed staying the disease, but that is not the point in question.—CALCARIA.

[Mr. Ward is quite wrong. The first year the tubers of seedling Potatoes are very small, and never fit for table use. The second year some of the tubers are of a size about that at which forced Potatoes usually are cooked; but not until the third year are tubers produced of an adult size.]

WORK FOR THE WEEK.

KITCHEN GARDEN.

SOWINGS may be made early in the month, on well-situated beds, of Brussels Sprouts, Chou de Milan, Broccoli, early Cabbage, a small quantity of Cauliflowers, Green Kale, Leeks, Savoys, and Turnips. Sow more Broad Beans, and a succession of late Peas; the Blue Prussian, and Knight's Dwarf Marrow, are varieties well adapted for general purposes. It is advisable to sow them wide apart with other vegetables between, and not to huddle them together in masses, as is the usual practice. Early Peas should be staked, and well attended to, fir or yew branches put on the outside of the stakes will shelter them from withering winds, which are more to be dreaded than frost. Prick-out early-sown Celery, Cauliflower, and Walcheren Broccoli in a warm border, and protect them a little. This Broccoli, when true, is the best ever introduced, as it produces fine heads in the driest summers. The main crop of Onions may be sown when the soil is dry and well prepared, a week or two's delay on account of unfavourable weather is of little consequence if the above particulars are observed. The Silver-skinned variety should also be sown for pickling purposes: under the shade of trees, or where the ground is hard and dry, is the best situation for them. See that a good breadth of second early Potatoes be now planted. Protect Ash-leaved Kidneys, and other early varieties as soon as they appear above ground. Sawdust is as good as anything, and it can be raked off when all danger of frost is over. Make frequent sowings of Lettuces, Radishes, Horn Carrots, Mustard and Cress. It is a good rule to sow successions of these when the last is fairly above ground. See that fresh beds of Thyme, Mint, Sage, Winter Savory, and other herbs are made, they generally want renewing every year. Plant Jerusalem Artichokes, Sea-kale, Rhubarb, Horseradish, and Shallots, if not already done. Clear off the old stumps of

Coleworts, Savoys, Brussels Sprouts, Broccoli, &c., if not wanted for sprouts.

FLOWER GARDEN.

Nothing adds more to the beauty of a place than fine smooth turf; and where there is sufficient labour, it is a great improvement to extirpate daisies, whose flowers mar the effect of a lawn very much. Retouch the grass edgings of the walks with all care and precision, and turn old or add new gravel where necessary. Complete any planting which circumstances compel you to do, but otherwise do not choose this season. Remember there is no time like early autumn. Complete the pruning and training of Clematises, Jasmines, Bignonias, and other creepers on trellises. Sweep and roll the lawns well, taking care that they are closely cut down now, thus laying a good foundation for the season. This is of great importance. Well-managed rockwork is very pretty, but it is difficult to hit the happy medium between the picturesque and the confused. Study to do so.

FRUIT GARDEN.

See that recently-transplanted fruit trees are not suffering for want of water—a circumstance which, however, will hardly happen, except on dry, porous soils, and in such cases the ground should be muled with decayed manure or leaves, to preserve it in a uniformly moist state. Top-dress Strawberry-beds with rotten dung or leaf mould, if not done in the autumn. Plants forced one year, and planted out, produce the largest and finest crop of this delicious fruit. The British Queen, and Myatt's Pine, and other more shy sorts, never fail to produce a crop. Tie down the branches of the Pear trees, trained *en quenouille*, before the buds swell too far. Prune and nail Figs.

GREENHOUSE AND CONSERVATORY.

Orange trees whether in tubs or the open borders must be examined. Remove the surface soil down to the roots, and after giving the plants a good soaking of tepid water, top-dress them with rich compost—such as good mellow loam and leaf mould, to which may be added about one-third of sheep or pigeon's dung perfectly decayed. This is a good time to start *Leschenaultias* of kinds, giving them a liberal shift into decayed turfy peat and sand, to which, if it be not rich, some good leaf mould may be added. *Boronias* delight in a similar soil, as do most of the free-growing hardwooded plants. Examine the balls of those plants closely which have not been shifted, and see that they are in a proper state as regards moisture, for as the sun is gaining power those plants which are dry at the root will soon begin to droop and may ultimately perish. Young Heaths which are growing on should have their flowers removed to give strength to the plants, and see to stopping loose growth as soon as the plants have recovered their shaft.

STOVE.

Stimulate the young growing plants as much as possible—that is, consistently with the state of the weather; and while you give plenty of air at all times, guard against sudden changes and cold cutting winds. The tan-bed, where the good old plan is followed, must also be attended to. Add some fresh material and turn it over, but guard against inducing violent fermentation. Increase the atmospheric moisture gradually, and syringe on clear mornings. When the weather is changeable and the sun glaring it will be necessary to shade some of the free-growing plants slightly, but as a general rule it is advisable to dispense with shading as much as possible.

FORCING-PIT.

Introduce fresh plants for succession as fast as others are removed to the conservatory. Pinks which have trussed up will be better in a milder heat, and Lily of the Valley should be removed to a lower temperature as soon as the first flowers are open. Keep a brisk growing temperature with plenty of air and moisture in clear weather, and avoid crowding your plants as much as possible. Sow in a warm corner a pan or two of Chinese Primulas for next autumn, and those who delight in Balsams and Cockscombs, &c., should make a sowing if not done already.

PITS AND FRAMES.

Propagate diligently what you are short of. Divide and pot Lobelias. Take up some old plants of *Oenothera macrocarpa* to propagate in a gentle heat. W. KEANE.

DOINGS OF THE LAST WEEK.

KITCHEN GARDEN.

KEPT on planting *Potatoes*, as the ridged-up ground is nice and mellow; placed the dry surface soil over the spring sets of *Potatoes*, planting rather shallow, and leaving a nice ridge over the rows, forking the ground nicely over as we proceeded. We have, at times, in such ridged ground placed the *Potatoes* in the trench, and levelled the ridge down upon them, but do not like this so well as spading and forking the whole ground over as we proceeded, so as to leave the whole in an open friable state without the compression of a footmark. Here, as is often the case, the saving of a little extra labour is not all gain. For such small-topped kinds as *Frames*, *Ash-leaved*, &c., we generally leave 2 feet between the rows, which permits of planting vegetables before the *Potatoes* are taken up, and the moving of the ground then gives a good chance of assisting the vegetables. In order in a small space of ground to get room for *Peas* we generally leave a space of 4 feet between each six rows of *Potatoes*, which we will sow with *Peas* some 3 to 4 feet in height, which will come in about the same time as the *Potatoes*, or shortly afterwards. The *Peas* will thus stand 14 feet apart, and thus will produce more than when sown in rows in a quarter—a fact of some importance to amateurs and cottage gardeners, a single row of staked *Peas* always producing more in proportion than three or four rows that are only 4 or 5 feet asunder. The outside rows of such a quarter will thus in general be the best. Planted-out *Broad Beans* that were sown in turves under protection. The *Peas* so sown we will defer planting for a few days, as the winds are still cold, and the nights, as on Thursday, have been frosty. The roots have now gone through all the turf and into the rough leaf mould and soil beneath, and, taken carefully up, will get sufficient check to bring on the blooming process sooner. *Peas* in pots just beginning to show bloom have been moved to the back of the orchard-house, the forward part of which is now arranged and in bloom. The earliest *Peas* out of doors have been unmolested by the birds since the black string of old cotton was run along a few inches above them. Other crops of *Peas* and *Beans*, not yet above ground but beginning to peep, have also been little interfered with by either mice or birds, owing to being covered over with ashes from the furnaces. When they were sown and planted the ground was rather moist, though well stirred, and the seeds were deposited in drills from 2 to 3 inches deep, rather wide at bottom, and then the drill filled with these ashes. The seeds kept so sound and are coming up so strong and clear, that for early sowing we will repeat the practice: no vermin seemed to go near them. Sowed another piece of *Onions* of the *White Globe* and *James's Keeping*, and will sow a little bit more in a fortnight, and then once a-month all the summer for salading and soups. The two or three sowings of the main crop render the thinnings more useful than if sown all at once. Will sow the main crop of *Carrots* next week and a little *Beet*, reserving the main sowing of the latter and *Salsafy*, *Scorzonera*, &c., to the middle and end of April.

Regulated herb-beds, and made a fresh piece of *Sage*, &c. *Chives* are a most useful little vegetable for soups, and are, we think, for many purposes superior to small *Onions*. *Chervil*, *Carraway*, *Parsley*, *Thyme*, *Borage*, &c., should now be sown. *Mint* should be divided, and planted as soon as the young shoots are an inch in height. It is safest to make a fresh bed every year, where green *Mint* is in demand all the summer. The high winds had unsettled the collars of the quarter of *Cabbages*; firmed the earth about them, and forked over the ground between the rows, and gave the plants a little manure water, keeping the water from the leaves. If the dry weather continues, will water again, and then give them a final earthing up. We lost a few of our first planting from rabbits getting at them; and, therefore, though the quarter is filled, the fresh plants put in to supply deficiencies are not so large as the others, and the plantation does not look so level all over as we like to see them. To keep out the marauders we were obliged to place a net all round the *Cabbages*. Stirred the ground amid a quarter of *Broccoli*, and gave the plants a good watering with manure water. The plants were put out after *Strawberries* were dug down, and were short and not very large during

the winter, but strong and bushy. They had a few *Laurel* branches laid over them in very severe frost. Much stronger plants, though laid down with their heads to the north or the west, and a little protected too, have suffered much more—in fact the comparatively hardy *Purple Sprouting* in this forward lot was pretty well killed off. Such results make us more anxious to fall back on the *Scotch Cabbaging Kale*, *Cottagers' Kale*, and *Variegated Kale* and *Brussels Sprouts*, which hardly any of our winters will injure. A very dwarf *Curly Kale*, sent out by Mr. Veitch and others, is very hardy, and may be planted thickly, but it does not give cuttings like the *Scotch Cabbaging* and others. After a good frost all these *Kales* are truly delicious when boiled well, with a little soda in the water.

When any of our cottage friends get anything very good in the *Kale* way and wish to be more certain of the variety than they might be from seeds, and at any rate to have a plantation in before the seeds are fit to sow, a good plan is to nip off the side shoots close to the stem, when the shoots are some 4 inches in length, and plant them firmly in rows like young plants. A few may show bloom which must be nipped back. By this means all such hardy plants may be continued without sowing seed and give a good produce, which will be true to the kind. Have any amateurs tried the heads of *Brussels Sprouts* after being slightly frosted? The cutting them off causes the sprouts on the stem to come faster; but nice as they are they are not so delicate as the top or crowns. If the crowns are cut off in damp weather, it is well to place a piece of earth on the cut with the hand, or clay, to prevent moisture entering, which might burst the stem if severe frost followed. We never, however, saw above a score of plants so injured in all our experience.

Dining at a farmer's market table some time ago, we were rather amused at hearing one farmer giving the name of *Brussels Sprouts* to three or four neighbours who had never seen them before; and after telling them quite rightly how to sow and plant, he gave an account of the derivation of the name almost as good as a farce, though we suspect he drew on his own fancy for most of the details. On our last visit to Scotland we found cottage gardening very much improved; but were we to look back some thirty years we should find little worthy of imitation by cottagers except one thing. Then, in cottage gardens, *Scotch Kale* was sown in beds in the autumn like *Cabbages*, and if not transplanted in autumn, was transplanted in the first days of spring, instead of being sown then as in England. From these *Greens*, early in summer, stewings were taken—that is, the plantation was gone over and, perhaps, the half of the largest leaves was nipped off with a knife. The cuttings thus procured were next to endless before good-hearted *Cabbages* came in, and even afterwards. This docking of the leaves when nice and tender did nothing to prevent the plants becoming large in summer and autumn for the winter. Thus treated there would rarely be a want of *Curly Greens* for the *Scotch brose*, for which the north is famed. Whether thus treated or not, we wish that the *Scotch Kale*, *Cottagers' Kale*, and *Brussels Sprouts* were more commonly met with in our cottage gardens, as something to fill the pot with in winter. For labourers who have dry food chiefly for their dinner, a cooked mess, in which vegetables form a part, is a capital thing when they go home.

Removed the stumps of last season's *Cabbages* to the burning and charring-heap, and cut the ground out into beds 4½ feet wide, and 4 feet between the beds, which will come in ultimately for *Celery*. We wanted to get rid of the material of an old hotbed, and made the trenches, that the dung, &c., might go there at once. We used to sow *Peas* on the top of such ridges, which so far shaded the *Celery*, but these wide trenches we think we shall want chiefly in the first place for bedding plants. We have, therefore, made them into temporary earth pits. As the beds run north and south, the west side will be about 6 inches above the natural level, and the east side about 18 inches. The ground as thrown out being well trampled at the sides, the sides are cut straight and firm with a line, and a little litter thrown over them, to prevent the frost crumbling the sides down. A little litter over all enables a person to go about clean in any weather. These will answer the purpose as well for the time as the best pits. Mind, however, we would rather have regular

pits of brick or wood for all that is wanted, and we would prefer glass to any other covering; but still these makeshifts are very useful, and add very little to the labour that would be otherwise required. We notice Mr. Glascock recommends concrete pits. Of course, they will be better than earth, or even than turf. However, we may mention, that our turf pits never trouble us with the grass growing inside, or but little, and the heaviest rain seems unable to make them damp if there is a sloping bank of grassy turf from them. In a recent article the inquiry was how to make earth pits and turfpits, and not other more expensive kinds. We presume that Mr. Glascock will take away the boards as the concrete firms. We join in the request of the Editors as to the proportions of the concrete. To be firm the lime will cost something, and the gravel, sand, or ashes, would require to be clean. Where wood is to be used as a lining, we know of nothing more cheap and lasting than placing the fair side of slabs inside, leaving the outside, and making a wall round it outside of gravel or earth, well tarred and gravelled on the surface. Such a pit, however, should be made a few months before using it for anything.

Took up a bed of Sea-kale, and put it in the Mushroom-house for the last lot this season. Put pots on some rows out of doors, and covered with a little stubble to prevent frost acting on the pots. Put also a cone of ashes over other rows. When the ashes are raised up will either cover with pots or a little litter. We noticed what is so well alluded to by Mr. Wighton, page 233, as to the fibrous matter left as the remains of leaves that had not been removed. We have never noticed it so strong before; it seemed as if it would have done for ropes or cordage. The peculiarity of the water may have had something to do with it. To prevent anything like stringiness in the plant when used, we agree with Mr. Wighton that the chief remedies are quick, not too quick, growth and quick consumption. This holds also with forced Asparagus. Take a bundle out of a frame where the temperature is just high enough, and not too much air given, thoroughly green for 6 to 8 inches in length, and it will be sweet, soft, crisp, and juicy almost to the bottom. Take a dish from the same place, where, owing to having too much at once, you expose or give a great amount of air, even in cold weather, and though the stems be equally green and nice to look at, they will eat much harder and be more stringy. If forwarded in a cool place, and only the point exposed, the point will be almost the only part tender: hence the importance of successions, and not too much at a time. Here the market gardener, and the gentleman's gardener, and the general farmer must act differently. A crop is what is wanted in the one case; in the other, the crops must be numberless: hence those who crop market-garden-fashion in a gentleman's garden are apt to give glut to the establishment. The great point is never to give too much of any one thing, and to do this there should never be too much of any one thing at a time. The greatest rarities become distasteful when presented in too great abundance. We have known luxuries and scarce things disrelished merely because they had been too abundant and common.

Thinned Turnips under protection; sowed these and Radishes on a sloping bank. Will spawn in a day or two the last Mushroom-bed in the house; and strewed a little dry hay on the sides of the beds in bearing, as, with all our care, the woodlice generally assail us about this season. We move the hay in the morning, and run some boiling water over the woodlice. Boiled Carrots, boiled Potatoes, &c., placed in the bottom of a small pot, laid on its broad side and filled loosely with dry, hay are also a good trap for them. The pots may be emptied in hot water, hot enough to scald them at once. There are few old gardens in which these woodlice do not take up their abode, and, if not kept down, they would soon make havoc with everything tender. Planted out Cucumbers in frames. Sowed French Beans for succession in beds, &c. Will try and keep them out of the forcing-houses, for thrips are easier propagated than destroyed. Sowed Cauliflower under glass. Planted out Cauliflower, and stuck a few pieces of Laurel along the rows.

FRUIT GARDEN.

Very much the same, as to generalities, as last week—pruning Apples, and pruning, washing, and nailing Peach trees; and will protect with a few Laurel branches. Apricot

trees are thus protected whilst dangling from the walls, which keeps them back. Will prune, nail, and slightly protect again, as soon as we can. Moved Strawberry plants done bearing, and brought in others from frame. Have long proved that, after being set, Strawberries will swell and ripen in a high temperature, and even in a shady place, but they will be far inferior in flavour to those grown in the full sun, with plenty of air, and a temperature of from 55° to 60° at night, 60° to 65° in dull days, and from 70° to 85° in bright sunshine. Watered Figs and Vines in-doors. Regulated Vines, as mentioned last week. Potted-off Melons, &c. Disbudded Peach-house, not doing too much at a time, and thinned out the blossoms in the earliest orchard-house, as on some trees they are as thick as ropes of Onions.

We have found this *thinning of flowers* not only easier than thinning fruit, but also one of the best means of securing fruit to thin. We recollect of some Noblesse Peach trees that used to set their fruit badly until the blossoms were well thinned, when they set well. Some of our trees against the back wall are old and present no good appearance, as they had suffered from frost before the wall was fronted with glass, but there is no want of healthy blossom. Several inquiries have reached us as to the growing of fruit trees in pots in these lean-to cheap houses. We can say little against them ourselves. Last season, and slightly the season before, we were worried with the brown beetle aphid; but still the pots did fair, and would have done better had we thinned the fruit more, which we shall do this season. We suspect the plague came with a few plants we purchased. Green fly is nothing to it. However, we trust we will get rid of it this season, and will keep a sharp look-out.

Now as to this *growing in pots*. We think it is peculiarly fitted for small places where much variety is wanted in little room, and where every bit in that room will give something useful. We see no difficulty in getting fine fruit if there is enough of heat and plenty of thinning; and if the pots are set thinly enough for air and light to go all round them, there will be nothing so much amiss in flavour. There will be no comparison in the labour required for such plants in pots and plants turned out, either as standards or trained to a trellis against the glass, but about 15 or 18 inches below it. To take such a trellis up the roof all the way, the back wall would then become useless for fruit-bearing; to take it up half way would leave the back wall for a crop except at the bottom. To have one of these trellises and the trees turned out would be, perhaps, our favourite mode. But we wanted to try this pot-system, and we are sure it will answer where the necessary trouble and care are given. It is an especially good plan for obtaining much in little room from Plums and Cherries. Most of our plants were obtained as dwarf maidens, were potted, pruned, and nipped-in the first season, and bore the second, and on both Peaches and Nectarines we had just two heavy crops, and out of the lot some two or three Golden Drop Plums produced so heavily as pretty well to prevent enough of wood being made. Some Pears were also covered with fruit-buds the second season after being grafted, as well as Plums, Cherries, and Peaches. If not overcropped, this early maturity as to fruit-bearing does not seem to exhaust the vital forces of the plants. To save trouble, most of our pots were half plunged in the ground, and the roots were allowed to go a little beyond the pots in summer, but were stopped in the autumn, to insure the stoppage of mere growth and the ripening of the wood. One chief reason, however, for having these plants in pots, was not making our mind quite up as to a trellis, and the want of material, and the want of time, for making a fresh border. Could we have made a border in the same way as we made a piece for Vines the other day, in front of this house, it is most likely we would have had the plants planted out and trained to a trellis; and that most likely will be the ultimate result, if we should have the chance long enough. The ground below the trellis would be more useful to us for many purposes than it is now, as there would be no large pots to interfere with it, and the waterings, &c., in proportion, would be trifling. At the same time, we believe there will always be something very fascinating in the pot culture of fruit trees to amateurs and enthusiasts with but little room. In many such cases the frequent attention to nipping, watering, &c., will be a

recommmendatory consideration, as the greater the trouble the greater the interest. With gardeners in general, in these days, always having more than they can get at on their hands, extra labour will always present something antagonistic. Last season, with our scarcity of water, we were even obliged to mulch the surface of the pots to enable us to do with less, and still prevent the leaves drooping. On the whole, though planting-out and trellising will give less trouble, and perhaps, on the average, finer fruit, we have no doubt that, in all cases where there is heat enough, very good plants will be had in pots if sufficiently thinned.

ORNAMENTAL DEPARTMENT.

Much the same as last week. Potting, moving, hardening-off, and making preparation for turning out bedding plants.—R. F.

COVENT GARDEN MARKET.—MARCH 26.

The supply of all kinds of vegetables in season continues ample, and importations of French Lettuce, Endive, Radishes, &c., are well kept up. Dessert Pears and Apples are scarce. Cut flowers principally consist of Azaleas, Roses, Camellias, Cinerarias, Geraniums, Primulas, and Violets.

FRUIT.

	a.	d.	s.	d.		s.	d.	s.	d.
Apples.....	½ sieve	2	0	10	Nectarines.....	0	0	0	0
Apricots.....	doz.	0	0	0	Oranges.....	100	4	0	10
Figs.....	doz.	0	0	0	Peaches.....	0	0	0	0
Filberts & Nuts	100 lbs.	0	0	0	Pears.....	8	0	12	0
Grapes, Hothouse.....	lb.	15	0	25	dessert.....	½ bush.	6	0	18
Foreign.....	1	6	2	0	Pine Apples.....	lb.	6	0	10
Muscats.....	0	0	0	0	Pomegranates.....	each	0	3	0
Lemons.....	100	4	0	10	Strawberries.....	doz.	1	6	2
Melons.....	each	0	0	0	Walnuts.....	bush.	14	6	20

VEGETABLES.

	s.	d.	s.	d.		s.	d.	s.	d.
Asparagus.....	bundle	8	0	14	0	0	0	0	0
Beans, Broad.....	bush.	0	0	0	0	0	1	0	2
Kidney.....	100	2	0	3	0	0	1	0	2
Beet, Red.....	doz.	1	0	1	6	Mustd. & Cress, punnet	0	2	0
Broccoli.....	bundle	0	7	2	0	Onions.....	ushel	4	0
Brussels Sprouts.....	½ sieve	2	0	3	6	pickling.....	quart	0	6
Cabbage.....	doz.	0	0	0	0	Parsley.....	doz.	0	4
Capiscums.....	100	0	0	0	0	Parsnips.....	doz.	0	9
Carrots.....	bundle	0	6	0	0	Peas.....	bush.	0	0
Caulliflower.....	doz.	4	0	8	0	Potatoes.....	sack	5	0
Celery.....	bundle	1	6	2	0	Radishes doz.	bunches	0	6
Cucumbers.....	each	1	6	3	0	Rhubarb.....	bundle	1	0
Endive.....	score	1	3	2	6	Savoy.....	doz.	2	0
Fennel.....	doz.	0	3	0	0	Sea-kale.....	basket	1	6
Garlic and Shallots, lb.	0	8	0	0	0	Spinach.....	½ sieve	2	6
Herbs.....	bundle	0	3	0	0	Tomatoes.....	½ sieve	0	0
Horseradish.....	bundle	1	6	4	0	Turnips.....	doz.	0	4

TRADE CATALOGUE RECEIVED.

W. Bull, King's Road, Chelsea.—List of New, Beautiful, and Rare Plants.

TO CORRESPONDENTS.

* * * We request that no one will write privately to the departmental writers of the "Journal of Horticulture, Cottage Gardener, and Country Gentleman." By so doing they are subjected to unjustifiable trouble and expense. All communications should therefore be addressed solely to The Editors of the Journal of Horticulture, &c., 162, Fleet Street, London, E.C.

We also request that correspondents will not mix up on the same sheet questions relating to Gardening and those on Poultry and Bee subjects, if they expect to get them answered promptly and conveniently, but write them on separate communications. Also never to send more than two or three questions at once.

N.B.—Many questions must remain unanswered until next week.

BULBS AND BEDDING PLANTS IN THE SAME BEDS (Agnes).—Your subject is under consideration; but, as you say, it is beset with difficulties unless fibrous plants be used for bedding that will lift well from intermediate-beds, and other things, such as Geraniums, are grown in say 40-sized pots. Bulbs might also be planted early on a hard bottom, and covered with 3 or 4 inches of rough leaf mould and soil; and then, when the bedding plants were over, they could be moved with balls in November after the beds were well prepared. The latest-flowering could also be grown in pots and the pots plunged in the beds, and be taken up when the flowering was over. Hyacinths and Tulips may be moved in lumps when the leaves get yellow at the points, and planted and well watered. As a rule we have never been satisfied with the result of plating bedding plants among beds of bulbs unless the taller were taken up.

BOOKS ON MEDICINE (A Suffering Gardener).—We know of no medical periodical which would answer queries relative to your bodily ailments, and we would warn you from consulting it if there were such a periodical. Diseases require the medical man's personal supervision; for to the experienced there are guiding symptoms which you would not think of consequence sufficient to be detailed.

CHARCOAL FOR MANURE (Mrs. Newbury).—No doubt you could obtain charcoal dust from those who deal in it, but we do not know where it can be obtained, nor the price. Soot would be quite as good for manure, and so would the charred refuse of your garden.

TUBULAR BOILER SETTING (J. L. Reading).—The No. 2-sized boilers, if we remember rightly, have not hollow grates, and are not so soon acted on by the fire as those of a larger size. In setting, the grate-bars should be 1 foot clear of the floor of the ash-pit, and above them the furnace should be made circular, so as to suit the boiler, or so that the furnace brickwork may be 3 inches wider than the boiler. The boiler itself should be 1 foot above the grate-bars, thus allowing 1 foot beneath it for fuel. A cavity 3 inches wide should be left between the brickwork and boiler all round, and this should be carried up to the top of the boiler, an opening being left at the top, 9 inches by 6 deep, to conduct the waste heat and vapour into the flue or chimney. This is how we have ours set, and we can heat 1200 feet of four-inch pipe in an hour after lighting the fire. Ours is a No. 4, and instead of consuming double the quantity of fuel of an old saddle boiler, which it displaced, it does not consume one-third the quantity. Our coal bill for the old boiler was £10 7s. per quarter, and it now is £3 5s. with the tubular boiler. Your boiler must be wrongly set altogether to give such results.

LEAF BLOTCHED (A Subscriber).—Pray what plant does the part of the leaf enclosed belong to? We do not profess to name plants by a sight of the leaf, much less tell what causes white variegation from a small fragment of a leaf. Send us the name of the plant from which the leaf is taken, and we will assign a reason if we can.

CELERY LEAFSTALK ROOTING (C. W. K.).—It is by no means unusual for Celery stalks to root in the manner yours have done. The stalks have been cut partly through in earthing-up, and roots are emitted from the upper surface of the wound. This is caused by the descending sap which is intercepted in its passage to the root, and forms first a callosity, and through it roots in time protrude. Almost all plants will do this if the stalk be placed in a medium favourable to the formation of a callosity and the emission of roots. We do not know whether stalks so rooted would become furnished with buds, and so become plants. We rather think not, at least ours never did so; but a trial would solve the problem.

COVERING MATERIAL FOR ROOF OF GROTTO (Yorkshire).—Heather, or Ling, from its rustic appearance, is generally used for the purpose, and we know of nothing more appropriate. Common roofing felt is less expensive and more durable, and may be had through any principal ironmonger. The price is 1d. per superficial foot. It will require to be firmly fastened with nails, and should be coated with a composition of gas tar one gallon, in which a pound of fat is dissolved by boiling over a fire with the tar. It should be applied to the roof with a brush whilst hot, and a little sharp sand sprinkled over it to prevent its running and having a glazed appearance. The roof will require a coating of the above composition once in four years. We have some roofs covered with this material that are as good as ever at the end of ten years.

WATER CRESS CUTTINGS (Idem).—We do not know any nurseryman that sells them; but most streams or wide ditches abound with them, so that we think you will have no difficulty. Inquire of the labourers in your locality, and they will probably bring you abundance of cuttings. The stems readily emit roots from their joints.

AMERICAN ORCHIDS (A. R.).—We will publish some notes on them in an early Number. Our correspondent desires to know where he can procure plants of *Primula imperialis*, *Dielytra chrysantha*, and *Meconopsis Walpolei*.

GARDENERS' FRIENDLY SOCIETY (W. H.).—When the gentleman who undertook the formation of this Society learned that the Government were proposing to facilitate the granting of small annuities, for which the national resources will be a security, he wisely paused. If the Government carry out their proposed plan, no one, whether a gardener or of other employment, desiring to secure a small annuity, can possibly do better than to obtain it from the Government.

JARDINIÈRE.—A correspondent, P., Brentwood, wishes to know where, and at what price, he can purchase the Jardinière, of which we gave a drawing at page 6 of the fifth volume of our New Series.

BOOK ON VINE CULTURE (A Recent Subscriber).—Thomson and Roberts on the culture of the Vine are each good authorities. Hothouses are not unhealthy, except to a person who remains in them for a long time, and then is exposed to a cold wind whilst perspiring.

HAYTHORN'S HEXAGON NETTING—COVERING MUSHROOM BEDS (C. P.).—We presume that Haythorn, Hexagon Net Manufacturer, Nottingham, will be sufficient. It will do very well for ventilators, for moderating draught in cold weather, and for keeping flies and wasps out. There is no necessity for covering your Mushroom-bed with anything, under the circumstances, as Mushrooms will grow as well in the light as in the dark, but in a subdued light we think they are more tender. Without any heat except from the manure, a little hay covering causes the Mushrooms to come sooner, by keeping the surface of the bed warm; but with heat below from pipes, and heat above, it will be less necessary to have a cover of any sort; but care must be taken that the bed is not too much dried under the circumstances.

GLASS FOR VINERY ROOF (J. A.).—Hartley's Patent will answer very well for the roof of a vinery; but for such a house we see no necessity for blinds and rollers, if good British sheet glass is used. If the leaves of the Vines are far enough from the glass, no shading will be needed to prevent burning.

CUTTING DOWN A HOLLY HEDGE (Jane).—This had better be done as early as possible, and a portion of the stems may be cut as low as convenient, while, if possible, one or two branches of each plant ought to be left with foliage on. Evergreens do not like to be entirely denuded of their leaves; those branches that are allowed to remain may be rendered less unsightly by being tied down to the low one, and in another reason they may be removed altogether.

DOUBLE AND VARIATED DAISIES (Ada).—We fear your soil is wet and cold, and the situation bleak. We advise you to have a sufficient quantity planted in nursery-beds, in a dry situation, in a compost formed of any light loamy soil, early in autumn, and to plant them with balls, in their final situations, in March following. Slugs can be kept from eating them by scattering soot round the plants, or a little quick-lime over them occasionally in dry weather.

ENDIVE (Idem).—We usually sow the Batavian and Curled Endive—the first sowing the last week in June, and this comes into use in October and November, some being placed in dry sand in a dark shed or cellar, and a frame or two filled with the remainder, which is blanched by placing in sand at intervals of a fortnight, or by tying the leaves of the Batavian, and placing a pantile or inverted flower-pot over the Curled. We sow again the second week in July, and, after transferring into beds, transplant into frames early in November, and protect in severe weather with mats or other covering material. The last sowing is made in the first week in August, and this is planted the second week in September, close to a south wall, and it comes into use in the February and March following. We know of no better protection than planting in frames, and covering them in frosty weather with mats or dry litter.

CELOSIA AND MIMULUS MACULOSUS (T. C.).—These do well in a compost of turfy loam two-thirds, and leaf mould one-third, with a liberal admixture of sand. Pot the seedling Mimulus into small pots when large enough to handle, and when the plants have made four leaves pinch out the points of the shoots. Repeat when the pots become filled with roots into 48's, and when these become filled with roots, transfer them to 24's or six-inch pots. The compost recommended for the Celosia will grow them well. You may flower them in 48-sized pots, but the flowers will be poorer, and the plants proportionately smaller than they would be in larger pots.

VINE LEAVES RUSTING (An Amateur).—We think the steam generated by the fermenting fresh manure and leaves has been rank, or the materials not sufficiently turned over to sweeten before putting in the house. We cannot see anything beyond this that could possibly cause the leaves to be injured as yours are, unless they were wet from syringing overnight or moisture from the fermenting materials; and the sun's rays falling suddenly upon them in the morning would cause the water or moisture to be heated considerably and the leaves to be scorched. We do not think the age of the Vines can possibly affect the foliage in the way complained of; and if other Vines do well in the same house and border, we cannot discern why the Black Hamburgh should not do well also.

ORCHIDS—DRACENA AUSTRALIS—VACCINIUM ERYTHRINUM (A Subscriber).—Your Orchid is the plant known in gardens as *Dendrobium moniliforme*, and the one figured under that name by Lindley, in "Botanical Register" (vol. xvii., t. 1314), and by Hooker, in "Botanical Magazine" (vol. lxxi., t. 4153); but, according to Reichenbach fil., none of these plants is the true *Dendrobium moniliforme* of Swartz, and he therefore coins a new name for them—viz., *Dendrobium Linawianum*, which will be the name for your plant. *Dracena australis* grows well in a compost of turfy loam, from rotten turves a year old, with one-third of leaf mould added, and a liberal admixture of sand. It requires the heat of a cool stove or warm greenhouse, and does well in ainery in summer. Perfect drainage, plenty of pot room, abundant water when growing, and a moist atmosphere to keep the foliage free of red spider, with abundant light and ventilation, are essential to its healthy development. *Vaccinium erythrinum* requires cool greenhouse treatment, and a compost of sandy peat two-thirds, light loam one-third, with a little silver sand intermixed. Abundant light and ventilation at all seasons, copious waterings when growing (but it requires to be kept rather dry at the root when at rest, but not so dry as to affect the foliage), and keeping rather under-potted, will do all that is necessary to bring this plant into a blooming state.

POMPON DAHLIAS (T. Judge).—These and dwarf Dahlias are the same. They have small flowers, and vary in height from 18 inches to 2½ feet. In rich soil they grow higher than in poorer soil.

TREYS FOR BRISBANE (E. T. Ratcliff).—Mr. Beaton is dead. Messrs. Low, of the Clapton Nursery, could give you the information you ask for.

APRICOT BLOSSOMS FALLING (S. E., York).—The blossoms are perfect; but the small spray with these you have sent intimates that the wood last autumn was very imperfectly ripened. Notwithstanding this, you may have enough set to give an average crop.

BRITAIN'S THREEFOLD NETTING (M. II.).—We do not know where it can be now obtained. It has not been advertised recently.

CRACKING THE JOINTS OF FLUES (C., Litcham).—You must have had strong fires so to crack the joints, or else you must have allowed the flue to get dirty, and the cracks have been caused by explosions. One thing is so far good, that a crack in a flue can be easier filled than a crack in a pipe of metal. The best mortar for flues is lime putty, which every bricklayer knows how to make. This sets harder and firmer than common mortar. Portland cement does very well if not close to the furnace. We some time ago saw nice flues at Linton Park, formed of pipes of Portland cement, which Mr. Robson considered both efficient and economical. If your flue is very shattered it had better be taken down and fresh built, using lime putty or Portland cement, lime putty and brick on bed for a yard at least from the furnace. The *Tropaeolum* will grow much higher than the *Lobelia*. We would prefer the Variegated *Alyssum*, *Cerastium*, *Cineraria maritima*, or *Centaurea ragusina*, round the beds of Scarlet Geraniums.

NAMES OF PLANTS (A Young Beginner).—You are correct, and your employer mistaken. It is the Variegated Mint used in flower gardens, and its roots run freely. (*Alberis*).—1, *Stachys lanata*; 2, *Hebeborus latidus*. (*G.*).—*Limnantes Douglasii*.

POULTRY, BEE, and HOUSEHOLD CHRONICLE.

POULTRY SHOWS.

APRIL 7th. ACCRINGTON. Secs., Mr. J. Dugdale, Dutton Street. Entries close March 31st.

MAY 26th and 27th. WOODBRIDGE. Secs., Messrs. Dailenger and Whistock, Market Place.

JUNE 1st. BEVERLY. Secs., Mr. H. Adams and Mr. J. Kemp, jun. Entries close May 21st.

JUNE 13th to 17th, 1864. BATH AND WEST OF ENGLAND, AT BRISTOL. Stevard, S. Pitmao, Esq., Bishops Hall Manor, Taunton. Entries close May 9th.

JULY 14th and 15th. EASTERN COUNTIES. Secs., Messrs. Ranson and Simpson, Stowmarket. Entries close July 1st.

TRIMMING GAME COCKS FOR EXHIBITION.

THERE are divers opinions as to the fairness of trimming Game cocks for exhibition, and we have many communications on the subject. Some say it is a pity they should fight. To that we can only say it is their nature, and it cannot be prevented. Certain animals are brought into the world with certain gifts, talents, or propensities. We have often laughed to see the gravity with which a pointer puppy will stand and draw the chickens in the yard—no tuition is necessary. We do not think we are cruel, but we confess we have no objection to see an occasional fight in the yards. We do not interfere till the combatants are dragged and exhausted by the weight of their wet and dirty feathers. With every breed but the Game the question of mastery is soon decided, and the beaten bird submits. He generally shows he has a system in his submission. He knows the crow of his master; he seems to have an intuitive perception of his approach, and, calling a hen or two, he walks, sometimes struts away. He seldom ventures to crow. He takes a revenge on a young or a new bird, but the truth is these are not fighting cocks.

Much has been said lately about Caesar's liking for stout men (good easy souls), and his mistrust of lean ones (hungry fellows). The same holds true of fowls. Fat Dorkings, plethoric Cochins are good for a skirmish, but they have no wind, they take up a deal of time in sparring, and often end by a parley. Not so the Game, they will fight in their own slogging way—hard fighting and no surrender. They have no spare fat.

Men who have worked all their lives and made or saved no money, will believe anything of those who have—that is, as to the way in which it has been made. The lower classes will believe anything of the upper. Stonehenge, or the village bridge, or any other erection that is rather beyond the mechanics of the place, must have been built by Julius Caesar or the devil. If man could have built it, they could. It is said and believed by many (fancy Earl Russell giving up politics, and sitting at the feet of THE JOURNAL OF HORTICULTURE, to hear the legends of his family), that a certain Duke of Bedford showed in his youth such a decided penchant for gambling, that his guardians, wise men, seeing he must play, determined he should win. They accordingly put him under the tuition of some of those who, strange to say, always turned up an ace, told the king, and threw double sixes. It is said that owing to this knowledge, Russell, Bedford, and Tavistock Squares, Woburn Place, &c., became his property. Just so, seeing that Game cocks will fight, the operation is made as comfortable as possible to them. Imagine a soldier going into battle with a huge comforter round his neck, thick gloves on his hands, and all his pockets full of stones, he would be quite as well equipped for fighting as a Game cock with all his feathers. His wings, tail, and hackle become wet and heavy, and exhaust him. For this reason he has been bred with as little feather as possible, and for this reason he has his comb, gills, and wattles removed. Such trimming as this is not only justifiable, it is essential for successful exhibition. No feather or hair should remain on the head, or face, or throat of a bird intended for competition, but pulling out tail-feathers or trimming body-feathers should not be allowed. A cock is not trimmed for fighting, but "cut out," which is a very different process. Even a badly dubbed cock shows at a disadvantage; and those who exclaim against all preparation for showing would themselves, if acting as judges, decide against slovenly and heavy-feathered birds. In this Game fowls stand alone. No preparation of the sort is allowable in any other breed, but it is impossible to look at a Game cock as any other than a fighting bird, and all his points are those that fit him for it.

HENS LAYING TWO EGGS DAILY.

A FRIEND of mine has a hen of the Cochinchina breed (not pure), which he says laid two eggs a-day for a fort-

night. Sometimes the eggs were slightly different in colour, varying from cream colour to white. Would you be kind enough to let me know if this is an uncommon circumstance, as it has led to a discussion?—P. McI.

[Our experience of these extraordinary layings is, we have known a hen lay twice in twenty-four hours. We have never known such to continue even for two days. Our only instance was a hen which laid at 4 A.M., and again at 8 P.M.]

RELATIVE PRIZES AND ENTRIES.

The articles in your Numbers of the 8th and 15th inst., concerning the schedules of poultry shows, I hope may produce the effect I desired—viz., the encouragement of discussion on this subject, in order that we may more clearly ascertain what are the prevailing sentiments by which we should be guided. Let this matter, then, be further considered, and rendered more uniform throughout the country.

To contribute to this result I offer a few explanations and remarks, more particularly in reference to the recent comments on my former communication.

In the first place, "Y. B. A. Z.," not having sent to Darlington birds deemed sufficiently good to win the first prize, seems to imagine that either our Committee was to blame for his being "out of pocket," or that his experience does not agree with our theory. We never committed ourselves by saying that the second prize should pay expenses, when we knew that all our first prizes at Darlington would leave a margin over expenses, whatever the distance, from within a few miles of the railway; and if this margin in some cases is but small, we explain that we have not the funds of a Crystal Palace, and must therefore arrange our prizes proportionately. Nevertheless, on account of the prosperity of our recent show, our prizes will be materially raised, and even in the Bantam classes, though not disproportionately, as some seem to wish.

"Y. B. A. Z." is entirely mistaken if he considers that we imagine him interested in these pigmies; but nevertheless we admit that we have noticed the drift of his arguments, and do not consider him impartial: on the contrary, he has decidedly, in almost every article, shown a marked leaning towards Brahmas—a variety so much doubted, that even Mr. Tegetmeier remarks that they never were anything but either Grey Cochins, cross-bred Cochin and Dorking, or cross-bred Cochin and Malay, or Chittagong. And yet what a decided and distinct breed they have now become! Yes; and what distinct breeds Black Hamburgs and Crève Cœurs have become, whatever origin they may have had. Whether they were Polands or Spanish it matters not, the question now is, Can they be reared true to their acknowledged points? for, if we are going back to the origin of fowls, "What is applicable to Brahmas, or any other breed, applies also to Dorkings, Spanish, and Polands."

We are then asked whether a reason has been discovered for Bantams not coming from all parts of the country? In the first place, we must say that our entries comprised many from a distance; and, secondly, we admit that if we could have afforded higher prizes birds would have come in larger numbers from greater distances, but this applies no more to Bantams than to all other varieties in the show.

In reference, however, to the communication of Mr. Brent, we think he cannot fail to see that the money at the disposal of committees is not unlimited, and therefore they must consider how many classes they can afford, and then divide the money proportionately among the most fashionable and useful birds; and as a loss will undoubtedly be made on many of the heavier varieties, some of the most fancy varieties must pay for these losses.

It is quite unimportant by what names new varieties may be called, whether it be a Rose-combed Spanish or a Black Hamburg, or anything else. We must confess, however, our pity for the poor Malay-breeders if they have sunk to so low an ebb that they are afraid to compete in a class in which they could only meet a few of the despised Black Hamburgs, Crève Cœurs, or other dubious varieties.

There is a suggestion we would offer, which, though not immediately connected with the subject, we think decidedly needed. Many shows do not advertise till their entries are nearly closed, and some not at all; whilst others do not

issue their schedules till near the show time, and these materially injure their entries. We would advise all shows to give at least three months notice.

Before leaving this subject we must express our obligation to "Y. B. A. Z." for the candid and handsome manner in which he has alluded to our show. We are aware that it is impossible to attain perfection; but we have no doubt that the improvements he will notice in our next exhibition will show him that, however much we may differ in minor points, we shall strive by attention to the public opinion to merit a large increase on our former entries.—
A COMPILER OF THE DARLINGTON SCHEDULE.

STOCKING AN OBSERVATORY-HIVE.

I HAPPEN to have an observatory or uncomb-hive in the form of a cross, with glass sides, holding four combs. Last spring we were unsuccessful in getting the bees to stop in it. Can you tell me how to reconcile them to it? The glass sides have zinc covers to darken them, so that they are not exposed to light, but I did not give extra warmth by flannel. Is this necessary? In putting some comb in, I supposed it is no use placing it at the bottom—it must be fastened to the top?—H. W. T.

[An observatory-hive, with zinc shutters, is so very chilly and ungenial a habitation, that we are by no means surprised at bees refusing to remain in it. Additional protection, by means of flannel or other non-conducting material, should be afforded, and the hive furnished with combs if possible. If these are sufficiently deep to touch the top, there is no objection to their resting on the bottom; but means should be adopted to prevent their coming in contact with the glass on either side. If small, they should be suspended at the top by melted wax, or by some mechanical contrivance, which may be removed as soon as the bees have firmly secured them.]

WATER FOR BEES.

THE consumption of water by a stock of bees commences so soon as the queen begins to lay, which occurs in some colonies early in January. This, however, varies, depending on the vigour and favourable condition of each several swarm. The most critical period is during March and April, when the rapidly increasing amount of brood causes an increased demand of water.

The particular use or uses which bees make of water remains one of the "mysteries of the hive." In the raising of brood, however, its agency is that of a diluter, indispensable in the forming of honey and pollen into jelly for feeding the larvæ.

The amount of water consumed by a colony during any given period has not been definitely ascertained by the writer in his own experience. This point, however, has been duly determined by that prince of modern apiarists, the Baron of Berlepsch. The Baron says, "That in 1856, during a protracted period of unfavourable weather, we gave all our bees water, and they remained at home in quiet, while those of other apiarists were flying briskly in search of water. At the beginning of May our hives were crowded with bees, whilst the colonies of our neighbours were mostly weak." "One hundred stocks required eleven Berlin quarts per week to keep on breeding uninterruptedly." "Dysentery is one of the direct consequences of water-dearth, the bees in dire need of water consuming honey immoderately, and taking cold by roaming about the combs."

It is said that "in the Isle of Wight the people have a notion that every bee goes down to the sea to drink twice a-day." Thus it will be seen that bees are unable to progress with the raising of brood without the daily consumption of water for that purpose. Indeed, the commonwealth of the hive, in consequence of a dearth of water, are brought to the verge of ruin. Furthermore, that the Creator did not arrange for the storing-up of water by bees; therefore they are not susceptible of being naturalised to cold climates: hence it ought not to be expected that they should thrive and flourish in a regular prosperous degree except it be by culture from the intelligent supervision of the apiarist.

Bees, when confined by stress of weather after breeding has begun, can obtain the water they need only (if duly ventilated) from the watery particles contained in the honey. A knowledge of these facts reveals not only the truth and nature of a natural obstacle to success, but also the mode of counteracting it. Thus by feeding bees with limited quantities of honey and sugar, largely diluted with water, at short intervals during March and April, they promptly store-up a very dilute honey, from which they get adequate supplies in ordinary contingencies. This affords them all the facilities needed to multiply and replenish the hive. Herein consists the means by which, and only so, the ultimatum of success is attainable.

Bee-keepers who have given any attention to feeding colonies, unite in affirming that stocks thus fed swarm ten to fourteen days earlier than they otherwise would. This is of paramount importance, as the few days thus gained in the honeymoon secures to first swarms some fifty per cent. more stores, besides affording after-swarms like benefit. The cause of these advantages has generally, through misapprehension, been ascribed to the incitement produced by the saccharine contained in the feed, while the water, though overlooked, is evidently the chief cause, as judicious feeding will produce the like effect with colonies having an excess of honey as those possessing limited stores of it.

Many bee-keepers still manage bees according to the popular notions, which consists in hiving the swarms when they issue, and giving them a careful letting alone, thus expecting to follow nature by counterfeiting wild bee-keeping. Those who persist in this, of course will not be benefited by experience, or anything which might be published. Indeed, the sooner these traditioners' bees run out, the sooner will this wild crude practice become extinct, and a new era of a rational system of culture will be the happy result.—C. J. ROBINSON, *Richford, Tioga Co., N. Y.*—(*American Country Gentleman.*)

[Water drought is much spoken of by the Germans; and, in a country which is generally so far removed from the sea, and in which the atmosphere is robbed of its moisture by traversing large tracts of sandy soil, it is doubtless much to be dreaded. So also in North America, where, in some cities, buildings and churches are roofed with tin plates, which remain perfectly bright for years, whilst in England they would be dimmed with rust in a week, and totally destroyed in a year or two; and, where an axe may be left in the forest for weeks without a speck of rust appearing on its surface, it may very probably be of great importance to furnish bees with a supply of water within their hives during cold and backward springs. In this country, however, we have generally to contend with the opposite difficulty, since it is well known that, in wooden hives especially, internal moisture, produced by the watery particles of a humid atmosphere, condensing on the top and sides of the interior of the hive, is the parent of some of the worst evils that afflict our apiaries. The idea that bees always visit the sea is not peculiar to the Isle of Wight, but is also very prevalent in the West of England. I have often astonished our rustic apiarists by informing them that I had kept bees successfully in one of the midland counties, a hundred miles from the seacoast, which was therefore quite out of the reach of my little winged excursionists.—A DEVONSHIRE BEE-KEEPER.]

BEE RAIDS.

It is well not to be too certain of anything, and the rule holds good with regard to the natural history of bees.

Last year, in early spring, I had a hive (the bees carrying at first), whose inhabitants frequently got "small by degrees and beautifully less." I fed them from the top with honey; they would not take it down. One day when the sun was shining I turned the hive up, and tried to beat out the few bees within. On returning to the apiary to see how many bees had returned to the stool, I found in the front of one of the hives on the ground a small cluster of bees encircling a queen. There was no brood in the hive that I could see, and I preserved the comb, to which in due time I added two second swarms. They gathered honey, and appeared a good keeping stock. A few weeks ago I examined and found

them light. I fed them, and found they would neither accept honey at the top nor bottom, yet they appeared to work, and certainly carried a little. On Sunday last there was a terrible row amongst my bees, and an onslaught was made on this unfortunate hive. They fought hard. I could not attend to them, but in the evening, when my work was done, I examined the hive, and found that all the bees were gone. The next day I broke up the hive, found plenty of honey, but not in good condition, about thirty larvae, with a few cells sealed up, the contents dried up, evidently the remains of last year. What became of the bees and queen I cannot say. I have no doubt she was in existence the previous week, and I should imagine on the Sunday morning, or the inhabitants would not have fought as they did. There is a belief amongst bee-keepers in this region that the robbers entice the bees away with them. One hive appeared to contain the culprits, for they were hard at work going to and fro in the evening when all the other hives were at rest. Very late last autumn, almost into winter, one of my hives alone appeared to rob a neighbour's. On examining the latter all the bees were gone, although the owner of them had not missed them.—A HAMPSHIRE BEE-KEEPER.

HOW TO ROAST A GOOSE.

GEESE seem to bear the same relation to poultry that pork does to the flesh of other domestic quadrupeds—that is, the flesh of geese is not suitable for, or agreeable to the very delicate in constitution. One reason, doubtless, is that it is the fashion to bring it to the table very rare done—a detestable mode!

Take a young goose, pick, singe and clean well. Make the stuffing with 2 ozs. of onions (about four common-sized) and 1 oz. of green sage chopped very fine; then add a large coffee-cup of stale bread crumbs and the same of mashed potatoes; a little pepper and salt, a bit of butter as big as a walnut, the yolk of an egg or two; mix these well together and stuff the goose. Do not fill it entirely, the stuffing requires room to swell. Spit it, tie the spit at both ends, to prevent it swinging round and to prevent the stuffing from coming out. The fire must be brisk. Baste it with salt and water at first, then with its own dripping. It will take two hours or more to roast thoroughly.

A green goose—that is, one under four months old, is seasoned with pepper and salt instead of sage and onions. It will roast in an hour.

SAUCE FOR A ROAST GOOSE.—Put into a saucepan a table-spoonful of made mustard, half a tablespoonful of Cayenne pepper, a glass of port wine, and a gill of gravy; mix, and warm, and pour it through a slit in the apron into the body of the goose, just before serving.—(*American Country Gentleman.*)

OUR LETTER BOX.

CANNIBALISM OF POULTRY (*R. B.*).—Discontinue the meat feeding. Do the hen-pick the feathers from the cock's poll, or are the hens only bare?

MUSTY-FLAVOURED EGGS (*A Subscriber*).—As all the food you give the hens is free from mustiness, the flavour must arise from the place in which the eggs are stored, or from some plant they eat in their two-acre run.

GAPES (*H. C.*).—Making the chickens frequently inhale tobacco smoke, and the vapour of spirits of turpentine, is said to be curative. We would try "Day's Gape Paste." It may be had of Barclay & Soas, 95, Farringdon Street, through any patent medicine vendor.

HENS LAYING WHILST PEACHED (*An Ignoramus*).—This habit and their eating their eggs, are intimations of morbid irritation, and we believe caused by their being too fat from over-feeding. Give to each a dessert-spoonful of castor oil; give them no whole corn, but feed them for a month on boiled potatoes with very little barley-meat mixed with them.

BOOK ON POULTRY FOR EXHIBITION—BANTAMS FOR EXHIBITION (*J. R.*).—Mr. Baily's book treats at length on exhibiting poultry. The best breed of Bantams for prizetaking is the Black-breasted Red. They breed more truly to colour than the others. Cochins Bantams as good as those shown last year at Birmingham and the Crystal Palace would be sure prizetakers anywhere.

PRIZES FOR DOMESTIC PRODUCE (*An Inquirer*).—Our correspondent will be obliged by being told the names and addresses of some societies which offer prizes to cottagers' and farmers' wives for home-made articles. We know that many agricultural societies offer prizes for butter.

YELLOW CANARIES (*A Subscriber*).—Write to Mr. W. Walter, 29, Hyde Street, Winchester.

WORK ON BEES (*P. II.*).—"Bee-keeping for the Many" you can have from our office free by post for five postage stamps. Mr. Taylor's and "A Country Curate's" works are larger and excellent.

WEEKLY CALENDAR.

Day of M th	Day of Week.	APRIL 5-11, 1864.	Average Temperature near London.			Rain in last 37 years.	Sun Rises.	Sun Sets.	Moon Rises.	Moon Sets.	Moon's Age.	Clock before Sun.	Day of Year.
			Day.	Night.	Mean.	Days.	m. h.	m. h.	m. h.	m. h.	m. h.	m. s.	
5	TU	Plum and Lombardy Poplar flower	57.0	36.2	46.6	17	28 af 5	38 af 6	37 4	38 5	28	2 38	96
6	W	Crown Imperial flowers.	57.1	36.4	41.7	13	25 5	40 6	4 5	58 6	●	2 21	97
7	TH	PRINCE LEOPOLD BORN, 1853.	57.5	37.0	42.3	17	23 5	41 6	33 5	16 8	1	2 4	98
8	F	Pear and Raspberry foliate.	55.6	35.5	45.6	20	21 5	43 6	6 6	29 9	2	1 47	99
9	S	Rooks hatch.	54.4	35.1	44.8	18	19 5	44 6	43 6	36 10	3	1 30	100
10	SUN	2 SUNDAY AFTER EASTER.	55.3	33.2	44.2	14	17 5	46 6	27 7	35 11	4	1 14	101
11	M	Turnip and Birch flower.	55.2	35.3	45.3	18	14 5	48 6	17 8	morn.	5	0 57	102

From observations taken near London during the last thirty-seven years, the average day temperature of the week is 56.0°, and its night temperature 35.5°. The greatest heat was 79°, on the 7th, 1859; and the lowest cold, 20°, on the 10th, 1860. The greatest fall of rain was 0.73 inch.

CULTIVATION OF THE PINE APPLE.



An apology for a pen-invasion of the very highest region of practical horticulture might, perhaps, not be unseemly to the minds of some who scan the heading of this paper, and analyse the treatment which it may receive at my hands. I have, however, no apology to make, and shall, therefore, not attempt to offer one; and while I make an appeal for a hearing on a subject which so many have either not cared to treat of, or considered of such limited importance, I am not afraid that

I shall be classed among those who ought to be silent, even when they have a mind to speak, by any who have witnessed the results of a practice on which I have proposed to offer a few practical remarks. I would, however, offer the premonition to those who may be, shall I say, advanced enough to look for, and be content with nothing short of something sensational, that they will be thoroughly disappointed, for that is an arena to which I hope to remain a stranger. There is no Blondinism in gardening, far less in that branch of it that is now chosen for consideration. But there is a vast deal of love, attention, mental and bodily watchfulness, of the most restless and never-ceasing kind—just those qualities which are so requisite in a thorough good nurse, and no man will ever garden successfully without them. To attempt, then, to place some talismanic wand in the hands of youthful aspirants that will enable them to conquer in the battle that lies before them, is presumption; and my advice is to turn away from all who try to charm you into gardeners without the qualities I have named in active operation, as from your worst enemy.

The Pine Apple is, without doubt, the most aristocratic, if I may so express myself, as well as the most rich and delicious of all fruits. Strange to say, it has not been known in Europe for much more than two centuries, while it is not much more than half that period since its cultivation first commenced in Britain. There is no absolute certainty as to where its native habitat may be strictly considered to be. It has been affirmed that it was first brought from Brazil to the West Indies, and thence to the East. In Holland it was known for some time before it was introduced into this country. Mr. Bentinck, ancestor of the Duke of Portland, is supposed to have first introduced and cultivated it in England about the year 1690.

It is well known that within the last twenty or thirty years the cultivation of the Pine Apple has made great progress. In 1820 it was considered an extraordinary feat to be able to produce a solitary fruit of the Providence variety, the largest and coarsest, to the weight of 9 lbs. In 1821, another Providence Pine is mentioned in the "Transactions" of the Horticultural Society, as

having weighed 10 lbs. 8 ozs., and this was then considered so extraordinary by the Fellows of the Society, that it was presented to the King for the dessert of the royal table at the coronation banquet. It is almost needless to say that the productions referred to would not now be considered wonderful, although the occasional production of a heavy fruit is not that on which I would base the assertion that great progress has taken place since those days. It is the speed and certainty which now characterise good Pine-growing, upon which the claim to improvement rests, more than on an occasional giant fruit. Queens from 4 lbs. to 6 lbs. are now produced in half the time that was at one time considered necessary to produce fruit of little more than half such weights, and the rapidity with which Pines are now forwarded into the fruiting stage, was not generally thought of, far less realised, even twenty years ago.

In proceeding to make the few cultural remarks proposed, the point which naturally claims attention first is that of the houses or pits best adapted for the growth of the Pine Apple, and the situation or exposure they should occupy. The situation should be one well sheltered from cutting winds, and have a due south aspect. There is nothing that necessitates hard firing to keep up a given temperature more than exposure to wind, and the less the application of fire heat in all forcing, and particularly for Pines, the more conducive to healthy growth will the atmosphere be. Shelter, therefore, from north, east, and west, should be taken into consideration in the erection of all Pine-pits or houses, bearing in mind at the same time that the sheltering objects shall not interfere with a full exposure to sunshine.

Pineries should be so constructed as to afford as much light and sunshine as can be had. During by far the greater portion of the year Pines cannot possibly have more light and sun than is necessary to command a fruitful growth in the hazy atmosphere which so much prevails in this country. During the few months when at times the sun may be more scorching than is in some cases desirable, a slight shading can easily be applied. For summer growth and fruiting I would give the preference to span-roofed houses running north and south, from the fact that in the morning and afternoon they receive the full sun; and for a period in the middle of the day when the sun is most intense, the plants would, from the position of such houses, be partially shielded from the more vertical and scorching rays of the sun. Such a house would be decidedly the best for summer growth; but on the other hand lean-to pineries would have the advantage for at least seven months in the year, in as far as exposure to the more direct rays of the sun is concerned. They also possess the advantage of having a less radiating surface than span-roofed houses, and, consequently, require less fire heat to keep up the temperature. For swelling-off fruit in winter they would, therefore, have the advantage, while on the other hand for summer work the span-roofed pinery would be preferable. The accommodation which I should therefore prefer and recommend, would be in part span-roofed and

in part lean-to; but I am well aware that there are few places indeed where such varied accommodation is at command, nor is such absolutely necessary for producing a very creditable supply of Pines, although various structures render variety necessary in some points of management.

The Pine Apple being a fruit which during the greater portion of the year requires a high temperature, particularly in some of its stages of growth, there should, therefore, be a good command of heat both for top and bottom.

The atmospheric heat I should always prefer to be given by hot-water pipes. For bottom heat many have yet a predilection in favour of a fermenting bed of leaves with a sufficiency of tan on the surface to plunge the pots in, and would not prefer either the tank or hot-air chamber for any other reason than that of cleanliness and economy of labour—very important points certainly in most forcing establishments. Some of our very best Pine-growers produce the finest Pines even at the dead of winter, as well as at all other seasons, where bottom heat is dependant entirely on the old leaf-and-tan-bed system, and find from 3 to 4 feet of oak leaves sufficient, with slight surface-dressings of fresh tan, to maintain the proper heat for several years. Some extraordinarily fine examples of Pine-growing have been produced on the Continent, by supplying bottom heat from heaps of fermenting stableyard manure applied in chambers underneath the beds in which the Pines are grown; and the fumes from these heaps have, no doubt, much fertilising power. The same benefit to some extent may be attributed to the old English system of filling the pits with fermenting leaves alone. I believe the heaviest Pines that have ever been produced were grown without the aid of fires for either top or bottom heat; and although in a cultural point of view I have a warm side to the old fermenting-bed, and am obliged to carry it out in practice, at the same time I am far from recommending it in preference to the more modern and far more manageable system, which gives the grower the command of temperature with a title of the trouble connected with the old bed system. To supply both top and bottom heat in the present day from linings alone would most certainly be a misapplication of labour to an extent which scarcely any consideration would warrant. On the other hand, where top heat is supplied by hot water I have little objection, beyond the greater labour that it entails, to a bed of leaves for supplying bottom heat, although it necessitates greater watchfulness and anxiety on the score of heating to an injurious extent, especially after fresh material has been added; but notwithstanding these objections I am inclined to believe with some of the very best Pine-growers, that Pines of the very finest quality are quite as likely to be produced over a bed of fermenting material as over a tank or hot-air chamber; but for ease and regularity of temperature I would most certainly recommend the latter.—D. THOMSON.

(To be continued.)

ROYAL HORTICULTURAL SOCIETY'S SECOND SPRING SHOW.—MARCH 30TH.

It had been announced that Her Majesty intended to honour the Society with her presence on this occasion, and the result was a large attendance of the Fellows and their friends, notwithstanding a heavy fall of snow in the morning. This made even those most confident in Her Majesty's proverbial good fortune as to weather fear that the Exhibition would not be favoured with a "Queen's day;" but a westerly wind soon melted the snow, and the after part of the day was tolerably fine. At 11 o'clock Her Majesty and H.R.H. the Princess Helena arrived, and were received by Mr. Wilson Saunders, the Secretary, and other members of the Council. The Royal party, having inspected the Show, proceeded to the conservatory, which is now extremely gay, and, after having remained in the gardens for half an hour, took their departure by the north entrance.

This Show was held in the same place as the previous one—viz., the Entrance-hall, Council-room, and a portion of the adjoining arcade; but as the heating apparatus had been set early to work, and precautions had been taken to exclude draughts, a comfortable temperature was secured. And now to speak of the Show itself. It was styled the "Camellia and Rhododendron Show," and there were six

Camellias and four Rhododendrons—a sad deficiency in what was set forth as the primary object of the Show; but Roses, Hyacinths, Tulips, and rare plants, made up a good display for the time of year.

CAMELLIAS AND RHODODENDRONS.—The only exhibitor of these was Mr. Young, of Highgate, who received a second prize for six Camellias, which had been previously exhibited at the Regent's Park, and which were past their best; and a first prize for four Rhododendrons—Columbus, rosy crimson; Barclayamum, in fine bloom; Lucidium; and Maculatum, lilac crimson. Mr. Treen, of Rugby, had a first prize for twelve cut blooms of Camellias; and Mr. Todman a similar award for a stand of six. The most conspicuous kinds were *Angustina superba*, and *Rubens*, rose; *Mathotiana*, deep rose; *Bealii*, crimson; *Fimbriata*; and the old Double White.

Roses both in pots and as cut blooms made a most attractive display. Of the former there were three fine collections, one furnished by Mr. Turner of Slough, to whom the first prize was awarded, and two from Messrs. Paul of Cheshunt. In Mr. Turner's collection John Hopper was an object of general admiration from the size and beauty of its blooms; *Général Jacqueminot*, *Vicomte Vigier*, *François Lacharme*, and *Teas Gloire de Dijon*, and *Madame Bravy*, were also fine. Messrs. Paul, who were second, had *Charles Lawson*, with seven fine blooms; *Beauty of Waltham*, *Lord Raglan*, *Noisette Céline Forestier*, the pale yellow flowers of which set off well with the colours of the others; and *Teas Souvenir d'un Ami*, *Madame Willermoz*, and *Vicomtesse de Cazes*, all of which were excellent. Messrs. Paul & Son had a second collection in the Miscellaneous Class, for which an extra prize was given. In it were included *Lord Clyde*, *John Hopper*, *Madame de St. Joseph*, *Victor Verdier*, *François Lacharme*, and some others. Of Cut Blooms Mr. W. Paul and Messrs. Paul contributed several boxes, including a multitude of varieties which it would be tedious to enumerate. A few of the most striking were *Maurice Bernardin*; *Red Rover*, noticeable from its glowing colour; *William Jesse*, *Lord Herbert*, *Victor Verdier*, *splendid*; *Lord Clyde*, one of the finest of dark Roses; *Général Jacqueminot*, *Madame Alfred de Rougemont*, a very desirable white Hybrid Perpetual; *Senateur Vaisse*; *Teas Gloire de Dijon*, and *Louise de Savoie*.

HYACINTHS were a principal feature, Messrs. Cutbush and W. Paul again throwing all other exhibitors completely into the shade. Messrs. Cutbush were first in twenty-four distinct kinds, and Mr. Paul second, but from both the spikes were splendid. Of Reds, *Cavaignac*, *Macaulay*, *Von Schiller*, *Princess Clothilde*, *Florence Nightingale*, and *Pelissier* were the best; of Blues, *Van Speyk*, *Laurens Koster*, *Marie*, *Charles Dickens*, *Grand Lilas*, *Thorwaldsen* (noticed last week), *King of Blues*, *Argus*, and the truly beautiful *Lord Palmerston*, which was seen in even more striking perfection than on former occasions; and of Whites, *Snowball*, *Mont Blanc*, *Queen of the Netherlands*, and *Grandeur à Merveille*. *Ida*, yellow, and *Prince Albert*, *Mimosa*, and *General Havelock* of the Black class were also in great perfection. *Duc de Malakoff*, buff, with a rosy crimson streak down each segment, was more true to colour than we have yet seen it this year. Messrs. Cutbush and Paul likewise exhibited in the Miscellaneous Class collections of upwards of a hundred, for which they each received prizes; and Messrs. Barr and Sugden had a third prize for twenty-four.

Among Amateurs the best came from Mr. Young and Mr. Carr, Highgate, who were first and second respectively.

TULIPS of the early kinds, as shown by Messrs. Cutbush and Paul, were very showy, and the collections of both exhibitors were of such equal merit that to each a first prize was awarded. The varieties were *Fabiola*, rosy violet and white; *White Pottelakker*; *Coleur Cardinal* and *Vermilion Brilliant*, scarlet; *Keizerkroon* and *Bizard Pronkert*, red and yellow; and *Bride of Haarlem*, red and white. *Molière*, purple; and *Proserpine*, violet rose, were also fine. Mr. Young and Mr. Carr took the second and third prizes.

PELARGONIUMS.—The only forced Geraniums, as they were termed, were from Mr. Turner, of Slough, whose plants were far better than could have been expected at this early season, and though not equal to what he exhibits at the summer shows, were quite equal to those which many other exhibitors bring to these meetings. The kinds were—*Clarissa*,

very pale rose with a small dark blotch; Sir Colin Campbell-orange scarlet with dark maroon upper petals; Dr. André-salmon rose; Pescatore, salmon scarlet; Phœbe, light pink upper petals rose with dark blotch; and Pamela.

LILIES OF THE VALLEY.—Some fine pots of these came from Mr. Howard, of Balham; and Mr. Bartlett, of Hammersmith, to whom were awarded the first and second prizes.

FORCED FLOWERS.—Only two collections of these were shown—a circumstance which is rather surprising, considering that there are so many plants offering resources for the spring decoration of conservatories. The best and most varied collection was that of Mr. Treen, which included Azaleas, Rhododendrons, *Deutzia gracilis*, *Cytisus racemosus*, *Acacia armata*, *Dielytra*, Tea and Hybrid Perpetual Roses, *Clematis Sophia*, *Cinerarias*, Tulips, and Lily of the Valley. Mr. Young, who was second, had *Kalmia latifolia*, *Pimelea spectabilis*, *Acacia Drummondii*, common Lilac, a *Rhododendron*, *Hyacinths*, and Tulips.

MISCELLANEOUS.—Here Mr. Bull exhibited six fine Azaleas, of which one, Queen Victoria, white flaked with purple, was a beautiful pyramid of bloom; *Concinna*, violet crimson, was also very showy, and in the background a large plant of *Trinmphans*, rose spotted, was a mass of bloom. For this exhibition Mr. Bull had an extra prize; also for a large collection of new and rare plants, including *Dracanas*, *Cordylines*, *Lomaria*, *Cephalotus*, *Chameranthemums*, and several others, which will be found in the report of the proceedings of the Floral Committee. Mr. Williams contributed a similar collection, in which were several *Amaryllises*; *Aulica major*, bright scarlet; *Vivid*, deep scarlet; and *Marginata grandiflora*, scarlet, margined and streaked with white, being the most showy. Mr. Todman, and Mr. Turner, were awarded extra prizes, the former for Chinese *Primulas*, the latter for four pots of *Bougainvillæa speciosa*, in better bloom than it has hitherto been seen when cultivated in that manner. Mr. Moss, of Bentley, Brentwood, sent among other flowering plants, *Azalea Iveryana*, so densely covered with bloom that scarcely a leaf could be seen; and Miss Maling's plant case tastefully filled by Mr. Bull, completed the list of noteworthy objects.

After all, the fairest exhibition was in the conservatory, for about four o'clock there were not less than four hundred ladies seated and promenading there. This is a hint which the Committee will do well to be guided by. Let all the arcades be converted into one continuous conservatory walk, and then there will be a winter garden worthy of what ought to be the first horticultural society in the world, and the strengthening of the subscription list would soon tell how it was appreciated.

FLORAL COMMITTEE, MARCH 30.—The second meeting of this Committee was held in connection with the *Camellia* and *Azalea* Exhibition. There were but few plants for examination, and none of any particular merit. The greatest attraction was a plant sent by Mr. Williams, *Holloway-Sarracenia Drummondii*, having one of its singular forms of flower and curiously mottled pitchers in fine condition. Not being a new plant, though rarely exhibited, a special certificate was awarded it. Mr. Williams sent also a beautiful variegated specimen of *Phormium tenax*, the New Zealand Flax, which is a very handsome plant—first-class certificate; *Lomaria zamiaefolia* or *cyadifolia*, a fine form of the tree Ferns; *Amaryllis Leviathan*, a free bloomer, but deficient in form and colour.

Mr. Standish exhibited three Japanese plants—*Corylopsis spicata*, a flowering tree, producing small pale yellow bunches of flowers, but not much to recommend it as seen at present; *Skimmia* species, which received a first-class certificate last year; and *Forsythia* species, with larger flowers of a deeper yellow than other known *Forsythias*—second-class certificate.

Mr. Bull had *Anætochilus speciosus*, a new kind, with deep red-veined foliage—second-class certificate; *Anætochilus zebrinus*, an erect-growing variety, with pale green mottled foliage; *Asplenium feruleaceum*, a delicate and beautiful Fern—first-class certificate; *Chamærops stauracantha*, a noble-foliaged plant, extremely useful among decorative plants—first-class certificate; *Lastrea varia*, a Fern much resembling *L. opaca*, the young fronds of a dull red colour, and when older not so stiff and a glossy green—second-class

certificate; *Pandanus cuspidatus*; *Hebeclinium atrovirens*; *Dielytra spectabilis alba*, an imported variety—(should this produce its white flowers as freely as *D. spectabilis* it will prove very useful; the plant was not in condition to judge of its full merits); *Amaryllis Spark*, a very bright red variety, flowers undersized and of bad form.

Mr. Earley, Digswell, sent *Cineraria Gipsy Queen*, a bright purple, not differing from many other seedlings; also *Begonia Digswelliana*, which was thought useful as a decorative plant, and, being in much better condition than when last seen, was awarded a label of commendation.

Mr. W. Paul, Waltham Cross, sent *Hyacinth King of the Blues*, a fine spike with very deep blue bells—first-class certificate.

Mr. Cutbush, Highgate, had *Hyacinth Thorwaldsen*, a fine deep porcelain-coloured flower, distinct from any other; the bells of great substance and good form. A stronger bulb would doubtless have produced a much finer spike—first-class certificate.

The Secretary announced that the Council had awarded the silver Flora medal to Mr. Standish for the beautiful specimen of his fruit-bearing *Aucuba* exhibited on the 9th ult.

ORCHARD-HOUSES.

MR. ABBEY'S temperate and excellent account of his experience given at page 213 is well worthy of attention, and I feel real pleasure in endeavouring to explain why the sub-smoky atmosphere of Bradford, Leeds, and some other manufacturing towns in Yorkshire, is unfavourable to unheated orchard-houses.

It cannot be owing to the difference in latitude, for in places much farther north Peaches and Nectarines ripen in such houses freely and well, as the following extract from a note from Seggieden, Perth, N.B., dated March 3rd, 1864, will show.

"As I see that the orchard-house controversy is still going on, I may conclude by informing you that my orchard-house was a complete success last year, as it always has been. Many of my Peaches from trees in pots were even 9 inches in circumference, and weighed just under the half pound. I had two crops of Figs, and the Grapes were ripe by the first week in September, and all this without one particle of fire heat, and that in a part of the country where neither Peaches nor Figs will ripen in the open air, and much less Grapes. This year everything looks well for another large crop. I may also state that I never ate finer *Burré Diel Pears* in my life than those I grew last year in the same house."

That is the report of a gentleman well known for his love of fruit-tree culture, and is quite conclusive as to the possibility of unheated orchard-house culture being successful upwards of two hundred miles farther north than Bradford. Can it be, then, that the sun's rays, so often obscured by smoke near the large towns of Yorkshire, have not force enough to heat such houses sufficiently to ripen Peaches and Nectarines? It seems probable. Mr. Abbey would do well to visit the neighbourhood of Nottingham, it is only a journey of one hundred miles or so, and then he would see a score of houses, and be able to judge correctly.

As to this neighbourhood, and the south and east of England, they rarely fail if they are properly built and not too much confined in height and width. This leads me to an illustration of this statement. A few miles from this place, at the seat of W. F. Maitland, Esq., is an orchard-house of roomy dimensions, 12 feet high, and 15 feet wide, in which the gardener, a self-taught man who has worked himself up to a good practical knowledge of fruit-culture, has had the greatest possible success in producing from his trees in pots Peaches and Nectarines of the finest size and flavour.

Two or three miles from this place is another seat, the gardener at which is well educated as a gardener, and is a careful, good man. He was recommended to the situation by "D.'s" friend. At this place there are two houses, one 30 feet by 9 feet, the other 14 feet by 8 feet. They are, consequently, narrow. In those houses Peaches and Nectarines in pots were a failure, and consequently the gardener declaims against the system. In the large house first named they are a complete success, and both employer and gar-

dener are delighted with them. What, then, must we say? There has been no want of skill in the gardener who has the narrow houses under his care; it must, then, be that the currents of air in such narrow houses are too sharp, and thus the trees standing in the middle of the house would suffer. I have more than once seen a failure in small low houses. One friend in particular told me that the insects were such a pest that they beat him. In my large houses 12 feet high and 24 feet wide, I have really no insects, the trees have not been dressed, and yet not a brown aphid is to be seen, and this is always the case. We have then to find out why, as in Mr. Abbey's case, insects should be such a pest in small houses, and not in those that are lofty, wide, and well ventilated.

From a note recently received from the author of "Cordon Training," living at Guernsey, I quote—"Your opponents have much the worst of it. I wish they could see my trees. It is now seven years since I began, and they bear more every year." I may, in like manner, say I wish Mr. Abbey could see my trees. The Apricots are now (March 21) in full bloom; and they are the most perfect specimens of successful culture ever seen—far more so than those I saw in France in 1842, which first excited my ambition. The management of these trees is very simple. Towards the end of October their fibrous roots are "dug out" (as Mr. Creed recommends for his Cucumbers) to 4 or 5 inches deep round the sides of the pots, some compost (tenacious brown loam and good rotten manure in equal parts) is then filled in, so as to be some 2 or 3 inches above the rims of the pots. This is left for say ten days to become partially dry—the trees are never removed from the house—and then it is rammed down very firmly with a stout stick. When finished the compost is as nearly as possible level with the rim of the pot, and formed into a concavity round the stem of the tree, to retain some water. A gallon or so of water is then poured gradually into the soil, and no more care, except protecting the pots from severe frost, and no more water is given till early in March. The trees had their shoots pinched-in all last summer, and now they are covered with short spurs that are masses of finely-developed flowers. Many of these trees are capable of, and will bear, a peck and upwards of fruit. The house being large, 12 feet high and 24 wide, has resisted the frosts we have had lately (on the 24th and 25th instant), the thermometer registering 31° without even a pan of charcoal, while in the open air it has registered 21°. I can scarcely give an idea of the comfort of looking at these fine trees—no protection required, no being in fear and trembling for two entire months, and even more; for not till the beginning of June are young Apricots free from injury by spring frosts. Why should not this be done by hundreds? There is no extra skill employed here; all is done by nursery labourers. Why should it not be done in Yorkshire?

If I were a young man, with some capital which I wished to employ advantageously, I would settle in Yorkshire, and grow fruit for the millionaires of the county. If I found the climate too cool to ripen fruit in orchard-houses without heat, I would take advantage of the cheap coal, and use artificial heat to bring forward the blossoming period in spring, and to ripen the fruit and wood in autumn. As to the idea that heating a house containing various fruits destroys its character as an orchard-house, we may as well say that I have destroyed the character of one of mine because I placed a pan of charcoal in it last night (the 20th), to prevent the possibility of injury from frost. The idea must be discharged. I hesitate to give it a character.

Mr. Thomson ripens Grapes in January, so that they ripen without much assistance from the sun. Surely, then, in Yorkshire any kind of fruit may, by a little artificial heat, be made to ripen towards the end of summer. Light, roomy, span-roofed houses, not less than 12 feet high, and not less than 24 wide, with a ventilating shutter 18 inches wide on each side, the roof fixed, glass large (20 inches by 15), rafters 20 inches asunder—in short just such houses as are so successful here and elsewhere, would surely conquer the difficulties of a Yorkshire climate. If such houses would not ripen fine fruit in the murky atmosphere near the large towns, then the cultivator must take advantage of the cheap coal, and introduce one or two four-inch hot-water pipes, and thus "make assurance doubly sure." Failure is

a word that should not be found in a gardener's vocabulary in this orchard-house business more especially, for scores of cultivators are successful. Why, then, should Yorkshiremen be beaten? We southerners reckon ourselves rather inferior to them in sturdy perseverance; they must not, then, allow us to hold them in low estimation as to this branch of gardening.

My attention within these few days has been drawn to my beautiful pyramidal Cherry trees, in large pots, just coming into bloom—no fruit tree succeeds better under pot culture, for, when planted out, the large kinds of Bigarreaus grow far too vigorously—and I thought, "were I a wealthy manufacturer in the north, I would have a Cherry-house, 100 feet long and 24 wide; to a certainty, no artificial heat would be required for that." And then, again, I would have a house of the same size for my Golden, Ribston, Newtown, and other Pippins. It is scarcely credible how well they succeed in pots under glass. My Apple trees of these sorts stand in the house all the year; not a spot of canker or any other disease is to be found on them. The same may be said of Pears and Plums; their beauty, health, and fertility, under glass, is something to think about, and I wonder that wealthy persons in the north can neglect such delightful culture, or be persuaded by incompetent persons not to go fully into it.

It may be said that in this article I recommend lofty roomy houses, whereas, in the "Orchard-House," I mention that small houses are equal to large ones in their products. This is quite true as far as regards the climate here (Saw-bridgeworth); for I have several small span-roofed houses, 12 feet wide and only 7 high, in which Peaches and Nectarines are grown successfully and largely, and very rarely is an aphid or spider-infested tree to be seen in them; but, in writing this, I have had Mr. Abbey constantly in my mind, his failures in small houses, and the capability of building large houses by wealthy Yorkshire manufacturers; also their greater fitness for cold climates, as they resist rapid changes of weather better than small houses, and give a far more equable, and consequently a more favourable, climate. I have never been more convinced of this than I have during this month (March); for in the morning the register of the thermometer in my large span-roofed house, 12 feet high, stood at 31°; that in a small span-roofed house, 7 feet high, stood at 26°. If the blossoms of the trees had been as forward as they are in the large house, they would probably have been injured by 6° of frost. As a rule, the trees in my small houses are from ten days to a fortnight later in blossoming and ripening their fruit than those in the large houses, and this seems to point out the latter as being better adapted for cold climates.

I have made this article, I fear, intolerably long; but I have felt anxious to clear up the doubts expressed to a certain extent by Mr. Abbey, and because he is not a describer of other men's descriptions, nor one of those who decry books they have not read simply for the sake of annoying the authors.—T. R.

VISITS TO GARDENS PUBLIC AND PRIVATE.

MR. W. BULL'S, KING'S ROAD, CHELSEA.

If the old saying "Novelty is pleasing" be correct, Mr. Bull ought to live in a perfect elysium; the "*tu det me vite*" should never escape his lips, and *canit* be for ever banished from his domains. But then novelties will die. Some of them are worthless, and others cost more money than they are ever likely to bring him in, especially in the way of prizes; so that I dare say he has, like the rest of us, found out that the wheels of life do not run in so smooth a groove as he would like; but certainly a more indefatigable caterer to the wants of the novelty-loving public than he is cannot well be, and I have little doubt if a plant were to be discovered which grew with its head into the ground and roots in the air, he would ferret it out. Long-threatened had been my intention of visiting him; for although I am "only a florist" (by-the-by I was amused to see Mr. Rivers designated in an advertisement the other day as an "eminent florist"), yet I have some love of novelty, and know a little about stove and greenhouse plants. It was a snowy wretched day when I fulfilled my threat, yet I saw much to interest

me; and although I cannot give an idea of the title of the novelties which I saw, yet I will jot down a few notes of those which more especially struck me at the time.

Any one who reads the advertisements in gardening periodicals will see that there is hardly a branch of horticulture in which Mr. Bull does not endeavour to introduce novelties. Such being the case, it will and must happen that many things new but not good are introduced; and indeed it has ever seemed to me questionable whether it would not be better to attempt less and so to have fewer failures. The reply will doubtless be, People will have them, the demand creates the supply. But then, again, it may be said that were a different course adopted people would soon fall into it; and I believe they would not object to pay a higher price provided that the subjects were really good.

The large conservatory or winter garden is a fine span-roofed structure, and is filled with a collection of tree Ferns and other ornamental-foliaged plants, and with new varieties of Camellias and Azaleas. Amongst the Ferns was a fine plant of *Cyathea serra*, reaching nearly to the top of the house, with a stem 14 or 15 feet high. There were also fine specimens of *Dracæna australis latifolia*, *Cordylone indivisa* and others; and amongst the Camellias a fine new striped variety called Comte de Gomer, the colour a bright red with dark crimson stripes. The roof of this house is covered with Grape Vines; and Mr. Bull assured me that when in full bearing it had a very striking appearance, but even in the dark and dreary days of February it was very agreeable to see both green foliage and flower in tolerable abundance.

On either side of this winter garden are two stoves, in which are to be found a larger number of new plants than I can well record even the names of; but among them were Palms (of which Mr. Bull has a choice collection), Ferns, Orchids, &c. *Areca dealbata*, the Silver Palm of Madagascar, is a very elegant-foliaged plant drooping over the sides of the pot. Then there was a variegated *Pteris*, with much better foliage and habit than the old variety, and with serrated edges; and splendid plants of *Gleichenia dicarpa* and *Asplenium flabellatum*. Amongst Orchids I noticed some nice plants of *Angræcum sesquipedale*, the beautiful species from Madagascar, and which Mr. Bull is enabled to sell at fifteen guineas. Then there were *Vanda Griffithii* and *violacea*, *Zerides Schroederi* and *Fieldingi*, *Cypripedium Veitchii* and *Lowii*. Then amongst those dear little beauties, the *Amætochilus*, were to be seen some apparently most desirable kinds—such as *spectabilis*, with large leaves like *Lowii* and the colour of *cretaceus*; *magnifica*, with leaves 6 inches long; *speciosa*, very pretty; and many of the better varieties of the older sorts. Of course at this season *Caladiums*, *Belgonias*, *Achmeas*, and *Gloxinias* (of all of which Mr. Bull has a numerous collection), were at rest, and nothing could be seen of them. There were, however, nice plants of *Alocasia zebrina* and *alba violacea*. Then there were the curious Australian Pitcher-plant, *Cephalotus follicularis*, and several varieties of *Pandauns*, among which were *elegantissimus*, with serrated leaves, and *cuspidatus*; and also a very fine variety of *Dracæna*—viz., *terminalis latifolia pendula*, like *terminalis*, but with broader leaves, which are pendulous; also *Ehrenbergii*, a fine species from Mirador, *Chameranthemum reticulatum* and *marmoratum*, and a host of other new plants. There were also fine plants of the valuable *Inantophyllum miniatum*, and *cyrtanthiflorum*, like the former, only of a lighter shade of colour, with drooping instead of erect flowers. Nor must I omit *Clerodendron Balfourii*, which is said to be better than the very handsome *C. Thomsonæ*. Then there was *Calonyction sanguinea*, a beautiful-foliaged hothouse climber, with large heart-shaped leaves measuring 10 inches across; and also *Corysanthes limbata*, which one of our most distinguished botanists has called a perfect gem, and declared that in a lithograph it was impossible to do justice to the transparence of its stem, the vivid green and white of its delicate undulated and variegated leaf, or the sparkling beauty of its amethystine flowers. I had almost forgotten amongst Ferns the pretty small tree Fern, *Asplenium pinnatum*, from Brazil; and the beautiful stove Fern *Asplenium ferulaceum*, on which, although the fronds are 1½ foot long, yet the parts are of that delicate and fine character as to have suggested the name of Fennel-like; as also *Adiantum Feei*, of half-

climbing habit and *Gleichenia*-like growth; and *Cionidium Moorei*, an Australian species which was exhibited before the Horticultural Society last year, and which is remarkable for producing its fructification in cup-like appendages on the margin of the leaves. Amongst the hardy subjects was a nice stock of *Aracaria Rulei*, which is described as being without exception the grandest and most beautiful tree in existence. It is somewhat of the character of *A. imbricata*, but with denser foliage and a larger number of branches. It is not so hardy as *imbricata*, but will make a good plant for the large conservatory or winter garden.

Mr. Bull has several houses filled with those plants in which I am more at home—*Fuchsias*, *Petunias*, *Antirrhinums*, *Verbenas*, *Pelargoniums*, &c.; but at the season of the year in which I was there it was impossible to form any opinion concerning them. Of the Horseshoe or *Zonale* varieties of *Pelargoniums* he has an immense collection, one house being completely filled with them. I have already stated that I think he has obtained a very good strain from which we may expect occasionally some good things. Of those which he sent out last year I have reason to speak favourably; and I can therefore readily conceive that those of the present season are an advance upon his previous varieties, and no doubt the house would be a blaze of most dazzling beauty when all were in flower together.

It were utterly impossible for me to convey an idea of the multitude of objects of novelty and interest which Mr. Bull has collected together; for not only has he the novelties which he himself introduces, but also those sent out by other growers, so that any one desirous of knowing what new things are is pretty sure of having his curiosity gratified, and will be certain to meet every attention from Mr. Bull.—D., Deal.

NORTH AMERICAN TERRESTRIAL ORCHIDS.

YOUR correspondent, "A. R.," asks for information on the cultivation of these rare and curious plants generally, but specifically as regards *Calopogon pulchellus*, *Goodyera pubescens*, and *Jeffersonia diphylla*, one of the order *Papaveraceæ*. Your correspondent, however, does not furnish any special data to act upon, and I am, therefore, left to surmise a great deal, and specialise very little. Were correspondents to study their own interests, they would confer a boon on those who answer queries, and would receive answers more suited to special cases, by stating the present state and previous treatment of the subject to which the query relates.

CALOPOGON PULCHELLUS is an elegant purple-flowering, tuberous frame perennial, growing 1½ foot high, and flowering in July. It is increased by division of the root. It is synonymous with *Limodorum tuberosum*. To grow it successfully it requires a compost of turfy yellow loam one-half, sandy brown peat one-fourth, and leaf mould partially decomposed the remainder; the whole to be well mixed and chopped with a spade, but not sifted. This kind requires the protection of a cold pit or frame, and so in fact do most of the hardy North American Orchids, not so much on account of the severity of our winters, which are nothing compared with those of North America, but to shield them from the vicissitudes of our climate, especially its drenching autumn rains. It should be repotted in spring, just as the buds begin to swell. The soil should have been well exposed to the weather for at least a twelvemonth, and must be kept under cover a few days to have it in a proper condition for potting. Having a clean pot of a larger size in readiness, drain it well to at least one-third of its depth, and on this place an inch of the rougher parts of the compost. Turning the plant out of its pot, pick away the old soil and drainage, being careful, very careful, not to injure a single root or tuber, and if any increase is contemplated it should be taken. Having taken away as much of the old soil as can be done without injuring the roots, place a layer of the finer soil over the rough, and then introduce the plant, placing it so that the crown may be in the centre of the pot, and a little higher there than at the rim. The crown should be covered about half an inch with compost, placing the compost solidly round the ball, but not too firmly, and the operation is completed by a gentle watering.

After potting plunge in coal ashes in a cold pit, and water sparingly until growth has fairly commenced, when a liberal supply will be required, especially when the leaves attain their full size, and the blooms are expanding. It will much refresh the plants to take off the lights during the prevalence of gentle showers, but they must be sheltered from heavy rains. From the time that the leaves appear air must be given in all weathers, for a close confined atmosphere is extremely pernicious to these plants. When the flowering is past the quantity of water should be gradually diminished, so as to leave it off altogether by the time the leaves decay.

During summer the surface of the soil in the pot will require to be frequently stirred, otherwise it will become covered with *Marehantias* or *Lichens*, excluding air from entering by the surface. In winter the pot should remain plunged in the situation previously occupied, and beyond the admission of air in mild weather, and protecting the plants from frost by means of mats placed over the frame, no more attention will be required until the time of repotting in the spring. In very severe weather, however, a layer of leaves should be placed over the pot in the frame, for the frost not uncommonly passes through the frame-covering, and so might freeze the plant in the pot; for though our winters are milder than those of North America, we must bear in mind that the remains of the summer's grass and the falling autumn leaves afford a protection to these plants in their native habitats which is denied them in cultivation. It is also worthy of remark that tuberous-rooted plants bury themselves considerably deeper in the soil than the cultivator considers advisable, and that a thick covering of snow shields them from frost and the vicissitudes of climate.

GOODYERA PUBESCENS.—This is a fibrous-rooted plant, rarely growing more than 9 inches high. It has white flowers in June and July. A strong chalky loam and sandy peat is a good compost for it. It should be potted in the same manner as recommended for *Calopogon pulchellus*—that is, just when the young shoots are starting from the crown, and the pot plunged quite to the rim in coal ashes on an east border. Water should be sparingly given at first, increasing the quantity as the plant advances in growth; and if drenching rains occur whilst the growth is young, a large flower-pot inverted will throw much of the rain off, and keep the plant from being deluged with it. By May the plant will require abundant watering, and onwards until the blooming is past, when water must be gradually withheld, so that it may be discontinued by the time the leaves turn yellow. After this the pot should be shielded from drenching rains; and when severe weather sets in it would be wise to remove the pot to a cold frame, where it could be protected from severe frost and an excess of moisture. The pot should be plunged to the rim. The soil should not be allowed to become dry, for this is quite as injurious to terrestrial Orchids as too much wet. It should neither be allowed to become dust dry nor very wet, but be kept in a moderately moist condition whilst the plants are in a state of rest.

JEFFERSONIA DIPHYLLO requires a compost of loam two-thirds, leaf mould one-third, with a liberal admixture of silver sand. It is best grown in a pot, for it is one of those pretty little things that are soon smothered in the neglected herbaceous borders. It should be potted in the spring, prior to starting into growth, and then plunged to the rim in a cold frame until May, when it may be plunged in the open garden in a sunny situation, where it must have a due supply of moisture in dry weather, and be allowed to go gradually to rest by withholding water. In autumn the pot should be removed to a cold frame, and the plant protected from frost, and kept dry at the root during winter. In severe weather a few inches of dry leaves placed over the pot will be sufficient protection; but this should be removed in mild weather, so that the roots may not become unduly excited, and air being given on all favourable opportunities, the plant will fare much better than if left in the open border. Towards spring it should be examined, and potted when just moving, removing as much of the old soil as can be done without injuring the roots, and potting it in the compost already named, and in a clean pot, larger in size if the plant has increased in growth, or in a smaller one if it be at all sickly. Any small divisions of the plant should be removed at the time of potting, for these only rob the main

root. The small roots should be potted to increase the stock, and will in time become sufficiently strong to flower.

GENERAL TREATMENT OF NORTH AMERICAN ORCHIDS.—They are all reduced at one period of the year to a complete state of rest, and at another period are excited to a continuous state of growth. The summers are hotter, and the winters colder than in this country. When once the snow begins to melt the American summer rapidly approaches. There is no fickle weather there, but an uninterrupted period of growth and another of rest. We must bear in mind also that, although the winters are much more severe, yet these plants grow for the most part in meadows and in the open glades of forests, so that they are protected in winter by the dead grass in the one case, and by the fallen leaves in the other, in addition to which the ground is covered with a thick coating of snow. Here, under cultivation, there is no dead grass to protect the plant from sudden changes of temperature, no leaves to prevent frost reaching the fibrous roots or tubers, and very seldom indeed is the ground covered with snow when severe weather sets in, at least it is as often absent as present.

It is the extreme changeability of our climate that tells most seriously against the successful management of these and other plants which pass one-half the year sealed up from the changes of the atmosphere by a coating of snow. With us the temperature varies from mild weather to severe in a few days; and many times over, during the period of rest, is the weather warm enough to excite these plants into growth during winter, and quite as often the reverse. This has a tendency to waste the vital energies of the roots, and these, year after year, get weaker and at last perish. This is very commonly the case where hardy Orchids are grown in borders, where the soil may be not only unsuitable, and the situation lacking that protection which Nature affords these plants in their native habitats, but devoid of that summer shelter afforded by grass and the verdure overhead.

Now, it is a generally acknowledged fact that success in the cultivation of this or that plant is dependant on the cultivator following out, as nearly as possible, the conditions of its natural requirements. Terrestrial Orchids require a protection from the rigour of winter, and shelter from the burning rays of a vertical sun. Extremes of heat and cold are not endured by them: hence they do not do well when grown indiscriminately in borders with other plants, but they require special treatment, and particular conditions of soil, shelter, and protection, and these I will briefly allude to.

The North American kinds are the most easily cultivated of the hardy Orchids—that is, they will well repay the pains taken with them, and seem to thrive better than our native species under artificial treatment. To do them justice they require more than ordinary care, and are best grown in pots and in cold frames. The situation most suitable is an open east border, protected from the north and west, but not to the extent to cause shade or prevent a free circulation of air from all points. The ground should be dry, and the soil taken out to the size of the frame to a depth of 2 feet. The bottom should be covered with lime-riddings to a depth of 6 inches, and made higher in the centre to throw the water to the sides. This concrete should be rammed until quite hard, water being added to make the lime set more closely. On this a single brick wall is built to a height of 1 foot 6 inches, the first row of bricks being laid with the ends 3 inches from each other, to allow of water getting through, the ends being previously dipped in gas tar; and a sprinkling of that substance being smeared on the bricks and concrete at all the openings, worms will not like to enter by them, and they cannot come through the concrete, so that the pit is impervious to worms from the bottom. Six inches of rough rubble placed at the bottom, and 3 inches of coal cinders on that, will leave 9 inches to be filled with sifted ashes, in which the pots are to be plunged. The frame is then set on the brickwork; it should be 6 feet wide, 2 feet high at the back, and 1 foot in front. Ashes should be piled against the frame all round, to within 3 inches of the lights, and this will prevent frost entering by the sides of the frame.

If it be cheaper to build walls instead of a wooden frame, that may be done, only if a frame be employed, the ashes round it may be removed in summer, and the frame raised

on a brick at each corner, thereby securing a circulation of air when the weather necessitates the lights being kept over the plants. It is on this account that I prefer a frame to a pit. We have now a dry site and means of shelter suitable for those which require frame treatment; and I may as well say at once that all the kinds of hardy Orchids are well worthy of a frame, but in some localities, and for some kinds, a border will answer moderately well.

The bed or border is best with an eastern aspect, and the spot should be concreted and well drained—in fact, made equal to a Vine-border. It would be well to grow them in raised beds made by taking out the soil to the depth of a foot, concreting the bottom if worms were at all likely to be troublesome, and placing 6 inches of rubble upon it, but before putting it on building a brick wall without mortar, so that the beds would be 4 feet wide with two or three-feet alleys between, which should be filled quite down to, but better a little below the concrete with lime-riddings or materials of any kind impervious to worms and slugs. When the surface level is reached the bricks should be set in mortar and carried up 9 inches higher, so that there will be 3 inches of concrete, 5 inches of rubble, and 1 inch of charred turves upon it, leaving 9 inches in depth for prepared compost in which to grow the plants. G. ABBEY.

(To be continued.)

FISH-CULTURE AND HORTICULTURE.

WE observe that the process of fish-hatching is now in full operation in the garden of the Royal Horticultural Society at South Kensington. It might be worth the while of the Fellows to ask the Council at the next ordinary meeting what are the terms upon which the operator has undertaken this business; whether it is a gratuitous exhibition on his part as an indirect advertisement of his profession, or whether any sums of money have been placed at his disposal to enable him to carry out his experiments? If the latter, from what source are those sums derived, and is any portion of the funds of the Royal Horticultural Society devoted to this purpose?

Efforts are now being made to establish at Chiswick a School of Horticulture, which, from all we can hear, will be begun, if begun at all, on a very second-rate scale, because of the want of necessary funds. Is it possible that the Council will raise obstacles to the development of such a plan, which is essentially one of the Society's missions, on the ground of want of means, while at the same time we hear they are paying Mr. F. Buckland £100 for such a discordant object as fish-culture? It is perfectly monstrous! Where will this foolery end?

ENTOMOLOGICAL SOCIETY.

THE meeting of the Entomological Society, held on the 7th ult., was made special for the election of a President in the stead of Mr. H. T. Stainton, who had been elected President at the anniversary meeting in January, but had declined to accept the office, whereupon F. Pascoe, Esq., F.L.S., who had been proposed by the Council as President in his stead at the February meeting, was unanimously elected.

Amongst the donations to the Society's library received since the last meeting were the publications of the Royal Academies of Brussels and Munich, the Natural History Society of Brunn, the Entomological Society of Vienna, the Linnean Society of London, the Society of Arts, the Liverpool Philosophical Society, Messrs. Dano, Zeller, Gerstaecker Schiner (Fauna Austriaca, Diptera), &c. Copies of the President's address delivered at the anniversary meeting were distributed amongst the members.

Mr. G. R. Waterhouse exhibited two new British species of minute Staphylinidae, belonging to the genus Aleochara, one of which, taken near Reigate, considerably resembled an Ocotea.

Professor Westwood exhibited specimens of both sexes of the magnificent *Ranzania splendens*, Thomson (*Ramphorhina Petersiana*, Gerst.), a species of Goliath Beetle, recently brought home from the Zambesi by the Rev. H. Rowley; also, a number of Lepidoptera from the same country, including a new Butterfly of the genus *Charaxes*, to which he applied the name of *C. Argynnides*, from its resemblance to

some species of Fritillary Butterflies. He also read the description of a new species of the true genus *Papilio*, from Borneo, under the name of *P. Hewitsonii*, belonging to the singular group typified by *P. paradoxus*, and also of two new Beetles, *Syntelia indica* (a new genus of the Trogoxetidae), and *Apatetica nitiduloides*; insects which illustrated the theory that very wide geographical range was not inconsistent with extreme divergence from the family type of former. Professor Westwood also exhibited the larva and cases of a common English Moth, *Eudrosia fenestrella* (*Tinea sarcitella*, Linn.), which he had received from a correspondent, who attributed to them the formation of numerous holes in a carpet recently laid down, the cases having been found in large numbers in the crevices of the floors and beneath the joists. He also exhibited specimens of *Ptinus hololeucus*, a small Beetle imported about thirty years ago from Russia, in a cargo of leather, which has subsequently spread widely over this country, and which had caused considerable damage to the leather binding of books in the library of one of his correspondents.

Mr. S. Stevens exhibited a number of interesting Beetles and Moths recently received from Old Calabar, Western Africa, including specimens of the interesting *Asthenorrhina Turneri* (one of the small Goliath Beetles). Amongst the Moths was a remarkable white semi-transparent species of which the veins of the wings were singularly distorted.

Mr. J. S. Bales communicated a memoir entitled "A Catalogue of the Cassididae (Tortoise Beetles), captured by Mr. A. R. Wallace, in the Eastern Archipelago, with descriptions of the new species."

Mr. Pascoe also contributed the first part of a paper entitled "Longicornia Malayana, or a descriptive Catalogue of the species of the three Longicorn families Lamiidae, Cerambycidae, and Prionidae, collected by Mr. A. R. Wallace in the Malay Archipelago." Not fewer than a thousand species of these fine insects were collected by Mr. Wallace during his residence among the eastern islands, of which number Mr. Pascoe estimates that at least eight hundred are new to science. In the introductory observations, Mr. Pascoe passes under review the systems of classification recently proposed by Messrs. Leconte, in North America; Thomson, in Paris; and Baly, in England.

Mr. G. R. Waterhouse read an elaborate paper on the construction of the cells of insects, especially those of a hexagonal form arranged in regular layers or combs, with the view of proving that the hexagonal was not the typical form of the cell, which was normally cylindrical, but when the cells were formed in close proximity the bees were compelled to give them straight sides arranged hexagonally. Mr. Waterhouse passed a well-deserved eulogium upon the collection of insect-structures exhibited in the nest-room, in the north zoological gallery of the British Museum, and divided the insect-nests into—1st, those formed singly in burrows in the ground or in wood; 2nd, isolated cells attached to extraneous objects, and of an oval form; and 3rd, cells arranged in groups or layers surrounded by a common envelope.

Mr. John Young made some remarks on the beneficial effects derived from the employment of Dumont's insect-destroying powder, which were confirmed by Mr. H. T. Stainton, who had used it in his garden at Lewisham.

Mr. F. Smith, the Chairman, stated that the introduction of the small, troublesome, House Ant into the metropolis, was, probably (in part at least), owing to the recent introduction of large cargoes of Pine Apples into London, he having observed this insect swarming in great numbers on a truck laden with this fruit offered for sale in Oxford Street.

MR. BEATON'S SEEDLING GERANIUMS.—We are informed that the entire stock, consisting of some thousands, of the late Mr. Beaton's seedling Geraniums have passed into the hands of Mr. William Paul, of the Waltham Cross Nurseries. We congratulate Mr. Paul on adding to his already well-earned reputation that of becoming the possessor of a stock of plants so unique and remarkable. These were the result of Mr. Beaton's last efforts in the work in which he was so great a proficient, and we look forward with interest to see some of those charming novelties which we know Mr. Beaton himself prized so highly.

GEOMETRICAL FLOWER GARDEN.

I SHALL be much obliged if you will give me some advice respecting the planting of the centre of my flower garden, a plan of which I enclose.

At the two ends there are sixteen small flower-beds, but I do not send a plan of them, as it is only the planting of the centre part that puzzles me. I have hitherto had it filled

with herbaceous plants, but this year I want to try it with masses of bedding-out plants. Will my proposed plan of subdividing the beds do? and will the dwarf blue Ageratum be a suitable companion for Christine Geranium? or can you suggest anything better for a light blue bed?—X. Y. Z.

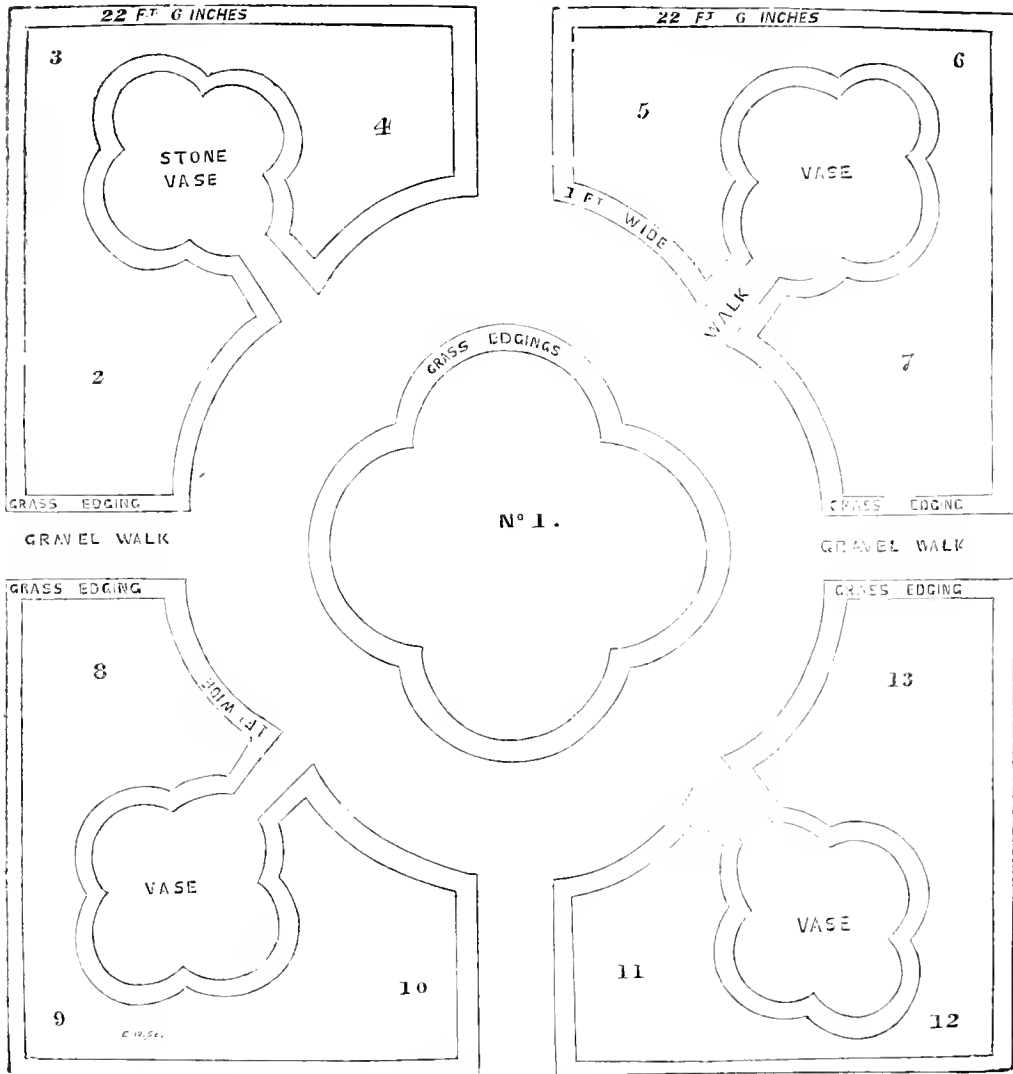

No. 1, Tom Thumb Geranium, with a border a foot wide of Lobelia speciosa round it.
2, 4, 11, 13, Dwarf Ageratum.

Nos. 3 and 12, Christine Geranium.
5, 7, 8, 10, Aurea floribunda Calceolaria.
6 and 9, Purple King Verbena.

[If you fill the centre with Scarlet Geranium, we would give it a broad band of such white-leaved plants as Alma or Bijou Geranium with the flowers removed, or of Cineraria maritima, or Centaurea candidissima. This will lighten up the whole group. The dwarf Ageratum will suit admirably if you obtain it true. You should use plenty of it so as to discard tall plants, or those with bad colour. When a good stock is secured it is best kept up by cuttings, as then you

will be more sure. We mention this because there has been complaint of seeds at times giving not true dwarfs. We would, however, change your arrangements, and make 2, 5, 13, 10, Ageratums; and 4, 7, 8, 11, Calceolarias; the rest as you propose. In another year we would edge all these four large beds, and plant still more simply. The four vases would be improved if they were from 3½ to 4 feet in height, and draped with hanging plants.]

A JAPANESE WORK ON HORTICULTURE.

DR. HALL, who, during a long residence in Japan, collected and sent to America many of the most remarkable plants of that country, has lately received a horticultural work in

twenty-five volumes, which he has kindly given the writer an opportunity of examining.

The volumes are thin, containing from eighty to a hundred

pages, of the form and size of a very large octavo. The paper is of silk; and the title, as is the case in various oriental languages, is at the extreme right instead of the left of the volume, so the book, speaking from our standard, is read backwards. The letter-press, as well as the engravings, seem to have been struck off from a plate, and not from moveable types. The character is in the usual vertical columns of Japan and China. There is very little of it, however, nearly the whole work being occupied by the engravings, consisting chiefly of representations of an astonishing variety of plants, and in number not less than two thousand. A few of the plates are coloured by hand, but for the most part they are line engravings, admirably drawn, and perfectly characterising the variety. Many, however, are designated by wooden or paper labels, represented as attached to them, and bearing their names in Japanese character.

After looking through these volumes, the conviction is forced upon us that the floral treasures of Japan are far from being exhausted, and the art of horticulture has been there cultivated with a skill and assiduity which has resulted in the production of an immense number of seminal varieties, full of interest to the horticulturist if not to the botanist. The work seems to have been issued as a serial, for there is but a very partial attempt at systematic arrangement, though a few of the volumes seem to have a character distinctly botanical, containing representations of plants of little interest in any other regard, accompanied with coloured dissections of the vital organs and other parts of the flower.

Among the genera represented, are Magnolia, Rhododendron, Azalea, Vaccinium, Salisburia, Palma, Aralia, Sophora, Ardisia, Acacia, with a host of herbaceous plants, including many varieties seemingly new. But one of the most interesting and characteristic features of the work is to be found in six volumes filled with illustrations, hundreds in number, of variegated-leaved plants, some of them of extraordinary beauty. Among the rest we observed a variegated-leaved Rose, a variegated Passion-Flower, Sagittaria, Arundo, Iris, Sempervivum, Dianthus Heddeewigi, Arum sauromatum, Orchids of many sorts, Acacias, all distinctly striped, spotted, or otherwise marked upon stem and leaves. There is also a vast collection of variegated Camellias.

In another volume, fifteen distinct sorts of Lily are represented, several of them new to the writer.

Another volume is devoted to water plants and Cacti; but one of the most curious of the whole series is that devoted to the instruments and appliances of floriculture. And here, more than ever, we found cause to lament that the abundant notes and explanations in Japanese, which accompany all these plates, were worse than Greek to us. No doubt, useful hints might be drawn from some of them, for no one can examine these volumes without being satisfied that the Japanese are adepts in the arts of cultivation. A multitude of appliances are figured for shading, protecting from cold, and forcing by artificial heat, some of them quite incomprehensible without the explanation. There is also a multitude of flower-pots and vases of every variety of ornamental device, together with pans and supports, some of them ingenious and tasteful to a high degree.

A volume, companion to the last, is filled with illustrations of the various methods of propagation, accompanied with copious descriptions, causing us more than ever to lament the defects of our Japanese education. First, there is propagation from the single leaf, as modified in its application to different species of plants; then from cuttings; then from layers, in many different forms; then from inarching. In the last case, the plant to be propagated is sometimes lifted with a ball, bound round the roots with wet moss and matted, and in this manner applied to the stock, or a large number of stocks planted near together. The book closes with the grafting of Coniferæ and deciduous trees; but strange to say, there is no illustration of budding.—(*American Gardener's Monthly*.)

ECONOMIC HEATING.

PLEASE refer to page 234, second column, and nearly at the bottom, where it says: "In section No. 4 it will be seen that between the flue and the four-inch wall of the plunging-pit is a cavity." Now, as the flue is not shown in the

section No. 4, may I trouble you to tell me where it should be. The reason I wish to know is, I am building a small vinery or useful house, 21 long, 14 wide, and am desirous of heating it, and the flue would also heat the pit. As I am desirous of forcing the Vines early, I hope there would be heat sufficient.—W. W.

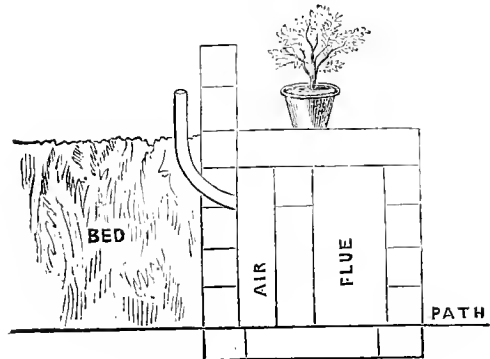

[In reply to "W. W.," I beg to explain that an error of small importance in the section of the flue prevents the explanation being so clear as it ought to be. I say small, because if the cavity for the air were made on the top of the flue, as there shown, it would answer equally well. Above is a section of the air-drain and flue, as intended for No. 4 section. The bottom of the pit, inside, is on a level with the flue that goes across; and there is a great amount of rough rubble, as old brickbats, &c., and over this a plunging material.

"W. W." need be under no apprehension as to deficiency of the heat. The Grapes in the vinery I mentioned close to this are now stoning, and that vinery would make at least two of the dimensions mentioned by "W. W." The only difference between my flue and a common flue is, it gives out double the heat, and takes less fuel by one-half.

I may add that I visited this house a short time ago with a friend learned in those matters. His only objection was, that if the fire were getting low in a cold night, the air would come into the house without being heated, and consequently do great injury to the plants. Mr. Frost not being present, I mentioned this when I saw him next. His reply was that it could not occur when once the bricks were heated. He had known the fire let out for twenty-four hours, and, although a cold wind outside, the air in the tubes was at 85°.—F.]

STRAWBERRIES IN NEW ZEALAND.

SEEING in your Journal last received the extraordinary weight of Strawberries—namely, fourteen to the pound of 16 ozs.—I write to say that I have this season seen some here in New Zealand of ten, eleven, and twelve to the pound, produced in a bed of extreme prolificacy. The bed is 14 yards square, and was planted in February, 1863; it is a stiff loam, well dressed with old manure from the Cucumber-frames, and was top-dressed in the spring, about August. Gathering commenced on the 15th of October, and has continued from that time until now (January 12), averaging two gallons per day ever since. The plants have now thrown out a second set of blooms as vigorous as the spring blooms. The bed lies facing the west, with a slight inclination to the north, on a gentle rise. One Strawberry, gathered in my own garden yesterday, was 2 inches long, 1½ inch broad, and 1¼ inch thick.

The owner of the garden I have spoken of is Mr. Mansell, and he has had many much larger than the Strawberries I have thus described.

The weather has been very unsettled this summer. We have had but a few days of heat, but vegetation has gone on rapidly in consequence of showers every three or four days. This day (January 12th), is equal to about the 21st of July at home; and I have planted Ash-leaved Kidneys for next spring seed, and sowed Peas for autumn picking to-day.

The Potatoes were in the same ground they were taken from three weeks since. I placed them in trenches as we do Celery, laying beneath them a mixture of road sand, bog earth, and brush weeds, and rubbish, with a slight addition of rabbit-dung.—G. EDWARDS, *Commission Agent, Willis Street, Wellington, New Zealand.*

WORK FOR THE WEEK.

KITCHEN GARDEN.

AFTER the late rains it will be advisable to pass a heavy roller over the gravel walks, to set and bind them well for the season. Trench-up all spare ground, placing all green refuse at the bottom of the trench, and strewing it over with lime to hasten decomposition. Take every opportunity to destroy slugs which the recent rains have brought out from their winter quarters in abundance, the use of quicklime repeated several evenings after showery days is generally an effectual remedy. Seeds are now coming up fast, and the hoe must be set to work as soon as they can be distinguished, never wait for weeds; take care not to tread on any ground after it is surface-stirred. *Broccoli*, make the principal sowings of favourite sorts to stand the winter; a sowing of the dwarf hardy Russian made a fortnight hence often bears frost better than those sown earlier. *Beet*, sow a little of the Red sort, but not much, as the chances are that it will run to seed. The Green and White sorts may be sown for the stalks. *Cauliflowers*, continue to plant out the strongest plants from the stock kept through the winter, those which have been brought on under hand-lights will be getting sufficiently advanced to be benefited by applications of liquid manure, to keep them in a free-growing state, otherwise we may expect some to button. Let the soil be constantly stirred about them. *Kidney Beans*, sow a few in pots or boxes, also a few dwarf sorts in a warm corner. These will require shelter for a short time when coming up. *Peas*, continue to earth-up and stake them as they advance. Sow successions of late varieties, and take care that those just coming up do not want for surface-stirring, which will be the more necessary after heavy, dashing rains, which consolidate the surface of the soil. Thin and transplant where desirable all seedling crops sufficiently advanced. *Radishes*, make successional sowings of these and Salads. Small sowings are best, each made as soon as the other is up.

FLOWER GARDEN.

As grass lawns will soon require mowing, they should be well swept and rolled, in order to be ready for the scythe. Plant out from the reserve garden Pinks, Cloves, Picotees, Carnations, Canterbury Bells, Sweet Williams, Lychnis, &c., into borders and beds, taking care to lift them with as much earth to the roots as possible. Vacant beds should now be dug up roughly, to be sweetened by the sun and air before planting time. Attend strictly to the neatness of the shrubby borders; rake and clean off everything unsightly before the more busy time arrives. Go over the Rose stocks budded last season, rub off all the suckers and buds that are making their appearance on the stocks, that the whole of the sap may flow into and strengthen the Rose-buds. Cut away all the ligatures that may have been left, that the shoots may have room to swell. Auriculas will require gentle waterings as they are growing fast. Take great care that the advancing blooms are not drawn up weakly, as hardly anything looks worse than to see stems unable to support their trusses. Polyanthus seed may now be sown either in pans or boxes, or on a border with a north-east aspect; the soil to be composed of decayed leaves, loam, and a little sand. Tulips will be benefited by having the surface of the beds loosened, all the cracks filled up, and the soil brought close round the neck of the bulb. Ranunculus ought now to be all in the ground; where this has been delayed, their planting should immediately be attended to. Propagate Pansies for succession, and fill up vacancies that occur in the beds.

FRUIT GARDEN.

The disbudding of Peaches and Nectarines must be commenced forthwith, removing all the foreright wood-shoots, and a portion of those on the lower side of each shoot also. As blossom-buds are very thick this year, it will be proper to take off a portion of those where ill placed. As the trees

advance in age and acquire a full complement of wood, and circumference according to the space allotted them, it will be found necessary to pursue this system of disbudding, in order that the trees may be maintained in a healthy, fruit-bearing condition, and not weakened by crowding with too much wood; for this end we must encourage only the young shoots nearest the base of the fruit-bearing shoot, but as the terminal shoot will be necessary for the proper maturation of the fruit, it must be closely stopped at the last thinning, and any attempt at growth afterwards to be carefully removed. As soon as the fruit is gathered, it is advisable to remove these stopped shoots down to the young ones, which are greatly strengthened thereby, and it also exposes the young wood more to the influence of the sun at a season when the exposure is most needed for its ripening. After high winds, freshly-planted trees in the open quarters should be finally looked over, and the earth pressed firmly around them.

GREENHOUSE AND CONSERVATORY.

As the season advances heat and moisture should be gradually increased; but in all cases avoid a high night temperature. Let Fuchsias for summer and autumn display have due attention, repotting them as may be required, and occasionally watering them with liquid manure. Look well after the Azaleas for next year's flowering; use heat liberally to forward their growth, and if any overluxuriant shoots arise pinch them in directly. In shifting, drain thoroughly; use chiefly a sharp sandy peat, or, rather, heath soil, adding a small amount of leaf soil. The leading shoots of Epacris, Chorozemas, Heaths, Corraes, together with as many other choice plants as produce the best effect in a bushy condition, should be frequently pinched or stopped, in order to form good specimens; also those of Calceolarias, Verbenas, and other young stock intended either for decorating the flower-beds or for succession in pots.

STOVE.

If former directions have been attended to the plants in this house will now be making rapid progress, and some of the young plants which are growing on for specimens will probably require a second shift. See to these in time, and, if they are in good health, treat them liberally by giving a large shift, especially to plants of free growth. Nothing is more interesting than a house of healthy stove plants at this season; for if well managed you may almost fancy you can see them growing. Give plenty of air at all favourable opportunities, and saturate the atmosphere with moisture. If not attended to before, it is now time to put in cuttings of the winter-flowering plants—such as *Eranthemums*, *Begonias*, *Justicias*, *Gesneras*, and *Euphorbias*. Should the mealy bug make its appearance among the plants no time should be lost in endeavouring to eradicate it: brushing it off is, we believe, the most effectual means.

PITS AND FRAMES.

The plants to have plenty of air in favourable weather to harden them for turning out. *Verbenas*, *Salvias*, &c., may still be propagated for the flower-beds. Tender annuals to be shifted as they require it: give them plenty of air, but let them have a moderate bottom heat. W. KEANE.

DOINGS OF THE LAST WEEK.

KITCHEN GARDEN.

PLANTED out the remainder of the winter-saved Cauliflower, which consisted of the smallest plants. Stuck a few twigs of laurels on each side of the rows. Thinned those under glasses, watered and top-dressed them, and shut the glasses early to bring the crop early to maturity. Kept planting Potatoes as the ground could be had. Have had good gatherings from those forwarded in pots. Planted out the *Peas*, Sangster's No. 1, sown on turf, but with rough leaf mould and rough rotten dung below, into which they had rooted. These were put on a south border, and to make the most of it the rows were little more than 3 feet apart, which is contrary to our usual plan with *Peas*. These transplanted *Peas*, however, as they bear earlier, do not in general grow so strong as those sown at once. In turning them out the turves and the leaf mould below them were little broken, and the driest mellow surface soil was trundled in

about them, and each row was staked and finished as the work proceeded, every row having also a few laurel twigs stuck on each side of it. This mode of finishing as you go leaves the ground mellow and loose behind you without a single footmark to be seen—just one of those little things in such circumstances that do so much to insure neatness and success. Only think of the mess, especially if the ground were damp, which would be caused by planting out such a border, and then walking up and down for the purpose of staking until the ground were left pretty well as hard as a macadamised road. In staking Peas it is difficult to get men to leave an old beaten track, more especially when the work done in the old way looks the neatest. The stakes are generally put in so as to meet or cross each other at the top, resembling when finished a triangle with a narrow base. When so done the haulm at the top falls through the stakes and is broken by the wind. It is a much better plan to let the stakes stand upright or nearly so—say with a base of 2½ feet at bottom, and an opening at top of some 18 or 20 inches. The tendrils will cling to the stakes equally well, and as there is more room inside will be less likely to fall outside the stakes. Stakes are so difficult to be had and last such a short time that cheap light wire hurdles would in many cases be a great advantage for amateurs and the possessors of small gardens, who have come to the conclusion, in which we cordially agree, that to realise the fine flavour of a Pea it ought not to be long gathered before it is boiled, and, also, that the pods should have light and air around them, instead of being huddled near the ground. But for this latter fact, good crops of the general kinds of Peas—that is, those of not very high growth, may be obtained by the haulm being allowed to rest on the ground, with the exception of some short stakes, and a line on each side, being placed to prevent the wind sweeping the haulm into bundles. Scarlet Runners do very well when grown in this way, even without any strings, but topped as they grow and with a little litter over the ground to prevent the pods being dirtied in showery weather. The transplanted Peas are growing freely and putting out their tendrils healthily, though they have had several frosty mornings, and 3 inches of snow on Wednesday morning. Planted out a few of the dwarf Tom Thumbs into the late orchard-house, which may come in a few days before those planted out of doors, and succeed those coming into bloom in pots in the first orchard-house. Prepared a border for sowing the Cabbage tribe in a week or so. In noticing the fibrous matter in the remains of Sea-kale leaves last week, we meant to say that it might be owing to the peculiarity of the “winter,” which has been printed “water.” This fibrous matter was so strong the other week that we are convinced that if it had been noticed sooner, it would have made a nice material for tying small plants, quite as good as the China Grass now coming into vogue for that purpose. Other matters much the same as in previous weeks.

FRUIT GARDEN.

Planted out some of the Strawberry plants that have done bearing in the houses, and which we expect will give us an autumn supply. Squirted Gooseberry bushes with a thickish mixture of soot, lime, clay, and cowdung, to render the buds unsavoury to the birds. Pruned and nailed Peaches. Find that we are rather late with Apricots, and, a sharp frost being expected the other night, covered with laurel boughs, and stuck in some to stand out horizontally for 2½ feet from the top of the wall. Will uncover as we can fasten the trees, and if the weather be very cold, will let the fastening alone until the weather clear up and be fine and mild. Painted Cherry trees over with such a mixture as was lately mentioned, to keep birds from the buds, and to keep insects down, if there should be any larvæ of them left. These trees had been painted previously, but the rains had washed it off considerably. A good many of the Apricot buds have also been pecked off, though we do not recollect of the birds meddling much with them or with Peaches. We have not noticed any Peach trees interfered with as yet. Our own impression is that, where covers are very securely kept near gardens, the gardens will cease to be of much use, unless they are netted over at certain seasons of the year. Under such circumstances small birds will increase amazingly. Set out and arranged the second division of the orchard-house, with Peaches and Nectarines

on the back wall, and the front border filled with plants in pots, chiefly Cherries, Plums, and Pears, all of which are swelling their bloom-buds freely, with which they are well supplied. Had the shallow gravel path removed from such houses, and after stirring the ground added some manure, and fresh surfacings of soil. Placed down a latticed gangway of wood 16 inches wide, which will save a great deal of trouble so far as giving the roots air and moisture is concerned. After clearing away all the litter which protected the pots in winter, we scraped off and removed about a couple of inches of the surface soil; and after the pots were fresh placed, the whole was forked over, and then sprinkled, as well as the pots and the bottom of the trees, with strong sulphur water. We have merely watered the pots in a sunny day, and the back part of the border below the trellis, where it was driest, and will leave the rest of the house rather dry until fine sunny weather set in, as if we should have a sharp frost, it will be less felt in proportion as the soil and air of the house are dry. The Plums and Cherries, as well as Peaches, &c., in the first of these houses, are in full bloom, and setting or beginning to do so; and this house receives a little less air than the other, and in a cold night, and more rarely in the morning if frosty, a fire has been lighted in the *iron stove*.

Several people, rather sceptical as to the effects of such a stove in so large a house, have come to see if they could be convinced against their will; and what has puzzled some of them is how the ends of such a house are heated as well as the centre—that is, within a couple of degrees or so of the same temperature. This is so different from what some of our readers and correspondents have found, the air being heated only to a short distance from the stove, that we regret very much being unable to assign a satisfactory reason. We may, however, mention two circumstances that may possibly have something to do with it. The first is, the stove is sunk for the greater part of its depth, with an open space round it. The second is, there is a small open space all the way at front between the rafters and wall-plate, which we generally daub up in winter with hay or moss, but which is open now; and the large squares of glass, 20 inches across by 12 in depth, are open-glazed—that is, have no putty, &c., in the laps. Judging from analogy, we think there may be something in these facts as tending to diffuse the heat more regularly from a common centre, and which might not be so effectually done in a close-glazed house. We have made no other alteration, except having a good-sized vessel of plate-iron to stand on the top of the stove, painted with red lead inside and of a black colour outside; the red being the best to resist rust. This vessel will hold several pailfuls of water, and has had a pound of sulphur mixed up in it. This will give off vapour slightly sulphury, and when quite clear the water will be pretty well as much influenced by the sulphur as that obtained by a correspondent by pouring boiling water over sulphur contained in a bag. We have more faith in such water, and the lime and sulphur water which we have several times referred to, for keeping insects away, than in any painting or using the sulphur in a raw state. There is only one objection to the moderate use of such water, and that is that it will taint the hands and clothes where it drops. This might not be objectionable to some people; in fact, we have been told by a good authority that for keeping off and driving off cramp in the limbs nothing is so effectual as holding a piece of stick sulphur firmly in the hands. Other fruit-houses much the same as before, with the exception of drawing a dry hand over bunches of Sweetwater Grapes in bloom.

In the last line of Fruit Garden last week the word “plants” should be “fruit.”

ORNAMENTAL DEPARTMENT.

The weather being unsettled, opportunity was taken to pot lots of stove and greenhouse plants. The lawns were rolled in fine weather, but the ground was not in a first-rate state for doing much there. When fine, and the ground is light, hardy annuals may be sown. Where there are plenty of pots, it is a good plan to cover the tenderest of the patches with pots, and then edge these up on one side, when the seeds are above the ground. Sweet Peas and Lupines sown now in good rich soil, will bloom a long time if the most of the pods are cut off. Beds of all the hardy annuals may now be sown. In general, however, to produce

TACSONIA NOT BLOOMING (A. H. J. L.).—It appears to be *Tacsonia pinnatifida*, which requires to run freely, and to be pruned very little, if at all. Your conservatory is too warm, perhaps, for this *Tacsonia* is almost hardy, and requires abundance of air.

VINE DISEASES (H. B.).—We differ from you, for we think the Vine has not been "well kept in the hot-house." It has been kept too hot, and too little air has been admitted. The bunches that would have been consequently become tendril and slanked, or ulcerated, the roots not being sufficiently active to supply sap for the rapid upper growths.

DRYING BOTANICAL SPECIMENS (Inquirer).—Mr. Brocas, 25, Hart Street, Bloomsbury, supplies botanical presses for this purpose. Until you obtain one put the specimens between sheets of blotting-paper, placing a stout even board upon that, and a weight.

WOOD versus IRON ESPALIER-RODS (S. W. G.).—It is nonsense for any one to say that iron espaliers cause canker in the Apple and Pear tree stems trained to them. If the branches are left so that they are moved by the wind, then they may be injured by the friction, otherwise we consider iron espaliers far preferable to wood where expense is no object, or where wood stakes are difficult to obtain. We have not found anything better than stout oak stakes, 4 inches square, firmly fixed in the soil to a depth of 2 feet, the lowest end having been previously charred for 2 feet 6 inches of its length. Place them perpendicularly 4 feet apart, and 5 feet out of the ground. Along these, quarter-inch galvanised wire is strained out and horizontally, the lowest wire at 1 foot from the ground, and the others 9 inches apart above it, and these form the rods to which the branches are trained. The wires will be secured in their proper places by small staples driven into the oak posts. These are not expensive, and very serviceable espaliers. It is immaterial whether the supports are fixed horizontally or perpendicularly, but we prefer the former. We consider iron far preferable to wooden espaliers. They last longer, and do not harbour so much mildew.

CALCEOLARIAS—GERANIUMS, &c. (Agnes).—*Calceolaria*s now put into earth pits will require to be covered with oiled calico, or old lights, to protect them from heavy rains on sunless frosty days; but all the air, light, and sun possible should be admitted in mild weather. When severe weather occurs (and we may have some severe frosts yet), in addition to glazed lights, some mats should be thrown over them. Geraniums should, by all means, have the protection of glass for a month yet. We rear a calico covering would not answer your purpose. It is now thought a good plan to put them in moss, and we have tried the plan and find that it answers admirably. We plant out Geraniums, Verbenas, &c., with the ball entire; and we advise you not to follow such a plan as disrooting when planting out, for plants feel the effects of the change sufficiently without positively injuring them by such a process.

SEEDLING PRIMULA (A Four-years Subscriber).—The pips, with but one exception, have become entirely white by fading. From the appearance of that one, and the defective form of all, we think the variety would not be of any marketable value.

WATER MELONS (A Mountaineer).—We do not think you will do much with such a monster Water Melon in a two-light box. You may succeed by giving it little earth to grow in, and curbing the roots. If you kept your plants in the box, and shifted them singly, until you had each of them in 15-inch pots, and then took them to the viney you speak of, and trained them some 18 inches from the glass, you would be more likely to succeed. We would stop the Melons, allow them only one shoot to a plant, train that shoot on the viney for 4 or 5 feet at least in length, pick out all the buds from the axils of the leaves for 3 or 4 feet, nip out the point of the shoot, say at 5 feet, which will leave several side shoots to come from the part not disbudded, and then take one or two fruits from a plant. A Melon as big as our two lists is as large as we wish them to go to table. 150 lbs. is certainly a monster. You may invite the village to a feast. The Feverfew will do very well.

RIBBON-BORDER (J. C.).—Selecting from your list and beginning at the back, we would have *Ageratum* tall, *Trentham* Rose Geranium, *Perilla*, *Calceolaria aurea*, *Tom Thumb* Geranium, *Variegated Mint*, *Yellow Pansy*, *Lobelia speciosa*, *Cerastium*. The white *Alyssum* sown would be too coarse.

IRON-FRAMED GREENHOUSES (P. Hunter).—There is no objection to cast-iron houses or wrought-iron houses, if they are kept well painted, and there are sufficient rebates for the glass to permit of easy glazing, so that the glass shall not be broken by contraction in cold weather, &c. The chief objection is their greater coldness in winter and warmth in summer, where much iron of bulk is used; but when the sash-bars are small, and well painted, the difference between them and wooden houses is not great.

PLANTS FOR GLASS CASE (An Old Subscriber).—You do not tell us where you place your case. For this season you might have *Primulas*, *Violets*, and a hanging-basket of the *Tradescantia zebrina*, or some of the smaller and rarer alpinas; but we would know better if you repeat the question, and tell us where the case is to be placed. A little miniature rockwork, with a few small alpine plants, such as the nearest nurseryman, if tasteful in these matters, could furnish, would be interesting. We have a glass case just now looking very bright, having the soil clothed with *Lycopodium denticulatum*, with some of the upright-growing Ferns, such as *Nepitrolepis pectinata*, *Cyperuses*, and *Hyacinths*.

ANTS IN HOTHOUSE (A Constant Subscriber).—Guano in powder, sprinkled about the pots of *Strawberries*, and over the haunts of the ants, will be effectual. Water with the ammoniacal liquor from the gas works, applying it as we have directed the guano to be applied. Repeat the application until the ants are extirpated.

CHRYSANTHEMUM CUTTINGS AND PLANTS (Agnes).—The bulk of our *Chrysanthemums* are managed thus:—After flowering they are turned out of doors into a sheltered place, not cut down, and in severe weather a few boughs are stuck in amongst them. In the beginning of April the plants will have thrown up suckers, all the better for the dead tops being still on them. These cuttings are taken off and put under a hand-light in the open ground, and when they are rooted a few are taken up and potted, and the remainder are planted out in the open ground, about 18 inches or more apart. These are stopped once in July, and taken up and potted in September, and become nice bushy plants. All our plants stand in the most exposed situation, to prevent anything like drawing, the pots only being shaded either by being placed inside another, or plunged in moss. Most likely, however, you will see some notes on their culture by some of our departmental writers.

PRUNING AND PLANTING COMMON AND IRISH YEW (A Subscriber).—If the Irish Yews are large fine plants, and open and spread at top, it would be better to put a strong wire round them in two or three places than cut them too severely. Some little cutting away might be done at the same time; but unless plants have been begun to be pruned when young, and kept pruned, they are very apt to get open and loose at top, and cannot well then be cut into shape. The Yew thrives best on a dry stony soil, and transplants well, only trees that have been self-sown in a wood or waste, and grown some years, can seldom be moved with advantage. If you want them as a screen, prune very little, until they accomplish the object wanted. After this they may be cut at will.

SOLOMON'S SEAL FORCING (M. G.).—We confess not being acquainted with the forcing capabilities of the different species of this plant, as mentioned in "The Cottage Gardener's Dictionary," our own forcing that way having been all directed to that of the Lily of the Valley, a plant immensely superior to any of the species of *Solomon's Seal* we have met with; and it only forces well by being grown well the preceding season. It, however, thrives well on most sandy soils, and we have seen it taken up from such a thrives in turf-like lumps, and produce flowers abundantly; while in other places it cannot be made to do so by careful artificial means. *Solomon's Seal* is no doubt capricious in like manner.

DESTROYING LAURELS (H. Goddis).—We should think a strong dressing of gas lime would kill the roots of Laurels, as well as rocksalt. If not strong it will ultimately add to their vigour. Unless this can be procured near at hand, why try either mode in preference to grabbing them up? This, after all, we think would be the cheapest plan; and we should like better to hear of our Irish brethren getting good wages for such work than hear of their going to be shut at in Jonathan's quarrels. Laurels must indeed be an eyesore when there is such anxiety for their destruction. Most people would rather cut and prune. When faggotted they make capital firewood, when old and dried.

GEOMETRICAL GARDEN (Lilian).—Cuttings of *Gazania* may be made to bloom in autumn. Seeds of *Lobelia* sown now (see "Doings of the Last Week"), and pricked-off and hardened-off, will bloom from the end of June. Your *Lapageria* is most likely deficient as to drainage; it must have moisture, but not stagnant. The arrangement of colours in the garden will look well. The seeds sown now in a slight hotbed, though planted out in patches, will not all be in full bloom in June. If sown in the autumn all except the *Nasturtiums* would have been so. The *Nemophila* and *Clarkia* will be the best; and *Silene pendula*, white and pink, would be fuller than *Saponaria calabrica*. This latter, sown in the end of April or the beginning of May, would keep on for the year. Yellow *Heartsease*, or *Erysimum*, or *Eschscholtzia*, would be better yellows in June than *Tom Thumb Nasturtium*. Then for August and onward you may have the *Saponarias*, pink, and treated as above, blue *Lobelia*, orange *Gazania*, scarlet *Verbena*, Purple King *Verbena* or *Verbena pulchella*; and the *Nasturtiums* will be at their best from July to frost.

DEEPENING EARTH OF VINE-BORDER (J. S.).—In the case of Vines not doing well we should not think of placing a twenty-inch new border on the top of the old one and expect them to do better. The ceasing to crop the border with flowers is all right. If that were done, and part of the old surface soil removed, and a few inches of fresh added, the roots might be coaxed to the surface, and an inch or so added every year. If we thought of 20 inches of a new border we would have lifted the Vines, drained if necessary, taken away as much of the old border as would have given a good loose bottom, and then replanted the Vines in the new material. If the stems of the Vines are covered thus 20 inches deeper roots may be emitted from them, but this is not a plan to be advised. The work being done, if drainage is all right we would plant fresh Vines in the new border, and let the old ones remain as they are just now, cutting them out as the young ones take their place. The flat roof will do tolerably for Grapes to ripen in the beginning of autumn, but not at all well for early Grapes or Grapes to hang through the winter. Your *Hydrangea* will do best in a box in a sunny place and the surface soil enriched.

ROSE TREE (J. C.).—We believe the mass to have been a nestful of spiders' eggs; but it was entirely smashed by the post office punch.

RIBBON-BORDER (A Young Beginner).—Which of the following arrangements would be best? I should like seven rows if they would not be too thick. No. 1.—*Christine* Geranium (top row), *Perilla*, Flower of the Day Geranium, *Scarlet Tom Thumb* Geranium, yellow *Calceolaria*, blue *Lobelia*, *Cerastium* (bottom row). No. 2.—Old *Scarlet* Geraniums, Flower of the Day ditto, *Perilla*, yellow *Calceolaria*, *Christine* Geranium, *Lobelia*, *Cerastium*. No. 3.—*Perilla*, *Scarlet* Geraniums, Flower of the Day ditto, *Christine* ditto, *Calceolaria*, *Lobelia*, *Cerastium*.

We like No. 2 best: the *Perilla* and *Amaranthus* will shade each other nicely if mixed. We do not know the best edging to *Christine*. We have seen *Alma* with the flowers off look charming, and so have we seen *Verbena Purple King* very telling, but we should not like to decide which was best.]

NAMES OF PLANTS (C. F.).—The specimen is too much shrivelled for us to be certain, but we think it is *Arthropodium errhatum*, a New Zealand plant. There is a drawing of this species in the 9th volume of the "Botanical Register."

POULTRY, BEE, and HOUSEHOLD CHRONICLE.

POULTRY SHOWS.

- APRIL 7th. ACCRINGTON. Secs. Mr. J. Dugdale, Dutton Street. Entries close March 31st.
- MAY 26th and 27th. WOODBRIDGE. Secs. Messrs. Dallenger and Whistock, Market Place.
- JUNE 1st. BEVERLEY. Secs. Mr. H. Adams and Mr. J. Kemp, jun. Entries close May 21st.
- JUNE 13th to 17th, 1861. BATH AND WEST OF ENGLAND, AT BRISTOL. Steward, S. Pitman, Esq., Bishops Hall Manor, Taunton. Entries close May 9th.
- JULY 14th and 15th. EASTERN COUNTIES. Secs., Messrs. Ranson and Simpson, Stowmarket. Entries close July 1st.

NOTES FROM A CROSS-GRAINED CORRESPONDENT.

I READ your paper last week; but in your article on Trimming Game Fowls, although I agree with it all, I could only say when I got to the last lines, which, like a young lady's "P.S.," contained the gist of the whole, "What! all this sack to one half-pennyworth of bread?"

I have been breeding Hamburgs, and had a bird so beautifully pencilled, that I determined to overlook a single comb. None of her chickens are as well pencilled as herself, nearly all are single-combed. Ask your last week's correspondent why I may not dub them as well as Game. I can answer for their pugnacity. My best bird was killed by his son about a fortnight ago. Can any of your readers tell me why faults are transmitted more certainly than merits? Can they tell me why prize birds cannot be bred, both cocks and hens, from the same parents? We do not sufficiently communicate our experiences. The bee-keepers put us to shame. I do not like bees or I would keep them. All my hens have laid badly, and I have no sitters. I can hatch them artificially, but cannot rear them. Can any one tell me anything about it, or give me any hints on the subject likely to be useful?

I have found more pleasure and less loss in poultry than in any other pursuit, but I have not only not made it profitable, but it is not self-supporting. My greatest satisfaction is, I eat really new-laid eggs and wholesome-fed fowls. Other people make profit, why is it impossible for me to do so? There seems to be a law that as soon as a man has an independent property every pursuit shall immediately become profitless. I do not mean legitimate trade or commerce, but hobbies. I am quite prepared to have my writings criticised, but I am tired of reading smooth articles. It is one of the charms of the "Spectator" that papers of all kinds were admitted, and I have derived more real pleasure from some of the grumbling articles in that periodical than from others of great pretensions. Give me space, if you please, and some reader may derive satisfaction from the fact that he is not alone in his ideas.

ROYAL DUBLIN SOCIETY'S SHOW.

THIS was held in the Society's show-yards on the 31st ultimo. We can only record the prizes awarded to the poultry, of which 150 pens were exhibited.

DORKINGS.—First, Col. Leslie, M.P., Glasslough. Second, G. Langtry Malahide. *Chickens.*—First and Second, Col. Leslie.

SPANISH.—First, R. W. Doyle, Dundrum. Second, C. E. McClintock, Randalstown. *Chickens.*—First, R. W. Doyle. Second, C. H. Peacock, Dalkey.

COCHIN-CHINA.—First, F. W. Zurhorst, Donnybrook. Second, R. W. Doyle. *Chickens.*—First, R. W. Doyle.

GAME.—First, G. Langtry, Malahide. Second, C. H. Peacock, Dalkey.

HAMBURGHS (Spangled).—First and Second, Mrs. Kemmis, Maryborough. *Chickens.*—First, Mrs. T. Kemmis, Portarlinton. Second, Mrs. Kemmis, Maryborough.

ANY OTHER VARIETY.—First, R. P. Williams, Hollybrook; Mrs. Kemmis; and F. W. Zurhorst. Second, J. Lafarelle, R. W. Boyle, and R. P. Williams.

TURKEYS.—First, Capt. Cole, Hamilton. Second, Mrs. Murphy, Streamstown. *Poult.*—First, R. W. Boyle. Second, J. Tate, Mullingar.

GESE.—First and Second, R. W. Boyle.

NEW VARIETIES OF PIGEONS.

I AM much obliged to your correspondents who have kindly answered my inquiries about some varieties of Pigeons, and from their replies I recognise the Brunswicks as a Blue variety of the Priest Pigeon, so common in Germany; the Icelanders are evidently the German Ice Pigeons; and the Sabinettes are a spangled-shouldered variety of Turbits.

While thanking those who have given me the explanations respecting these birds, may I ask for an account of the Neapolitan? I rather fancy they are a variety of the rare breed called Laughers, on account of their peculiar coo.

I hope I shall not be thought troublesome if I again ask, Can any reader of THE JOURNAL OF HORTICULTURE give any information respecting the Lowtans or Ground Tumblers of

India? or what variety it is of which we read that the natives of that country train them for high fliers? By so doing they will confer a favour on—B. P. BRENT.

RECOLLECTIONS OF AN OLD FANCIER.—No. 2.

HUMBLE FRIENDS AND SMALL PETS.

THERE seems to be a brief period in the life of us all when pride of position is unknown. What man is there but remembers, when he was just emerging from childhood to boyhood, not as yet the smart youth wholly taken up with his appearance, not grown to the aristocratic age for carrying a gun, and talking of "our fellows," that he had a strong friendship for some humble mechanic, some ingenious artisan, or small tradesman? How he half sighed that he could not renounce his place in society, and be bound apprentice to that dear old tinker, in whose shop—a little back place it was—he sat and watched the soldering of old kettles, or looked on admiringly at the rounding of a sheet of tin into a pot-lid; how the very smell of the old shop was pleasant to him, and how much he really learnt of life's experiences, picking up many a bit of knowledge to come into use some day—perhaps in the colonies when thrown upon his own resources.

Or, perhaps, it was not the brazier, but the carpenter, a little wizened-faced old man, childless, and therefore fond of children, who was the friend, the chum. Well do such humble friends know how short and uncertain is the tenure of their friendship. "Ah! Master Harry, you'll be a fine gentleman soon, and you'll be above I and my old shop." "No, John, never." "Yes, but you will, though; I knows the time will come, and you'll not make friends of the likes as me."

Now, at this no-pride age, my great crony was old Will Read, the shoemaker. I believe I could mend shoes now, for I watched Will so often cobbling.

Will was famed for possessing the best singing birds, and the fattest of fat dogs. "What makes your dog so fat?" asked everybody. "Well, master, I fry the odd bits of leather, and he lives on them. There's nothing like leather," was the stereotyped answer, and this was all the information he ever vouchsafed on the subject.

Now, one day I became possessed of a young skylark; a femman, a grateful patient of my father's, brought it as a present to me (larks abound and superabound in the flat districts), and I nearly broke its beak in trying to feed it; so, in despair, I took it to old Will. "This is a sulky bird, Will, and won't feed." "Leave him with me, Master Harry, and I'll make him feed, and take the sulks out of him. You come and see him to-morrow morning."

To-morrow came, and I hastened to see my bird, and found him sitting on a perch in a blackbird's cage looking very lively, the cage on a chair close by old Will. "Now, Bob, show the young gentleman how nicely you can eat;" and presenting some food to him on a long spoon-shaped stick, to my surprise Bob ate it with greediness. Here was a lesson to show that even a bird does not like to be violently forced to eat.

My next pet was a goldfinch (a red-cap Will called it), whose leg the cat nearly pulled off, and which Will and I mended with split straws for splints, and cotton for bandages, to our great satisfaction, but not to golly's, for he at once unpicked the cotton, took off the splints, then nibbled off his leg, and hopped about on the other, carrying about his late limb in his bill with a triumphant air.

Next, with five shillings—oh! how rich I felt myself to be—I went into the canary trade. There was a knowing old lady, five miles distant, who was famous for green canaries, and old Will and I thought that a cock bird of her strain would be the very thing. So, at five o'clock one summer's morning, I mounted my pony and went off, bringing back, in a paper bag, a fine young cock, as I was assured it was. Having produced my purchase to friend Will, he whistled shrilly and said, "Master Harry, you are the young bird, *this* is the old one, for the old lady has cheated you!" Back I went full speed, "nursing my wrath to keep it warm;" but the wary dame beat me again, for, at the first word from me, she broke into sobs, and "Oh!

my dear old cock, to think that I should have sold you by mistake! Oh! dear, deary me." I returned with a young bird this time. "Two young 'uns," Will said. Poor old Will—soon after this he took to his bed and died. He did not live till the time when he prophesied "I should be too high for him." My good father doctored him for love, and I went to see him daily from the same motive; but love could not save him—he soon drooped, and disappeared. And the fat dog grew thin, and whined, and died; so that the legend about the leather diet was devoutly believed in.

Another acquaintance—I never admitted him to friendship—was asthmatical Tom Stacey, the birdcatcher. I did not much believe in his asthma, but thoroughly believed in his bad temper. As to the former, when my father said, "Well, Tom, how's your asthma?" "Lor, sir, very bad, sir," wheezed out Tom, in the lowest and huskiest of voices. "By the way, Tom," added the doctor, "can I have a nice canary for a crown, fit for a lady?" "Oh! yes sir," was the reply, in a much louder and clearer voice. "Good morning, Tom. Glad to hear you speak so well; not much asthma now," said the wily doctor.

Tom and I went out together bird-catching; took our cages for the decoys, our snap-trap cages on either side of them, our clap-nets, and, where the thistles grew abundantly, and were in bloom, we caught many a poor goldfinch. But I did not like Tom; he was rough with his birds, and had no love for them—he never kept a pet, as old Will did.

A few concluding words about "Humble Friends." If a father reads this, let him be assured that I, a father and a clergyman, let my boys do as I did. I am sure no harm comes of humble friends if they be grown men and women, especially if they are old. It is the poor *boy* that teaches, and loves to teach, blackguardism; the low company that injures is by companionship of many of the vulgar of a similar age to a boy.

Also let not Miss Augusta Canariensis, that tall maiden lady—Augustas are always of lofty stature—sneer at this paper as childish—every look back upon childhood makes one feel a child.

Further, and lastly, I give my word that the boy whose mind is taken up with his pets, has not time, if he is also well worked at school, to get into evil. Bar the mental and moral door with wholesome employment and recreation, then the devil cannot well get in.—WILTSHIRE RECTOR.

INDUCING BEES TO WORK IN SUPERS.

PLEASE tell me how to induce bees to work in a bell-glass on the top of a common straw hive.

Last April I put some glasses on the top of some common hives, covered the glasses with flannel caps, then put a small hive over them. The old hives were well stocked with bees. The hole at top was about 1½ inch diameter. Now and then a bee went into the glass, but nothing more. The whole of them swarmed in May as usual.—J. B.

[We believe that much depends upon a happy knack of hitting the right time at which to give bees access to a super. If the communication be opened too soon—*i.e.*, long before the stock-hive becomes inconveniently warm and crowded—scarcely a bee will enter, and they often seem ultimately to regard the empty apartment as one with which they have nothing whatever to do. If, on the other hand, giving additional room be too long delayed—*i.e.*, until royal cells are formed and tenanted—it is frequently impossible even to delay the issue of a swarm. When the right moment is happily selected the bees frequently take possession with a rush, and if swarming can be delayed or prevented, do not again quit until expelled by the apiarian. Nothing attracts them so readily into a super as finding it ready furnished with as much clear worker-comb as the bee-keeper can appropriate to the purpose. Failing, or in conjunction with, this, it is well to smear the inside with a little liquid honey.]

BEE-KEEPING IN OXFORDSHIRE.

ONE of your correspondents wants to know how to manage his bees so as to have as few swarms as possible? Last spring I wanted the same advice myself, as I had then two

strong stocks in common straw hives. In April I cut a hole in the top and put a six-inch glass on each live. At the beginning of May one stock commenced work in the glass, but before they filled it they swarmed, but kept on with the glass. When it was full I took it off and put on another the same size. This they filled in sixteen days, then I put on a third which was filled in eighteen days, so that I had from this one stock one swarm on the 27th of May and three glasses of honey (about 13 lbs.), and to-day (25th March), the old stock weighs 22 lbs. The other stock did not work in their glass, but threw three swarms, the first on the 27th of May, the second on the 7th, and the third on the 9th of June.

The two swarms that issued on the 27th of May came out both at the same time and settled together, so I put them into a large tub just to see how much they would get in a season if they had room. Well, to work they went quite peaceably, worked well for eight weeks, and then left off. There was only a bee to be seen now and then outside the tub. I waited a fortnight and then took them. They had collected 38 lbs. of honey and comb. There was comb 2 inches thick and 18 inches long, brood of all ages, and a young queen nearly full grown, but the tub was not half full.—R. N.

FOUL BROOD, AND WHAT HAS BEEN WRITTEN ABOUT IT.

IN compliance with the wishes of divers esteemed correspondents, I have much pleasure in fulfilling the promise given in page 118 of the last Volume of THE JOURNAL OF HORTICULTURE, and taking a brief review of what has been written by such English and foreign authors as I am acquainted with on the subject of foul brood.

In thus fulfilling the promise above referred to, I wish it to be understood that I entirely deprecate any revival of the discussion which has been recently concluded. My intention is fairly to quote *all* the authorities on the subject which have come under my notice, and if omissions be discovered, I shall be obliged to any one who will kindly supply what is wanting.

That eminently practical Scotch apiarian Bonner, who wrote in 1795, appears to have been the first British bee-keeper to notice this disease. He says, page 128—"Sometimes in spring I have found, in particular cells in hives, a considerable number of young that, from some cause or other, had decayed and never come to perfection. I have sometimes observed the number of bees so great that in one comb, containing perhaps six hundred young bees, the one-half would have been in this state in the cells. The effluvia proceeding from these abortive productions gave the hive a savour by no means agreeable to me, and which must, doubtless, have been very disgusting to the bees. I have often endeavoured to investigate the cause of these phenomena, but am as yet unable to satisfy myself, unless, perhaps, it be owing to extreme cold. But against this supposition the objection naturally arises, that some eggs in the same hive, and in the same degree of cold, produce bees which arrive at full maturity; and, therefore, in reply, it must be taken for granted that some eggs are naturally more able to bear cold than others; and, indeed, it is most commonly in hives that are but thinly inhabited that such misfortunes take place."

Huish writes in 1815 as follows:—"The abortive brood, although it cannot be classed as an epidemical disorder, is still of very injurious consequences to the bees. It arises from the two following causes:—First, when the bees have given the larvæ vicious food; and secondly, when the worm is placed in its cell with its tail towards the orifice. In this state the young bees, incapable of extricating themselves from their prison, die and putrefy." This whimsical idea of the young bees having "their heads where their tails should be," appears to be adopted from the Abbé della Rocca, who, as we are informed in a footnote, "speaks of an epidemical disease which, from 1777 to 1780, attacked all the hives in the island of Syros in the Archipelago, and was very nearly annihilating all the bees. He attributes it entirely to infested combs, or to the brood being placed in the cells in an inverted manner."

Next we have Dr. Bevan, who, in the second edition of "The Honey Bee," speaks of foul brood under the name of "pestilence, or *faux couvain*," by which latter name it appears to have been described by the celebrated Schirach, the first discoverer of that greatest of Nature's marvels, the power possessed by bees of raising a perfect queen or mother bee from a worker egg. Dr. Bevan discredits the hypothesis of the Abbé della Rocca and Huish, thinking the disease more likely to arise from a deficiency of *suitable* food; and relates a case which occurred in the apiary of the late Dr. Dunbar in the summer of 1835, which, it appears, was checked so far as to enable the bees to lay in an ample store of honey by means of partial excision, accompanied by the removal of the old queen, and the addition of an after-swarm. Dr. Bevan also (probably in this respect following Schirach), appears to consider the disease contagious, since he concludes his notice of it as follows:—"In all such cases it will be prudent, in order to prevent contagion, to have the infected combs burnt or buried."

Dr. Dunbar, writing in "The Naturalist's Library" five years after the occurrence of foul brood in his apiary, as related by Dr. Bevan, appears quite to have overlooked its existence, since he says—"After long experience and attentive observation, we are satisfied that this insect is subject only to one malady—viz., dysentery." Then tracing it to results, he says of the offensive smell:—"This last circumstance, no doubt, contributes to augment the evil, for the bees and brood inhaling only an unwholesome air must be *fatally* affected." Here I coincide with the suggestion of a valued correspondent, a personal friend of, and fellow workman with, the lamented writer, who believes that in this allusion to the brood "he passes from dysentery proper, and seeks to bring within its compass abortive or fatally-affected brood"—or foul brood, as it has more recently been named.

I am also indebted to the correspondent above referred to for the following extract from "Chambers' Information for the People," in which foul brood is thus described:—"There is still another distemper which sometimes makes its appearance among bees, for which the continental agriculturists administer Spanish wine, as in the former case. This is a kind of pestilence by which many of the insects are cut off. It happens when the queen bee has placed the eggs carelessly in the comb, so that the larvæ perish in the cells, or that they are killed by the cold, or otherwise when numbers die and infect the rest. The only attention requisite in this case is to remove the infected combs, perfume the hive with aromatic plants, and give them wine to sip, as already mentioned, in order to strengthen and restore them from their sickness."—Article "Honey Bee," page 655.

Having briefly recapitulated all that I can find related with regard to foul brood by British apian writers, whose crude ideas on the subject appear to have been mostly copied from the continental authors of the last century, I propose in a future paper to transcribe what the most reliable German and American apian writers of the present day have written about it.—A DEVONSHIRE BEE-KEEPER.

(To be continued.)

APIARIAN NOTES.

HONEYDEW.—Your correspondent "J. E. B." has made some observations on honeydew which are important. He mentions this sweet exudation being on beans, which is new to me. An apian in Oxfordshire, who has kept a number of hives for many years, stated to me that when wheat was going into blossom about the early part of June bees collected a good deal of honey from our bread plant. The bees referred to were close to a large field, which was every fourth year sown for wheat. I tried several times to verify the assertion by going into wheat fields in June, but never could see any bees busy on the blossom of the wheat. Probably some of your numerous correspondents may be able to throw some light on this.

FOUL BROOD.—I am glad that this controversy has nearly come to an end. I can say with our immortal bard, "He laughs at scars who never felt a wound." I have never suffered from this scourge, but I have a neighbour who keeps generally twenty stocks and has kept bees for many years.

Having asked him if he ever noticed foul brood, he said that he has suffered at various times from foul brood, but does not consider it an infectious disease, having constantly within a very short period hived swarms into the same hives which contained the foul brood after removing the combs, and in no instance has infection taken place. My neighbour is quite certain on this point, and I consider him one of the most intelligent bee-keepers in this parish. I may probably send a few observations of his to THE JOURNAL OF HORTICULTURE.

I conclude my observations with only saying, on this last tiresome subject, that I lean very much to the opinion of my brother apianists, Gelieu, Mr. Taylor, and other practical men, who say that they have not observed this scourge.—H. W. NEWMAN, *Hillside, Cheltenham.*

STOCKING AN OBSERVATORY-HIVE.

As I have very successfully used an observatory-hive (one constructed by my neighbour, the late Mr. Nutt,) of the same cruciform construction as "H. W. T.'s," a hint or two may be useful in reply to his queries. If one of these be placed in a circular or octagonal case, at least 6 inches greater in diameter than the glass frames, and 16 to 18 inches higher, so as to hold a large quantity of air external to the glass sides, he will, I think, have conquered the chief difficulty. If a swarm is used to stock it, it will require providing with guide-combs along all the four wings; but even these will be useless unless some of the cells contain honey.

Although this form of observatory-hive is unquestionably most ornamental, especially when neatly made, and constructed on the rotary principle, it is with equal certainty far inferior in practical utility to the "unicomb observatory-hive," such as exhibited by Mr. Woodbury in the International Exhibition, and described, with illustration, in THE JOURNAL OF HORTICULTURE, Vol. IV., page 160. In the cruciform-hives, even with the aid of guide-combs, it is a work of the utmost difficulty to prevent the new combs being made in two of the wings parallel to the other two, instead of at right angles to them, which, of course, quite prevents anything like "observation" at times; and the great difficulty in stocking them, with the much greater difficulty of "unstocking" again for winter preservation, induce me to very strongly recommend "H. W. T." to abandon the attempt, and to provide himself with one of the more serviceable "unicombs" referred to.—G. F. B., *Spalding.*

OUR LETTER BOX.

AUSTRALIAN BRONZE-WINGED GROUND DOVES (H. M.).—These have, I believe, bred in this country. They require to be kept in an aviary, and make their nest on the ground. I have not heard of their crossing with domestic Pigeons; and if they did the produce would certainly be a mule, as they are a different species to our tame Pigeons. Californian Quails are of the nature of Quails and Partridges, and have nothing to do with Pigeons. Their eggs may be set, and the young reared under Bantams.—B. P. B.

HATCHING TEMPERATURE (Nautilus).—From 100° to 105° of Fahrenheit's thermometer. We have not the book you mention.

ASCERTAINING THE FERTILITY OF EGGS (E. H. F. P.).—We know of no method of ascertaining whether eggs are fecundated save trying to hatch them. It is said the germ may be detected, but there is no certainty. In our opinion eggs are sealed hooks as to life and sex. The tedium of the process may be lessened by taking them from under the hen after five days and examining them from a dark place on a sunny day, closing the door (1) but a narrow space, taking the egg in the hand closed telescope fashion, holding it in a line with the sun, and looking through it. If the egg is fertile the first formation of the embryo chick will be distinctly seen—it appears as an irregular dark streak. If the egg is clear there will be nothing of the sort, nor would there be if the egg remained under the hen three months.

POULS' POLLS PECKED (R. B.).—The best thing we know for naked polls is to rub them with compound sulphur ointment. It is a strange taste, but it is not less true, that cocks will call the hens and stand still while their heads, faces, and polls are eaten by the ladies of their harem. It is the only instance we know of voluntary submission to being hen-pecked.

CHICKENS PECKING THEIR FEET (Ruswick).—The chickens would only peck their legs because they trod in something that adhered to them, and was either palatable to eat or made them itch. It is not natural for them to do it.

HEAT FOR EGG-HATCHING (G. H.).—We cannot tell you "the maximum and minimum heat at which an egg hatches;" but you will see by an answer to another correspondent the requisite temperature.

CHINESE RABBITS (Gardenia).—We are not aware that the skins of these Rabbits are at present of the value you mention. Mr. Baily deals largely in these Rabbits, and would doubtless buy them.

WEEKLY CALENDAR.

Day of M ^o nth	Day of Week.	APRIL 12—13, 1864.	Average Temperature near London.			Rain in last 37 years.	Sun Rises.	Sun Sets.	Moon Rises.	Moon Sets.	Moon's Age.	Clock before Sun.	Day of Year.
			Day.	Night.	Mean.	Days.	m. h.	m. h.	m. h.	m. h.	m. s.		
12	TU	Common Laurel flowers.	55.4	36.7	46.0	24	12 af 5	49 af 6	13 9	25 0	6	m. s. 0 42	103
13	W	Ash flowers.	55.2	33.7	44.4	15	10 5	51 6	12 10	5 1	7	0 26	104
14	TH	Lime and Sycamore flower.	56.9	36.7	46.8	14	8 5	53 6	13 11	39 1	9	0 11	105
15	F	Easter term begins.	57.6	37.7	47.6	19	6 5	54 6	after.	8 2	9	after.	106
16	S	Cherry flowers.	56.9	36.4	46.6	16	3 5	56 6	21 1	31 2	10	0 19	107
17	SUN	3 SUNDAY AFTER EASTER.	57.2	35.8	46.5	14	1 5	58 6	25 2	53 2	11	0 33	108
18	M	Black Currant flowers.	58.2	35.8	47.0	15	59 4	0 7	30 3	14 3	12	0 47	109

From observations taken near London during the last thirty-seven years, the average day temperature of the week is 56.8°, and its night temperature 36.1°. The greatest heat was 73°, on the 14th, 1852; and the lowest cold, 20°, on the 15th, 1862; and 16th, 1847. The greatest fall of rain was 0.63 inch.

EVERGREENS AND VILLA FRONT GARDENS.

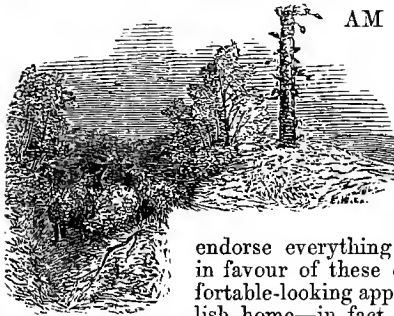

AM glad to see that Mr. Dawson, at page 249, has taken up the subject of evergreens as the most suitable ornaments for villa gardens; and I can fully

endorse everything he has advanced in favour of these cheerful and comfortable-looking appendages to an English home—in fact I expect, after we

having exhausted all our ingenuity in improving and producing bedding plants by the million, we shall eventually sober down into the calm reflection that, after all, there is nothing like evergreens for general and continuous effect. Even among evergreens there is diversity of colour already, and possibly a few years hence will give us additional tints of colours now wanting; so that if we cannot look out on a bed of Golden Chain Geranium in February, we may have Hollies equally fine to look upon at that time, and reds may be forthcoming. The purposes that evergreens generally so called may be put to are far from being fully developed, but will become so as suitable plants make their appearance.

At the present time, let us fancy a bed of *Skimmia japonica* growing by the side of another of similar proportions of Gold-edged Holly, and the common tree Box makes, in like manner, a very suitable bed, though not more so than *Thuja aurea*. For a deep dark green I know of nothing better than *Cotoneaster microphylla*; and the Holly-leaved Berberry with its bronze-coloured foliage gives a fine contrast in winter. I expect that *Pernettya mucronata* will, in a few years, become a general favourite, from its violet-coloured berries, in winter; and a plant which I have not seen noticed generally furnishes a colour we do not otherwise possess—*Retinospora ericoides*, which, in winter, assumes a sort of reddish chocolate colour, contrasting well with most other shrubs, more especially with the pale green foliage of *Griselinia littoralis*, a shrub not so common as it ought to be—its densely clothed stems, bushy and compact habit, and the fact of its being easily cut into shape, entitles it to a place in most collections. Then we have *Majorea Box*, another useful shrub of a like stamp; while on some soils the *Rhododendron* may be grown to great advantage; and for a few years several of the Cedars, Cypresses, and Junipers may be introduced with advantage. Most of the *Coniferæ* while in a young state are ornamental objects; but I would not by any means recommend them to be planted too extensively in a mixed border, as a time may come when they must be sacrificed, otherwise the object they were planted for will be defeated; and there are often painful regrets at

having to destroy a fine *Deodar* growing where it ought not to have been planted. Common *Virginian Cedars*, *Arbor Vitæ*, and some *Junipers*, as well as *Yews*, may be planted in the shrubbery, as no one cares about sacrificing them, and they serve a useful purpose in the mean time. But the more choice kinds of *Pinus* ought not to be planted in such a position; for nothing looks worse in the eyes of those who look beyond the present moment than, for instance, a *Wellingtonia* planted within a yard of a sitting-room window, which I have on more than one occasion done, and perhaps a *Cedar of Lebanon* as short a distance from the edge of a permanent roadway. A *Bay*, *Box*, or *Aucuba* in such a position conveys no unpleasant feelings, as the knife may be used to keep them in bounds, but with the others its use is improper.

As my purpose is merely to write a sort of appendix to Mr. Dawson's article, I will not repeat the shrubs he mentions, but simply urge on all who have the management of villa fronts to well consider what he says in behalf of evergreen as contrasted with deciduous trees. The boundary fence he speaks of, being of wire or iron, quickly becomes invisible, and a cheerful belt of evergreens, having the strongest-growing ones in the centre, and back to back, separate villa No. 1 from villa No. 2, and so on. The more choice shrubs being in front, with a space for a few herbaceous plants, a cheerful appearance is at all times presented, even in midwinter, and the freshly-dug border looks well. In February and March *Snowdrops* and *Crocuses* will have enlivened the plot, and possibly the *Winter Aconite* and *Christmas Rose* may have done so before; while the whole batch of spring-flowering plants follow each other quickly after the *Crocus* is over. Even if there be none of them the turf and evergreens look well at all times, and always give a clothed appearance to the plot. If, on the contrary, deciduous trees be cultivated, the half-naked condition of the turf underneath, especially in winter, presents a miserable aspect, with which the healthy green of the open sward and the glossy hue of the evergreens stand out in strong contrast. There are, however, perhaps some few positions where deciduous trees may be countenanced, and these are where evergreens have but a poor chance to do well—that is, in the midst of the smoke and dust of a large town. When too much enveloped in smoke and dust, evergreens look dirty and bad; and although deciduous trees quickly do so likewise, still, as a fresh leaf has to be formed each spring, for a short time at least that leaf is fresh, and is appreciated accordingly. In the suburbs of towns, where there is less smoke, and consequently a better chance of shrubs doing well, the advantage, as above stated, is entirely on the side of evergreens.

To those who may be anxious to lay out their villa fronts without consulting professional men, I would say, Avoid a high brick wall between your garden and that of your neighbours. A straight central path to a front door, with parallel brick walls a few feet from it bounding the whole, gives more the character of yard than a garden. When space will allow, it is better in many cases to form

a sort of curved walk to the front door, taking care to avoid abrupt turnings; for this reason the outer gate need not necessarily be in a line with the front door, and if at or near one corner of the plot so much the better. In forming a curve between two objects which are visible from each other, a reason must be apparent for doing so; a tree, a shrub, a single plant, or some other object ought to project, so as to give a just reason for departing from the straight line. This, however, is often an advantage in a villa front, as it may be made the means of hiding the front door from the gaze of those in the street or highway, and if the curve is easy and agreeable, it will look better than a straight walk. If the plot be small, there will not be room for any flower-beds, perhaps, between the walk and the boundary of shrubs, but a good frontage of the latter may be made available for the growth of flowers; and if the intervening portion of grass have a few specimen plants, as Irish Yews, Yuccas, and perhaps an *Araucaria* scattered thinly and unevenly over its surface, it will do without beds, and on the whole be made to look well all the year.

There is one other mode of making a villa front of limited dimensions not only interesting, but highly attractive; and that is by covering the whole of the central path with glass, making, in fact, a sort of span-roofed house the whole way from the entrance-gate to the front door. In this case a straight pathway is advisable. This covered way need not, however, be heated; neither is it necessary to have glass at the sides, if objectionable, as a plain brick wall with a glass roof will afford all that is wanted by a host of the finest plants we possess, including *Camellias*, several New Holland plants, many creepers, &c. To the invalid such a promenade will be invaluable in bad weather; and as the cheapness of glass affords such facilities for the erection of structures of this kind, I hope to hear of examples of them being constructed ere long. Be it remembered, also, that many plants will do well under glass in situations where they will not thrive out of doors, the artificial assistance they receive counterbalancing, in a great measure, the impurities of the atmosphere and other drawbacks. Entrance porches of this kind might, therefore, become excellent situations for many highly-ornamental plants, and might be diversified in many ways. For instance: assuming the passage to be a long one, if there be space at command right or left of the central avenue, a sort of cavern might be formed of a side chamber, in which Ferns might be grown, as many handsome species require merely shelter. Such a recess would require but little light, and it might be made a very interesting feature. The central line might, in addition to *Camellias*, contain some of the best specimens of *Rhododendrons*, and many of the *Acacias* will be found to do well in such a place; and, assuming the front door to face this floral avenue, nothing could look better from it when thrown open. I may add that there is no necessity for the end nearest the highway being in a direct line with the rest of the avenue, as that might invite the rude gaze of the multitude; but it is easy to effect some central screen or turning, so as to stop idle curiosity. Even if the outer door did open in a line with the centre of this avenue, there might be an upright boarded screen near it, while such screen, on the other side, might be ornamented in any manner that might be thought advisable, or might be a mirror, if such were thought proper. Once let ingenuity be exercised on the matter, and the means of making the most of such a feature will quickly present itself; and, as gardening at the present day has assumed a higher position than it ever did before, it is not likely its votaries will be deficient in the necessary inventive power.

The above notes were merely intended to give a rough idea, capable of being extended and improved, of what might be done in the covered avenue way; while in the matter of evergreens, as forming agreeable features in villa fronts, I can but simply echo Mr. Dawson's views; and assuredly plants which do good service from the 1st of January to the last of December, are deserving of a higher position in the scale of ornamental worthiness than those which merely present a gay appearance some two or three months at most. That the public will no doubt be brought to do full justice to the most deserving there is no doubt. In the meantime, therefore, it behoves all those who cater for the public taste to be prepared with novelties in the

way of evergreens; for they may rest assured that, whether such plants produce berries of an ornamental character, or in some way present us with tints we have not hitherto possessed, the plants will be eagerly accepted, if such merits be of a lasting kind. This much I urge and ask for as regards evergreens; and, with respect to the covered porch or villa entrance, I have no doubt that the idea will be taken up by some one. Be this as it may, the idea is well worthy of the attention of practical men. J. ROBSON.

THORNS, USEFUL AND ORNAMENTAL.

(Concluded from page 255.)

2ND, THORNS AS DECORATIVE PLANTS.—For ornamental purposes Thorns are mostly budded or grafted on the common kind, and as near the soil as possible. Some work at 6 feet to obtain standards; but such trees are not half so good as those budded or grafted near the soil. No Thorn makes so fine a tree on other roots as on its own; but it is scarcely possible to propagate some kinds without a stock. Such species as produce haws are best raised from seed; for seedlings make handsome trees, and are more free in growth. The Cocks spur Thorn (*Cratægus crus-galli*), makes a good stock and the Black Hungarian (*C. nigra*), with the Heart-leaved American (*C. cordata*), are vigorous growers, and so make stocks. For general purposes, however, none is better than the common Hawthorn (*C. oxyacantha*). Budding is performed in the beginning of July, and grafting in the beginning of March, whip grafting being preferable. It is a good practice to graft them close to the root, and to cover the grafted part, or the union of the scion with the stock, with earth, in addition to the usual clay coating, as the soil keeps the parts moist, and thus promotes a more rapid flow of the sap.

Seedling Thorns intended for stocks should be clean and strong, three-year plants being the best. They should be planted in autumn in well-trenched ground, cutting the roots back about half their length, and trimming off all the side branches of the head, leaving nothing but the bare stem with its leader untouched. The operator will decide whether he will train the stock up to a certain height and bud it there, and if so, he will be studious to preserve the leader; or if it be determined to bud or graft near the ground, he will cut back the head and retain some of the side shoots to draw the sap past the graft or bud, which is to be inserted in the July following if a bud, or in the March of the second year if a graft. The stock may be grafted at 6 or more feet from the ground and the head formed at once or common Thorns growing in pleasure grounds or parks may be grafted, and a variety will thus be obtained with but little trouble and expense.

Grafted or budded plants should be trained with a single stem until the required height is attained, when they must be topped, and all the side shoots and buds except five at the top removed. The top should not be taken off until the autumn, and if the leader be a few inches longer than the required height it will shoot more freely in the spring. When the eyes break remove two of the weakest shoots, and let the others grow at freedom until July, when the leader is to be stopped back to six leaves, and the side branches the same. They will shoot again and need no further pruning beyond cutting out all rampant shoots to strengthen those which are weak, and removing such as interlace or overlap each other, so as to form an even-headed tree, for nothing is so ugly as a standard tree with all the branches on one side. In the autumn following (after the head is formed), they may be planted where they are to remain; but it is preferable to transplant them into lines 4 feet apart, cutting back the thick roots a little to induce the fibres to be formed nearer the stem. Here they may remain twelve months, when they will remove more freely, or they may be allowed to grow another season, when they will have a much finer head and look more effective on the lawn.

Planted singly on lawns they are very effective, not only when in blossom, but their peculiar foliage and habit are attractive at any season, and their fruit render them picturesque objects when even the garden has a dull, sombre appearance. Planted singly or in groups in parks they are

highly ornamental, and in woodland scenery and by rural walks they are delightful. Thorns do best on rich and rather stiff loams, but do moderately well in almost all soils and situations. In the smoky impure atmosphere of large towns they thrive better than most trees of moderate growth, they, with Limes and Elms, being almost the only trees that do any good.

Thorns make handsome pot plants, either for forcing or as dwarf bushes and pyramids for small gardens. Maiden plants one year from the graft are selected for potting. The roots are pruned so that they can be easily potted in 12-inch pots. These should be well drained and filled with a compost of one-half turfy loam from a rich pasture, and one-half leaf mould and cowdung, well rotted. After potting, the pots are plunged in coal ashes in a sunny but exposed situation. In spring, for the potting must be done in the autumn, the top is taken off at the height of 1 foot and copious waterings given in dry weather. When the shoots have made six leaves they are stopped to that number, but the leader is allowed to grow a foot before it is stopped, by which time the side shoots will be pushing again, when stopping the leader will throw increased vigour into the side shoots, which must not, however, be stopped again the same season. In August see that the roots are not pushing through the hole of the pot into the soil; if they are, cut them close off to the pot. Replunge, and water moderately when the plants need it until the last week in September, when no more water must be given; then lift the pots out of the ashes to make sure of the plants not rooting through into the soil beneath. When the leaves begin to fall, provide some strong rich soil and cowdung one year old, and with a compost of equal parts of each top-dress the plants. Shake out the old soil all round to at least 3 inches from the side of the pot, leaving the centre undisturbed, and not less than 6 inches in depth. Be careful not to injure any root the thickness of a straw, and no more of the small fibres than is done in taking away the soil. Refill the pot with the prepared compost, and ram or press it very firmly. Plunge the pots overhead in ashes to protect the roots from frost, and prevent its mouldering the pots. In spring raise the pots so that the rim may be a few inches above the surface, and any shoots that are straggling in growth may be cut back.

If all go well, at the commencement of the second season the plants will be nice bushes, or rather cones of from 1 foot to 1 foot 6 inches through at the bottom, and 2 feet in height, with the shoots about 6 inches apart. If closer than this they must be thinned, and the plants liberally supplied with water. When growth commences and the shoots have made four leaves stop the side shoots to that number, letting the leader make eight leaves before it is stopped. Stop the side branches at the second leaf when they shoot again, and the leader the same, and if they offer to grow again stop them at every leaf. This, with the precaution not to let the plants root through into the soil, will tend to further the formation of large leaves on short, stunted growths, and these give flower-buds. Towards autumn reduce the supply of water, and so adopt the plan most likely to secure the ripening of the wood, on which depends the well-flowering of the plants. If these are well set with buds, and it is contemplated to force them early, they must not be top-dressed, but if larger plants are desired, or if not likely to flower, they must be top-dressed the same as the year before. Some plants will flower at two years old, but others require to be three years old before they are furnished with flower-buds.

Bushes are formed in a similar manner, only there is no leader, consequently their upper shoots are allowed less lead than in the case of forming a cone or pyramid; but the remarks as to stopping and top-dressing apply equally to both forms.

The plants, for we can hardly call them trees, should be allowed six weeks rest at the least before forcing, but three months is not too much. They will flower all the stronger if allowed a long rest, and the less they are excited the finer is the blossom. A temperature of 40° for the first fortnight is quite high enough; afterwards they may be introduced into a house with a minimum of 45°, with a rise of 10° or even 20° with sun and abundance of air. The temperature may be further increased to 50° by night, in which heat

they will expand their flowers. They will require syringing morning and evening from the time of their being introduced into the forcing-house till the flowers open, and watering copiously with water of the same temperature as that of the house. The flowers will retain their beauty longer in a rather cool and dry atmosphere than in the moist warmth of the forcing-house. It usually takes about nine weeks to have them in flower from the time of introducing them into the house, less or more according to the heat and the season. Plants after forcing must be allowed a season of rest; therefore, two sets of plants must be provided.

The sorts best adapted for forcing are *Cratægus oxyacantha rosea* (Rose-flowered), *C. oxyacantha punicea* (Scarlet), *C. oxyacantha rosea flore pleno*, *C. oxyacantha flore pleno*, and *C. oxyacantha rubra splendens flore pleno* (Double Scarlet).

Most of the following are very effective on stems of sufficient height to allow of the grass under them being mown, or as dwarfs in plantations. They may also be cut so as to form dwarf bushes on lawns or any figure desired. They must have a free access of sun and air to the stem if they are expected to flower.

- | | |
|---|---|
| <i>Cratægus apiifolia</i> (Parsley-leaved). N. America. | <i>Cratægus oxyacantha leucocarpa</i> (White-flowered). Britain. |
| <i>C. Aronia</i> . S. Europe. | <i>C. oxyacantha aurantiaca</i> (Orange-fruited). Ayrshire. |
| * <i>C. azarolus</i> (Azarole). S. Europe. | <i>C. crus-galli</i> (Cockspur). North America. |
| <i>C. Douglasii</i> (Small purple-fruited). | <i>C. crus-galli splendens</i> (Shining-leaved). North America. |
| * <i>C. flava</i> (Yellow pear-shaped fruit). C. marocana. Morocco. | <i>C. crus-galli sulcifolia</i> (Willow-leaved). North America. |
| <i>C. nigra</i> (Round black fruit). Hungary. | <i>C. crus-galli linearis</i> (Linear-leaved). North America. |
| * <i>C. odoratissima</i> (Sweet-scented). Crimea. | <i>C. crus-galli pyracanthifolia</i> (Pyracantha-leaved). N. America. |
| <i>C. orientalis</i> (Eastern). S. Europe. | <i>C. crus-galli nana</i> (Dwarf, 4 ft. in height). North America. |
| * <i>C. tanacetifolia</i> (Tansy-leaved). Greece. | (The above attain 15 ft. in height, except <i>C. crus-galli</i> , which attains 30 ft.) |
| <i>C. oxyacantha</i> (Hawthorn). | * <i>C. coccinea</i> (Large scarlet-fruited). C. coccinea corallina. France. |
| <i>C. oxyacantha rosea</i> (Rose-flowered). | <i>C. coccinea indentata</i> (Indented-leaved). France. |
| <i>C. oxyacantha laciniata</i> (Cut-leaved). Sicily. | <i>C. coccinea neapolitana</i> (Evergreen Neapolitan). Naples. |
| <i>C. oxyacantha eriocarpa</i> (Woolly-fruited). Britain. | <i>C. coccinea maxima</i> (Largest-leaved and fruited). S. Europe. |
| <i>C. oxyacantha aurea</i> (Golden-fruited). Hybrid. | <i>C. glandulosa</i> (Glandular). North America. |
| <i>C. oxyacantha multiplex</i> (Double-white). Britain. | <i>C. glandulosa succulenta</i> (Succulent-fruited). Germany. |
| <i>C. oxyacantha punicea</i> (Scarlet-flowered). Britain. | <i>C. glandulosa minor</i> (Small-fruited). North America. |
| <i>C. oxyacantha punicea plena</i> (Double-scarlet). Britain. | (<i>C. coccinea</i> and varieties have large flowers and fruit; the plants are tree and vigorous growers, attaining 20 ft. in height.) |
| <i>C. oxyacantha pendula</i> (Drooping). Britain. | <i>C. orientalis sanguinea</i> (Blood-coloured fruit). Crimea. |
| <i>C. oxyacantha regina</i> (Queen Mary's Thorn). Scotland. | <i>C. parvifolia</i> (Small-leaved). 6 ft. North America. |
| <i>C. oxyacantha fol. aureis</i> (Yellow-variegated). Scotland. | * <i>C. parvifolia grossularifolia</i> (Gooseberry-leaved). |
| <i>C. oxyacantha fol. argenteis</i> (White-variegated). Scotland. | <i>C. pyracantha</i> (Evergreen Thorn). S. Europe. |
| <i>C. oxyacantha præcox</i> (Early-flowering Glastonbury). Scotland. | <i>C. pyracantha crenulata</i> . S. Europe. |
| <i>C. oxyacantha laciniata pendula</i> (Drooping cut-leaved). Scotland. | <i>C. pyracantha crenulata fructu albo</i> . S. Europe. |
| <i>C. oxyacantha pendula fol. variegatis</i> (Variegated-drooping). | |
| <i>C. oxyacantha</i> (Upright). Britain. | |
| <i>C. oxyacantha lucida</i> (Shining-leaved). Britain. | |
| <i>C. oxyacantha melanocarpa</i> (Black-fruited). Tauria. | |

Those with an asterisk prefixed produce fruit moderately well-flavoured. *C. azarolus*, *tanacetifolia*, and *odoratissima*, have fruit the size of Cherries. The trees bear well as standards, but are only worthy of a place in the orchard on the score of curiosity.

The last three are highly ornamental plants for covering rockeries and walls. They grow 10 feet high, have white flowers in May or June, which are followed by numerous coral-coloured fruit, very bright indeed, contrasting well with the dark green foliage. The white-fruited variety is also very handsome.—G. ABBEY.

DEATH OF MR. JOSEPH KIRKE.—The name of Mr. Joseph Kirke has now almost passed away from the remembrance of the gardening community of the present day, except as his name is associated with some fruits to which he applied it—as Kirke's Admirable, Kirke's Lord Nelson, Kirke's Golden Pippin Apples, and Kirke's Plum, &c. But there are still some who knew him personally, and to whom it may be interesting to know that he died on the 26th ult.

full of years, having attained the great age of ninety-six. Mr. Kirke succeeded his father as a nurseryman at Brompton, where they occupied six or eight acres of ground devoted entirely to the cultivation of fruit trees. From this he retired about eighteen years ago, and became an inmate of Huggins' College at Northfleet until the time of his death. The ground he occupied now forms part of that on which the Exhibition building of 1862 stands. In the early days of the Horticultural Society Mr. Kirke was a great supporter of that institution, and rendered its meetings interesting by the large collections of Apples he was in the habit of exhibiting.

SPRING TREATMENT OF SCARLET GERANIUMS.

MR. THOMSON'S directions for Geranium cuttings in your Journal of August 4, 1863, page 81, are so clear and concise that I am sure many as well as myself would be extremely glad if he would continue his detail, and direct us as to the treatment of the cuttings during the spring. He mentions that they are wintered in pots, and "shaken out" in spring. I should be very glad if he would give more particulars as to whether they are potted off, and in what month? and if so, how they are treated—whether put in heat, &c., till they reach their final destination in the beds? Also, when bedding them out from pots, whether the balls should be left round them, or the roots shaken clean out?

Is it too late to make cuttings now of the Golden Chain and Variegated Geraniums?—A LADY GARDENER.

[The above inquiries afford another instance of the fact that it is not possible to write about any gardening question, however simple and well known to many, which may not be interesting and instructive to some one. There are many ways in which autumn-struck Geraniums are treated in spring previous to their being planted out. The way which I practise now I find to produce young plants that suffer very little or no check when planted out, and which are mostly studded with flower-trusses both in bloom and bud, and, consequently, make comparatively gay beds as soon as planted.

About the middle of February the common Scarlets are shaken out of their cutting-pots and boxes, and potted into pots 3 $\frac{1}{4}$ inches wide, or what are known about London as small 48's. The soil in which they are potted is made up of about equal parts loam and leaf mould, not quite so much leaf mould as loam; three barrowfuls of the former to four of the latter, with a sprinkling of sand, make an excellent compost for this purpose. In potting them the soil is pressed firmly into the pot. When potted they are placed on the floors and trellises of Peach-houses, where they get no more fire heat than is necessary to keep the temperature from falling below 35° in time of frost. They are exposed to as much light as can possibly be admitted to them through a very light structure. For a few days after they are potted there is no front air put on, but a full supply from top ventilation. In this position they are kept in a moderately moist condition at the root. Over-watering at first must be avoided. Up to planting-out time they receive no further attention than that of watering and pinching the terminal buds out of any of them that are inclined to run up without branching out nicely. I stand fifteen thousand of these in one house all winter in their cutting-pots, and when potted off in February the same house receives eight thousand of the Green-leaved and Zonale sections. The variegated sorts are potted at the same time, but placed in heat in vineries and Peach-houses to give them a start. They are more tender than the others, and to make fine plants of autumn cuttings it is necessary to give them a start in heat. As soon as they have grown pretty freely in heat they are turned into colder places, but still kept under glass till planting-out time. We begin to plant here in the second week of May, and not later than the 15th. By this time almost every plant has a truss of flower in fine hardy condition, which is the most practical refutation of the croaking about there being no bloom in our modern flower gardens till July. Our Geranium-beds were really gay last June from plants managed in the simple way described. I like to keep those young Geraniums in their pots till planted out in preference to turning them out of their pots into

beds of soil. In the latter case I have always found plenty of strong flabby foliage at planting-time, but very few bloom-buds or flowers as compared with those kept in pots.

"A LADY GARDENER" will learn from the foregoing that it is not necessary to put the hardier sorts into heat when potted, particularly if the cuttings are large and stubby when put in in August, as directed in the paper to which she refers. The variegated varieties are much the better of a little warmth for three weeks or a month after being potted. If "A LADY GARDENER" cannot command any more heat than is afforded by a greenhouse, she should place them in the warmest part of the house. If the soil is nicely moist when they are potted they should not be watered for a week after they are potted, and when watered the foliage should be wetted as little as possible; and it would also be well when no extra warmth can be afforded them not to pot-off till March.

When planted the ball is kept entire, and the soil is firmly pressed around it. Care should be taken that the ball is in a medium state as to moisture when it is placed in the ground; for if mealy dry it takes a deal of water to moisten it when out of the pot, and the plants receive a check before they take hold of the border.

One of the chief points to insure success is to see that the plants are well exposed to light and air before they are planted. If turned out from some shady corner where they have had but little sun and air, they are sure to lose all their large leaves, and will be late in recovering the shock they receive from bright sun and winds.

It is not yet too late to put in cuttings of Golden Chain and other variegated sorts. They will make nice plants if put in immediately, and pushed along for fourteen days after they are rooted and potted off. In making cuttings of these avoid the lilliputian-system. Large cuttings root far more quickly, and, of course, make better plants than the mere tips of shoots that are so often put in.—D. THOMSON.]

THINNING THE BLOSSOMS OF PEACH TREES.

IN the Number of your Journal dated March 29th, in the article "Doings of the Last Week," after directing the blossoms of the Peach tree to be thinned out, the writer adds, "We have found this thinning of flowers not only easier than thinning fruit, but also one of the best means of securing fruit to thin." Now, as I have not before met with directions to thin the flowers on fruit trees, I, and I am sure many of your readers, and especially amateur gardeners like myself, would feel much obliged by having more precise directions on the mode of and proper time for thinning. The direction generally given is not to begin thinning till the fruit is fully set. I have just thinned the flowers, which were very thick, on several of my Peach trees; but I did so with some misgivings, and I shall feel greatly obliged by having my doubts on this subject cleared up.—AN AMATEUR.

[In general the mere setting of the fruit does not require much of the vital energies of the plant, and therefore the mere thinning of the blossoms is a matter of less consequence if the fruit is thinned sufficiently early afterwards. The advice to thin the blossoms as given in the "Doings of the Last Week" to which you refer, was based on two facts. The first is, that in the multiplicity of matters needing attention the young fruit, when set very thickly, are apt to remain too long unthinned, and therefore so much is taken from the fruit ultimately left, whilst there is more trouble in taking off the fruit than removing a lot of the blossoms. The second fact is, that when the wood is not thoroughly ripened, or the top of the tree has been excited into action before there was much action at the roots, there may be a fine show of blossom on the shoots, and yet very few of these set and swell kindly, because there was such a diminished reciprocal action between roots and branches—in other words, there might be plenty of aroused power to set the fruit of from four to six blossoms on a shoot when there would not be power to set the fruit of two or three dozens of blossoms; and then the natural-selection principle might so far fail, that in attempting to set and swell all the lot there might be none set at all. This is chiefly likely to happen with old trees, with tender kinds of Peaches, and with trees against walls where the blossom is expanded

by sun heat when there is hardly any root-action. The throwing off the buds and blossoms prematurely, so far as our observation extends, is owing to too great dryness at the roots, too much moisture at the roots, too much moisture at one time, especially if the liquid is warm enough to excite vigorous action or cold enough to retard it, unripened wood, the want of reciprocal action between roots and branches, and giving the plant suddenly too much to do.

The Noblesse Peach trees I referred to were old trees. It was supposed that the roots were deep and the soil rather wet. The blossom every season was magnificent—quite a picture, but year after year there was little fruit, the blooms falling without setting. The thinning of the blooms was tried—fully two-thirds were removed. The most prominent blooms were left, those more on the sides and back of the shoot removed, and year after year there was a plentiful crop. I recollect more than twenty years ago meeting with a gentleman at the nursery of Messrs. Osborne at Fulham, and, the subject accidentally coming up, he told me he regularly thinned all the blooms of his Peach trees in-doors, and never had a failure. Before he did so whole trees used to drop their blooms without setting. I have no reason to believe that the advice in the "Doings" contained anything novel, though it may not have come previously under our correspondent's notice. I have counted the bloom-buds on some shoots that in the length of a single foot contained from twenty-four to thirty blooms, and on short stubby shoots in pots the blooms were much thicker. The blooms on such shoots are not by any means all equally well placed. Those on the fronts of the shoots are generally the best, and the fruit there will have the best position for light, &c. On looking over such blooms, and allowing the largest and best-placed with the most prominent pistils and anthers to remain, the half or even two-thirds might be removed, and still fruit enough be left to thin. It would be well to err on the safe side at first, and not take too many blooms away. Of course, when the blooms are thin on the shoots no thinning must be resorted to. I believe that many of our shy-setting Cherries and other fruits would be benefited by such a thinning if we could assist them, instead of allowing Nature to make the selection herself. I am much obliged to "AMATEUR" for his inquiry, and unless he overdo the thing I have no fear of a moderate thinning. Old trees, and young trees with unripened wood, often throw lots of imperfect blossoms, and therefore he should make sure that the stigma of the pistil is bold and prominent in the flowers he leaves. Such stigma and pistil always have the miniature fruit (the germen) at the base. After a dull wet autumn it is not uncommon to meet with flowers that are destitute of these parts of fructification, and, of course, they never can set fruit. In thinning, therefore, the eye must be used.—R. F.]

STAGE FOR A GREENHOUSE.

A CORRESPONDENT, whose case doubtless resembles that of many others, writes as follows:—

"A Lady wishes to know the best way of having a greenhouse-stand made. The order is given to a country carpenter who is inexperienced and requires instructions. The greenhouse is a lean-to nearly fronting the south—length 16 feet, width 12 feet, height in front, 5 feet 10 inches, ditto at back, 11 feet 5 inches, width of front shelf, 2 feet 2 inches, height from floor, 2 feet 7 inches; and it is proposed to have a three-foot path next this shelf, which leaves about 7 feet for the stand. What height should it be? to consist of how many shelves, and the width of each, and how far from the floor should the first shelf be?"

"At the west end next the wall is a door leading to other houses, therefore the path must continue to this door."

As the case is stated so clearly there can be no difficulty in giving a reply, only one or two exceptions must be made to the advice we give, and that is we are not certain what description of plants the house is intended for, but presume it to be for a mixed collection of greenhouse plants of all sizes. Under this impression we would say, Let the first shelf of the proposed stage be the same height as the front shelf, which is 2 feet 7 inches, and let it be 10 inches wide. The next shelf might have a rise of 6 inches, and be the

same in width; and the third shelf the same both in width and rise. The fourth shelf might be 12 inches wide, with the same rise of 6 inches, so that there will be four shelves with three rises, occupying a horizontal space of 3 feet 6 inches, which, taken from the 7 feet allowed for stage, leave 3 feet 6 inches for a top platform, which ought to rise 6 inches above the last shelf. The advantage of a good broad top platform is to place large plants—as Azaleas, Camellias, Cytisus, &c., on, as well as other plants of a like character; or even when smaller plants have to be arranged thereon, the tallest being placed at the back, will sufficiently overtop those in front of them. For instance: plants of *Salvia* in autumn and winter become pretty tall, as likewise do many *Chrysanthemums*; and the house not being a lofty one, we should prefer the arrangement here given, unless the house be exclusively intended for small plants, like a stock-house in a nursery, in which case the shelves might be narrower and more of them; but for a private grower, when plants of various sizes are grown, the above will, in a general way, be found better, more especially as we expect creepers may be grown against the rafters, and the other features of an ordinary greenhouse carried out.

With respect to the door being at one end and against the back wall, it is easy to return the stage at the ends, and, if necessary, you could return the front shelf also. If you had not previously arranged your front shelf we would have advised it to be only 2 feet instead of 2 feet 7 inches high. Most plants are seen to more advantage under the eye than on a level with it; but many stages are quite as high as the shelf you have made. If the space underneath the stage be unsightly it may be shut-out from view in a great measure by wooden latticework, or now and then a trailing plant hanging over it will do much to hide it from view; but in many cases such places are turned to account in winter for preserving roots of *Dahlia*s, *Salvia* patens, *Fuchsia*s, and other plants, as every place under cover is put in requisition at that time.

If "A Lady" who now asks our advice does not contemplate growing many large plants she can add another shelf, say 12 inches wide, and still have some 2 feet 4 inches for the top platform. This, however, must depend on what she proposes to grow. In general we do not like a stage to rise uniformly up to a narrow shelf at top unless it be for small plants alone; and where there are various-sized plants grown it is easy in placing them to arrange the tallest at the back so as to show a good face: whereas if the stage be carried up to an apex the tall plants will appear overtopping the shorter ones and look unpleasingly.

POSITION OF FLOW AND RETURN PIPES.

I HAVE a flow and return pipe putting up for my small hothouse. They are to be one above the other extending the whole length. Both pipes are about a yard above the boiler at the point of starting. Now, when the flow-pipe has attained the height of one yard above the boiler, I presume it may traverse the length of the hothouse on the level, or at least with the slightest possible rise (say 2 inches in 8 or 9 yards), then return underneath, and at last dip perpendicularly to the bottom of the boiler. The party erecting it says there must be a rise of at least 5 inches in the 8 or 9 yards. I wanted to have the lower pipe made the flow-pipe, and the water to rise from it into the upper pipe, and return by it, and then dip down perpendicularly to the boiler; but I was considered a theorist. What say you Mr. Editor?—*QUEERO*.

[Your pipes will do very well on the level, if you have an open cistern or an air-pipe at the farthest end. But if anything they will do better if in a length of 24 to 27 feet there is a rise of from 2 to 3 inches. It is not absolutely necessary. It is all right having both pipes a yard above the top of the boiler.

You cannot by any means make the lower pipe the flow-pipe, if that lower pipe is, as we understand you, connected with the bottom of the boiler, just because the hottest water will always be at the top of the boiler. As we understand you, the flow-pipe on entering the house from the boiler is a yard above it, and the other pipe comes underneath it, and on coming near the boiler descends to its bottom. Such

a pipe cannot be made the flow-pipe, that must come from the top of the boiler. It is true you might take the lowest pipe from the top of the boiler, and then make the higher one the return, and let it drop to the bottom of the boiler as you propose, and the lower pipe would then be the hottest; but we see no advantage in departing from the usual practice. If your two pipes were on the same level, the heat in both would be more uniform.]

ROYAL HORTICULTURAL SOCIETY.—APRIL 5TH.

WHETHER it was from the miserable state of the weather, or from the meeting not having been announced in the gardening journals, that there was such a meagre attendance to listen to Mr. William Paul's admirable lecture on the Hyacinth, we leave the authorities at South Kensington to determine; but for our own part we do not think it is the sort of treatment a gentleman like Mr. Paul is entitled to, after he has given himself the trouble to prepare a lecture for the benefit of the Society, that due publicity should not be given to it. Even the "Proceedings," due on the 1st, and which are kept up on the pretence of being the medium of communication between the Council and the Fellows, did not appear till the 7th, and then it was announcing a meeting and a lecture that had taken place two days before!

Mr. Paul's lecture was an admirable one, and was the first of a series which it is intended shall be given during the season at certain intervals on subjects connected with horticulture. He commenced by giving the botanical name and alliance of the Hyacinth, its native country, and describing its botanical characters. He then proceeded to give a very full account of its history from the time of its introduction to this country in 1596 till the present time; exhibiting the gradual development of its florists' characters from the loose scantily furnished spike to the dense bottle-brush head of flowers which it now presents. As exhibiting the great change that has taken place in this respect, Mr. Paul had provided large coloured drawings of the varieties existing in the early part of the seventeenth century, and which are described and figured by Parkinson in his "Paradisi in Sole Paradisus Terrestris;" and these gave a very vivid idea of the progress that had been made through horticultural skill when contrasted with the finely grown living specimens that decorated the room and the lecture-table.

Mr. Paul then entered into minute details on the cultivation of this popular flower in the open ground, in pots, and in glasses, and concluded by giving his ideas on the properties that a good Hyacinth ought to possess. As, of course, the lecture will be published first in the "Proceedings," we shall defer giving further particulars until the Society has had the benefit of its publication.

The Assistant Secretary then read a paper from Mr. Bateman, of Biddulph Grange, on the cultivation of *Musa Cavendishii*, and specimens of the fruit received from Mr. Bateman were distributed among the audience. Mr. Bateman placed at the disposal of the Council a plant of *Dendrobium nobile* to be ballotted for at the meeting, and on the numbers being called it was found that a young lady—Miss Nicoll, of Hyde Park Gardens—had become the fortunate possessor.

THE ROYAL BOTANIC SOCIETY'S SECOND SPRING SHOW.—APRIL 9.

On this occasion the day was remarkably fine, and so was the Show. Azaleas constituted the principal feature. The early Tulips were grouped near them, and the brilliant colours of the two contrasted admirably with the banks of green turf and the foliage of the other plants. Altogether this was the gayest floral and fashionable display which has taken place this season.

In Azaleas Mr. Turner, of Slough, distanced all competitors, his plants being magnificent pyramids of bloom, and so skilfully trained that it was only on the closest inspection that a stick could be discovered. The kinds were Criterion, Coronata (a blaze of rosy purple bloom), Prince Jerome, Beauty of Reigate, Illustris Alba (white), and General Williams (scarlet). Messrs. Lane, of Berkhamstead, were

second, having, among others, a showy plant of Chelsoni; and Mr. Bull, of Chelsea, third.

Among Amateurs, Mr. Cross, gardener to Sir F. Goldsmid, Bart., Regent's Park, was first with very good examples of Perryana and Juliana, scarlet; Louise Margottin, white; and Triumphans. Mr. Todman, gardener to R. Hudson, Esq., was second; and Mr. Young, of Ilighgate, third.

In the Miscellaneous Class Mr. Turner exhibited a well-grown collection of eight, of which Queen Victoria, white flaked with purple; Sir J. Outram, bright crimson scarlet; and Duc de Nassau, rosy purple, were the most remarkable. Messrs. Lane had also a collection in the same class, and to both exhibitors extra prizes were awarded.

Of New Kinds Mr. Turner had President, rosy salmon; President Claeys, pale salmon with white margin; and Perfection, rosy crimson spotted. Messrs. Lane had Reine des Blanchés, white; Comte de Hainault, rosy salmon, much spotted; and President Claeys. Messrs. F. & A. Smith sent Flag of Truce, a beautiful semidouble white; Prince of Orange, glowing salmon scarlet; Prince Albert Victor, semidouble red; and Excelsior, dull violet crimson, the last-named receiving a first-class certificate. From Mr. Bull came Hortense Vervaene, delicate salmon spotted with crimson; and Alexander II., a good white.

Cinerarias were neither very numerous nor fine. The first prize was taken by Mr. James, gardener to W. Watson, Esq., Isleworth. Lord Elgin (ruby), Duke of Cambridge (crimson self), and Perfection (white), were the most showy. Mr. Marcham, of Hanwell, was second. Rembrandt, a dark crimson purple with large eye, a seedling of Messrs. Smith, of Dulwich, received a first-class certificate; and A. Potts, Esq., Hoole Hall, Cheshire, had also a certificate for Magnifica, a very large bright crimson flower. Several other seedlings were shown, upon some of which remarks may be offered hereafter.

Of Amaryllis only one collection was shown, and for it a first prize was awarded to the exhibitor, Mr. Williams, of Holloway. For Begonias Mr. Cross received the first prize, and Mr. Young the second.

Mixed collections of flowering and ornamental-foliaged plants included *Boronia pinnata*, *Eriostemons*, one or two *Camellias*, *Azaleas*, *Maranta zebrina*, *Pandanus variegatus* and *elegantissimus*, *Latania borbonica*, *Gleichenia spunea*, and *Dicksonia antarctica*. Mr. Williams and Messrs. A. Henderson & Co., who had the finest two collections, received equal first prizes. Mr. Williams had in his collection a fine plant of *Vanda suavis*, with a spike of a dozen flowers. *Croton longifolium aureum*, from Messrs. Henderson, with longer leaves than the common sort, was beautifully variegated with golden yellow. Mr. Bull took the second prize, and third prizes were awarded to Messrs. Cross, Young, and Treen.

Early Tulips and Hyacinths were again exhibited in large collections by Messrs. Cutbush and W. Paul, who stood equal in the prize list for both. *Pelargoniums*, with but one or two exceptions the same as shown at Kensington, came from Mr. Turner, of Slough; and of Roses in pots, a score of compactly-grown plants in splendid bloom from Messrs. Paul & Son. Hybrid Perpetuals John Hopper, Lord Clyde, Senateur Vaisse, and Madame Boutin were especially remarkable; and Noisette Celine Forestier was in splendid condition; whilst Virginal, from its peculiar and extremely delicate colour, deserves a place in every collection. Several boxes of cut blooms came from the same firm; also, from Mr. W. Paul, and both exhibitors well deserved the equal prizes which were awarded to them. Lilies of the Valley were again shown by Mr. Howard, and a plant of the *Loquat* in fruit attracted some attention.

Among new plants there was very little that has not been previously exhibited. A variety of the New Zealand Flax called *Phormium tenax variegatum*, the foliage distinctly striped with yellow, received a first-class certificate. It came from Mr. Williams, who also exhibited three of those curious and seldom-seen plants, the *Sarracenia Drummondii*, flava, and *purpurea*; *Erica profusa*, a very free-flowering ornamental Heath; *Cypripedium Lowii*, and other plants. Mr. Mr. Bull also sent a collection, in which, besides plants referred to in previous reports, were *Camellia Angelo Cochi*, white and crimson; and Lilac Dr. Lindley, a new continental variety with large thyrses of almost white flowers. The latter

received a second-class certificate. *Genista Everestianum*, a free-flowering Broom, came from Messrs. Low, of Clapton; also, *Erica Haldfordiana*, a pretty rose-coloured kind, but not sufficiently distinct. It received a second-class certificate.

HEATING BY A STOVE OR BY HOT WATER.

I WRITE to ask your opinion respecting the stove used by "M.," of Liverpool, described at page 172. It appears to be very useful and economical, and, I think, would be still more so if a flue could be carried from it along the front of a house instead of taking a pipe through the roof. What I want to know is, Will the above stove or the old-fashioned flue be best for my purpose? I have three of what should be hothouses, but they are little better than cold houses. I have consumed a large quantity of coals and coke this winter, and all to very little purpose, for I cannot obtain heat enough.

My apparatus consists of a conical boiler, cast-iron pipes, and a very large brick-and-cement hot-water cistern, but it will not answer, and after trying it again and again I have condemned it, and shall pull all to pieces in the summer and build that which you may recommend, whether it be the above stove or the old sort of flue.

I have three houses. No. 1 is 12 feet long and 8 wide; No. 2 is the same in size; and No. 3 is 10 feet wide and 16 long. They are all lean-to's, on the ground level, and 6 feet high at front, and nearly 10 feet high at the back. I want a forcing temperature in No. 1, and also in No. 2, and to be able to keep the frost out of No. 3. The backs of Nos. 1 and 2 are brick wall, and the back of No. 3 is boarded. I want to heat all as economically as I can, and with one fire if possible. I have any quantity of bricks by me, and there is a chimney 30 feet high at the end of No. 3 house into which I can turn the flue if it will be of any service, but the flue must be about 40 feet long before it reaches the chimney, as the stokehole or cellar is at the beginning of No. 1 house. "M.," of Liverpool, does not say where such a bend of hot-water pipe as he mentions can be obtained, nor whether a flue would answer from such a stove.—AN AMATEUR GARDENER.

[We are afraid that if you cannot succeed with your conical boiler and hot-water pipes, you would not be more likely to succeed with the simpler plan of "M.," of Liverpool. We think that your conical boiler ought to heat a forty-feet range very completely, and the flue would also be an assistance. There is no other plan by which you can so easily heat the three divisions separately from one furnace, and that at the end of the range. We need not here specify the various modes by which that may be done, as they have been frequently alluded to, farther than to state that one of the simplest would be to sink the boiler well and take a flow and return pipe from it to the farther end of the 40 feet. If you did not wish this heat to go, unless when frosty, beyond the forcing part of 24 feet, you could have a semi-circular junction there, and a valve on the flow-pipe beyond. You could also do the same with the first 12 feet if so disposed. In each division, in proportion to the heat required, you could have—say four pipes in No. 1, and three in No. 2. If you took a fine right through less piping would be required. We rather incline to think, unless we knew positively to the contrary, that your want of heat is owing to deficient piping, or to the bad setting of the boiler.

In taking the flue right through such a range of 40 feet you would always have a little heat in the cool house, but this you could neutralise by giving more air. With a stout flue alone passing round the ends and along the front of such a range to the tall chimney, you could have heat enough for moderate forcing; but then you could not so easily manage with one chimney at the farther end from the furnace to heat the three divisions separately and at will. The flue and the hot water combined will enable you to do so with one furnace and with scarcely any waste of heat, and more especially as you have plenty of bricks at your disposal. We incline to think you do not obtain from the boiler what you ought to do. You would lately see answers to correspondents who have failed from bad setting, so that the heat from the fuel ascended the chimney and warmed the general air of the neighbourhood.

Did you want a strong heat for one place alone, you might heat the first 24 feet by a flue going right round, and

going into a chimney over the furnace, and then you could keep the frost out of the 16 feet by a small stove, with the smoke-pipe going into the chimney, either simply as a stove or with "M.'s" appendage of a hot-water pipe. Such a short pipe as he uses must either be made on purpose, or two bent pipes may be used joined together with a semicircular elbow. In short there need be no difficulty.

You could do no good with a flue from such a brick stove as "M.'s" built inside of his house. Such stoves, as has frequently been stated in "Doings of the Last Week," do not act well with a horizontal smoke-pipe of any great length, the less the better. Your high chimney would enable you to have a longer horizontal pipe or flue from your stove. But to have a regular flue from such a stove, even with the advantage of such a chimney, you would require to sink the stove so that the top of it would be about level with the bottom of your flue. As you have already a furnace, a boiler, pipes, and bricks for a flue, we would sink the boiler well, set it properly, take the flue along all the houses to the tall chimney, take a flow and return pipe all the way, rather below than above the ground line of the houses, and then take from these mains what extra pipes were wanted for extra heat, and these to be on a higher level than the main flow and return.

If you tell us what plan you decide on, and state what you want, we will be glad to help you if we can. Had your furnace been in the middle or between the hot and the cold houses matters would have been more simple. A good flue would heat the forty-feet range nicely without more trouble; but then there would be a good deal of trouble in so heating to different temperatures three separate divisions.]

THE DUCHESS OF BUCCLEUCH GRAPE.

IN a notice of this Grape from the pen of Mr. Anderson, of Oxenford Castle, which appears in the Journal of the 29th of March, he says—"The flavour partakes of that fine Grape, Chasselas Musqué, which is the parent crossed with Muscat." In a notice of it in another Journal, it is represented as a cross from the Royal Muscadine.

Both the statements are mistakes; and as much confusion exists as to the origin and parentage of some of the new Grapes sent out of late years, allow me space to say that it was raised from seed taken out of a Muscat berry, crossed with Chasselas Musqué.—W. THOMSON, *Dalkeith Park*.

OBJECTIONS TO THE TWO-DAYS SHOW OF THE ROYAL HORTICULTURAL SOCIETY.

I ENCLOSE a copy of a petition sent to the Council of the Royal Horticultural Society three weeks since, of which no notice up to this time has been taken.

Should you have space in your Journal for its insertion, it would greatly oblige the exhibitors.—GEO. BAKER, *Stamford Hill*.

"TO THE COUNCIL OF THE ROYAL HORTICULTURAL SOCIETY OF LONDON.

"WE, your petitioners, most humbly beg to inform you that in consequence of the schedule of the Royal Horticultural Society containing two days' exhibition consecutively, we regret we cannot out of justice to our respective employers advise that their plants should be shown, our former experience having convinced us that the exposure on the second day materially injures the plants, especially Orchids and stove plants generally.

"That the time occupied by the second day takes us from our daily pursuits; that the expense attendant on taking our productions to and from the exhibition, coupled with our personal expenses, are double those of a one-day's show.

"We therefore pray that you will take these our grievances (which are obvious to every practical exhibitor) into your serious consideration, and rescind your second day's show.

"It having come to our knowledge that you purpose lighting the conservatory with gas, we beg most respectfully to inform you that plants after one day's exposure in a dry hot atmosphere would be decidedly injured by the vapour from gas.

"GEO. BAKER, gardener to A. Basset, Esq., *Stamford Hill*.

J. WHEELER, gardener to J. Philpott, Esq., Stamford Hill.
 C. PENNY, gardener to H. H. Gibbs, Esq., St. Dunstan's, Regent's Park.
 J. CROSS, gardener to Sir F. Goldsmid, Bart., Regent's, Park.
 B. PEED, gardener to Mrs. Tredwell, Lower Norwood.
 T. PAGE, gardener to W. Leaf, Esq., Streatham Common.
 C. SMITH, gardener to A. Anderson, Esq., Norwood Grove.
 J. GREEN, gardener to Sir E. Antrobus, Bart., Lower Cheam.
 H. CHILMAN, gardener to Mrs. Smith, Ashted House.
 W. KAILE, gardener to Earl Lovelace, East Horsley Towers.
 R. BAXENDINE, Guildford, Surrey.
 J. WIGGINS, gardener to W. Beck, Esq., Isleworth.
 J. SMITH, gardener to his Grace the Duke of Northumberland.

W. TAYLOR, gardener to J. Yates, Esq., Lauderdale House, Highgate.
 W. YOUNG, gardener to R. Barclay, Esq., West Hill House, Highgate.
 J. WEIR, gardener to Mrs. Hodgson, The Elms, Hampstead.
 W. MILFORD, gardener to E. McMorland, Esq., Haverstock Hill.
 J. BAILEY, gardener to T. T. Drake, Esq., Shardeloes, Amersham.
 J. MAY, gardener to T. P. W. Butt, Esq., Arle Court, Cheltenham.
 R. BULLEN, gardener to A. Turner, Esq., Bow Bridge House, Leicester.
 W. MAY, gardener to J. Spode, Esq., Hawksyard Park, Staffordshire."

WIDE VINERIES WITHOUT INSIDE POSTS.

THE great rage among cultivators of the Grape under glass at the present time is for wide houses, or long rafters, with the greatest possible extent of cane.

A wide house with long rafters renders it necessary to employ inside posts and braces to support the roof, which,

in houses of any pretensions, greatly mars the beauty of the structure. A neat, convenient, and efficient method of supporting long rafters without inside posts or braces is shown in the following engravings.

In *fig. 1*, we have an end view of a lean-to vinery, with

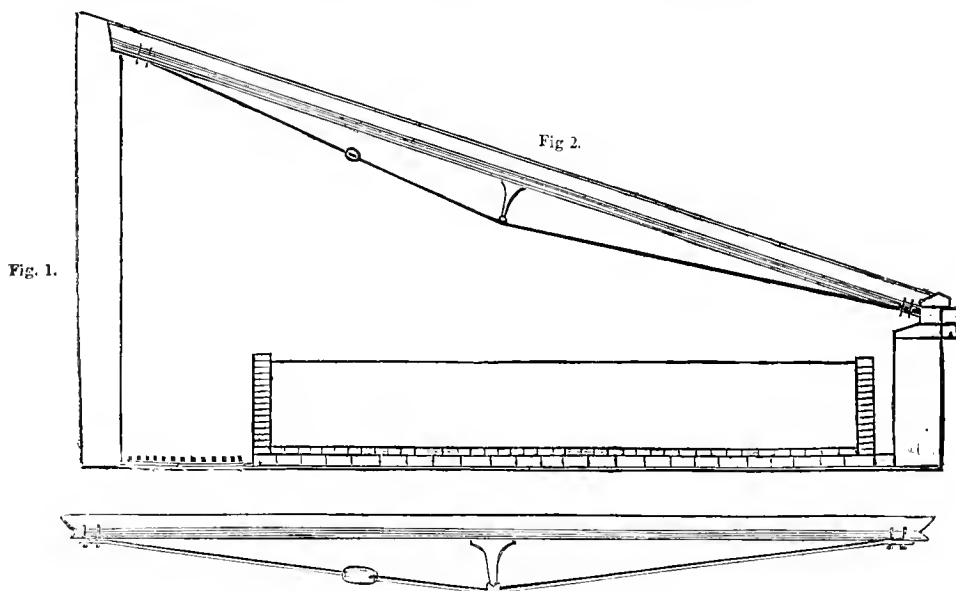

inside border detached from the front wall, but resting upon a concrete floor. The rafter may be 30 to 50 feet long if desired, and can be perfectly supported, without inside posts or braces, by means of a wire rope running over a central wheel, as shown in *fig. 2*. In *fig. 3* we have an enlarged view of the wire rope, and means of tightening it should the rafter sink.

Inside posts are always unsightly, and much in the way, and cross-braces of wood make a vinery look more like a

barn than a hothouse. We now construct houses of any width, without any sort of inside posts or braces. The rafters are bolted together at the ridge by concealed bolts, and all danger of spreading or lifting is prevented by bands of iron and bolts running from the rafters and plates into the solid wall.

The wire ropes and wheels, employed to support the rafters in the above design, will be entirely concealed from view by the trellis and vinery.—(*American Gardeners' Monthly*.)

CASUAL FAILURES OF LOBELIA SPECIOSA.

ASSUREDLY it becomes us, as practical horticulturists, when we hear of casual failures to suggest if possible a remedy, and not to fly to the supposition that in consequence of failures in some localities the plant, whatever it may be, is to become inapplicable to the purposes for which it may have been extensively used. I opposed the decided language once used in connection with all yellow bedding *Calceolarias*, "They were quickly to disappear from amongst us." I disagreed with that verdict, having stated in these pages that the chief cause of the want of success lay in the practice of stowing away cutting-pots crammed with roots into the hottest corner or driest shelf in old flue-pits and

elsewhere, which practice destroyed their vigour and favoured the production of a species of insect, which seemed ever afterwards to consider these plants as its hereditary domain. This view of the subject I have had the pleasure of seeing generally upheld, and, as I suggested, a cooler system of treatment practised. I have now to say that I see no cause of alarm in reference to the particularly useful *Lobelia speciosa*. As these notes have been suggested by Mr. Robson's paper in a late Number, I will now give a short detail of my own very successful practice with this plant.

I treat the *Lobelia speciosa* as an annual as much as possible, as I have to secure its being very early in bloom,

for I generally pull our bedded-out plants up in the second week in August. The seed is saved from the most compact and best-flowered plants of the past season, and is sown in the early part of September. When sown the box is placed at the back of the north wall; and a bit of netting with meshes sufficiently narrow to keep small birds away, held by means of a few sticks loosely over it, is the only protection it has. Thus the seedlings come up strong and healthy. They remain in this situation until after the first slight frost, which, if it does not thaw too hastily, seems to give them a greater hardiness, and enables them the better to withstand the winter. The box is then placed near the glass in the coolest end of a pit or greenhouse from which frost is excluded, and where the seedlings can have abundance of air. Here they remain the whole of the winter and grow rapidly. I have omitted to say that the seedlings should be properly thinned if too thick; those thinned out and transplanted will be equally useful with the others.

We struck our first batch in January, our second batch in February, and we hope again before this is read to have placed another lot in. In due time we pot the whole, both young cuttings and the old topped-back seedlings, which have by this process become strong bushy plants.

When bedding-out time comes we cannot tell the one from the other, so thoroughly robust are the whole. Out of two thousand which we planted out last year we only lost four.

Without reference to our successful practice, does not this treatment seem far more feasible and likely to lead to success than the process mostly practised of striking hard autumnal-flowering wood?—W. EARLEY, *Digswell*.

CONSTRUCTION OF VINERIES.

As I was thinking the other day how I should build some large hothouses for forcing Grapes, I visited, among others, one in which the produce was very small. The proprietor ascribed the deficiency to having forced the Vines too much two years following; and then the following plan for a vinery suggested itself to me.

It happens that the piece of ground I have slopes steeply. I would have double walls both front and back, and Vines planted between both, with sashes both back and front that would slide in either of two grooves in each wall as required, so that I could force one side one year, and let the other side rest. In this way I could begin to force one side in November, to get the crop off before the other Vines would be brought in. In this way the Vines of each side would only be forced every second year. Would you please tell me your opinion about it?

Or, if the above way of forcing the Vines so early would not do, would it not be a good plan to have the Vines planted just the same, but only to let them come halfway

along the roof of the house, meeting in the middle? In this way the house would produce a heavy crop without exhausting the Vines. In this latter plan I could begin to force later, without being bound to have the first crop off before the other could be brought in, as in the first plan.—A NOVICE.

[We think it is quite a mistake that Vines forced early are unfit to be forced early again. We consider that they are the best fitted for this purpose, because they will break early naturally of their own accord. Of course such Vines will sooner get exhausted by heavy crops than later ones, but not so much as is generally imagined. For a novice, however, your plan is very ingenious, and we have no doubt that you would succeed, either by having a back and front crop at the same time, or an early and late crop, as you propose. We presume that the high border at the back of the house is owing to the slope of the ground. If that back faces the north, the roots there would be very cold, and never feel the sun. We would much prefer planting such Vines in a border inside of the house; and, did we wish an early and a late crop, we would make that the early one. The whole of the Vines, except the stem, could go outside, as you propose them. In the back border we do not see what use you make of your double walls, with a space between them. In the front you take the stems of the Vines down through the opening to the border; but you could attain the same object with a single wall, and better without a wall at all, by columns some 5 feet apart to support a stout sill; and in that you might have openings for the plants if you required it—in fact you could plant inside if you liked, and allow the roots to go out underneath the sill. In doing so we would raise the border outside to the sill, and the sun would have more power on it than a level border. The double sashes are a good idea; the Vines, when at rest, could repose in the space between, and for this the double wall yields a slight advantage.]

PLANTS SUFFERING FROM A NEWLY PAINTED FRAME.

Do you think it likely that the fumes from a newly painted frame could act injuriously upon young Cucumber and Melon plants? I have been much disappointed in a hotbed upon which such a frame has been placed, and am utterly at a loss otherwise to account for the total failure of every plant that has been placed in it. In point of temperature all seemed quite right—a moderate growing heat, good soil, and every possible care taken in the management; but in spite of all means used nothing thrives. Pots of Cucumber and Melon seeds plunged in the bed come up, and look well for a day or two, and then hang their leaves, look wretched, and, instead of growing, daily become worse and dwindle away before the second leaves come. Good healthy plants were set out in the bed, and from the time of planting began to assume a sickly look. The young leaves, instead of expanding, curl at the edges, turn brown and flabby, and make no advance in growth from day to day. In appearance it is very much like the effect of cold air having been let in upon them, but such has not been the case. In short, it is quite plain that the plants will never do any good.

It appears to me that the evil influence, whatever it be, is above the surface, for on examining the roots they seem healthy and the young fibres spreading. The frame was put on the bed when the paint on it was scarcely dry; and the weather being cold at the time, the frame, of course, had to be kept rather close.—OMICRON.

[The delicate leaves of young Melon and Cucumber plants no doubt suffer from any impurities in the atmosphere they are placed in, and, had as our correspondent's case may be, we have known a worse. A gentleman who was erecting a quantity of timber fencing had a tank fitted up for dipping, or rather steeping, the posts and other framework in hot creosote. The lower ends of hop poles for about 3 feet or so have been for many years dipped, or rather parboiled, in this black preparation, and have been found to last much

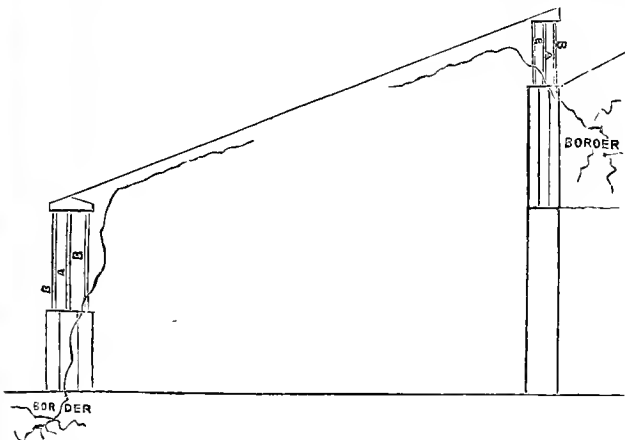

A Pillar. B Sashes to slide.

The sashes B slide in and out, so that when the Vines are inside, and you want to put them outside, you have only to slide out, from the end of the house, the sash of the outside groove, and put it in the inside groove.

longer; and the same is done in some cases with fence and gate-posts. And the gentleman alluded to, noticing the rapid decay of box frames when exposed to the various changes of hot moist dung and the drying heat of summer, had his box frame immersed in the tank with his other timbers. The consequence was that plants of all kinds refused to thrive for a time in his frame; even weeds seemed to dislike the coal-tar-like fumes emitted from it, and after repeated failures the gardener asked my advice on the matter. I suggested that, as the evil must have in a measure abated, if they immersed their frame in a pond for a day or two, and, after allowing it to dry again, gave it a thin coat of limewash, it would most likely be sweeter, which I understand was done with perfect success. Now, the fumes or gases emitted by creosote are more lasting than those of any oil paint that I am acquainted with, and I hope that before this page meets the eye of our correspondent the evil he complains of will have ceased to exist; but if not, and he still has reason to believe that the recently painted woodwork is the cause of the plants not thriving, I would say, Take the frame off some bright sunny day and expose it fully to the sun, and afterwards give it a coat of limewash and replace it again.

But it is quite possible some other agency may have been at work as well as the smell of paint. If the latter were the only cause it could easily be detected on opening the frame at back: in fact gardeners, by inhaling a little of the confined vapour of a Cucumber-frame, can tell better than a chemist whether that vapour is of the kind relished by the occupants. A long period of dull weather, however, so often proves fatal to young Cucumber and Melon plants, that it requires great care to carry them through the dark days beginning with the new year. Perhaps the evil has ceased with the increased sunshine. Though I have repeatedly had the interior of plant-houses painted when occupied with plants, I never perceived any serious injury to them from the causes you mention; but, as I have observed, Melon and Cucumber plants in the seed-leaf and in the dull days of early spring are delicate, and I am quite willing to believe they may have suffered; but the remedies prescribed above will, it is hoped, remove the evil if it still exists.—J. R.]

CONCRETE.

I BELIEVE that I have obtained reliable information relative to the materials and the proportions for making concrete to construct the walls of pits and other buildings.

The materials are fine sandy gravel washed or screened pretty fine and good lime. The proportions are three of gravel and one of lime.

I may add that it is by no means necessary to lay it all on at once. Indeed, we find it better that the lower part of the walls be allowed to get firm before any more is put upon it.—J. GLASSCOCK.

DESTROYING GOOSEBERRY CATERPILLAR.

I CAN with confidence recommend the application of soft soap and soda as a perfect cure for the above pest. My gardener has used it for years, not only here, but also in the west of England. The proportions mentioned in No. 157 are about the same as he uses.

It is very efficacious also for Apricots, Peaches, Currants, and Roses—in fact, I know no caterpillar or aphid that can stand against it. Care should be taken to sprinkle the under portion of the leaves, as the caterpillar conceals itself in the fold of the leaf.

One great advantage of the mixture is that it does not affect the flavour of the fruit. Should any of your correspondents wish for further information I shall be happy to give it to them.—E. Y. N., *A Lincolnshire Rector.*

WORK FOR THE WEEK.

KITCHEN GARDEN.

ANY person who applied liquid manure to his kitchen-garden crops when they were in a growing state can have no doubt of the great benefit that they derive from it. But

although such favourable results may reasonably be expected by all who would give the subject a moment's consideration, nevertheless it is surprising how very few adopt it. Suffice it to say that all food for plants must be fluid, whether in a liquid or gaseous state, and that when it is thus prepared it is brought to the state in which vegetables can absorb it: therefore there should always be a tank in the dungyard, or framing-ground, into which to conduct all the drainings of hotbeds, &c., or a large tub or barrel placed in a convenient situation; a bushel of manure to 40 or 50 gallons of water, horse, cow, sheep, pigeon, or any other such sort of dung would be suitable for the purpose. After being left to soak for twenty-four hours, the dung should be removed, and the liquid used in a clear state. *Brussels Sprouts*, make an ample sowing of these, which are the most useful green for a long winter; it is, moreover, the hardiest green we have, and produces, if sown in time, a greater bulk than any other, unless it be the Thousand-headed Cabbage. *Broccoli*, let a sowing of many of the sorts be made during the week. Do not forget the *Walcheren*, *Somers's Particular Late*, and *Snow's Winter White*. *Carrots*, thin-out these and all advancing crops. This should always be done in due time, and at twice: in the first instance, leave double the number you intend to retain as a permanent crop to meet accidents that young seedlings are liable to, and thin them to the proper distance when such danger is over. *Cucumbers*, sow the Ridge immediately in heat, and throw grass mowings, leaves, manure, &c., into a heap to ferment ready for making the ridge. *Dwarf Kidney Beans*, sow the dwarf sorts on a warm sheltered border, also a few *Scarlet Runners* and *Haricot Beans*; but these succeed so well transplanted that it is best to provide against failures by sowing them in pots or boxes, and germinating them under glass. When well up remove them to the open air, and cover at night if the weather is unfavourable, and transplant the beginning of the second week in May. *Onions*, throw up some high beds, 9 inches above the level, in the poorest part of the garden, and sow the Silver-skinned for pickling. Sow very thickly, and tread the seed very firmly, using scarcely any soil to cover them, rather shaking some old wet litter over them to keep the seed damp. *Scorzonera*, sow, and also *Salsafy*; and get in successions of *Red Beet*, *Peas*, *Broad Beans*, &c. Where *Broccoli* and *Winter Greens* are coming off the ground should be deeply trenched, the stems chopped in pieces being laid at the bottom, and quick-lime strewed over them.

FLOWER GARDEN.

The cultivation of annuals for garden decoration has in some degree given way to the more permanent class of bedding-out greenhouse plants. Yet some of the former will always find a place in many gardens, where they are useful for filling up vacancies in borders of herbaceous plants, bulbs, &c., and particularly for dressing up the margin of shrubberies where the space between the line of turf and shrubs may be occupied with them, so as to hide the bad effects which bare soil always produces, and afford a gay appearance through the summer, and this at a trifling expense. The present is a favourable time for sowing, the ground having previously been well dug and prepared. No idea of the beauty of annuals can be formed by the stunted patches we generally see, owing to the common practice of sowing the seed in a patch, and allowing, perhaps, fifty or more plants to grow in a space where only two or three should have been allowed to remain. The sorts to be selected which continue a considerable time in flower, appropriating those of a dwarf habit near the walks, and placing the taller-growing ones at a greater distance. Every seedsman's list affords a selection. Stocks, of course, will always be grown, and *Chrysanthemum*-flowered *Asters* which have bright and distinct colours with erect flowers. Do not forget to make one or two sowings of *Sweet Peas* to keep up a succession of bloom.

FRUIT GARDEN.

Top-dress *Raspberries*, and get them well staked. Cut down the double-bearing *Raspberries*. Cut away all suckers but two, or at most three, from a stool, and top-dress them. These will never succeed unless they are kept very thin. In-spect frequently grafted trees, remove all shoots below the scion. Moisten the clay if cracked and dry. Look to last year's budded stocks, and search for caterpillars. The

weather having become more genial to the opening bloom, a portion of the protecting material should be removed from Peach, Nectarine, and Apricot trees. Do this gradually that the blooms may not suffer by a too sudden exposure. Where spray or netting is used, and which could not conveniently be removed daily, a part should at once be removed, only keep it on hand in case a return to severe weather should render its use again necessary.

GREENHOUSE AND CONSERVATORY.

With the increased circulation of air which mild weather sanctions, there will be a more evident necessity for increasing the supply of water, to repair the loss which must ensue from a rapid evaporation. During strong solar light the paths of the houses may be damped, which will produce a gentle moisture extremely grateful to exhausted plants, many of which, having lately been shifted and made some little growth, will certainly suffer from any deficiency of moisture. Let all Pelargoniums, Calceolarias, &c., be well staked out. Give frequent attention to climbers in free growth, regulating the young wood before it gets entangled. At this busy season there is great danger of neglecting winter-blooming plants, such as Epacris, Daphnes, &c.; but if these are to be had in anything like perfection next season, they must be properly cared for now. Show-houses are generally kept too close and warm for Epacris, Heatis, and New Holland plants, and in that case they should be removed to the greenhouse as soon as they are out of bloom, affording them a rather damp and shady situation for a few weeks. Attend to repotting such as have started after being cut back, and keep them moist and rather close until the roots get hold of the fresh soil.

STOVE.

Those plants recently potted will be in motion. Allow of no diminution of bottom heat, and keep a moist warm atmosphere. Make cuttings as they can be obtained in a young state of all the most useful plants, in order to keep up a succession of clean young stock.

PITS AND FRAMES.

Pot off cuttings as soon as sufficiently rooted. Nothing is more injurious to young plants than to allow them to remain crowded in their cutting-pots until the roots become matted together. Pot and prick-off seedling plants, or remove them to a cool pit to strengthen them. W. KEANE.

DOINGS OF THE LAST WEEK.

KITCHEN GARDEN.

EXCEPT sowing Tomatoes, pricking off Capsicums and Chilis, pricking out a little Celery, sowing more, pricking off early Cauliflowers, watering and earthing-up those under hand-lights, potting Dwarf Kidney Beans and sowing more in succession, and part of a row in a cool orchard-house, sowing Mustard and Cress and such herbs as Parsley out of doors, and Basil, &c., in a little heat, the work has been of a routine character and much the same as in previous weeks. The linings round Cucumber-frames have been banked up so as to maintain a minimum temperature of about 65° at night. From making the bed wider than is generally done, and banking up to the top of the frame, we can regulate internal heat without giving too much bottom heat.

On Tuesday we had a heavy snowfall, which continued the whole day and most of the night, and this made the ground greasy and unworkable. We prepared for frost on Tuesday, but there was none to speak of. There has not been a gleam of sun from Sunday to Thursday evening. We find that from the frequent changes during the winter Parsley has pretty well dwindled and rotted away out of doors; but a small row sown in the orchard-house in the beginning of July, has given an abundant supply. Previously we used to fill some boxes and pots, to place in a cool house under glass in winter, to be ready when the weather was bad outside.

FRUIT GARDEN.

On Tuesday afternoon, then snowing heavily, a rising barometer made us afraid of a sharp frost, and, therefore, we put laurel branches over Peach trees, Apricots, and even forward Pears and Plums. A Plum trellis bristling with

fruit-buds last week, we were saved all trouble about. We do not believe that out of many thousands the birds left a dozen. Some trees against walls, and exposed, and the bloom more forward, were untouched. These were slightly covered. They were young trees growing vigorously, the roots were cut in the end of September, and every twig and spur has been covered with fruit-buds. A row of dwarf Pear trees that were pictures last season, and promised as well for this, were protected with nets; but last Sunday and Monday the larger and smaller tomtits got under the nets, and didn't they enjoy themselves, pretty well clearing the trees of their buds! Much against the grain, we were obliged to pepper a lot of the pretty little rascals with dust shot. But for the noise this is preferable to trapping and poisoning them, which means are often attended with lingering pain. We shall always remember a pretty young lady who, shrinking with terror at the sight of a repulsive crawling reptile, cried out, "Kill it, but do not hurt it." There was much of humane philosophy underlying the seeming contradiction involved in the injunction. A rat or a colony of them, but we think but one, had made itself a home too near to our doorway, and nothing would induce him to quit his quarters. Having no desire to have him for a bedfellow, a trap was set for him, and it caught by the legs a favourite robin that had hopped about the door, and in-doors, and been fed for many a winter. Poor thing! it vexed us as much almost as if we had had a finger crushed. At last the rat was found trapped and dead, and it was so far satisfactory to know that his death must have been almost instantaneous. A favourite cat lost for a week at last came back a perfect skeleton, and minus a foot and part of a leg. He was as good a mouser as ever, but instead of catching with the claws of the other foot, he used to give the mouse a stroke with the stump, and thus turned it over. Gamekeepers, and gardeners too, should recollect that if they assume the right to kill, they can have no right to torture. When some favourite fruit tree is rendered fruitless for the season, however, our finer and more delicate feelings are very apt to fall into abeyance as respects the wrong-doers.

Went over, thinned and regulated the wood in the earliest Peach-house. Here there has been little need for thinning fruit this season, and the crop will be thinner than usual. It is but right we should let the readers know the reason. For years the trees have borne heavily. Last season they were attacked with the brown-beetle and fly, and our attempts to destroy them we fear, did no good to the buds. We gave the house a smoking when the fruit had commenced to swell freely; and we ought not to have done so, as we found that some of the fruit when ripe were rather tainted. We were mortified to find lots of flowers defective when in bloom this spring. The above causes might help, but the chief cause we believe to be taking the lights off too soon in order to have them painted on the under side. The painter was very anxious to have them off, and against our judgment we consented. The wood should have had another month's ripening under glass. They wanted more ripening than the later trees on the back wall of a lean-to orchard-house, as these latter had the full sun on them all the time of their growth, whilst the trees in the Peach-house were considerably shaded by shelves of Strawberries, until they came ripe in the open air. This house is about 12 feet wide, 11 feet high at back, and about 1 foot above the ground in front. The trees cover the back wall, and there is a trellis in front, 4 feet high at back, and within 3½ feet of the back wall. A shelf is suspended over the path, another over the top of trellis, a third farther down, and a fourth at the front. When these shelves are taken out before the fruit ripens, the trees receive then plenty of light; but whilst the Strawberries are there, of course they are considerably shaded. Notwithstanding these drawbacks, taking the evidence of many years as something like a test, we are persuaded that if we had kept the glasses on a month longer after the fruit was gathered, and given the trees plenty of heat and sun, we should have had as much trouble in thinning flowers and fruit as in the case of most of the trees in the orchard-house. It is very seldom we remove the lights from this house at all. We mention the thinness of the crop this season when compared with the heavy crops of many previous years, just to impress the idea that little matters are often of great consequence. But for the painting, and to oblige, by taking off the sashes by

degrees before all the fruit was gathered, the dry sun heat would have made the twigs like oak branches for firmness, which is the state we like to have them in. The thinner crop will give a little more strength to the trees.

Thinned out lots of blooms, and fruits just setting in the orchard-house, and disbudded and shortened foreright shoots. With all our thinnings of blossoms there will be more than four times left that we shall finally retain even for a heavy crop. Some of the shorter shoots were crowded with blossoms like ropes of Onions or bottle-brushes. As yet we have seen no trace of our brown-beetle enemy of last season, and hope he has taken his departure for good. Every inch of these houses as respects the floor, is covered with Strawberries, Peas, fruit trees in pots, and plants requiring a little shelter.

We have read with much interest the articles by Mr. Abbey and Mr. Rivers, &c., and if time would allow should like to see the houses of the latter gentleman just now. There can be no question, that the larger such houses the easier they will be managed; but there need be no difficulty even with narrower houses, if one thing is thoroughly attended to, and that is *early air-giving*. With that given early, a higher temperature from sun than we should like to mention will do little or no harm. Defer this air-giving until the sun has made the enclosed place like an oven, and you may expect scorching, scalding, and burning of blossoms, and falling of the fruit. Some years ago we saw a beautiful house not more than 7 feet wide, the fruit was just set and swelling, and everything looked so well. In a fortnight we heard the trees were a wreck so far as the fruit was concerned for that season. The gardener had to leave home, and his generally attentive assistant forgot all about the house until eleven o'clock, after the sun had been beating on it strongly for three hours and a half. He then gave all the air he could under such circumstances. It would have been better to have given only a little air at first, shaded the house, and sprinkled the whole inside with tepid water.

Disbudded and regulated Vines in second division, or rather thinned out the shoots. Young Vines planted to help the old ones are coming away strong. Gave a coating of sulphur to the pipes in second house, in order that the strength of the sulphur may be pretty well gone before the bunches open to bloom, as just when in bloom we deem fumes of sulphur to be dangerous. Though a hardy Grape, yet none is so sensitive, or more sensitive in this respect at this time, than the Black Hamburgh; and if, however young, the berries are at all blotted they will never grow out of it, though the berry may swell pretty well. Gave the wood in the Fig-house a good thinning, and stopped the points of most of the young shoots left for a second crop. When Figs have been rather dry, and the fruit shows before they are watered, they should be watered gradually, or the fruit will be apt to be thrown off. Give a thorough good soaking at once, and very likely a lot of the young fruit will drop. It would be safer to make holes, and water at three or four times until all the soil was moistened. Pines should now have a nice regular heat, and all potting should be proceeded with, giving the plants as little check as possible. If the roots are at all in bad order they should be transferred to a smaller pot, be placed in a bottom heat of from 80° to 90°, and kept rather close in a moist atmosphere, and then when the pot is filled with fresh roots a larger shift may be given. Fruit approaching ripeness should have a dry atmosphere to impart flavour. Melons train and disbud, to prevent an accumulation of small shoots and masses of leaves. Every leaf that cannot be exposed to the light is one too many. Do everything to avoid shading. The only times when shade is likely to be essential are when a bright day comes after a week of sunless weather. Early air-giving will ever help in that case.

ORNAMENTAL DEPARTMENT.

The weather has been unsuitable for much out-of-door lawn or flower-gardening work. Planted out lots of Calceolarias and Geraniums in turf-pits, with cloth and hurdle coverings. Was obliged to use litter and hay over those beds pretty freely, as we dreaded a severe frost after the snow, which, however, did not come. Made cuttings of Petunias, Nasturtiums, Variegated Alyssum, Chrysanthemums, Heliotropes, &c., and put many of them on tiles and pans, to be turned out temporarily as soon as they are struck. Cleared out part of the Calceolaria-bed. Put about a foot of hot

leaves and dung in the bottom of it, 2 inches of rough leaf mould on the top of it, and about 3 inches of a rough compost made of riddlings from beneath the potting-bench, sifted burnt and charred heap, sifted old Mushroom-dung, and ditto leaf mould, in about equal proportions, and commenced planting out in it young Verbena plants, giving them from 3 to 4 inches spaces. They will root and lift well when we want them out of such material. Pricked-off in wet days lots of Lobelias, Ageratums, dwarf Petunias, &c. Sowed more of tender annuals, and before this is read shall have sown Stocks, Asters, Marigolds, Zinnias, Coreopsis, &c., Nasturtiums of kinds, &c., Sweet Peas, &c., as there is a pleasure even in variety, though some things be homely. The finding places for all these is now the difficulty. Potted numbers of Geraniums, Fuchsias, Centaurea candidissima, &c., and placed them on stage in second vinery, whilst many Begonias, Achimenes, and Caladiums, were fresh potted and placed on the stage in the first vinery, the shade being just the thing for these fine-foliaged plants. Potted also Gloxinias, and brought pots of Gesnera zebrina and varieties out of a dry, dark, warmish place, where they could have light and moisture, as they are beginning to move.

Where the stock of Azaleas is large, it would be well to place a portion in a house or shed with a north aspect, to prolong the period of blooming. Camellias done flowering should receive a help beneath the shade of Vines. Epacris done flowering should be pruned back, not cutting, however, into the old wood. Boronias, Croweas, &c., should have the warmest part of the greenhouse, and be carefully watered. All the hardwooded pea-flowered shrubs, as Gompholobiums, &c., require similar care, and plenty of air in mild weather, but no keen draught when it is stormy and cold. Primulas and Cinerarias should be sown for early autumn blooming. Pansies and Violets may now be divided, and cuttings will strike freely at the north base of a wall with or without hand-lights. The bright little yellow Viola lutea is well worth growing and propagating. Took up our old stools of Cineraria maritima, and got some hundreds of suckers from them about 2 inches in length, and placed them thickly in heat to strike. In a few days we shall get lots more from the same stools, and these make the neatest plants.—R. F.

COVENT GARDEN MARKET.—APRIL 9.

The market continues well supplied, and business is slightly improved. From abroad large consignments of Lettuce, Eadive, Carrots, Artichokes, &c., continue to arrive. Hothouse Grapes and Strawberries are sufficient for the demand; but Pies are somewhat scarce. In Apples Nonpareil, Winter Pearmain, and Golden Knob can be had good. Pears are now very scarce. In Greens there is a good supply of Coleworts, and spring Cabbages are very good. Brussels Sprouts and Savoys are now over.

FRUIT.

	s.	d.	s.	d.		s.	d.	s.	d.
Apples ½ sieve	2	0	4	0	Nectarines	0	0	0	0
Apricots doz.	0	0	0	0	Oranges	100	4	0	10
Figs	0	0	0	0	Peaches	0	0	0	0
Filberts & Nuts 100 lbs.	0	0	0	0	Pears	8	0	12	0
Grapes, Hothouse...lb.	15	0	25	0	dessert.....½ sieve	6	0	10	0
Foreign	1	6	2	0	Pice Apples.....lb.	6	0	12	0
Muscats	0	0	0	0	Pomegrauates.....each	0	0	0	0
Lemons	100	4	0	10	Strawberries.....doz.	0	6	1	6
Melons..... each	0	0	0	0	Walnuts.....bush.	14	6	20	0

VEGETABLES.

	s.	d.	s.	d.		s.	d.	s.	d.
Asparagus bundle	8	0	14	0	Leeks..... bunch	0	4	0	0
Beans, Broad..... bush.	0	0	0	0	Lettuce..... doz.	1	0	2	0
Kidney	2	0	3	0	Mushrooms..... pottle	1	0	2	0
Beet, Red	1	0	1	6	Mustd. & Cress, punnet	0	2	0	4
Broccoli	0	5	2	0	Onions..... bushel	4	0	7	0
Brussels Sprouts ½ sieve	0	0	0	0	pickling quart	0	6	0	8
Cabbage	1	0	1	6	Parsley..... ½ sieve	2	0	3	6
Capsicums	100	0	0	0	Parsnips	0	9	1	6
Carrots	0	6	0	8	Peas..... bush.	0	0	0	0
Cauliflower	4	0	5	0	Potatoes..... sack	6	0	9	0
Celery	2	0	3	0	Radishes doz. bunches	0	6	0	9
Cucumbers..... each	1	0	2	6	Turair	2	0	3	0
Endive	score	1	3	2	Rhubarb	0	4	1	0
Fennel	0	3	0	0	Savoys..... doz.	0	0	0	0
Garlic and Shallots, lb.	0	8	0	0	Sea-kale..... basket	1	6	2	6
Herbs	0	3	0	0	Spinach..... stove	2	6	4	0
Horseradish ... bundle	1	6	4	0	Turnips..... bunch	0	4	0	6

TRADE CATALOGUE RECEIVED.

Downie, Laird, & Laing, Stanstead Park, Forest Hill, London, and 17, South Frederick Street, Edinburgh.—Descriptive Catalogue of Florists' Flowers, &c.

TO CORRESPONDENTS.

CAPE GOOSEBERRY (R. O.).—It is *Physalis edulis*, a native of Peru and Chili, but cultivated for its fruit at the Cape of Good Hope, and thence introduced to Australia and others of our colonies, where it is popularly known as the "Cape Gooseberry."

SCARBOROUGH LILIES (Amaryllid).—We do not know them by that name. If you send us one of the flowers in a box probably we shall be able to identify it.

GUANO AS A VINE MANURE (B. A.).—The best time to use guano on a Vine-border, is when the Vines are growing freely. If the roots are near the surface, 2 ounces to a yard will be sufficient at one time. If the roots are deep, 3 or 4 ounces may be used. Perhaps the most profitable way is to use it as a watering, stirring the surface at first, and throwing a little fresh soil over after the watering, or at least raking the border, to keep the ammonia in. From 1 to 2 ounces a-gallon, according to the nearness or distance of the roots, would be enough. It is better to repeat the dose instead of giving too much at once. When applied merely on the surface by the hand, much of the virtues of the manure will go into the atmosphere. Among growing crops this is of less importance; but the Vine-border should not be cropped.

DIELYTRA SPECIOSISSIMA SEEDLINGS (F. V. Trollope).—We could not specify instances of raising seedlings of *Dielytra*, but we think yours well worth looking after. They will do best in the cool conservatory. Do not give them more heat by any means.

PANSY SOIL—CLIANTHUS SEED SOWING (Leighton, B.).—Rich garden soil will grow Pansies very well. If you must make compost, use six parts of fresh sandy loam, and one part rotten dung and leaf mould. You may plant out the seedlings now, near the wall, as you propose; and if the weather is stormy, protect with a few twigs stuck in the ground. You may sow the seeds of *Clianthus Dampieri* either with or without soaking them previously. They are best put into small pots separately, and as soon as the first root gets to the side of the pot, repot in a larger pot, and water only as the roots occupy the soil.

LARGEST PEA AND LONGEST DWARF KIDNEY BEAN (A. R.).—The largest-podded Pea is the Tall Green Mammoth; the Pea having the greatest number of peas in the pod is the true Scimitar. The longest-podded Dwarf Kidney Bean is the White Dutch.

MANY QUESTIONS (A Subscriber).—We answer three out of your nine questions. There are two white-flowered Ribes, niveum and sanguineum album. Chopped tobacco will not kill the green fly unless it is converted into smoke. Canna roots are the roots of some species of Canna. Whether they are worth having depends upon whether they are in good condition and what are your means of growing them, of which we know nothing.

MOVING YUCCAS—GREENHOUSE CREEPERS (F. H. C.).—The Yuccas may be very safely moved. Preserve their roots as much as possible, and lift them with a ball of earth round them. Water well when planted. Now is a good time to move them. *Lophospermum scandens*, *Manrandaya Barclayana*, *M. kermesina*, *Ipomoea rubro-ocerulea*, *Cobaea scandens*, *Calampelis (Eccremocarpus) scabra* will suit your purpose, and give an interesting variety in your greenhouse.

STRIKING AND GRAFTING ROSES (T. G.).—You are not likely to succeed in striking Roses at this season of the year. The cuttings will look fresh, and burst into bud, and then the great majority of them will go off. Such is our experience. You will be as far forward by striking cuttings next September and October, as by making the attempt now. At the season named Roses strike like Gooseberry cuttings, managed just in the same way. The grafting, as you describe, is worth trying, and you may succeed to a certain extent.

CONSUMPTION OF FUEL UNDER BOILERS (J. Mackenzie).—We have no great faith in the wonders that some boilers are stated to do. In severe weather there could be little waste in raising your houses 40° or 50° above the external atmosphere with the consumption of half a ton of coals or so a-week. Grapes can only pay where there is a good market and coals cheap. 16s. 6d. per ton is not out of the way. There can be little matter with the boiler when you can boil the water in the pipes so readily. We, however, disapprove of ever having the water so hot. When the heat is up, the fire should be banked a little with cinders and ashes, and the damper should be put in, leaving about a quarter of an inch for draught, and from that to one-eighth of an inch in the ashpit-door, if closing altogether would cause the fire to go out. The preventing the heat of your fuel going up the chimney is the only way by which you can save fuel. It will seldom be necessary to raise the temperature 40° or 50° above the external air. If the pipes do not give you heat enough unless the water in them is nearly boiling, it will be cheaper to add more piping instead of heating the water so much. As a rule the water should rarely go beyond from 170° to 180°. When you raise it higher there will be sure to be waste of fuel in proportion. No boiler ever yet tried will absorb all the heat from the fuel under it. The use of a damper and a close ashpit-door enables us to economise as much as possible. Very likely you might heat another house from a flue from your furnace, without costing you more for fuel.

PLANTING VINERIES (F. Grant).—For forcing-house we would plant the following:—*White*: One Dutch Sweetwater, one Buckland Sweetwater, one White Frontigan, one Muscat of Alexandria, one Bowwood Muscat. *Black*: One Muscat Hamburg, one Victoria Hamburg, two Black Hamburgs, one Trentham Black. For greenhouse part:—*White*: One Muscat of Alexandria, one Royal Muscadine, one Calabrian Raisin in warmest part. *Black*: Two Black Hamburgs, one Lady Downes'. You may grow anything in the pit of the forcing-house until the roof is pretty thick with foliage. It would do for forcing all sorts of things early; also for propagating purposes. It would not do well for established Peaches on a trellis, as, if your Vines were nearer than 5 feet apart, there would not be light enough to ripen the wood. You might grow Peaches in pots, as the fruit would be set before you wanted a high temperature for the Vines, and you could move them to the sunniest places, and might harden the wood out of doors in autumn. Figs also would do well in pots.

BOOK ON VINE CULTURE (A Recent Subscriber).—If you send a post-office order for 5s. 8d., with your address, directed to Mr. F. S. Angel, at this office, you can have Mr. Thomson's book on Vine culture, and the Number of this Journal for January 19th, 1864, free by post. The other work, on reconsideration, we think might mislead you on some points, especially as to making the border.

PRIMULA SINENSIS SOWING, &c. (A Young Beginner).—For plants to flower early in winter sow in the middle of April, or even earlier than that; while a second sowing may be made in the beginning of June. The best compost is peat and sandy loam in equal quantities. It is usual to sow in pans, and if the seedlings come up very thickly, thin them and prick them out into pans or boxes for a time; afterwards pot them off successively, until, at last, the early-sown plants will occupy a 32-pot. Observe to shade the plants from the midday sun until the beginning of September, when they may be gradually inured to it and benefit accordingly. The later-sown plants will, of course, come in for a succession, but, with care, will flower equally well with the first.

VARIOUS (F. H. C.).—We have seen no appearance of any *Calceolarias* marked 4 and 5 respectively. We find three specimens marked 1, 2, 3, but nothing about them in the letter. The first is *Gnaphalium lanatum*, the second Variegated Alysium, and the third is so withered that we do not know whether it is a *Cerastium* or a creeping plant, with whitish leaves. You may sow the *Cineraria seeds* in a hotbed, if not too hot, but, as soon as they are up, remove them to a cold pit or frame. Perhaps it would be safer to sow in the last place at once, as, if you keep them too long in heat, it will enfeeble them for the rest of their existence. *Cinerarias* do best kept cool, but untouched by frost. Those sown as early as this should be pricked off when they can be handled, potted separately in small pots afterwards, and then into larger, and placed in a shady place out of doors in summer, and they will bloom early in autumn. Sandy loam and leaf mould will grow them well. If you had read the accounts of such places as Trentham, or even the "Doings of the Last Week," you would have seen that most gardeners do something to their Peach trees after pruning them, in the way of washing, painting, &c. The lower part of your shoots being destitute of fruit-buds must be owing to imperfect ripening of the wood, or the attacks of insects last season. Of course you cannot have buds there now. You must not syringe your trees whilst in bloom, either with clear water or tobacco water. When the fruit is set you may do so; but use the tobacco water not too strong. If there are insects, as fly, on the young shoots now, you may brush them over with tobacco water, but keeping it out of the centre of the flowers. You have allowed green fly to get ahead among your Verbenas, and no one or two smokings will clear them, because the smoke, however effectual, will only kill those that are alive. As you have plenty of tobacco water, we would dip them in it—thus: make up a pail of water with it, not too strong—just weak enough not to injure the plants, and strong enough to kill the insects when dipped into it, which you can ascertain by trial—then take the pots or pans of plants or cuttings, pick off the dead leaves, and turn out any of the loose surface soil; turn the pot upside down in your hand, and draw the heads of the plants, right down to the soil, backwards and forwards through the prepared liquid in the tub or pail; afterwards lay all such pots down on their broadsides, in a clean place—say on some litter, straw, or mats. Let them lie there for from six to twenty-four hours; then, with some clean water, turning the head up and down. When the plants are dry, pick off as much as you can of the surface soil, and replace with fresh; and then place them, if possible, in a mild bottom heat, say of 70° to 75°, and an atmospheric heat of 50° to 55°. If anything will recover your plants, and furnish healthy heads for cuttings, the above plan will do it. Even then it would be well to draw the cuttings through weak tobacco water.

LAPAGERIA ROSEA CULTURE (Country Subscriber).—The following is the extract from our No. 575, which you request. It was from the pen of the late Mr. Beaton:—"The best *Lapageria* we have seen is the one we described three or four years since in the Heath-house at the Pine-Apple Place Nursery; it was a planted-out plant. No doubt but some of our best plant-growers will do this plant in pots, but second-rate gardeners never will; and a child might grow it in a border in any side or aspect in a cool house. But for the first three or four years of good growth *Lapageria* may be grown in a pot as well as in a border, as some extra heat can be thus given it for two or three months in the spring, as we have reported from the nurseries. Plants of *Lapageria rosea*, which are as hardy, if not more so, than Cape Heath, were reported by Mr. Beaton last spring as being in the stove along with *Alamandas* in the Messrs. Fraser's Nursery, at Lea Bridge. The plant referred to by our correspondent is still in active growth; a young shoot just rising. There are some few fast-growing climbers, which, if they were in this condition at the beginning of October, ought to be fresh potted even then, but they are few indeed. On the other hand, this *Lapageria*, as compared with our hedge Bindweed, is an extremely slow grower; besides which, its roots are very different in their power and formation from those of most other climbers, save such as are related to *Smilax*. Indeed, *Lapageria* is a kind of extreme southern *Sarapailla*, with the flowers of the most gorgeous of the Peruvian *Bomareas*; therefore, very distinct in its natural habits from all ordinary climbers. The plant, therefore, should not be potted under any circumstances later than the middle of August, nor be kept in artificial heat later than the middle or end of September. In ordinary cases, however, this plant ought not to receive artificial heat after the summer sets in warm enough to dispense with fires in stoves and drawing-rooms. Keep the frost from it in winter, and at the end of February introduce it into stove heat, if there is a stove; and after 6 inches of fresh growth are made in heat, pot it afresh, if it require it, and keep it in this till the end of May, by which you will gain two more months to the summer as it were. A north rafter in a conservatory-house will suit it best; but as to pole, pillar, trellis, or chains, they are all the same to all climbers. As to the size of the pot or pan, that depends entirely on the quantity of roots. One would need to be endowed with the spirit of prophecy to be able to tell the size of a pot, pan, tub, box, vase, or basket, for any plant without seeing it turned out of the pot it is in. Once it is fairly in good growth, *Lapageria rosea* requires an enormous deal of water—say four times more than a *Passion-Flower*."

FLOWER-BED (F. T. C.).—If, instead of mixing the Scarlet Geranium and *Cineraria maritima* for a centre, you were to plant the former alone, and then a ring of the latter, and, as you advise, *Lobelia speciosa* for an outer edge, the effect would be excellent. If required, you might have your *Cineraria* ring to consist of two or more lines of plants. The outer edge, however, ought to be regulated by what it is bounded with; if that be turf, we would dispense with the *Lobelia* for that bed entirely, and allow the *Cineraria* to become the edge. You can have, free by post, the work, "Window Gardening for the Many," by sending your address and ten postage stamps to our office.

SILK-WORMS (E. P.).—You may purchase either eggs or caterpillars in Covent Garden Market.

CULTURE OF GYMNORHAMMA CHRYSOPHYLLA (Violet).—It wants all the warmth that can be given it; properly it is a stove Fern. It will not bear damping too often or too freely. It should have shade. The plant you enclosed is *Pimelaea decussata*.

DIMINUTION OF SOIL (J. Ainsworth).—No one can answer such a general question as—"If a field be grazed for a hundred years, and no manure be carried on, at the end of that time will there be less soil in that field?" The nature of the soil, its elevation, surface slope, and many other circumstances must be known before a guess could be made, and then it would be but a guess. All plants absorb oxygen by their roots; seeds will not germinate, nor will fruit ripen, without it. You will find full information on these and relative subjects in "The Science and Practice of Gardening," published at our office.

CUCUMBER, THE LONGEST (G. W. F. P.).—The Snake Cucumber, as it is called, is the longest we know; but it is more an elongated Gourd than a Cucumber, and is merely grown as a curiosity; but if you want one to grow and exhibit, we would advise you to try one of the many kinds advertised by respectable parties in our columns. The Manchester Prize is a good Cucumber, as likewise is Telegraph, Victory of Bath, Champion, and many others; but, of late years, other qualities, as well as length, are taken into account, and many Cucumbers, not remarkable for extreme length, possess the other qualities in a greater degree.

SOIL FOR POTTED PLANTS (F. T. C.).—Some little knowledge of the character of soils is required by those who mix and prepare them for potting; but we may say that, in general, finely sifting any soil, except for, perhaps, covering seeds or other special purposes, is seldom done. Such soils need not necessarily become impervious to water if there be sufficient sand in their composition. One thing, however, we must caution the inexperienced against, and which is, we fear, often disregarded—that is, never to move a pot or pan that has been newly filled, and then deluge with water. A mass of fine earth, thoroughly wetted, and then shaken in a pot, becomes much like concrete, and possibly our correspondent's plants may have been treated in this way. Pot in moderately-dry mould, and remove the plant to its final resting-place before watering. Generally speaking coarse lumpy mould for large plants, and fine for small ones, with, however, plenty of drainage in both cases, is advisable.

NAMES OF PLANTS (Broomfield Park).—1, *Aristolochia sempervivens*; 2, *Hypericum aegyptiacum*; 3, *Goldfussia anisophylla*; 4, *Adiantum capillus-Veneris*. (C. P.).—1, not recognised; 2, *Teucrium marum*; 3, *Oxalis cornuta* (?). The gutta percha keeps them fresh, but does not save specimens from the post-office punch. (*Orchidophilus*).—Not recognised from such a specimen. (C. P.).—It is *Lastrea decurrens*. *Selaginella casia* succeeds best in a heated structure, but should go well in a plant case in a warm room. It likes shade. (*Leighton, B.*).—*Doronicum austriacum*. (D. H.).—The plant you found on Cader Idris, at an elevation of 2000 feet, is *Saxifraga oppositifolia*.

POULTRY, BEE, and HOUSEHOLD CHRONICLE.

POULTRY FOOD.

THE quality, quantity, and the nature of the food are vexed questions. Where one dies of starvation a thousand die of excess. One eats ravenously, and bolts his food from craving hunger, looking in vain for more; another looks discontentedly at delicacies because he is overfed, and consequently has no appetite. Nothing will come amiss to the first, nothing will produce appetite in the other. It was only a choice of evils that gave Oliver Twist courage to ask for more. The attractions of the plateful outweighed the dread of the flogging; yet a very short time in luxury would have destroyed the appetite and the health that was the foundation of it.

Look at the difference in the condition of "nobody's dog," such an animal as is known in many neighbourhoods, liked by all and fed by few, and the plethoric pet of Lady May Fair. The first is always on the look-out; he examines the sawdust that is swept from the butcher's shop to search for any scraps that may be among it; if a bone be thrown into the street he knows the rattle, it is music to him, and he has it directly; he has indistinct notions of property, and pays little respect to the child carrying bread and butter carefully but temptingly along the street; but he is in grand health and splendid condition. The other animal is daily washed and combed; it is fed on every luxury; its poor stomach rejects chicken without sauce; fat and skin are abominations not to be thought of; it makes fat and loses strength, muscle, and appetite. Then it must be coaxed, delicacies must be discovered that can tempt it to eat, but all is of no avail; health and utility are destroyed by over-feeding, and by ministering to a pampered appetite. See the leaden complexion and deadly look of the spoiled child that will eat nothing but pastry, sweets, jams, and such like, and compare it with the bright eye and clear skin of one brought up on moderate quantities of wholesome food: no one can hesitate which to choose. Yet persons who see the case clearly in dogs and children have no discretion when chickens are in question.

As an example, one writes to us, "The fowls are dull and heavy; they lay very badly; they seem to care for nothing;

they pick food about, but eat little. They have wheat, barley, Indian corn, bread, meal, raw meat chopped fine occasionally, the scraps from the kitchen, and the crumbs from the table. They have food always by them, yet they do not lay. What makes it more tiresome is that a cottage tenant of our's close at hand is successful both in eggs and chickens, though she labours under the disadvantages of small space and scanty food."

They are all fowls alike, but there the similitude ends. They remind us of a scene we once witnessed at an agricultural show. £2 were offered for the servant, being an agricultural labourer, who lived longest with one master. Isaiah Cox, thirty-three years with the Rev. Dr. Primrose—he was a fat, ruddy, wholesome-looking man, of about fifty, dressed in a black frock coat, good cloth waistcoat, white neckcloth, and black shorts. Lest he should be taken for his master, the latter articles of dress were of velvet, and he farther disclaimed the clerical appearance by wearing drab gaiters. Reuben Hanks had the second prize of £1; he had lived thirty-one years with the same master on the same farm. We could but contrast the two: the complacent look of Isaiah, his fair rotundity telling of Sunday roast beef; his full round calves, placing the buttons of his gaiters in jeopardy; and his face free from any wrinkles or furrows that looked at his master, who sat at the table, and said plainly, "See what a treasure you have." Reuben was very different; he was younger than Isaiah, but he looked older; he stooped; his cheeks were thin; he wore very heavy boots; he had no calves to his legs. He was the very reverse of the other. "Are they both agricultural labourers?" asked we. "Yes," was the answer; "but one lives with a good easy parish, who farms ten acres of his own; the other with a man who farms five hundred. That fat fellow has two men under him to do the work of one. He is fat, overfed, and lazy; a day's work would kill him. That lean fellow beside him is the best chap in the parish to work."

Our story is still the same—these men represent the ladies' and the cottagers' fowls. Fancy the obese prize labourer at work on a stiff cold clay, or pitching at harvest-cart. He would lie down and give up. He was incapable of exertion. In truth he was overfed. His master, good easy soul, liked to see all comfortable about him, and, honestly trying to do good, he spoiled every person in his employ. The same is done in poultry. Mary Searle has a cottage about a mile from the Hall. Her fowls run on the green opposite, and down a lane at the side. How smart and firm, and handsome they looked. The cock paced and strutted, and lifted up his foot, curling it proudly and daintily, as though the earth was not good enough for him to tread on; and the hens, what beautifully bright red combs, and what layers they were! Mary always had eggs. When the children from the Hall drove past in the carriage they threw them crumbs. The fowls learned to look for them, and when they heard the wheels they would come from all quarters. Mamma was coaxed to buy them to be pets at the lodge. "What a treat it will be for them," said the children.

The fowls were bought and put at the lodge. All the scraps were saved. Four times every day the children ran to feed their pets. Every morning they went down to look for eggs. It was very delightful to see the fowls coming from the shrubbery to meet the children; and it was pleasing to see each return with the egg that was to form part of the breakfast. But after a fortnight the birds cared little to come. Then they ceased to lay, or layed but seldom. The learned in such matters were consulted. They advised change of food. Then the "wheat, barley, broad, Indian corn, raw meat, and scraps" went to work, and the fowls got fatter, lazier, and more listless every day; while Mary Searle's thrive and laid as well as ever. Moderate feeding is the secret of health. A very fat fowl squats about instead of taking exercise. It ceases to be a pleasure or useful, and it does not take the trouble to seek that natural food which is essential to health.

CLASSES FOR GAME HENS AND PULLETS.

As the attention of amateurs has lately been called to classes at shows, with their relative entries, may I offer a plea for extending classes to Game hens and pullets? These

classes speak for themselves whenever they are met with. At Birmingham, for instance, last year, they were not only numerically strong, but, as regards quality, vain are the hopes of a man who looks for better. At Darlington there were twenty-six entries, and the silver cup was carried off by a pair of Game pullets, beating their male rivals. At Manchester also there was such competition that the first prize was £6, an increase on the generality of classes of above a third. I bring forward these facts to show that they are quite as deserving of a place at our principal exhibitions as Dorkings, and form as great, if not a greater, attraction. I should like to see this taken up by the Agricultural Hall and Crystal Palace Companies, and, as I suppose they will shortly compile their schedules, let them offer as a trial prizes of £2 and £1 to Game hens and pullets of any variety, and I feel no hesitation in saying the call will be attended with success, and will prove beneficial both to the societies and to the poultry world at large.—**FAIRPLAY.**

WIGTON EXHIBITION OF POULTRY AND PIGEONS.

This Show was held in the Odd-Fellows' Hall, Wigton, on the 5th inst., and following day. It is well known to poultry amateurs that the present moment is, perhaps, the most difficult time of any throughout the whole year for carrying out successfully a show of this nature. The best birds of our principal breeders are now busily engaged as breeding-stock, and however forward may be the locality, no chickens are, as yet, sufficiently matured for exhibition purposes. These reasons combined, are, undoubtedly, cogent ones for selecting an earlier or later date for holding such a meeting. Truth, however, compels us to state, that the Show at Wigton seemed to suffer but little from these causes, whilst the entries of this year exceeded those of the preceding by upwards of seventy pens. Yet another somewhat unexpected feature was, that scarcely a single pen was unfilled—a remarkable result, more particularly as regarded the Pigeons, when we consider that most of these birds are now nesting. The Show was beyond doubt a good one; but still another drawback to pecuniary success awaited the promoters of the Wigton Show:—the day was throughout one of the most comfortless imaginable, continuous rain, snow, and sleet falling from daybreak to nightfall. Still, as the room was constantly well filled, the absence of fine weather was less to be regretted.

In the *Game* classes for Black-breasted and Brown Reds Mr. Beldon took the first prize easily, Mr. Brough also exhibiting some very good birds. The class for either White or Piles was very indifferent, and it was in this class alone that any prize was withheld throughout the Show. The Duckwing were good, and the class for a pair of Game pullets (without any restriction of colour), was numerously and well filled. The Honorary Secretary of the Wigton Society here obtained the first prize with Black Reds; the second place being secured by Mr. Addison's very good pen of Brown Reds. The Black *Spanish*, for a Show held so far north, were most creditable; but the *Dorkings* were not so good as might have been anticipated. Miss Aglionby took both the *Cochin* prizes; the first prize with Partridge-coloured, and second with Buff ones. The *Hamburgs* were a good display taken collectively; but it must be always borne in mind, that perfectly-formed rosy combs, firmly set on the head, without any disposition to hang over to either side, are imperatively necessary to success. Some beautiful Red Piles (*Bantams*), were shown, and were among the chief excellencies of the Show. It will not be a matter of surprise to most of our breeders of *Game Cocks*, to find that Mr. James Fletcher, of Manchester, was the winner of both the cups offered by the Wigton Committee, as premiums for the best Game cock and Game cockerel respectively. A really first-rate Black Red was the adult cup bird, and an equally good Brown Red cockerel secured the second cup to the same exhibitor.

The *Pigeons* were, without any question, such as would have added to the renown of even our greatest shows, the *Carriers*, *Powers*, *Almonds*, *Barbs*, *Jacks*, and *Fantails* being excellent. In the class for other varieties of Pigeons

were shown some perfect specimens of Spots, Meeves, Runts, Blue Swallows, and Brunswicks.

The Committee were persevering and attentive, and the Show was, consequently, a success.

GAME (Black-breasted and other Reds).—First, H. Beldon, Gilstead Bingley. Second, J. Brough, London Road, Carlisle. Commended, E. Fearon, the Cottage, Hensingham.

GAME (White and Pile).—First, J. Todd, Waverbridge, Wigton. Second, withheld.

GAME (Duckwing and other Greys, Blacks, and Blues).—First, J. Brough, Carlisle. Second, J. Cowen, Oughterby.

GAME (Any Colour).—First, A. Robinson, Wigton. Second, W. Addison, Oulton. Highly Commended, W. Hastwell, Clifton Station; H. Thompson, Old Hutton, Milnthorpe. Commended, H. Beldon, Gilstead.

SPANISH.—First, H. Beldon, Gilstead. Second, J. G. Park, Highton Hall, Whitehaven. Highly Commended, J. Wilson, Lonsdale Terrace, St. Bees.

DORKING.—First, J. Armstrong, Citadel Station, Carlisle. Second, P. Nixon, Dalston. Commended, P. Nixon.

COCHIN-CHINA (Any variety).—First and Second, Miss Aglionby, the Hollins (Buff and Partridge).

HAMBURGH (Golden-spangled).—First, H. Beldon, Gilstead. Second, E. S. Goodhart, Dalston. Commended, Rev. W. Gordon, the Manse, Ruthwell, by Annan; D. Tait, the Hollins.

HAMBURGH (Silver-spangled).—First and Second, H. Beldon, Gilstead. Commended, J. Hall, Wigton.

HAMBURGH (Gold and Silver-pencilled).—First and Second, H. Beldon, Gilstead. Commended, H. A. Clarke, Aspatria.

ANY OTHER VARIETY.—First and Second, H. Beldon, Gilstead, Bingley.

BANTAMS (Game).—First, R. Thompson, Moresdale Hall, Kendal. Second, Miss Aglionby, the Hollins. Highly Commended, Miss Aglionby; H. Beldon. Commended, Master J. Bell.

BANTAMS (Any other variety).—First, H. Beldon. Second, R. Pickering, Carlisle. Commended, H. Beldon.

DUCKS (Aylesbury).—First, I. G. Park, Highton Hall, near Whitehaven. Second, Miss Kerr, Red Hall. Highly Commended, Rev. A. F. Curwen, Harrington Rectory; J. P. Foster, Killbow. Commended, W. Barnes.

DUCKS (Rouen).—First, M. H. Brisco, Croiton Hall. Second, G. Highfield, Blencogo. Commended, H. A. Clarke, Aspatria.

DUCKS (Any other variety).—First, T. Mauduell, Aikhead. Second, H. Beldon.

PIGEONS.

CARRIERS.—First, W. Towerson, Egremont (Blacks). Second, J. Rumford, Sunderland. Highly Commended, H. Beldon; R. Pickering, Carlisle. Commended, W. T. Armstrong, Carlisle.

TUMBLERS.—First, R. Thompson, Kendal. Second, R. Pickering, Carlisle. Highly Commended, H. Beldon. Commended, J. Rumford, Sunderland; W. Towerson, Egremont; H. Yardley, Birmingham; W. T. Armstrong, Carlisle.

POWTERS.—First, R. Pickering, Carlisle. Second, J. Rumford, Sunderland. Highly Commended, T. C. Taylor, Middlesborough. Commended, H. Beldon; W. T. Armstrong, Carlisle.

FANTAILS.—First, T. C. Taylor, Middlesborough. Second, Jobling, Newcastle. Commended, H. Yardley, Market Hall, Birmingham.

JACOBS.—First, H. Yardley, Birmingham. Second, R. Pickering, Carlisle. Commended, H. Beldon; J. Chambers, Middlesborough.

NUNS.—First, W. Johnston, Carlisle. Second, H. Beldon, Gilstead.

BARBS.—First, H. Yardley, Birmingham. Second, W. T. Armstrong, Carlisle. Commended, H. Beldon; T. C. Taylor.

TURBITS.—First, E. Thompson, Kendal. Second, T. C. Taylor. Highly Commended, W. Towerson, Egremont.

OWLS.—First, R. Pickering, Carlisle. Second, W. Towerson, Egremont. Highly Commended, Jobling, Newcastle. Commended, R. Thompson, Kendal.

ANY OTHER VARIETY.—First, H. Yardley, Birmingham. Second, Jobling, Newcastle. Highly Commended, R. Pickering, Carlisle; Jobling, Newcastle. Commended, H. Beldon, Gilstead; M. Irwin.

EXTRA PRIZES.

BEST GAME COCK.—First and Second, J. Fletcher, Stoneclough, near Manchester. Third, W. Boyes, Beverley, Yorkshire. Highly Commended, J. Gaddes, Carlisle; Adams, Beverley, Yorkshire. *Cockerel*.—First, J. Fletcher, Manchester. Second, J. Brough, Carlisle. Third, Adams, Beverley, Yorkshire. Highly Commended, W. Boyes, Yorkshire; J. Brough, Carlisle. Commended, J. Brough, Carlisle; J. P. Foster, Killbow, G. Studholme, Moorrow.

HAMBURGH (Golden-spangled).—A Silver Cup presented by Mr. Hall E. S. Goodhart, Dalston.

Mr. Edward Hewitt, of Sparkbrook, near Birmingham, officiated as Judge.

ATHERTON AGRICULTURAL ASSOCIATION.

The Show was held on the 31st ult., when the following prizes were awarded for poultry:—

GAME COCK (Any variety).—First, W. Brierley, Middleton. Second, S. Foulds, Atherton.

GAME.—First, C. W. Brierley, Middleton. Second, T. Ridgway, Atherton. Highly Commended, C. W. Brierley; W. Gillibrand, Tyldesley.

SPANISH (Black).—First and Second, N. Cook. Highly Commended, N. Cook; J. Kilshaw, Atherton.

COCHIN-CHINA (Any colour).—First, J. Elliott, Westleigh. Second, E. Smith, Middleton. Highly Commended, J. Elliott; E. Smith, Middleton.

DORKING.—First and Second, J. Fryer, Liverpool Road, St. Helens (considered to be the best pen exhibited). Highly Commended, E. Smith, Middleton; P. Wood; S. Farrington. Commended, W. Hulston; S. Farrington.

HAMBURGH (Golden-pencilled).—First, J. Haselden, Great Boy's Colliery, Tyldesley. Second, W. Horrobin, Atherton. Highly Commended, T. Wrigley, jun., Tonge, near Middleton; H. Leigh, Willow's Cottage, Bedford. Commended, C. W. Brierley, Middleton.

HAMBURGH (Silver-pencilled).—First, E. Crompton, Over Hulton. Second, J. Platt, Dean.

HAMBURGH (Golden-spangled).—First, N. Marlor, Denton. Second, G. Whittaker, Horwich. Highly Commended, C. W. Brierley, Middleton; P. Unsworth, Lowtoe; M. Kay, Wallsucha, Horwich.

HAMBURGH (Silver-spangled).—First, M. Kay, Horwich. Second, J. Haselden, Tyldesley. Highly Commended, N. Marlor, Denton. Commended J. Haselden; Mrs. Withington, Calcebeth.

POLANDS (Any colour).—First and Second, S. Farrington.

ANY OTHER VARIETY.—First, H. Lacy, Hadden Bridge, Yorkshire. Second, N. Cook. Highly Commended, E. Smith. Commended, J. Elliot, Westleigh.

BANTAMS (Game).—First, C. W. Brierley, Middleton. Second, J. Croft, Atherton. Highly Commended, E. Seddon, Atherton.

BANTAMS (Any other variety).—First, C. W. Brierley, Middleton. Second, N. Marlor. Highly Commended, C. W. Brierley.

DUCKS (Aylesbury).—First, E. Leech, Rochdale. Second, A. Ballough.

DUCKS (Reuten).—First, E. Leech, Rochdale. Second, W. Gregory. Commended, C. P. Ackers, Bickershaw.

DUCKS (Any other variety).—First, C. P. Ackers. Second, C. W. Brierley. Highly Commended, J. Wakefield, Golborne; C. W. Brierley.

GESE (Any breed).—First, L. Wall, Westhoughton.

TURKEYS (Any colour).—First, C. W. Brierley. Second, E. Leech, Rochdale.

The Judge was Mr. R. Teebay, of Fulwood, near Preston.

THE WINTER AND OPENING SPRING OF 1864.

AN INSTANCE OF EARLY BREEDING.

THE close of the past season found my apiary, both as regards population and provisions, everything that could be desired. The greater number of my hives, especially such as were not artificialised, were densely populated. The winter has been a comparatively mild and open one, and the consumption of stores has consequently been above the average. From the end of January the weather has been very cold and ungenial, the month of March, especially, being exceedingly unpropitious for bees. So inclement has been the opening spring, that it was so late as the 20th of March before a single loaded bee was seen to enter any of my hives. Vegetation is considerably behind this season, and breeding much retarded.

My especial object in this communication is to record one of the earliest instances of breeding which ever came under my notice, and I beg to draw the particular attention of minute scientific observers to the fact, in order to elicit their experience in the matter. Strange as it may appear, it occurred in a hive neither very populous nor very healthy.

The queen of this hive is a Ligurian one, and was artificially reared towards the close of last summer; but her fecundation having been considerably retarded through adverse circumstances, which I need not here relate, the population at the close of the season, though numerous enough, yet lacked a preponderance of that youthful element which I consider so essential to a good keeping winter stock. The intelligent apiarian will understand the force of this remark by a consideration of the short-lived existence of the honey bee, which I may here state I have been enabled thoroughly to test during my first year's experience of the Ligurians. As the true knowledge of the longevity of the bee is a matter of more importance to the bee-master than is generally supposed, I shall, perhaps, at a future time make it the subject of a separate communication.

In addition to the above unfavourable condition as to population, there was another which operated adversely on the colony in question. It was domiciled in a glass hive. Now it is, perhaps, familiar to most apiarians that a hive either not very populous or one domiciled within glass walls, is much more apt to become diseased by long confinement than others more favourably circumstanced. The reasons of this I will not now farther explain than to say that they are in some measure connected with a solution of that theory first propounded by the Swiss apiarian, M. de Gelieu, that an increase in the population of a hive does not produce an increase in the consumption of stores.

Throughout the early part of winter I noticed symptoms of unhealthiness in this hive. The bees assumed a swollen appearance, and the colony was even then being gradually diminished by deaths and the desertion of such as were much afflicted by the retention of their fæces. By the middle of January I observed, through the glass panes, a marked diminution in numbers. Being a frame-hive I determined to examine it, and to unite to it a few bees belonging to a reserve queen kept over for spring contingencies. Accordingly on the 18th January, I took the hive into a warm room, and minutely examined every frame. The bees were still more numerous than I anticipated, but it was

evident from the internal appearance of the hive that they were much afflicted by dysentery. The queen I found most lively—so much so, indeed, that she escaped out of my hands and took wing to a distant corner of the room, and so completely eluded my search for her that I almost despaired of recovering her alive. At length, observing a bee enter a little crevice beneath a press door, I opened it, and found her majesty surrounded by a few faithful adherents that had found her out or accompanied her into this curious retreat.

But what struck me as very remarkable in my examination of this hive was, that a considerable portion of a comb was found filled with brood in all stages—eggs, grubs, and sealed larvæ, and several young bees traversing the combs. Having joined a few hundred common bees to the colony, I replaced the hive in its old site.

From this it will be seen that the queen of this hive actually commenced egg-laying in the dead of winter, or so early as Christmas. This, as I have already stated, is the earliest instance which ever fell under my observation.

Most of our writers lay down the end of January or beginning of February as the commencement of the breeding season. Wildman says if the month of January be mild the queen may be induced to lay. Bevan states, that in similar circumstances breeding will sometimes commence at the latter end of January or beginning of February. Huish affirms that the ovarium of the queen is entirely empty during the winter months, and the earliest period that he ever knew of the appearance of an egg in it was the 20th of January. Sir W. Jardine mentions February as the time when the queen resumes egg-laying; and, indeed, most English authors, so far as my recollection goes, give forth similar opinions. These opinions, though no doubt mostly formed more from outward observation than from internal examination of the combs, are, nevertheless, in accordance with the known facts of the case. This is certainly the usual period, but earlier instances, similar to the one now related by me, have been noticed by foreign naturalists. The celebrated Huber—that prince of apiarians, whose sagacity of research, accuracy of experiment, and important discoveries, have placed him on the very pinnacle of apiarian science—mentions, in his "Natural History of the Bee," that he found brood of all stages in certain hives in the month of January, when the thermometer stood in the interior at about 93°. So, also, the celebrated French naturalist, M. de Reaumur, found brood of all stages in some hives in the same month. Still these must be considered as exceptional instances; and, for my own part, I am not inclined to view such premature exhibitions of breeding on the part of the queen as at all indicative of future prosperity—indeed, I am disposed rather to look upon everything of an abnormal character in the bee community with an unfavourable eye. In the present case I find that the hive in which this instance of early breeding took place is not an exception to the general rule; for it has turned out to be, as I expected, the weakest in all my apiary; the bees having still further diminished, and not one-third the number of brood-filled cells can now be seen as were found in it more than ten weeks ago.—J. Lowe.

OUR LETTER BOX.

HENS WITH SWELLED HEADS (K. R.).—The swelling at the back of the head would naturally expose the white of the eye by stretching back the skin. The feeding is bad, being far too stimulating, and the broth they have to drink is quite unnecessary. It is very likely that, in the heated state of their bodies from over-feeding, the natural use made of the poll at this time of year has caused a swelling that would not have appeared had they been in ordinary health and feeding. Give them less stimulating food, and less in quantity.

EGG-EATING FOWLS (A. W. C.).—Nothing is more difficult than to cure fowls of eating eggs when they have once taken to it; it amounts to a disease. It is almost waste to allow such to sit; but, if allowed at all, they should be permitted to steal their nests. The only thing that can be tried is to put them on a nest filled with composition eggs. They peck till they are tired, and, finding it useless, sometimes abandon the habit. We would get rid of such birds at once.

DIARRHEA IN A DORRING COCK (J. F. Sinclair).—The enlarged liver proved where was the seat of the disease. The weight (1 lb. avoirdupois) was enormous. It is impossible to say what the cause was. If it was to the touch like butter, it was a fat liver, and would arise from over-feeding and want of exercise. If it was hard and stony, it was simply a diseased liver, which must end in death, but the cause of it is unknown. The use of Indian corn exclusively as food is, we believe, conducive to disease; and the want of a grass run equally so.

DAHLIA FLOWERS AND BEES (H. S. A.).—We are not aware that dahlia flowers are injurious to bees, we do not think they gather honey from them.

WEEKLY CALENDAR.

Day of Mnth	Day of Week.	APRIL 19—25, 1864.	Average Temperature near London.			Rain in last 37 years.	Sun Rises.	Sun Sets.	Moon Rises.	Moon Sets.	Moon's Age.	Clock after Sun.	Day of Year.
			Day.	Night.	Mean.	Days.	m. h.	m. h.	m. h.	m. h.	m. s.		
19	TU	Apple flowers.	58.1	35.0	46.5	8	57 4	1 47	36 4	35 3	13	1 0	110
20	W	Swallow and Queen Waaps appear.	59.6	34.8	47.2	14	55 4	3 7	43 5	56 3	14	1 13	111
21	TH	Nightingale sings.	58.6	37.1	47.8	14	53 4	4 7	52 6	20 4	15	1 26	112
22	F	Hornbeam flowers.	58.3	37.6	47.9	20	51 4	6 7	2 8	48 4	○	1 38	113
23	S	Beech foliates.	58.3	37.0	47.6	20	49 4	8 7	9 9	20 5	17	1 50	114
24	SUN	4 SUNDAY AFTER EASTER.	58.2	35.9	47.1	15	47 4	9 7	13 10	59 5	18	2 1	115
25	M	ST. MARK. PRINCESS LOUIS OF HESSE BORN, 1843.	59.1	37.6	48.3	16	45 4	11 7	12 11	47 6	19	2 12	116

From observations taken near London during the last thirty-seven years, the average day temperature of the week is 58.6°, and its night temperature 36.4°. The greatest heat was 80°, on the 25th, 1840; and the lowest cold, 18°, on the 24th, 1854. The greatest fall of rain was 1.40 Inch.

CULTURE OF THE PINE APPLE.

(Continued from page 260.)



SOIL.—The soil which I prefer for Pines is that which is known among gardeners as a friable turfy loam, rather of a sandy than a clayey texture. The top six inches of an old pasture, inclusive of the vegetation on its surface, should be collected when in a dry state, and stacked in a compost-yard for twelve months, and a few

months previous to its being wanted for potting it should be put into an open shed to become tolerably dry. This, simply chopped up with the spade, or teased with the hand, with about an eight-inch potful of crushed bones, and as much soot, to each barrowful of the turfy loam, is all that finds its way to our potting-bench for Pines. I have a great dislike to those mixtures of three or four sorts of animal excrement which I have sometimes known to be used. Any admixture which has the slightest tendency to become soured or compressed is contrary to the nature of the Pine, and fatal to healthy root-action. To anything in the way of dung this applies; and there is, besides, the great inducement for worms to enter the pot, revel in the soil, and reduce it to a mere putty. In shifting Pines I always observe the most healthy and active roots in the most fibry portions of the soil, and a sound turfy loam I regard as the best medium for supplying nourishment in a liquid state.

SUCKERS.—In proceeding to give a general sketch of the more minute points of Pine-culture I will suppose a batch of suckers to come under treatment about the end of August or early in September—the time when, generally speaking, suckers are in a fit state to be taken from stools which have produced the summer supply of fruit. First, then, let the suckers be carefully detached from the parent plant; cut the rugged base smoothly off with the knife, and remove with the finger and thumb those short scaly leaves which cluster round the base of the young plants, and under which appear the embryo roots. The leaves should not be removed any higher up the stem than where these young starting roots are of a brownish hue. As this operation is proceeded with the suckers for convenience should be classed in two lots, the smallest and the largest being placed by themselves; the largest set, presuming they are strong and healthy, to be potted into seven or eight-inch and the smallest into six-inch pots. The pots if not new should be well washed and efficiently crooked. Over the crocks should be placed a thin layer of moss or the most fibry part of the loam, and over all a sprinkling of fresh soot, which

acts as a barrier to worms, and at the same time affords a stimulant to the plants.

In potting the suckers place them sufficiently deep in the soil to keep them firm and steady in the pot, and press the soil as firmly as it can be made with the hand, leaving the soil about three-quarters of an inch from the rim of the pot, so that there may be no difficulty in watering them when such is necessary. It being presumed that a pit was previously made ready for their reception, let them be plunged to the rim of the pot; and if the temperature of the bed, should the heat be from leaves or tan, is not likely to exceed 85°, press the tan tolerably firm round the pot. Avoid crowding the young plants together, for there is nothing more injurious than crowding young plants too much. If they become drawn and weakly in their early stages of growth it is not easy to make good plants of them afterwards. They must now be shaded from the sun during the hottest part of the day for ten days or so, or, in fact, till it be found that they are making roots; and in the afternoon, when the shading is removed, they should have a gentle dewing overhead through a very fine rose. This shading and bedewing overhead must be discontinued by degrees, and entirely given up when the roots reach the sides of the pot, when the plants should have a watering at the root, enough to moisten the whole ball. After this they soon show signs of growing freely, and air should be given early in the day, which, with as much light as is possible and a moderately moist atmosphere with a very sparing use of the syringe, will prevent them from making a weakly drawn growth.

The night temperature for September should range from 65° to 70°, with 10° or 15° more when shut up with sun heat in the afternoon. After the middle of October the temperature should be 5° less, and after that it should gradually decrease till at the middle of November it be 55° at night and 60° by day. From the time the suckers are potted the great object is to obtain a sturdy well-matured growth, such as will stand the rigours of winter with impunity, and form a good foundation for rapid and vigorous growth in spring. Such a condition is dependant upon a free exposure to light, plenty of air without draughts, and not overmuch moisture or heat, either at the root or in the air.

During October the bottom heat should not range higher than from 75° to 80°. This is much safer than a higher degree, and 5° less will be quite sufficient to keep the roots healthy in winter. In olden times, when every sucker potted in autumn was deprived of its black and lifeless root in spring, I believe in many cases such an operation was considered necessary, from the root having been destroyed by too much bottom heat from too frequently renewed beds of violently-heating materials; and in ignorance of the heat that the roots of Pines will bear with impunity, it was considered that Pines lost all their autumn-made roots in the common course of nature. This idea, however, has been long ago exploded, and the good Pine-grower of the present day is not satisfied if, when September-potted suckers are shifted in March,

their roots are not white and full of life, instead of black and shrivelled.

Under ordinary circumstances I would recommend that from the middle of November till the middle of February the suckers now being treated of should be kept quiet, and not encouraged to grow; and to rest them thus a temperature of 55° at night is preferable to 60°. The atmosphere should be dry rather than otherwise, and little or no water should be given at the root, as the soil in the pots will generally be found to be regulated as to moisture by the state of the tan or other plunging material, which is generally moist enough for the maintenance of Pine roots in a healthy state. Under ordinary circumstances this is the winter treatment to be recommended as that which will give plants in a strong and healthy condition in spring, and that will most surely make the best fruiting stock by the following autumn. But in cases where, from scarcity of intermediate stock, it is desirable to considerably increase the size of the plants and steal a march on time, they may be kept gently on the move all winter by a temperature 5° or 8° higher, with more moisture at the root and in the air. This winter growth, however, can only be adopted with anything like success when good light pits are at command, and where every ray of sunshine can be had during the winter—say, for instance, when strong fine suckers can be had in the early part of August, and which it may be desirable from a paucity of more advanced stock to push on for supplying fruit in the winter of the next year, then they may be grown on all winter, and be rested in April and May previous to their being started for winter fruit. But when such suckers are not required till the following spring, they will make all the finer plants by being rested in winter as I have described, and the results will be all the more satisfactory.

(To be continued.) D. THOMSON.

NORTH AMERICAN TERRESTRIAL ORCHIDS.

(Concluded from page 265.)

ALMOST all the North American species delight in a compost of turfy loam (about 4 inches of the surface of a rich and rather moist pasture laid in a heap in the sun and frequently turned over for twelve months), one-third, sandy but fibry peat one-third, and leaf mould (from oak or beech leaves), partially decomposed another third, the whole to be well mixed and chopped with a spade, sand being added if the compost does not present unmistakable evidence of its presence.

The compost should be in nice working order when used either for potting or placing in the beds for planting, so that it will not bind when pressed owing to the wet, nor be so dry that repeated waterings are necessary to moisten the mass. The right condition is the mean of the two extremes.

The most suitable time for potting is just when the plants are on the move, and this can only be determined by actual observation, for it depends in a great measure on the season and the species. In potting much of the old soil should be carefully picked away; and if the plants are too large to be convenient, or if any increase is desired, it is preferable to perform that operation then. This is effected by cutting with a sharp knife the strings that connect the young plants with the parent roots, taking care not to wound any part of the tubers, for this is sure to cause diseased roots. The less these plants are handled the better, for no plants are so sensitive of disturbance and show more marked effects if their tender roots and fibres be injured. Bear in mind that the larger a plant is the better cultivation is shown. Division of the roots should, therefore, be only practised for the purpose of increasing the stock. Clean pots, inside and outside, should only be employed, and these vary in size according to the size of the plants. If the plants have increased in size a larger pot will be required, but if no increase in size be perceptible, one of the same size will do again. If, on the other hand, the plant has decreased in size it should be placed in a pot no larger than sufficient to contain it comfortably. None of the pots should be larger than sufficient to hold the plants without cramping the roots. The pots being drained to one-third of their depth with crocks, the larger at the bottom and the smaller above, place a thin layer of sphagnum or cocoa-nut fibre on the

crocks, then a couple of inches of the rougher parts of the compost, and an inch or more of general compost on that. The plant being introduced and sufficient soil added to bring the crown to within half an inch of the level of the pot-rim, place the compost round the ball, pressing it lightly, covering the crown half an inch with soil, but leaving a cavity for watering purposes to the extent of half an inch at the sides of the pot, or the centre elevated above the rim. Water cannot thus rot the crown owing to the frequency of the watering. Give a gentle watering and set them in the frame, plunging the pots to the rim in the ashes, and at the back or front as the size may determine.

Air will be necessary in all weathers except when the temperature is below freezing; ventilation must be afforded these plants day and night alike, or they will soon become sickly. The lights will be better drawn down by day, and at night, too, in mild weather, drawing them on only on frosty nights and when heavy dashing rains occur. They will, therefore, enjoy the refreshing influence of gentle showers of rain, and the dews of night, and this combined with fresh air is the grand secret in growing these rare plants. Whenever it is necessary to put on the lights to guard against heavy rain, they should be tilted back and front to create a free circulation of air. At no time ought the plants to become dry, for they do not owe their rest to dryness, but decrease of temperature. At rest they should be kept moist, but less water must be given them than at any other period: in fact, none will be required if the pots be kept plunged as they ought to be. In the early stages of growth they will need very careful watering, but enough should be given to keep the soil moist, but not wet, and under no circumstances should they be allowed to become dry at the root after growth has commenced. If that occur growth is effected at the expense of the delicate fibres, and weakened tubers and roots are the consequence. When the plants are in full growth copious supplies of water will be necessary; but when this is past, and the leaves do not increase in size, the watering will require to be gradually diminished, and it should be discontinued when the leaves turn yellow.

During the period of rest the plants should be kept in as uniform a temperature as possible. The lights should be drawn off by day in mild weather, and some mats or other covering thrown over them in severe periods, the sides of the frame being also protected by placing ashes against them or some litter. If it were possible to keep the plants in a cellar with a constant temperature a few degrees above the freezing-point, I am certain that that would be the best place for them for three months at the dullest period of the year, for success in their cultivation depends on a complete state of rest, and another corresponding period of free growth.

In borders these plants should be planted when in a state of rest, a little before or when on the point of starting into growth. They require pretty nearly the same attention as to watering, &c., as those in pots. I will, therefore, briefly allude to a few points in which the treatment differs. In the first place they will not require so much attention as regards watering, at the same time measures must be taken to shield them from rains and severe frosts. To guard against the former, stakes should be driven into the ground at a distance of 6 inches from the bed, on all sides, and left 2 feet above the surface. These stakes are intended to support a kind of span-roof, formed of laths, over which some glazed calico can be spread when heavy rains occur, and this will be found effectual for the purpose, and a material protection in winter against rain and snow. In summer the cover will protect the plants from drenching rains, and at the same time afford a free circulation of air from all points. Besides, when the plants are in flower this covering placed over them will much prolong their beauty, especially if a piece of tiffany be hung against the upright side next the sun. Now, this protection is only for shielding the plants from heavy rains, from sun when flowering, and in winter from rains and snow; at other times it should be taken off, and the plants exposed to the full influence of the atmosphere. The beds will need to be frequently stirred to keep them free of moss; water must be given when necessary, but not in excess, so as to cause a sour condition of the soil, and all weeds should be removed by hand-picking.

In autumn after the leaves have decayed the beds should be covered with 3 inches of dried leaves, some small stones being placed on them to prevent the wind blowing them away. This mulching assists in maintaining a uniform temperature in the soil, and with the oiled calico frame is all that is required to keep them dry and cool and yet prevent them from becoming frozen at the most precarious period of their growth. The calico frame should be kept over the bed when snow falls, and not be removed or the snow brushed off it so long as the frost and snow continue.

In spring the leaves placed over the bed should be removed before the plants start into growth, and the surface pointed over carefully with a small fork, taking care not to go so deep as to injure the roots. If a little fresh soil were added it would materially tend to invigorate the plants. At the end of two years the bed will need renewing, and this is the greatest drawback to growing these plants in beds, for it is scarcely possible to move them without causing more or less injury. It must, however, be done, and in order to effect the removal safely the plants at one end should be taken up for the space of a yard and placed in a basket, covering them with mats to protect them from the air. The old soil should then be removed and some fresh put in its place, taking up the plants as they rise in the old bed, and replanting them in the new compost, and so on until the whole of the soil is renewed and the bed replanted, those in the baskets being planted at the opposite end of the bed. These plants, being impatient of disturbance or frequent shifting, should not be removed so long as they continue to grow strongly, nor must they be in any wise roughly handled.

In conclusion, I would out of a love for these and other curious plants say a few words about a kind of disrespect shown by the Royal Horticultural Society to those amateurs who are well known to be the almost exclusive cultivators of hardy Orchids. I allude to there being no prize offered for such plants in the Society's schedules, whilst hundreds of pounds are yearly lavished on exotic Orchids, chiefly such as can only be grown by those possessed of great wealth, and which are not half so difficult to cultivate as the terrestrial species now under consideration. What should hinder the Society giving a prize of £10 for twenty hardy Orchids, another £10 for the best collection of rare and well-grown alpine plants? It would surely be as reasonable as spending nearly £50 on their epiphytal brethren—a sum which is annually given to the same exhibitors for the same plants. Were those in authority as anxious to give an impetus to skilled cultivation as they are to throw money away in cultivating a taste for the fine arts, they would more fully carry out the objects of what should be the first horticultural society in Europe. The main object of such societies should be to promote high cultivation in every sense of the word, and to offer prizes for plants that are difficult to cultivate. Prizes for such plants are only what are needed as a reward for the perseverance and skill of a number of amateurs who devote their leisure to cultivating them.

Our correspondent will find much valuable information on the cultivation of hardy Orchids in Vol. XXIV., pages 342, 359, 370, and 387, by an enthusiastic cultivator, whose views are embodied in the "Orchid Manual," published at the office of this Journal. It is only due to a previous grower and writer to say that it is the best and only work on the subject ever published. I may at some future time say a few words on the cultivation of British Orchids. G. ABBEY.

SALE OF JAPANESE PLANTS.—The agreement between Mr. Fortune and Mr. Standish having nearly expired, Mr. Stevens has been instructed to dispose of the remaining portion of the valuable Japanese plants brought home by Mr. Fortune. The sale is to take place on the 11th of May, and will doubtless excite much competition, as amongst the novelties to be disposed of are Clematis Fortuni, with magnificent double white flowers, and which was figured in the "Florist and Pomologist" of December last; and Clematis Standishii, with rich violet purple flowers. Among hardy evergreens we understand that several of the highest merit are to be offered, such as the male Aucuba, the variegated and green-leaved varieties of the Holly-leaved Osmanthus; two Skimmias, one of them with very sweet-scented flowers, and the other with broad leaves and berries twice as large as those of

the common kind. Both of these, being free growers, will be valuable for shrubberies. Lastrea Standishii, too, will also doubtless be much sought after, as it is a remarkably handsome species, with graceful, pea-green, much-divided fronds; and is, moreover, probably hardy, for it has withstood without injury several degrees of frost. In addition to the above many curious varieties of Maples, with leaves variously cut and variegated, and several other objects of interest, are to be offered.

FLOWERS OF THE PAST SEASON.

HOLLYHOCKS.

Is there a place for the Hollyhock in the bedding-out system? I fear not: but I am sure there is in the gardens or shrubberies of all those who desire effect, and who admire large and gorgeous masses of bloom; while there are, Mr. Chater doubtless can testify, numbers who own the soft impeachment of unbounded affection and love for it. I remember that at the last autumn Show at the Crystal Palace one enthusiastic amateur would be satisfied with nothing less than a national exhibition of the flower. "If a national exhibition of Tulips, and Auriculas, and such gimcracks, why not of this noble and magnificent autumnal flower?" What could I, a lover of one of these "gimcracks," say against such a proposition? and as it, amongst other flowers, has received the cold shoulder from the Royal Horticultural Society by the abolition of the September Exhibition, it is not unlikely that some such notion may be carried out. As for me, I have neither a geometric garden nor a shrubbery. I grow flowers for their own sake, am content to admire them without "effect" and "contrasts" (all very desirable and nice for those who have the capabilities, but utterly beyond my poor efforts); and as, amongst other things, I grow some few Hollyhocks, and these the newest of those in growth, I have thought that amongst the flowers of the past season they deserve a notice.

Although there are many raisers and growers of this flower, yet it is to Mr. Chater, of Saffron Walden, Messrs. Downie, Laird, & Laing, of Stanstead Park Nursery and Edinburgh, to whom we now mainly look for new varieties; the former raiser especially devoting to them the experience and skill which many years of successful cultivation have given him; and when one remembers what the Hollyhock was and what it now is, we may well wonder at the rapid improvement made in it. Flowers with stiff and large guard petals, and a centre entirely filled with a half-circle of densely packed petals without any pockets or gaps, and of the most brilliant and delicate colours—glowing crimson, black, pink, rose, yellow, white, orange, &c., and densely packed in a spike sometimes 3 feet in length, form a floral picture which few things can rival, fewer still exceed; and where there is the advantage of shelter from high winds (for their height renders them liable to damage from these), and a tolerably rich soil, they may be well grown. It so happens that I have one little corner thus situated, and I am consequently enabled to do what "rude Boreas," who presides over our locality, would inevitably hinder me from doing, and grow from year to year some very tolerable flowers. To those who would desire to grow them I would recommend as good and cheap flowers the following:—

Sylvia, rose; David Foulis, rose; Beauty of Walden, carmine; Rosy Gem, rosy carmine; Augusta Bland, peach; Carneia, flesh; Mont Blanc, white; Candidissima; President, scarlet salmon; Warrior, crimson; Walden Gem, crimson; Illuminator, scarlet; Black Knight, black; Diamond, apricot; Yellow Defiance, yellow; Premier, salmon buff; Miss Ashley, fawn; Canary, yellow; Miss Lizzie King, yellow; Agenora, mauve; Purple Prince, purple; Tyrian Prince, rich crimson; Loveliness, shaded grey; and Rhea Sylvia, shaded rose.

There are better flowers amongst the newer varieties, but these are all reasonable in price and good in quality. And now for the newer flowers.

MR. CHATER'S.

Countess Russell.—This is a large and bold-looking flower of medium height. A beautiful rosy peach, the spike full, and in all respects a fine flower.

Euphrosyne.—Deep blush; flower close and compact; the spike full. Medium growth.

Emblem.—French white, shaded at the base; spike close and compact. A tall-growing variety, but very striking.

Governor-General.—Bright cerise scarlet, with large flowers. Of excellent shape and good habit; in all respects excellent.

Glory of Walden.—Large full flower, of a bright vermilion scarlet, and having a very noble appearance on the plant. Medium height.

Gem of Yellows.—A very fine yellow, without any pockets, and bright in colour. One of the best, if not the best, yellow in cultivation.

Hesperis.—A curiously coloured flower, marbled and veined rose shaded with purple. Very novel in appearance and very good in shape.

Imperator.—Large and bold salmon-coloured flower. Of medium height, good habit, and altogether extra fine.

Incomparable.—A shaded cream; spike close and compact, and habit good. Of medium height.

Lady Paxton.—A delicate flesh-coloured variety. Of excellent substance; centre entirely without pockets; guard petals good.

Ne Plus Ultra.—Bright rosy lilac. Beautiful shape and excellent substance; large and full.

Princeps.—Rosy purple, shaded with lilac. Quite novel, and in every respect good. It is one of the tall-growing varieties.

Dulcis.—Pure white, violet base. A very fine flower; of excellent form, habit, and substance.

Rose Celestial.—A very brilliant rosy carmine flower, with beautiful centre and fine broad guard petal. Tall in growth and effective.

Royal Scarlet.—Intense crimson scarlet. Exceedingly bright, very effective in the spike, and altogether first-rate.

There were some others sent out by Mr. Chater, but I have not seen them; these I have, and from day to day under my own eye, and I do not think that any of these now named are second-rate flowers.

MESSES. DOWNIE, LAIRD, & LAING.

Alexander Shearer.—A large bright crimson of a deep shade of colour. Flowers very compact, and the outline good.

J. B. Ullett.—A bright rosy crimson, of a large size; spike very fine.

Mrs. Balfour.—A shaded flower, crimson with salmon. A bright flower, with fine spike.

Stanstead Rival.—A superb and highly finished flower. Of large size, regular form, and excellent substance. Without doubt one of the finest Hollyhocks in growth.

I had not an opportunity of seeing any others from those raisers whose flowers run so close a competition with Mr. Chater's; but I think that the kinds which I have named are well worthy of growth and will adorn any collection.

It is hardly needful to say much on the subject of cultivation. They require well-trenched good soil, and during the summer season will thrive well in even a very damp situation. Not so, however, in winter. They should, if suffered to remain in the ground, have a good deal of sand placed round the crown; but all good growers advise them to be propagated every year in the same way as Dahlias. They should be planted out in the present month at about 3 feet distance from one another, and in rows 4 feet apart. Not more than three or four spikes should be allowed on a plant; and the flowers on the spike should be thinned out, and the top of the spike taken off when it has attained the height desired.—D., Deal.

ARTIFICIALLY IMPREGNATING THE VINE.

I do not know whether gardeners in general pay sufficient attention to artificially impregnating their Vines. Some of the best varieties are uncertain, others are shy setters, and will well repay any labour bestowed on them in this way.

My attention was first directed to the importance of this subject about five and twenty years ago. I then lived in a place near Edinburgh, where I had charge of the forcing-houses. In one of the houses an unusually strong Vine of the Black Morocco was then growing, which had, with the

others, been planted many years before. I was informed that it had never produced a crop. Year after year it showed fruit abundantly, setting only a very few berries in each cluster. This suggested the question, Can nothing be done to remedy this defect?

The first year I had to do with these houses the fruit set on this Vine as formerly, very imperfectly. The second year it was agreed that an attempt should be made to impregnate its blossoms, and this was gone about in the following manner:—The Vines being in flower, about midday, and while the sun was shining, a large newspaper was procured, and two men employed to spread it out, and hold it close beneath a cluster in full flower. A third party struck the upper part of the fruit-stalk, by springing his finger against it, thus causing it to discharge a cloud of pollen, which fell on the paper beneath. This was repeated a number of times with other bunches till a sufficient quantity of pollen was secured. The paper was then held beneath a bunch of the variety to be operated on, observing that it also was in full flower. The pollen was then collected near the centre of the paper, and by striking it sharply from beneath with the hand, a cloud of pollen was made to surround the cluster to be operated on. The process was repeated till all the clusters on the Vine were impregnated.

The result was highly satisfactory, the berries set as freely as Black Hamburgs, large bunches and berries being produced.

The Vine having been so long unproductive, had accumulated an unusually large amount of nutritive matter, and was thereby enabled to mature a large crop of fine fruit.

This experiment impressed on me very strongly the great advantage to be derived from impregnating all the varieties of Grapes which set imperfectly, and which in my practice I have often since verified.

Most gardeners are aware that even under very favourable conditions, Muscat of Alexandria, Canon Hall Muscat, Muscat Hamburg, Black Morocco, Black Damascus, and other varieties, either occasionally or generally set their fruit imperfectly. To guard against this, they should always be impregnated, the process as described above being extremely simple, and occupying very little time. I never have the slightest difficulty in getting any variety of Grape to set abundantly, and make it a rule to impregnate all those of which I have any doubt of their being free setters.

The importance of a high temperature—say from 70° to 75° at night, with a corresponding temperature during the day, is well understood. The atmosphere should also at this period be kept somewhat drier than usual. To be successful these conditions must always accompany artificial impregnation.—ARCHIBALD FOWLER, *Castle Kennedy, Stranraer, N.E.*

ORCHARD-HOUSES.

Owing to changing that dark place in the "north" for a more salubrious and clearer atmosphere in the Principality, my copy of THE JOURNAL OF HORTICULTURE did not reach me as usual on the day of issue; nor should I have learned that my remarks on Orchard-houses had met with a somewhat severe handling at the hands of Mr. J. R. Pearson, Chilwell, had not a friend directed my attention to it as I journeyed to what may in future be considered the place I write from. However, the Number for March 29th is before me, and at page 246 I find the communication in question, and beg to reply to some of Mr. Pearson's observations.

Mr. Pearson complains of correspondents not giving their places of abode in addition to their names, and points to me as an instance. I had no idea that there were many readers of this Journal ignorant of my place of abode; nor do I see why Mr. Pearson should not know my place of abode from the name any more than I should not acknowledge Chilwell to be in Notts. Then my house was radically wrong. It was not wide enough, the sides too high, the paths sunk, it was covered with old lights, and so on. Will Mr. Pearson tell me where, in Mr. Rivers's "Orchard-House," it is that the author states the house should be built with glass sides to nearly the ground level, the house and paths above instead of below the surface of cold wet soils, the construction such as would enable me or others to kill aphids before or after the blossoms expanded? Does he not recom-

mend boarded sides to the roof, the paths to be sunk, and say that the shrinking of the boards creates a delightful atmosphere? It is all very well to say that my house was wrong, but is it not such as you recommended for growing fruit trees in pots, and stated that by doing so I should be successful? I admitted that the house was covered with old lights, and I stated that these lights were sufficient to afford light and shelter when the house was heated for the production of Peaches, Nectarines, and Vines, but the light was not sufficient when it was not heated.

I repeat that orchard-houses in the north are a complete failure as regards Peaches and Nectarines, Vines and Figs, not only in houses constructed with glass sides, brick walls 2 feet above the surface, and a roof glazed with squares 20 inches by 15 inches, but in those of humbler pretensions, and these were those we were to employ for the purpose of growing Peaches, Nectarines, Vines, and Figs. Unheated orchard-houses are not equal to heated walls in the northern parts of our island for the production of Peaches, Apricots, Grapes, Figs, and Nectarines. Good large Peaches and Nectarines have been grown on walls in that north about which Mr. Pearson is so alarmed; and there are places now in that smoky, cold, wet district that have nothing to rely on to produce Peaches in September except their ordinary garden walls, and from which fruit is annually gathered quite equal in size, if not superior, to any grown in orchard-houses in the same locality.

It is asserted that fruit grown in orchard-houses is superior in flavour to that grown on walls. This is a point diametrically opposed to the laws of vegetable physiology, and altogether beyond my understanding. In the concluding sentence of Mr. Pearson's first paragraph he says I am not to mind whether a heated orchard-house is worthy of the name or not. I do not see the propriety of this, for from time immemorial Peaches have been grown in houses by the aid of artificial heat with a less pretentious name than orchard-house to designate it. A heated house for the production of Peaches is nothing more than a Peach-house. An orchard-house is a glass structure devoted, unheated, to the growth of various fruit trees, at least such is Mr. Rivers's own description of it.

Mr. Pearson charges me with quoting unfairly from his "Hints on Orchard-Houses." I never quoted from his work at all; but he will find, if he refer to a former communication of his in this Journal, that I gave his words verbatim; and as to the inference drawn from it, I hold that any one recommending glass houses unheated in the place of walls for the production of Peaches in the north knows nothing whatever of that which he is recommending. I have said, and still say, that it is better to build a wall and cover that wall with glass than to erect an orchard-house and be at the expense of heating it. The house would be the more expensive, it would take double the amount of labour, and the results would seldom be equal to those afforded by the wall.

It seems that we are to have Pear trees trained to walls, and Apples too, if I understand Mr. Pearson correctly, which may be something new to those residing in "decent" neighbourhoods; but to those residing in the north it will be something more noticeable because of the ignorance of those propagating the idea than because there is anything new in it. It may be new to train them with one stem like a Vine, and to get them on quince stocks to the top of a ten-foot wall in, I suppose, as many months as it now takes years. Time, however, will prove this to be a parallel case with orchard-houses.

The question now is, Have orchard-houses answered the purposes for which they were intended? In the north they have not. They were to be cheap yet efficient, and by their aid we were to be enabled to grow fruits superior to those grown on old-fashioned principles. The old barque has been refitted. Instead of wood walls we have something more substantial in the shape of bricks, or stone, and mortar. There are to be front lights instead of a boarded side up to the rafter; instead of being narrow the house must be wide—in short, a good substantial house, equal to any used for horticultural purposes. Further than this, we must heat it if we expect a crop of fruit, and raise the borders in cold wet districts. We are to build an expensive house and call it an orchard-house. Might we not as well have kept to

our old mode of doing business as adopt a principle diverging into the same thing? It is something like deceiving people to tell them that a cheap house with wood walls is all that is necessary to produce certain fruits, and then turn upon them when they fail and say, "You should have used more of your own judgment, and adapted a special thing to special circumstances without trusting to the dictation of others." My friends, you provided the chart for our guidance, but on that chart the rocks and breakers are not pointed out. Experience has made them known to us, and we offer you no thanks for telling us now what we have found out ourselves without your assistance. G. ABBEY.

FLORISTS' FLOWERS AT THE ROYAL BOTANIC SOCIETY'S SHOW.—APRIL 9TH.

Roses.—I do not think that so good a group of pot Roses was ever shown so early as the 19th of April as those exhibited by Messrs. Paul & Son, of Cheshunt. They were well-sized plants, beautifully fresh, with some excellent blooms on them, and to my mind infinitely preferable to the great, long, gawky things, all poles and ties, which we shall shortly see. Amongst them were Madame Julie Daran, a fine Rose, full and good; and John Hopper, glorious. I believe the merits of this flower will be better seen this year. It was overworked this season, but every one was struck with the magnificent character of the blooms on these plants. Then there was another English Rose, for whose character I am somewhat responsible—Lord Clyde: this was shown very fine. Maurice Bernardin was also excellent; Madame Boutin, very large, but somewhat dull in colour; Senateur Vaisse, as ever, excellent; while Celine Forestier was so large and fine that it was impossible to conceive how it ever could have been slightly thought of. And then Virginal, how chaste and blooming! but the ditto of Mdlle. Bonnaire. These, with Madame Charles Wood, formed the cream of the lot.

Amongst the Cut Roses Mr. Wm. Paul had Baron Lassus de St. Genies, a fine double crimson; President Lincoln, a flat Rose, but pretty; Le Rhône, excellent; Lord Macaulay, very bright; Mrs. Wm. Paul, good; and Beauty of Waltham, not distinguishable from Madame Charles Crapelet. In Messrs. Paul & Son's Duc de Rohan was very good; Baron Adolphe de Rothschild was like its parent Général Jacqueminot; Madame Alfred de Rougemont, no use—nothing more than a white Noisette; John Hopper, excellent; Rev. H. Dombrain, not in condition; and Mdlle. Jenny Vermet, a pretty delicate Tea, was well worth notice.

CINERARIAS.—As far as pot plants are concerned the progress here was backward, while amongst the seedlings were some honoured which hardly merited it; but one of Messrs. Smith, of Dulwich, named Rembrandt, of a novel mulberry colour and of good shape, deserved all it got—a first-class certificate.

AZALEAS.—Many of these were very fine, and amongst seedlings one what boys call a "stunner." It was raised by Mr. Ivery, of Dorking, and is called Fascination, one of the margined sorts in the style of Etoile de Gand, &c., but perfectly distinct—not a sport from another, but a distinct seedling, and so likely to be constant: this deservedly had a first-class certificate. Messrs. Smith's Flag of Truce was admirable, as it always is; and so was Louise Von Baden of Mr. Turner. The older kinds exhibited were very fine, although I do not like the shape in which they are shown.—D., Deal.

FLOWERS MISCALLED FORCED AT THE ROYAL HORTICULTURAL SOCIETY'S SECOND SPRING SHOW.

IN your report of the above Show in No. 158, I perceive that in the class for forced flowers such plants as *Acacias armata* and *Drummondii*, *Cytisus racemosus*, *Pimelea spectabilis*, and *Cinerarias* are included. Now it strikes me as a misnomer to call these "forced flowers" on the 30th of March, when the greater part of them can be had in flower all the winter without any forcing. Even the *Pimelea spectabilis*, which is strictly speaking a spring-flowering

plant, can be had in March without anything like forcing; and a neighbouring garden here has now a large plant of the *A. Drummondii* past flowering. As for the *A. armata* and *Cytisus racemosus*, it is their winter-flowering habit that makes them such general favourites.

No doubt this class was introduced for the purpose of encouraging the forcing of flowers which could not otherwise be had at that early season; and as you very properly remark, "when there are so many plants offering resources" for such a purpose, I cannot but think it a misapplication of the prize to give it to a group of plants containing such as I have enumerated. I believe the presence of such would have disqualified it at a Dublin exhibition.

I was surprised not to see the old *Spiræa japonica*, *Weigela rosea*, *Forsythia viridissima*, the *Philadelphus* or *Mock Orange*, all of which can easily be had by the 30th of March, and would, I surmise, be more the style of plants expected to be exhibited in such a class. I might also mention the *Spiræa Reevesii plena*, and *prunifolia plena*, as excellent forcers.—J. K., *Arch Hall*.

THE TWO-DAYS EXHIBITION AND SCHEDULE OF THE ROYAL HORTICULTURAL SOCIETY.

WILL you permit me through your valuable Journal to make known to the Royal Horticultural Society, and other London societies who may follow their example of holding a two-days exhibition, that the plan is highly disapproved of by exhibitors, more particularly by those who are exhibitors of stove and orchidaceous plants, whose very valuable productions must, in some instances, be nearly destroyed? A petition is in course of circulation amongst exhibitors, to be signed by those who are determined to give no support to a two-days exhibition, which I earnestly trust may produce the desired effect—viz., a one-day exhibition.

I also wish to complain of the alterations made in the schedule for 1864. To enter into the subject fully would, I am sure, occupy too much space in your Journal, so I shall confine myself at present to a few classes in the schedule for the June Exhibition at South Kensington, in which I am more particularly interested, and leave exhibitors of Azaleas and other minor florists' flowers, to state their own cases, they having great grievances. The following classes are highly disapproved of by exhibitors on whom the Council have mainly to depend for a glorious display, without which the Society will soon fall to a secondary position. It is generally admitted that to compile a schedule of prizes properly, requires a committee of men particularly well informed on the different subjects connected with the formation of such schedule. This has evidently not been the case in the preparation of that of the Royal Horticultural Society.

Class 1 is for a prize offered for twelve fine-foliage and flowering plants by the President, and, no doubt, the best of all the prizes offered, as it will recompense the Society for the lack of exhibitions in other classes. There will be entries innumerable from the great London establishments, and some of our country friends living at a distance may think this the only prize in the schedule likely to pay their expenses.

Class 2 entirely excludes exhibitors living at a distance.

Classes 3, 4, and 5 may be viewed in the same light. A nurseryman, say, from Manchester, has no prospect of being able to pay his expenses, even if he could win the first prize in any class.

Classes 6, 7, 8, 9, 10, 11, and 12 also exclude most exhibitors, those living at a distance entirely. If we are to have a national exhibition, let us have prizes offered which will induce competition from the most distant counties, as there are collections of stove plants and Orchideæ, also gardeners who have ambition in other than London districts.

This sub-division of Orchids into classes is the greatest mistake of all, and would seem to be done for the accommodation of certain parties. For instance: Class 6 is a prize offered for *Ærides*, *Vandas*, and *Saccolabiums*. Any person acquainted with the subject could tell directly who would win this prize. Class 7 is to consist of *Cattleya* and *Lælia*—a noble class, but short of variety to make a display what it ought to be—viz., varied. There would also be no diffi-

culty in naming the party who would win this prize. Class 8 is to consist of *Oncidiums*, *Miltonias*, and *Odontoglossums*. This is a puzzler. What beautiful *Oncids* are there in flower now? *Miltonias* are out of the question altogether; the party who can flower a *Miltonia* in June deserves credit. Perchance a beautiful stray *Odontoglossum* may preserve some of its beauty to grace this class; but this is quite a chance. Class 9 may invite some competition between two or three parties who make an especial hobby of the Slipper-plants. Classes 10, 11, and 12 hold out a poor prospect for small exhibitors round London, and still worse for those from a distance. Considering all this, and the poor unvaried display these collections must produce, compared with a well-arranged collection of varied Orchids, I cannot but say it is a great mistake.—ROBERT BULLEN, *Gardener to A. Turner, Esq., Bow Bridge House, Leicester*.

ROSES ON THE BRIAR.

Much has been written and said against standard Roses and with some show of reason. The grounds of objection are numerous and worth consideration, but not sufficient to induce an entire rejection of Roses on the Briar; such would be disastrous in many respects, and further discussion on this point will neither be uninteresting nor without its use.

I am ready to concede that standard Roses are, under many circumstances, inelegant objects for a great part of the year, and where they can be grown on their own roots or on the *Manetti* stock with advantage, either or both of these forms should be preferred, because the unsightliness complained of in the "inverted mop," as an eminent florist has been pleased to term it, is to a great extent avoided and more symmetrical plants reared; and, further, better flowers can, with proper treatment, be obtained from dwarf Roses. But there are kinds that can be grown so well on the Briar, and uses to which it can be applied, that to cast out unceremoniously an old and tried friend would appear little short of madness.

It is not to be understood that this article is intended to be a defence of the standard Rose *in toto*. Like most other things, the Briar as a stock for budding has been misused, ill-used, and abused, and, of course, has its defects, the main evil being that it has been applied for the propagation of all kinds indiscriminately, and, therefore, the failures have been frequent. I have used it here extensively for some years past—more, it is true, from necessity than choice, Briars being somewhat plentiful in the neighbourhood, and not difficult to obtain; yet I hesitate not a moment to state my deliberate opinion, that where good flowers and display are sought for, we should grow Roses on their own roots and on the *Manetti*. It has been said that standard Roses are going out of fashion. It may be so: but judging from the numerous applications I have for buds every summer, I am inclined to think budding has become a very fashionable employment.

But to return more directly to the subject. It is not difficult to point out some of the most prominent instances where the Briar may be serviceable. It is very usual to plant standard Roses on and near the outsides of shrubberies, and among low-growing shrubs. In such places the Briar is indispensable, and the unsightly stem is partially or wholly concealed by the surrounding plants. The following kinds are well adapted for such purposes, being all vigorous and perfectly hardy in habit, and will bloom and flourish for many years; they will likewise produce good flowers if pruning be attended to at the proper season, and if the soil be mulched and a little manure added occasionally.

Summer Roses, such as *Gallias*, *Hybrid Chinas*, &c., *Madame Hardy*, *Madame Plantier*, *Adèle Provost*, *Séduisante*, *Paul Ferras*, *Cynthia*, *Blairii* No. 2, *Brennus*, *Chéné-doké*, *Coupe d'Hébé*, *Charles Lawson*, *Paul Ricaut*, *Kean*, *Frederick II.*, *June*, *Ohl*, *Boula de Nantenil*.

Hybrid Perpetuals.—*Baronne Prevost*, *Jules Margottin*, *Lord Raglan*, *Alexandrine Bachuetoff*, *Général Jacqueminot*, *Pius IX.*, *Souvenir de la Reine d'Angleterre*.

Bourbons.—*Aïdalie*, *Madame Despres*, *Docteur Berthot*, *Sir J. Paxton*.

The whole of the above may safely be attempted on the Briar under all circumstances; and in places where the soil

is damp and retentive most of them will live on the Briar, when in any other form they would perish. It is not by any means presumed that the list is complete. The names given are such as have been proved here, and, being nearly all of them good varieties, are recommended for the purpose stated.

As I said in a former article, with the exception of a small spot where most of the above are planted, the soil here is very light, and what is more, fully exposed to the north and north-east, and in many respects unfavourable for successful Rose-culture; yet the Rose being the great essential to my horticultural pleasure, I am obliged to adopt means to my end. Briars are at hand, and I have used them freely. The result thus far amounts to this—they must be perfectly straight, and with a good root when first planted, and not planted too deep; the wood must be sound and healthy, and of not less than three-years growth. Pithy and green stocks are worthless. If you bud them they will die off below the budded joint. They must never be budded too high, 2 feet from the ground should be the maximum, the lower down the better, excepting always that the point of union must not run the risk of being buried in the soil; if so, death will most probably be the consequence. To preserve the plant in health and vigour, it must be highly manured, in dry weather the soil frequently mulched and watered (occasionally with manure water), and with Hybrid Perpetuals and Bourbons, especially after their first crop of bloom. If these simple directions are followed out Roses may be obtained on light soils upon the Briar—that is to say, many really good and fine kinds.

I am of opinion that all the summer Roses are best on the Briar not higher than 2 feet, although some—as Charles Lawson, Coupe d'Hébé, Frederick II., Blairii No 2, and Brennus, may be used for higher standards. I have not tried any of them on the Manetti, but a few on their own roots do not produce so fine blooms as on the Briar.

Of Hybrid Perpetuals the most thriving are those before mentioned, and the following:—Admiral Nelson, Madame Boll, Mademoiselle Bonnaire, Baronne Hallez, Belle de Bourg-la-Reine, Cambacères, Cecile de Chabillant, Eugène Appert, Cardinal Patrizzi, Triomphe des Beaux Arts, Anna Alexieff, Comte de Nanteuil, Lion des Combats, Madame Charles Crapelet, Triomphe de l'Exposition, Triomphe de Paris, Duc De Cazes, Sénateur Vaisse, Pauline Lanzeleur, La Ville de St. Denis, Gloire de Vitry, Madame Laffay, Madame Masson, Empereur de Maroc, Madame Hector Jacquin, Caroline de Sansal, Duchesse d'Orleans, Duchess of Norfolk, La Fontaine.

I have many other kinds on trial, but refrain mentioning them till proved. This is especially the case with the newer varieties. I could also make out a much longer list of sorts that will not thrive even after repeated trials; but as the readers of this Journal do not look for negative information it is useless to load a page with mere names.—ADOLPHUS H. KENT, *Blechingley, Surrey.*

FERN-HOUSES AND GREEN GLASS.

BEING about to erect a Fern-house, I should like to hear from some of your many correspondents what features such a house ought to present, so as to have the most pleasing appearance coupled with suitability to the requirements of the plants intended to be grown there. I have seen several Fern-houses, many of them differing widely from each other, and some of them presented a really tasteful arrangement. Perhaps as pretty a model of a house adapted to hardy and half-hardy Ferns is that attached to the extensive establishment of Messrs. Veitch, of Chelsea, which I have known ladies of acknowledged good taste pronounce a perfect gem; but there are other classes of Ferns not so accommodating in their capabilities of enduring cold, and, consequently, a more tropical temperature must be provided for them. This class of Ferns, although in point of beauty presenting little to admire over the more hardy class, nevertheless often exhibit more gigantic and noble forms, and the term "tree Fern" implies a larger growth than anything of a like kind in the more hardy series. Tropical Ferns, therefore, often present features which stamp them with a degree of importance which it is impossible to deny them, and a

house for their culture is one of the fashionable requirements of the day in places where plant-growing is encouraged in all its departments. Now, it is in the construction of such a house that I ask the contributors to THE JOURNAL OF HORTICULTURE to assist me with their advice, more especially in one or two features which I have not observed in any house of the kind I have ever visited. The principal thing I thus publicly inquire about is shading, which is generally regarded as indispensable in Fern-growing, whether under glass or out of doors; but as it is the former I now ask advice upon, I will go a step further and suggest a plan by which I think it may be dispensed with. Although I suspect it will be retorted that it is easier to force fruits, &c., without sun than it is to grow Ferns without shading, I nevertheless think the latter may be done in the way I propose.

As Ferns, I presume, in their native habitats invariably either grow under the shade of large trees, or behind rocks, or in some other way beyond the reach of the fiercest sunshine, it is certainly imperative to present an intervening medium between the direct rays of light and heat and the plants; but cannot such a substance be sufficiently opaque to meet the requirements of the case without further artificial shading? In other words can we not have the glass roof of our Fern-house tinted green or some other colour that will subdue the light so as to enable the plants to endure it without injury? I am well aware that highly coloured glass, such as is sometimes met with in doors of small suburban greenhouses and other places, is much to be objected to as killing the colours of the plants flowering inside; but such an objection need not be made to a dull subdued green tint, or any other of a similar kind. Has any one ever tried this in a Fern-house? I have myself had the management of a greenhouse that was roofed with glass tinted a rather deep green, and it answered its purpose well in summer, the plants remaining longer in flower than in any other way that I ever had them—quite as long as if the house had been covered with canvass, while the peculiar green shade cast on everything was, on the whole, pleasing. Now, I ask, Would not this description of glass suit Ferns exactly? It is true it would be the same in winter as in summer; but would that not be an advantage rather than otherwise? and as the unsightly appearance of canvass shading would be dispensed with, a great benefit would result. I confess having a dislike to the tent-like appearance which a hothouse presents when covered with such shading material, and something of the kind is indispensable in all sunny situations.

I think the subject of Fern-houses is but indifferently understood. It is true the mode of growing Ferns in houses erected especially for them is well accomplished, but are such houses the best that can be made? I should certainly say not; and has any one tried coloured glass? if so, would he be kind enough to report thereon? What I want is a house that will do its work without the unsightly and expensive shading alluded to, and I think such may be made. I have said that I have grown Geraniums and other greenhouse plants in a house that was glazed with glass strongly tinted green, and they did well. Why, therefore, should not Ferns do well also? I am of opinion they would; but if others have tried it and found it unsuitable, I am bound to bow to their experience. However, let the matter be fully investigated; and if those who have not experienced the effect produced by coloured glass would favour me with their opinions, it would be equally acceptable and might lead to a more thorough knowledge of the requirements of plants of this important family. They are daily rising into higher repute, and if we can make any improvement in the structures devoted to their culture, the gain will be on the side of the public. Fern-houses are rising in all directions, and some of them are assuming the dimensions of what were considered good-sized conservatories twenty years ago, and these often at places but little known to the reading part of the gardening public. An example of this occurred to me about a year ago, when I accidentally came upon a noble Fern-house, in which the best specimens of tropical Ferns I ever met with were grown. It was some 60 feet or more long, and, perhaps, half that width. Artificial rockwork and water formed the interior fittings, and nothing could exceed the health and vigour of the plants. I forgot the name of the gentleman

to whom it belonged, but it was near Chester-le-Street, in the county of Durham. The house, a span-roofed one, was, like most that I have seen, covered over with canvass. That this expensive appendage can be done without I sincerely trust; and in calling attention to the utility of green-tinted glass as a substitute for shading, I ask the opinion of all interested in the subject, and more especially invite any who may have had practical experience of its working to come forward and give their opinions.—W. R. R.

THE COLD PIT.

PERHAPS there is no structure in the garden that is really more useful than this, so that it is no wonder that now and then the subject is treated on in the pages of THE JOURNAL OF HORTICULTURE, and the various opinions given by the different writers are all in their way good. I, too, am anxious to record the various forms in which cold pits are made in the different localities which I have visited, as far as I can recollect. At the same time, let it be understood that there are probably numerous other forms of the cold pit which may have equal claims to attention, but which may either not have come under my notice, or have escaped my recollection in the lapse of time. I may observe that by the term "cold pit" are meant those structures which are destined to shelter plants in cold weather, but which of themselves are not heated in any artificial way. Cold pits, also, by a sort of acknowledged equivocation of name, may either be above the surface or below it, but are generally so restricted in size as not to admit a person inside, or under the covering, although this qualification is not strictly adhered to.

My first acquaintance with a cold pit calls to mind very unpleasant memories of sore fingers and painful knees. A square of perhaps half an acre in a nursery was divided into beds of about 4 or 5 feet wide, a like width being allowed for an alley or pathway. The beds were excavated perpendicularly, their sides bricked up, and a timber wall-plate placed at top a few inches higher than the path; the depth of the pit, including the wall-plate, being some 18 inches or more. Along the centre of this bed stakes, 4 or 5 feet apart, were placed, and along the top of these stakes a sort of ridge-pole was fixed, sufficiently high to form a sort of easy span-roof, having the side wall-plates as eaves. It is easy to perceive how quickly by this contrivance a sort of ridge-shaped covering of mats could be made; and in the case to which I refer I may mention that in winter when it became necessary to cover up the contents of the pit for a long time, the old wooden hoops from sugar-casks, cut in two, were very suitable, forming in fact a hooped-over bed. I may add that the bottom of these beds was coal ashes in which pots were plunged, more or less neatly as the skill of the workman enabled him to do it. These pits, I believe, were formed at the end of the last century, and although the central row of stakes, ridge-pole, &c., might want occasional renewing, the main features of the pit and its durable character would be difficult to improve upon. I may add that the situation though very cold was dry. Mats and such coverings were used, but no glass.

Another good class of pit may be formed much in the same way, but above ground; but it is more common when such pits are above the surface to have them what is called "lean-to," and either glass or wooden shutters are in requisition. One thing, however, seems necessary in this as in all cold pits—that is, a timber wall-plate at back and front; occasionally a cemented brick coping is met with, but it is an exception rather than the rule, and is expensive without being so good, and as cheapness is an important item, homely structures are more frequently met with. Where, however, stone of an easy working kind suitable for dry walls abounds it is easy to form a useful good pit at very little trouble; and in some districts of Yorkshire such pits are plentiful and good, the size and other features being determined by the requirements of the case.

Some years ago I came upon a set of cold pits in the west of England which were formed of materials abundant on the spot, and yet the pits looked well. The pit, or rather frame, for it was all above the surface, was formed of rough pieces of larch and Scotch fir cut into lengths of a yard or so, and placed touching each other all around the space

required for the pit. Their tops being level, a rail was nailed on, which served as a wall-plate, the other ends of the stakes being set in the ground to the depth of about a foot or less. When I saw these pits they were filled with leaves, and Potatoes and other crops were growing in them; but they were likewise available for all the other purposes to which a cold pit is put, and their appearance was good. Where greater closeness was required the interstices could be stuffed with moss. The pieces of timber were from 4 to 6 or 7 inches in diameter, and had scarcely any dressing; occasionally, however, one or two placed with the thick end upwards retained the uniformity of space and appearance.

Differing in some degree from the last-named, I have seen the sides of cold pits formed of two rows of stakes of a smaller kind, and the intervening space filled in with Heath, and a board or plank placed at top. Straw might do, but it is not so durable, and it is impossible to keep it dry; Fern or the stems of Asparagus are more durable than straw, and more lasting still is Broom, but local circumstances will point out the best materials that are available for this purpose, and of such there is a great diversity.

The carpentry work required in a frame of boards entitles it more to the claim of being called a box-frame than a cold pit; but there are many varieties of this, and boards and slabs are used in all manner of ways in order to manufacture pits or frames adapted to the wants of plants, the amount of labour in making one being on the whole less expensive than might be expected.

I now come to the turf pit, which is a favourite with our worthy friend Mr. Fish, and is not exceeded in usefulness or in the healthy character of its occupants by any class of mechanical structures, but as he has so often described it further notice of it is needless. I may, however, remark that turf is often less plentiful than the other materials above mentioned, and the abundance or otherwise of the article must guide the operator what to use in forming his cold pit.

Besides the turf pit there is the clay pit, which is much in the same way. Lumps of roughly-prepared clay are piled upon each other to the required height, and on the top of all a sort of wall-plate is pressed in; the sides are pared smooth with a sharp spade, and in some cases whitewashed. Buildings of much greater pretensions than cold pits are often made in this way; even cottages, and not of the worst class either, are not unusually so formed. For cold pits the plan is highly to be recommended. I believe that in working up the clay some short straw is used, but not so much as when the clay is used as a plaster, which is done in some cases.

It is almost needless to say that there are many other ways in which a cold pit may be formed, but enough has been shown to prove that materials for the purpose exist almost everywhere. As the examples given above refer to such structures as are intended to last some years, I may observe that many makeshift substitutes are often brought into use for the time being, as, for instance, to shelter a quantity of low-growing plants prior to bedding-out. In this case it is not unusual to see a row of large empty pots placed along the back and front; and across them poles of some kind are laid, and mats thrown over. Piles of loose bricks are sometimes used instead of pots, or it may be fagots are laid down for the sides; or any other arrangement that may be most handy, or which ingenuity may suggest, can be adopted.

In giving a sort of list of cold pits I must confess my own preference for brick and mortar, which in the end will not be found an expensive affair, and when its durability and neatness is taken into consideration it has many advantages. Two such pits we have here (Linton), each being 120 feet long by 6 feet wide inside; they are built of four-and-a-half-inch brickwork, with a roughly-sawn timber wall-plate fitted to the inclination back and front, the back being about 28 inches, and the front about 15 inches high. Divisions of brickwork about 20 feet apart afford opportunities for connecting the back and front wall-plates by cross-ties, and the pit is much sheltered by these partitions. There are, however, no sliding rafters for lights; for what glass is used is merely laid on, and the absence of rafters is a great advantage for planting or doing anything inside. These pits are in use with but little intermission the whole year. In winter

Calceolaria cuttings occupy a part of the space, while Strawberry-pots for forcing, resting on loose bricks or something of that kind, also find shelter; and it is not unusual to plant-out untried plants or such as are too small or tender to be trusted in the open ground, but which can be securely protected here. As each crop is removed another is ready. After the Calceolarias are gone a crop of ridge Cucumbers is sometimes obtained, or it may be Celery plants are pricked out to strengthen, and after the last of them are gone, say early in August, it is time to put in cuttings of Geraniums, which, in their turn, are taken up in the first week in October, and soon afterwards Calceolarias are put in again for the winter. This routine is of course now and then interrupted in small portions of the pit by other crops, as, for instance, a small hotbed may be made up in a part of it, and a batch of Pink cuttings, with double Rockets, favourite Phloxes, and the like may occupy it some time; and some seedling Pinuses, as well as struck plants, are indulged at times with a place in this general receptacle for almost everything not sufficiently hardy to endure the cold weather of the season of their probation.

Something ought also to be said about the covering for such pits. In my case I may observe that glass forms only a very small portion indeed; but we have wooden shutters of three-quarter-inch deal which answer very well for very severe weather; but when there is not sufficient of them, and the glass is wanted elsewhere, a few poles laid across, and mats thrown over answer very well in late spring, or we have sometimes merely covered with laurel boughs for a time; but to keep out winter snow something of the nature of shutters or glass lights must be adopted, or Mr. Fish's covered frame may be put in requisition. Many things, in fact, may act as substitutes for this purpose—as oil-cloth, asphalte, and the many forms comprehended in the term "matting." To guard against a late spring frost but slight protection is required, but to bear the weight of a winter's snow a more substantial article is wanted. Enough, however, has been said on this head, the presence of the material that will effect the object will of course determine its use in the proper place.

J. ROBSON.

TODMORDEN BOTANICAL SOCIETY.

MEETING, APRIL 4TH.

MR. A. STANSFIELD, jun., read a paper on cryptogamic embryology, being the first portion of a *résumé* of M. Vaillant's recently-published and hitherto untranslated *thesis*: "De la Fécondation dans les Cryptogames." M. Vaillant's work is one of great interest to cryptogamic botanists, being somewhere about the "last word" on the subject of which it treats. The laborious researches of the indefatigable Hofmeister and others have lately thrown a flood of light on this interesting though hitherto mysterious branch of vegetable physiology. It is purposed, at subsequent meetings, to pursue the subject in a series of papers, of length sufficiently moderate to allow of all necessary questions being put by members not familiar with this speciality.

The President laid before the meeting a list of all known British Ferns, recently published in Edinburgh. The species and varieties now number over 1200! The President observed that little more than ten years ago the total number of species and varieties did not exceed 100. What the figures will be ten years hence is a matter little less than terrible to contemplate.

We have omitted to remark on the specimens laid on the Society's table, but some of them were really noticeable, as, for instance, the curious and monstrous *Scopolopendrium*, var. *sagittato-polycuspis*, *Polystichum Braunii*, *Iris reticulata* (an

exquisite thing), *Clematis azurea*, the beautiful *Anemone thalictroides* brought direct from its North American habitat, and *Epimedium violaceum*, surely the handsomest of the Barrenworts! On the table, too, was a pot of *Saxifraga oppositifolia*, the larger variety, profusely covered with its rich purple flowers, which reminded us that this floral gem is now blushing in monster patches, in innumerable warm nooks and crevices, "on a hundred hills," even on our Yorkshire Ingleborough. We had forgotten a beautiful example of *Draba aizoides*, direct from the Swiss Alps, where in far-stretching golden masses it is making at this moment a glorious sreen.

A CHEAP GATE.

THE accompanying figures represent a gate invented and patented by A. C. Teel, of Girard, Macoupin county, Illinois. It is a very simple affair; any person who can use a saw, hammer, and nails can make one. Its cost, too, is comparatively trifling. We are informed that it can be made here for 1 dollar 50 cents. Inch boards are used, put together with wrought nails, clinched.

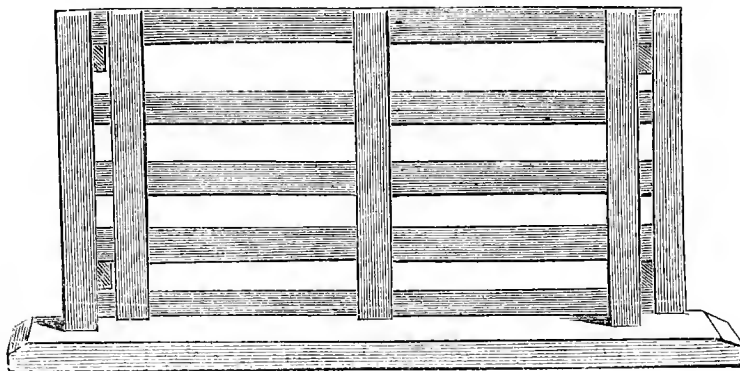

No. 1.

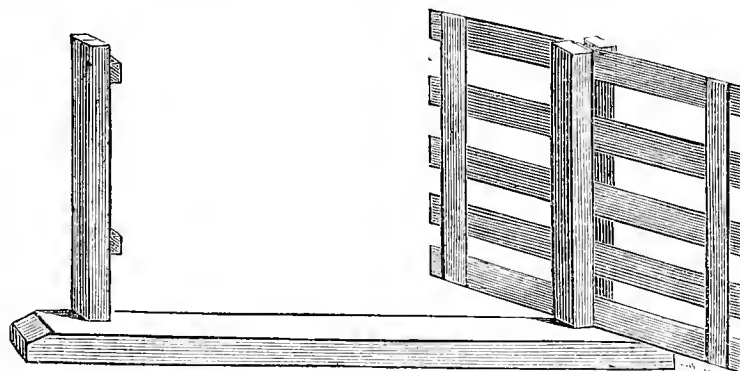

No. 2.

The figures herewith given represent the gate-posts as framed into a piece of timber; but for ordinary farm purposes the posts may be set in the ground. *Fig. 1* represents the posts as closed, and *fig. 2* as opened. At the right hand there are two posts, set as shown in *fig. 2*. It will be noticed that they do not stand opposite each other. At the other end of the gate there are also two posts, which stand opposite each other. One post in this place, with holes to receive two bars of the gate, would answer as well, or better. At each end of the gate cleats are fastened to the posts under the top bar of the gate, and also under the second bar from the bottom. The gate slides on the cleats on the right-hand posts. When it has been pushed back to the centre batten it is easily swung round, so as to leave the space between the posts clear, as shown in *fig. 2*. Rollers might be used instead of cleats for the gate to slide on.—(*Boston Cultivator*.)

RHODODENDRON NUTTALLI.—There is now in bloom in Mr. B. S. Williams' fine new show-house at his Victoria Nur-

sery, Upper Holloway, a magnificent plant of this beautiful *Rhododendron*. It is, perhaps, the finest specimen in the country, being certainly not less than 10 feet high, and furnished with numerous branches, on the extremities of which are heads of its large bell-shaped flowers. Some of these individual flowers we do not exaggerate when we say they are 5 inches across. The great marvel is the small pot it occupies; for though of the dimensions of a good-sized tree, the pot is only what is called a No. 1.

CULTIVATION OF THE GLADIOLUS.

HAVING had several years' experience in the cultivation of the *Gladiolus*, I beg to offer a few remarks on the subject, as for late summer and autumn decoration the flower is very beautiful, and now that really good varieties are to be had at very reasonable prices, common sorts need not be grown at all.

I will suppose you have obtained your bulbs by the beginning of April. Get as many four and five-inch pots as bulbs; the larger pots for the stronger bulbs, and the smaller pots for the less-sized bulbs. Fill them half full with the following compost:—two-thirds good fibry loam, one-third thoroughly decayed manure mixed with a little sharp sand.

Place the bulbs in the centre of the pots, one in each, and fill up with the compost. When all is finished give a gentle watering with a fine rose. Take the pots to a frame or greenhouse where they can be kept near the glass and free from frost. Keep them regularly moist, but not too wet.

By the middle of May your plants will be strong and fit to plant out into their summer quarters. I prefer planting them in masses 18 inches from bulb to bulb, with *Heliotropes* to cover the ground beneath.

If the weather should prove dry and warm, a good soaking of water occasionally will benefit them much. If the soil where they are to be planted is not rich, it should have a good coat of dung dug in before planting.

As soon as the flower-spikes show above the foliage, they must have a strong stake put to each plant and be loosely tied to prevent their being broken by the wind.

As soon as the foliage begins to decay (about the middle of October), take up the bulbs with a little soil attached to them, and place them in a cold frame with old tan, leaf mould, or sand, between the rows, to dry them off gradually. Be sure never to hasten their drying, for therein is the secret of fine bulbs and blooms.

When the old stalks part readily from the bulbs they should be nicely cleaned and labeled, and put away in any dry place till again wanted.

The finest lot of plants and blooms I ever saw in a private garden was at High Legh Hall, Cheshire, under the management of Mr. Harley, the gardener. His plants were from 5 to 6 feet high, with from thirty to thirty-six flowers on a spike. The above directions are exactly the same as Mr. Harley adopts with such great success.—J. BROOKES, *Chantry House, Somerset*.

THE MYSTERIES OF PLANT DISTRIBUTION.

WHY certain species are to be found only on the mountains, others in the plains, and a third by the seashore, may be ranked among the marvels which ought to, but do not, excite in us the least surprise. Those who have thought deepest and pondered longest on the subject are always those who are least inclined to attempt an explanation of the mystery; while others who never gave it a passing thought are ready with an answer at once if a question such as the following be proposed to them:—Why does it happen that a certain plant is never seen growing elsewhere than at an elevation of two or three thousand feet? They will immediately reply without the slightest hesitation, that it is the nature of the plant to grow there and nowhere else; and they seem to think that this answer ought to be received as perfectly satisfactory. It may be so to themselves; to the querist it is no answer at all, but merely a restating of his question in different words. No doubt it is the nature of the plant to grow there. But why this nature? It is not in every case from an inability to live elsewhere, for if removed from their own chosen place of abode, many will flourish in

health and vigour under circumstances the very antipodes of those which surrounded them in their natural habitat. Such determination to hold by their favourite place of residence without any apparent necessity would almost make one believe that plants are sentient beings, and that their peculiar home is with them more a matter of choice than necessity. An illustration of this may be readily furnished by reference to the habits of *Alchemilla alpina*, *Saxifraga oppositifolia*, and other species of the genus *Saxifraga*. These are never found in their normal state unless at a considerable altitude on the mountains, and to find them anywhere else in a state of nature would excite surprise, as they never descend from their elevated position of their own accord; yet they all bear transplanting well, and will flourish even at the sea level, without any care being bestowed on them. We have seen *Saxifraga oppositifolia*, that had been transplanted into a garden at Rowardennan, in beautiful flower in the month of May, and in three hours afterwards we have gathered it in the same condition on the very crest of Ben Lomond, growing within a few feet of a deep wreath of snow.

On the same mountain you will not find *Alchemilla alpina* till you reach an elevation of nearly 2000 feet, when all at once it appears in profusion; but you will find it likewise flourishing in Kelvingrove Park, in the immediate neighbourhood of Glasgow, with a luxuriance equal, if not superior, to what it displays on its native mountains. There are others, again, that appear so enamoured of their freedom, and so attached to their rugged but sublime home, that no treatment yet discovered can reconcile them to their loss of independence. Amongst these may be numbered the beautiful little *Primula scotica*, that abounds on the dreary upland moors of Sutherland, in the neighbourhood of Cape Wrath. This beautiful little plant would no doubt be highly prized by the cultivator, if it could only be induced to submit to the restraints of cultivation; but no sooner is it brought within what we may term the amenities of civilised life, than the little savage pines away and dies.

"And the loud whirlwind, and the tempest's roar,
But bind it to its native mountains more."

Primula auricula, its near relative, is much less independent in its nature, and accommodates itself to circumstances with the greatest facility. Every one knows how easy of cultivation it is, and into how many beautiful varieties it has diverged by skilfully diversified treatment, yet its native home is on the Alps of Europe, near the confines of everlasting snow. Why two plants so nearly related, and inhabiting localities so closely resembling each other in their natural features, should differ so essentially in their capability of adapting themselves to change of circumstances, is another of those marvels, to which in our present state of knowledge, or rather ignorance, we can give no better answer than the one formerly quoted—it is just their nature.

Who has wandered along the sea beach in the month of June, and not been delighted with the flush of delicate pink shed all around by the Sea Thrift (*Armeria maritima*), that grows so abundantly along our shores, often in situations where it is overflowed by the tide, and always where it is directly under the influence of the salt spray? This appears to be its naturally chosen habitation, as it entirely disappears a few feet above high-water mark, but, strange to say, makes its appearance again on the tops of our highest mountains—for instance, Ben Lawrs—a situation as remote from the sea as can be pointed out within the bounds of Scotland, while all the intervening space between that and the seashore is, as far as it is concerned, a total blank. Like other plants that grow in the immediate neighbourhood of the sea, it contains a considerable amount of soda, a circumstance not to be wondered at, considering the immense reservoir of muriate of soda on the brink of which it lives. But where does it find the soda on the mountain tops? The plants inhabiting the latter position contain nearly as much of it as those that grow in situations where they are overflowed by the tide twice in the twenty-four hours. The mountain specimens likewise differ in a few trifling particulars from those that frequent the shore, such as a greater degree of downiness pervading the whole plant; and this slight difference has furnished that class of botanists, who have been not inaptly called "hair-splitters," with an excuse for pronouncing it altogether an entirely different plant, and raising it to the dignity of a species under the title of

Armeria alpina. Here we have a remarkable instance of a plant naturally choosing, not one locality but two, and these as widely apart geographically and physically as can be found within the bounds of our island: the one being at, or even beneath, the level of the sea; the other the highest peaks that our loftiest mountains afford. But although these two positions are the only ones that it chooses for itself, it appears to have no great repugnance to any other upon compulsion. It will even condescend to flower if planted in a miserable handful of earth on a window-sill in the most crowded parts of our cities.—(*West of Scotland Horticultural Magazine*.)

[There are some other plants which seem to be very exclusive, and we will quote an instance from what has been thus stated in that excellent serial, now publishing, "Chambers's Encyclopædia for the People."

"**KERGUELEN'S LAND CABBAGE** (*Pringlea antiscorbutica*), the only known species of a very curious genus of plants of the natural order *Crucifera*, and further interesting as being found only in that most lonely of islands, Kerguelen's Land, and as being extremely useful to the crews of whalers and other vessels which have occasion to touch there. It has a long, stout, perennial rootstock, and a bolted head of leaves very similar to those of the common garden Cabbage. Capt. Cook first discovered this plant, and directed attention to it. It is exceedingly abundant in all parts of Kerguelen's Land, which produces only seventeen other flowering plants. The rootstocks have the flavour of Horseradish. The dense white heart of the cluster of leaves tastes like Mustard and Cress, but is coarser. The whole foliage abounds in a very pungent, pale yellow, essential oil, which is confined in vessels running parallel to the veins of the leaves. The whole plant is used by voyagers, boiled either by itself, or with beef, pork, &c., and its antiscorbutic properties make it very important to them."

Now, this Cabbage of that solitary land grows there only because the soil and the climate are especially suitable to it; but if a similar soil and climate are found, and the seed of that Cabbage sown there, we have no doubt it would there flourish equally well. The Kerguelen Cabbage has not banished all other plants but the seventeen found in its neighbourhood, but the neighbourhood is not suitable to any others which have reached that island of boggy soil, rainy climate, and low temperatures.]

WORK FOR THE WEEK.

KITCHEN GARDEN.

CONTINUE to trench into the soil all refuse vegetable matter as advised in former calendars. It is much better to do so at once than to lay it in heaps in the rubbish ground, where it loses its most fertilising properties with the gases which it evolves during decomposition. When it is trenched into the ground the greater part of the gases will be retained in the soil till again taken up in combination with water by the roots of the plants, exemplifying the words of the poet when he said—

"Organic forms with chemic changes strive,
Live but to die, and die but to revive.
Immortal matter braves the transient storm,
Mounts from the wreck unchanging but in form."

And thus Cabbage stalks, &c., trenched into the soil last year will be gathered this season as Peas, Beans or any other vegetable whose roots come in contact with the elements of which they were composed. *Asparagus*, the young plants will now be ready for planting in beds, which it is hoped have been kept well prepared. Let the roots be carefully lifted with a strong fork, and after planting give a good supply of water to settle the soil about them. *Beet*, sow a full crop of Red if not already done. *Broccoli*, sow Early Purple and Myatt's White Cape; also, Waicheren Cauliflower for late-autumn use. *Brussels Sprouts*, prick out the seedling plants of the earliest-sown of these and of Savoys to get them stocky for final planting. *Cauliflowers*, draw the earth well up to the most forward, and give plentiful applications of liquid manure. *Celery*, continue to prick out. This must always be kept well supplied with water, rapid and continual growth being a very essential point in its cultivation if it be required large. If the earliest-sown

plants get any great check from drought, the chances are ten to one but they run to seed. *Dwarf Kidney Beans*, sow a full crop of the dwarf sorts, and also of Scarlet Runners, if it be more convenient to sow in the open ground instead of transplanting, as recommended last week. In some soils wireworm is very apt to attack the cotyledons during the progress of germination; as a remedy it is recommended, where it can be obtained, to water the drills after the Beans are sown with a liquid composed of one gallon of ammoniacal liquor from the gasworks, diluted with six or eight gallons of water. *Lettuces*, repeat the sowings of all sorts, and thin out and transplant those advancing as occasion may require. *Turkeys*, sow a good breadth. The ground for them would be benefited by a dressing of wood ashes or charred refuse.

FLOWER GARDEN.

All operations in the shrubbery should now be concluded for the season. Finish, if not already done, the pruning of those summer Roses which were left unpruned for the purpose of retarding their bloom. Insects, especially the green fly and rose-caterpillar, will now be making their appearance, the former to be destroyed without delay by syringing them with weak tobacco water, and the latter to be picked off with the hand and destroyed. Let all beds for mass flowers be prepared while the weather is dry. Remember that stagnation at the roots is one of the chief causes of bad success with many tender mass flowers. Take advantage of the present favourable weather for the destruction of weeds, &c., and to get shrubbery and herbaceous borders cleaned. Indeed, it will be advisable to run the Dutch hoe over these, even if merely to stir the surface.

GREENHOUSE AND CONSERVATORY.

With frosty nights and scorching days there is still some difficulty in managing the plants in these houses. The shading if not already on the conservatory, should be put on forthwith, as, until we have more genial weather, it will be found more advantageous to shade during the middle of the day, than to admit strong currents of dry air. Look well to the plants in the borders, and if dry give them a good soaking of weak manure water, and let it be a soaking that will percolate throughout the whole mass of soil, and not a mere dribbling. Sprinkle the plants and borders both night and morning, and use every endeavour to keep the atmosphere saturated with moisture, so as to cause a deposition of dew during the night. The newly-shifted plants in the greenhouse are now beginning to feel the benefit of the fresh soil, and if properly encouraged will grow rapidly. Do not, however, be in a hurry with them, as elongation is not growth, but endeavour to get clean, short, stubby growth, and strong foliage. Those plants which have taken good hold of the new soil, and which require stopping to make them bushy, should be stopped at once.

STOVE.

Attend to previous directions in giving liberal shifts to the free-growing young stock, selecting healthy, fibrous soils, applying occasionally to healthy plants clear tepid manure water, frequently syringing, slightly shading for a few hours in hot weather, taking the shading off early, shutting up in the afternoon with sun heat, and raising a kindly humidity by damping the floors, walls, &c.

PITS AND FRAMES.

Continue to pot-off rooted cuttings as soon as they are in a fit state for the purpose. Those potted-off some time will now be getting established in their pots; remove them from the hotted to the cold pits or frames, and plunge them in sand or other light material. See that they do not suffer for want of shading and water during hot, sunny days. Give them every encouragement that they may grow rapidly, and frequently attend to the stopping of the shoots to induce a robust, bushy growth. Shut up early in the afternoon, having previously given the plants, the walls, and sides of the pits and frames a good syringing with tepid water. Cover up closely at night, and uncover early in the morning. As little danger is now to be apprehended from frosts, it will be well to remove all litter, fern, &c., to its proper place. Tender annuals that have been raised in heat should be pricked out in light soil under glass in order to have them strong before bedding-out time. All that can be safely done until the nights shall have become warmer in the way of hardening the stock preparatory to its being planted

out, is to give as much air as the weather will permit, and to place *Calceolarias* and the stronger *Verbenas* in turf-pits, where they can be protected at night, and sheltered from drying winds.

W. KEANE.

DOINGS OF THE LAST WEEK.

KITCHEN GARDEN.

SOWED succession of Peas and Broad Beans, and a few Dwarf Kidney Beans out of doors, and a lot under glass for transplanting. Will sow in boxes *Scarlet Runners* for transplanting, as they move well. Some people like the White Dutch Runners, but we always think them tough and deficient in crispness and juiciness when compared with good Scarlet Runners. Our first knowledge of this fine vegetable was obtained from seeing it carefully trained round the outside of the window belonging to a poor widow in Scotland, and beautifully it looked with its masses of scarlet flowers. At that time the working people there knew nothing of the use of its green pods. A man who even grew and used a few Lettuces was considered an epicure who was aping to imitate genteel society. Hardly anything will yield a greater amount of food from a small space of ground than these Runners, whether staked, or stopped and forced to keep near the ground. If the pods are kept clean picked off few things would beat it as a row in a ribbon-border—say about 16 inches high and as much across. The best plan for the cottager to obtain them early would be to sow after the middle of April in a small bed thickly, protect with an old cloth or a few branches, and then transplant into well-prepared and aired soil after the middle of May. A few evergreen twigs placed along the row will prevent the frost injuring them. Sowed a piece more Carrots, and a few rows of Beet. Will wait until the end of the month to sow the main crop of Beet, Salsafy, Scorzonera, &c. Sowed, also, a piece more Onions, as the main crop is just peeping through the ground. Sowed, also, a succession of Turnips and Radishes; generally we sow them together, the Turnips in rows 2 feet apart, and then the Radishes in rows between, and they are gone by the time the leaves of the Turnips cover all the ground.

Sowed the main crop of the Brassica family, as Brussels Sprouts, Scotch Kale, Broccoli, &c. Snow's White Broccoli, if true, is still the best for late autumn and winter use. To have it early in October and onwards, it is a good plan to sow early in April under glass, prick it out on a border, and transplant when established. It is one of the few Broccolis that are as delicate as a Cauliflower. Put in a few more Potatoes as ground could be had for them. To get ground where scarce Scotch Kale and Brussels Sprouts may now be lifted and placed thickly in a shady place; and this, too, if attended with a good watering, will prolong their producing properties. We used to grow a good deal of the Red and White Variegated Kales, and thought them very nice, especially the pretty side shoots when from 3 to 4 inches long; but now we hear complaints that they boil black. Sowed Silver-skinned Onions thickly for pickling on a poor hard piece of ground, merely breaking the surface an inch or so with the point of a fork.

Gave a good watering with strong farmyard manure water to Cabbages and Broccoli, and in these bright sunny days it has made them push on so vigorously that you can almost see them grow. This will be more observable if you keep your eyes off them for a couple of days. Watered also Cauliflower, but with manure water much weaker,—except the forward ones under glasses still. Gave the most forward their final earthing-up, and elevated the glasses to give them room; the glasses will be kept on at night a little longer. Uncovered about one-half, and stuck a few twigs of laurel round them at first; and these will come in after the others, so as not to give us a great glut at once. Pricked-off a few more seedlings in boxes, as we had not a convenient bed. Sowed also a pinch more out of doors. Will delay sowing Ridge Cucumbers, Vegetable Marrow, &c., for a week, because we will not be able to find a place for them in a hurry, and the plants are often much injured when kept long in pots without planting out. In warm places, where no dung is used for them, it is best to sow in the ground at once. They sow in rows about Biggleswade, just as most people would do Peas, and, besides the thinning of the plants, little more

is done except to gather the fruit in large hampers for market. Many things rather tender will do better thus managed than when sown in heat, coddled, and made tender before going into the open air. In all such cases they should be so protected as to be exposed fully by degrees.

Regulated Cucumbers, and potted-off for succession. Cleared out the bottom of an old slight hotbed about ten inches deep, and, as it is only about half decomposed, mixed it up with a little fresh and some manure water to get it to heat nicely, as we are very short of fermenting matter, and we keep looking at only a small heap of leaves as if it were miser's gold, not to be touched rudely. The slight hotbed from which the above material was taken was made in October, and from then to now served the purpose intended; but if it had been made of well-wrought sweetened dung it would have served no purpose but manure now, whilst we shall manage to have a good hot heap out of it. We say nothing, however, against sweetening dung properly before using it, as it is the safest plan; but where the material is scant the sweetening process greatly lessens the bulk; and if only half sweetened so as to heat strongly, there need be little danger if there is a covering of from 8 to 12 inches of sweet material, or stuff from an old hotbed, or a covering of the same thickness, or even less, of soil. These will absorb all the deleterious exhalations before they can reach the enclosed atmosphere.

Peas, transplanted from turves, are growing with extraordinary vigour; but we do not expect to gather early out of doors this season, unless the bright weather continue. Pods are making their appearance in the orchard-house. Put a lot more ashes over a fresh piece of *Sea-kale*, as but little is gained by not cutting it when out of doors. If not done too late, the crowns are sure to throw out plenty of shoots to make buds for next season. Perhaps one of the most economical modes for obtaining a large supply now, is to cover the crowns with a foot of ashes, old tan, or dry earth, and then place a few inches of litter over it, as old stubble, &c. One of the neatest and cleanest modes would be placing stout wooden boxes over the crowns. Of course pots would do, either *Sea-kale* pots, or common garden pots with the holes filled up; but, in the case of pots uncovered, we have known the produce inside spoiled by a sharp frost in the beginning of May; and these, if covered with litter, would not bring the crop so soon to perfection as an uncovered pot in sunny days. Under wooden boxes there would be little danger from frost, but, if not stout, the heat of the sun would cause them to crack at the joints, and the *Kale* would be purple instead of white. We tried the plants with small oyster-tubs, but the sun opened the seams, and we were obliged to cover them. What gives least trouble in taking and removing will be the best at this season, when all labour power is wanted for so many purposes.

Jerusalem Artichokes should be planted if not already done. Removed the little litter from the stools of Globe Artichokes, forked over the ground between them, and removed some pieces to make a short fresh row. When this is greatly prized for a dish, it is always advisable to plant a little bit every year, or every two years, as those later planted generally produce later; and, for ourselves, we never can have them too early or too late. In some grounds, too, old stools become sickly and wear out. As soon as the material is countable, we will mulch them with dung, and, when growing freely, give them a good soaking with manure water, choosing a warm day for the operation.

FRUIT GARDEN.

Though somewhat late, we have set some labourers to limewash some walls against which Cherries are growing. The trees had been unnailed and washed, and as fly was a little troublesome last year, we thought it advisable to wash the wall before the trees were fastened to it again, the nailers following the washers. The wall was well scrubbed first with old brooms and brushes. The white colour of the lime was toned down by adding a little blueblack made into a paste. We also use sulphur at times. The fresher the lime the better it will stand, and if the wall is a little damp when the wash is applied, it will last better than if put on it when perfectly dry. Turned out a lot of forced *Strawberries* and filled the shelves from frames, &c., which is a good plan for bringing them on at this season. Took up some

hundreds of nice plants that had been pricked out in a border last summer. Potted them and plunged the pots in a slight hotbed of leaves out of doors, with a few branches stuck round. Here they will soon fill the pots with roots, and may be moved to the houses after that. All our potted ones have been housed, and these will come on in succession. If we can obtain a little hot dung we will make up a slight bed or two, use some nice soil, and fill with similar plants to come in before those in the open air. This generally answers better than placing lights over them on a sunny border where they grow. If the weather is bright, the lights thus placed over the plants, and moveable boards back and front, will forward the crop some eight or ten days; but in dull weather the fruit will be forwarded very little. Tiles and slates placed along the rows will also forward them several days. But a slight hobbed beneath brings them in nicely if the plants are raised with large balls and planted firmly, and a fair amount of air given. This plan of lifting and planting, or potting, will do very well now, but let no one suppose that such a plan would succeed with early Strawberries from February and onwards. In that case the plants must be well established in pots, well ripened, and rested before forcing. We mention this as a warning. From the middle to the end of March and onwards, the lifting system will do well, and fewer pots require to be kept filled with Strawberry plants during the winter. Proceeded with work in the fruit-houses much the same as last week, nipping, shoot-removing, Grape-thinning, &c. On Wednesday we saw a capital plan for protecting fruit trees by beech twigs with the old leaves on, which we consider one of the best for standing protection.

On Wednesday, we may say for the first time since autumn, we went out for a few hours to Berkhamstead. The Vines in the large house at Mr. Lane's were merely showing their buds, like large pin-heads, though the frost had been kept out all the winter. The contemplated border inside had not been made, but large banks of sawdust were placed inside, and in these fine strong plants of Vines in pots were plunged, though not a root had gone outside. Cherries, Plums, Peaches, and some Pears in pots were in full bloom. Trees in pots and Roses in pots are now grown dwarf, and kept near the pot, instead of rising as pyramids.* Of Azaleas we need not speak, as they were shown in London; the chief novelty, perhaps, was a small house with young Vines planted-out and in pots, and both showing very strong.

At Mr. Cooper's, a chemist and colour manufacturer in the town, and an enthusiastic amateur in fruit culture, we saw enough to tell us that many incitements to renewed exertion among us professionals must come to us from men connected with other professions. At the gardens of — Curtis, Esq., under the charge of Mr. Gibbins, we saw a fine house of Cucumbers, Peaches, superb young Vines, and a fine strain of *Primula sinensis*, &c. At Frithsden, the kitchen garden of Earl Brownlow, at Ashridge, which was all we could glance at, we noticed splendid plants of *Musa Cavendishii*, with leaves more than 2 feet across, growing on the floor at the back of a Cucumber-house; very fine Grapes and Peaches; a house of young Vines, breaking with extraordinary vigour—the roots here and at Mr. Curtis's, so far as we recollect all inside, and a fine show of fruit on the walls, as the garden being surrounded by the common and the park and having few trees near it, the birds scarcely ever give the least trouble. The garden, however, being on the slope at the bottom of a dell or glen, is subject to keen frosts, and little will stand against the walls without being protected. Mr. Sage, whose doings we hope some day to notice in detail, uses various means for protection; but the favourite one, when he can obtain them, is the branches or twigs of beech with the last year's leaves on them. We noticed Apricots under nets that were touched by the frost of Wednesday morning; but they and Plums were quite safe under the beech. The twigs are fastened so as to hang down, and stand out a good deal from the tree, the pieces so short that the wind has little power over them. They broke the force of winds, and yet allowed plenty of light and air to reach the wall. In fact, the blooms were just enjoying a slight shade from the bright sun. The branches hanging out also from the wall gave a better protection from frost than if they had

been closer to it. We have seen beech used previously, but we never saw it so neatly and efficiently applied. For this purpose we consider the beech much superior to laurels or to spruce boughs; and the mention of this may be of more importance to our readers than our own doings.

Plants of all kinds much the same as in previous weeks. Potting, planting-out, &c.—R. F.

COVENT GARDEN MARKET.—APRIL 16.

THE supply continues good. Ithoese Grapes are brought in good quantities, but good Pines are still rather scarce. From abroad consignments of Lettuce, Artichokes, Radishes, Carrots, &c., continue to arrive. Foreign Peas are now to be had at 15s. per half sieve, and new Potatoes from Lisbon, Malta, and the West Indies, are bringing from 4d. to 6d. per lb. Cucumbers are plentiful and good. Spring Cabbages are coming in in greater quantity, whilst of Broccoli-sprouts, Turnip-tops, and other rough Greens there is an abundance. Out-door-grown Asparagus has begun to make its appearance, and is sold at from 10s. to 15s. per bundle.

FRUIT.

	s.	d.	s.	d.		s.	d.	s.	d.
Apples..... ½ sieve	2	0	4	0	Nectarines.....	0	0	0	0
Apricots.....doz.	0	0	0	0	Oranges.....100	4	0	10	0
Figs.....doz.	0	0	0	0	Peaches.....	0	0	0	0
Filberts & Nuts 100 lbs.	0	0	0	0	Pears.....bush.	8	0	12	0
Grapes, Hothouse...lb.	15	0	25	0	dessert.....½ sieve	6	0	10	0
Foreign.....	1	6	2	0	Pine Apples.....lb.	6	0	12	0
Muscats.....	0	0	0	0	Pomegranates.....each	0	0	0	0
Lemons.....100	4	0	10	0	Strawberries.....oz.	0	6	1	6
Melons.....each	0	0	0	0	Walnuts.....bush.	14	6	20	0

VEGETABLES.

	s.	d.	s.	d.		s.	d.	s.	d.
Asparagus..... bundle	5	0	12	0	Leeks..... bunch	0	4	0	0
Beans, Broad..... bush.	0	0	0	0	Lettuce..... doz.	1	0	2	0
Kidney.....100	2	0	3	0	Mushrooms.....pottle	1	0	2	0
Beet, Red..... doz.	1	0	1	6	Mustd. & Cress, punnet	0	2	0	4
Broccoli..... bundle	0	9	2	0	Onions.....bushel	4	0	7	0
Brussels Sprouts ½ sieve	0	0	0	0	pickling..... quart	0	6	0	8
Cabbage..... doz.	1	0	1	6	Parsley..... ½ sieve	2	0	3	6
Capsicums..... 100	0	0	0	0	Parsnipa..... doz.	0	9	1	6
Carrots..... bunch	0	6	0	0	Peas..... bush.	0	0	0	0
Cauliflower..... doz.	4	0	3	0	Potatoes..... sack	6	0	9	0
Celery..... bundle	2	0	3	0	Radishes doz. bunches	0	6	0	9
Cucumbers.....each	1	0	2	6	Turnip.....	2	0	3	0
Endive..... score	1	3	2	6	Rhubarb.....	0	4	1	0
Fennel..... bunch	0	3	0	0	Savoys..... doz.	0	0	0	0
Garlic and Shallots, lb.	0	8	0	0	Sea-kale..... basket	1	6	2	6
Herbs..... bunch	0	3	0	0	Spinach.....sieve	2	6	4	0
Horseradish... bundle	1	6	4	0	Turnips.....bunch	0	4	0	6

TO CORRESPONDENTS.

** We request that no one will write privately to the departmental writers of the "Journal of Horticulture, Cottage Gardener, and Country Gentleman." By so doing they are subjected to unjustifiable trouble and expense. All communications should therefore be addressed solely to *The Editors of the Journal of Horticulture, &c., 171, Fleet Street, London, E.C.*

HEALTHY LOCALITY (T).—Not knowing your constitution, nor any particulars as to your object, we cannot advise you. If we wished to devote ourselves to gardening, and to secure the greatest amount of pleasure from the pursuit, we should select some part of the south-west coast of the Isle of Wight.

ANTS (E. L.).—The answer we published at page 271, gives all the information you require.

FRUIT TREE TRELLISES (A. Calheart).—The trellis in Mr. Rivers's "Miniature Fruit Treatise," is for upright-trained Pears, although he mentions that Peaches and Nectarines may be grown on it in warm gardens. The cordon culture of Peach trees would take too much of our space to describe. "Cordon Training of Fruit Trees," by the Rev. Thos. Briant, of Guernsey (Longman & Co., London), will give you all the information you require on the subject.

SPARROWS EATING CARNATION SEEDLINGS (C. K. R.).—The seedlings will probably produce fresh leaves if the browsing has not been often repeated. We should cover the bed with a net propped up by sticks, until the leaves are too hard for the marauders.

BLISTER ON LEAF OF BLACK HAMBURGH VINE (A Constant Reader).—Your complaint is by no means an uncommon one. It would appear to be an unequal balance in the amount of sap furnished by the root, and the space allowed by the foliage for its due development. A similar evil is sometimes met with in the Peach, the foliage of which, instead of rising in rough, uneven eruptions as the Vine does, generally thickens into a sort of crisp, fleshy, half-salad-like substance. A remedy for such a state of things is out of the question in regard to the out-door Peach; but care and attention will do much to prevent it in-doors. Sometimes a Vine near a door by being exposed to cold draughts becomes so affected; or it may happen, as in your case, that the reciprocal action of the root and foliage in supplying and elaborating sap may have been disturbed. The evil is more one of appearance than really damaging, and the means you have adopted are the most likely to prevent its recurrence.

LOMARIA (A Young Beginner).—We never heard of *L. gibba*. There is *L. Gilliesii*, a native of Chili.

* Roses for the Nyss Shows were plunged in sawdust in a house, but no fire had whistever.

MANDARIN ORANGE SEEDLINGS (J. Roberts).—Your Mandarin Oranges from seed five years old, may perhaps bear in the course of three or four years if confined to rather small pots, and they may not bear for the next seven years. You had better graft them with shoots from bearing trees of the Tangerine or St. Michael's, plunge them in bottom heat, and when grafted, cover them with a hand-glass, and give them no air till the grafts have made young shoots from 5 to 6 inches in length.

VINES IN POTS, PLANTING OUT (T. Holden).—It would be advisable to keep the Vines in pots now in bloom until the fruit is ripe, and plant them in their final quarters immediately afterwards. If the Vines were only just breaking, we would advise you to plant the Vines at once, and to be content with a bunch or two this year, and encourage them to make as much growth as possible; you will then gain a year, and may obtain a good crop of fruit another season.

VARIOUS (Ego-Ego).—1. Apricots, Peaches, and Pears are not propagated from eyes like Vines, but by budding and grafting. 2. Etna, Leopard, The Alliance, Victor Emmanuel, Sunset, and Beauty of Limpsfield, are six good Calceolarias for pot culture. 3. Cuttings of Hybrid Roses can be struck now if you have any forced plants just done blooming. By inserting them in heat they will soon root. 4. We know of no Lily with a hole through the middle. 5. We prefer keeping cuttings in the shade until well rooted, and then a shelf near the glass is the best place for them.

EVERGREEN LEAVES BROWNED (A Constant Reader, Dublin).—We think the leaves are browned with the frost, or it may be occasioned by an immature condition of the foliage. We have no doubt your climate, from its humidity, is more suited for growth than maturation, and frost acting on unripe wood turns the leaves brown as yours are. With us many shrubs that were cut down to the ground in 1860, make gross growths in summer which are not ripe in autumn, and the points of the shoots and the leaves are severely injured with the frost this season, and have been annually since 1860.

CALLA (RICHARDIA) ETHIOPICA—AGAPANTHUS UMBELLATUS (H. M.).—1. Pot the Callas in larger pots before putting them in the tank. 2. Place them in the water so that some of the leaves at least will be above the surface. 3. You may plant them in the tank any time after the 29th of May; but it is preferable to place the Agapanthus on the margin and not in the water, for it is only a sub-aquatic.

PINES AND MELONS IN THE SAME HOUSE (A Tyro).—You may grow these very well as you propose, by the aid of a tank heated by hot-water pipes running through it. If the water in the tank just cover the pipes it is deep enough, or say 7 to 9 inches in depth. The tank should be covered with slates, and soil put upon these to the depth of 10 inches or a foot, and in it the Melons should be planted.

VINE LEAVES SPOTTED (A. M. D.).—The leaves enclosed appear to us to be spotted by syringing the Vines heavily in the morning, and the sun shining powerfully on them whilst wet scorches them. In addition to this we think your glass is of bad quality, and that alone is sufficient to cause the spotted condition of the leaves.

PLANTS FROM AUSTRALIA (An Amateur).—No. 1, *Rossia cordifolia*, is an evergreen greenhouse shrub growing 1 or 2 feet high, and has yellow flowers in June. It likes a compost of sandy peat two-thirds, loam one-third, with a free admixture of silver sand. No. 2 is unknown to us. No. 3, the *Ilakea*, has white flowers with a tinge of rose in them. It grows about 4 feet high, and is a greenhouse shrub requiring the treatment of a Heath. No. 4, the *Pultenaea*, is a greenhouse shrub growing 2 feet high, and has yellow flowers in May. It requires the soil of No. 1. No. 5, *Rulingia* (not *Rubingia*) *parviflora*, is a greenhouse shrub growing 2 feet high, and has white flowers in early summer. It requires a compost of sandy peat. No. 6 we do not know; but we have no doubt that it will succeed well if treated the same as the others, which require the same treatment as *Eriac*.

ERYTHRINA CAITRA (Idem).—It should be kept in a well-ventilated greenhouse, and be syringed morning and evening to prevent attacks of the red spider. It should be potted at once in turfy peat half, loam from rotted turves half, with a liberal admixture of silver sand, putting it into a 12-inch pot, and providing perfect drainage. It will need copious waterines up to July, when it should be kept drier at the root, but not so as to affect the foliage, and it should be kept in the full sun. It ought to flower in August or September, but if not continue to withhold water, and give all the light and air possible. This will favour the maturation of the wood, and on that depends its future flowering.

VARIOUS (A R.).—The longest-podded runner Kidney Bean, is the Tall Dutch. The Scimitar is not the edible-podded Pea. The book you mention is a nurseryman's catalogue.

NAMES OF ORCHIDS (C. F.).—No. 1, *Oncidium ampliatum*, Lindl., the small-flowered variety. The flower with the double labelum is a very remarkable and interesting monstrosity. It has also an extra sepal, so that the two outer floral whorls are quaternary, instead of ternary as in the normal form. Was the flower sent the only one upon the plant, or are there more? If the latter, we shall be very thankful for additional specimens; and it would also be interesting to know what proportion the abnormal flowers upon the plant bear to the normal. Will you favour us with your address? No. 2, is, probably, *Oncidium sphacelatum*, rather than *atissimum*, but it is impossible to decide with certainty without seeing the plant, or a better specimen of it. The term "obsolete," applied to the column-ears, is not to be taken in its strict sense. It merely means that in that particular section the ears are very much smaller than in the closely allied one. A little latitude must always be allowed to such terms. No. 3, *Erides virens* (?). No. 4, *Dendrobium angulatum*.

NAME OF MOSS (Elmwood).—It is *Hybrid proliferum*. It is a common species, found both in highland and lowland districts, usually on the ground, but occasionally on walls, rocks, pebbles, and trees in damp and shady situations.

FORCING LILY OF THE VALLEY (P. B. M.).—The Lily of the Valley is much influenced by soil. The nurseryman would be the best able to tell whether the roots were imported. If the forced plants are put out of doors when done flowering, they will do no good for a year or two. If the leaves are kept healthy and green after flowering, until they decay naturally, the same pots will do pretty well again; but, where the shade is good, it is as well to have fresh plants every year. They will do after a year's growth with less care.

VINES NOT STARTING REGULARLY (M. A.).—We have often very severe weather in January, and the power to give 20° to 24° above the external air is hardly sufficient. We would, therefore, either widen or continue a piece more of the flue, or we would commence forcing in February. If, as you say, you lighted your first fire on the 9th of January, we can hardly think that the buds would be half an inch long on the 26th, with a night heat of 52°. 45° would be enough for the first week, and from 45° to 50° the second and third weeks. We think you must have had heat in the house before. The temperature at night, since the fruit showed, from 55° to 65°, would not cause the Vines to break irregularly, or prevent them showing fruit. The quieter all these earlier processes are conducted, the better will the Vines break. It is better to hurry them a little at a more advanced period, when the heat from the sun can be more freely used. We should object to making your flue so very hot; the Vines will like a lower temperature better in a cold night. It would be advisable to have more flue space. We cannot say anything of the canes without knowing the age of the Vines. Very likely the wood was not so well ripened as those canes that show so freely. Long canes are often the better for being twisted a little round, to make them break regularly. They will also break more regularly if placed horizontally along the house, instead of being trained up under the glass. In the latter case the buds at the point will be apt to break first and strongest. Very strong canes sometimes disappoint, owing to imperfect ripening.

VARIETY OF THE POTATO (W. H. B.).—More than thirty years ago we cultivated a variety like that you describe—"Late, round, medium size; skin dark purple, almost black; inside a mingling of purple and white." We ceased to cultivate it because it was neither prolific, nor superior in quality. Its appearance, when cooked, was also against it. We never heard that it had any name; and no one that we can ascertain, cultivates it.

YOUNG PEAR TREES BLOOMING PROFUSELY (Agnes).—To avoid the consequences from many of the flowers, perhaps, being defective, we would let the most of them remain. You may thin them a little if you make sure of leaving the perfect flowers, as stated lately in "Doings of the Last Week." If not sure on that point, leave them alone, and when the fruit are set and swelling freely, leave from six to twelve on each tree.

SANVITALIA PROCUMBENS AS AN EDGING (W. H.).—As the season is getting late, by all means sow the seed of this plant where it is to remain, taking care, if the edging adjoins the turf, that slugs do not destroy it; to prevent which sow a row of quicklime on each side of the seed line, and cover the latter with sharp sand. It will not flower so early as *Lobelia*, and some other plants, but will look well when it does come on.

CINERARIAS FOR SEED (W. H.).—Flowers good in form are of more consequence than those good in colour; but as you say the bees have been much amongst them it cannot make much difference. We certainly would in all cases give the preference to good form and habit, and when the next batch of seedlings was wanted, select those having good colour also. In general, light-tipped flowers produce something of a like kind; and the crimson and purple self-coloured ones do so also, but it is not by any means universal, neither is it often observed in saving seed. Most growers notice the first opening flowers of each plant, and when one of more than usual excellence appears, the plant is set aside, and put in another place to save seed from.

CHAIN BORDER (J. E. T.).—We should have been glad to have known whether your chain border is on grass or gravel. Whichever it is, your proposed plan will tell well for the parallelograms. Centre Bijou, Purple King round it, and edged all round with *Cerastium*, or, perhaps better, Variegated *Alyssum*. There will be enough of white in the Bijou leaf. The circles between the oblongs would look well filled with Cloth of Gold or Golden Chain, and bordered with *Lobelia speciosa*. If you took the flowers off Bijou all the circles might each have a different dwarf Scar or Geranium, a line of *Aurea floribunda* *Calceolaria*, and an edging of *Lobelia*.

FLOWER-GARDEN PLAN (F. H. R.).—We have no fault to find with your arrangements. We presume the other four quarters are to be planted in a similar manner. We just question whether it would not be as well to make two cross pairs of your four quarters, and then plant them more massively and simply. Thus, suffering 1 to be planted as proposed, and scroll 2 to be planted as proposed, then we would make 3, 3, 4, 5, 5, 6, 7 into two beds at most, or even one bed, consisting of two colours like No. 2. Then 8, 9, 9, 10 might be one bed of two colours, instead of being divided into three. If the quarter cent were the whole garden the dividing of the separate scrolls would be desirable; but as there are four quarters we think the planting them in two pairs, and each quarter more massively and simply, would tell better than cutting them up so much in detail. In No. 2 the Variegated Arabis would do better than the common White. In No. 10 the *Heliotrop* would do better for a centre than the *Saonaria*; and that would do best for the edging, and would contrast better with the purple in 3, 3. But now, if without the dividing of the upper scroll into three distinct beds, we think it would look better as one bed—say a nice row of yellow *Calceolaria* in the centre, a row on each side of scarlet *Geranium*, and a row all round of Variegated *Alyssum*. In parts of deeper bays a few plants of Purple *Jacobaea* may be used, as you propose, between the *Calceolarias*.

FLOWER-GARDEN PLANTING (C. H. X.).—We prefer No. 1, though either would look very well. The *Perilla* would have to be pegged or shortened, for the Yellow Prince of Orange *Calceolaria* is rather dwarf, unless your *Ageratum* is dwarf. In No. 1 we would prefer *Mangliet* for No. 4, and we would make 8 *Perilla*, and 9 yellow *Calceolaria*. In 5 we think that a scarlet *Verbena* would be better than a lilac one.

DEFICIENT BOTTOM HEAT (C. P.).—You seem to be in much the same predicament as to bottom heat as a correspondent a few weeks ago. Two four-inch pipes in a chamber 2½ foot wide, and 2 feet deep, and these pipes quite hot, ought to heat the slate and all the earth, &c., above it. We are surprised that though the pipes are hot the slate continues cold. We can fancy the slate becoming hot, and yet the punging material being cool, from the dryness of the tree leaves placed over the 3 inches of rubble that covers the slate. In such a case, a few small drain-tiles placed upright through the punging medium, for pouring water down on the slate, would give plenty of heat upwards if the slate itself were warm. The pipes would tell all the more on the slate, if instead of being one on the top of another, the two pipes had been placed on the same level, and only a few inches from the slate. The slates would be heated also more thoroughly, if a few small openings, say 2 or 3 inches square, were made close to the bottom of the chamber, as was shown a short time ago as existing in such chambers all *Berkhamstead*.

BLUE WILD VIOLET (*Two Readers and Admirers*).—The wild Purple Violet (*Viola odorata*) is fully scented; the white variety is also scented. They are both common all over England. Late in spring a pale blue Violet blooms, which is scentless; but this is a different species—*Viola canina*, or Dog's Violet.

IMPROVING A PASTURE FIELD (*J. G.*).—Mowing for hay each year is a bad way to secure a good even turf. It would be better to feed it off with sheep, allow the seed-stems to ripen and shed their seed, and early in autumn to give it a good dressing with compost in which a large quantity of good soil forms a part. This by a brushing-in during winter will fill up many of the unevennesses and promote the growth of the young Grasses sown in the autumn. If, however, you prefer having a crop of hay, sow some perennial Grass seeds over the ground in September, and dress it as above, rolling it in the spring. If wet, drain in winter.

THREE CLIMBERS FOR A GREENHOUSE (*J. D. U.*).—For growing in a pot and to train against a rafter, the *Rhynchospermum jasminoides*, one of the *Hardenbergias*, as *inophylla*, or *Glycine*, with *Pasiflora carulea racemosa*, would answer your purpose. There are many others, but those with a good-looking foliage all the year are to be preferred. For a short rafter, some of the *Acacias* look very well, and the old *Fuchsia Corallina* is also good. The best variety of *Abutilon* is also shown from below; but if you rafter exceeds 10 feet, measuring from the pot, try the first three mentioned in preference to the last three.

PLANTS FOR WARDIAN CASE (*An Old Subscriber*).—As you object to Alpines, we would try a *Daphne odora*, two small plants of yellow *Cytisus*, two or three small *Camellias*, and an edging for Chinese *Primulas*, and Musk for winter and spring; and for summer we would have several kinds of *Tabernaemontana*, including the fine-leaved *Zabrina* for the centre, a variety of *Achimenes* round them, and a skirt of *Achimenes coccinea* for a row all round. These roots could be kept all the winter, in a cupboard near the kitchen fireplace, in earth or sand; and when they began to shoot in the spring, in April or May, they could be pricked out in shallow pans or in small pots, and placed out in the case when the winter residents were withdrawn. There need be no end of ways and means of filling such a case.

BUNCHES OF GRAPES BECOMING TENDRILS (*A Constant Reader*).—No doubt the rain running from the roof of your vinery on to the border is bad for the Vines, but the treatment you have given them atmospherically is more likely to have been the immediate cause of your failure; 40° to 50° is far too low a temperature for Grapes at such a stage, and you have aggravated the injurious tendencies of so low a temperature by using the syringe twice a-day. You have just done the very opposite of what you ought to have done with Vines having a tendency to what is called "running." You should have raised the temperature to 65° or 70° at night, and instead of syringing twice a-day you should have kept the air dry, and not a drop of moisture should have been applied to the Vines. A low temperature and damp is the very treatment to cause bunches to run out into tendrils. You should purchase and study some good work on the Vine. Thomson's will suit you. We may just say, that the want of a properly ripened bud the previous season, is the primary cause of the tendency to produce bunches that may be described as half bunches half tendrils. A fuller treatment of the subject will appear in another column.

NAME OF RHODODENDRON (*T. G. H.*).—It is *Rhododendron nivens*, a Sikkim variety.

NAMES OF PLANTS (*J. W., jun.*).—1, a *Brassavola* certainly, perhaps *nodosa* or *tuberculata*, but we are not certain; 2, *Pteris geraniifolia*; 3, *Aepulium flaccidum*; 4, *Litobrochia denticulata*.

POULTRY, BEE, and HOUSEHOLD CHRONICLE.

LONG CONTINUANCE OF SHOWS.

ALLOW me to trouble you with a few remarks in reference to the forthcoming Bath and West of England Poultry Show, which is proposed to be held at Bristol, commencing on the 13th day of June next, and ending on the evening of the 17th, thus lasting five consecutive days. Now, the poultry, including their transit to and from long distances, if they are not negligently detained, as is too often the case, will be at least eight days from their own yards, as they must be penned on Saturday evening the 11th, and cannot be removed until the Saturday morning following.

This seems to me to be not only objectionable, but cruel, and will most certainly cause many valuable birds to be kept back, and very justly so; for what advantage is it if we receive a prize of a couple of pounds, or, it may be, a cup worth five pounds, if we get back a dead bird, or a sickly unhealthy pen of birds, instead of fine healthy pets that gave us pleasure not only in looking upon them, but also in contemplating the many proud triumphs we should have in welcoming them back as winners?

We all know that close confinement in a room is very detrimental to the feathered tribe, and especially when prolonged, the birds possibly fed upon hard corn all the time, with an insufficient supply of fresh water, and, it may be, entirely without gravel, which latter is so necessary to the healthy action of the digestive organs of birds. Some of us know what a sickly state our birds were in for some weeks after the Manchester Show last Christmas, from the cause complained of. It does not matter quite so much where parties living near can go, or send a man to attend to their favourites; but it is of great importance to exhibitors from

a distance that shows should not be unduly prolonged, as is the case with the one in question. I hope these remarks will be responded to by some of our large and influential exhibitors, and that a change may be effected in this particular in some of our forthcoming large shows.—COCHIN-CHINA.

RELATIVE MERITS, PRIZES, AND ENTRIES.

I AM happy to see that at last our local shows are beginning to improve their prize lists by making a class for that often despised, yet not always rejected, Brahma; for although at most local shows they are placed in the "All variety class," yet as a rule they are at least awarded one or more prizes. And now as to the paying part of the business, to which all compilers of schedules should have an eye. Your attention shall be directed more immediately to the late Accrington Show, which was held on the 7th inst., and I will endeavour to prove that, give Brahmas half a chance, and they will remunerate you most abundantly.

Breed.	Prizes offered.	No. of entries.	Amount in entry money
Game.....	£4 5 0	16	£2 8 0
Dorking	2 12 6	10	1 10 0
Cochin-China.....	2 12 6	8	1 4 0
Black Spanish	2 12 6	9	1 7 0
Brahma Pootra	2 12 6	15	2 5 0
Golden-pencilled Hamburg	2 12 6	22	3 6 0
Silver-pencilled do.	2 12 6	14	2 2 0
Golden-spangled do.	2 12 6	13	1 19 0
Silver-spangled do.	2 12 6	13	1 19 0
Any variety.....	2 12 6	13	1 19 0
Game Bantams	2 12 6	10	1 10 0
Any variety do.	2 12 6	12	1 16 0

You thus see by the above that Brahma Pootras stand second where the same amount of prize money is offered. Is not this proof sufficient that they will pay their way? and what do the promoters of poultry shows want better? As to their not being considered by some a distinct breed is nonsense in the extreme, although Mr. Tegetmeier says they are a cross between something, but cannot say exactly what. Let me ask Mr. Tegetmeier or any other man which is the identical breed that entered the ark with Noah? What is applicable to Brahmas applies to almost all other breeds—therefore, for one year, at least, let compilers of schedules give them a class; if they do not pay, they need not repeat the experiment.

A word in conclusion as to a very serious item to "exhibitors in a small way"—viz., railway carriage. Now, I should say, that all railways in the immediate vicinity of a show, ought to give exhibitors some little privileges in the amount charged as carriage; do they not reap a harvest rich enough by the extra number of passengers brought by them to the show? The railway officials at Accrington levied black mail, in the shape of sixpence per hamper, on any poor wight that was caught with one under his arm leaving the train, large or small, no matter how far or how short the distance brought. I saw several poor cottagers who had come as passengers, bringing with them their hampers, who were thus charged, and on returning were not allowed to bring a hamper within the station gates without paying another sixpence per hamper return carriage. It is to be lamented that railway companies will resort to such mean expedients in order to turn a bright penny on such occasions.

The Accrington Committee will do well to make some arrangements with the Company another year, for if not I am sure the Show will suffer.—A YORKSHIRE BREEDER OF POULTRY.

ACCRINGTON POULTRY SHOW.—APRIL 7TH.

TOTAL entries of poultry, 258. There were some very fine birds exhibited, especially the single Game cock of Mr. James Fletcher, Stoneclough. The attendance upon the ground was astonishing; it is estimated that at four o'clock in the afternoon there were about 10,000 people on the Show ground. The want of catalogues was severely felt, as much as 2s. being offered for them, when the real worth was only 6d. The fault was not with the Committee of the Show,

but with the printer, who could not get them ready in time. The following is a list of the prizes awarded:—

GAME COCK.—First and Second, J. Fletcher, Stonecrough. Third, J. Sunderland, Halifax.
GAME.—First and Second, J. Fletcher. Third, A. B. Dyas, Madley.
DORKING.—First and Third, J. Cople, Eccleston. Second, Sir St. G. Gore, Hopton Hall.
COCHIN-CHINA.—First, C. Kershaw, Ashton-under-Lyne. Second, F. M. Hindle, Haslingden. Third, C. Sedgwick, Riddlesden Hall.
SPANISH.—First, W. Cannan, Bradford. Second, W. Harvey, Sheffield. Third, J. Siddall, Halifax.
BEAEMA FOOTRA.—First and Second, H. Lacy, Hehden Bridge. Third, W. Harvey, Sheffield.
HAMBURGH (Golden-pencilled).—First, S. Smith, Halifax. Second, J. Fielding, Newchurch. Third, E. Hindle.
HAMBURGH (Silver-pencilled).—First, Messrs. Hindle & Pickles, Accrington. Second, A. Nicholson, Sheffield. Third, Sir St. G. Gore, Bart., Hopton Hall.
HAMBURGH (Golden-spangled).—First, N. Marlor, Benton. Second and Third, J. Newton, Silsden.
HAMBURGH (Silver-spangled).—First, T. D. Walker, Hoylake. Second, J. Fielding, Newchurch. Third, W. Smith, Woodside.
ANY OTHER VARIETY.—First, W. Cannan, Bradford. Second, E. Leech, Rochdale. Third, F. R. Pease, Darlington.
GAME BANTAM COCK.—First, G. Fielding, Accrington. Second, J. Shortkosc, Newcastle-on-Tyne. Third, G. Maples, jun., Wavertree.
BANTAMS.—First, Sir St. G. Gore. Second, C. W. Brierley, Middleton. Third, J. Munn, Shawlough.
BANTAMS (Game).—First, W. Cannan, Bradford. Second, W. Brierley, Middleton. Third, R. M. Stark, Hull.
TURKEYS.—First, C. W. Brierley, Middleton. Second, J. Cunningham, Blackburn.
GESE.—Prize, T. Honker, Blackburn.
DUCKS (Aylesbury).—First, Sir St. G. Gore, Hopton Hall. Second, E. Leech, Rochdale.
DUCKS (Rouen).—First, J. Munn, Shawlough. Second, E. Leech.
DUCKS (Any variety).—First, W. Moorhouse, Read, Whalley. Second, C. P. Ackers, Bolton House, Wigan.
ORNAMENTAL WATER-FOWL.—First and Second, J. Jennison, Bell Vue, Manchester.

Judges for Poultry: Mr. E. Smith, Middleton; Mr. T. Dodds, Watkinson Hall, Halifax; Mr. Sunderland, Burnley; and Mr. N. Grimshaw, Pendle Forest.

POULTRY AND THE POOR.

PERHAPS this periodical does not often, in its printed form, find its way into the homes of our country poor: they have, alas! little money to spend, and are not quite scholars enough as a rule to master its pages. Although the word "cottage" is on its title-page, yet it belongs—flanked on either side by the titles "Journal of Horticulture" and "Country Gentleman"—to cottages of a higher caste than those of our agricultural poor. But yet I fancy that some of the contents of this periodical in a spoken form may not seldom enter many a country cottage. These, as we all know, are days when visiting the poor is so general. The clergyman is a cottage visitor not only in times of sickness, but he makes constantly recurring calls of kind and neighbourly inquiry as well as his more strictly professional visits. Then there are the good ladies—mothers or their growing daughters, and those helpers in all good works, single ladies passed their girlhood.

Now I ask, Do not both clergymen and lady visitors occasionally come short of conversation?—do they not exhaust the stock of talk? I assure them I do. After the health of all the family has been inquired after, granny's rheumatism—that long story—listened to, whether the children now go regularly to school, how nicely the Wallflowers look—well, what next? I inquire after the live stock, first and foremost about the pig: still, that is a subject soon exhausted. Now, I am sure no wellwisher to the poor likes to see them have a hobby that does not pay. Cats!—well, I would not banish one poor puss at any rate, though here the keepers do; for no sooner does the pet pussy grow to cat age than she leaves mice "and such small deer" for young rabbits, and poaches day after day (my cat brought in six one day). And when she thinks, good easy cat, full surely "her greatness is a-ripening," there comes a bang, a flash, and then she falls as many cats have fallen before her. Dogs I approve not in cottages: the revenue is cheated, the children's food eaten, and their owner generally does a bit in the poaching line. I frown, then, on dogs. Then there are cage birds. I object not—I have not the heart to object—to a linnet or goldfinch, provided it was brought up from the nest; neither do I object to rabbits, which, with industry and kept chiefly during the summer, may be made profitable. I knew a lad who owed his watch to his rabbits;

but then he was no blunderer, had his wits about him, and was very industrious in searching for food. Bowles the poet—once, like myself, a Wiltshire rector—is reported to have said that a row of flower-pots in the window and a birdcage, were the best indicators of worthy cottagers there residing. I cannot say as much for the owners of miserable-looking magpies in rotten wicker cages—filthy the cage, filthy the cottage, bad-looking the bird, worse the owner.

But cannot the poor, the very poor, keep anything besides rabbits with profit as well as pleasure? I answer they can. Next, what? Well, poultry, under certain circumstances and with certain limitations.

"Why not always?" inquires somebody who has been across the water to France for a fortnight, and noticed that all cottagers there seem to keep fowls. Well, the reason, says a friend of mine who resided twelve years in the country districts of France, that such troops of fowls are kept by the humble country classes, is that the corn is so badly dressed that you never get hold of a piece of straw without finding several grains of corn in it; so the fowls live because of the rough dressing of the corn—they thresh it out.

Next, how and when may our cottagers keep poultry with profit? If there be a pond in the village and no valuable grass land close to your cottage, my advice to a cottager is, Get an old hen early in the spring—one not cared for as being past frequent laying, and get also a sitting of Duck eggs. Hurry the ducklings on with good and constantly supplied food; and in nine or ten weeks sell, matching the Ducks to the green peas: but do not keep Ducks save under these circumstances.

Or, again. Having bought your old Dorking hen in February, pen her up, put a nestful of known bad eggs in a corner (the boy that collects eggs at the farm will stand your friend here)—the sight of these will soon make her broody. When she has well taken to them put good eggs under her: this must be in March at the latest, better in February. Mix pepper with rice as part of your food for your chicks. I saw a splendid troop of chickens the middle of last March in Berkshire; they were then six weeks old, and brought up chiefly on peppered rice. Whether

"Who peppered the highest was surest to please"

I know not, but the fact I know, they being the property of a lady with whom I was staying for some days.

Next, the cottager who wishes to profit may follow one or other of these two plans—sell the hen and chicks at a month old, the latter at 6d. a-head; or keep the young pullets (no cock is needed), and then the good wife will have fresh eggs in the winter, always then bought readily at the hall or rectory. Then, further, in the next spring sell the hens, because it is in spring and summer that a cottager gets into trouble with the farmer if he keep adult fowls, while no one but a churl indeed will grudge the chicks or pullets a run in the autumn or winter in their fields.

I have simply stated what I recommend and see followed in my own parish. So, clerical brother or lady visitor, here is a subject for you to talk about and go. COTTAGE GARDENER in hand, and read this paper (how honoured it will be by the ladies' silver voices), or talk over its contents to your thrifty, pet-loving, decent cottagers: the pet part of the business will please the children, the profit their parents. —WILTSHIRE RECTOR.

FOUL BROOD, AND WHAT HAS BEEN WRITTEN ABOUT IT.

(Continued from page 274.)

PRE-EMINENT amongst the scientific and experimental apiarists of America stands the Rev. L. L. Langstroth, whose admirable work on "The Hive and Honey Bee," bears witness to his extensive knowledge of the subject, as well as to his intimate acquaintance with the writings of German authors, whilst our transatlantic brethren are indebted to him for the introduction of the German invention of frame-hives, now in such almost universal use amongst them. He says, "The disease called by the Germans '*foul brood*,' is of all others the most fatal to bees. The sealed brood die in the cells, and the stench from their decaying bodies seems to paralyse the bees. There are two species of foul brood, one of which the Germans call the *dry*, and the

other, the moist or *foetid*. The dry appears to be only partial in its effects, and not contagious, the brood simply dying and drying up in certain parts of the combs. In the moist the brood, instead of drying up, decays and produces a noisome stench, which may be perceived at some distance from the hive." Mr. Langstroth then goes on to describe the German modes of treating foul brood, and adds the following information in footnotes. "Dzierzon thinks that this disease was produced in his apiary by feeding bees on 'American honey' (honey from the West India Islands). As this honey does not ordinarily produce it, he probably used some taken from colonies having the disease. Such honey is always infectious. Mr. Quinby informs me that he has lost as many as a hundred colonies in a year from this pestilence. It has never made its appearance in my apiaries, and I should regard its general dissemination through our country as the greatest possible calamity to bee-keepers. As Aristotle ("History of Animals," book ix., chap. 40), speaks of a disease which is accompanied by a disgusting smell of the hive, there is reason to believe that foul brood was common more than two thousand years ago." Rather an ancient date for a disease which has recently taken English apiarists so much by surprise.

Foremost among the practical bee-keepers of the western world, and at the time his work was written using only good plain hives without frames, comb-bars, or any of the more complicated contrivances of modern science, Mr. Quinby, as has been already stated, appears to have been one of the greatest sufferers from the ravages of foul brood. Considering him, as I do, a good, honest, and painstaking observer, I quote his observations at some length. He devotes a whole chapter to the subject, under the heading of "Diseased Brood," and says:—"This, like many other chapters in this work, is, probably, new, as I never saw one thus headed. A few newspaper discussions are about all that have yet appeared on the subject. . . . I had kept bees but four or five years when I discovered it in one of my best stocks—in fact, it was No. 1, in May and 1st June. It cast no swarm during the summer; and now instead of being crowded with bees it contained but very few; so few, that I did not attempt to winter it. What was the matter? I had then never dreamed of ascertaining the condition of a stock while there were bees in the way, but was like the unskilful physician who is obliged to wait for the death of his patient that he may dissect and discover the cause. I consigned what few bees there were to the brimstone-pit. A *post-mortem* examination revealed the following circumstances:—Ninety-ninths of the breeding-cells were found to contain young bees in the larva state stretched out at full length, sealed over, dead, black, putrid, and emitting a disagreeable stench." As to what caused the death of this brood just at this stage of development, "not the least satisfaction could be obtained. All the inquiries among the bee-keepers of my acquaintance were met with profound ignorance. 'They had never heard of it!' No work on bees that I consulted ever mentioned it. As to remedies, I tried pruning-out all those combs containing brood, leaving only such as contained honey, and let the bees construct new for breeding. It was 'no use,' these new combs were invariably filled with diseased brood! The only thing effectual was to drive out the bees into an empty hive. In this way, when done in season, I generally succeeded in rearing a healthy stock."

Subsequently, Mr. Quinby had so many cases of this kind that he became alarmed, and made inquiry through an agricultural paper as to its cause and for a remedy, offering "a reward for one that would not fail when thoroughly tested." This appeal produced no efficient remedy, but various causes were suggested. One writer connected foul brood with the potato disease (almost as whimsical an idea as that of "INQUIRER," who attributed the outbreak of the disease in my apiary in 1863 to the introduction of Ligurians in 1859!), declaring that "since the potato rot commenced he had lost one-fourth of his stocks annually by this disease." Another said that "dead bees and filth that accumulated during winter when suffered to remain in the spring was the cause." Several others declared that it arose from chilled brood, but Mr. Quinby himself, after duly weighing this suggestion, says:—"I have known the chrysalis in a few stocks to be chilled and destroyed by a sudden turn of cold weather, yet these were removed by the bees soon after,

and the stocks remained healthy. To me the cause assigned appears inadequate to produce all the results with the larvæ. After close, patient observation of fifteen years, I have never yet been wholly satisfied that any one instance among my bees was thus produced."

Dismissing, therefore, this hypothesis, our author proceeds to liken foul brood to such diseases as smallpox, whooping-cough, and measles among human beings, ascribing its existence to contagion in nineteen cases out of twenty. He admits "that some cause or causes adequate to the effect must have produced the first case;" but appears to have failed in identifying it or them. After declaring that his best and most populous stocks in spring are just as liable to foul brood, or even more so than smaller or weaker families, he gives his reasons for the conviction that it is a contagious disease, and that the virus is contained in the honey.* He then points out how one stock that becomes defunct through foul brood is plundered of its infected stores by others, and as these die they are in their turn robbed by a still increasing number of colonies, until it becomes impossible to place a limit to the mischief thus let loose on the bee-world.

I have transcribed so much of the experience and opinions of Mr. Quinby, because they are evidently those of a man of strong common sense and great powers of observation, contending nearly unaided with a great and almost unknown difficulty, and are related in a plain, straightforward manner. Quinby's "Mysteries of Bee-keeping," is a book which will well repay an attentive perusal, and to any one interested in the question (and what bee-keeper is not?) I would especially commend the chapter on "Diseased Brood."

It cannot fail to be remarked, that whilst Mr. Langstroth, probably the most experimental apiarist in America, is able to announce that foul brood "has never made its appearance" in his apiaries, it has, nevertheless, ravaged those of Mr. Quinby to a fearful extent, and that it made its first appearance at a time when he was emphatically an old-fashioned bee-keeper, driving him in self-defence to become an experimental one.

My next and concluding paper will state the opinions entertained on this subject by the apiarists of Germany.—
A DEVONSHIRE BEE-KEEPER.

(To be continued.)

UNITING WEAK STOCKS.

Two hives of driven bees joined and put to work, to all appearance with every prospect of success, the first in July last, have during the winter and spring dwindled away from causes to me unknown; but certainly not from want, as I supplied them liberally. They worked well during harvest in both hives.

No. 1, containing bees of three stocks in eight-leaf hive, one glass side, nearly full of comb, plenty of honey. Examined April 9th, about half a pint of bees, a queen, but no eggs or brood of any kind. These are not working.

No. 2, containing bees of two stocks in five frames, glass sides, kept covered with flannel, in house, about quarter full of comb. Opened and examined April 4th, not more than one hundred or one hundred and fifty bees, found queen easily, a dozen or two of eggs apparently recently laid, a little honey, few cells of pollen. Not working.

To make an attempt to save one hive by joining both is, I think, the only way, destroying the barren queen, for I am sure a careful letting alone in this case must result in the loss of both. But this joining, simple as it may appear to some, if not skilfully managed will not succeed, as I am afraid if the fruitful queen is put at once to those strong in stores, she and her subjects are likely to suffer, as this stock has been set on by its neighbours and plundered. They fought and a great many were killed. I stopped up the entrance, and so they gave up the piracy. Now, there are none going in or out.

If some of your able apiarist correspondents would give their advice on this matter it may serve many, none more than—BEE-FRIEND.

[Read Mr. Woodhury's article in pages 523 and 524 of our last volume, and unite your bees in the manner therein recommended. Use smoke and scented syrup, and if the

* This virus, Mr. Quinby asserts, may be destroyed by boiling the honey

frames of the two hives are not interchangeable, place the fruitful queen with her bees on three or four combs in the centre of the hive, and having removed the barren queen, sweep her subjects from their combs with a feather pretty equally into the empty space on either side. If properly managed success is nearly certain at this season.]

EARLY BREEDING.

I AM much obliged to Mr. Lowe for relating the circumstances under which early breeding occurred in the case of the queen of a stock suffering from dysentery. May it not be that this disease induces a sort of feverish heat in the hive, and that this abnormal state of things promotes egg-laying? Whatever be the cause, there is no doubt of the fact which I have witnessed over and over again, that in a colony afflicted with dysentery breeding continues throughout the winter, and is not checked even when the most complete ventilation has been resorted to, with the view of mitigating the disease. During the winter of 1862-3, I had a very large and handsome Italian princess hatched at Christmas in a hive thus circumstanced, from which I had removed the original queen with the view of rescuing her from the total destruction which impended over the entire colony. Of course, her successor remained a virgin, and ultimately perished with the remaining bees before winter was over.

But this feverish and unnatural state of affairs, resulting only from disease, must not be confounded with early breeding in a strong and healthy stockpossessed of a young and vigorous queen. Accident made me acquainted with the fact that on the 7th of January, 1861, during one of the severest frosts I ever remember, a large quantity of brood in all stages existed in one of my strongest Ligurian colonies, and in this case it proved, as might have been expected, the token of present, and the harbinger of future prosperity.—A DEVONSHIRE BEE-KEEPER.

WHAT IS THE BEST MODE OF MAKING ARTIFICIAL SWARMS?

THE signatory to this note is an apiarian of long standing, who has made the subject of bee-husbandry one of much study and reflection, and takes a deep interest in the various communications of a theoretical and practical character on apiculture that appear in your well-conducted and excellent journal. The object of writing this note is for the purpose of requesting your more distinguished apiarian contributors to write an article on artificial swarms, and to explain and detail fully the process and manipulation adopted, and if possible to state from experience the practical results. The writer has had no small experience in the formation of artificial swarms himself; but the results of his processes and experiments, though conducted with the utmost care and in accordance with the nature and instincts (so far as practicable), of the bee, have not in general been so satisfactory as he could have wished. On the contrary, he believes that the process of forming artificial swarms where universally adopted, and not employed as subsidiary to natural swarming, as he believes it ought to be, is prejudicial to the prosperity of an apiary, and in some cases will effect its complete ruin. He is accordingly of opinion that natural swarms, where they can be obtained with convenience and little risk, are to be preferred, and that an apiary will not flourish long unless the bees are so far left to nature and to their own habits and instincts.

He is aware, however, that some distinguished apiarians are of a different opinion. "A DEVONSHIRE BEE-KEEPER" is one of these, and increases his stock of bees entirely by the process of artificial swarms. Would Mr. Woodbury write an article on the subject, giving the details of the process he adopts and his method of procedure in the case of apiaries consisting entirely of bees located in common straw hives? Where the apiaries are composed of Huber and vertical frame-hives the process of artificialisation can be performed, it may be, with more success, with greater facility, and with less injury eventually perhaps to the bees; but the manipulation is more difficult in the case of straw hives. Mr. Woodbury, the writer knows, has had much

experience in the multiplication of bees by means of artificial processes; and he believes, moreover, that no injury accrues therefrom either to the stock or the swarm. Would he favour the readers of the Journal with a detailed account of the method he adopts in the formation of artificial swarms both as respects apiaries consisting of frame and common straw hives? The writer is desirous of knowing the method of "A DEVONSHIRE BEE-KEEPER" (which he pronounces a successful one), in order to compare it with that which he himself occasionally adopts.—PHILISCUS.

OUR LETTER BOX.

BOOK ABOUT POULTRY (*Herberta*).—"The largest and best work" is now out of print. It is "The Poultry Book," by Messrs. Jobson and Wingfield. You can have a copy free by post if you send a post-office order for 25s. with your address.

WINTER LAYERS (*A Subscriber, Ireland*).—There can be no doubt that early pullets of any of the Cochim-China breeds are the best egg-producers in winter.

BLACK BANTAM (*Black Bantam*).—We have no doubt that the hen died of a diseased liver, and that the disease was the result of over-feeding. Her liver was a fat one, and although she was, perhaps, but a skeleton in frame, her inside was all fat. Free purging in the early stages, and scanty feeding were the cures, or rather the preventives.

HENS PICKING-OFF THE COCK'S FEATHERS (*H. A.*).—We have some fowls that have shown the same propensity. They have, however, their preferences, as they eat their favourite and utterly neglect his companion. He has only his wing and tail feathers left. He is now rubbed all over with sulphur ointment and separated from the hens. This cannibal taste is generally the result of a sickly state of body, and is cured by a grass run. It is only common to those fowls that are in confinement.

HENS FEATHER-EATERS—SWELLING (*L. T. R.*).—Hens peck each other from lack of green food, and from having been fed on raw meat, which is unnatural and a mistake. Do you really mean the rump? Sometimes the hinder parts (or abdomen) of a hen is almost dragged on the ground, especially at this time of year, from difficulty of laying. Oil internally administered with a feather will remedy this, as it is only caused by fever and consequent dryness of the egg-passage. If the swelling is a hard solid mass kill the hen as soon as she has done laying.

POLISH COCK'S CREST DISCOLOURED (*A Subscriber, Chester*).—If the discoloration be the result of dirt, washing will cleanse it; but if it is a gradual change from white to straw colour we know no remedy. Such a change is not uncommon in Black Poland cocks.

SIKCK PIGEON (*Almond, Beechwood*).—I think you need not be in any trouble about your Almond retching. It is not an uncommon occurrence, and I have never known any harm attend it. Yet, should it continue, and the Pigeon appear ill from it, you might try half a rhubarb pill occasionally; but while the bird does not suffer in health I think you had better leave it to nature.—B. P. B.

WHEEZING CANARY (*H. W., Derby*).—Your Canary has caught cold. Change its food. Give it hard-boiled egg, maw and canary seed, and water-cress. Soak a small piece of bread in lemon juice sweetened with sugar, and place in the cage in a pan. Also place a piece of loaf sugar and common cuttle fish between the wires of the cage.

RABBITS EJECTED (*Idem*).—The cause of the young Rabbits being thrown out of the nest by their mother was, no doubt, from there being too many for her to suckle. Nine is too large a number for a young doe at the first litter, and probably she was disturbed by the young being looked at.

DISEASED PIGEON (*J. E. D., Dewsbury*).—Have you tried the following? Give the Pigeon, of the illness of which you complain, a dose of castor oil, and then follow it by cod liver oil daily for some time. If the bird is very weak let her have as much bread as she will eat. The oils may be given mixed in flour or meal in the form of pills. I should like to hear of your success.—B. P. B.

UNUSED BEES (*D. B. jun., Bedfordshire*).—We should unite the queenless ones to the other stock by driving, as described in pages 423 and 523 of our last volume. If you cannot manage this, you may do as you propose, putting the queenless colony on the top, and compelling the bees to work through the lower hive. We do not know where you can obtain a Ligurian comb and queen.

ROOF BEES (*Rusticus*).—The bees, if suffered to remain, will probably swarm, when they should be hived in the usual way. They may be destroyed by brimstone, or a practical apiarian could put both bees and combs into a frame-hive when the cottage is re-thatched. You must yourself decide on what kind of hive will best suit you. If you mean to be scientific and experimental, frame hives are the best; if not, Payne's improved cottage-hive is cheap and good. You will find an extensive assortment of all kinds at Messrs Neighbour & Son's, 149, Regent Street.

TARPAULIN.—*North Briton* would be obliged by a recipe for the composition with which a tarpaulin should be painted.

LONDON MARKETS.—APRIL 18.

POULTRY.

The supply of good poultry is very small, but the trade is unusually dull for the time of year.

	s. d.	s. d.		s. d.	s. d.
Fowls	4	6	to 5	0	0
Smaller do.	3	6	4	0	0
Chickens	2	6	3	0	1
Goslings	6	6	7	0	0
Ducklings	4	0	4	6	0
Pheasants	0	0	0	0	0
Pigeons	0	8	0	9	0
Rabbits	1	4	1	5	0
Wild do.	0	8	0	9	0
Guinea Fowls	2	6	3	0	0

WEEKLY CALENDAR.

Day of M'nth	Day of Week.	APRIL 26—MAY 2, 1864.	Average Temperature near London.			Rain in last 37 years.	Sun Rises.	Sun Sets.	Moon Rises.	Moon Sets.	Moon's Age.	Clock after Sun.	Day of Year.
			Day.	Night.	Mean.	Days.	m. h.	m. h.	m. h.	m. h.	m. s.		
26	Tu	Blue Bell and Buttercup flower.	59.4	36.0	47.7	16	43 af 4	12 af 7	moru.	46 7	20	2 22	117
27	W	Strawberry and Quince flower.	58.1	35.2	46.6	16	41 4	14 7	0 0	52 8	21	2 31	118
28	Th	Beech flowers.	60.2	35.8	48.0	14	39 4	16 7	42 0	5 10	22	2 41	119
29	F	Wych Elm flowers.	61.0	37.7	49.4	12	37 4	18 7	17 1	22 11	(2 49	120
30	S	Lilac flowers.	61.7	40.2	50.4	15	35 4	19 7	46 1	after.	24	2 57	121
1	SUN	ROG. SUNDAY. PRINCE ARTHUR	61.5	39.9	50.2	13	35 4	21 7	13 2	59 1	25	3 5	122
2	M	Oak foliates. (BORN, 1850.)	62.5	39.4	50.4	13	31 4	22 7	33 2	17 3	26	3 12	123

From observations taken near London during the last thirty-seven years, the average day temperature of the week is 60.6°, and its night temperature 37.7°. The greatest heat was 81°, on the 28th, 1840; and the lowest cold, 18°, on the 29th, 1861. The greatest fall of rain was 0.75 inch.

MANAGEMENT OF FIRES.

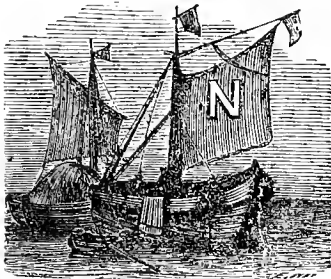

NOT with a view of communicating anything new, nor, in reality, advocating any particular management, am I induced to offer a few remarks on this subject; but having had the management of fires employed for heating various horticultural structures, I feel that I can offer a

few notes that may be useful to many besides "IVY GREEN," to whom the Editors are indebted for directing attention to the subject.

Efficiency and economy should be the aim and result in heating garden structures of any kind. The former depends to a great extent on the construction of the furnace or appliance, but equally on the management; and the all-important question economy is quite as much dependant on the appliances at command as on the careful or, otherwise, careless management of the fires. Efficient heating cannot be accomplished without a properly constructed apparatus, and there is no economy effected by employing an inefficient apparatus. This is the master's affair and the builder's business. It is a false idea to employ an apparatus of questionable efficiency on the score of economy; an inefficient heating apparatus is worthless, and wastes a greater amount in fuel annually than the cost would be of doing the work well at first, and the results are not only discreditable to the gardener's skill, but a source of annoyance to the owner. Economy cannot, therefore, be said to be attained unless it be accompanied by efficiency.

The construction of furnaces, however, is not within my scope at present, for it is assumed that their efficiency is secured, and that the gardener has nothing to do but to manage them. Still it is necessary for those having the management of fires to know that they are efficient for the purpose for which they are intended, and it may not be any great digression to state what I consider the necessary elements constituting efficiency in a furnace. 1st. The furnace should be such as can be lighted and will warm the surface radiating the heat, so that the temperature of the structure will be affected thereby within an hour after lighting the fire, and the greatest heat be attained in half an hour more, or one hour and a half in all. 2nd. After the furnace has attained its greatest heat it should act on the slow-combustion principle, and maintain the temperature of the heating surface without working the fire hard. 3rd. It should have a good draught that can be regulated at will. 4th. It should hold a quantity of fuel, and yet burn less or no more fuel than a furnace needing attendance every hour or two; whereas a properly constructed furnace will only need the fire attended to every six hours in the daytime,

and every twelve hours at night. 5th. The fire should command a steady heat, and be neither very soon hot nor very soon cold. 6th. It should be rather above than below its work—that is, the temperature required should be raised and maintained without heating the radiating surface too highly, or to the highest point possible to maintain the proper temperature within the structure required to be heated; for heat generated at a high temperature from a small radiating surface is extremely pernicious to vegetation in its immediate vicinity.

I need not enter into an explanation of the points I consider necessary to constitute efficiency in a furnace, for the points themselves convey their own meaning; but I will proceed with the question under consideration. The first essential to the management of fires is regulating the draught. All fires should have a good draught, and this should be regulated by some contrivance, so that from the maximum it can be reduced to the minimum. Dampers have been employed with success for this purpose, and in some cases close-fitting furnace and ashpit doors. The former I have found attended with some evils, and the latter are not always so close-fitting as to keep the fire in check. Where the furnace and ashpit-doors are made to slide and fit so closely as not to allow air to pass through into the furnace in such quantity as to cause the fuel to burn more rapidly than is necessary to secure the proper condition of the fire, I am persuaded that is the best and safest method of regulating the draught.

It is not always possible to obtain close-fitting furnace and ashpit-doors, and where there is a good draught, and the doors do not fit well, a damper becomes absolutely necessary. An advocate for dampers I am not, though there is no fault to be found with them, but it frequently happens that too little attention is paid to them, and the results are very often disastrous. Misfortunes through them very often happen in this way: the fire is worked hard, and the flue, &c., becomes too hot; then away those in charge run to the damper, and it is thrust in, so that there is not room for the vapour to pass up the chimney, and the results are a smoky flue and a number of plants injured by the vapour. Many flues, indeed, are burst through thrusting the dampers in too closely, and to prevent such mishaps it is important to have the dampers so constructed that they cannot be shut so as to completely close the chimney. They should, nevertheless, be so made as to exert a great influence on the draught, reduce it to a minimum, and yet leave an opening in the flue for the smoke to pass by and out of the chimney. I recently saw a new description of damper in the greenhouse of an amateur which I thought a great improvement on the old-fashioned pull-out and thrust-in damper, and I was told it answered admirably. It was formed of a piece of sheet-iron rather less than the width of the flue inside, so that it might work easily, and 6 inches wider than the flue the other way. Across this a half-inch iron rod was rivetted lengthwise, but 6 inches nearer one end from the centre than the other, and of sufficient length to enter a socket fixed in the flue-wall on one

side, and to pass through the opposite wall into the greenhouse on the other, and to this end an iron handle was fixed. The sockets were formed of half-inch gas-piping, and so fixed in the walls of the flue that the damper would not shut within an inch, so that the sockets should be one inch from the centre of the flue on opposite points. When fixed the long end of the damper was downwards; shut or open it was the same, and owing to its slanting position soot could not lodge upon it and choke the opening left for the smoke to escape by, but the soot fell to the opposite side of the flue, even when the damper was shut. The latter never could be so far closed as to stop the draught completely, and soot could not rest upon it and so close the flue and prevent the passage of the smoke. I considered it worthy of noting, especially as it was the handiwork of a person with a small income devoting his leisure to horticultural pursuits. He told me he disliked dampers fixed transversely in flues, especially when they closed the whole of the flue; but even if they did not, soot sometimes fell down the chimney and lodged upon the horizontal damper, completely closing the opening left, and the result was a smoky flue and a house unpleasant to the smell, and the effect on the plants was extremely injurious, if they were not killed outright. His damper, on the contrary, was easily regulated by the handle, and was an efficient and cleanly apparatus not liable to get out of order.

To commence with lighting the fire. Before a fire is lighted it should be known beyond doubt that the furnace is clean and in good working order; that the furnace and ashpit doors, together with the damper (if there is one), are in proper order; that the flue has been properly cleaned, and examined to see that it is not full of cracks; or if there be a boiler, that all the flues in connection with it have been properly cleaned and put in order. All repairs, whatever they may be, should be done before the fire is put on, for it is useless repairing anything after an accident, which could by a little forethought have been made unlikely, and it costs less to keep anything in repair than to let it run to ruin for want of a slight expenditure, and, perhaps, have to replace it. Now, a fire should be lighted bit by bit—that is, very little fuel indeed should be put upon the quickly-igniting materials at once, and they should be put on by little and little until a good fire is made. When the fire is first lighted the furnace-door should be shut, the ashpit-door open, and the damper drawn out. Fresh additions of fuel should be made as the other ignites, and be carefully attended to, so as to obtain the greatest heat from the least possible consumption of fuel in the shortest time.

When the fire becomes large enough for raising the required heat, the ashpit-door should be partially closed, so as to favour the slow combustion of the fuel by diminishing the draught, and in order that the surface to be heated may be raised to the proper temperature slowly, for a sudden change is inimical to vegetable life. When the fire attains sufficient heat for the purpose it is intended to serve, it should be "made up"—that is, more fuel is put on if necessary, or if sufficient be on the fire to serve a given time—say six hours, it is only necessary to lessen the draught, so that the necessary heat may be maintained with the least consumption of fuel. There is no rule by which this can be governed; but practice alone can teach what is to be done. If, however, the draught be what it should be, and the required temperature is attained, the ashpit-door should be closed almost completely, if not quite; and if this is not sufficient to keep the fire in check, the damper must be brought into requisition. Unless the ashpit-door fits badly, and the draught is exceedingly strong, there will be no necessity to employ a damper except on special occasions, such as when the wind is strong and increases the draught considerably; then a damper is useful, otherwise I do not acknowledge its utility.

(To be continued.)

G. ABBEY.

THE HORTICULTURAL EXHIBITION AT BRUSSELS.—APRIL 24TH TO MAY 6TH.

If there are any of our readers—and we strongly suspect there are many—who indulge the idea that we in England surpass all the rest of the world in the way we get up our

horticultural exhibitions, let them at once banish it from their minds, for it is a popular fallacy which is likely to become as fixed as that other of our boyish days, that "one Englishman is able to beat three Frenchmen at any time." Now as, on the contrary, it takes a very good Englishman to beat one very good Frenchman, so it is as true that in many points we come far short of our continental brethren in the way in which we get up our horticultural exhibitions.

The striking feature of our great London exhibitions is colour: in this one at Brussels it is colour and form combined. With us the arrangement is stiff, formal, and monotonous: here it is graceful, flowing, and picturesque. On entering one of our exhibitions—take the Royal Horticultural or the Crystal Palace as an example—the plants are arranged in a series of parallelograms either stuck end to end, or, for variety's sake, sometimes set at right angles to each other, and running end to end in another direction. Such an arrangement admits of no scope for varied outline; and the long monotonous lines of tables, or "stages" as we call them, produce no more the effect desired than a long avenue with a primly cut Yew hedge on either side of it furnishes us with the landscape effects which are so skilfully produced by the artistic planting of our parks and pleasure grounds. The Regent's Park exhibitions are not so open to this objection; but there is still remaining that one of glaring colours unsubdued by the neutral tints and unbroken up by flowing outline, which is so striking in the Exhibition at Brussels.

But so long as our plant-growers and judges preserve their present views as to beauty of form so long will this state of matters continue. So long as our Azaleas are to be shaven close and even like the surface of a balloon, instead of being encouraged to make a flowing, undulating, and towering outline, and our Pelargoniums, Roses, Ericas, and, in short, almost everything else, are to be reduced to the same standard, so long must this stiff and formal state of matters continue with us. Instead of encouraging the natural habit of the plant, the object with us appears to be to distort it as much as we can to our own artificial standard—a system which, in our opinion, might be greatly modified, and might be rendered highly beneficial in improving the effect of our horticultural exhibitions.

The Brussels Exhibition is held in a large erection situated in the Place du Trône, and covers a superficial area of 45,000 square feet. It is covered in by a ridge-and-furrow roof, which is supported by planks about 12 feet high, and the ridges of the roofs are about 5 or 6 feet higher. The whole is enclosed on the sides and on the roof with canvass, except one portion on the north, where the sides are covered with feather-edge boards.

On entering the enclosure in front we saw at once that this was no ordinary "Flower Show," but a perfect Horticultural Exhibition, embracing all the branches of the art; for the first objects that caught our eye were some splendid examples of fruit-tree training. They were living specimens of several years' growth, and all in full bloom. These consisted mainly of Pears and Plums, with a few Peaches, planted in large tubs, and all, apparently, looking perfectly thriving and as if they had never known any other condition. There were also numerous exhibitions of boilers, edgings, implements of horticulture, summer-houses, examples of glazing, &c., all of which we shall enter more minutely into when we come to treat specially on these subjects.

Proceeding to the entrance to the Exhibition one might have fancied he was entering a semi-tropical region, so dense and umbrageous were the Palms and the tree Ferns that just obscured the blaze of the Azaleas beyond them, and which were reflected in a series of large mirrors artfully placed behind at various angles, so as to reproduce all within their scope to just double the extent it really was.

As we entered the interior, immediately fronting us was a magnificent specimen of *Latania borbonica* raised up on a mass of ornamental rockwork, ornamented with patches of moss. This at once arrested the eye and had the effect of breaking up the mass, so that the attention was not directed to any particular object. The great hall is a sort of parallelogram, lofty, spacious, and well-proportioned, and the plants are grouped in irregular masses, these masses rising from the very floor in an undulating and broken outline to the height of 10 or 12 feet, and one mass of colour, which, how-

ever, was relieved by the Palms and Ferns with which they were flanked and surrounded. All along the walls were large specimens of fine-foliaged plants, composed principally of Palms, tree Ferns, Caladiums, Grevilleas, &c., interspersed here and there with a fine specimen of a Camellia or Rhododendron, which has the effect of enlivening what would otherwise have been a dense mass of green; but which, even if the flowering plants had not been there, could not have looked heavy, because of the gracefulness of the habits of the plants chosen, the play of light that was admitted through their foliage, and the consummate taste with which they were arranged. Above the line to which vegetation reached, the space was decorated with shields at certain distances, draped with the national colours, and bearing on their field the Belgian Lion, the arms of the city of Brussels, and the monogram of King Leopold alternately. The tropical department was partitioned off from the body of the building like that at the Crystal Palace at Sydenham, and was heated with hot water. Here the walls were decorated with plans of parks and pleasure grounds on a very large scale, paintings of flowers and fruits, and designs for garden architectural decoration. Many of these plans possessed great merit, both in the design and execution of them; but those that were most worthy of notice in this respect were exhibited by M. L. L. Le Breton, of Paris, who received the first prize. Among the other works of this description that were exposed in this department were Warner's "Orchidaceæ," the "Annales de Pomologie," and a work now publishing at Brussels, illustrative of the Fruits and Flowers of Java. The effect of the whole was beautiful and telling in the extreme.

But let us now proceed to the examination of what properly forms the substance of the Show. In this we must necessarily fall far short of accomplishing the task before us, for when we state that there are 155 classes, and that these are not arranged as at our shows consecutively, nor are the various exhibitions in each class kept together, but dispersed in all directions over the building, for the purpose of producing an effect, it will be evident that the task of furnishing a consecutive and complete report is next to impossible; besides, the space to which it would extend would be so great, that we shall confine ourselves merely to a few observations on the leading classes.

Beginning with Class 1, which is for collections of seventy-five plants in flower in fifty species or varieties, we have some groups that told with considerable effect. They were arranged in the angles and against the walls of the great hall. The most attractive of these was exhibited by M. A. Verschaffelt, of Ghent, the plants composing it were the best grown and most tastefully arranged, and, besides, it contained by far the most select and choice species. There were large plants of Acacias such as Drummondii, Grevilleas, Azaleas, Cytisus, Polygalas, Eriostemons, Rhododendrons, Ericas, Chorozemas, Adenandra, and many such plants as we used to see in our exhibitions at home years ago, and which we hope some day to see again when we become a little more purely horticultural than we have been lately. The prize for this was the great gold medal offered by the Duke of Brabant, and was won by M. A. Verschaffelt.

Class 2 is for fifty species or varieties of plants in flower in thirty species or varieties. The best of these, which received the gold medal, was exhibited M. Van den Ouwelant, of Laeken, and occupying a corner by the entrance to the tropical department formed a segment of a circle 30 feet round. It rose in a conical form, the apex being terminated by a magnificent specimen of Hybrid Rhododendron grown in a pyramidal shape. The sides were flanked with double white Camellias 10 or 12 feet high. In the centre was a Pomegranate in full bloom, a fine specimen of Cytisus, a scarlet Rhododendron, and a white Azalea indica; the mass being filled up with Azaleas, Grevilleas, Dracenas, Strelitzias, Deutzias, Roses, tree Pæonias, &c. We cannot possibly find time nor space to notice all the collections in this class, and will therefore proceed to notice the subjects of interest from their novelty.

Class 5 was for collections of twelve new plants directly introduced into Europe by the exhibitor, and which are not found in commerce. Here we find M. Ambroise Verschaffelt, of Ghent, M. Linden, of Brussels, and Mr. Veitch, of Chelsea, entering the lists together. Mr. Veitch's collection

was composed of a splendid new Maranta named Veitchii, in memory of the late Mr. Veitch, from the circumstance of its being one of the last plants introduced by the house before his death. The leaf is a foot to 15 inches long, and 8 to 9 inches wide, beautifully marked on the upper surface with zones, having a vandyked outline; the centre is yellowish green, foliating as it were from the midrib; this is encompassed with a zone of very dark bluish green, that again by another of yellowish green than the centre, then the whole is margined with a broad band, vandyked on its inner margin, of deep but bright green. No two of the zones, nor the centre, have the same shade of colour; and these markings extend through the substance of the leaf to the under surface, which is entirely of a purplish tinge, the zone corresponding with the dark blue green one on the upper surface being of a deep claret colour. Then there was a beautiful specimen of that lovely Fern *Leptopteris superba* from New Zealand, *Dracena Cooperii*, *Echites* sp. nov., *Eranthemum tuberculatum*, *Retinospora Veitchii*, *Eranthemum* sp. nov., *Pteris serrulata cristata*, *Maranta striata*, and *Primula cortusoides amoena*. M. Linden had a nice plant of *Mappa fastuosa*, *Phrynium majesticum* (a plant which has a close resemblance to *Maranta albo-lineata*, but rather a stronger grower), *Maranta transparens*, *M. picturata*, *Crescentia Liboniana*, *Philodendron amazonicum*, *Cissus amazonica*, *Medinilla parasitica*, *Asplenium alatum*, *Sphærogynne cinnamomea* (which is a pretty plant, covered with light cinnamon-coloured tomentum), *Rhopala elegans*, and a plant from Rio Negro, not yet named. In M. A. Verschaffelt's collection there were some very remarkable and interesting plants. A fine specimen of *Cibotium regale*, a beautiful tree Fern between *Schiedei* and *princeps*. The bases of the fronds and the upper part of the caudex are covered with dense long silken hairs, and the young fronds, just before they uncoil, are enveloped in a thick pod of this same covering. *Amorphophallus nivosa* is a very unique plant, singular and elegant, with a great deal of what, when applied to the human form, would be called a statuesque appearance. It is an *Arad* with a tall tapering naked stem, 6 to 7 feet high, crowned on the summit by three leaves, which radiate from the centre, and which are pinnated; the pinnae clothed with decurrent pinnules. These leaves spread out like an umbrella, in an horizontal direction. The stem is 8 inches in circumference at the base, and tapers upwards like a billiard cue. It is beautifully variegated with dark green and ashy grey bands, much in the way of *Alceasia zebрина*. It is a fine thing, and will be valuable for planting out in summer on those sub-tropical beds that are now becoming so common in our best establishments. *Maranta splendida* is also a good thing, with a dark centre and yellowish green zone. Then there were *Amaranthus versicolor*, *Dieffenbachia gigantea*, *D. spectabilis*, *Caladium Leopoldi*, a lovely little Palm called *Regelia* (?) *majestica*, *Achyranthes Verschaffelti*, *Phrynium Van den Hecke*, *Dieffenbachia Baraquiniiana*, *Caladium albo conspersam*. The first prize for this was the gold medal, obtained by Mr. Veitch; and the second, a silver gilt medal, framed, was gained by M. A. Verschaffelt.

Class 6 was for a collection of plants introduced to Europe not before 1863. The great object of attraction here was the female *Aucuba japonica* full of fruit, exhibited by M. Verschaffelt, and with which many of our readers are familiar as being shown at some of our spring meetings by Mr. Standish of Ascot. This received the gold medal. The most remarkable plant in the collection exhibited by M. A. Van Geert of Ghent was one of *Kingia australis*, with a caudex about 15 inches high, and furnished with long leaves that hung down gracefully over it, and extending below the pot.

In Class 7 for six new plants directly introduced into Europe by the exhibitor, Mr. Veitch had *Primula cortusoides alba*, a fine specimen of *Alocasia zebрина*, *Eranthemum rubro-nervium*, *Camellia sesanqua fol. var.*, *Hibiscus Cooperi*, and *Pouretia pungens*.

M. A. Verschaffelt sent *Dieffenbachia grandis*, *Caladium Duc de Nassau*, *Smilax maculata macrophylla*, *Amaranthus amoenus*, *Smilax lancifolia*, and *Caladium Rougierii*; but as some misconception took place as regards the interpretation of the wording of the schedule, neither of these was awarded a prize.

Class 8 consisted of three new plants exhibited for the first time in flower. Mr. Veitch was the only exhibitor, and obtained the silver-gilt medal with *Primula cortusoides anona*, *Dracophyllum* sp. nov., and *Phalænopsis Lobbii*.

Class 9 was for an exotic plant in flower, newly introduced into Europe. Mr. Veitch was here again, and showed that singularly grotesque little plant *Anthurium Schertzerianum*. M. Linden sent *Grevillea pteridifolia*; and Dr. Von Siebold took the silver-gilt medal with a beautiful new double-blooming Japanese *Cerasus*; Mr. Veitch being second.

Class 11 was for seedlings; and foremost among these was a hybrid *Cattleya* from Mr. Veitch's establishment, raised by Mr. Dominy, and which M. Reichenbach on the occasion has named *Brabantæ*, in compliment to the Duchess of Brabant: this received the first prize. Then there was *Rhododendron* Countess of Haddington, exhibited by Mr. Robert Parker, of Tooting. This is a pure hybrid between *Dalhouisia* and *ciliatum*, and possesses the habit of the latter with the flower of the former, is perfectly hardy, and one of the best hybrids that have yet been raised of the class. To this the second prize was awarded. Then Mr. Veitch's *Rhododendron* Princess Alice was diffusing its fragrance all around.

Passing on to the Orchids we found several fine collections in good condition. The principal exhibitors were MM. Linden, A. Verschaffelt, Beaucerne, and Mr. Veitch of Chelsea.

For the special gold medal offered by Her Royal Highness the Duchess of Brabant, for the best collection of twenty-five Orchids, the competition was very keen, the prize being won by M. Linden, of Brussels. The most remarkable plants in this collection were two fine plants of *Vanda suavis*, and no less than seven well-bloomed varieties of *Vanda tricolor*; the rare *Vanda Cathcarti*; *Cypripedium Hookeri* and *Lowii*, with three fine flowers, *hirsutissimum*, and *villosum*; *Cattleyas* *Schilleriana*, *amethystina* and *Skinneri*; *Phalænopsis amabilis*; *Dendrobium Dalhousianum* and *densiflorum*, the latter having ten fine spikes of bloom; *Arides Fieldingii*, &c.

Next in order came M. Verschaffelt's collection, containing, amongst others, the beautiful *Phalænopsis Schilleriana*, a fine plant of *Odontoglossum hastilabium*, *Dendrobium infundibulum*, and *macrophyllum gigantum*, four plants of *Vanda suavis*, *Oncidium sarcodes*, *Chysis Limminghi*; and, in addition to these, a beautiful assortment of *Cypripediums*, comprising *Veitchi*, *Hookeri*, *villosum*, *barbatum*, *majus*, and *hirsutissimum*.

In the Class for fifteen Orchids Mr. Veitch won the gold medal with some beautiful specimens in good condition, considering the distance they had so lately travelled. The most remarkable were *Odontoglossum Pescatorei* and *nævium*, *Cymbidium eburneum*, with four good flowers, a magnificent variety of *Lælia purpurata*; *Dendrobium Dalhousianum* and *densiflorum*; *Cypripedium Lowii*, *barbatum majus*, and *Hookeri*; *Cattleya Skinneri*, &c. The second-prize collection was in very poor order. The silver-gilt medal for the best specimen Orchid was also won by Mr. Veitch with a beautiful plant of *Cypripedium villosum*.

Before leaving the Orchideous plants we must notice four fine plants of *Vandas suavis* and *tricolor*, shown by M. Canard d'Amal, an amateur of Malines. These plants showed very good cultivation, each having two or three fine spikes of bloom.

The prize offered for a collection of *Nepenthes* brought but one exhibition, which was sent from London by Mr. Veitch. It comprised very fine specimens of *Hookeri*, *Rafflesiana*, *Dominiana*, *ampullacea*, *ampullacea vittata*, and others. This class of plants is not generally grown on the continent, and the curiously-shaped pitchers hanging from the ends of each leaf attracted great attention.

To proceed any farther would be a hopeless task, for we could not possibly in one or even half a dozen such reports as we have now given exhaust the subject were we to treat all the classes in this way. We shall merely specify what formed by far the most effective part of the Exhibition, by remarking that the Palms, the Cyads, and tree Ferns, the species of *Pandanus*, *Arads*, the *Dracænas*, *Pincinctias*, *Agaves*, and other fine-foliaged gigantic *Lilacæ*, and, indeed, whatever tended to give effect by their foliage, were taken advantage of. These were contributed mainly by M. A. Verschaffelt, M. Linden, MM. Bruylant frères of Brussels, Madame Legrette d'Hans of Antwerp, M. Van den Hecke de Lembeke, M. Van den Ouwelant, M. Vander-

maelen of Molenbeck-St-Jean, M. Van Geert of Ghent, and M. J. Verschaffelt of Ghent.

We may again return to this subject, and notice some of the most salient points in it, many of which must necessarily be omitted in a report which has been got together in so short a space of time. And here we must tender our thanks to M. Linden, through whose kindness we have been enabled to furnish any report at all; for, on our arrival at the Exhibition on Friday, we were expressly told that no person whatever could be admitted to the building when the Jury were going round; that no tickets were permitted to any but the Jury; and that if we wanted a report we must make it on Sunday. Such an arrangement would not suit us in any way, and it was only by urgent representation on our part and a condescension on that of the Council that we succeeded. We hope that in future, if these exhibitions are to be repeated, that the Council will see the advantage of having as much publicity given to their Exhibition as possible, and that they will, as is the case with us in our London exhibitions, allow members of the horticultural press to be admitted not by favour but by courtesy at all convenient times, and that they shall not be compelled, as we were, when once in the building to remain there from seven o'clock in the morning till four in the afternoon, in defiance of all Nature's wants, or run the risk of being denied re-admission. Let the Secretary in future be authorised to issue a free pass for such members of the horticultural press as may apply for them, and the Society will be neither the poorer nor the less thought of for the concession.

All the preliminaries of arrangement and judging being completed on Saturday, the Exhibition was opened to the public on Sunday. The King and the Royal Family arrived at half past twelve. The King was conducted round by M. Linden, the Duke of Brabant by M. Ambroise Verschaffelt, and the Count of Flanders by M. Funk. This did not quite accord with our English ideas, which have been trained to regard lords and baronets only as qualified for such honours; nurserymen being accorded such a privilege merely when they are fortunate enough to be a member of council, and even then they must be content to take a subordinate position in the retinue.

THE ROYAL HORTICULTURAL SOCIETY'S THIRD SPRING SHOW.—APRIL 20.

A DAY more bright and summer-like than that on which this Show was held could not have been wished for or expected in the month of April; and notwithstanding counter-attractions elsewhere, the result was a large attendance of visitors. Azaleas and Roses were the principal features on this occasion, and the display which they made was most brilliant and effective; nor were other plants wanting, for the miscellaneous collections of flowering plants and the varied objects submitted to the Floral Committee were full of interest.

AZALEAS.—Mr. Turner was far in advance of all other competitors, his plants being those large, dense pyramids of bloom which he is in the habit of showing, and trained with his usual skill. One of his plants, *Broughtoni*, was most magnificent. It was some 6 feet high, and being placed between two splendid white-flowered plants, *Mary* and *Fielderi*, its glowing colour was set off to the greatest advantage, and, indeed, was dazzling to the eye. *Trotteriana*, violet rose, and *Gledstanesi*, white, were also very fine; the others were *Stanleyana*, rosy scarlet; *Duc de Nassau*, with very large purplish crimson flowers; *Rosalie*, salmon; and *Standard of Perfection*, rose. Messrs. Lane, of Berkhamstead, who were second, had *Chelsoni*, fine scarlet; Whites—*Louise Margottin*, *Iveryana*, and *Magnificent*; *Criterion*, *Lateritia*, *Eulalie*, and *Murryana*.

In the Amateurs' Class the first prize was taken by Mr. Todman, gardener to R. Hudson, Esq., Clapham Common.

In the Open Class for six plants, Mr. Turner again took the first place with *Holfordi*, rosy purple, a splendid specimen; *Criterion*; *Gem*, scarlet, very fine; *Iveryana*; *Model*, bright rose; and *Union*, a fine mass of mixed red and white flowers. Messrs. Lane were second, with *Juliana*, *Chelsoni*, fine; *Reine des Belges*, a fine red; *Iveryana* and *Louise Margottin*, white; and *Rosea albo-cincta*, rose edged with

white. The third-prize lot was from Messrs. Dobson, of Isleworth, and it contained a small plant of William Bull, with very large and fine violet crimson flowers; Reine des Doubles, bright rose, very attractive; and Souvenir de l'Exposition, delicate lilac blush with violet crimson spots.

In the Miscellaneous Class, Messrs. F. & A. Smith sent baskets of Flag of Truce which is always fine; Prince of Orange, orange scarlet, fine form; and Clapham Beauty, rosy pink. Messrs. Lane had an extra prize for a score of Azaleas, among which were Rubens, with very large flowers of a fine deep red, and several compact good specimens of kinds already named.

ROSES.—The great struggle was in the Nurserymen's Class for nine in pots, and Mr. Turner was successful in carrying off the first prize with plants the merit of which was unquestionable; they were not large but compact, with splendid foliage and magnificent blooms. Hybrid Perpetuals Victor Verdier, Charles Lawson, Senateur Vaisse, and Baronne Prevost; Bourbon Souvenir de Malmaison; and Tea Comtesse de Ouaroff, were particularly fine. Mr. W. Paul was second, and Messrs. Paul & Son third; and extra prizes were awarded to Mr. Francis, of Hertford, and Mr. Treen.

New Roses were shown in great force, and in one or other of the different collections almost every variety sent out in the last two years was to be found in greater or less perfection. The most extensive collection was that of Messrs. Paul, to whom the first prize was awarded; Mr. Turner taking second; and Mr. W. Paul third; the plants of the two latter exhibitors, however, being the finest in growth. Of Hybrid Perpetuals—Le Rhône, Madame William Paul, Lord Macaulay, Baron Adolphe de Rothschild, Pierre Notting, Jean Goujon, Lord Clyde, and Lord Herbert were very fine. Vainqueur de Goliath was very large and brilliant in colour; Deuil de Prince Albert on the contrary, though very distinct, is scarcely pleasing to an English eye. Tea Alba Rosea, was a pretty white with a pale rose centre; and Mlle. Adèle Jougant, a good yellow. H.P. Murillo was large and full, and remarkable for the richness of its colour.

Of cut Roses eight beautiful boxes came from Mr. W. Paul, and six from Messrs. Paul & Son, to both of whom extra prizes were given; and Mr. Batley, of Rugby, had a similar award for a single box. To lovers of the Rose these cut blooms afforded a wide field for comparison and selection, and before them the public lingered long.

CINERARIAS though in good bloom were not remarkable. Among those shown were good plants of Duke of Cambridge, crimson self; Lord Elgin, ruby; Miss Smith, white, blue edge; Miss Franklin, large white with rosy purple edge and dark disk; Perfection, white, rosy carmine edge, fine; Regulator, blue self; Adam Bede; and Queen Victoria. The first prize was awarded to Mr. James, of Isleworth; and the second to Mr. Marcham, of Hanwell, both in the class for six; and in that for four plants, Messrs. Dobson also exhibited a collection not for competition, containing some very well-grown plants.

AURICULAS AND POLYANTHUS.—For Auriculas, Mr. Turner, of Slough, who was the only competitor in the Nurserymen's Class, took the first prize with Ensign, a new Grey-edged sort shown before the Floral Committee last year, and fine examples of Union and Conqueror; White-edged—Maggie Lauder, Fletcher's Mary Ann, and Taylor's Glory; Green-edged—General Neill, Sir H. Havelock, and Stretch's Alexander; Selfs—Othello (very fine), Mrs. Sturrock, and another. In the Amateur's Class for eight, two of a kind, Mr. Potts, of Glengall Grove, Old Kent Road, was first; Mr. James was second; and Mr. Butcher, Camberwell, third. Among them were good examples of Syke's Complete, Union, Countess of Wilton, Lord Yarborough (fine), Mayflower, Sims' Eliza, Lightbody's Meteor Flag, and Spalding's Blackbird. In Alpines, Mr. Turner was the only competitor and had a first prize.

For Polyanthus, Mr. Turner had the first prize for Lady Milner, very perfect in lacing and outline; Defiance, pretty in colour but rather starchy; Santarara, large pips and finely laced; Warrior, Lady Abingdon, and Highland Mary. Mr. Butcher was second.

PANSIES.—A few stands of these were shown. The best came from Mr. Bragg, of Slough, who had a first and third prize; and Mr. James, of Isleworth. Rev. H. Dombrain

(dark self), Beautiful Star, Attraction, Black Knight, and Miss Carneggie, were a few of the best. Mr. Treen, of Rugby, had also a stand. Mr. Bragg was the only exhibitor of Fancy Pansies in pots.

MISCELLANEOUS.—The Miscellaneous Class, as usual, was a very large one. Messrs. Veitch had a first prize for a collection of flowering plants, in which were several fine Azaleas, *Eriostemon pulchellum*, *buxifolium*, and *neriifolium*, the last two very large and fine plants; and *Boronia tetrandra*. Mr. Bull received an extra prize for a collection, in which were several of the newest Azaleas, the fine deep red Rubens, *Rhododendron Victoria Regina*, a leaf of the remarkable *Pogonia discolor*, and a number of other scarce plants. Mr. Williams, of Holloway, had also an extra prize for a similar collection, in which were the white-flowered *Rhododendron Edgworthii*, *Cypripedium Lowii*, *Dendrobium infundibulum*, &c., and the same exhibitor sent what was by far the most remarkable object in the Show, a plant of *Kingia* or *Xanthorrhoea australis*, one of the Grass Trees of Australia, and which was probably some centuries old. The stem, which was almost black and resembling that of a tree fern, was surmounted by a head of Rush-like foliage. This received, and well deserved, a first-class certificate. Mr. Williams also had a collection of nine *Amaryllids*, a race of plants of which he possesses a good selection; also a spike of the magnificent white-flowered *Rhododendron Nuttalli*, and other plants which will be noticed in the report of the proceedings of the Floral Committee. Mr. Parker, of Tooting, received an extra prize for some plants of his new *Rhododendron* Countess of Haddington, bearing a profusion of its rosy bluish flowers $3\frac{1}{2}$ inches in length. A like award was made to Mr. Turner, of Slough, for forced Geraniums; to Messrs. Dobson, for Pansies in pots; and to Mr. Bull, for a nicely-filled plant case. Mr. Thompson, of Ipswich, sent *Collinsia verna*, an ornamental early-flowering blue and white annual from the United States; Messrs. Wrench, of London Bridge, a large collection of imported Hyacinth blooms; and J. Bateman, Esq., flowers of *Thibaudia elliptica*, and *Psammisia sarcantha*, remarkable for their rare beauty, and wax-like appearance, the former a brilliant orange scarlet, the latter vermilion and green. On the same table with these was placed the *epergne* to be presented to Dr. Lindley by the Council and Fellows, in recognition of his services to botany and vegetable physiology, and to the Society, during a forty-years connection with it.

FLORAL COMMITTEE, APRIL 20.—The third spring Exhibition took place on this day, and as far as flowers and plants were concerned must be allowed to have been a great success. The Floral Committee had many interesting plants to examine, and among them some striking novelties.

From Messrs. E. G. Henderson, Wellington Road, came *Genista prostrata*, a drooping sort producing numerous bright yellow flowers. This plant is well suited for hanging-basket decoration—second-class certificate; *Azalea Souvenir de Prince Albert*, semi-double, badly-formed rose and white flowers, thought a promising variety in 1862, and then received a second-class certificate; also, a remarkably fine-grown specimen of *Calceolaria violacea*, well covered with flowers, but the naturally weedy appearance will always prove an objection to this annual.

Messrs. Smith, Dulwich, sent *Azalea Bellona*, a very smooth, semi-double flower, of soft reddish carmine tint, a good addition to the semi-double class of Azaleas—second-class certificate; *Azalea maculata*, bright rosy scarlet flower, with a blotch of shaded brown spots on the upper petals.

Messrs. Veitch had *Franciscea calycina*, var. major, producing much larger light blue flowers than any other *Franciscea*, a very handsome free-flowering plant—first-class certificate; *Azalea Stella*, a beautiful variety exhibited on the 9th of March, but not then in a condition to be noticed beyond the opinion that it would be a first-class flower. That opinion has been verified, and at this Meeting a first-class certificate was awarded it. From the same firm came *Rhododendron sestertianum*, a large white flower which had been noticed before; *Trichopilia crispa*, one of the cool-house Orchids, a very curious free-flowering species—first-class certificate; *Trichopilia coccinea superba*, an older and well-known plant; *Primula cortusoides aemona*, a very bright

purplish rose with much larger flowers than other Primulas, a pretty decorative plant—second-class certificate; *Dracæna Cooperi*, one of the most beautiful forms of *Dracæna*, with drooping deep red variegated foliage. This variety is said to be much hardier than many other varieties, and will be most serviceable for table decorations—first-class certificate.

Mr. Williams, Holloway, sent *Azalea splendidissima*, a white flower with dull red stripes and spots, flowers of bad form and uncertain in the character of marking; *Dendrobium Dayanum*, a recently imported Orchid, with rosy purplish spikes of flowers, and very fine—first-class certificate. A branch of that truly magnificent plant *Rhododendron Nuttalli*, was also exhibited by Mr. Williams, and not having been brought under the notice of the Committee before, was awarded a first-class certificate. This is the finest *Rhododendron* ever seen, it has a very delicious and powerful scent. He also sent *Drimys lanceolata*, with mottled foliage not unlike an *Aloe*.

From Mr. Bull came *Phalenopsis Ruckeri*, with large white flowers, much resembling *P. grandiflora*, but with deeper and broader yellow markings on the lower lip. This will probably make a valuable addition to the *Phalenopsis* family. *Gymnostachyum Verschaffelti*; this plant has been mistaken for *Eranthemum rubrovenium* which it somewhat resembles, but upon close inspection is quite distinct, it is a handsome-foliaged plant, and as such received a first-class certificate. *Azalea Roi des Doubles*, a beautiful bright rose, small semi-double flower; this plant attracted much attention from its brilliant colour, it is one of the best of the double varieties—first-class certificate. Mr. Ball also had *Azalea Roi des Blancs*, a white flower with very firm petals, but not equal in many respects to other white varieties; *Begonia longipila*, with palmate leaves and dull pink flowers; *Azalea alba delicatissima*, this plant had variegated foliage, flowers small; *Phlox Louis Gell*, *Petunia Narrator*, *Caladium marmoratum*, a bad specimen of the beautiful *Streptocarpus Saundersii*, *Dorstenia maculata*, *Rhododendron Souvenir de Jean Byles*, *Anthurium leuconeurum*, *Begonia Prima Donna*, and *Lomaria discolor*.

Mr. Kinghorn exhibited *Azalea ochroleuca*, large white semi-double flowers, but inferior to *Flag of Truce*; *Azalea Meteor*, bright scarlet showy variety, with spotted upper petals, second-class certificate. Mr. Ivery sent *Azalea Garibaldi*, rose, deeply spotted; Mr. Turner, Alpine *Auricula Shakespeare*, a very dark self, of good form, second-class certificate; *Auricula Prince Alfred*, a dark chocolate self; also *Cineraria Herbert*, bright blue flower. Mr. Wm. Thompson, Ipswich, had several plants of a new annual *Collinsia verna*, not equal to bicolor, but commended for its bright blue colour.

Mr. Low, Clapton, had *Boronia Drummondii alba*, *Genista Everestiana*; Messrs. Paul & Son, Cheshunt, two seedling Hybrid Perpetual Roses from English seed—*Hamlet*, a shaded rosy violet, Lord Canning, dark cerise. Both varieties appeared thin and deficient in petals, but April is not the month to judge of the merits of seedling Roses: they will both make a better appearance in July.

BEAUTY OF WALTHAM ROSE.

My friends often ask me what I have done to your reporter who rejoices in the pseudonym of "D., Deal." Verily it would seem that it is his settled opinion that a good thing cannot come out of Waltham Cross. To go back no further than your Journal of last week, he writes—"Beauty of Waltham, not distinguishable from Madame Charles Crapelet." Now, if this be so, I must be very dishonest to send out an old Rose under a new name; but it is not so, and as an old rosarian, I must tell "D., Deal," that if this is his honest opinion, he, notwithstanding all his pretended knowledge of Roses, is no authority in such matters. On the other hand, if he knows better, the sooner he abandons such a policy the more to his credit, and the better for the interests of your Journal. A public writer must, if he has ever acquired influence, soon lose it if he does not rigidly adhere to truth.

The Rose Beauty of Waltham has been shown over and over again in the same stand as Madame Charles Crapelet. It received first-class certificates as a new Rose from the Royal Horticultural and Royal Botanic Societies of London.

It was pronounced the best Rose of the year both at the Kensington and Stamford Rose Shows; and more than four thousand plants of it have been sold from these nurseries alone, principally to those who had seen it in flower. And this Rose is now pronounced by "D., Deal," "not distinguishable" from Madame Charles Crapelet. It is not the report of the reporter, but the medium through which it is conveyed that has induced me to trouble you on the subject. The correct teaching, general fairness, and high honour of your Journal, none can appreciate more fully than I.—WILLIAM PAUL, *Waltham Cross*.

OBJECTIONS TO THE TWO-DAYS SHOW OF THE ROYAL HORTICULTURAL SOCIETY.

As a very humble exhibitor in the trade, I am truly glad to find the exhibiting gardeners have so unanimously protested against the proceedings of the Council of the Royal Horticultural Society in reference to the contemplated two-days show. The arguments adduced are so reasonable in every sense, more particularly as to the injury caused to plants by so long a period of exposure to an uncongenial atmosphere, that I should think so really practical a body as the Council of the Royal Horticultural Society should be, would at once accede to the request, and rescind the second day's show. But where are the trade in their protestations? They surely cannot find the second day's show conducive to their interests. If they do, in my humble way I am an exception; but the existence of such exception I have very good reason for doubting.

I leave argument in more able and influential hands, trusting to see some representative of the nurserymen exhibitors follow the example of Mr. G. Baker.—F. RHODES, *Sydenham*.

[Since the foregoing was in type we are glad to see that the Council have met the representation in a good spirit. They reply they are sorry that the arrangements are considered inimical to the interests of the memorialists, which was certainly not intended; that a large portion of the second day's receipts have been set apart for the exhibitors; that they are prepared to make any necessary arrangements for carefully preserving the plants; that the lighting by gas of the evening exhibition will not injure the plants, the ventilation provided by the Society being ample.

If it be a question of expense, they would be prepared to consider any proposal for converting the exhibitor's anticipated share of the second day's receipts into a fixed sum, or to guarantee that such share should not be less than a sum to be decided on; and should it be desired, the Secretary would be glad to see a deputation, to endeavour to arrive at some satisfactory solution of this point.

The evening show will probably be the most attractive part of the exhibition; but if after these explanations it is desired only to show plants for one day, arrangements will be made by arranging such plants apart, so that they may be removed at the close of the first day's exhibition.

The Council will be glad to hear specifically from each individual which of the different arrangements he has a preference for, in order that they may prepare accordingly.]

DEATH TO THE GOOSEBERRY CATERPILLAR.

A GARDEN near us was infested with caterpillars, and although the bushes were partly stripped the marauders were destroyed by placing a piece of the common Furze in each bush. Whether any smell came from the Furze which the caterpillars did not relish I am unable to inform you, but so simple an experiment is worth a trial.—G.

[This comes from a correspondent well worthy of credit; and as we have had similar communications from other correspondents, we join in saying the experiment is worth a trial. We presume that the Furze employed is in bloom; and, if so, the perfume of the flowers, though grateful to human nostrils, may be detestable in the nostrils of the caterpillar. We wish some of our readers would try the alleged remedy and inform us of the results.]

CURATORSHIP OF KEW GARDENS.—Mr. Alexander Smith, who for so many years had the management of these gardens

under Sir W. Hooker, having at length retired, Mr. John Smith, lately gardener to the Duke of Northumberland, at Syon House, and who is well known as one of our best and most intelligent practical gardeners, has been appointed to succeed him.

ORCHARD-HOUSES.

It was not my intention to enter on this subject again, but some remarks by "T. R." at page 261 seem to call for a few observations, which I hope will be taken in the spirit in which they are tendered. I have no interests to serve, and have only a desire to arrive at a correct conclusion, and may therefore claim to be impartial.

"T. R." commences by endeavouring to explain why unheated orchard-houses are a failure as regards Peaches and Nectarines in or near the large manufacturing towns of Yorkshire. "It cannot be owing to the difference in latitude, for in places much farther north Peaches and Nectarines ripen in such houses freely and well," as at Seggieden, Perth, N.B., &c. But let it be remembered that different degrees of latitude are not suitable for the same plants, but each has its own flora. "T. R." should bear in mind that elevation exerts as great, if not greater, influence on the temperature of any particular place; and in speaking of latitude the elevation above the sea level should be taken into consideration. For instance: Bradford, on a mean, is 400 feet above the sea level, and the mean temperature within the town is 49.6°; but at Horton Hall, situated three-quarters of a mile to the west, and at 496 feet above the sea level, the mean annual temperature is 47.8°, and the rainfall is 1.50 inches greater than in the town itself. Leeds, which is nearly in the same latitude as Bradford, but only some 87 feet above the sea level, has a mean temperature of 49.9, and 7.62 inches less rainfall than Bradford. It is calculated that the temperature of the air decreases 1° for every 100 feet of elevation, so that at Perth, although several degrees farther north, the temperature may be higher than at another place two hundred miles farther south, and at a greater elevation. Some parts of Perthshire I know to be highly elevated. Ledard, where the Glasgow Waterworks Company keep a rain-gauge, is 1500 feet above the sea level, but there are places in that beautiful county that are not more than 60 feet above that level; and if I remember rightly Perth and its vicinity are not at a high elevation. Latitude, therefore, without taking into consideration the elevation of a place, is no criterion to go by, but is liable to lead to an incorrect conclusion. Hertfordshire with its fruitful soil has a mean temperature exceeding that of London on the cold wet clay; and some parts even of the "sunny south" are not equal in temperature to Nottingham, which is about 100 feet above the sea level, and has a mean temperature of 51°, whereas Hertfordshire has a mean temperature of 52.3°, and may be on an average 100 feet above the sea. Taking into consideration the diversity of the elevation of the surface of this country, it is not to be wondered that orchard-houses unheated are a success at one place and a failure ("T. R." will pardon my employing the expression) at another.

I think that I may now say it is acknowledged by the promoter of orchard-houses that it is necessary to heat them in highly elevated and cold situations, but at the same time I must say that a heated house devoted to the growth of the Peach and Nectarine is a Peach-house. An orchard-house, on the other hand, is a cold house of cheap construction devoted to the cultivation of fruits hitherto grown in the orchards and gardens of this country.

"T. R.'s" next endeavouring to find out the cause of my failure hits the nail on the head with a vengeance. I give him credit for knowing a great deal more about smoke than those who reside in dwellings enveloped almost continuously in smoke. I have found that when the wind was blowing from the west, taking the smoke from us, the sun's rays were not obstructed by the volumes of smoke drifting over, for a thermometer in the sun's rays read quite as high as one in the country; but when the wind blew from S.E. to N. (opposite the sun's course), a thermometer in the sun read 10° lower than in the open non-smoky country. We cannot attribute the difference to any greater intensity of the sun's rays in one situation than in

the other; and any one not altogether sceptical will doubt that large volumes of smoke obstructing man's vision of objects at a distance, must admit that volumes of smoke passing over hothouses must obstruct the sun's rays and cause a sensible decrease in the solar heat passing through the glass. This, then, may be one cause of failure in smoky towns. The want of success is certainly not due to the narrowness of the houses themselves, for although mine was narrow and a failure, my brother gardeners were no more successful with their large houses, for no fine Peaches were grown in any of them; and I therefore came to the conclusion that orchard-houses for the growth of the Peach and Nectarine required artificial heat, not in smoky towns only, but in cold districts generally. Many houses of this kind have been heated during the past winter, and I have no doubt that fine crops of fruit will be grown by the same men who failed to do so when their houses were unheated.

Narrow houses, certainly, are not so good as wide ones; and I am glad to see "T. R." recommending large substantial houses in preference to those miserable glazed wood sheds, which are no credit to the proprietor, nor can any gardener take a pride in managing them. "T. R." says I would do well to visit Nottingham, where I would see a score of houses and be able to judge correctly. I have no doubt that orchard-houses are a success there. I never expressed an opinion of things I have not experienced, and I do not think Nottingham is the place for me to go to in order to express an opinion as to whether orchard-houses have succeeded or failed in the neighbourhood of Bradford. If I saw a success at Nottingham I should never see a prospect that perseverance at Bradford would be crowned with similar success. I have tried orchard-house cultivation there, and seen it tried by a score of gardeners, some of whom have had several silver cups for skill in the cultivation of plants, and with one and all it was a failure.

"T. R." then wishes I could see his trees. Nothing would afford me greater pleasure than to do so; but nothing would alter my decision—Orchard-houses for the cultivation of the Peach and Nectarine must be heated in the cold districts of the north.—G. ABBEY.

STRAWBERRY FORCING-HOUSE.

I HAVE an orchard-house heated by hot water, and I wish to grow a few early Strawberries in it. Its height at the eaves is 5 feet. There are 20 inches of glass below the eaves, then a 12-inch ventilator opening downwards, then boards to the ground. Where should I place my shelf for Strawberries? If at the top of the ventilator they would be near the glass above, and close to the side glass, but I could give them no top air: would that matter? If placed below the ventilator, the spring winds might blow too directly on them. It would be the least trouble to place them on the ground, but I suppose they would be too far from the glass.—C. P.

[Your orchard-house with hot-water pipes in it is a misnomer. It is a hothouse, and from the 1st of April there is hardly a place in it in which Strawberries would not succeed if fully exposed to light, and if air could pass easily over them, especially when in bloom and coming into bloom. Before that time it would be well to have a stage or shelves suspended some 20 or 24 inches from the glass, and near enough to the ventilators to secure a small current of air, but this may be secured in any part of the house; and great draughts may be prevented by netting the openings, or giving only half an inch or an inch opening in cold stormy weather. The air will pass right over the Strawberries. Now it is of less moment where there is unobstructed light. In a lean-to orchard-house, with a square of glass in front and a wooden ventilator opening downwards beneath it, we have now a row of pots, with the tops about level with the bottom of the front glass. When in flower, the blooms will have the benefit of the front glass and what air we like to give them. These have not been long in, but last year in the same place the plants did first-rate. Behind these, say 2 feet, is a row of Tom Thumb Peas, and some 15 inches behind them is a row of Strawberries just coming strongly

into bloom, and we have no doubt they will do well; but if the shade from the Peas growing fast should be too much, we will elevate the pots a few inches. They now stand from 3 to 4 feet from the front, and fully as much from the sloping glass of the lean-to roof. Behind them are rows of

fruit trees in pots; we have no doubt they will do well. In January and February, and even in March, we should have liked them to be nearer this glass, say 18 inches from it. The distance is less material now if there is unobstructed light.]

FLOWER-GARDEN PLAN—ROSE FLOWERING BUT NOT GROWING.

“MAY” encloses a plan for her garden with the way in which she proposes to plant it, and will be glad to have any

advice. She is doubtful whether the scroll-beds, averaging 2 feet, are wide enough to look well with two colours; and if so, whether the edgings should go all round the beds or on one side only?

As the garden is not made yet, any suggestions about the design will be acceptable; but space will not admit of its being more than 80 feet in length and 40 in width. It is to be on a grass lawn in front of a house.

“MAY” would also be glad to have advice about a Rose, which flowers profusely, but will not grow. She does not know the name. The cutting was taken from a tree covering a wall of great extent. It looks like a Tea Rose. About two years ago she planted the cutting (then a year-and-a-half’s growth) against a south wall. It flowered constantly all last summer and autumn, though the flowers were frequently pinched off in hopes of making it grow. This spring it has been well pruned, but at the end of every branch are three or four little shoots, each with a flower-bud coming on it. “MAY” would like much to know what to do to make it grow, as her object is to cover the wall, and she would willingly sacrifice the flowers for this year. The soil is light and rather sandy.

[We do not think we could improve upon your pretty plan. You can have one thick row along the centre of your narrow beds, and the edging all round. We would not make one-sided things of them; we would skirt 11 with some little thing, as Impératrice Josephine Verbena; and round 12 and 13 we would skirt Verbena pulchella or venosa; 9 and 10 we would skirt with Golden Chain or Cloth of Gold Geranium; in 14 and 15 we would place a few white Verbenas along with the purple.

You had better take off the most of the flower-buds from the Rose, and top-dress the ground with a bushel of horse-droppings or cow-manure that has laid in a heap for a month previously, and during the summer use manure water freely.]

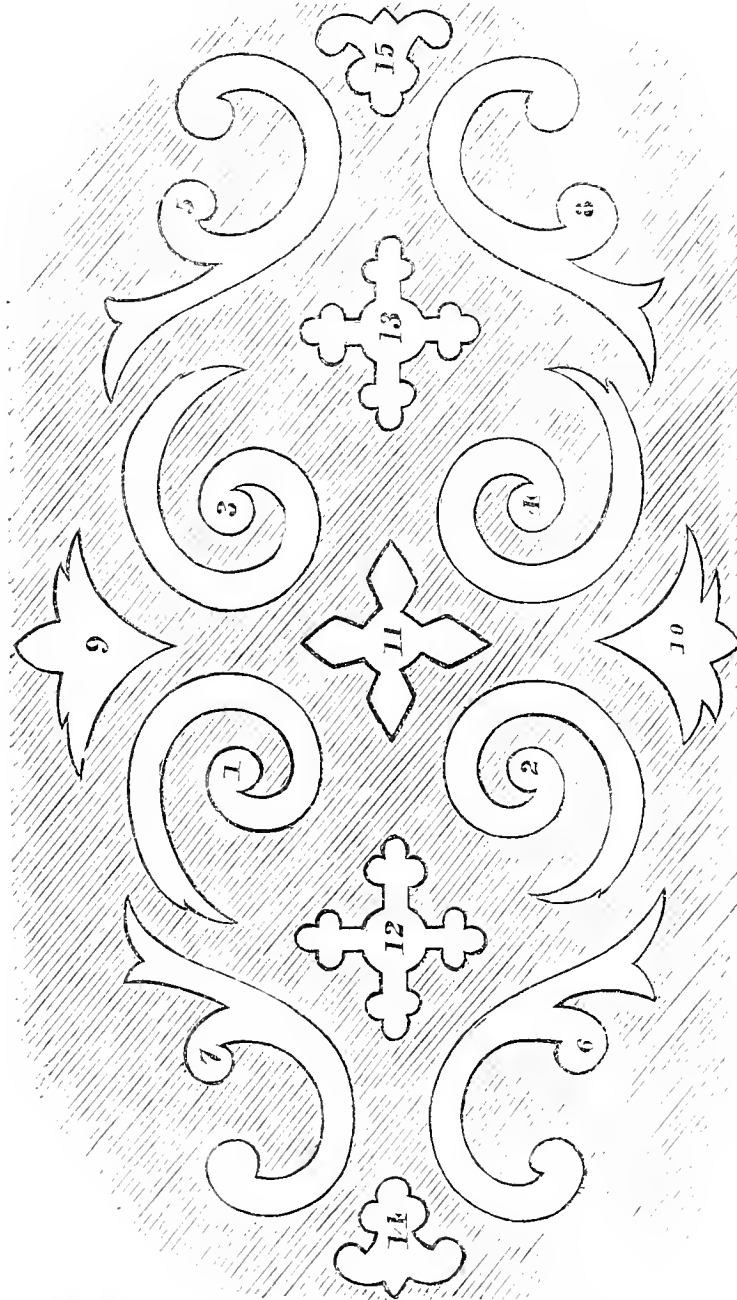

Scale 10 feet to 1 inch.

- 1, 2, Variegated Geranium; edge, Lobelia.
- 3, 4, Scarlet Geranium; edge, Cerastium.
- 5, 6, Scarlet Verbena; edge, Variegated Alyssum.
- 7, 8, Cineraria maritima; edge, Rose Verbena.
- 9, Geranium Diadematum.

- 10, Geranium Christine.
- 11, Geranium Unique.
- 12, 13, Centre Fernia: ends, yellow Calceolaria.
- 14, 15, Verbena Purple King.

GARIBALDI AND THE GARDENERS.

THERE is no want of unity in this association, for we have it in the General’s own words, that he “cultivates Cabbages in Caprera.” Whether, after his ovation in England, like Diocletian, he regrets leaving their cultivation, we will not pause to inquire, but will only express our regret that our Royal Horticultural Society has missed taking the initiative, and has not conferred upon the General an Honorary Fellowship, as a token that the gardeners of England, whom the Society ought to represent, duly appre-

ciate the man of Nature's own nobility, who is only the warrior when needed, and who retires to the cultivation of his field and his garden when the sword need no longer be unsheathed.

However, our national Horticultural Society did not come forward to honour Garibaldi, and an Association of much lower pretensions has done what it could. On the 18th inst., at the Crystal Palace, after two very young children, fancifully dressed, had presented to the hero of the day baskets of fruits and flowers, the Central Horticultural Society of London presented to him the following address:—

“TO GENERAL GARIBALDI.

“Sir,—The members of the Central Horticultural Society of London, an institution whose object is to promote the knowledge, practice, and general interests of horticulture and agriculture, presume to offer you their sincere homage and hearty welcome, esteeming you a noble example of all that is good and great in war or in peace. They recognise in you a fellow-labourer in the field and in the garden, and are proud of your consent to become an honorary member of their Society. They will long cherish a recollection of your visit to this country, and they feel an honest pride in the enthusiasm of all ranks vieing with each other to show their admiration of your devotion to the most holy of all causes, Liberty and the Welfare of all Mankind.

“The members of the Central Horticultural Society beg leave to present you with a few of the beauties which Nature (subservient to the horticulturist's art), produces at this early season, to beg your acceptance of so simple yet earnest an offering, and to express their earnest prayer that you may live to see the noble works contemplated by you carried out, feeling convinced that they tend to the happiness of all nations.”—(Signed by G. GORDON, President, and other Officials of the Society.)

FLOWER-STALKS OF VINES FALLING OFF.

I AM in possession of a viney the Vines of which were planted about thirty years ago. They are Black Hamburgs, and have borne excellent crops hitherto. Nothing material has been done to the border since they were planted, beyond top-dressings. The soil in which they are planted is of a deep, hard, sandy nature. We commenced forcing at the beginning of January, and in time no Vines could have broken stronger or more freely, showing one and, in some instances, two bunches, on each shoot. But my expectations have been blighted, for none of the bunches have set, the stalks turning yellow and ultimately falling off. Can this be owing to a cold border, or to its exhaustion? If the latter, why should they break so strongly and look so healthy and vigorous? The border, to the width of 10 feet from the front, is covered with 1½ foot of leaves and thatched with straw. I may add that the Vines have received due attention inside.—A TWELVE-YEARS SUBSCRIBER.

[We wish our correspondent had referred to the treatment as to atmospheric heat and moisture to which his Vines have been subjected, as we suspect that his failure arises more from a low, damp temperature than from anything connected with the border. Another correspondent has consulted us about a failure of the same sort, and informs us that he kept the temperature at from 45° to 50° at night, and syringed the Vines twice a-day, which is enough to ruin the crop on any Vines, however comfortably situated the roots may be.

The yellow appearance and the ultimate decay of the bunches in the present case is what might be expected from like treatment, more particularly in a cold cloudy spring, like the early part of the present one.

That there are other circumstances which predispose bunches to “wiring” or running out into productions which may be termed half bunches and half tendrils is beyond doubt; Vines, for instance, that are in a damp or over-rich border, and the wood of which has not been well ripened in the previous autumn, will make strong growths in the following spring, and show long sprawling bunches which, unless treated to a high temperature and dry atmosphere, will be most likely to run away into claspers.

A low temperature with moisture are just the circumstances that will aggravate the evil, which originates in

ill-ripened wood. When Vines are in this condition the cultivator should keep a high temperature and a dry atmosphere directly the Vines show such a tendency, and with such treatment a crop may be secured, which with the opposite treatment would most surely either run to claspers or damp off, as described by various correspondents.

We have one viney under our own care at present, the Vines of which could be made to run to claspers every year, but which under the influence of heat and a dry air produce good Grapes.

Our correspondent may, perhaps, think that to raise the temperature now, is like locking the door when the steed is stolen. It is not so, however, and we would advise that he keep a night temperature of 70°, with an atmosphere rather dry than otherwise, and maintain this state of things till his Vines are thoroughly ripe. This will lay a good foundation for strong compact bunches next year.

The fact that the Vines have hitherto borne good crops leads us to assign his failure this year to a low temperature and too much moisture, and the cold spring would accelerate the failure.

We would not in the absence of more particulars advise that the roots of Vines that have hitherto always done well should be interfered with; and with favourable inside treatment we know of no reason why they should not still bear good crops.

This has been a most trying spring for Vines that have not been thoroughly well ripened last year, and we are not surprised to hear, that with cool, damp treatment there are many failures.]

PORTRAITS OF PLANTS, FLOWERS, AND FRUITS.

MILTONIA REGNELLI (Regnell's Miltonia).—*Nat. ord.*, Orchidaceæ. *Linn.*, Gynandria Monandria. Native of Minas Geraes, Brazil. Bloomed in August; flowers white, tinged with purple.—(*Bot. Mag.*, t. 5436.)

REIDIA GLAUDESCENS (Glaucescens Reidia).—*Nat. ord.*, Euphorbiaceæ. *Linn.*, Monœcia Diandria. Stove plant, native of Java. Flowers numerous, greenish, red at base, remaining a long time; habit graceful.—(*Ibid.*, t. 5437.)

VIUSSIEUXIA FUGAX (Fugacious Viussieuxia).—*Nat. ord.*, Iridaceæ. *Linn.*, Triandria Monogynia. Native of the Cape of Good Hope. Flowers in August. Colour pale lilac, with orange spot at base of each petal.—(*Ibid.*, t. 5438.)

SCUTELLARIA COSTARICANA (Costa Rica Scutellaria).—*Nat. ord.*, Labiata. *Linn.*, Didynamia Gymnospermia. Native of Costa Rica. Scarlet flowers, large and numerous.—(*Ibid.*, t. 5439.)

ERANTHEMUM CRENULATUM var. GRANDIFLORUM (Large-flowered crenulated Eranthemum).—*Nat. ord.*, Acanthaceæ. *Linn.*, Diandria Monogynia. A variety common in Ceylon and India. Flowers bright pink. “*Crenulatum* is hardly characteristic of the leaves.”—(*Ibid.*, t. 5440.)

DENDROBIUM LUTEOBUM (Pale Yellow Dendrobium).—*Nat. ord.*, Orchidaceæ. *Linn.*, Gynandria Monandria. Native of Moulmein. Introduced by Messrs. Low & Co., Clapton Nursery.—(*Ibid.*, t. 5441.)

GODETIA ROSEA ALBA var. TOM THUMB.—Hardy annual. Introduced by Messrs. Carter, High Holborn.—(*Floral Mag.*, pl. 189.)

VERBENAS.—Introduced by Messrs. Low & Co., Clapton Nursery. *Conspicua*, rosy purple. *Mrs. Nichols*, bluish white, eye crimson-shaded. *General Bazaine*, crimson scarlet.—(*Ibid.*, pl. 190.)

DAHLIA.—*Princess Alexandra*, raised by Mr. C. J. Perry, Cedars, Castle Bromwich, near Birmingham. Pearly white florets, tipped with pale lavender.—(*Ibid.*, pl. 191.)

LYCASTE SKINNERI.—A variety of this Orchid. It is in the possession of Messrs. Veitch, and not yet offered for sale.—(*Ibid.*, pl. 192.)

LYCHNIS SENNO.—“We are happy to introduce here the following remarks on this plant, with which we have been favoured by its introducer, Mr. Fortune:—*Lychnis Senna* (Siebold and Zuccar.), is one of the most common garden plants in Japan. It is a favourite with farmers and cottagers, and is very showy and handsome when in bloom. There are three very distinct varieties; one has red flowers,

another has white ones, and the third has red flowers with white stripes. The specimens which have bloomed in England have given but a faint idea of the beauty of this plant; they have been wanting in that depth and richness of colour which they have at home. The striped variety is well shown in the figure as it appeared when it flowered for the first time in this country; but in Japan the ground colour is a deep red, while the stripes are of a pure white colour. When the plants are more naturally and slowly grown the old colours will probably return—that is, the red will become deeper, and the stripes of a purer white and more clearly defined. It blooms in the end of May and in June. Senno is the name it is known by amongst the Japanese: and hence Siebold and Zuccarini have adopted this for the specific name in their *Flora Japonica*. Kämpfer and Thunberg both describe the plant, but, erroneously, refer it to *L. coronata*, which is quite a different thing.”—(*Florist and Pomologist*, iii., 73.)

NEW BOOKS.

GRASS-SOWING SEASON.

Laying Down Land to Permanent Pasture. By MARTIN H. SUTTON, F.R.H.S., Reading.

Little Book on Grasses. J. C. WHEELER, Gloucester.

THESE two pamphlets, though having for their object primarily to inform their readers that Grass seeds are supplied by the authors, yet deserve a notice for the very useful information they contain.

Mr. Sutton's pamphlet is a reprint of a communication made by the author to the Royal Agricultural Society, was published in their Journal, and is a very able dissertation on the formation of permanent pasturage, commencing with the sowing of the seed, and giving all needful directions for the after-management of the pasture.

Mr. Wheeler's "Little Book" also gives good information relative to permanent pasturage, points out which are bad Grasses, gives drawings as well as descriptions of those which are good, and remarks briefly on lawn Grasses.

Both the above publications are seasonable, and will be useful to those about to sow Grasses either on their farm or garden.

FUMIGATION.

No less an authority than Mr. Barnes, of Camberwell, has stated that after giving the various substitutes which have been proposed for fumigation, for the purpose of stopping the ravages of thrips on Azaleas, a fair trial, he is satisfied that nothing is so effective for the purpose as the old-fashioned plan of using tobacco; but the difficulty is, especially with amateurs, how best to do it. It requires some considerable powers of endurance to remain in a house while the process is going on, and the old fumigating bellows had some disadvantages which made it less effective than it should have been, mainly arising from the material of which the cylinder containing the tobacco was made, and which frequently gave way under the influence of the heat. Messrs. Barr & Sugden, of King Street, Covent Garden, have recently brought out an improved one, which we feel sure will obviate all these difficulties and make "every man his own fumigator." The cylinder is one piece of solid brass casting, so that it cannot be acted upon by heat; and, as it is sold at a reasonable rate (10s. and 12s.), it is really a great boon. We have ourselves tried it and can testify to its efficiency.

WORK FOR THE WEEK.

KITCHEN GARDEN.

THE drying easterly winds and the present clear warm weather have rendered it necessary to supply water to recently-transplanted vegetables, and also to seedling crops which are just making their appearance; it is, however, sometimes better to allow the seeds to remain in a dormant state until we have rain, as continued waterings bind the surface of the soil into a hard crust, impenetrable to air and extremely prejudicial to the germination of seeds. This may be in some degree prevented by shading from the sun or by

covering the soil, so as to prevent evaporation as much as possible: frequent waterings are not then necessary, and the soil is kept in an open porous state, which is of the utmost importance. When the nights are warm seeds and herbaceous plants of all kinds should be watered in the evening, so that the soil may gradually imbibe the water; but if cold nights prevail, the early part of the morning is the best time for its application. *Asparagus*, it is an erroneous practice to cut the weak as well as the strong shoots until cutting is altogether discontinued, it is weakening the roots unnecessarily, and, therefore, should not be done. *Broccoli*, as the present warm weather brings it forward so fast some of it should be pulled up before it is fully grown, and laid in a cool place so as to prolong the season. *Cabbage*, where the soil is very hard between the autumn-planted it will greatly benefit the plants to fork between them, and after rain they should be again earthed-up. *Cauliflowers*, dig the soil surrounding them with a fork, and afterwards give them a good soaking with water, which must be repeated twice a-week during dry weather. *Dwarf Kidney Beans*, make a good sowing for succession; a few should be sown in a pan at the same time to fill up vacancies. *Lettuce* give a few of the earliest plants a good supply of water to bring them forward: some of the Cos may be tied up to form heads. *Radishes*, sow both Long and Turnip-rooted kinds; water beds from which they are drawn for use.

FLOWER GARDEN.

Continue to regulate any of the more advanced herbaceous plants, tying them up if they require it. Clematises or such climbers to be frequently looked over, and nailed or tied as they advance in growth. Hardy annuals coming up too thickly to be thinned out, and transplanted if required. Sow annuals amongst rockwork, and plant-out any rock plants that have been kept in pots during winter. Plant-out Ferrara roots, that have not been potted, into borders, and plant, also, in beds *Gladiolus cardinalis*, *Ixias*, *Tritonias*, &c., sticking laurel branches amongst them as a protection for a few days; if frost should occur a few mats to be thrown over them. The present is unfavourable weather for planting evergreens, owing to the prevalence of dry winds. As it is more than probable that where much planting was intended part of it may yet remain on hand, we may observe that some kinds of evergreens may yet be safely removed, taking the precautions to water them at first planting and occasionally afterwards, to well mulch the surface, and to damp the foliage over in the evenings of dry days. These attentions, which are indispensable should dry weather continue, will enable late-planted evergreens to start, in most cases, freely.

FRUIT GARDEN.

The operation of disbudding Peach, Nectarine, and other wall trees should be proceeded with more or less, according to the development of vegetation, and this will now be rapid; constant attention will be necessary in order that the removal of shoots may be gradual. Strawberry plantations will require abundance of water if dry weather continue, and a piece of ground should be prepared for the reception of plants as they are turned out from the forcing-house.

GREENHOUSE AND CONSERVATORY.

Gesnera oblongata and *Euphorbia jacquiniæflora*, both being profuse bloomers and remaining long in beauty, should be grown wherever winter flowers are valued; they should be afforded every necessary accommodation and attention at the present season, in order to secure good specimens for next winter. The conservatory plants are now making active growth, and should be liberally supplied with water. Those growing in prepared borders to be frequently examined to see that the roots are kept sufficiently moist. Hybrid Indian *Rhododendrons* and Chinese *Azaleas* will now be in great beauty, and every care should be taken to preserve the blooms from damp and drip, which materially injure them. *Primula sinensis*, especially the double varieties, is deserving of every attention, and should not be neglected at the present time. Unless there is a good stock of young plants of the double varieties on hand, the flowers should be pricked-off the old plants as soon as they show any symptoms of weakness, shaking the exhausted soil from the roots, and repotting in light fibry peat, well intermixed with sand, keeping the plants well down in the pots, and

placing them in a warm shady situation. If these showy winter-flowering plants are not allowed to exhaust themselves by flowering, young roots will be freely emitted from every branch; and when this is the case the plants should be broken up and repotted separately, affording them a rather warm and thoroughly moist atmosphere until they become well established, when, with ordinary care, they will grow freely, and form fine specimens before winter.

STOVE.

Attend to the training of twiners as they advance in growth, and do not allow these to get entangled before giving them attention. Also attend to the stopping and training of other plants, and afford free-growing subjects plenty of pot room. Very little fire heat will now be sufficient if the practice of shutting-up early in the afternoon is adopted. Proceed with repotting Orchids as they may require it.

PITS AND FRAMES.

Push forward late-propagated stock, and endeavour to keep the whole growing on slowly. Do not allow the bedding stock to stand in small pots exposed to bright sunshine and drying winds. The plants should be exposed to the weather as freely as circumstances will admit; but this should be done by degrees, and never to the extent of browning the foliage and drying-up the tissues, and they should never be allowed to suffer for want of water.

W. KEANE.

DOINGS OF THE LAST WEEK.

KITCHEN GARDEN.

Took a piece of Brussels Sprouts to the charring-heap, and planted with Potatoes. The Scotch Curly Cabbaging Kale is now throwing out numberless beautiful compact shoots, far more compact than Cottagers' Kale, Garnishing Kale, &c. It seems to come true enough from seed. Our two or three first crops, after the first seedlings, were kept up by slipping off the side shoots and planting them firmly, as stated in a late Number. The Cabbaging Kale should take the place of all Scotch Curlies, tall or dwarf, the side shoots are so much more compact. We think we mentioned the other week, that the Variegated Kale had a bad name for turning black, blue, &c., when cooked, and was of no use but for garnishing; but there is nothing like trying things, and a dish of the White Variegated was everything that could be wished—crisp, juicy, and tender, with the white and green as conspicuously blended after boiling as before it. For garnishing, the pretty little leaves, either of the White or the Red varieties, set off Apples and Pears in winter; and the little leaves of the White lend a charm to fine Strawberries now, whilst in odour they seem more scentless than anything generally used for the purpose, except it be Vine leaves; and it is not always desirable to meddle with them, for if we want a vigorous root-action we must also secure a vigorous top growth. When we have heard of, or witnessed disputes about Vine leaves, we often think of the attitude taken by one of the grandees of gardening in the last generation—men who, with the extreme of enthusiasm for their art, asserted for themselves, and obtained unhesitatingly from others, even from employers and neighbouring gentry, the respect and the attention due to a gentleman. A nobleman passing through his vineries and expressing his approbation, added, "But how is it, Mr. B., that the housekeeper has, ever and anon, those grievous complaints about Vine leaves that have been ringing in the ears of my lady for this month past, failure after failure being traced to the want of Vine leaves, and to your pertinacity in not sending her a quarter of the quantity which she requires?" "My lord," replied Mr. B., "if it is required to have so many Vine leaves, and it meets your approbation, I would plant a piece of ground out of doors with Vines, and cultivate them for leaves alone with as much pleasure as I would cultivate a quarter of Cauliflower, or a quarter of Gooseberries; but these Vines under glass are all that I have, and with these I should be more disappointed than your lordship if there were a failure of the crop. I have repeatedly taken every leaf from them that I thought could be spared in order that there should be no semblance of a complaint. Of course, if it were your wish, I could easily **cut off** a quarter or a half of the leaves you now see; but

in doing so, I must also state my conviction that I should have small hopes of sending good-coloured, high-flavoured Grapes to your table this season, and less hopes of having much except leaves for a crop next season." This settled the question, and other Greens and curled Mallow leaves had to do service for Vine leaves. In these advanced days of progress and improvement, when good servants and good masters part owing often to the want of a word of explanation, we frequently regret that there is not more of the willingness to oblige, accompanied with an unvarnished statement of facts on the part of the servant, and a condescending courtesy on the part of the employer, that would ever prompt to the patiently listening to details and explanations before finally deciding, which, perhaps, more than in the present marked the times of the past. The resolve to make no explanations, the determination to listen to none when made, are some of the chief causes of short servitudes, whilst, on the other hand, these short servitudes and their accompanying annoyances and evils, turn gentlemen who would be enthusiastic patrons into mere passive supporters. Both sides are, no doubt, to blame; but the moral we would deduce is, that if employers wish to retain a faithful, intelligent servant, they must not be above looking on both the sides of a Vine leaf or any other question, and the very knowledge that they will do so will secure them from the infiction of having it often to do.

Sowed the main crops of Broccoli, Brussels Sprouts, Kale, &c. Sowed succession of Turnips and Radishes, protecting the secondary crops from birds, and thinning the first Turnips under protection. Watered Cabbages from drainings of the dunghill and house-sewage. The last does well out of doors, but we dislike using it much under glass. Finally earthed-up the Cabbages afterwards, as the winds are too powerful for them without support. Watered Broccoli likewise. Staked Peas, regulated Cucumbers, and gave them less protection at night after these warm days, as the thermometer was above 70° in the morning, and that tends to weaken the plants—from 65° to 70° is quite enough at night when the plants are well established. Thinned Dwarf Kidney Beans that were too thick in pots, staking and top-dressing them at the same time. Planted out Lettuces, some at the foot of a wall, and others on the north side of a bank to come in later. In sowing Dwarf Kidney Beans and Scarlet Runners out of doors, if there is nothing better at hand a few coal ashes will tend to keep slugs, snails, and wireworm from the seeds as they are vegetating.

The fine weather has brought on Asparagus out of doors. Threw some stubble and a little earth over a piece of *Sea-kale* to blanch it. A little salt will do good to that left exposed and growing. The latter may need a little thinning of the shoots in a few weeks, and we will take it up to force next season. Took out the greater part of what was forced in the Mushroom-house, cutting it into lengths of about 4 inches or so, and planting the crowns by themselves, and the pieces of the roots without crowns by themselves. Unlike forced Asparagus roots, these will make capital forcers in the second year. We find, however, that when the roots taken up have been exposed to a good heat, their lower part is apt to rot and die off. When plantations are, therefore, made of such forced roots cut up into pieces, it is a good plan to cut up and place the roots in dry sand or dry soil until the wounds begin to callus all over. If a few are showing signs of decay they need not be planted. *Rhubarb* roots, forced, may also be divided and planted out into deep rich soil, and in the second season they will be in fine trim for forcing again. If seedlings are used for that purpose the seeds should now be sown in shallow drills and covered with light soil. A few of these may be forced the first winter, and all of them at all well treated will be very fine plants for the second winter. Asparagus seeds should also be sown if not done, and Asparagus is best planted when the young shoots are about 3 inches long. The young seedlings of last or previous years (but young ones are not the worst), should be carefully taken up and planted, and the fibres never allowed to get dry. In stiff land the plants will do best in ridges, with a good dressing on the surface of manure, charred refuse, and burned clay, &c., well mulched in summer. Beds in bearing may be sprinkled with salt, but it will tell most when the gathering ceases and the plants are allowed

to grow freely. The finer the stems in summer the better the heads next season.

FRUIT GARDEN.

Hoed and rough-raked Strawberry grounds, taking off some of the roughest litter that had lain between the rows all the winter, and will follow with a dressing of lime, and in a week afterwards with a little soot, using the lime before an expected shower, that it may be washed into the ground, and kill snails, slugs, &c., or cause them to emigrate. Potted a lot more Strawberry plants for succession. Disbudded and thinned shoots and young fruit in orchard-houses. Cherries and Plums in the later part have been lately a beautiful picture. The sun and the wind have both been so powerful in drying and parching of late, that in addition to sprinkling the floor with water we will just spot the glass with whitening to-morrow—done by throwing water finely with the syringe over the glass that has just been whitened. This will break the force of the bright sun and render less watering necessary, and the slightest shower will wash it all off, as in general weather there is no danger of too much sun heat. The sun and the sweeps of wind together have lately been quite enough for trees in bloom. Peaches set freely, and with a good portion of leaves are far less affected.

Planted out *Melons* in hot-water pits, and also on dung-beds. The latter were made up of everything comestible that would produce heat by fermentation. In the "Cornhill Magazine" for April there is an amusing sketch of an old gardener, who, in defiance of orders, would persist in taking what "doong" he wanted from the farmyard without ever asking leave from Mr. Joliffe the bailiff. Plenty would be glad to ask for it with all the et-ceteras of courteous obligations and "thank you" into the bargain, and then run a small chance of succeeding, the bailiff being quite as well aware of the value of manure, long or short, as the gardener can be. When people are content with vegetables grown without any dung there is no great cause for trouble, but it is more than mere annoyance when certain results are desired and the means for producing these results are not forthcoming. One thing is a satisfaction—that after this period a little bottom heat will do better for *Melons* than a very strong one, and much may be done by causing the sun, if it shines pretty regularly, to do the most of the work. In these frames, a little more than one-third in width is supplied with earth for the *Melons* to grow in, chiefly rather stiff loam. A slab goes at back and front, and on each side lots of plants are placed to bring them on, and to be removed as the *Melons* grow. Though the vines of the *Melons* will fill the frame, the roots will chiefly be confined to the space between the slabs, and thus we get rid of extra vigour, and little pruning is needed if our disbudding plan can be carried out. This plan does away with all successive earthing-up of *Melon* plants, by which the vines and leaves were often much injured. The soil being at first placed at some 16 or 18 inches from the glass, there is no after-occasion for moving or lifting the frames to give the plants room, and unless in extreme cases there is little need for shading. The plants in these frames will have earth some 18 to 24 inches deep, and from 24 to 28 inches in width—quite sufficient to grow a heavy crop of *Melons* in a frame 5 or 6 feet wide. Much less labour is needed in every way by lessening the root space, and there is less likelihood of the shoots becoming gaugrened and gouty at the collars of the plants.

Watered *Figs*; if they become dry they should be thoroughly moistened gradually. Tied-up the *Vines* in the late house, which kept us going to the middle of March. We wish they could have been kept back a little later, as late as even those we saw last week at Mr. Lane's. We presume Mr. Lane finished cutting in the beginning of winter, but we kept on to the middle of March; and the fires necessary to keep the house dry must have helped to cause the *Vines* to start sooner. In another season we will try more fully the plan of Mr. Thomson, of Dalkeith, and stick the bunches with a piece of wood attached into beet-root, &c. Those we stuck into turnips kept as well as those hanging on the *Vine*, and we could have had the house a few weeks sooner at liberty for other things. We are getting bedding plants cleared out of it as quickly as we can. Went over other vineries, regulating shoots, pulling a dry hand slightly over bunches in bloom, and thinning *Grapes* farther advanced. Took Strawberry plants out of

the early houses, and set them in every place where light and air could reach them. The sun is everything in their favour, but the bright light and the sharp wind have rendered the waterpail no sinecure. After such days the fruit should be gathered for table before watering.

ORNAMENTAL DEPARTMENT.

Pretty well finished pruning Laurels, shrubs, &c. Turned over beds not cropped. Must have all edgings of beds and walks cut as soon as moisture comes, so as to stand well for the season and make easy work for the shears. Rolled preparatory to mowing. Damped paths and stages of plant-houses. Shaded also from bright sun. Have done a small stove with whitening, milk, and a little flour; it stands very firm. A skiff with whitening water is as good as any where only temporary shading is wanted, as a dry broom or a little water will remove it. When put on with size, with milk, or a little flour, or with driers, such as painters use, it will stand for the season, and may look like ground glass, and very neat. In places where only a slight shade is wanted it may be put on very thinly. Cloth shades are no doubt better, but they are very expensive, and if generally used and neglected for a few hours the effects would be serious. A thin shade from whitening would prevent danger, and yet not keep out much light. For fine-foliaged stove plants such a composition as any one of the above may be put on pretty thickly, and be allowed to remain until the end of September.

Proceeded with potting *Fuchsias*, *Geraniums*, and hard-wooded plants. All, especially the latter, require to be kept in a closer, moister, shady place until growth is freely proceeding, and until that take place the plants must be fed rather by moisture upon and round the foliage, instead of deluging the roots. In potting small plants of *Balsams*, &c., watering the soil well is of less consequence; but in the case of all hard-wooded plants especially, and other plants generally, the safe rule is never to soak the new soil much until it is occupied by fresh roots. Of course, such soil should not be dry, and neither should it be marshy wet; only drain a pot well, and if you give even a good shift, the soil will never become stagnant and marshy at the sides if the roots have taken fair hold of it. The roots, in fact, will make a sweet soil for themselves if they have a fair chance. Place a plant from a six-inch pot into a twelve-inch one, water heavily and regularly all over, and the soil at the sides will run a chance of becoming a stagnant poisonous marsh to the roots as they reach it. See that such a plant is well watered before potting; disentangle the roots when potting, and water carefully only as far as the roots extend, and ere long the whole will be occupied healthily. Even in common things the waterer may easily be deceived. Some large *Fuchsias* were potted some time ago; the old balls were dipped in tubs before potting, to secure thorough drenching. For several sunny days lately the plants flagged, and yet the soil seemed moist enough, and when the pots were rung with the knuckles, they emitted heavy dead sounds, and still we considered that dryness was the cause. There were several holes bored near the centre of the pot, and then a good watering given, and there has been no more flagging, even in the brightest sun. The water had passed too freely to the sides of the pot amongst the new soil. When anything of this kind is apprehended, the above system should be followed, or the pot be set for half an hour overhead in a tub of water. The tub would save many a valuable plant that otherwise would be lost.

PITS.

A great deal of time has been taken in moving and sheltering bedding plants, as after filling all our turf or earth pits, we are now filling our wide *Celery*-beds. To *Calceolarias*, &c., we would have given all this fine sun, but for its drying them, so we have mostly allowed the calico, &c., to remain over them. We were obliged to water them with a rose to-day, and then protect a little again, just to save watering, especially in the middle of the day. We are just preparing to take off the last lot of *Verbena* cuttings, and are not quite decided whether to place them in tiles, pots, &c., or prick them out into a bed under glass at once. The last will cause least trouble. They may now be so planted about 1½ inch apart, and will lift with nice balls, if there is sandy leaf mould to plant them in, and a nice heat beneath them.—E. F.

COVENT GARDEN MARKET.—APRIL 23.

All kinds of produce in season continue to be well supplied, and trade is rather brisk. Good Pines are somewhat scarce; Hothouse Grapes are sufficient for the demand; and a few good dessert Pears are still to be had. Heavy consignments from abroad continue to arrive, and include Peas, Kidney Beans, Artichokes, Lettuce, Carrots, and large quantities of Turnip Radishes. Cut flowers principally consist of Roses, Pelargoniums, Cinerarias, Azaleas, Hyacinths, Tulips, Violets, Mignonette, and Wallflowers in abundance.

FRUIT.

	a.	d.	s.	d.		s.	d.	s.	d.	
Apples 1/2 sieve	2	6	to	4	0	Nectarines	0	0	to	0
Apricots doz.	0	0	0	0	0	Oranges 100	4	0	10	0
Figs doz.	0	0	0	0	0	Peaches	0	0	0	0
Filberts & Nuts 100 lbs.	0	0	0	0	0	Pears bush.	8	0	12	0
Grapes, Hothouse... lb.	12	0	25	0	0	dessert	0	0	12	0
Foreign	1	6	2	6	0	Pine Apples	6	0	10	0
Muscats	0	0	0	0	0	Pomegranates	0	0	0	0
Lemons 100	4	0	10	0	0	Strawberries	0	6	1	6
Melons each	0	0	0	0	0	Walnuts	14	0	20	0

VEGETABLES.

	a.	d.	s.	d.		a.	d.	s.	d.	
Asparagus bundle	6	0	to	10	0	Leeks	0	4	to	0
Beans, Broad..... bush.	0	0	0	0	0	Lettuce	1	0	2	0
Kidney	2	0	3	0	0	Mushrooms	1	0	2	0
Beet, Red..... doz.	1	0	1	6	0	Must. & Cress, punnet	0	2	0	4
Broccoli bundle	0	9	2	0	0	Onions bushel	4	0	7	0
Brussels Sprouts 1/2 sieve	0	0	0	0	0	pickling	0	6	0	8
Cabbage doz.	1	0	1	6	0	Parsley 1/2 sieve	2	0	3	6
Capsicums 100	0	0	0	0	0	Parsnips	0	9	1	6
Carrots bunch	0	6	0	8	0	Peas..... quart	7	0	10	0
Chiafflower doz.	4	0	8	0	0	Potatoes sack	6	0	9	0
Celery bundle	2	0	3	0	0	Radishes doz. bunches	0	6	0	3
Cucumbers each	1	0	2	6	0	Turnip	2	0	3	0
Endive score	1	3	2	6	0	Rhubarb	0	4	1	0
Fennel bunch	0	3	0	0	0	Savoy doz.	0	0	0	0
Garlic and Shallots, lb.	8	0	0	0	0	Sea-Kale basket	1	6	2	6
Herbs..... bunch	0	3	0	0	0	Spinach sieve	2	6	4	0
Horseradish ... bundle	1	6	4	0	0	Turnips bunch	0	4	0	6

TO CORRESPONDENTS.

** We request that no one will write privately to the departmental writers of the "Journal of Horticulture, Cottage Gardener, and Country Gentleman." By so doing they are subjected to unjustifiable trouble and expense. All communications should therefore be addressed solely to *The Editors of the Journal of Horticulture, &c.*, 171, Fleet Street, London, E.C.

We also request that correspondents will not mix up on the same sheet questions relating to Gardening and those on Poultry and Bee subjects, if they expect to get them answered promptly and conveniently, but write them on separate communications. Also never to send more than two or three questions at once.

N.B.—Many questions must remain unanswered until next week.

NEAL'S FUMIGATING PASTILLES (*Alpha*).—Our correspondent says that Mr. Neal is dead, and wishes to know where the pastilles are now to be obtained.

VINE-BORDER (*J. M. B.*).—The bunches enclosed were slightly shrank and turning to tendrils. Such effects are usually occasioned by the roots being deep, and in a cold wet border; and such we believe your border to be. For a late viney we prefer the border to be made inside the house, building the front of the house on arches, so that the roots can come into an outside border which we should prepare for them in addition to that made inside the house. We should advise you to plant the Vines within the house, and to keep the roots as much within the house as possible. The kinds you name will answer well, except the Barbarossa, which is a shy bearer, otherwise it is a good long-keeping Grape. It requires rather more heat than most Grapes, and unless you can command this we advise you to plant another West's St. Peter's in its place.

DISEASED LOUISE BONNE PEAR TREE (*A. Z.*).—The tree of which you sent a shoot appears to be suffering from being what is sometimes in local phrase called "hidebound," and we fear your best remedy is to remove it and procure another. In general the Louise Bonne of Jersey is a free grower, and less prone to canker than such old varieties as Crasanne, Jargonelle, and Gansel's Bergamot. In our orchard its greatest fault seems to be growing too freely and bearing too heavily. We have known a tree similarly diseased to yours renovated by being taken up and its roots and top judiciously and rather severely pruned, especially the top, and the tree, being a small one, was for a time partly encased in wet moss, the roots being planted in dry suitable soil, and it came round, but the labour cost more than would have procured another plant. We fear that the roots of your tree are decayed past restoration.

NAME OF ORCHID (*J. B., Daventry*).—Your Orchid is *Dendrobium macrophyllum*, Lindl., var. *giganteum*, the largest-flowered species of the genus, but certainly not the largest-leaved, as its specific name would imply. Some years ago Sir William Hooker, thinking the name *macrophyllum* a misprint, figured it in his "Botanical Magazine" under the more appropriate one of *macranthum*, and by that it is known in some collections; but according to the rules of priority recognised by botanists *macrophyllum* is its correct name. Your plant with three shoots 3 feet long and 108 flowers is assuredly a very fine one, and must be exceedingly beautiful.

WORMS IN GARDEN WALKS (*C. P. C.*).—Watering the walks once a-week with a solution of salt in water, 4 ozs. of salt to a gallon of water, will drive them away from the surface.

DWARF CHRYSANTHEMUMS (*Under the Shade*).—Take off some of the strongest and best-rooted suckers, and plant these in place of the old ones that have grown too large. Stop the shoots when about 6 inches, and again stop the plants the last week in July. Your plants will then be dwarf and bushy.

CYCLAMEN PERSICUM AND SCARLET ANEMONE FAILING IN POTS (*Idem*).—Your Cyclamen fails to bloom because it has not sufficient light in a north window, and a glazed china pot will assist in bringing on the evil. Tepid water, if not warmer than 80°, would not injure the blooming of your plant. We advise you to turn the plant out of its pot in the latter part of May in a warm dry situation in the garden, and let it remain there until September; then take up the plant and pot it, employing a compost of turfy light loam and leaf mould in equal parts. Place in a cold frame, or, failing that, in your south sitting-room window, and if duly attended to with water, not giving any until it is needed, and then enough to run through the pot, we have no doubt that you will be rewarded with a fine display of bloom. You may pot the plant in a common garden pot, and place that within the china pot, and by covering the surface with moss no one can tell but what it is growing in the china pot. Anemones are hardy, and we are unable to account for their being cut off by frost. If you keep the pots plunged in the soil quite up to the rim we do not think the frost would injure them. When in bloom you could easily remove them to the sitting-room window, which is a very un-suitable place for them at other times. After blooming they should be plunged in the open garden in the full sun.

CENTAUREA CANDIDISSIMA FROM SEED (*B. A.*).—Keep the plant now about to bloom in a light airy situation in the greenhouse, and continue the plant under glass until the seeds are ripe. They should then be sown in a compost of sandy turfy loam and sandy peat in equal proportions, with a liberal admixture of silver sand. Drain a seed-pan extra well, say to one-third its depth, with broken crocks, and on this place the rougher parts of the compost. Fill the pan to within a quarter of an inch of the rim with the finer parts of the compost, and, having levelled the surface, sow the seeds thinly over it. Cover lightly with very fine soil, in which silver sand largely predominates. Water moderately through a fine rose, place in a shady part of the greenhouse, and place a bell-glass over the pan. Keep close and shaded until the plants appear, then remove the glass and shade, and place on a shelf near the glass. Water moderately, but never until the soil shows unmistakable evidence of the want of that element, and give abundance of air and light. During winter the young plants should be carefully watered and kept near the glass in a dry, light, airy situation in the greenhouse. In February the plants should be large enough to handle, when they should be potted into 60-sized pots, taking them up very carefully out of the seed-pot, and employing the compost recommended for sowing the seed in. Give a gentle watering, and place in a house having a temperature of 55° by night, with a rise of 10° to 15° by day. The plants should be shaded for a few days from bright sun until they recover the potting, when they cannot have too much light nor be kept too near the glass. By the beginning of April the plants will have grown amazingly and the pots be full of roots. This is the right time to pot them into 48-sized pots, which being done with the same compost in a rather rougher condition, continue in heat a fortnight longer; then gradually harden off, and remove to the greenhouse in the first week in May. These plants should be but moderately watered at all seasons, and a moist cold atmosphere is theirbane. They require as dry an atmosphere as a Heath, and do well under similar treatment. By the middle of May the plants should be gradually hardened-off, and if all has gone on well they will be strong plants suitable for flower-garden decoration by the beginning of June; but if you have not the convenience to place the plants in heat in early spring we advise you to defer sowing the seed until April, and then to sow the seed as described above. The seedlings will make good plants in the following season.

CUCUMBERS HAVING GUM DISEASE (*S. J.*).—We could not discover any insects in the box. We do not think that the gum oozing out has anything to do with the insects, though the latter may weaken the plants. Your plants have, no doubt, the "gum disease," and there is hardly anything more difficult to master. It is very probable that you will also find little brown spots on the leaves, as this very frequently attends the gumming. Some of the best gardeners have their Cucumbers attacked by the gum and spot and cannot cure it, though growing Cucumbers most successfully for a score of years. For palliatives do not keep the soil too wet. It is well to have it in a ridge form, so that the sun may heat upon it. Wash all the walls of the pit or box with sulphur paint merely darkened a little with soot. Do not syringe much, and chiefly early in the afternoon. Give plenty of air, leaving on a little at night. Be satisfied with a night temperature of from 60° to 65° and 70°, but never above the latter. Let the temperature get to 85° or 5° more on a sunny day, but with air given early. If gum or patescent matter exude from a good fruit or what promises to be one, rub it off carefully, and dust the place with a powder consisting of lime and charcoal, and though a scar will be left, you may yet get a good serviceable fruit for cutting up. With these precautions you may keep the disease in abeyance, but you will not always; and we might say you will not often conquer it wholly. The only remedy is to sow again, and sow often, and use chiefly fresh sandy loam until all trace of the disease has left the premises. We can feel for and sympathise with you, but we should be wrong if we held out much hope, except in fresh plants and fresh rather poor soil. The spot is rather worse than the gum.

CHARCOAL FOR MANURE (*A. N.*).—We know of no dealers in this. Apply to the London Manure Company, 116, Fenchurch Street.

AZALEAS GROWING PREMATURELY (*Glasgow Subscriber*).—We fear the flower-buds are not fully matured before placing in cool quarters to rest, and are overpotted. In addition to this, we think they are brought on too rapidly when forced, and thus excited they start into growth, shoots are produced by the side of the buds, and the buds become blind or the bloom poor, because the nutriment is lavished on new growths instead of on the flowers. We can only advise you to keep the plants rather under-potted, at the same time providing perfect drainage, and not to remove the plants out of heat until the bloom is well set and the wood well ripened, after which they cannot have too much light and air, and keep them cool during the dull winter months. In forcing they should be slowly excited, so that the sap may ripen proportionably with the swelling of the buds. When quickly excited they start into growth, because the old leaves pump up more nutriment than is necessary for the demands of the bloom-buds.

FLOWER-GARDEN PLAN (A Suffolk Subscriber).—We have no doubt the planting will look very well. The two scrolls 1 and 2, on each side, may be planted quite independently of the central group of nine clumps, or so as to combine as you have arranged it. Beginning with them you give the key note to cross planting, and we think it would be best to continue it. Thus 5 and 6 you make yellow *Calceolarias* differently bordered, we would border both with blue *Lobelia*, and more especially as the *Phlox* is less to be depended on. Then 4 and 7 we would plant alike, though there is no necessity for using the same things. The *Heliotrope* and the *Verbena* will do well; 11 and 9 we would plant with white and blue; 8 and 10 with blue and scarlet, using the materials you propose for the two beds, but both the same instead of different. A broad band of Flower of the Day in 3, round the Scarlet Geraniums in the centre, will enliven the whole group. Your main centre group is just one of those simple arrangements that always please when well planted.

APPLYING LIQUID MANURE (A Young Amateur).—Your overflow-pipe will take away most of the clear liquid and leave the tank full of the thickest manure water. This, as you rightly say, is too powerful for vegetation if applied indiscriminately. When employed for watering vegetables the liquid should be stirred-up with a stick from the bottom, and, if very thick and muddy, it should be diluted with three times its volume of water. This applied to fruit trees that need vigour, and between the rows of kitchen-garden vegetables, twice weekly in summer, should assist them wonderfully. The liquid of the same strength is specially useful for watering Roses and other shrubs outside; in fact, at this strength you may safely apply it to all growing crops in the kitchen, fruit, or flower garden, taking care not to water bog plants, as *Rhododendrons*, &c., with it. For flowering plants in the greenhouse it should be diluted with six times its volume of water, and be made equal to the temperature of the house by mixing or diluting with warm water. In this state it may be applied to *Fuchsias*, and all plants grown in loam, advantageously twice a-week, and for strong-growing plants at every alternate watering.

FLOWER-GARDEN PLAN (Subscriber, Tulla).—We never give directions for planting a garden we have never seen. All that we can do is to criticise any planting that is proposed to be carried out.

NAMES OF PLANTS (A Young Gardener, Trevalyn Gardens).—1, *Diplazium polypodioides*, or *D. asperum* if the stalk is prickly; 2, *Pteris serrulata*; 3, *Nipholobus pertusius*; 4, *Cheilanthes hirta*. (*G. S. W.*)—*Riccia fluitans*, Linn., is the name of that little plant belonging to the Hepaticæ, or Liverwort family, which you found in the pond of water near Gloucester.

POULTRY, BEE, and HOUSEHOLD CHRONICLE

POULTRY SHOWS.

MAY 26th and 27th. **WOORBRIDGE.** *Secs.*, Messrs. Dallenger and Whistock, Market Place.
 JUNE 1st. **BEVERLEY.** *Secs.*, Mr. H. Adams and Mr. J. Kemp, jun. Entries close May 21st.
 JUNE 13th to 17th, 1864. **BATH AND WEST OF ENGLAND, AT BRISTOL.** *Steward*, S. Pitman, Esq., Bishops Hall Manor, Taunton. Entries close May 9th.
 JULY 14th and 15th. **EASTERN COUNTIES.** *Secs.*, Messrs. Ranson and Simpson, Stowmarket. Entries close July 1st.
 JULY 19th, 20th, and 21st. **NEWCASTLE-UPON-TYNE.** *Secs.*, Mr. William Trotter, Bywell, and Mr. J. Shorthose, Shieldfield Green, Newcastle-upon-Tyne.
 AUGUST 22nd, 23rd, 24th, and 25th. **ALEXANDRIA PARK.** Poultry, Pigeons, and Rabbits. *Sec.*, Mr. William Houghton. Entries close July 16th.

SOUTH AUSTRALIAN POULTRY SHOW.

WHEREVER an Englishman sojourns he introduces his pastimes and improvements. We have before us, whilst now writing, letters from Australia, Canada, and the Cape of Good Hope, all asking for aid to obtain good specimens of various breeds of fowls. The following report shows how in the antipodes they are already rivaling "the old country."

The Show of the Central Agricultural and Horticultural Society took place at Adelaide, on the 25th of February.

The poultry evinced the superiority of the present Show over some preceding ones. Every class for which prizes had been offered was represented, with the exception of *Turkeys*. There was a good deal of competition in *Geese* and *Ducks*, and some of those exhibited were really splendid-looking birds. The same remark will apply to the *Polish* fowls, and it will be seen that the Judges recommend a prize to be awarded to a pen of this variety which had not been entered to compete. The beauty of the *Spanish* fowls was much admired; and a Gold Sebright *Bantam* cock and two pullets, sent in by Mr. A. Scott, were deemed deserving of a prize. The Judges, it will be seen, recommend classification in fowls at future exhibitions, and that facilities should be afforded for showing them to better advantage.

There were some very fine Rabbits exhibited, some of them being ticketed as high as 25s. a-pair.

GEESE.—First, J. V. Kase. Second, J. Ind.
DUCKS.—First, J. Reedie. Second, Nation Brothers.
SPANISH.—First and Second, A. Pengelly.
DORKINGS.—First, A. Loutit. Second, J. Reedie.
COCHIN-CHINA.—First and Second, Nation Brothers.
POLISH.—First, W. Pengelly. Second, A. Loutit. (D. Holbrook's pen, not for competition, recommended for a prize.)

ANY BREED.—First, A. Loutit. Second, T. Ivey. (A. Loutit recommended for a prize, Game breed.)

JUDGES.—Messrs. H. Selway, C. Bechtel, and T. Mellor.

Judges' Report.—The Judges would recommend a prize for a Game cock and hen exhibited in No. 7 pen; also, that a pen of young *Polish* fowls, *White-crested Blacks*, not entered for competition, are worthy of a prize. A pen of Sebright *Bantams* exhibited, but not for competition, are worthy of special notice. There were some excellent Rabbits exhibited, for which no prizes were offered. The Judges recommend a larger number of pens being provided, and that all poultry should be classed at future exhibitions.

WHARFDALE POULTRY SHOW.

THE poultry Show in connection with the Wharfedale Association took place at Otley, on the 15th inst.

The day was a very favourable one for an out-door show, and the visitors were numerous.

Twenty prizes were competed for, and the Show being held in that part of Yorkshire which *Homburghs* may claim as their home, it was exceedingly good in this respect. The *Spanish* were of first-class quality, as were also Mr. Kell's *Dorkings*; and Messrs. Beldon and Sunderland's pens of Black and Brown-breasted Game *Bantams* produced such a pen of Black as is seldom seen, and the Rouen and Aylesbury *Ducks* were exceedingly large and good in all respects. An extraordinary pen of Golden *Polands* took first in the Variety class, and the second went to a pretty pen of *White-crested Blacks*.

A good number of sales were effected before the close of the Show.

SPANISH.—First and Second, W. Cannon, Bradford.
DORKINGS.—First, T. E. Kell, Wetherby. Second, Miss E. Beldon, Gilstead.

HAMBURGERS (Golden-spangled).—First, W. Cannon. Second, E. Beldon. Highly Commended, W. Birdsall, Meanwood, Leeds. Commended, E. Beldon.

HAMBURGERS (Silver-spangled).—First and Second, W. Cannon. Highly Commended, E. Beldon.

HAMB ROES (Golden and Silver-pencilled).—First, E. Beldon. Second, W. Cannon.

GAME.—First, E. Beldon. Second, J. Sunderland, Coley Hall, Halifax. Highly Commended, E. Beldon; Miss M. Deighton, Hawksworth.

BANTAMS.—First, W. Cannon. Second, E. Beldon. Highly Commended, I. Todd, Clifton, Otley.

DUCKS (Rouen).—First, W. Cannon. Second, W. Hindle, Burley, Otley.
DUCKS (Ayle-bury).—First, T. E. Kell. Second, E. Beldon.

ANY OTHER VARIETY.—First, W. Cannon. Second, E. Beldon.

JUDGES.—Mr. Thos. Dodd, Ovenden, Halifax; and Mr. E. Hutton, Pudsey, Leeds, York.

ARTIFICIAL SWARMS.

I HAVE much pleasure in responding to the appeal of "PHYLISCUS," in page 308, and describing those modes of making artificial swarms which have proved successful in my own apiary.

I need not enter upon the vexed question as to the superiority or inferiority of artificial swarms. My own opinion is that all depends upon the skill with which the operation is effected. A natural swarm, if it consists of a fertile queen and an equal number of bees, is quite as valuable as an artificial one, and *vice versa*. The advantages in favour of the latter are its freedom from risk and uncertainty, and the saving of many hundreds of valuable lives. Any one examining the ground in front of a hive from which a natural swarm has just issued, can scarcely fail to be moved with pity as he views it covered with young bees, which the excitement of swarming has induced to quit their home before they can use their wings, and regret at this waste of what may be justly termed the very life-blood of the community. For my own part I rarely see a natural swarm in my apiary, and the appearance of one is always a cause of anxiety as well as some little self-reproach for the carelessness which has permitted it; whilst not unfrequently has it been the herald of actual and serious loss, not of the swarm itself, but of its sovereign, since on no less than three occasions have I had to deplore the loss of valuable Italian queens, owing to the oversight which has permitted natural swarming to take place. I cannot, therefore, endorse "PHYLISCUS's" opinion that the practice of artificial swarming

when properly managed is prejudicial to the prosperity of an apiary; but I feel assured we may readily "agree to differ" on this point, and leave its decision to the test of experience.

As I am requested to frame my reply with especial reference to the requirements of apiaries consisting entirely of bees located in common straw hives, and wherein a complete examination of their interior is necessarily out of the question, I must commence by endorsing the conclusion of Mr. Edwards, that when the honey season has fairly set in, when the population is overflowing, and drones have been reared, a hive is always ready for the operation. In doing this I write only according to the light of my own experience, and mean no offence to Mr. Lowe, who controverted Mr. Edwards's assertion, and declared that a colony thus circumstanced may, because of the absence of certain other conditions, be unfit to be operated upon artificially. As I am ignorant of these conditions, and consider we ought all to be ready to help one another, I hope Mr. Lowe will be kind enough to enlighten me on this point in the same spirit as I am now endeavouring to reply to "PHILISCUS."

The plan which I am about to describe originated, like most modern improvements in apiarian science, in Germany, whence it was introduced into America by Mr. Langstroth, through whose work it first became known to me. It has been thoroughly tested by that highly scientific and practical apiarian, "B. & W.," as well as by myself, and is, I believe, free from the risk and inconvenience attendant upon the usual modes of forcing swarms from common hives.

It is, however, necessary to employ two stocks in the operation, and both of these should be in the flourishing condition above described. Selecting, therefore, the forenoon of a fine day, the whole of the inhabitants of one of them should be driven with their queen into an empty hive. When I say the whole, I mean with the exception of the few stragglers and young bees which generally cling to the deserted habitation. "PHILISCUS" evidently needs no instruction from me as to the best mode of driving bees; but any novice had better refer to my article on the subject in page 423 of the last volume of THE JOURNAL OF HORTICULTURE. This exodus having been effected the swarm is formed, and the bees in their new and unfurnished domicile should at once take the place of the old stock. I need not say that, possessing its old queen and all the adult bees of the parent hive, it will form a very strong swarm with every element of prosperity that can exist in the case of a natural one. But the original hive crammed with combs and brood in all stages, must not be for one moment neglected or allowed to run the risk of becoming chilled in the slightest degree. It should at once take the place of the second strong stock, which must be removed to a little distance, not necessarily beyond the limits of the apiary, but so far as to prevent absentees from readily discovering it; and it is well at the same time to disguise its outward appearance as much as possible. With no desire to revive the celebrated milk-pan and straw-hackle controversy, I think even our Renfrewshire friend might with advantage temporarily resort to the former in such a case, whilst "UPWARDS AND ONWARDS," might also momentarily check his impetuous career in order to substitute the latter for his favourite earthenware cover and stone effigy. In its new position this stock will remain apparently dormant for a few days, but in about a fortnight will, probably, so far recover itself as to admit of being again employed in a similar manner. The bees returning to the old spot and missing their queen will at first be in some confusion, but will ultimately settle down to their task of forming royal cells to supply her place.

If it be desired to repeat the operation with other hives, it will be very advantageous to supply them with sealed royal cells. This may be done eight or nine days after the primary operation, when they can be readily cut out of the first hive by turning it up and dispersing its inhabitants by means of a little smoke. As soon as the bees are expelled from another hive, one of these cells may be inserted by the exercise of a little ingenuity, either through a hole in the top, or in some position at the edges of the combs from the bottom. It will speedily be fixed by the bees, but care must be taken that it is not chilled or bruised in the slightest degree during its transition.

This, then, is the best method with which I am acquainted

of making artificial swarms, whether from common or moveable-comb-hives, but in the case of the latter it will be advisable somewhat to modify the course of proceedings. Instead of driving the bees, the combs should be looked over until the queen be discovered on one of them. This comb, with its adhering bees and their queen, should be placed in an empty hive, into which, also, many of the bees may be shaken from the other combs, after which it should be placed on the old stand. The remaining combs in the old hive being brought together so as to leave the vacancy on one side, it should take the place of another strong stock, which must be removed to a new position in the manner above described by—A DEVONSHIRE BEE-KEEPER.

(To be continued.)

APIARIAN NOTES.

FOUL BROOD.—I have hitherto purposely avoided saying anything about this much-vexed question, having had no desire to add fuel to the fire already burning rather too fiercely between some of our most worthy and respected correspondents. I must, however, express my pleasure at the change which has taken place in the manner of conducting the discussion, and trust that the friendliness and amiability, which ought always to prevail among bee-keepers, will not again be put in peril.

It is with no desire to reopen the discussion that I now give my own opinions on the matter at issue; but as it is a subject of vast importance to apiarians generally, it surely is incumbent on all who can lay claim to some small amount of experience in bee-keeping, to furnish the results of their observations, and add their testimony to the evidence on one side or the other, so that the real truth may at length be made manifest.

I long ago arrived at the conviction that foul brood is a disease, and I may say that my views on the subject are almost entirely identical with those held and advanced by Mr. Woodbury.

Fortunately the disease has never, at any rate of late years, appeared in my apiary, so that my own personal acquaintance with it has been very limited. It may be asked by what right do I lay claim to any experience, or advance any opinions, as to the question which has been so warmly contested? In reply to this, I may state that my conviction that foul brood is a disease has been influenced, partly by evidence of a negative character, and partly by the positive evidence which has been furnished by a close observation of Mr. Woodbury's apiary since he first discovered what it was that so materially affected its prosperity.

To the positive evidence I need not allude, as Mr. Woodbury has already given that in the clearest manner possible. I can endorse every word he has said as to the extent of the evil, the experiments tried, and the remedies adopted for its cure, and the way in which the disease has, in some instances, reappeared after every care had been taken. I can bear willing testimony to the indefatigable manner in which he has laboured to eradicate the disease, and the almost incessant labour, care, and anxiety which were devoted to the attempt, at last, as we believe, to be crowned with complete success. We must all hope this will prove to be thoroughly and permanently the case, and that during this season his apiary may be restored to its former state of prosperity.

But the negative evidence alone will go far to prove that foul brood and chilled brood are not identical, and also that the disease is not necessarily an adjunct of an experimental apiary.

Perhaps I may claim to having been almost second only to Mr. Woodbury in queen-rearing operations, forming artificial swarms, and various other manipulations incidental to a thoroughly experimental apiary. How is it, therefore, that I, living in the same town, and using my bees in the same manner, have escaped the scourge which would have almost annihilated his apiary but for his most indefatigable exertions? Simply because the disease was never first introduced into my apiary by infected combs or honey, or first established in any hive from any cause however originating.

During the last three or four seasons I have worked my apiary on more completely scientific principles than ever previously. Commencing with making artificial swarms by

driving all the bees out of their respective hives, sometimes leaving the brood completely unprotected for a considerable time, I at length arrived at my present system of artificial queen-rearing and swarm-making. This involves constant supervision, a considerable amount of meddling, and consequent exposure and interruption in the working economy of the bees. For years I may have been considered a tolerably successful bee-keeper, but never has my success been so marked as since the time when I first adopted the more scientific mode of bee-keeping. One hive only, out of twenty-one, has succumbed to the trying winter, and that was a late artificial swarm, made chiefly of driven bees from cottagers' hives, and lost entirely through my own carelessness. After the bees had become, by starvation, greatly reduced in numbers, I captured the queen, and united the survivors to an adjoining stock.

As I have before intimated, my bees are kept in three separate localities, the two outlying apiaries being at a distance of several miles apart. Frequently, in the course of my manipulations, have I had to convey hives of brood deprived of their bees, or frames and combs of brood in all stages, from one garden to the other; and often have twenty-four hours intervened before bees could be given to the depopulated hives, or the combs transferred to the quarters to which they were assigned. In fact, so little apprehension has been felt of causing injury to the stocks by this mode of procedure, that I have frequently put in brood-combs which I knew contained chilled brood for the express purpose of being cleaned-out by the bees. Out of many instances in which brood-combs have been exposed for a considerable time prior to insertion in the destined hives, I may mention one case which in particular is brought to my remembrance. Rather late in the autumn a young Ligurian queen, which had been recently raised in a small artificial swarm, suddenly disappeared before she had commenced laying. Being unwilling to lose this little swarm, I removed from the original Ligurian hive a suitable brood-comb, and at the same time a comb of honey for supplying another stock with food. Before the operation could be completed I was called away, leaving the combs on the ground. On my return, being in a hurry, the comb containing the honey was, by mistake, given to the artificial swarm, and the brood-comb, which escaped my observation, was left resting on the ground. Many hours afterwards this was discovered by my man, who asked if I had purposely left it there, and said that there was a grand attack on the contents by robbers. Proceeding to the spot, I saw the error which had been committed. The honey had been carried off, and some of the eggs and brood torn out. The honeycomb given to the artificial swarm was removed, and the brood-comb substituted; and the greater part of the brood was duly hatched out. I would ask, if ordinary inspection and shifting of brood-combs is likely to be attended with such evil consequences, how is it that in an instance like the above no disastrous results followed? But the exposure to which this comb was submitted was nothing to what I have frequently been in the habit of giving to brood-combs before it has been convenient to consign them to their intended hives. Removed from hives at a distance, brought into town, left exposed until the following day, then fixed into frames, and eventually transferred into boxes, I have never found any ill effects. Some of the brood may have died, but it has been removed by the bees.

In one instance I know that a quantity of dead brood was given to a hive without injurious consequences. Two years ago a gentleman called on me and asked advice respecting a stock which he had been feeding, but which he said seemed quite deserted by the bees towards evening, though many were flying in and out during the day. As I expected, the stock was dead, and the bees which still visited it were robbers. There was a small quantity of brood on three combs, this I carried home, fixed in frames, and gave to one of my own stocks. None of the brood hatched out, it was dead, but the following spring I noticed that it had been effectually cleaned out by the bees, and I could trace those combs during the following summer, as they were transferred from one hive to another in the manipulations attendant on artificial queen-rearing.

It is, therefore, quite evident to my mind, that scientific bee-keeping will not in itself bring the evils of foul brood

upon the unhappy meddler; nor can foul brood and chilled and abortive brood be synonymous terms. Should, however, this dire disease, from what cause soever, once make itself known in any hive, there is no doubt that the scientific operator runs a very great risk of distributing it throughout his entire apiary.

What the exact nature and cause of this disease may be I will not attempt to determine. I think it very possible that it may, under certain peculiar and mysterious circumstances, originate in chilled brood; but what it is that causes this transformation at present remains undiscovered. If chilled and foul brood were identical, how is it that I have escaped, while my friend Mr. Woodbury has suffered so terribly? Our system of management has been much the same. Had I not been a constant personal witness of the ravages that this disease has effected in his once prosperous apiary, I might have been almost as sceptical as some others with respect to its being really a disease to be so much and deservedly dreaded.—S. BEVAN FOX, *Exeter*.

WHY BEES WORK IN THE DARK.—A lifetime might be spent in investigating the mysteries hidden in a bee-hive, and still half of the secrets would be undiscovered. The formation of the cell has long been a celebrated problem for the mathematician, whilst the changes which the honey undergoes offer at least an equal interest to the chemist. Every one knows what honey fresh from the comb is like. It is a clear yellow syrup, without a trace of solid sugar in it. Upon straining, however, it gradually assumes a crystalline appearance—it candies, as the saying is, and ultimately becomes a solid mass of sugar. It has not been suspected that this change is due to a photographic action; that the same agent which alters the molecular arrangement of the iodide of silver on the excited collodion plate, and determines the formations of camphor iodide crystals in a bottle, causes the syrup honey to assume a crystalline form. This, however, is the case. M. Scheibler has enclosed honey in stoppered flasks, some of which he kept in perfect darkness whilst others have been exposed to the light. The invariable result has been that the sunned portion rapidly crystallises, whilst that part kept in the dark has remained perfectly liquid. We now see why bees are so careful to work in perfect darkness, and why they are so careful to obscure the glass windows which are sometimes placed in their hives. The existence of their young depends on the liquidity of the saccharine food presented to them, and if light were allowed access to this syrup it would seal up the cells, and in all probability prove fatal to the inmates of the hive.—(*Quarterly Journal of Science*.)

SOLVENT FOR OLD PUTTY AND PAINT.—Soft soap mixed with solution of potash or caustic soda, or pearlash and slaked lime, mixed with sufficient water to form a paste. Either of these laid on with an old brush or rag, and left for some hours, will render the putty easily removable.

OUR LETTER BOX.

TURKEY HENS NESTING WITHOUT LAYING (*Constant Subscriber*).—If you did not say your Turkeys were watched we should say they laid and ate their eggs, and that is almost our opinion now. It is hardly possible to be as crafty as an egg-eater. There has been the same propensity in one of our pens of Silver Pheasants, and we have waited and watched in vain so far as saving the egg was concerned. We have prevented the eating of the egg, but have not saved it from injury. Watch personally and patiently once or twice.

AVERAGE DAY'S FOOD (*M. M.*).—Six fowls will eat four gallons of corn per week if they are from a poor run, or if they are low in condition. Afterwards they will eat less. They eat less in warm weather than in cold. They eat less corn when there is plenty of herbage about. If they have household scraps they should have less corn. Under no circumstances, unless there is waste, should the consumption exceed that we have named.

BUFF-COLOURED BANTAMS (*Spring Chicken*).—They are "Nankin" Bantams, and are now scarce. The best specimens of this breed always have single combs.

OBSERVATORY-HIVE (*J. C. F., Hereford*).—The Woodbury uncomb-hive, which was described with illustration in page 160 of our fourth Volume, is the best observatory-hive. It is manufactured by Messrs. Neighbour & Sons, 149, Regent Street, and 127, Holborn, whose advertisement appears in our present Number.

CANARIES (*J. H., Petergate*).—A work will be published at our office very shortly. Write to Mr. W. Walters, bird-fancier, Winchester.

WEEKLY CALENDAR.

Day of M th	Day of Week.	MAY 3-9, 1864.	Average Temperature near London.			Rain in last 37 years.	Sun Rises.	Sun Sets.	Moon Rises.	Moon Sets.	Moon's Age.	Clock after Sun.	Day of Year.
			Day.	Night.	Mean.	Days.	m. h.	m. h.	m. h.	m. h.	m. h.		
3	Tu	Yellow Wagtail arrives.	61.5	40.2	50.3	17	29 af 4	24 af 7	5 3	35 4	27	3 18	124
4	W	Medlar and Horse Chestnut flower.	62.2	38.2	50.2	13	28 4	26 7	5 3	55 5	28	3 24	125
5	Th	ASCENSION. HOLY THURSDAY.	62.3	39.1	50.2	19	26 4	27 7	2 4	8 7	29	3 30	126
6	F	Pheasant lays. [flower.	61.0	38.9	50.0	14	24 4	29 7	37 4	17 8	●	3 34	127
7	S	Red Clover and Mountain Ash	58.8	40.3	49.6	16	22 4	30 7	19 5	20 9	1	3 38	128
8	SUN	SUNDAY AFTER ASCENSION.	61.3	39.3	50.3	16	21 4	32 7	5 6	15 10	2	3 42	129
9	M	Easter Term ends.	61.2	39.7	50.1	15	19 4	34 7	59 6	0 11	3	3 45	130

From observations taken near London during the last thirty-seven years, the average day temperature of the week is 61.2°, and its night temperature 39.4°. The greatest heat was 84°, on the 6th, 1862; and the lowest cold, 21°, on the 8th, 1855. The greatest fall of rain was 1.26 inch.

ORCHARD-HOUSES AND AMERICAN PEACHES IN THE CHANNEL ISLANDS.



Y good friend, Mr. Rivers, having alluded, in his last letter, to me and to my work on "Cordon Training," which has now been two years published, perhaps my further experience of orchard-houses may interest others.

Mine is the oldest orchard-house in the Channel Islands, and the various handsome structures built or building have generally been organised upon the results of the original one. Many visitors to the islands have also seen the fruit in its various stages, and been thereby encouraged to adopt the system. Possibly their chief inducement to do so was the fact of an amateur managing, with the help of occasional unskilled labour, a lean-to house 125 feet long, filled with trees even ten years old, and producing every year abundance of splendid fruit, so fine and valuable that it is regularly exported to Covent Garden.

This is a fact of a certain value in judging of the merits or demerits of the culture of fruit on Mr. Rivers's plan. It shows, in the first place, that no great amount of skill is required, nor any great demand of time or labour; and, in the second place, that an abundance of fruit can be expected, and that of a first-rate quality, if certain conditions be observed. These conditions mainly consist in systematic and regular care, and in the selection of sorts calculated to insure a succession of produce.

It should also be borne in mind that it is unfair to expect that orchard-houses can succeed if built in very unfavourable localities. I am astonished to read of small span-roofed houses being used in northern counties, and sometimes in low and damp places. Is it wrong to suggest that lean-to houses, though not at all so picturesque as span-roofed, at least 200 feet long and 12 feet high, would, with the aid of a stove, be perfectly successful in such districts? In the southern counties smaller buildings, if not too crowded with trees, which is a fatal fault, could hardly fail. I am, however, convinced, that, as with Vines so with Peaches, the days are approaching when very large houses will be found the best in any part of England.

Not only, therefore, regular and assiduous attention is needed to work an orchard-house well, but choice in its position and shape is of essential importance. Lean-to houses are much warmer and earlier than span-roofed, and the back wall affords places for the best sorts; but

lean-to houses must be long and wide. No locality with stagnant air and retentive subsoil is suitable for orchard-houses at all. But, to my mind, the highest value of orchard-houses consists in their anticipating and prolonging the out-door Peach season. In my own house Peaches are ripe from the middle of July to the first week of November, or nearly three months. Apricots come in by midsummer. Of late Pears some remain. Early Potatoes are grown between the potted trees, and are ripe by the vernal equinox.

Great care is required in the selection of the sorts of Peaches and Nectarines, and among the Peaches the new ones from the Southern States are likely to be of great value. As they are little known, perhaps amateurs may like to hear something about those which I have fruited for two years.

Exquisite is a Peach measuring about 10 inches in circumference. In colour it is wonderful, and has the same effect among Peaches that Mrs. Pollock has among bedding Geraniums. The flavour is excellent.

Stump the World measured nearly 11 inches in circumference, and weighed 10½ ozs. Its colour formed a fine contrast with *Exquisite*, both being ripe together about the end of August.

Canary.—A good-sized orange-coloured Peach, streaked with pink on the sunny side. Freestone, juicy, with the usual Apricot flavour of these southern, pointed fruits. Ripe just after Early York.

Golden Purple.—A beautiful medium-sized Peach, with a rose-water flavour; remarkably elegant colour and form. Ripe about the same time as Canary.

Thomas's November.—Ripe with us in October. A capital medium-sized Peach, prolific and good.

Baldwin's Late.—The latest Peach in the house. Ripe in November. Medium size, of a pale greenish colour, juicy, and good. It, however, required more sunshine.

Poole's Late Yellow.—Fine colour and flavour. Ripe the end of September.

I have seventy varieties of Peaches and Nectarines under cultivation, and I carefully exclude the midseason sorts from the house. Nectarines are a great success under glass. Apricots are more difficult to manage; they will not endure as much stagnant air as Peaches, nor such irregular watering. This year, however, like Mr. Rivers's trees, mine are loaded. One, *De Coulange*, a first-rate variety, has a hundred already stoned on it. *De Milan*, a full-sized Apricot, was gathered last year on the 20th of June. These two sorts are my best, and are more prolific here than the Peach-Apricot.

A valuable peculiarity of orchard-houses consists in their generally hastening the period of maturity of fruits. In this way I have gained at least a week in seven years. The difficulty is to retard the ripening.

It must not be supposed that the Channel Islands are especially suited for orchard-houses; they have nothing in advance of the south of England. If our winters are comparatively mild, the Peach does not suffer from dry frost in the mother country, while our springs are cold and long, and our pleasant autumns are apt to produce

too much growth in all fruit trees. But our greatest drawback is the continually cloudy state of the sky in summer: the temperature then, though agreeable to the human body, is many degrees too low for ripening delicate fruit trees. Many cultivators have abandoned out-door Peach training from this cause, joined to cold winds and spring blights; so that we, too, are gradually coming to adopt orchard-houses. The few cases of failure that I have witnessed arose from neglect.

There are many other points of view from which this interesting subject can be studied; but, in this instance, it seemed a fair test of what can be done for an amateur to compete, and profitably, with others in an open market. I cannot allow that producing fruit for an employer demands more skill or labour.—T. C. BRÉHAUT, *Richmond House, Guernsey.*

MANAGEMENT OF FIRES.

(Concluded from page 310.)

It should be borne in mind that the less air passes into the fire after the requisite heat is obtained, the less fuel will be consumed in maintaining the heat necessary, and the less will cold air reduce the heat raised by the fuel. All air should pass into the furnace through the ashpit-door, beneath the fire of course, so that it may be partially heated before it enters the fire itself by coming in contact with the heated grate-bars. On no consideration should the cold air enter by the furnace-door, for then it reduces the heat produced by the combustion of the fuel, wastes fully one-half the heat raised, and tends to create a rapid combustion of the fuel, the heat of which is almost lost by a current of cold air coming in immediate contact with it, or passing over it. The furnace-door, therefore, should at all times be kept closed, except when opened for stoking purposes, for to open it does not increase, but reduces the heat, or wastes that which is raised, and causes rapid combustion to no purpose. It is a common practice, I am aware, to open the furnace-door when the heating surface is heated sufficiently; but it is a practice contrary to the object of the door itself, that being to prevent the heat raised by the combustion of the fuel from ascending the flue too rapidly, and to confine the heat, and not allow it to diffuse itself into space not required to be heated. The less draught a fire has after the necessary heat is attained, the greater heat is obtained from a small consumption of fuel, and this cannot be the case unless all the heat raised is made to pass along the flue slowly, for if the draught be great a greater percentage must necessarily be lost by the rapid journey along the flue and quick exit at the chimney. There cannot be a doubt that we have yet much to learn as to the economical consumption of fuel, and much may be learnt, I think, by a study of the construction of some of our steam-boiler furnaces, some of which consume but a small quantity of fuel, and yet afford an astonishing amount of heat for the production of steam. Such matters I leave for wiser heads than mine.

After the fire has burnt a time, and needs attendance, which it should have without its being allowed to go nearly out, and the flue to become nearly cold, the grate-bars should be cleared, and all dirt cleared from the inside of the fire before any more fuel is put on, varying the quantity according to the condition of the fire. If it be low a less quantity must be put on than if it were strong, and more air must be admitted by opening the ashpit-door or damper, and the fire should be allowed to burn freely until sufficiently large again, when it should be made up, and the draught regulated according to its condition and the state of the temperature within the house.

The purpose for which a fire is employed exercises a great influence on the management; but I will only treat of firing for houses occasionally needing artificial heat, and those requiring artificial heat almost continuously. The first relates to greenhouses, and other structures employed for growing plants from temperate climates. In such structures it is only necessary to use a fire to dry up damp, and prevent the temperature becoming so low as to injure the occupants of the structure. It is a common practice to light a fire in greenhouses in the afternoon, to dry up damp during the dull autumn months. Now, this is radically wrong. The heat generated is damp owing to the flue, &c., being damp,

and the heat radiated causes a more rapid evaporation, which instead of drying the atmosphere makes it really more moist, and the result is, plants dripping wet in the morning. All fires to dry up moisture should be lighted in the morning, and gradually worked on so that air may be given during the day for the moisture to pass away. The fire, therefore, should attain its greatest heat by noon, after which it should be made up, and left to burn out slowly. Greenhouses, and all structures of a like nature, need no fire at night in mild weather, for if a fire be employed then, the temperature is greater by night than by day, and that is contrary to the laws of Nature, and causes a sickly condition of the plants. A few degrees of frost with a dry atmosphere are not half so injurious to vegetation as an artificial, warm, moist atmosphere at night, when plants are inactive. It is in reality stimulating them into growth when Nature has determined that they should rest. It is, or was, an old saying amongst gardeners, "If you want insects fire hard; but if you wish to keep your plants clean and healthy fire no more than is really necessary." I have always found that saying true, and I strongly urge those having the care of plants to employ no more fire than is imperatively necessary to effect their healthy development and maturation, to economise fuel, to take care to give air early, so as to let in natural heat, and to close early, thereby shutting in and securing a good amount of the same.

For drying up damp, and securing a free circulation of air, fires, as before stated, should be lighted in the morning, and when the heating surface is a little warmed air should be given at the top of the house, which will secure a circulation quite adequate to dry up damp. The fire should be kept steadily going until noon, or until two o'clock in the afternoon, when it should be made up, the furnace and ashpit-doors closed, and the damper thrust in, if necessary, so that the fire may burn slowly, and yet consume all the fuel in the furnace. It will thus be seen that by lighting the fire in the morning the heat increases with the light and heat of the day, and like natural heat, attains its highest temperature in the small hours of the afternoon, after which the temperature remains stationary for a time, then gradually declines like the light and heat of day.

Firing to keep out frost is another business belonging to cool houses, and for this purpose the fires are lighted at all times, but only when necessary. It is immaterial when, only the fire should not be allowed to become too hot, for an artificially hot air is of all things most injurious to plants. It requires a vigilant eye to know when to light a fire in such structures as greenhouses; but practice and a diligent servant will seldom fail to detect the right time, and that is when the external air attains a temperature likely to affect the safety of the plants in the greenhouse. Then he will put on a gentle fire, and not go to bed until he see his charge in a fair way of being safe. It is no system to allow the temperature of any structure to become reduced by cold to a minimum and then put on a strong fire. It is false economy, and the effects of a strong fire are injurious to plants but recently exposed to too low a temperature.

Then as to fires employed for heating structures requiring a regular or continuous artificial heat. These are kept almost continuously at work, and as there are many structures requiring heat regularly, I may remark more minutely thereon. Given a structure—say a stove, requiring heat day and night, the first thing a gardener does in the morning is to examine the temperature of the house, which should be at its minimum. The fire is then attended to, cleared of clinkers and ash, and fuel put on according to circumstances. If it be out it is lighted; if low a little fuel is put on, and the damper is drawn out to increase the draught; or if large but little or no fuel is put on, though it may be necessary to increase the draught and obtain a higher temperature in case the fire has not burnt properly during the night, and the minimum temperature become too low. Whilst the fire, or fires, are getting into order the ashes in the ashpit are cleared away, and a fresh supply of coal, if necessary, brought in. The fires are then looked at again, and left gently glowing until breakfast time, when they are expected to have warmed the flue or hot-water pipes, whichever it may be, and raised the temperature of the house 5° in winter and 10° in summer above the minimum temperature. The fires are then made up so as to gain a little by noon, at which time

the highest temperature of the day is attained, and the fires are then made up, and the draught regulated so that the heat may gradually sink until nightfall. Before leaving work the fires are again attended to, and more fuel is added and the draught increased or diminished according as the fire is too hot or too cold to maintain the proper temperature. If too hot the draught is reduced to a minimum, and the fire is smothered with ashes instead of fuel. About eight o'clock or from that to ten o'clock the stoker takes a look upwards (about the only one he does take), scans the face of the skies, notes whether there is a probability of a frost or not, and then shapes his course accordingly. If the weather is frosty the state of the thermometer outside is taken, then that within the houses is examined, he calculates according to the state of the temperature of the house, the condition of the fire, and the probable alterations in the condition of the external air whether there will be a change before morning for a colder or higher temperature. I need hardly say he makes the fire up according to his judgment; if too low he works it on to obtain the proper heat; if too hot he leaves it so that it will be considerably lower in temperature before morning. G. ABBEY.

HONOUR TO HORTICULTURE.

We are happy to be able to announce that, on the distribution of prizes at the Great Horticultural Exhibition at Brussels, on Sunday last, by the King, Mr. James Veitch, of Chelsea, was created a Knight of the Order of Leopold, in consideration of his services to horticulture. When will he, or any other person following the same pursuit, meet with a similar recognition in this country?

THE ROYAL BOTANIC SOCIETY'S THIRD SPRING SHOW.—APRIL 30.

This was held in conjunction with the National Auricula Society's Show, and that flower consequently was largely represented; but of other flowers there was an excellent display. The Roses of themselves formed a lovely exhibition—one which certainly had never been surpassed, if indeed equalled, at any previous spring Show; whilst of Azaleas, Pelargoniums, and Cinerarias there was no lack.

Roses.—First prizes were awarded to Messrs. Lane & Son and Mr. Turner, of Slough, for collections of six in pots, the plants of both being healthy and vigorous, and bearing numerous magnificent blooms. Messrs. Lane's were Paul Ricant, Paul Perras, Duchess of Sutherland, Baronne Prevost, Comte de Paris, and Souvenir d'un Ami; whilst of Mr. Turner's the most remarkable were Madame de Cambacères, Paul Perras, Comtesse de Chabillant, and Madame C. Wood. In Mr. W. Paul's collection, which was placed second, *Lælia* was remarkable for the immense size and beauty of the blooms; Madame Boll and Senateur Vaisse were also fine; in addition to which were a large plant of *Triomphe d'Amiens*, Catherine Guillot, and Souvenir d'un Ami. Messrs. Paul & Son took a third prize for a collection, in which Comte de Nanteuil, Charles Lawson, and Victor Verdier were conspicuous. Mr. Turner had, in addition to his six, a fine collection, for which he received an extra prize.

The only exhibitor in the Amateurs' Class was Mr. Cross, gardener to Sir F. Goldsmid, Regent's Park, who had a first prize; but the plants, though well grown, were not to be compared to those of the great growers already cited.

Cut Roses did not come up to what we have seen on previous occasions. Among them were fine examples of Lord Herbert, of which a small plant was also shown, Lord Clyde, Mrs. W. Paul, Princess of Wales, Paul de la Meilleray, and Rev. H. Dombrain, which, as new kinds, at once caught the eye. Of older varieties there was a host. Both in the Class for twenty-four cut blooms and in collections, Mr. W. Paul was first, Messrs. Paul & Son second. Mr. Treen, of Rugby, was also an exhibitor.

PELARGONIUMS.—Mr. Turner was the only exhibitor in the Nurserymen's Class, and received a first prize for fine plants of Sir C. Campbell, Orion, Dr. André, Eugène Duval, Canopus, and Phœbe. Among the Amateurs' the best six came from Mr. Wiggins, gardener to W. Beck, Esq., Isleworth, whose plants were excellent, both as regards growth and bloom. They were Amazon, Madame Heine, Plene,

Madame Corbay, Rosabella, and Princess Mathilde. Mr. Weir was second, Mr. Todman third.

PANSIES.—Good stands of these came from Messrs. Dobson & Son, James, Bragg, and Treen; Mr. James taking the first prize, Mr. Bragg the second. The last-named exhibitor had also a very good stand of thirty-six Fancies, and eight pots of the same, for which he had an extra prize. Messrs. Dobson & Son had also an extra prize for a similar exhibition of the show kinds.

AURICULAS.—Though well represented as regards numbers, and though many remarkably fine trusses were shown, these were not so good as usual. Owing to the cold winds and absence of sun, many of them were rough and not flat; and many of the northern growers were not able to show owing to the lateness of the spring. Of the different Classes, Page's Champion, Lancashire Hero, and Prince of Wales were the best *Green-edged*; of *Grey-edged*, George Lightbody, Richard Headley, and Maria; of *White-edged*, Smiling Beauty, Taylor's Glory, and Favourite; of *Selfs*, Mrs. Smith, Metropolitan, Mrs. Sturrock, Blackbird, and Pizzaro.

Of new kinds, the best were Campbell's Admiral Napier, Turner's Buckstone, Reid's Miss Giddings, Smith's Richard Cobden, and Jamieson's Mrs. Jamieson. These are promising flowers, but require more proving.

In the Nurserymen's Class for six distinct kinds, Mr. Turner had a first prize for Campbell's Admiral Napier, Reid's Miss Giddings, Lightbody's Fair Maid, Violet very beautiful, Spalding's Metropolitan, and Blackbird; of which kinds the trusses shown were splendid examples. From the same exhibitor came also a fine collection of twenty-five, for which an extra prize was awarded. Among Amateurs, Mr. Potts, Old Kent Road, had the first prize, Mr. James the second, and Mr. Butcher, Camberwell, the third. Messrs. Hopkinson, Paine, and Holland, had also good exhibitions.

In the National Auricula Society's Show Mr. H. Steward, of York, took first prize in the Class for eight, with Conqueror of Europe, Fletcher's Mary Ann, Beoston's Apollo, Lightbody's Meteor Flag, Smith's Waterloo, Traile's Mayflower Countess of Dunmore, and Pizzaro. These were very fine, as also were the eights of Mr. Turner, who was second; of Mr. Pohlman, of Hull, third; and of Mr. Headley, of Stapleford, fourth; and nothing less could be expected from these great florists.

In the Class for four distinct varieties Mr. Headley was first, with Colonel Taylor, General Garibaldi, Napier, and Mrs. Sturrock. Mr. Pohlman was second, Mr. Turner third. The first prize for the best *Green-edge* was taken by Mr. Wilson, Halifax, with Page's Champion; the second by Mr. Turner, with Cheetham's Lancashire Hero; that for the best *Grey-edge* by Mr. Douglas, York, with Countess of Wilton; the second by Mr. Headley. The first prize for the best *White-edge* went to Mr. Turner, for Taylor's Incomparable; the second to Mr. Wilson, Halifax, for True Briton; and in the Class for *Selfs* the same exhibitors held the same relative positions with Metropolitan and Othello; the prize for the best of any kind going to Mr. Turner, for Buckstone, which also received a first-class certificate.

NEW PLANTS.—There was a good show of these, mostly the same as those exhibited at the last Show at Kensington, and for particulars of which we must refer our readers to the report in our last Number. Messrs. Veitch had first-class certificates for *Primula cortusoides amœna*, *Dracœna Cooperi*, their fine large-flowered variety of *Franciscea calycina*, and for *Clematis Regina*, with splendid bluish lilac flowers, a hybrid between *lanuginosa* and *azœura grandiflora*, raised by J. Anderson-Henry, Esq. They had also their fine hybrid white-flowered *Rhododendron* Princess Alice, and a hybrid *Cattleya* between *Epidendrum aurantiacum* and *C. Skinneri*, the flowers partaking of the orange colour of the former. Mr. Williams had first-class certificates for *Dendrobium Dayanum* and *Dalhousianum superbum*, the latter with a magnificent spike of cream-coloured flowers marked with two deep crimson blotches; also for *Rhododendron Nuttalli* and *Xanthorrhœa australis*. *Ancuba japonica marginata*, broadly and irregularly margined with light green, which will doubtless be yellow when the plant is in a more advanced stage of growth, was shown both by Mr. Williams and Mr. Bull; but it cannot be judged of till the colour and marking be more fully developed.

Second-class certificates were awarded to Mr. Thompson

Ipswich, for *Collinsia verna*, already noticed in these pages; to Mr. Turner for *Cineraria Herbert*, a very pleasing bright blue-edged variety, with a clear white ring surrounding a dark disk; to Mr. Bull for *Astrocaryum mexicanum*, an ornamental-foliaged plant, and for *Geranium Eve*, a pretty pale pink; and to Messrs. Fisher, Holmes, & Co., for *Berberis Handworthiensis*, with linear yew-like foliage, and numerous small yellow flowers. Both Mr. Williams and Mr. Bull received prizes for groups of new plants which have been already noticed in previous reports.

MISCELLANEOUS.—For a collection of mixed fine-foliaged and flowering plants Mr. Williams had the first prize; Messrs. A. Henderson & Co. second; Mr. Young, Highgate, third; Mr. Cross fourth. Among them were fine plants of *Gleichenia spelunca*, *Cymbidium aloifolium*, with numerous fine spikes of bloom. *Pandanuses*, variegated *Crotons*, *Aphelexes*, *Boronias*, *Eriostemons*, *Azaleas*, &c. Of *Azaleas* Mr. Turner exhibited some magnificent plants, for which he received a prize; and Messrs. Lane and Dobson & Sons had also prizes for nice well-grown plants. Awards were likewise made to Messrs. Dobson and Mr. James for *Cinerarias*; to Mr. Young for exotic Ferns; to Mr. Turner for *Bougainvillea speciosa*; to Mr. Cross for *Begonias*; to Messrs. A. Henderson & Co. for a collection of ornamental baskets, pots, and vases, among which were several pretty designs in porcelain, with and without silvering, and in which the plants were contained in a separate inner casing of tinned iron, in order to prevent the water dripping into the room; and to Mr. Young for hanging-baskets, neatly filled with *Caladiums* of various kinds, with a *Dracæna* in the centre.

FLORAL CRITICISM.

If any one doubt whether the task of reporting on the merits of the various productions of those growers who are constantly adding to the list of our garden flowers and fruits be an agreeable one, he has only to consider the manner in which one who really speaks his honest opinion, as I have endeavoured to do, has been treated by those who, from their education and position, ought to know better—firstly by Mr. Rivers, and now by Mr. Wm. Paul; but it does somewhat astonish me that they should endeavour to impute motives when they must be utterly ignorant of such being those which influenced me, and refuse to give me credit for honesty of purpose, as is apparent in the very sharp letter of Mr. Paul in your last week's issue, in which he endeavours to fix me on the horns of a dilemma—either that I am an ignoramus or else a knave. I hold it to be utterly useless for any one who professes to be a teacher in public matters of any kind to imagine that he can be of any service unless he give his opinions without reference to whether he may please this or that person. Such has been ever my wish; and were I to be asked to abandon it, I would rather lay aside my pen on any subject on which I am in the habit of writing. I know what it entails. I know that some are "tetchy," others jealous, others so enamoured of their own productions and theories that to attempt to please them would be as useless as to endeavour to ladle out the sea. But I do know that those for whose benefit I write appreciate it; and while I have said many things adverse to the theories or productions of horticulturists, I am not conscious of having imputed to them unworthy or dishonest motives.

And now with regard to this latest attack. Mr. Paul accuses me of disparaging his Rose *Beauty of Waltham*, and of habitually doing the same with regard to all his productions. My answer to both these statements is that they are not true; and I will take the last first, as it contains the virus of the whole letter; nor will I meet it by counter assertions, but by simply referring to what I have said.

Mr. Paul is an exhibitor, and a very successful one, in two classes of flowers—the *Hyacinth* and the *Rose*; and during last year and this (it will hardly be necessary to go further back), I have sent reports to you of the following shows at which he has exhibited—the Royal Horticultural and the Crystal Palace last year, and the Royal Horticultural and the Botanic during the present spring.

In my report of the first spring show (Vol. IV., p. 166), I said of Mr. Paul's twelve *Hyacinths* there were "Howard,

a salmon crimson, with stripes of deeper colour; bells close, and spike good. Grand Lilas, a fine and useful azure blue flower. Queen of the Netherlands, a good pure white. Solfaterre, a brilliant orange scarlet; large bells and spike. Charles Dickens, a good greyish blue, with an excellent spike." Speaking of the large collections of *Hyacinths* I wrote, "In Mr. Paul's, which were placed equal first, there were some fine trusses," &c. This remark refers not merely to the sorts but to the style of cultivation, as indicated by the size of truss, &c.

In my report of the second spring show (Vol. IV., p. 219), I wrote thus: "Mr. W. Paul occupied the place hitherto held by Messrs. Cuthush & Son, who came second in the three classes, Mr. Paul standing first. In the collection of six new and distinct varieties Mr. Paul had some very magnificent blooms, Koh-i-noor being quite a model." "In the class for 18's both Mr. Paul and Messrs. Cutbush had some very fine trusses. Amongst the former were Haydn, very large; Koh-i-noor, a splendid spike; Macaulay, very fine; Solfaterre, large and good, novel, too, in colour—a sort of orange red." "Amongst the 100 varieties contributed by each firm were some really magnificent blooms." "The most favoured spot in the exhibition was, however, that where the two boxes of *Roses* exhibited by the Messrs. Paul were placed; and an opportunity was afforded of seeing some of the new *Roses* of last season, especially in the box of Mr. Wm. Paul." May I ask, Does all this look like not seeing anything good of Mr. Paul's productions?

In my report of the Crystal Palace Show (Vol. IV., p. 393), I find my report runs thus:—"Roses in pots were not, I think, so fine as I have seen them, although some individual plants were magnificent. My own taste rather inclines to the smaller-sized plants than to those monstrously overgrown specimens; but taking them as generally admired, *nothing could be finer* than the plant of *Souvenir d'un Ami* or *Charles Lawson* in Messrs. Lane's collection, or the *Lobelia* of Mr. Wm. Paul. So close was the contest here that the Judges placed the two collections as equal firsts. In *Roses* in eight-inch pots Mr. Wm. Paul was second with . . . *Beauty of Waltham, fine*," &c. "In Cut *Roses*, in Mr. Wm. Paul's collection I saw *Monte Christo*, *Souvenir de Lady Eardley*, both good, *Beauty of Waltham*, and *Amiral Gravina*, a dark and good flower."

In my report of the Royal Horticultural Society's first show (Vol. IV., p. 411), a very brief one, I said, "The *Roses* of Messrs. Lane and Mr. Wm. Paul were again very nearly matched, but the freshness and novelty of the latter's gained for him the first place."

At the second great show I do not think Mr. Paul exhibited Cut *Roses*—at least I do not see his name amongst the list of prizes. He did, I believe, exhibit pot *Roses*; but as I took no notes of any of them he cannot complain of my partiality there.

In the report of the Crystal Palace Show (Vol. IV., page 470-471), I merely gave the names of the *Roses* in the classes of cut flowers, and those only in the first and second prizes. I find my notice of *Beauty of Waltham* runs thus:—"A fine Rose, but soon flies."

In my report of the National Rose Show (Vol. V., p. 7), I again find myself recording the names of new *Roses*; and amongst Mr. Wm. Paul's stand of new *Roses* I mention, "*Beauty of Waltham, good*." And again, "It was quite too late for pot *Roses*, but some creditable plants were exhibited by Mr. Wm. Paul, Messrs. Turner, Paul & Son, and Francis." "In the class for twelve blooms of any new Rose Mr. Wm. Paul was first with *Beauty of Waltham*."

So end my reports for 1863 as far as Mr. Paul is concerned, for at the autumnal shows, either at the Crystal Palace or the Royal Horticultural Society, he did not exhibit. And I now leave it to any of your readers—nay, I leave it to Mr. William Paul himself, to point out any attempt at underrating his productions, or not seeing anything good out of *Waltham Cross*. Both in *Hyacinths* and *Roses* I have given him praise, and that, I think, with no sparing hand.

And now as to the charge about *Beauty of Waltham* and Mr. Paul's indignant disclaimer of my criticism. I did not state then, let me say, that *Beauty of Waltham* is not distinguishable from *Madame Charles Crapelet*, but that *the bloom then exhibited was undistinguishable from it*. I was

not giving a general description of Roses, I was merely noticing the Roses as *then* exhibited, for such a report at a flower show only pretends to be; and I maintain that the bloom Mr. Paul exhibited that day could not by one rosarian in fifty be distinguished from Madame Charles Crapelet; but that is a very different thing from saying that it is always so, or that Mr. Paul has been guilty of dishonesty in sending out an old Rose under a new name. He is too good a Rose-grower not to know that when Roses are in the same style that they very often do approach so closely as to be undistinguishable. I have seen Madame Vidot and Mrs. Rivers in the same stand, but the labels might have been changed over and no one the wiser; and I have seen Triomphe d'Amiens with all the marking gone, and like an indifferent Général Jacqueminot. The opinion that I have given of Beauty of Waltham all through I still hold to. It is a "fine Rose" and a "good Rose," but its colour soon flies in warm weather (and probably in heat); and when it does so it is as like Madame Charles Crapelet as it well can be. I have seen hundreds of blooms of it; this is my honest opinion, and I know it coincides with that of many successful growers.

Why, then, will Mr. Paul impute motives to me? Why not be a little more charitable? I have found fault with the productions of other raisers, but they do not write furious letters. There was a Rose sent out by Mr. Standish which I at one time thought well of, but it failed to keep up its character, and I said so; but I was not marked as a black sheep therefore. In my reports of the flowers of last season I have unhesitatingly condemned many of very pretentious character, but I have not been abused by the raisers.—*D., Deal.*

A GOSSIP ABOUT HOTBEDS.

WE have received a number of definite inquiries and complaints of failures, the inquiries having chiefly reference as to how to make the most of a small quantity of fermenting materials, and the failures being either from using these materials in too rank a state, or expecting too much from a very limited quantity, and especially at an early period of the season. Our random gossip will, therefore, chiefly apply to those readers who for fermenting material must chiefly depend on the droppings and litter afforded by a horse, a cow, and a pig, with perhaps the occasional purchase of a load from persons in similar circumstances who do not wish to do anything with the manure. We will take the cases somewhat at random.

"A" states "that by purchasing, in addition to his own material, he put up a bed 2½ feet deep in the end of February that it gave plenty of heat, and he planted out Cucumbers in the beginning of March; but the heat declined, and damp, cold, and steam killed his plants." He would have required at least a foot more of well-wrought dung to have kept up a nice heat at that early period, and must either have had more material to have added as linings, or have made the bed some 18 inches larger all round than his frame, and protected those sides from wind and weather by a thatching of straw or evergreen branches. It is amazing the effect that such a protection, even if only a wattled hurdle, has round the sides of such a bed in keeping the heat in. When a hotbed is to be made at all early, and the ground permits of it, it is a good plan to have a good part of the hotbed sunk beneath the ground level. The fermenting material is thus not brought so much in contact with the air; and therefore, whilst the heat will not be so strong it will last much longer, and then, the frame being much lower, all work inside will be more easily performed. Such a bed, fully half sunk and made as large as represented above, will rarely want more in the way of heat until the autumn than adding fresh litter round the sides of the box, and thus securing, from the warm sides of the box, atmospheric heat inside independently of the heat that rises from the warm dung beneath the soil.

If "A" had been content with his amount of materials to have planted out in April, he would have been more successful. Even then, if his materials were not very good, he would require a bed 3 feet in depth, unless he had some means, as fines or open fagots, for sending heat from linings through beneath the soil. It should not be forgotten,

however, that the linings take a great quantity of material for the heat they give—that, in fact, one good load of hot manure inside will do more in the way of heat than three or four applied as linings.

"B" "has a fair amount of material and a brick pit, which he uses for early work. He has commenced placing his fresh manure round the outsides of the pit, and turning and working it there for hotbed frames; but then several authorities tell him he will get the rank steam inside, and that he will kill everything." And so he will if the rank steam come in. But why should it do so if common prudence be exercised? If the wall is solid and secure in the joints, be it 4½ inches or 9 inches, no steam can pass through, but the heat will, and perhaps best from a 4½-inch wall; and the sprinkling of such a wall inside with clear water will give off a vapour that most plants delight in. In giving air, however, care must be given to lift the sashes and tilt them up, and not shove them down or pull them back. This is also necessary in the case of frames with linings round them. We have known a crop destroyed by shoving down a sash a few inches over a front lining which was a little rank. Even a mat hanging over is liable to produce the same result. When such care is not exercised the linings ought to be as sweet as the bed. There will be less danger for all things requiring much heat from the fact that air will be wanted chiefly at the top—we might say solely at the top. There will be no want of circulation of fresh air if the sashes are merely tilted a little at the top; the great point is to do it early enough.

All turning and moving of such rank linings should be done when the sashes are shut. If covers are used for the glass it would be as well to do this turning work before the covers were taken off. We know of no more economical plan, where fermenting material is abundant, for preparing manure for sweet hotbeds, as most of the heat given off is brought into use, instead of passing all away into the general atmosphere. When a pit and its linings are sunk, and the linings are covered in with boarded flaps, scarcely any heat will escape, as what rises will strike against the walls. Unless the linings are wide there will, however, be more trouble in working them than when mostly above the ground. As to rankness, we may mention that we are glad to pack our first mowings from the lawn round our frames, and the heat such grass gives off is rank enough; but with moderate care as to air-giving, there need be no injury occasioned thereby.

"D" tells us, "Since giving less bottom heat and banking up round my frames or pits I have escaped unhealthiness and burning at the roots. But obtaining so much top heat, I would wish to have more. Would you approve of large slates, or plates of iron let into the walls of brick pits? and what would you say to light iron frames instead of wooden ones?" As to the pits, we approve of them, so long as the slates and plates are covered outside. If uncovered they would rob the inside of its heat much more than a brick wall. Even the brick wall of a pit that is heated inside loses much heat by the wall exposed. We have tried a layer of straw against the exposed wall of such a pit, and during winter and spring if you place your hand on the wall beneath the straw it is like putting it on a warming-pan. The slate, and much more the iron, would radiate heat more quickly than brick. We may mention that our walls are 9 inches thick, and if heat comes out through that thickness it will also go in. As to the iron frames, there can be no question as to the sending heat through them, and they could be made moveable in pieces by bolts, &c. We never have wrought such; but we would, judging from analogy, come to the conclusion that unless covered up outside, they would part with heat from the inside very freely. The fermenting material would also be apt to rust them out. To guard against this we would have them shallow—say 10 inches in front and 16 or 18 at back, with a sill at bottom. The outsides we would tar well, and use only when well dried. The inside we would paint of a dark lead colour, and when in use we would paint again with much the same colour, made of size water and soot or lampblack and sulphur. Did we wish the greatest amount of heat and light inside we would make the colour light; but if at all light there would be danger of scorching from the reflected rays of the sun during the day. The dark colour would absorb the heat of these rays, and that heat would be radiated, and also the heat from the linings, when most needed. We should certainly like to hear of

such frames being used. When the outside could not be covered with a lining it could be protected from the free atmosphere with litter or straw tied neatly on.

As an evidence of the effect of little matters, we may mention that during the first frost this last winter an amateur told us, that of two frames standing on the top of an old hotbed, and filled with similar plants, and with one exception treated every way alike, the plants suffered much in one and escaped in the other without injury. In the one case the boards of the sides of the frame were exposed; in the other an inch of straw was tied round them, the ends hanging over the sides of the old bed. With iron sides and unprotected not a plant would have escaped. This fact reminds us of another. A number of loads of Potatoes were stored in a small brick building. Care was taken that air should circulate through them to prevent heating. The roof was tiled and somewhat open, and therefore some 16 inches of straw were placed over the Potatoes. A very sharp frost came; the door and the windows were securely covered, but nothing was thought of the walls; but through them the frost entered, and all that was good in the Potatoes was found only in the centre of the heap.

"E" "used to have very deep frames, but they were unwieldy. He had them cut so as to have a bottom and a top easily moved, as without this convenience of movement he might as well have had a pit or a fixed frame; but then he found that steam penetrated between the joints. He then tried shallow frames 11 inches in front and 17 at back, and Cucumbers and Melons did well in them at first; but then the leaves came too near the glass, and the frames had to be raised by supports at the corners, and then steam was apt to find its way in all round if the smallest cranny was left." No doubt, but then the cranny should not be left. The earth should be firmed to the bottom of the frame all round. It is best to avoid all this lifting, and let the frame stand steady whilst the crop remains, and this may easily be managed. We have not a frame deeper than the above—quite deep enough for many general purposes. Ours are not deep enough for Cucumbers and Melons, but the depth is easily secured. We made a couple of beds the other day, which had served many purposes previously according to the thickness of the bed, the fresh manure being placed at the bottom and the older at the top. But these beds finally might be 3 feet high at back and 2½ feet in front, made all over of rather open materials and well beaten. Then all round the sides, so as to be 6 inches wider inside than the bottom of the frame, a wall was built of the best and sweetest material 16 or 18 inches higher than the main part of the bed, so that the soil inside should be little or nothing higher than the bottom of the frame. The six inches overhanging is then beaten firmly, so as not to extend much, if at all, above the base of the frame. We thus secure plenty of heat outside and less in the centre of the frame. Allowing 2½ feet wide for soil in the centre, the outsides may be filled up with sweet short dung at first and removed afterwards. If that space can be shut off with boards it will give quite enough of soil for the plants; and between these boards and the sides of the frame we generally fill with sweet dung and cover over with soil, placing some stiff loam or clay close to the sides of the frame, and wetting it and beating it firm. This kept rather damp will not crack; and there will be no trouble from lifting the frame or danger from steam; and there will be plenty of room for the foliage except at the front, where the soil should be 2 or 3 inches below the bottom of the frame but joined to it, and a couple of inches above it, by a short sloping bank of this firmed earth. The little extra trouble at first saves much labour afterwards.

"F" "has tried a plan recommended by us of only slightly working his stable-manure before using it for beds, and means to go back to the old plan of working and turning his heap some three or four times until it is a uniform sweet dark mass, as such, he finds, gives a more uniform and continuous heat than dung that has been less worked, which latter is apt to dry up and cake when built into a bed." Well, we advise every one to use the peculiar bridge that carries him safest over the stream. If such material only slightly fermented be used in a dry state it will be apt to cake, and the extra air and want of moisture will arrest the heat that can only be given off so long as decomposition is taking place, and there is enough of matter for the oxygen to burn or de-

compose. We easily remedy this by making holes obliquely at the sides of the frame, inside, and pouring water down. This is best done by leaving small round drain-tiles standing nearly upright, and the upper end plugged to prevent any noxious steam escaping. These should be plugged again when water is poured slowly down, a pailful or more to a light. This will take down moisture and air likewise, which will cause fresh bottom heat as long as there is any fuel left for oxygen to burn. This is also a good plan for supplying moisture at bottom when not wanted at top. However, we have no fault to find with the thorough working and sweetening of dung before using it for beds. Only we are short of material and we want the heat that is given off whilst working.

Much of the dung we use in winter for Radishes, Potatoes, &c., comes in for the tops of beds for Cucumbers, Melons, &c., in spring and summer. Our dung is chiefly litter with but few droppings, and often the latter must be saved for Mushroom-beds. However, we leave a few so as to make the litter ferment with the assistance of watering, and if manure water can be obtained from the drainage of a farm-yard all the better. This is thrown together, well mixed, and the heap covered with dry litter. When this has heated eight days we frequently use it as it is. More generally we give it one turn, taking off the litter outside, covering, and then placing the top to the bottom, and the sides to the centre, and mixing with it some tree leaves, which are generally hot from lying in a heap. We do not mix these at first because we do not wish to waste them by fermentation, and after they have lain a short time in a heap they will always be sweet enough. We cover the heap over again so that it shall heat equally, and in about a week in general circumstances and if the weather is at all mild, it will be fit for the main bulk of a bed, whilst we give a surfacing of leaves, or part of an old hotbed as a surfacing to keep down any steam that might be injurious. The heat we thus obtain with this surfacing is generally sweet enough for anything.

"G" "has suffered much from unhealthy steam killing his plants, and is much alarmed after reading such accounts of inflammable gases in dung-bed frames." Well, we never noticed anything of the kind but once, and then there was an extra quantity of urine, blood, and hoof-parings among the manure that had been fermented, inasmuch that we did not at all like it. When covered over with earth we do not, however, recollect of any bad effects having followed. When dung is used pretty well sweetened in the usual way, the drops of water condensed against the sash-bars will always be a good test of healthy sweetness. If clear as dewdrops there will be no danger. If tinged of any colour there will be danger. If the tinge is but trifling—just perceptible, a little air constantly at back will avert the danger. A surfacing of from 9 inches to a foot of sweet older material will avert all danger. Hence, when satisfied about the amount of heat, a surfacing of soil will also keep down any noxious steams if thick enough and firm at the surface. This fact lessens the necessity of wasting manure by such frequent turnings before using.

"H" "obtains from two to three barrowloads of manure, fairly mixed with litter, during the week—enough, he thinks, to make a bed now and then, with a little help; but all being placed in a heap, it is always heating, and the centre is quite rotten before he can use it for anything." Keep this centre for surfacing, or the roughest of an old hotbed. Do not throw your manure into a heap at all. If you have a shed at liberty, spread it out there, a foot or 15 inches thick. If not, do the same out of doors, and sprinkle the surface with a little earth. This will keep in the gases and arrest decomposition. When you have as much as you think you will want for your bed, throw it nicely together in a heap, mixing the litter and the droppings, and watering when dry. Then you can use it according to our rougher way, or as recommended by our friend "F," and follow that which suits you best.

It seems we have forgotten to notice the dilemma of "C," who says, "I must use two or three barrowloads of manure a week, chiefly horse-droppings, and but little litter. I find, that when made into a hotbed, the heat given off is very strong, but it is not lasting; it soon burns itself out, or quite dry, even after being much wasted in the preparation." Such manure becomes too close; it wants mixing with a treble quantity of tree leaves, after the first rankness is gone, or

litter of any kind, or stubble would do. Failing all such, it should be freely mixed with layers of garden prunings; and, failing these, there should be a layer of dung and a layer of faggots, with the ends covered, to prevent too much air entering. Moisture and air are necessary to decomposition. Too much of either will arrest decay. What is wanted is just enough of both to keep the fire slowly burning, to give out continuous heat; and our idea is that, provided a heap is compressed enough to heat freely, the less the heap is wasted before being made into a bed the more fuel there is left to keep up the slow continuous combustion.

Once more for the present. "I" "wants to know how to make the best of his two barrowloads of dung a-week, chiefly horse-droppings, for assisting him with two or three frames, rather small, for forwarding a few early vegetables, and striking cuttings, sowing seeds, and forwarding plants for his flower garden in spring." For a rather large bed, we must refer to what we have said on preserving the manure before it is wanted. He says he has suffered awfully from steam; that comes from either not using the dung sweet, or not covering it enough when rank. Much, however, may be done in forwarding potted plants, striking cuttings, and sowing seeds at this season, with a constant supply of two or three barrowloads a-week of such droppings. Throw that quantity into a heap and cover with litter. That will make a nice bed for one light when it heats, if mixed with an equal quantity of half-rotten stuff from an old hotbed, and covered over with some 8 inches of the same. A fortnight will, therefore, give you enough for a two-light frame for such a temporary purpose. If the heat then comes too strong the pots can be raised. If you sowed the seeds, or planted the cuttings in sandy soil, you would need only about 4 inches of old hotbed stuff over your dung; but for much work the use of pots will be best. You can then remove what has been struck, rooted, &c., and commence afresh; and if the heat has declined a little, then out with the pots, move the surface sweet stuff again, and add a barrowload of hot droppings or so, mixing it a little with the old, but not tossing it much about to let out the heat, replace the covering, and place or plunge the pots, and if they get too near the glass raise the frame. A bed thus renewed inside every three weeks or a month will keep up a nice heat almost continuously, and, as hinted already, one barrowload inside will do as much good as ever so many round the outsides of the frame. Of course, in the case of manure chiefly litter instead of droppings, there must be double or treble the quantity used to produce the same effect. Without the covering referred to, or one of sweet hot tree leaves, it would be dangerous to use manure unsweetened for such a purpose. For all such temporary forwarding purposes, it is best to have the hot manure below the plants, and the moving of the material and a little fresh addition will always renew the heat. In such cases we like the hot material to be added without much shaking about. For a large hotbed we do not care how much there is of shaking and mingling.

"K" wishes to know "how large a bed should be for sowing half-hardy annuals, to be covered with frames, hand-lights, or calico, and sown on soil." Well, that depends on the material. If containing a fair portion of droppings, we would throw it together, water, and get it to a good heat. We would then make a bed from 15 to 18 inches deep, not shaking it too much to disperse the heat, cover with 2 or 3 inches of rotten leaves or dung, and 3 inches of sandy soil, and sow directly, or at farthest in a day or two.

We think these cases will bring up most of the arrears on this subject. If a few do not find their wants alluded to, we shall be glad to help so far as our own practice will enable us to do so. Simply covering a hotbed with sweet materials will prevent many an accident and disappointment.

R. FISH.

WINTER DECORATION OF THE FLOWER GARDEN.

WE this week give a design of the mode by which the winter decoration of the flower garden is effected at Linton Park, as taken from a coloured plan furnished us by Mr. Robson, but the colours unfortunately we cannot introduce

in our engraving. These were all simple and effective, the groundwork being black. The white figures were white, and those slightly shaded were red; so that red, white, and black formed the colours, to which might be added, if necessary, the green band of turf surrounding the whole.

Mr. Robson has also forwarded us portions of a paper on the winter decoration of the flower garden, as read by him at a meeting of the Maidstone Gardeners' Mutual Improvement Association—a body only formed last autumn, yet numbering upwards of two hundred members; and at its monthly and fortnightly meetings subjects of interest are often ably discussed. The flourishing condition of the Association during the winter months culminated in an exhibition of plants, fruits, and vegetables in the Corn Exchange, Maidstone, on the 11th of March, on which occasion the room (a large one), was tastefully decorated with evergreens, and the show of plants highly creditable. The exhibition was continued during the evening, when some medical gentlemen and others connected with the town kindly exhibited a valuable assortment of microscopes in a separate compartment; while in the body of the Hall papers on "The Harmony of Colour as applicable to Gardening," "The Wonders of Vegetable Creation," "The Cedar of Lebanon," and "The Winter Decoration of the Flower Garden," were read and favourably received. There were about 1200 persons present.

We now give a portion of Mr. Robson's paper on "The Winter Decoration of the Flower Garden."

THE great advance which, in every department of the industrial arts, has been made in decoration during the last few years, ought to stimulate those who have the management of that portion of the garden which, by its very name, indicates it to belong to the highest grade of the ornamental department—the flower garden; and those who have the management of such gardens are not behind the rest of the community in enterprise, skill, and the tact of perceiving where their inventive powers can be brought to bear with advantage on anything likely to gratify the taste of employers or the public. Flower-garden decoration, therefore, instead of following in the wake of other sciences of an ornamental kind, has in most instances preceded them; and some of the best designs for household decoration, whether in the way of wall papers, carpets, or the more costly productions of the carver, are indebted to the florist for their models; whilst the inexhaustible variety of forms which vegetation assumes gives scope for the many beautiful pieces of embroidery which issue from the loom of the manufacturer, or perchance are worked by the fingers of some fair one, whose dress at the same time may exhibit forms and patterns taken from the same inexhaustible source. The flower garden and its collateral branches, though affording so many good designs to the artist and manufacturer, is of itself also susceptible of innumerable changes and improvements; and it becomes all those having the management of such gardens to keep pace with the times, by the introduction of such changes or improvements as will merit the approbation of a public which has to a great extent become fastidious.

Important the subject of flower gardening now is when it is borne in mind that almost all dwellings of any consequence in country places, and many also in towns, possess flower gardens; and the adornment of these gardens requires no little labour, and often the exercise of much taste on the part of those concerned. If the garden should be large, the due adjustment of its planting in the summer has of late years become a work in which very considerable taste may be displayed; and in the case of public gardens any error or defect in this respect is sure to be visited by public condemnation—a censure by no means to be despised, the more so as the masses are at the present day pretty conversant with the principles on which true taste is based. It is, therefore, not to be wondered at that many of our public gardens exhibit good examples of flower gardening with much the same varieties of plants year after year, rather than make a wide departure in the way of novelties being introduced into use. We meet more frequently with fresh plants and fresh designs in private or smaller gardens, where the danger of offending an unsparing public is not to be feared; or, now and then, the subordinate departments of large gardens exhibit styles of gardening differing from

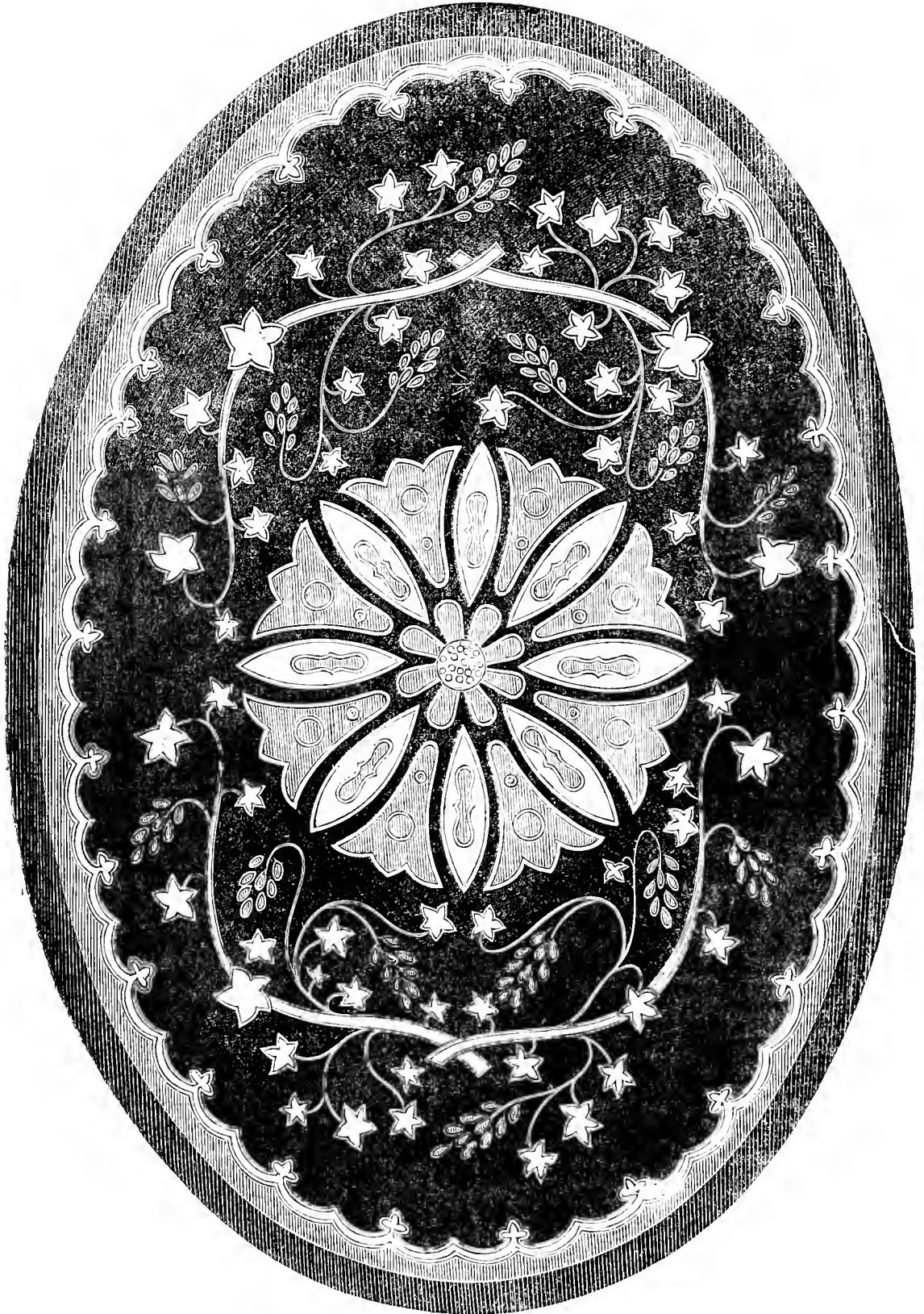

WINTER GARDEN AT LINTON PARK.

that so often met with. But as my object does not affect the summer decoration of such gardens, I have merely entered into these matters as an introduction to the more important subject I more especially call your attention to, which is the Winter Decoration of the Flower Garden.

The winter decoration of the flower garden, especially when such garden is placed in sight of the principal windows of the mansion, has, for a long time, been a source of trial and difficulty. The summer occupants of the beds being generally either tender or only half-hardy, succumb to the first frost, and a desolate blank suddenly succeeds the floral beauty of the autumn. To supply substitutes for such beds has long taxed the skill and ingenuity of the best gardeners of the day; and although there are means for the extensive cultivation of plants suitable for clothing beds with a respectable foliage during the cold and dull winter months of November, December, January, and February, a somewhat cheerful appearance may be kept up, yet floral beauty at that inclement season is entirely out of the question. Neither can any very telling effect be produced by any change in the disposal of the plants that are adapted for such winter display. In fact the number of plants that present an agreeable appearance at that time, after undergoing the removal rendered necessary in November, is far from being great; but as my purpose is not particularly to go into this matter, I will simply say that the best plant I have been able to obtain in any large quantity is the common Variegated Arabis, the light-coloured foliage, aided by its compact habit and adaptability for transplantation without injury at all seasons, give it the best place on the list. The soil being invariably damp, and consequently dark-coloured during winter, compact-growing light-coloured foliaged plants are the best of all for telling effect. No doubt a quantity of neat plants of Gold and Silver Hollies would be equally good, perhaps better; but in the absence of these such plants as we possess must be used to the best advantage. My purpose, however, is more especially to call attention to a plan that does not require any plants whatever, but which is complete in itself in a very few days after the first autumn frosts have destroyed the waning beauty of the parterre.

Taking this subject of the winter decoration of flower gardens in the sense conveyed by its name, I by no means assume the mode by which I would advise it being treated in winter to be entirely original; on the contrary, I believe there are examples in this country upwards of a century old, differing only from that which I now exhibit in their being permanent, instead of being annual as mine is; and, doubtless, some of these permanent examples of this kind of ornamentation present a more chaste and elegant design than that now presented to you. I need hardly say that such designs may be worked-out for winter decoration as well as for permanency; but if of a temporary character they have the advantage of giving every year an opportunity for a change, and the endless variety of forms which may be brought into use in such a space as the one here before you, gives scope for a greater exercise of taste, which of itself affords a pure and intellectual pleasure, differing widely from the tiresome monotony of always looking on the same thing over and over again. And, as the season comes round for effecting such a change, the task of designing a pattern that differs from all preceding ones, and, perhaps, is expected to be some improvement on them, is by no means an unsuitable employment for a lady; in fact, it is to ladies that we look alike for advice, assistance, and encouragement in such matters.

As some description of the plan now before you may be of service, I may observe that a walk 10 feet wide surrounds the oval bed, and a margin of 3 feet of green turf separates the walk from the bed. This bed was last summer, as in former years, planted with Variegated and other Geraniums, Perilla, &c., which continued tolerably attractive up to the first week in November, when a sharp frost destroyed them. The bed was at once trenched, and the remains of the crop buried as evenly as possible to prevent after-sinking unequally. After being trenched it was at once trodden all over firmly, and when required it was levelled, this treading and smoothing being done before it became wet, for kneading ground, as it is called, is a bad practice. After being well trodden over and smoothed with the back of a shovel it was

ready for marking out, which, I need hardly say, requires some little knowledge of geometry to accomplish quickly and correctly; but the work is not an arduous one. An ordinary garden line stretched across the oval the short way, and another the long way, and allowed to remain until the job was finished, afforded base lines to measure from; and as the centre figure is in outline a circle, it was easily drawn, the outside being measured into the required number of parts for the fringe work. The remainder of the ground was left for the foliage or embroidery. This was the most difficult part of the work, but the position of the stems of the foliage work being determined by measuring from the parts already done, the fixing of the leaves was not difficult. I ought, however, to have said that I had for guidance a plan on paper on a smaller scale than the coloured one, and the only tools used were a ten-foot measuring rod and an old Dahlia stake, the latter to scratch out the figures, while three men and two boys gave them the marked-out form by laying uniformly-sized broken Kentish rag stones on the lines thus marked-out. Each figure, and in fact each leaf, was surrounded with a close line of these stones, which gave a sort of beaded character to the whole, but which are not shown in the coloured model, and they formed a very important part of the whole. These stones were merely picked as being medium-sized from a heap of Kentish rag that had been broken for the roads; and when I say that it took about three cartloads of them it may be understood that the job was not small. Nevertheless it was not long in hand; for although, as every one knows, November days are short, and we could not do anything until the dew was dispelled after 9 o'clock, I may say that we began one morning at that time, and by the next day at noon had all the figuring and a part of the colouring done, and by the next day at noon the whole was finished, and it might have been done sooner if particularly wanted.

As will be seen, only three colours are used, and these are coal ashes for black, either broken-up old plaster or shells for white, and soft half-burnt red kiln bricks broken up for red. The ground being smooth, these substances are only laid on about an inch thick, yet they answer every purpose. In mild winters worms are apt to partially discolour them, more especially in March; but as we always remove the colouring matter then, and dig and prepare the bed for planting in May, it is of no consequence. In severe weather the bed looks as well as at any time; a slight covering of snow, leaving the tops of the grey stones peeping through like strings of beads, is far from uninteresting. But the great merit of the plan is that it affords a change every year, and gives scope for that interesting but endless diversity of design which every one is ready to give an opinion upon, and from which I admit I have learnt much. It requires, however, to be seen to be fully appreciated; and for beds on a large scale it certainly offers advantages for displaying taste which no other plan possesses; and, as I have before observed, the same variety, but in another form, may be introduced in the summer planting. It may be as well to inquire whether many of the flower gardens we now see composed of a number of small beds scattered over a lawn could not be altered so as to make a good-sized panel-bed, which might be sunk or not as desirable; and the pleasing task of contriving suitable designs for its summer planting and winter colouring might afford an agreeable study for ladies, while to our own craft a new field would be open for great improvement.

"FULL OF SCORPIONS IS MY MIND."

Macbeth.

MANY like myself must be astonished at the constant, never-ceasing wailings of amateurs. The one complains that his stove will not act, it burns so much coal and gives no heat. Another says, that though every point has been attended to his Cucumbers or Melons will not grow! Now, I am only an amateur. I have two gardeners, but all orders, &c., are given by me. I take upon myself the entire management of both flower garden and kitchen garden, and all goes well. I never yet had occasion to ask your advice, always so kindly given. I never have to complain that my Mushrooms will not break, that my Cucumbers come to

nothing. I lay no claim to extraordinary sagacity, great diligence, or exertion, but I do use my wits. I do look very sharply after minor details. I read all I can on gardening that I know to be worth study, and when I can I get a lesson from an old hand. The consequence is, that all works easily and nicely, the fires are kept in, the plants look healthy, the fruit is abundant, and there is no grumbling and whining. This is, perhaps, a little severe, but I want to apply the iron hot—the wound will heal the sooner.

The real state of the case is this:—There are two classes of amateur gardeners: one is ever ready to save itself trouble, as it thinks, by troubling the good-natured Editors of THE JOURNAL OF HORTICULTURE; the other strives for itself, puts its shoulder to the wheel, and finally and surely thrives. I have known some of these would-be gardeners who had not the remotest idea how to light a fire or attend to it when lighted, and who could not even describe a hotbed. What they like is to take cuttings, sow seeds, and talk a great deal about the depth of their learning. I should consider it a positive disgrace to be everlastingly asking questions of and detailing sorrows to the Editors.

For a garden to look nice and produce well, the owner or one of the family must take an interest in the affairs of the garden, and be ready with praise or blame as it is required. Nothing gives the head gardener so much pleasure as to be told "such a thing was delicious," by the master. Nothing gives a man such a spur as to be told, "Mr. Blank gave us better Grapes than yours." "No eye like the master's." It is not that the men shirk their work, but when the master knows how work should be done the men feel that shuffling will be found out and blame incurred; and, on the other hand, hard work will have its reward in a kindly nod, or, perhaps, something more palpable. This is, however, much too long already. One word to well-meaning amateurs:—Make yourselves thoroughly acquainted with every department of the science, and assuredly all will work well.—**PATELIN.**

[Very glad indeed are we that the majority of the lovers of horticulture are not "PATELINS," for if they were the Editors of this Journal, again quoting Shakspeare appropriately in this time of Shaksperian furor, might truly say, "Othello's occupation's gone." Let no one hesitate from asking a question, because if "PATELIN" knew him or her the said "PATELIN" would cocker over them. "PATELIN" never shall know who asks the questions. We only wish we had this same wholesale critic before us for examination preparatory to his taking his degree as Doctor of Horticulture, wouldn't we puzzle him.]

WORK FOR THE WEEK.

KITCHEN GARDEN.

Nothing gives a more finished appearance to the kitchen garden than clean well-rolled walks with neat edgings. If these edgings are of Box, they require to be regularly clipped during the growing season. Box-edging is, however, at all times a great harbour for slugs and other vermin, and, therefore, the preference is now generally given to edging-tiles, or edgings of slate where they can be conveniently procured. Half bricks are more easily procured, and when laid down thus **AAA** they form a neat edging. Any of these will last for a long time, and if well laid down in the first instance no further trouble is required with them, and they do not exhaust any portion of the soil. *Beet*, watch, and also Carrots, Parsnips, and similar crops, and see that they do not fall a prey to snails and slugs as soon as they appear above ground; for, in consequence of this, it often happens that the crops prove a failure, and the seedsman is blamed for not supplying good seed. If there is any indication of their appearance sow a quantity of soot and lime, mixed together, over the crops attacked: the best time for doing this is either at dusk in the evening or early in the morning. *Brussels Sprouts*, prick-out, and also Cabbages, Broccoli, Celery, &c., as they become large enough to handle. Some of the most forward of the early-sown *Cauliflowers* and *Cabbages* will now be in a fit state for final transplanting, which should be done the first favourable opportunity, and if dry weather prevails let them be well supplied with water. *Dwarf Kidney Beans*, sow full crops, and *Scarlet Runners*, if

not done. *Lettuce*, keep up successional sowings. *Leeks*, transplant from the seed-bed as soon as they are large enough in rows 18 inches apart and 9 inches plant from plant. The soil cannot be too rich. *Peas*, continue to earth-up, and stick; but previous to earthing-up let them be well thinned out if too thick. They are generally sown thickly to insure a crop, but if all come up, and are allowed to stand they will grow, certainly, and bloom, and produce a number of small pods, but after a gathering or two they are exhausted; whereas, if well thinned out, a greater weight of finer *Peas* is gathered, and they will continue to grow and bloom so as to produce a succession. *Parsley*, thin-out; also *Spinach*, *Turnips*, and all other advancing crops. *Potatoes*, where they are above ground, as is now the case with all forward sorts, have the ground between the rows forked up, which will prove of great advantage to the crops.

FLOWER GARDEN.

As there is every appearance of a continuance of fine weather a few of the most hardy kinds of bedding plants might be turned out, such as woody *Calceolarias*, *Salvia fulgens*, *Scarlet Geraniums*, a few *Verbenas*, &c., provided there is a possibility of protecting them from frosts, which sometimes occur early in May. Keep grass lawns neatly cut; roll and sweep walks. Continue to stake plants in borders, and bulbous plants in beds as they advance in growth. Go on thinning-out the annuals sown in the borders; they should never be allowed to smother each other by being left too thick; leave from three to six plants, according to the habit of the plant. Self-sown annuals, *Forget-me-nots*, and other useful little things, with *Pansies*, may be transplanted with balls to fill up blanks. Continue to attend to recently-transplanted evergreens with water, let the soil about their roots be kept moist, but not to saturation, and the plants be watered overhead on the evenings of bright days, which will be of more service in repairing the loss sustained from evaporation than water given in excess to the soil while there is a deficiency of active rootlets to absorb it. Where *Roses* are infested with grub, which is very general this season, it will be necessary to go over the plants frequently to destroy this pest. Green fly is also sometimes troublesome, a good washing with the garden engine on two or three successive evenings will greatly contribute to get rid of these insects.

FRUIT GARDEN.

Persevere also in the destruction of insects in this department, and use every means to prevent the young shoots being injured, for if they sustain any check at the present time they will not soon get over it, consequently the wood will be made late, and unless the autumn should prove favourable it will not be possible to ripen it well.

GREENHOUSE AND CONSERVATORY.

Where hardy shrubs are annually forced to decorate the drawing-room or conservatory, it is not necessary to pot a fresh stock each season, as a number of the deciduous shrubs, as *Roses*, *Lilacs*, *Honeysuckles*, &c., may, by proper treatment, be made to bloom for several successive seasons. Select, therefore, the most suitable plants when removed from the houses, and give them some kind of temporary shelter to gradually harden their foliage. Those cramped for pot-room shift into a larger-sized pot, using rich turfy loam. Towards the middle of the month plunge them in an open situation that the wood may ripen early. These plants, from having been previously forced, will bloom earlier than the new stock, of which a portion each year should be potted to replace such as become useless for further work. Cut down and place in a cold frame the choicest *Cinerarias* for suckers, and put in a stock of *Chrysanthemum* cuttings for autumn display. *Azaleas* as they go out of bloom to have their seed-vessels picked off, and those that require more pot-room to be shifted at once. Strong rich fibry peat with plenty of silver sand is the best compost for these. Any plant affected with red spider or green fly to be laid on its side on a clean mat, giving it a good washing with the syringe. This is preferable to the ordinary syringings, which are apt to render the soil too wet, and in many cases fail to accomplish the desired end.

STOVE.

Let the inmates here have plenty of light, warmth, and moisture, and a moderate circulation of air whenever the

weather will allow, and attend regularly to stopping and training as may be required, and do not allow young stock to suffer for want of pot-room.

PITS AND FRAMES.

Get bedding stock hardened-off as expeditiously as possible, but in removing them from the pits and frames place them where they can be covered at night in case of necessity, and also take care that they are not injured by too sudden exposure to bright sunshine. Be careful that the stock is free from the green fly before removing it from under glass.

W. KEANE.

DOINGS OF THE LAST WEEK.

KITCHEN GARDEN.

WATERED and earthed-up early Cauliflower, using sewage water from the mansion—a new reservoir we dipped into for the first time last season. Gave a little more to Cabbages hearting nicely, also to the later Broccoli, as the sun has been very drying, and the winds parching. Gave also a little to Globe Artichokes, and successions of Cauliflowers. Planted a piece of Dwarf Kidney Beans and Scarlet Runners. Sometimes grub and wireworm attack the seed when swelling freely. To keep them at bay, after the drills were drawn threw a little burnt earth and lime along the rows. Planted the Beans from 2 to 3 inches apart, and then covered over again with a sprinkling of the lime and burnt earth mixture. We find that Peas so treated with a surfacing of coal ashes, were never touched by mice or birds whilst below the ground, and not a seed seemed to be injured by other vermin.

The weather being dry, though much colder, allowed the mowing to stand in abeyance, in order to get the Onions well hoed, the succession crops of Peas well staked, and ground prepared for sowing, to succeed those just peeping through the soil. The sorts staked, or being staked, are Dickson's Favourite, Ne Plus Ultra, Veitch's Perfection, which will come in in turns after Sangster's No. 1, and the latter we hope will succeed three crops of Tom Thumb, from the earliest of which in the orchard-house we are now gathering. For earliness Dillistone's Early is the earliest by some days of any we have met with, but it does not produce like Sangster's, or the old Frames, Warwicks, &c., all of which are earlier than Dickson's Favourite, but the latter is a good Pea, and a wonderful bearer. For some time we have made it the fill-gap between the small early kinds and the fine Marrowfats. After the Perfection, Jeye's Conqueror, Champion of England, Knight's Dwarf, &c., come in, the other kinds are of but little use. The naming of each Pea when sown is useful, even as respects the staking, as it enables us to procure the stakes suitable for each variety. The chief objection to such tall growers as the Conqueror, &c., is the height to which they grow and their liability to be injured by winds. For such, and Ne Plus Ultra, we use the longest sticks well set in, and not close at the top. Even then we frequently have to use poles and strings to keep them up. Could that be thoroughly done, a pair of steps used for gathering them carefully, the ground well manured before sowing, well watered when the Peas were podding, and not a pod left after it was fit for the parlour table, we are convinced that the same row would pretty well last out the season as to gathering. When the plants suffer from drought, and a portion of the pods are allowed to swell and get hard, the haulm soon begins to turn yellow and decay. We are already getting short of ground at liberty, and just managed to clear three or four spaces about a yard wide, by removing rows of Spinach and winter Onions, &c., dunging the space moderately, or rather well, and trenching two spits, and working the manure mostly all through it, so as to offer a good place for the Peas to start in. The intermediate spaces will be dug as the crops are removed. We have long been convinced that the chief causes of mildew in the autumn, were poor, dry, shallow, hungry soils. Abundance of nourishment is the best antidote to the parasite.

Planted a piece of *Asparagus* with small plants of last year's sowing. The ground had been well aired, and somewhat enriched, and the roots of the little plants were spread out on ridges 2 feet apart, well firmed, covered over, leaving the tops out, and a little burnt earth thrown over all. The watering was given before the final covering, so as to leave

the surface open and loose. We turned out also the last of a little bed that was slightly forced, but not enough to injure the crowns. In planting *Asparagus* after it has thus grown 3 inches or so, the great point is never to allow a single fresh fibre to be dried up. Sowed the last of our *Asparagus* seeds. We have still a little *Celery* out of doors, which we will take up to obtain the room. A lot we took up some two or more months ago, and placed close together in a shed, has kept beautifully and crisp, and the Onions are coming nicely on in the ground it occupied.

FRUIT GARDEN.

Regulated *Cherry* shoots on standards, so as to give all the light and air possible to the blossoms, which are very thick on some trees. Hoed and cleared the ground among *Strawberry* plants, leaving a nice open surface to keep drought out and let moisture in. Will throw a little lime over the ground as soon as possible, to scatter slugs, wireworm, &c. Potted a lot more *Strawberries*, as we find we will not have enough to keep up a good supply until they come in from the open air. The plants used had been pricked out in a border some 4 or 5 inches apart in the autumn. We can choose only those with a good truss showing. We cannot spare a frame, or we would have filled one or two with something hot beneath them. We thus prepare these fresh-potted plants for going under glass: We put something like a foot of short grass and leaves into a bed, a layer of 9 inches of leaves over them, and in that plunge the pots. The heat below will in a fortnight fill the pots with roots, and then the heat will be gone, or nearly so. The plants will fruit then wherever placed, provided they do not have too much heat and receive plenty of air. We have one row setting nicely in an orchard-house, from 3 to 4 feet from the front, and the same distance from the roof glass. The bright sun lately was in their favour. Thinned and dis-budded *Peach* trees, also thinned many of the fruit.

Watered *Figs*, and stopped the shoots when stubby; thinned them out when too numerous and weak. The little *Singleton* is a sweet *Fig*, almost as good as the *Marseilles*, but it is a shy bearer as respects the first crop. We believe a good plan would be to dry it pretty well in winter, and prune it well in spring, and start it to make stout fresh wood at once. That stout young wood from well-ripened older wood will generally show from every joint, and a crop will thus be obtained better than by striving with the wood of last year. We cannot say we have ever had anything of the same difficulty with any other *Fig* as this little white one. The *Brown Turkey*, for instance, will yield you a fine first crop, and then give you two or three more if you like to begin soon enough and give heat enough. A gentleman says, "I have some nice *Fig* plants in pots. The first crop always drops—I began early in January. The second crop is getting yellow and falling, so that I fear I shall have none. The pots stand on boards, and are somewhat shaded by *Vines*." To do well *Figs* must have little shade. They will grow fast enough under it, but they will not continue fruitful. This might be one of the causes of the evil, but the standing on the shelf was most likely the more proximate cause. In such days as we had lately a sudden change from moisture to dryness at the roots will shrivel up the young fruit. A sudden change from dryness to extreme moisture will throw off the young fruit. The soil must never be dry, and it must never be marsh wet. Secure the happy medium. With plants in pots you will do so best by adopting one of two modes: Either set the pot in a pan with a little water in the bottom of it, or set the plant in a bed of soil for half the depth of the pot. These will be good preservatives against extremes, and with good light, and a fair proportion of heat and air, there will be little danger of not having a crop. If the roots go a little through the pot into the ground never mind: they will help to swell the fruit all the better; and then in the autumn raising the pot, and cutting off these roots, and watering the pot well, will check and mature the wood growth. These minutiae attended to, good fruit may be obtained from small plants and from small pots—say 8 inches in diameter.

Vines, *Peaches*, *Melons*, &c., much the same as last week. For a couple of nights lately gave no firing. Have been obliged to fire during the day in these dull cold days with northerly and easterly winds. As a matter of economy as well as utility, gave *Vines* in bloom a good heat when the

sun was so brisk ; but even in the case of Muscats we begin, and more than begin, to think that 70° or 75° at night is not absolutely required—at any rate in the case of moderately early Grapes. Where the fruit used to set thickly enough the temperature at night generally ranges from 60° to 65°. When fairly set and swelling 60° has been the average at night.

ORNAMENTAL DEPARTMENT.

Rolled lawn, dug and forked over beds and borders, preparatory to sowing annuals to bloom late. Made up Pink and Carnation-beds, and fresh planted; pointed over Rose-beds; protected Gladiolus a little, made preparations for planting more. Tritonias, Ferrarias, Ixias, &c., should be planted or potted. Amaryllis hybrids when done blooming should be put in a warm pit and encouraged to grow. As soon as possible will fill a stage with Azaleas, where they will be kept more from drip than on the central stage; and will remove the Camellias about done flowering to the vinery, in a little shade. Less moisture will now be required in the conservatory since the change of weather, and a less amount of air so long as the wind continues in the north and east. Potted lots of Euphorbia jacquiniiflora and other winter-flowering things; also, Achimenes, Gesnera zebrina, Caladiums, Begonias, &c., keeping them at present under the shade of the Vines. Potted, also, succession of Fuchsias, and lots of small Geraniums for bedding, &c.

The chief work has been getting bedding plants out under a little protection, pricking out thousands of Lobelias and other small annuals, and putting in a few thousand cuttings of Verbenas, which will be quite late enough; but will, we have no doubt, be nice plants in a month. They were thus done:—A little litter and leaves had been thrown over a Vine-border, on that frames with glass sashes were placed, and underneath them, thanks to the mild heat, several successions of plants have been forwarded a stage. All this makes a little litter, but so long as the use is seen the unsightliness is nothing to us. In fact, for several years we have never been quite passable as to neatness in these matters until June. Well, we removed from these beds some thousands of small bedding Geraniums in pots, and turned them out of the pots into an earth-pit, washed the pots, and filled them with other things; but the space of the beds we reserved for our cuttings. The heat of the bed was about 65°, the fermenting matter we mean, and that was not enough for our purpose, a part was removed, a barrowload of horse-droppings put inside each light, a couple of small barrowloads of hot dung half sweetened, 6 inches of the old leaves above it well trodden, 3 inches of half-rotten leaf mould mixed with lime to kill all worms, and then 3 inches of sandy loam with a little leaf mould rough-riddled; the whole trodden, levelled, covered with less than one-eighth of an inch of sand, beaten firmly with a spade, a flat board laid on for the planter to kneel on, and the cuttings dibbled-in in rows 2 inches apart, and 1½ to 1¼ inch apart in the row. We find some of our lads are betting as to the number of days they will be striking. We say about six, and in three weeks they will be nice, healthy, bushy plants. As the sun threatened to be bright we whitened with a brush the under side of the old sashes, so that the whitening might not be washed off, and this will just give them a nice subdued light. If the sun is very bright we will give a little shade outside for a few hours in the middle of the day; and if the sun is thus bright and hot, we will slightly syringe them several times a-day in preference to much shading. In fact, this skiff from the syringe, and leaving from an eighth to a quarter of an inch of air on at night at the top of the sash, will be the chief care and attention they will require. After considering various pros and cons. as to other modes, we decided that this would occasion the least time and trouble. The plants from which the cuttings were taken had been planted in a bed under glass, and in a few days this glass may be moved to something else more tender. The roughish riddled soil, and the leaf mould beneath causes such struck plants to lift well so as to be planted without suffering from the removal.—R. F.

TRADE CATALOGUES RECEIVED.

John Scott, Merriott Nurseries, Crewkerne.—*Descriptive Catalogue of Bedding Plants.*

B. S. Williams, Paradise and Victoria Nurseries, Holloway.—*Spring Catalogue of New, Choice, and Rare Plants.*
W. Dillistone, Munro Nursery, Sible Hedingham, Essex.—*Catalogue of Choice Plants, Azaleas, Geraniums, Fuchsias, &c.*

COVENT GARDEN MARKET.—APRIL 30.

Both the supply and demand continue good. Pines are more plentiful. English Grapes are sufficient for the demand, but those of foreign growth are nearly over. Though a few dessert Pears are still to be had they are not worth quoting. Dessert Apples may still be obtained. Oranges are becoming rather scarce. New Potatoes from Lisbon and Malta are bringing from 6d. to 8d. per pound. Of Lettuce, &c. from abroad, heavy consignments continue to arrive.

		FRUIT.					
		s.	d.	s.	d.	s.	d.
Apples	1 sieve	2	6	4	0	0	0
Apricots	doz.	0	0	0	0	0	0
Pigs	doz.	0	0	0	0	0	0
Filberts & Nuts	100 lbs.	0	0	0	0	0	0
Grapes, Hothouse	...lb.	8	0	20	0	0	0
Foreign		2	0	1	0	0	0
Muscats		0	0	0	0	0	0
Lemons	100	4	0	10	0	0	0
Melons	each	0	0	0	0	0	0
Nectarines		0	0	0	0	0	0
Oranges	100	8	0	14	0	0	0
Peaches		0	0	0	0	0	0
Pears	doz. bush.	8	0	12	0	0	0
Pine Apples	...lb.	0	0	0	0	0	0
Pomegranates	each	0	0	0	0	0	0
Strawberries	doz.	0	6	1	6	0	0
Walnuts	100	14	0	20	0	0	0

		VEGETABLES.					
		s.	d.	s.	d.	s.	d.
Asparagus	bundle	4	0	8	0	0	0
Beans, Broad	bush.	0	0	0	0	0	0
Kidney	100	2	0	3	0	0	0
Beet, Red	doz.	1	0	1	6	0	0
Broccoli	bundle	0	9	2	0	0	0
Brussels Sprouts	½ sieve	0	0	0	0	0	0
Cabbage	doz.	1	0	1	6	0	0
Capiciums	100	0	0	0	0	0	0
Carrots	bundle	0	6	0	8	0	0
Cauliflower	doz.	4	0	8	0	0	0
Celery	bundle	2	0	3	0	0	0
Cucumbers	each	1	0	2	6	0	0
Endive	score	1	3	2	6	0	0
Fennel	bundle	0	3	0	0	0	0
Garlic and Shallots	lh.	0	8	0	0	0	0
Herbs	bundle	0	3	0	0	0	0
Horseradish	bundle	1	6	4	0	0	0
Leeks	bunch	0	4	0	0	0	0
Lettuce	doz.	1	0	2	0	0	0
Mushrooms	pottle	1	0	2	0	0	0
Must. & Cress, punnet		0	2	0	4	0	0
Onions	doz. bushel	4	0	7	0	0	0
Pickling	quart	0	6	0	8	0	0
Parsley	doz.	2	0	3	6	0	0
Parsnips	doz.	0	9	1	6	0	0
Peas	quart	7	0	10	0	0	0
Potatoes	sack	6	0	9	0	0	0
Radishes doz.	bunches	0	6	0	9	0	0
Turnip		1	0	2	0	0	0
Rhubarb		0	4	1	0	0	0
Savoys	doz.	0	0	0	0	0	0
Sea-kale	basket	1	6	2	6	0	0
Spinach	sieve	2	6	4	0	0	0
Turnips	bunch	0	6	0	8	0	0

TO CORRESPONDENTS.

** We request that no one will write privately to the departmental writers of the "Journal of Horticulture, Cottage Gardener, and Country Gentleman." By so doing they are subjected to unjustifiable trouble and expense. All communications should therefore be addressed solely to *The Editors of the Journal of Horticulture, &c., 171, Fleet Street, London, E.C.*

We also request that correspondents will not mix up on the same sheet questions relating to Gardening and those on Poultry and Bee subjects, if they expect to get them answered promptly and conveniently, but write them on separate communications. Also never to send more than two or three questions at once

MUSCAT HAMBOURGH GRAPES (*J. Palgrave*).—The only way in which you can ever get this splendid Grape in perfection is by grafting it on the Black Hamburgh. We are glad to see, from an advertisement in our present Number, that the nurserymen are alive to this fact, and that Mr. Pearson, of Chilwell, near Nottingham, has already got them for sale.

PLUMS IN GREENHOUSE (*E. M. W.*).—There is just a chance that the Plum trees, being out of doors all the summer and winter until February, did not have their wood sufficiently hardened. The chief reason, however, why the blossoms dropped, whilst those on the Peach tree set well, is no doubt owing to a deficiency of fresh air, and giving too much and too close a heat before the fruit is set. The less confinement, the less artificial heat, before the setting of the fruit, the better will the Plums do, provided the blossoms are kept dry, and frost is excluded. Plums, Cherries, and Apricots will not bear the confined air, nor yet the heat at an early period, which a Peach tree will endure. We have a couple of Plum trees in pots, in the end of a cold house; the fruit set thickly, but a stream of air was allowed to pass over them night and day, unless on a frosty night; whilst the rest of the house was shut up for the Peaches, for the enclosed heat to give them a help on. When the Plums are set they will stand a closer atmosphere, and a little more heat. Anything like forcing should be given them chiefly after the fruit is set, and then an increase of temperature should be given very gradually.

COVERING OF VINE-BORDER; STOPPING—PRIMULAS (*An Amateur*).—We advise you to leave the covering on your Vine-border for another month. We prefer leaving two eyes above the bunch, instead of stopping at the first. If your Vines are very short-jointed, and the foliage thickly set, rub the laterals entirely off. If, on the other hand, the growths are rather long-jointed, and there is room for one leaf on the lateral without crowding the foliage, leave a leaf, but not more. Remove all the old flower-stems from your Primulas, and turn them out of their pots and partially reduce them—that is, remove part of the old soil, repot them in fresh, and grow them on in a cold pit in the same way as you would young plants; and, if you want large plants, give them a shift as soon as they have filled their pots with roots.

SHANKING IN GRAPES (W. B., Reading).—There is no doubt that the disease in your Grapes, which appears to us shanking at an early stage, is caused by your deep, damp, flat, cold border, and the sooner you lift and replant the Vines in a properly constituted border the better. You will find full information as to the proper time and manner of lifting, and reconstructing borders, in back Numbers.

AMARYLLIS FORMOSISSIMA AND VALLOTA PURPUREA, &c. (Clericus).—The former is a true Amaryllis and loses its leaves annually in autumn. It starts into growth in April, and flowers abundantly with the heat of a warm greenhouse, the flower-scape appearing at the same time as the young leaves, and usually carrying two flowers, which are of a rich crimson scarlet. The bulb is medium-sized, with a neck to it similar to an Onion. Vallota purpurea is an evergreen greenhouse bulb, and as such retains its leaves at all seasons. The leaves are stouter, more elongated, the flowers are produced in autumn, more than two from one scape, and are of a lively scarlet, and in these points it differs widely from Amaryllis formosissima. We know of no bulbs easier to manage than the genus Amaryllis, and there is an endless variety of its species. There are Babiana coccinea, B. purpurea, villosa, rubriflora, &c., all greenhouse bulbs; Clivia nobilis, Imantophyllum miniatum, Cyrtanthus of sorts, Brunsvigia, Camassia acantha, Chlidanthus fragrans, Galaxis graminea, Pancratium speciosum, and Eucharis amaranthica. These are a few that strike us at the moment, but we shall have something to say about bulbs generally shortly.

PRIMULAS (Eaton Cliff).—We hope to be able to publish a few notes about them next week.

FERNS (J. Baylis).—Mr. Sims, Foot's Cray, Kent, Nurseryman, will be able, probably, to give you the information you need.

POETRY (Baker Boy).—Your rhymes are not admissible. We would not check any one in his devotion to literature, and recommend you to continue to improve your stores of knowledge, but do not write verses. Rhyme and poetry are not identical.

FORCED STRAWBERRIES FAILING (E. Smith).—The fruit-stalks of your fruit seem to be dried up, and the small fruit scorched; and you say the plants and fruit are also infested with green fly, and you ask the cause. Surely what you have sent is merely some miserable remains, and not anything like a sample. We can hardly conceive how a crop, in bloom in January, should so dwindle down to the third week in April. We should have expected them all to be cleared off, and a fresh lot coming in, in that time; and more especially as the house has been kept about 60°, which is quite enough at night, with, we presume, a good height above that, say 10° to 20°, in the bright sun. The fly is generally the result of a check of some kind. If very bad the fruit-stalks will be shrivelled; and, to do any good, the fly must be smoked, or washed off—not when the plants are infested, but as soon as the fly is seen. They generally show at the bud first, and we have quickly cleared whole rows by going along them with thumb and finger, and then washing with the syringe. Your plants might also have been injured by the bright sun, and from their being placed so close to the glass. If 12 inches, instead of 6, from the glass it would have been better. On the shelves, close to the glass, we noticed signs of burning on some fruit half swelled, during the very bright days we lately had; and as the shelf could not be moved easily, we drew a brush, with thin whitening water, for about a foot over the glass, just to blunt the force of the rays a little, and there was no more burning. The dwindling and drying-up of the fruit-stalk, also its damping, and the berries damping, will sometimes take place if the plants are placed in a still, rather shady portion of the house, where there is a deficiency of fresh air. At this season the plants are safer from 1 to 3 feet from the glass, provided there is no shade over them. We sometimes meet with unreasonable grumblings from people, who say they can obtain Strawberries early from their vinery, but that the next crops are never so plentiful nor good. The first crop is obtained before there is much shade from the Vines; that accumulated shade hurts the succeeding crops. To have both right a part of the house ought to be next to clear of Vines. Read "Doings of the Last Week," and try again.

FLOWER GARDEN PLAN (B. Z.).—You have commenced on the balancing system, and we see no reason why you should not carry it out. 5 and 6 will look very nice, and so will 4 and 7. We are just a little in doubt whether ringing the beds with the Lobelia and the Cerastium would be better than mixing them, or, in your words, dotting the Cerastium with Lobelia Paxtoniana in the one bed, and speciosa in the other. Both will be very nice; but, if the dotting is resorted to, care must be taken that the dotting character is preserved. 3 and 8—centered respectively with Amaranthus melancholicus and Perilla, and filled with Aurea floribunda Calceolaria—will look very nice; but as there is a tendency in the Amaranthus sometimes to seed prematurely, we would use three plants in the centre instead of one. They may be pinched freely. 2 and 9 will also look very well as pairs, the centre of one being Flower of the Day Geranium, and the other Bijou; but, instead of mixing the edgings with Lobelia and variegated Arabis, we think it would be more telling to edge with the Arabis alone, and put Lobelia Paxtoniana in the one bed, and speciosa in the other, between the Arabis and the Geranium. No doubt your proposed plan of mixing will look well, but it will require more trouble, and then, we think, be no improvement on the simpler plan. 1 and 10 will also look very well. 1, Purple King Verbena, dotted with Cineraria maritima, if the Cineraria is the same height as the Verbena. Saponaria calabrica in 10, dotted with variegated Alyssum, will also look moderately well; but a purple Verbena will suit better, as the habit of the beautiful Saponaria is such that it ill brooks a companion or a rival, and, on this account, does not answer well for edgings or centres; and, unless you trim a good deal, the Alyssum will be apt to be smothered; and you must do this very nicely, or the Alyssum will seem to peep through a hole. These beds would be improved by a thin skirting of Cerastium all round. The Saponaria, if in bloom early, will scarcely last beyond September. If sown now it will be a mass of bloom until cut down by frost, if the soil is at all retentive of moisture. It is one of those things that the least cutting and forcing spoils. 11 you propose to fill in the centre with Heliotropes, and we would surround them with a bright scarlet Verbena, of moderate growth. On the border, whatever it is planted with, opposite No. 1, we would plant a patch similar to 11, and thus the balance throughout would be maintained.

PEACHES ON OPEN WALL (Malcontent).—Not knowing where you live, nor any one particular about the condition of the trees, we cannot say what was the cause of their failure. Most probably the young wood was not well ripened last year. Obtaining Peaches from an open wall is a most uncertain event.

PEA RIZZELS (J. W.).—You had better write to Mr. Hawkins. His advertisement offers to send full particulars post free.

BOILER TO HEAT A SMALL FERNERY (An Erotic-Fern Grower).—We should have liked to know what you use the place for—8 feet beneath the Fern-case in which you wish to place your boiler. If there is a fireplace in it generally used, a small boiler at the side or behind it would be the best. If not, and you can take a pipe from the boiler into a chimney, one of the smallest portable ones that have been noticed in our pages, as Riddle's, would suit you, though of course you would lose a good deal of heat in the place where the boiler was fixed. One-inch lead pipes would do very well for taking the heated water for 16 feet to the Fern-case. We think your simplest plan would then be to have a small wooden tank below your case covered with plate iron, and openings left for the heat to get up. If not, we would place two one-inch iron pipes below the earth and two all round above, as it is better to have plenty of piping instead of making pipes over-hot. The lead pipes from the boiler to the case should be placed in a tube of wood, and covered with sawdust to prevent them losing heat. By far the cheapest plan for you would be to have a small tank heated by a lamp below it. A simpler plan still would be to have a wooden base as a tank 3 inches deep covered with iron or zinc, and openings left through the soil to let the heat up, and fill this tank with hot water from the kitchen as wanted. If you cannot find a boiler small enough in a portable, we would have one made of sheet iron, say 18 inches deep, conical, 9 inches wide at bottom inside and 6 at top, secured by a close-fitting lid, and 1½ inch between the inside and outside for the water. Very likely you might heat the case much more easily from the place where you propose. If a kitchen fireplace, a bent pipe in the fireplace would give you enough. Like you, a great many people ask us which is the best boiler. All our practice leads us to say that the best-managed boiler is the best. We can do this conscientiously, after having had a good deal to do with them for the last thirty years. If ever there is a doubt we advise giving the preference to the most simple plan. If we can help you further nothing will give us greater pleasure.

BOOKS (S. H. S.).—There are no such books as you inquire about.

WEEDS ON GRAVEL WALKS (E. C.).—We are averse to using any powerful acids for destroying weeds on gravel walks, and we find nothing more effectual than salt. If the white colour is disagreeable when put on in its crystallised state it may be used as a strong solution either in cold, but better still, in hot water. Our plan is merely to scatter the salt on the walks, not thickly, but just enough to give them a whitish powdering all over, choosing a sunny dry day for the purpose. The longer the salt lies before rain the more effectual will be its action. In the case of walks edged with Box, it is safest to make a slight trench with a hoe, or pick, 9 inches from the Box, and put no salt nearer, but to weed that part. In pleasure grounds we clean the edges of the walks, sweep them hard, throw on the dusting of salt, and cover with a few fresh sittings, and that is all they get, besides rolling, for the season.

APRICOTS FAILING (G. Adams).—We found nothing on the leaves, but there are marks of their being eaten by a small caterpillar that rolls itself in the leaves, and which (especially in the egg state), remains in a dormant state all the winter. You have no remedy except picking and squeezing every part where the leaves are rolled up, and washing with clear lime and sulphur water will help you. Next winter unvail the trees, wash them all thoroughly with soap and water. Lime-wash the wall darkened a little with soot, and then paint the trees with a creamy mixture of soft soap, sulphur, clay, lime, and soot. A boy with nimble fingers would soon go over the trees.

RIBBON-BORDER (Country Curate).—We would change 4 and 5, making 4 Tom Thumb, and 5 Bijou. You may put a Cineraria maritima every tenth plant with the Perilla, but we question if it would be an improvement, especially if you take our recommendation and place Bijou next the Perilla. The distance of the plants from each other, as you say your plants are large: the Perilla and Geranium rows may be 15 to 18 inches apart, and from 12 to 18 inches plant from plant in the rows; the Golden Chain, unless large, should be as close as from 9 to 12 inches apart, the row of Lobelia from it about 12 inches, and the plants 6 to 9 inches from plant to plant. The Cerastium should be so thick as to make a mass—some 6 to 9 inches wide. The Bijou will lighten up the Perilla. The flowers had better be taken off, and perhaps it would be as well to remove the flowers of the Golden Chain.

ORANGE TREE SEEDLINGS (H. A. C.).—The answer we gave at page 304, about the Tangerine seedlings, is applicable to your case.

ZINC LABELS (E. August).—Having two holes is a great improvement, as they keep the label fixed in one position.

NAMES OF PLANTS (D. M. C.).—1, Cladonia coccifera; 2, Bartramia pomiformis; 3, Bryum nutans and Didymodon purpureum, mixed together; 4, Evernia prunastri; 5, an Usnea (?); 6, so imperfect, it is impossible to name. May be the base of Cladonia rangiferina. 7, Hypnum rotundatum; 8, Cladonia rangiferina; 9, too imperfect; 10, Parmelia saxatilis. (H. Enser).—It is the Cornfield Horse-tail, Equisetum arvense, very common, particularly in moist, poor, hungry soils. The Equisetaceae are included in the class of Cryptograms, and, therefore, you would not find this species among flowering plants.

POULTRY, BEE, and HOUSEHOLD CHRONICLE.

POULTRY SHOWS.

MAY 26th and 27th. WOODBRIDGE. Secs., Messrs. Dallenger and Whistock, Market Place.
 JUNE 1st. BRIMLEY. Secs., Mr. H. Adams and Mr. J. Kemp, jun. Entries close May 21st.
 JUNE 2nd. NORTH HANTS (BASINGSTOKE). Sec., Mr. Henry Downs. Entries close May 11th.
 JUNE 13th to 17th, 1864. BATH AND WEST OF ENGLAND, AT BAISTON. Steward, S. Pitman, Esq., Bishops Hall Manor, Taunton. Entries close May 9th.
 JUNE 15th. THORNE. Sec., Mr. Joseph Richardson. Entries close June 4th.
 JULY 14th and 15th. EASTERN COUNTIES. Secs., Messrs. Ranson and Simpson, Stowmarket. Entries close July 1st.

JULY 19th, 20th, and 21st. NEWCASTLE-UPON-TYNE. Secs., Mr. William Trotter, Bywell, and Mr. J. Shorthose, Shieldfield Green, Newcastle-upon-Tyne.

AUGUST 22nd, 23rd, 24th, and 25th. ALEXANDRA PARK. Poultry, Pigeons, and Rabbits. Sec., Mr. William Houghton. Entries close July 16th.

AUGUST 27th. HALIFAX AND CALDER VALE. Sec., Mr. W. Irvine, Holmfield, Ovenden, near Halifax.

TRIMMING GAME COCKS—RELATIVE ENTRIES, &c.

I HAVE purposely been silent for several weeks that I might allow Game-trimming breeders to state their own case; and I must confess to some amount of pleasure when I find that only one person has written openly supporting the practice.

"WESTMORELAND" appeals to me, saying that it is a great improvement! If this is to be our guide, will "WESTMORELAND" deny that it would improve Spanish, eye, and other breeds? Will "WESTMORELAND" deny that some strains scarcely require it? Will you, dear Mr. Editor, either deny this? and if, as I humbly think, you cannot, will you then consider it legitimate to put artificially on a bird a beauty he does not naturally possess to the disadvantage of competitors who do possess it? This, after all, is the honest, straightforward way of looking at the question.

Methinks that "WESTMORELAND," in his brief vindication of the practice, has shown ample reason for its discontinuance when he mentions the instance of an exhibitor at some show, whose trimming propensities led him to believe that that which was legitimate at the upper part of the neck was equally legitimate and as improving at the lower portion.

Dishonest exhibitors (and painted earlobes and painted legs testify to their existence), will never stop at legitimate trimming. For my own part, now that the cock-pit has disappeared, I should prefer, and I think many would, to see Game cocks undubbed.

I will grant that the sight of two Game cocks, or indeed other cocks, preparing for an exchange of incivilities, is a splendid sight; but where is the beauty after the first clash of the combatants? I must confess that I would much sooner that my pets did not fight; nor can I imagine that any bird that had undergone a severe battle, especially if vanquished, would stand much chance as a competitor in the quieter arena of a show until he had moulted again.

I answer only for myself; but in reply to Mr. B. P. Brent, I can only say I do not think Brahmans are Grey Shanghaes, nor should I be disposed to exhibit them in such a class, for I do not think them the same. The Darlington compiler, in quoting Mr. Tegetmeier, does not support the view, for he says they are a mixture, either this or that, that thing or the other thing, and this very doubtful sort of information does not clear up the parentage; whilst, as suggested by "A YORKSHIRE BREEDER OF POULTRY," this applies to other breeds. Brahmans have certainly made way against tolerably strong head-winds; they respond when fairly invited. Then let their parentage alone, as we do with other breeds.

My friend (for being interested in poultry makes him so, although personally unknown), my friend the compiler may hit me as hard as he pleases because I did not show birds good enough to be first. Alas! there can be but one first! I daresay I was fairly beaten. I did not grumble at position—nay, I was content, especially when I noticed the names of those who were behind me. But I maintain that although he covers his retreat like a skilful general, yet that it is a retreat from small prizes to a promise of larger! Well, that was my suggestion, and I am glad to see that it is taken so kindly. If he and I are at issue about the locality of the Bantam exhibitors at Darlington, the catalogue will show who is right. I fancied there were very few from the southern counties.

I must leave the matter of my impartiality in the hands of your readers. I frankly state that the reason why I waded through catalogues, and made calculations, &c., founded on them, was the impression that my pets, Brahmans, were unfairly treated at some of the leading shows, and utterly ignored at many of the minor, that I thought I might assist in altering this by analysing the entries. Has it been "love's labour lost?" I sometimes fancy so, espe-

cially when I look at the pretty blue schedule of the Bath and West of England Meeting; but still I hope on. I plead guilty in this light to being partial to Brahmans, but in the remarks I have appended to each analysis, I plead "not guilty." The best proof of my impartiality must be the fact that I have urged the lessening of the prizes to some breeds that do not enter as they ought, yet in these breeds I have been a successful exhibitor for years.

I may add to "B. P. B.," that the various analyses which I have made do not bear out the proposal he makes, that Spanish require a greater amount of prizes. Any of your readers will see by this table, that in the seven shows which have now been sifted, setting aside Malays and Polands, which are both very far behind, Spanish have absolutely made the lowest returns, Dorkings stand the highest, and Brahmans come second. This is not "partiality," but facts and figures.

It is plain, as I have in each analysis called the best payer No. 1, that when the addition is completed, the lowest amount in the aggregate has been the best returner of entry money to the coffers of the various shows. I leave the facts to speak for themselves.

Breed.	Islington.	Halifax.	Crya. Palace	Birmingham	Darlington.	Manchester	Accrington.	Number aggregate.
1. Dorking.....	1	4	1	1	4	6	4	21
2. Brahma.....	2	3	2	5	6	5	2	25
3. Game.....	6	2	6	4	2	2	6	28
4. (Hamburg).....	8	7	5	3	3	3	1)	30
5. (Cochin).....	5	1	4	2	7	4	7)	30
5. Bantams.....	7	0	3	6	1	7	3	32*
6. Spanish.....	4	5	7	7	5	1	5	34

The figures under each Show represent the position in which each breed stood in the analysis as payers, or rather repayers of prize money, the No. 1 being the highest figure of merit.—Y. B. A. Z.

DISAPPOINTMENTS IN POULTRY-KEEPING.

In the article entitled "Poultry Food" (April 12), one, and perhaps the chief, cause of the disappointments which beset the amateur, and especially the well-off amateur, was pointed out, and discoursed of right properly. Let us hope that fewer cases of the Isaiah Cox description—(Why was he made a parson's servant? Well, we must bear all),—will occur henceforth. But in addition to overfeeding there are two other main causes of disappointment—1st, Not getting the right kind of fowls for the right place; 2nd, Want of attention to age. One poultry-fancier's career shall illustrate both these mistakes.

I had an acquaintance who was fond of fowls, but who was equally fond of his own opinion—one who peep-pooped poultry books, and would not listen to those who knew more of the subject than himself. He resided in a villa, with but a small stable-yard (no horse was in the stable, by the way), in one corner a few dreary-looking weeds which he called grass, a dust-heap in the other; the stable, unfortunately, stood in the centre, casting a black shadow over nearly one half the yard; while on the other side was a pigstye, happily minus pig; hence the fowls' walk was very circumscribed.

One day found him with Game fowls, which he had procured with some trouble, for they were good ones. After properly admiring the birds I added, "I fear, not having a grass run, they will not do well; your yard is also too small for Game fowls. My 'Poultry Book'—I dare not quote my experience—says they cannot be kept in a confined space." "Hang all poultry books and their writers (I winced). Nothing like Game, sir, the true English fowl; best of eggs, best-flavoured pullets." "Granted," said I; "but I fear you will be disappointed." It proved as I had anticipated, the chickens died off, the hens were dull and fat, and did not lay.

Next I found my friend with Hamburgs. He was in good spirits with his new pets. "Mr. So-and-so tells me he never had such layers, and they are first-rate birds; they took the first prize at the show three years ago." "I fear,"

* Add average for Halifax—viz., 5.

said I, "your premises will not suit Hamburgs. Mr. So-and-so has a large paddock; and, indeed, your hens are too old, I doubt if you will get an egg (it was November) until the middle of next March." Again I was a true prophet; but, Cassandra-like, was not believed in until too late. Week after week no eggs, and then Hamburg shared the fate of the Game, and money was lost by both.

Now, in such circumstances, the only kinds of fowls to be kept up without disappointment were Spanish or Cochins. Should not these three cases of trouble be remembered—food, not too much; sort, adapted to the size of the yard, grass run, &c.; and age, none being kept longer than two years?—**WILTSHIRE RECTOR.**

EGG WITHIN EGG—HEN INCUBATING ON HER BACK.

SOME time back one of my Cochin hens laid an egg of extraordinary size. I pierced a hole at each end, and blew out the yolk, and, much to my surprise, I found there was another perfect egg inside the shell, hard, and as perfect as if the egg had been separately laid. I have made many inquiries as to whether so extraordinary a circumstance can be accounted for, but have not been able to meet with any satisfactory solution of the question. Can you help me in giving me some explanation of a circumstance which seems to me contrary to the laws of nature, as I have always supposed the action of the air was necessary to harden the shell of an egg? The hen, after laying this extraordinary egg, was irregular in her laying, and the eggs were generally soft.

I shall also feel obliged by your informing me if you have ever met with an instance of a hen sitting on her back. I found one of my Cochin pullets, a few days before hatching, upon her back, with her legs in the air, as I thought killed by a dog. I removed the hen to her proper position, and found that she had placed herself into this position, as I suppose, either for greater heat, or to prevent her legs from injuring the eggs.—**AN INQUIRER.**

[Save in the case noted above and in that of "NORTH BRITON," we have never met with such an egg as you mention, and it is more than curious we should hear of two in a week. We cannot explain it.

The hen sitting on her back was in a fit, or suffering in the brain. We have known such things often. If she were taken from her eggs and turned out, it would be seen she rolled her head about, and, after staggering, she would settle down on her back.]

ARTIFICIAL SWARMS.

(Concluded from page 323.)

It may be objected that the mode of making artificial swarms which I have described produces only one swarm from two hives, whilst the natural rate of increase is much more rapid, seeing that two swarms at least are usually anticipated from every strong stock. Putting aside the contingency, which, however, but too frequently occurs, in which the bee-keeper is kept on the tenter-hooks of expectation and unavailing watchfulness for weeks and even months together, whilst enormous masses of bees hang in enforced idleness under the floor-boards of their hives, into which at last they gradually retreat at the approach of winter—setting this aside, therefore, and saying nothing of the numerous instances in which swarms either altogether baffle the vigilance of their owner, or ultimately escape after leading him a long and weary chase, I think we shall find this mode of operating admits of a more rapid rate of increase than at first sight appears, and that it may even in this respect bear comparison with natural swarming, whilst it far surpasses the latter in respect to certainty and the strength and consequent value of the resulting swarms. In the first place, no time is lost in waiting and anxious expectation. As soon as a couple of stocks are ready they may be operated on; and the one which is merely removed from its position will so speedily recover the injury, that it may, as I have already stated, soon be again made use of in a

similar manner, or a swarm may be forced from it by the aid of another stock. It must not be forgotten, also, that such powerful swarms formed early in the season, become at the end of a few weeks themselves capable of contributing their share in similar operations, so that if it be desired merely to multiply the number of stocks in an apiary, that end may be effected by the means I have pointed out, as rapidly as, and with far more certainty than, by natural swarming.

When the apiarian has the advantage of either bars or frames, there is, however, another mode of proceeding which is, I believe, entirely my own, and by means of which I have been very successful in the formation of artificial swarms, whilst it has the advantage, if it be deemed such, of requiring only one strong stock to carry it into effect. As before stated, the forenoon of a fine day when the bees are in full work is the most favourable time for the operation, which should be performed upon the strongest stock in the apiary.* It should be commenced by slightly raising the crown-board and puffing a little smoke under it, when it must be replaced, and the hive moved a little to the right or left of its usual position, which should be occupied by an empty hive from which the crown-board and comb-bars or frames have been removed. The crown-board of the full hive may then be taken off and a side-comb carefully lifted out, after its attachments have been severed from the back and front of the hive by a bent knife.† Both sides of the comb must be rigidly scrutinised, and any cluster of bees gently dispersed with a feather until it becomes evident that the queen is not present, when it should be placed in the empty hive. The same process must be repeated with each successive comb until the queen be discovered, when the comb on which her majesty is found must be placed in an empty hive‡ (if a few clean worker-combs be added so much the better), and this new hive containing the queen should at once occupy the place of the old stock. The remaining combs in this latter having been brought together so as to leave the vacancy on one side,§ it should be shut up in a dark and cool place (due provision being made for sufficient ventilation) until dusk in the evening of the following day, when it may be placed in the new position which it is intended permanently to occupy. If other hives are to be operated on, it should be done eight or nine days after the first. By this time the bees remaining in the old stock will have formed a number of royal cells. Leaving two or three to insure the production of a young queen, as many of the others may be cut out as will supply the hives now to be deprived of their sovereigns with a couple of royal cells for each, and these will have the advantage of producing queens eight or nine days earlier than would otherwise be the case, thus reducing the interregnum to about a week or even less. If queen cells are sufficiently numerous, their introduction may be effected by simply exchanging a brood-comb in each hive; if they have to be cut out, a triangular bit of comb with the apex downwards should be removed with them, and inserted in a similarly-shaped hole cut in the centre of one of the combs of the hive into which they are to be introduced. As before stated, the greatest care is necessary to avoid bruising the royal embryos, and the operation should be effected as rapidly as possible in the middle of a warm day, as the slightest chill may prove fatal. For the same reason, the centre of one of the middle combs is a better position for royal cells than the allowing them to remain on the edges of the combs, where they are usually placed by the bees.

Nearly the same result may be attained with a very strong stock in a common straw hive, by driving the whole of the bees with their queen into an empty hive during the middle of a fine day when they are in full activity, and conveying them at once to a distance of not less than a mile and a half. Their absence need only be temporary, as they may be brought back to a new position in their old apiary about three weeks afterwards. The bees which have re-

* The use of a bee-dress and stout gloves (those made of india-rubber for the use of photographers are the best), is of course advisable.

† This knife is not required when operating on frame-hives.

‡ This comb should be carefully examined in order to ascertain that no royal cells are attached to it. It may be found, the queen must be transferred to another comb, and the royal embryos returned to the hive.

§ This side vacancy should always, if possible, be filled up with a spare worker-comb.

turned to the parent stock will in the meantime have raised another queen, and all will proceed as if a swarm had issued naturally. Supernumerary royal cells may, of course, be utilised by the exercise of a little ingenuity in the manner described in page 323.

I feel assured that much which I have written is already well known to so experienced an apiarian as "PHILISCUS." I have, however, thought it better, for the sake of those who may not be so well informed, to enter pretty fully into the subject, by describing what appear to me to be the best modes of forming artificial swarms. I hope others among the able contributors to THE JOURNAL OF HORTICULTURE, will favour us with the results of their experience in this interesting and important branch of apiarian science, in which case I feel assured that "PHILISCUS" will have every reason to be satisfied with the information elicited by his inquiry.—A DEVONSHIRE BEE-KEEPER.

ARTIFICIAL COMBS.

WOULD some of your correspondents give me, through your Journal, the results of their experience of the impressed waxen sheets for combs? Bee books tell us a hive usually contains about 1 lb. of wax, and that 1 lb. of wax is not made from less than 20 lbs. of honey. According to this calculation, if we supply the wax the bees should give us 20 lbs. more honey—perhaps rather too much to expect. But if any apiarians have used the impressed sheets on a large scale it would be interesting to know what apparent gain they have had in weight of honey. Would you also inform me if it ever fails through the bees refusing to work on it? Ten days ago the bees were working very much on the box trees; does this shrub or the berberry yield much honey?—A YOUNG APIARIAN.

[Our experience in the use of artificial combs amounts to this—that bees when disposed to work in wax will form them into perfect combs, whilst at other times they neglect them altogether, but we are quite unable to state what amount of saving is effected by their use. Perhaps some of our correspondents may be able to give the required information, and, at the same time, reply to the query respecting the honey-yielding properties of the box and berberry.]

CHILLED BROOD AND WAX-MOTH LARVÆ EXPELLED BY BEES.

DURING the last week or ten days two of my old stocks, one eight or ten years old, the other five or six, have been very busy throwing out young bees of all ages, varying from a perfectly-formed bee to a grub. The young bees are perfectly white and appear to have been dead some time; the maggots are in part dead, but some are alive, and all appear to me to be immensely large, some being as much as an inch or more in length. The oldest stock throws out the most. They are both very strong, weighing 38 lbs. and 34 lbs. respectively, and work well in pollen and honey, the neighbouring country being one mass of bloom with furze and fruit trees, and abounding with large commons and woods. Can any of your readers inform me the reason, and if anything can be done, as I am fearful of losing them? I have several other younger stocks all doing remarkably well, and have not seen a single dead young bee thrown out from them yet. I cannot find a similar instance mentioned in "Bevan," or any other work on bees. I have enclosed three specimens which were thrown out this morning with about forty others from one hive.—F. W.

[Of the three specimens which you enclose two are young bees in different stages of development, which have probably been chilled by some sudden fall in temperature, whilst the third is a living caterpillar of the wax-moth. If this latter pest cannot be got rid of owing to the combs being fixtures, it will be well to permit the stocks to swarm this summer and "take" them at the end of the season, when their inhabitants may be expelled by driving and added to their own swarms, which should for this purpose be placed in close proximity to their parent stocks.]

PLACING A SWARM WHERE THE PARENT STOCK WAS.—Some years ago I tried this experiment, but it did not come up to my expectation, as the old stock was thrown back at least a month or six weeks; but if the old stock were removed as far as a mile on the day of swarming, I make no doubt it would always answer the purpose very well, and with extremely populous hives would do pretty well with a near removal.—H. W. NEWMAN, Hillside, Cheltenham.

MAKING SUPERPHOSPHATE.—I procure the bones at from 50 to 80 cents per 100 lbs., throw them into a hogshead sunk one-half its depth in the ground (or, what is much more convenient, into a tight strong trough, somewhat similar to those formerly used for holding pomace when making cider), pour over them ten gallons of water, then empty one carboy Chamber's best sulphuric acid; and in that proportion increase until the bones are all covered. As they dissolve and sink down, add more bones, until the whole becomes a thick pasty mass, which it will in the course of two or three weeks. Care must be taken to keep it covered tightly, and avoid letting the acid touch any part of the clothing, as it will certainly leave its mark. When wanted for use, have ready alongside of the tub a bed of fine mould, dry muck, or plaster, into which shovel or ladle the mass, turn over and mix until sufficiently dry to handle pleasantly. Poultry-dung and plaster are valuable additions. The result, from applications of phosphate so manufactured, has always been highly satisfactory; one application to a field of rye was remarkable in its effects. I have sometimes broken or chopped the bones up with an old axe or hatchet.—WM. P. TOWNSEND.

OUR LETTER BOX.

GAPES (E. M. W.).—This disease is really the result of small worms in the windpipe. Shutting the chickens up in a box filled with the smoke of tobacco, or the vapour of spirit of turpentine, is said to kill the worms. Day's Game Paste is also said to kill them.

BUFF-COLOURED BANTAMS.—G. Manning, Esq., Chapel House, Springfield, Essex, would like to communicate with "Spring Cuckee" about this variety.

INDIAN CORN (J. R.).—It is too fattening a food for hens. Over-fatness is the cause of more irregularities and diseases connected with the production of eggs than any other. The summer months are those in which chickens are the most easily raised; but for profit the earlier in the year the better.

VARIOUS (North Briton).—There is no reason why we should not know more about eggs, and we should if all would communicate their experiences as you have done. The two eggs in one day are, in fact, two eggs in forty-eight hours. The laying sixteen in eight days is a thing we have never met with, and unnatural. We should doubt their being perfect eggs, and should rather expect to find them half-shelled abortions. The egg within an egg is a remarkable fact. Purge your cock with castor oil, a table-spoonful; and then give stimulants as strong beer and such like. If he is wasting, and you wish to show him in high condition, give him raw yolk of new-laid eggs. Hens seldom give over laying except from extreme old age—they then get very fat. If that is her case it is hopeless, and we should not advise you to keep a bird that had not laid for a year.

BOOK ON PIGEONS (A Yorkshireman).—"The Pigeon Book," by E. P. Brent will suit you. You can have it free by post from our office for twenty postage stamps. The charge for advertisements in this Journal is five lines (about sixty words) 3s. 6d., and 6d. for every additional line.

TRANSFERING BEES (A Subscriber, Royston).—Better let the stock swarm, and expel the remaining bees by driving, and unite them to one of the swarms, either at the end of the season or three weeks after the issue of the first swarms.

TEACHING CANARIES (A Bird Fancier).—The kind of bird employed to teach Canaries to sing depends upon the song of the bird that the fancier wishes the Canary to learn. Either the Skylark or the Nightingale, or a good singing Canary is used, and the bird shut up with the one that has the particular song required, out of hearing of any other. The Skylark builds on the ground, and the Nightingale also, and generally at the foot of a thick bush. The former lays a greenish white egg spotted with brown; and the Nightingale an olive brown egg.

LONDON MARKETS.—MAY 2.

POULTRY.

Good Poultry is very scarce, and prices are maintained.

	s. d.	s. d.		s. d.	s. d.
Fowls	4	0	to	4	6
Smaller do.	3	6	,	4	0
Chickens	2	6	,	3	0
Goslings	7	0	,	7	6
Ducklings	3	6	,	4	0
Pheasants	0	0	,	0	0
Guinea Fowls.....	3	0	,	3	6
Rabbits	1	4	,	1	5
Wild do.	0	8	,	0	9
Pigeons	0	8	,	0	9

WEEKLY CALENDAR.

Day of M th	Day of Week.	MAY 10-16, 1864.	Average Temperature near London.			Rain in last 37 years.	Sun Rises.	Sun Sets.	Moon Rises.	Moon Sets.	Moon's Age.	Clock after Sun.	Day of Year.
			Day.	Night.	Mean.		m. h.	m. h.	m. h.	m. h.	m. s.		
10	TU	Persian Lilac flowers.	61.9	40.0	50.4	16	17 4	35 7	59 7	37 11	4	m. s.	131
11	W	Partridge lays. Walnut flowers.	62.4	40.5	51.4	15	16 4	37 7	59 8	morn.	5	3 49	132
12	TH	Lily flowers.	63.4	41.1	52.2	17	14 4	38 7	4 10	8 0	6	3 51	133
13	F	Meadow Foxtail flowers.	63.6	38.9	51.2	17	12 4	40 7	8 11	33 0	7	3 52	134
14	S	Sweet-scented Vernal Grass flowers	63.4	40.7	52.0	14	11 4	41 7	after.	35 0	8	3 52	135
15	SUN	WHIT-SUNDAY.	64.8	41.1	52.9	13	10 4	43 7	15 1	17 1	9	3 52	136
16	M	WHIT-MONDAY.	66.1	43.1	54.1	14	8 4	44 7	20 2	38 1	10	3 51	137

From observations taken near London during the last thirty-seven years, the average day temperature of the week is 63.6°, and its night temperature 40.8°. The greatest heat was 86°, on the 15th and 17th, 1833; and the lowest cold, 25°, on the 15th, 1850. The greatest fall of rain was 1.14 inch.

CULTIVATION OF THE PINE APPLE.

(Continued from page 292.)

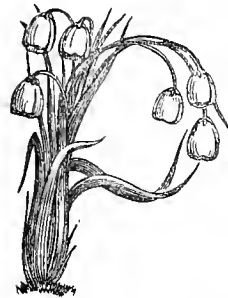

RESUMING that the autumn-potted suckers, treated of in my last paper, are found to be in a proper condition for shifting by the end of February or the beginning of March, all should be held in readiness for shifting them into their fruiting-pots the first mild day that occurs after that time. What I mean by plants in a proper condition for shifting may be described as those which have pretty well

filled their pots with roots in a white and healthy state of preservation. Pines should not be shifted till roots have formed themselves round the sides of the pot sufficient to keep the ball of soil together. On the other hand, they should not be anything like pot-bound. If the former condition is not arrived at by the time I have named for shifting, the operation should be deferred and the plants gently excited into root-action till the desired condition at the root be attained. If the latter condition be the case, as it not unfrequently happens with strong suckers that have been potted in small pots, then the balls should be partially broken up with the hand; for a hard-matted ball seldom starts away very freely into growth when potted into a larger-sized pot without being partially broken up. I, however, prefer keeping a watchful eye on all young stock, and shift them at all seasons, winter or summer, before they do become thus matted in small pots.

About a week before the shifting is performed the plants should be looked over, and all those that are anything like mealy-dry should be watered, so that at shifting-time the soil may be in a healthy state as to moisture. If shifted with the balls dry it is most difficult to moisten these afterwards, and, as a consequence, the young plants are likely to start prematurely into fruit.

The house or pit intended for the reception of the plants after they are potted should be thoroughly cleaned. The glass and woodwork should be all washed, and the walls whitewashed, so that there may be all the admission and diffusion of light possible, which for a stocky and fruitful growth early in the season is one of the most important conditions in the cultivation of the Pine Apple. In the case of those who are dependant on fermenting material for bottom heat, all that may be necessary in relation to that will be to fork into the surface of the bed a little fresh tan, well mixing it with that which was put on the previous autumn; but should the leaves have been several years in the pit, and the heat much declined, it will then be necessary either to take out the tan, and mix in fresh leaves, or to add a greater proportion to the tan without interfering with the leaves at all. There is no operation connected with the growth of the Pine Apple that I dread more than renewing the leaves in

Pine-pits; and rather than run the risk of sudden and violent fits of bottom heat I very seldom interfere with the bed of leaves at all, and find the slight addition of fresh tan twice a-year quite sufficient for the required amount of heat. All this labour will not be required in cases where the heat is supplied by a well-regulated system of hot-water pipes, and in that respect the labour connected with the shifting and arranging of Pines in spring is much lessened and simplified.

The other preliminaries of getting the necessary amount of soil prepared, and placed in some place to warm it, and the pots crocked and ranged in convenient readiness, being seen to, there will be less hurry and confusion in taking advantage of the first mild day for shifting and arranging the stock of plants that require such. In draining the pots it should be borne in mind that the plants are to remain in them till they have perfected their crops of fruit and of healthy young suckers for another season's stock, and the drainage should be efficiently performed. I much prefer crocks that are broken to a small size, with, of course, all dusty matter sifted out of them, to those of a larger size. Over the crocks a thin layer of moss should be placed, and over all a sprinkling of fresh soot, which prevents the destructive inroads of worms.

The suckers having been potted in autumn into six and eight-inch pots, and supposing that we are now treating of Queens that are not required to fruit till very early in the following year, to supply ripe fruit in May and June, some eighteen months after they are taken from the parent plant, I prefer shifting them into their fruiting-pots at once instead of giving them two small shifts. The strongest plants in eight-inch pots are shifted into twelve-inch ones, and those in six-inch pots into eleven-inch pots, and these sizes are quite sufficient for the production of the very finest Queens; and, what is of vast importance to those who have a regular supply of fruit to keep up from a limited amount of accommodation, it is well known Pine plants thus potted are much more manageable in the way of getting them to start than when grown on the old-fashioned large-pot system. From this it will be observed that one shift is all that is recommended as necessary in the progress of the Pine from its sucker state to its yielding and ripening the fruit.

Before turning the plants out of their pots a few of the short sucker leaves round their collars should be stripped off. When turned out of their pots all inert soil on the upper side of the ball should be removed with the hand, and the crocks, of course, taken from the bottom part. The ball should then have a gentle rap or two with the hand, and the roots be disentangled as much as possible without breaking up the ball. This is the treatment that should be followed in the case of plants that are in a thoroughly satisfactory condition, having fine, healthy, white roots with a moderately-matted ball, and the soil in a sweet healthy state. When the soil is inclined to be either overdry or soured it is best to shake out the plants either entirely or more freely than I have recommended. The pots should be filled firmly up with

soil, so that the plants when placed in them may be 2 or 3 inches deeper in the soil than they were before. Being an advocate for potting most things firmly, and especially Pines, the soil should be rammed firmly round the ball. Be it remembered, however, that the soil which has been recommended is not a damp mixture of heavy loam and the excrement of, perhaps, two or three different animals, but a light turfy loam, through which water passes freely, and the more firmly it is put into the pots the less water it holds; and this is just what is of great importance in the growth of a succulent plant like the Pine. I never remember to have seen really healthy Pines or fine fruit from a rich putted soil holding much water in suspension about the roots.

When the whole are shifted they should be plunged in their growing quarters at once; and should there for the time being be a scarcity of room for the desired number, with the prospect of more room in the course of a few weeks by getting rid of others that may be fruiting off, they may be plunged rather thicker than is proper for them to make their summer's growth; but if at once they can have all the space that is required all the better, for there is nothing more to be deprecated in Pine-growing than the overcrowding system. Two feet from centre to centre is little enough for Queens to grow them into fine sturdy plants.

Particular attention must now be paid to the bottom heat. From 85° to 90° should not be exceeded. Should it rise above 90° where the heat is derived from tan and leaves the pots should be shaken from side to side, so as to leave an opening round the sides of the pot for the heat to escape by. Although there may not be absolute danger of burning the roots while they have not reached the sides of the pot, yet too much bottom heat causes an over-rapid growth at so early a season, which, in the absence of sunshine and longer days, is exceedingly undesirable. During the month of March the atmospheric heat should, during cold weather, range from 60° to 65° at night. For a few days after having been shifted they should be kept rather close, and the atmosphere moist till they begin to lay hold of the fresh soil; then air should be admitted on fine days when the heat rises to 70°. There should be no attempt at immediate growth at anything like a rapid pace. The plants will root quickly and freely into the fresh soil from the increased bottom heat and the healthy irritable state of the roots, if they have been wintered properly, without much perceptible top growth for some time. There will be no necessity for water at the root for some time—not, certainly, till the early part or middle of April, and even then water should not be over-liberally supplied. The experienced can tell by the very appearance of the plants when they require water, and the inexperienced should examine the soil occasionally, and apply water when it becomes dry for a few inches from the surface of the ball. At this stage it is, however, much safer to err on the side of withholding water than to keep the soil too wet while it is not occupied with roots. The perspiratory organs of the Pine Apple are not very active at any season, and as the plant partakes so much of a succulent nature a moist atmosphere will be a much safer way of preventing injury from drought early in the season than applying much water at the root.

We often find in the case of those who have had next to no experience in Pine cultivation that young Pines after they are shifted are kept sloppy and wet: I have taken the soil out of the pots and squeezed the water out of it. There is no more fatal course to pursue at any stage of their growth, and more particularly when newly shifted. It not infrequently happens that suckers after being shifted start prematurely into growth. This evil may proceed from many causes, but the most common cause is allowing them to become potbound and dry before being shifted, in conjunction with too high a temperature. It takes a nicely-balanced combination of circumstances to grow really fine, healthy, and at the same time fruitful, plants; and however excellent the principal arrangement for Pine cultivation may be, the evils referred to must be carefully avoided, or disappointment will be the result.

D. THOMSON.

(To be continued.)

present the gardener at Syon House. This, probably, for some time will occasion trifling mistakes, and we have not lessened that probability by calling the present *John Smith Alexander Smith* in our Journal of April 26th: whereas *Alexander* is his son. Mr. Smith, in consequence of his eyesight having become so much impaired through overwork and the study of plants required by the duties of his situation, some time ago asked to be relieved of the active duties of his curatorship; and the Lords of the Treasury, acting upon the strong recommendation of Sir W. Hooker and the First Commissioner of Works (Mr. Cowper), have recently granted him a handsome and satisfactory retiring allowance. He was induced to take this course both in consideration of the interests of the Garden and in deference to the advice of Mr. Bowman, the celebrated surgeon and oculist, who, about two years and a half ago, performed a successful operation, which has had the anticipated effect of, in a great measure, arresting the disease. Heartily do we hope that Mr. Smith may long be spared to enjoy his well-earned pension, and the society of those with whom he has so long co-operated. For this purpose no better dwelling-place could be found than Kew, where he has already resided for more than forty years, and where he would have the freest opportunity of witnessing the progress of the Gardens under his able successor.

CULTURE OF THE CELOSIA OR COCKSCOMB FAMILY.

OUR forefathers were noted for growing Cockscombs of extraordinary size, and if we can place any reliance on the descriptions given of these, we need not be surprised at people sneering at the paltry specimens now seen on exhibition-tables. What should we think of a Cockscomb 2 feet across now-a-days? It is not possible to find them so large now; but whether we have come down from the large coarse flower, and brought our plants to such a state of perfection as to warrant our terming them fine-bred, I leave it for others to determine. Certain it is, however, that well-grown Cockscombs are not so generally seen as they ought to be, for a few such plants are not despicable objects even amongst a choice collection.

Various offensive substances have been recommended by old gardeners as essential for the successful cultivation of these plants; but since the adoption of the present system of supplying nutriment to a plant in a liquid state, according to its necessities, the old practice has been exploded, and bullock's blood, sugar seum, night soil, and a host of other matters, have long fallen into disuse. I am no advocate for applying strong food to plants, and, consequently, I am not about to recommend any compost containing such ingredients as the above. On the contrary, I recommend a compost which is the most suitable and useful of all things that come to the potting-bench. It is turfy loam, from turves 2 inches thick, taken from an old pasture in good heart, and which have lain in a heap for a twelvemonth in an open situation, and been frequently turned over so as to be sweet and mellow. A gardener with a good heap of this compost will always feel equal to any task, and the smile on his face will tell that he is not beholden to road surveyors for his supply of rotted turf. This is all we want for the roots of *Celosias* of all kinds to ramify in.

Let the seeds be sown thinly in April, in pots filled with the finer particles of the compost—those which pass through a half-inch riddle, and cover them lightly with fine soil. After sowing place the pots in a Cucumber-frame, and keep the soil moist by gently watering with water of the same temperature as the frame until the plants appear. This should range from 65° to 70° at night. When the plants are up bring the pots as near the glass as it is possible to do without interfering with the moving up and down of the lights; the plants cannot be too near the glass so long as they do not actually touch it. Air must be admitted freely so that they may grow strong, and they should never be allowed to flag for want of water. When of sufficient strength to be handled, they should be potted singly into 60-sized pots in the same compost as before, placed in the frame near the glass, and be shaded for a few days until established in the pots. If due regard be paid to bedewing

ME. JOHN SMITH, Curator of the Royal Botanic Garden, Kew, is about to have as his successor Mr. John Smith, at

the plants overhead before closing the frame, and if kept duly supplied with water, the pots will soon be full of roots; and when these become well matted round the inside of the pot, the plants should be transferred into 32's, employing the compost rather rougher than for the first potting, and placing the plant three-quarters of an inch deeper in the new pot than in the old. This will cover the stem to the extent of three-quarters of an inch, and from this portion fresh roots will be emitted. The plants must still be kept near the glass, and have abundance of air daily, a moist atmosphere, a gentle sprinkling of water overhead every day, and a moderate supply of water at the roots. The temperature should be 60° to 65° by night, with a rise of from 20° to 25° by day, with sun and abundance of air; but a day temperature of 70° to 75° in dull weather is more suitable, for a high temperature in dull weather only causes lanky growth, whereas we are seeking to obtain a strong, sturdy, well-matured development, from the appearance of the plant above the soil to the time of its showing for bloom.

By the time the pots are filled with roots the embryo flower will have been formed, and if all be right the plants will have some goodly-sized leaves supported by a stout, round, not flat stem, not more than 6 inches high. All that do not come up to this had better be sent to the rubbish-heap for they are worthless; though they give a large head of bloom, yet they will be leggy, and leggy Cockscombs are certainly ugly and coarse. Flat-stemmed Cockscombs are almost certain to give a double, divided, or open and unequal comb, and for this reason I advise their being discarded at once. Having selected a number of the plants that appear least disposed to be leggy, with fine foliage, and crowns apparently evenly balanced, with the crown higher in the centre of the flower, and not with flat tops, for these invariably give "pointed" flowers, let them be potted in nine-inch pots, using efficient drainage and the compost in a rough state, simply chopping it with the spade. In potting, the plants should be brought as low in the pot as possible, so that the stems may be covered a few inches with the compost; the lowest leaves on the stem being removed a few days prior to potting, so that the wounds may be healed over by the time the plants are potted, for if leaves are removed at potting the moisture of the soil not infrequently causes the stems to rot.

After potting the plants are placed near the glass in a Cucumber-frame for a fortnight until the pots become filled with roots, when they are removed to a frame or pit with a temperature of not less than 60° at night, and 75° by day, with a rise of 10° or 15° with sun and air. The grand point now is, to allow the plants light on all sides, close proximity to the glass, a moist but not stagnant atmosphere, and to feed them slowly by judicious applications of manure water. Those having the convenience of stoves with shelves near the glass will have no difficulty in growing Cockscombs, or a number of Cucumber or Melon-beds in succession will answer well; but in whatever place they may be the pots should be turned round frequently, so that all sides may be, each in its turn, presented to the greatest light in order to keep the head evenly balanced and straight on its stem. Sprinkling the plants overhead with water through a fine rose at shutting-up, which should be done early to utilise as much sun heat as possible, and admitting air early so that the plants may not run to stem and leaf by a close confined atmosphere, are essential to their growth. Endeavour in every way to obtain a slow, well-fed development, for all we want now with the stem and leaves is, the former to act as a channel for the food, and the latter to properly assimilate the food so that it may extend the size of the flower-head. Liquid manure at a temperature of 90° should be given to the plants at every alternate watering; it should be weak and made from cool manure, as that of cows or sheep. Soot and sheep-droppings in equal quantities, dissolved or mixed with six times their volume of rain water, make an excellent liquid manure of the right strength for Cockscombs, Balsams, and all plants requiring high feeding. It should not, however, be given in too powerful doses at first, but it is preferable to commence with the liquid at half the above strength, and gradually increase to the full strength in the course of a fortnight. Pursuing this treatment we have now to consider when to leave off applying the liquid, and this is when the seed is fully formed, for the head is then as

large as it can be made, and the plants will retain their beauty much longer if afterwards watered with soft water alone, and removed to a greenhouse or conservatory when in bloom.

It sometimes happens that the plants show bloom from the axils of the leaves on the stem. These blooms should be removed as they present themselves, for they only rob the head and render the crown less ornamental. Occasionally feathery-like substances rise from the base of the flower, and these with the feathery down-like inflorescence should be taken off close with a pair of scissors, for though they are the only agents necessary to the propagation of the kind, yet they are bad points in a Cockscomb, and contribute to the decrease of the head; whereas their removal, on the other hand, increases it. In my opinion a Cockscomb should have a round stem, and this conspicuous above the soil, the foliage sufficient to show off the comb to advantage and set evenly on both sides, the comb curving downwards from the centre equally on both sides, and describing the part of a circle equal to the height of the plant above the pot. It should, further, be of an equal width, free from irregularities and partings in the comb, and the points of the comb curving inwards towards the stem of the plant. Suppose a plant to be 1 foot high from the pot to the top of the comb, the latter should present its extremities at equal distances above the pot at opposite points, having precisely the same appearance as the moon at the first quarter, describing exactly the half of a circle. The colour of the flower is immaterial, only it must be bright and decidedly pure. Such I believe to be perfection in Cockscombs; but there are some persons who object to them because of their extremely stiff, formal character, and for such nothing is more likely to please than the elegant and graceful pyramidal form of *Celosia pyramidalis*. This is, indeed, a charming plant for decorating the greenhouse, for vases in the drawing-room, placing on dinner-tables, and for making bouquets in autumn and winter.

Celosia pyramidalis, and its varieties, are some of the most useful plants we have, and they do not require so much heat as a Cockscomb. Any one with a Cucumber or hotbed-frame of sufficient heat to get the plants established in pots will have no difficulty in growing them perfectly, if a greenhouse in addition be at command. The seed should be sown in April, but May is not too late, in light, loamy soil, and be placed in a gentle heat. When the plants are up they must be placed near the glass, be kept duly supplied with water, and have air on all favourable occasions. It is essential to pot the plants singly in small pots immediately they are large enough to handle, employing the same compost as that recommended for Cockscombs, with the addition of one-fourth leaf soil. Replace in the frame, and shade them for a few days until well established, and be cautious not to allow them to suffer for want of water, otherwise they not infrequently become stunted in habit, and there is no hope of obtaining a fine head of bloom from plants that do not show a stiff, strong, healthy foundation. The plants should be kept near the glass, and if the temperature be 55° by night (not lower), and 75° to 85° by day, with abundant ventilation, that is quite sufficient heat for them. They will need potting into 24's, or six-inch pots, placing them rather deeply in the pots so as to cover the stem with fresh earth to the extent of a couple of inches, the lowest leaves having been removed a day or two prior to potting to allow of the wounds healing over. The plants may then be placed on a shelf in a vinery, near the glass, or in a light situation in a frame or warm greenhouse; but if a frame be at hand, that is the best place for them, for their wants can be better attended to there than in houses devoted to Vines, or those covered with creepers. It is no use placing these plants under Vines, nor under creepers in a greenhouse, for they require all the light possible to keep them dwarf, and the plants are just ugly or ornamental according to the treatment to which they are subjected. If grown under the shade of other plants, or at a great distance from the glass, they are drawn, tall, ugly examples of feathery Cockscombs, and never can be considered ornaments; but when kept near the glass in a frame, or in any light, warm house, they are just the reverse. In whatever situation they are, they should be watered at every alternate watering with weak liquid manure, have air

daily, and a gentle sprinkling of water from a fine syringe on the evenings of hot days. If large plants are desired, some of the best plants may be potted in nine-inch pots, and if they be fed with liquid manure after the pots become filled with roots, they may be grown into handsome specimens. When in bloom they should be watered with rain water only, for liquid manure at this stage only tends to hasten the decay of the roots, and with them the end of the plant, whereas we are seeking to prolong the blooming.—G. ABBEY.

FLORISTS' FLOWERS AT THE ROYAL BOTANIC SOCIETY'S SHOW.—APRIL 30.

I THINK that the florists must be not a little proud to see how largely they contribute to these spring meetings, and how little display there would be at these but for them. Take away the Azaleas, Roses, Auriculas, Geraniums, and Cinerarias from the Exhibition of the 30th, and small indeed would have been the residue. I think, moreover, they may congratulate themselves that each year shows not only an increasing appreciation of their productions, but also a vast improvement in their cultivation; for, taking Roses as an example, I think one may safely say there never were such plants exhibited at this season of the year as those which obtained the prizes on that day, and indeed for any period of the year the plants would be considered marvels of growth. And then can Azalea-growing ever go beyond its present excellence? Azalea-showing I am sure can, for we must agitate for an alteration in the style of plant. If a more natural habit of growth be considered by the judges as more suitable, there would be no difficulty in our great growers falling into it; but so long as they consider either the cone or bell-shaped plant as the model, so long shall we have these unsightly-formed though most wonderfully grown and bloomed specimens brought forward. While I do not believe that we can ever assimilate our shows to the continental ones, yet we may learn from them to be contented with a more natural mode of growing our large plants.

AZALEAS have already been noted, but I would add a few remarks. There was a small number of the variegated varieties shown in small pots, including *Variegata Superba*, *Etoile de Gand*, and *Duc d'Artemberg*; and as some have asserted the similarity of these kinds, it was satisfactory to find that they are quite distinct both in marking and colour. Then there was a very excellent new seedling of Messrs. Smith, of Dulwich, called *Rosy Queen*, which is likely to be an acquisition, inasmuch as it is of the style of *Murrayanum*—an old and ill-shaped flimsy flower, whose place may be well supplied by the present new, well-formed, and stout variety.

AURICULAS were not nearly so good as I have seen them, the long prevalence of cold north-east winds having prevented their proper development. They were crimped in many instances; and those contributed by Mr. Turner were, while of wonderful growth, yet overdone; the character of the flowers in many instances being quite lost by the excess of stimulants, for there is no flower on which this tells more than on the Auricula, and coarseness to my mind quite destroys its peculiar charms. Mr. Potts, of Old Kent Road, took first place with Lightbody's Lord Lynedoch and Sir John Moore, green edges; Headley's Stapleford Hero (grey), Netherwood's Othello, and Spalding's Blackbird (self); and Hepworth's True Briton (white). Amongst the flowers exhibited by other growers were Smiling Beauty, good, but neither decided grey nor white; Headley's Royal Purple; Lightbody's Sir Wm. Peel, a good grey, but too pale in the eye; Oliver's Lovely Ann, an old and useful flower; Smith's Mrs. Smith, a bold and striking flower, although the paste is somewhat starchy. Mr. Turner's six were Reid's Miss Giddings, a new and apparently useful flower; Spalding's Metropolitan, a very bright violet blue flower; Spalding's Blackbird; Lightbody's Fair Maid, very fair indeed, as the whole flower looked as if it were covered over with meal; Lightbody's Admiral Napier, good; and Moore's Violet, the ground colour of which is one of the most unique and beautiful tints that we have in nature.

ROSES.—As I have already said, those in pots were magnificent, especially Messrs. Lane's and Mr. Turner's, which

were placed equal first. Messrs. Lane's were the largest and finest plants; but the style and finish of Mr. Turner's made up for a little deficiency in size, and larger plants than these we do not want. Why not curtail the size of the pots here as well as in Pelargoniums? The names have already been given of the winning flowers; but in a collection not for competition Mr. Turner had a beautiful plant of *Souvenir de Comte Cavour* (Margottin), and *Gloire de Santenay*, very fine; while *Le Rhône*, one of the new varieties of last year, promises to be very fine—it is a globular flower of brilliant colour. Nor must I omit a small plant with one bloom on it, but that a real beauty, of Mr. W. Paul's Lord Herbert, of great substance, brilliancy of colour, and good form.

In Cut Roses there were some fine blooms shown, although the character of flowers at this season is not always to be depended on. Mr. W. Paul, who was first, had *Jean Goujon*, a large flower with a peculiar purplish tint in it; *President*; *Bernard Palissy* (1863), a large, flat, rose-coloured flower; *Victor Trouillard*; *Lelia*, large; *Alba Rosa* (Tea), very good, and likely to be a favourite; *V. Verdier*, ragged; *Mrs. Wm. Paul*, good; *Louise de Savoie* (Tea); *Lord Herbert*; *Comtesse de Chabrillant*; *Vainqueur de Goliath*, dark and fine; *Madame Willermoz*; *Senateur Vaisse*, rather open; *Madame A. de Rougemont*, better than I saw it before, but still too much of the *Noisette* in it; *Alpaide de Rotalier* (1863), large good Rose; *Beauty of Waltham*, confirming my opinion of it, and *Princess of Wales*, good. Messrs. Paul & Son had, among theirs, *Souvenir de Lady Eardley*, large, rather thin; *Hamlet* (Paul & Son), in the style of *Beauty of Waltham*; *Amiral Lapeyrouse*, promising; *John Hopper*, good; *Paul de la Meilleray* (1863); *Lord Clyde*, not so good as usual; and *Rev. H. Dombrain*, bright and good.

In looking round I saw a good bedding Geranium of Messrs. F. & A. Smith, called *Excellent*; and a promising one of Mr. Bull's, light pink, and dwarf in habit, named *Eve*.—D., Deal.

BEAUTY OF WALTHAM ROSE AND MADAME C. CRAPELET.

Is "Beauty of Waltham not distinguishable from Madame Charles Crapelet?" This is the question; and I have no wish to widen the basis of the argument, unless in self-defence I should be compelled to do so. If "D., Deal," is right in his assertion, it follows—1. That I have grossly deceived my friends and the public in recommending it as a first-rate and *distinct* Rose; 2. That my stock of it, which is considerable, is depreciated fifty per cent. the difference in price between the two varieties. In a few weeks the Beauty of Waltham will be blooming in many of our foremost English gardens, and I appeal to the public in full confidence of a satisfactory verdict.—WILLIAM PAUL, *Waltham Cross*.

THERE is an old proverb that the "proof of the pudding is in the eating;" in like manner the proof of the Rose is in the growing. I am not surprised at Mr. Wm. Paul, in your impression for April 26th, joining issue with "D., Deal," as to the identity of Beauty of Waltham with Madame C. Crapelet. If "D." had grown the two Roses, unless under conditions very different from those which prevail elsewhere, he would soon have discovered essential points of difference between the two varieties.

In the first place, the Beauty is hardy and hearty, which, from my humble experiments, I cannot imagine Madame C. Crapelet to be, having lost two or three plants on the *Manetti*, the Rose perishing without apparent cause, the stock remaining alive. Again: the Beauty is constant (a charming quality in a beauty), and the flowers generally good; while not more than one flower in three or four of Madame is in character, particularly in autumn, when they are apt to be especially loose and yellow-eyed. Moreover the Beauty is a freer bloomer than Madame; and I hope to find from my present little trials that it will succeed in a town locality, which I have not yet been able to induce Madame to do. I also venture to think that Mr. Wm. Paul's Rose is deeper in colour than the French.

These views upon the two Roses in question are not opinions, but are grounded upon observations at not one but several nurseries, as well as at the show tables. Without wishing to question such an authority as "D.," whose papers I always peruse with interest, I would venture to ask whether hasty assertions are not sometimes conveyed therein? For instance: twice in his analysis of New Roses for 1863-64, I find it stated that "Touvais has never given us any good Roses;" yet in Mr. Rivers's select list Madame J. Daran and L'Éblouissante are placed. Fernet & Co. in the same paper are said to be unknown on this side of the Channel; yet Vainqueur de Goliath, described by Messrs. W. Wood & Son in their catalogue as the best Rose of the season, is of their raising; and Deuil de Prince Albert is incorrectly assigned to a wrong raiser. Want of accuracy as to facts in a public writer (amateurs will blunder, of course), is to be regretted, as it detracts from acknowledged merits, and is apt to mislead those who look up to such an unquestionable authority.—W. D. PRIOR, *Homerton*.

THE ROYAL BOTANIC GARDENS, KEW.

It is long since any notice of the vast collections existing at Kew has appeared in these columns, and the retirement of Mr. Smith from the curatorship, after a connection of forty-four years with these gardens, called the fact to mind. Still it was less with the view of attempting anything like a detailed account of the place than to see our old and valued friend that we determined on a visit. We were fortunate in finding him at home, and in excellent health and spirits, and we gladly availed ourselves of his guidance to take a run through the principal houses, and set down a few notes of their contents.

The first we entered was the Succulent-house, which is a spacious span-roofed structure 200 feet long and 26 feet wide, the rafters covered with *Lapagerias*, *Passifloras*, *Ipomæas*, and *Bignonias*, whilst along the shelves at the sides was ranged an immense collection of *Mammillarias*, *Crassulas*, *Echeverias*, *Sempervivums*, *Gasterias*, *Apieras*, *Cereus*, *Opuntias*, *Rhipsalis*, *Echinocactus*, *Echinopsis*, &c., all in the most perfect health. In the centre of the house a large American Aloe, some 8 feet high, and 12 feet or so across, was a striking object, and there were several others of less dimensions, though still large. Several other interesting species of the same genus were also noticeable, such as *Agave glanescens*, *A. xylonacantha*, with spines somewhat like pieces of wood shavings, and a fine plant of *A. Karatto*, a scarce species. Then there were *Furcraea longava*, a remarkable Bromeliaceous plant, growing in its native country with a tall stem and a cluster of leaves at top; *Dasyliropsis*, with *Yucca*-like foliage; *Yuccas* themselves in great variety; *Euphorbias*, one of which, *canariensis*, was a very large plant; *Echinocactus Stainesii*, 5 feet high, and a host of kindred plants. Among plants in flower were *Arthropodium cirrhatum*, with pretty white flowers; several *Cereuses*, of which there were specimens varying in height from 1 to 12 feet, *Phyllocactus phyllanthoides*, and *Cereus crenatus*, with very showy yellowish white blooms, which offered a strong contrast to the vivid crimson and scarlet blooms of *C. Gordoniana* and *Jenkinsoni*. The collection in this house has been brought together within the last twenty years, mainly through the exertions of Mr. Smith, who takes much interest in this class of plants.

The next house we came to was the Tropical Fernery, 140 feet long, where there is a valuable and rare collection of the genera *Trichomanes* and *Hymenophyllum* in forty square Wardian cases, which has only been brought together within the last ten years; and intermixed with these was a good collection of *Selaginellas*. Among the rarest species here were *Vittarias zosterifolia* and *lineata*, *Cyathea sinuata* from Ceylon, *Hymenophyllum nitens*, *Trichomanes angustatum*, *muscoides*, and *Bancroftii*, not little plants but large patches. The shelves at the sides were, in addition to the above, filled with *Adiantums*, *Blechnums*, *Lomarias*, *Gymnogrammas*, &c., whilst the centre stage was occupied with fine examples of the different species of *Neottopteris*, *Acrostichum*, *Hemidictyon*, *Lastrea*, *Pteris*, *Goniopteris*, *Angiopteris*, *Aspidium*, *Asplenium*, *Marattia*, &c.; and many curious *Drynarias* and *Goniophlebiums*. There were also two

remarkable plants of *Stevensonia grandiflora*, a very handsome broad-leaved Palm. *Oleandras* were here grown on wire cylinders filled with turfy peat, in which way they may be made to attain any height, so as to form, as it were, the trunk of a tree covered with Ferns. At the end of the house were some fine *Platyceriums* and the rare *Ophioglossum pendulum*, with a ribbon-like frond 4 feet long.

In the Tree Fernery, a recent and comparatively small structure, *Cyathea arborea*, some 18 feet high, was already touching the roof, and there were also fine specimens of *C. muricata*, and *Hemitelia horrida*, and *speciosa*. The plants were pictures of health and vigour; but we felt disappointed that the collection was not more numerous, although quite large enough for the size of the house.

The Cool Fernery also presented a very lively aspect, and contained a most extensive collection of *Pteris*, *Lastreas*, *Polystichums*, *Cheilanthes*, *Phymatodes*, *Todeas*, a fine plant of *Neottopteris australasiae*, *Trichomanes radicans*, a frame of *Hymenophyllum tunbridgense*, the Japanese *Woodwardia orientalis* growing well, the rare *Asplenium Selosii* from the Austrian Alps, and a multitude of other Ferns which succeed under cool treatment.

The Heath-house might well tempt one to linger in it for a while, being gay with *Chorozemas*, *Ericas*, *Epacrises*, and *Tetrathecas*; but hurrying through it and the Show-house, which was filled with *Azaleas*, *Rhododendrons*, *Eriostemons*, *Pelargoniums*, *Cinerarias*, &c., there was only time to notice in the latter *Rhododendron Nuttalli* with four trusses of upwards of a score of its large fragrant white flowers, and two large *Gleichenias*, *dicarpa* and *flabellata*.

A Palm-house, No. 19, was the next structure, and in it were several very remarkable plants, such as *Adenium obesum*, found on dry rocks near Aden, and having a swelled-out club-like stem, which in the specimen here seen is probably of immense age; and *Bowenia spectabilis*, discovered by Allan Cunningham, in Queensland, and rediscovered by Mr. Hill; in this the leaves are like those of a *Zamia*, but bipinnate instead of simply pinnate. *Strangera paradoxa* is another curious *Zamia*, the veins being like those of a Fern, and not running lengthwise as in a *Zamia*, from which circumstance it was once erroneously supposed to be a Fern. A plant of *Corypha umbraculifera* afforded a striking instance of the slowness with which the growth of some tropical giants proceeds at first. It was raised from seed in 1824, and although every known means has been tried to hasten its growth, even now, when forty years old, it is not more than 2½ feet high. After a time it may be expected to take a start and grow rapidly. In its native country, it may be observed, that this gigantic Fan Palm attains 100 feet in height with leaves 20 feet long. Among a numerous collection of *Zamias*, *Carludovicas*, *Cyclanthes*, &c., we noticed a magnificent specimen of *Alpinia nutans* in flower; also, fine plants of *Heliconia bicolor* and *H. metallica* with immense leaves of a bronzy green; and *Cereus Macdonaldii* covering a space of 8 feet by 12.

In the Cool Orchid-house *Lycaste fulvescens*, which, were it not for the dun colour of its flowers, would be very showy, some *Bletias*, *Epidendrums*, and *Dendrobiums*, were in flower; and of those not so were several species of *Octomeria* and *Pleurothallis* not often seen, as well as abundance of other Orchids better known. Passing into the Tropical Orchid-house we found *Sobralia macrantha*, *Cypripedium barbatum* and *Hookeri*, *Calanthe veatrifolia*, *Phalenopsis grandiflora*, *Chysis Limminghi*, and several *Oncidiums* in bloom; and in another division fine specimens of *Vandas* and *Arides*, the whole exhibiting a wonderful improvement on the condition which they were in some years ago, when by some change of men the collection had become much deteriorated.

Quitting the Orchids, the next house entered was Stove No. 15, in which a fine plant of *Rhynchospermum jasminoides* running 20 feet along the roof was in full bloom; besides which, *Stephanotis* and *Clerodendrons* were trained in a similar way. Here there was a good general collection of *Theophrastas*, *Clavijas*, and other tropical broad-leaved plants, a very old hushy plant of *Brownea coccinea*, with its fine scarlet flowers, *Medinilla magnifica* also in fine bloom, *Allamanda neriifolia*, also a few *Cinchonas*, of which *succirubra* appeared the most vigorous; but the number of plants of the various species of this genus is now greatly diminished

in consequence of the large quantities which have been distributed to the colonies.

In the old Victoria-house, now No. 6, were a few young plants of the *Victoria regia*, which has this year been very generally a failure throughout the country, Pitcher-plants, Marantas, Caladiums, &c. Of the other houses which we visited, one was wholly devoted to Mesembryanthemums, another was filled with Cape bulbs, and a third was extremely gay with Begonias in bloom. Several long propagating-houses contained a healthy stock of some thousands of young stove and greenhouse plants, partly for the supply of the gardens themselves, and partly for sending abroad, and for exchange; and lastly there was a great extent of glass occupied with bedding stuff, of which also there was a large quantity of strong sturdy plants turned-out under hoops, and other means of temporary shelter, to harden-off, preparatory to planting-out. Near these houses was the herbaceous ground, with a general collection of such plants arranged according to their natural orders, the beds neatly forked over, and not a dead leaf to be seen.

Crossing the grass to the Palm Stove, on entering that spacious structure we found that some important alterations had been made. Formerly there were no central paths in the wings, but such have been created, so that a better view can be obtained of the gigantic specimens of tropical vegetation growing in that part. The mode in which these paths are marked out is well worthy of notice, the edgings being formed of turf turned grass-side downwards, and afterwards covered with sand. There is an important advantage in this, for by keeping the sand moist a greater amount of atmospheric moisture can be secured, and with that object in view the plan might be still further adopted with advantage. Lofty as the Palm-stove is, it has proved not sufficiently so for the trees which are grown in it; and although the operation was deferred as long as possible, it became at last a matter of necessity to cut down one or two which had grown through the roof, and others which had become too large for the space. Two of these were *Caryota urens*, the others *Strelitzia augusta* and *Cocos plumosa*. These have been replaced by *Aerocomia sclerocarpa*, *Bambusa gigantea*, *Astrocaryum rostratum*, and *Caryota urens*; but it is evident that it will not be long before others will have to share the same fate as those which have been thus replaced. The large collection of *Billbergias*, *Ananas*, *Vriesias*, &c., has also been repotted and re-arranged. We found the *Rose Apple* (*Jambosa vulgaris*) in flower; both it and *malaccensis* have fruited here. *Seaforthia elegans* was also bearing its lilac racemes of flowers. It did the same last year, and seeded, and young plants have been raised. *Dracena Draco* (the Dragon's Blood) likewise flowered and seeded last year for the first time, and young plants have been obtained. The parent plant is now beginning to throw out branches from its hitherto straight stem, these being now about a foot long. A gigantic *Sabal umbraculifera*, which has been about seventy years at Kew, is also about to flower, and there is every prospect of *Musa ensete* doing the same; *vittata* flowered and fruited last year, but the fruit was not edible. *Phytelephas macrocarpa* had still the remains of its last year's flowers on it, previous to which it had not flowered for seven or eight years. We may also mention that *Cocos plumosa* has seeded, and that young plants of it have been raised. Time would not allow of more than a glance at these, and many other objects of interest had to be passed over altogether for the same reason.

In the Victoria-house the *Nelumbiums* are just making a start, but the *Victoria regia* itself is not yet planted out. Relative to the growth of this beautiful aquatic last season, Mr. Walker, the intelligent foreman of the Palm and Victoria-houses, kindly afforded us the following information:—It was planted on April 25th, and then had six leaves a foot in diameter; leaves taken off from time of planting to end of growth, 65; seeds sowed, 162. The first flower was produced on July 14th, the others as follows:—viz., July 16th, 18th, 22nd (two flowers), 25th, 26th (on the 26th consequently there were two flowers, one in its first or white, and the other in its second or rosy, stage), 28th, 30th; Aug. 1st, 3rd, 6th, 8th, 10th, 12th, 14th, 17th, 19th, 22nd, 24th, 26th, 29th, 31st; Sept. 2nd, 5th, 8th, 10th, 13th, 15th, 18th, 21st, 23rd, 26th, 29th; Oct. 1st, 5th, 8th,—in all thirty-seven flowers,

each lasting two nights. Of leaves, there were twenty-one on July 22nd, twenty-six on the 26th, twenty-five on Aug. 3rd, twenty-six on Aug. 8th, twenty-seven on the 10th (the greatest number at any one time), twenty-four on Sept. 3rd, twenty-five on the 7th, and twenty-six on the 11th, each leaf when full grown being 6 feet in diameter. The *Nymphæas*, of which there were several in the tank, are now grown in hampers instead of in pans as formerly, and this plan answers much better, as the roots can readily find egress by the intervals in the basketwork.

The lateness of the hour unfortunately rendered it impossible to visit stove No. 1, which contains a magnificent collection of *Aroideæ*, both useful and ornamental; nor the old orangery, now turned into a museum for specimens of woods, of which there is a most extensive and interesting collection.

Both in the houses and grounds everywhere the highest order and keeping prevailed, and an Englishman could proudly point to Kew as being in a condition worthy of what it is, and we hope will ever remain—the greatest scientific garden in the world. Year by year its sphere of usefulness is extending, may it go on and prosper in the future as it has done in the past.

ORCHARD-HOUSES.

HAVING been on a journey I have been prevented from sooner answering Mr. Abbey's letter at page 295 of your Journal.

First let me say I really had no idea where his "north" was, and had some curiosity on the subject; next, that though I built my first orchard-house with wooden sides and ends, and managed to grow fine crops in it every year, and shall be able to show good fruit on the trees of this house again this season, I never advocated the building of such houses. My little book was written to persuade people to build good houses, and convince them that however simple any cultivation might be, a little knowledge was requisite to insure success. I acknowledge I had really no idea a thing so easy to me and my men, who had never before grown a fruit tree in a pot, would have been difficult to any gardener worthy of the name.

Though I should not build exactly the same style of house in the cold "north" which has answered so well in sunny Hertfordshire, it would be a very bad one indeed from which I should not expect to get good Peaches; and where failures occur it is generally, if not always, the man who is in fault. There is an old saying, "Bad workmen complain of their tools." To illustrate this I will mention a few cases.

The first formed the subject of a paper I sent to your Journal last season in which an amateur who does not keep a gardener produced in a small house, not very well built, 2700 Peaches and Nectarines, and he tells me his prospects are first-rate for this summer. There is no artificial heat in this gentleman's house. The second is the house at Burton, also previously alluded to, managed by a lady, which has always been full of fruit. Her husband wrote to me a few days ago to say "He would rather give up his kitchen garden than his orchard-house, for he could buy vegetables, but could not purchase the pleasure he derived from his beautiful fruit trees under glass." This house is also unheated. Captain Hornby, of Knowsley Cottage, Prescott, who has several large orchard-houses, some with, and some without, heat, not only showed me that he, or his gardener, or I believe both, knew how to insure fruit, but the trees, both against the back walls of the houses and in pots, were all that could be desired. He gathered from a Green Gage 110 dozen in 1862, and 105 dozen in 1863; from a Kirke's Plum 80 dozen in 1863; a Pond's Seedling had 28 dozen in 1863, four fruit from which weighed 15 ozs. Place these facts against the one I will next relate.

A gentleman, also living near Liverpool, who had a better house than any of these, according to my ideas, had very poor crops for two years in succession. He was persuaded by his gardener to heat the house last year with hot water, and has now less fruit than ever. This proves the man, not the house, was in fault. Whenever gentlemen make up their minds that they will have Peaches every year, gardeners will be found able to produce them. I do not say an ocea-

sional failure from some unforeseen cause will not happen to the best gardener in any kind of cultivation, but the means being provided, may we not say with Napoleon, "Success is the test of merit?"

Mr. Abbey says it is contrary to vegetable physiology to say Peaches in an orchard-house can be superior to those grown on walls, and that fruit on a heated wall uncovered are always superior to orchard-house fruit. He may understand vegetable physiology better than I, and, perhaps, will be at the trouble to explain what he means. Are not Peaches, like Vines, natives of hotter countries than England? Do the laws of vegetable physiology teach him that Grapes are better from open walls, or without flavour from glass houses? However good Peaches may be in hot countries, I never in England eat a Peach from a wall equal to an orchard-house Peach; still less an Apricot. Then as to heated walls, there are numbers of old flued walls in this neighbourhood, but I never saw a fire in one of them; and when I believe heating an open wall an economical and satisfactory method of consuming coal, I will try to make myself comfortable out of doors on a cold night by sitting with my back to a good bonfire.

My friend Mr. Rivers tried to make plain a beautiful and interesting mode of culture, and I tried to give a few additional hints, and we, it seems, are to be answerable for the non-success of a man who required to be told not to sink a house below the level in a cold wet soil, or build a house with thin boards having nice ventilating spaces between them in the cold "north."

Those who talk against growing fruit trees in pots and tubs had better go to Liverpool, see Captain Hornby's beautifully-kept garden, if they can gain permission, and then go to Knowsley and ask to see Lord Derby's Cherry trees loaded with fruit, return home as soon as they like, and try to learn how to succeed in future, instead of attempting to convince people that every one ought to be as incapable as themselves.—J. R. PEARSON, *Chilwell, Notts.*

In answer to Mr. G. Abbey's remarks on the failure of orchard-houses near Bradford, lest amateurs so far north should be misled and discouraged by the dictum of such an authority, it seems desirable to state that within thirty miles of Bradford in a north-westerly direction, within cannon shot of famous Pendle, fine, well-ripened Peaches and Nectarines are grown without difficulty in the simple lean-to boarded houses made after Mr. Rivers's plan.

What the altitude is I am not at this moment prepared to say, but as regards excessive quantity of rain and for cloudy sunless weather, very few localities can compete with it.

It is necessary here to avoid the liberal air-giving which Mr. Rivers recommends. Air should not, except from sheer necessity, be given where there is danger of much loss of heat. In windy weather the ventilators on the windy side should be kept closed. As sun heat, which is by no means plentiful, has to do the whole business of maturing the fruit and ripening the wood, it must be hoarded with jealous care.

Plums alone would afford a sufficient plea for orchard-houses in this neighbourhood. Jefferson's, Coe's Golden Drop, and Reine Claude de Bavay, such as could not be produced on the best walls, can be grown within our orchard-houses.

Apricots are a failure, but not from the causes to which Mr. Abbey attributes failure in Peaches and Nectarines. We lack something in the management, and if any of your correspondents who have experienced and overcome the difficulties of growing them would give your readers the benefit of their knowledge, it might prevent our abandoning in despair the culture in the orchard-house of this most delicious fruit.—PENDLE.

[An amateur having much experience in the management of orchard-houses has just undertaken to furnish us with a series of timely notes, as well as to answer any relative questions.]

THE ROYAL HORTICULTURAL SOCIETY'S EXHIBITION ON THE QUEEN'S BIRTHDAY.—I have been asked many times what is the meaning of the word "swag," as used in connection with garlands, wreaths, &c., which we find advertised for competition by the Royal Horticultural Society, on the

Queen's birthday. We country Fellows are generally supposed to be ignorant fellows, but this word sticks in the throats of even West-enders, for we cannot get it explained by any to whom we have applied. Is it a word from which swagger is derived? Does it come from the South Kensington Museum? Pray, Mr. Editor, do try and enlighten our dark minds.—A YOUNG MAN FROM THE COUNTRY.

GARIBALDI AMONG THE GARDENERS.

On the occasion of General Garibaldi's visit, Cliveden, the residence of her Grace Harriet Duchess of Sutherland, near Maidenhead, was again this season budding into full bloom. Already, though the trees all round were leafless, the parterres of this lovely spot were gay with floral beauty, and seemed to smile as if in welcome to the great hero. The apartments occupied by the General and his suite consisted of all the lower part of the east wing of the mansion, looking on to what is called "The Duke's Garden." Here there is a saloon of considerable dimensions, leading into a conservatory, which, even in the duller months of the year, is always attractive, but which in that memorable month of April was positively teeming with "Flowers of all hue;" and when lighted up with M. Madier's new majolica flower-baskets, which are so formed as to combine a candelabrum also, the effect was very beautiful. This was the General's favourite retreat, and there in the evening he retired to smoke a quiet cigar after the labours of the day. Under the windows of the sitting-room, and all round what formed the bedroom, was a gay flower-border, consisting of Aubrietia, Arabis, Anemone, Pansies, Oxlips, and Jonquils, with a broad belt of Italian Wallflower. This last loaded the air with its perfume, which was diffused all through the apartments adjoining. All the beds in the Duke's garden were more or less filled with bloom. The most conspicuous were the white Pansy, with an edging of the beautiful blue Scilla amœna. Others were of yellow Arabis, single Tulips, Evergreen Candytuft, Virginian Stock, the double Cuckoo-flower or Lady's Smock, red and white Daisies, &c.

From the top terrace in front of the mansion the great flower garden, of which we last year gave a representation, had already begun to develop its beauties, for even at that early season it was sufficiently full of colour to be beautiful. Most conspicuous were large beds of blue *Myosotis* studded over with the white *La Candeur* Tulip, looking as if jewelled in honour of the visit; and there were other beds of the same studded with red Tulips, which were neither so rich nor showy. The other beds were of *Limnanthes Douglasi* and *Silene pendula* not yet in bloom, but sufficiently dotted with Tulips to create an effect of colour. The centres of the beds were already gay with some of the early-flowering scarlet *Rhododendrons* and yellow *Azaleas*. The large circle at the extreme end, too, was also gay, and told well in the distance with its blue field relieved with masses of the Purple *Honesty* pegged down, and making a bold effect.

But the greatest feature of the place was the ribbon-border that runs from end to end in front of the under terrace, from the great mass of colour which it exhibited, and which was so full of bloom, and the colours so beautifully disposed, as to extract from the usually unimpressive hero the exclamation, "Magnifique!" The first row consisted of the pink Daisy, then white Daisy, Cliveden Blue Pansy, Cliveden Yellow, and Cliveden Purple; mixed Virginian Stock, *Gilia tricolor*, *Collinsia grandiflora*, Dwarf Wallflower, and Purple *Honesty*.

In borders, all about the grounds, by the sides of the walks, and covering the sloping shady banks, were masses of Cowslips, Oxlips, Blue Bells, and Violets, by the acre; in fact the whole place was gay with flowers, as if in summer, while as yet the deciduous trees were bare.

The General planted some trees also as memorials of his visit, and the way in which he performed the work would have done credit to many a good professional.

We shall take an opportunity of recurring to these Cliveden flower gardens, and particularly to the large one, which will soon be in a full blaze.

AMONG the hundreds who visited the orchard-house at Brook House, Isle of Wight, in the first week of last month,

none were more delighted than General Garibaldi. "Italy! Italy!" he exclaimed on entering, so charmed was he with the hundreds of trees all in full bloom. Early every morning during his stay he took his walk and his first cigar in it, at the same time chatting in the most friendly way with Mr. Gray, the gardener, giving him a friendly shake of the hand, and the offer of a cigar to smoke with him.

He was quite astonished to see the trees in pots so full of bloom; this being quite new to him.

Mr. Gray found that he was no novice in gardening, for he told him that he had pruned his Vines before leaving Caprera.

The orchard-house at Brook is rather an imposing structure; it is 156 feet long and 24 feet wide. A border in the centre, 5 feet wide, is planted with pyramids of Peaches, Nectarines, and other fruit trees. A path on each side of this border, upwards of 3 feet wide, goes round the house. Two side borders are planted with bush trees, and among them are trees in pots. The effect of this large assemblage of fruit trees all in full bloom in a climate warm, dry, and most agreeable, was enough to remind the General of his dear native country.

FLOWER-BEDS, PLANTING.

DEAR SIR,—I say "Dear Sir," for you seem to be a very old friend, and there is no shelf in my bookcase I more frequently visit than the one with a long row of the neatly-bound "Cottage Gardener and Journal." That shelf is associated with some of my happiest days—gardening days; and you have been my head-master in this school, though a sorry pupil I am, and do you little credit I fear, when I remember it was so long ago as October, 1848, when you gave me my first lesson. I hope, therefore, you will forgive my troubling you with my plan for "spring bedding," which I enclose, and also the request I have to make, that you will kindly give me your opinion upon it.

I have just read Mr. Fleming's book on "Spring and Winter Flower Gardening," and which bears on the title-page the monogram of THE JOURNAL OF HORTICULTURE. There is much valuable information in that book, which is very much needed, for we must come to this spring bedding if the present fashion of summer bedding continue. I will put aside for the present the winter part of it, for winter is a season of the year when persons seldom go into their gardens, and the loss of flowers is consequently little felt. This loss, however, is very much felt in spring, and if there are no flowers then in the garden at home, one is sure to wander into the lanes and woods—anywhere, indeed, to escape from the bare, dreary, ploughed-field aspect of the beds in the garden, waiting for their summer tenants. Flowers are never so much valued by us as in spring; one Wallflower then seems to give more pleasure than acres of blazing colour in August.

Mr. Fleming gives a small plan in his book adapted from the larger Dropmore plan, suitable, he says, "for places where there is no great amount of glass, if any, and where the gentleman or lady takes a great amount of interest, &c." Now, this seemed to suit my case. I am my own gardener, and so I carefully studied the plan, being anxious to make ready for next spring, and to begin in time; but although Mr. Fleming's is, doubtless, a very simple plan for a duke's gardener, I am quite out of my depth in it. My difficulty is twofold. First, Tulips and Hyacinths are very expensive, if they are to be planted in sufficient numbers to make any show. In other respects nothing is easier than to fill the beds with bulbs; but the objection I name is generally a very serious one. And, next, as to the annuals mentioned. Now, I very much doubt whether annuals sown in the August previous, and ever so carefully brought on, will flower in the following spring early enough for the purpose, at least in this latitude. What they have done at Cliveden, on the sunny side of the Thames, I cannot tell; but for this climate I dare not trust to them.

I do not think I am very exacting in my requirements for the spring bedders. Give me six weeks' bloom from the middle of April up to the end of June, and I am satisfied; because, as I said before, the loss of flowers is really felt then, and there are sighs for the old herbaceous borders.

Any reasonable trouble would be more than repaid to me, if I could secure a continuous bloom for these six weeks from plants of suitable habit. In this neighbourhood (Derbyshire) we generally plant out our summer stock on the 20th of May, but if the beds were pretty then, and in full bloom, there could be no objection to a delay of a fortnight; indeed, the 1st of June would be the safer date. Last year we had 2° of frost here on the 20th of May; but we are naturally weary of the ploughed-field, and impatient to begin.

SCALE 1/4TH OF AN INCH TO THE FOOT.

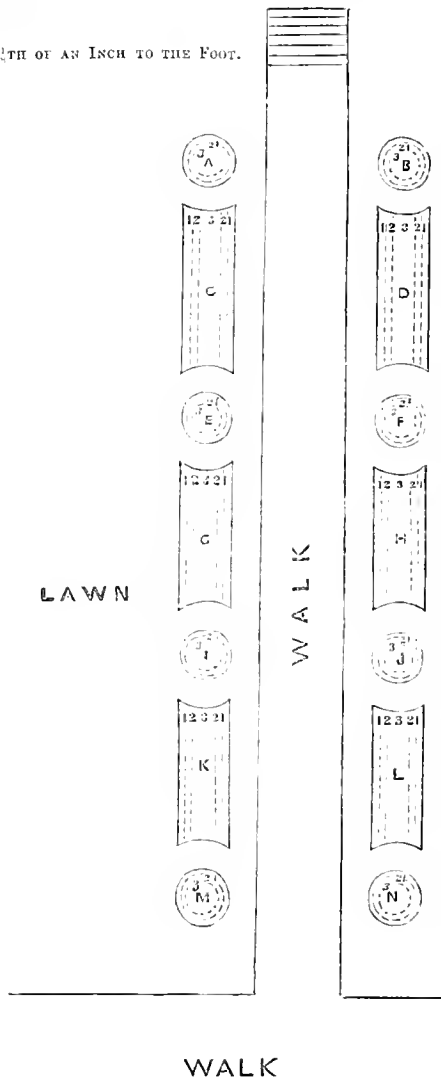

- Circles A, B, K, F, I, J, M, N, planted similarly—thus: centre of Cheiranthus alpinus (3); ring of Arabis, white (2); ring of red Daisies (1).
- c, 1, Cerastium tomentosum; 2, Aubrietia purpurea; 3, Alyssum saxatile, negged, mixed with Anemone Azure Incomparable.
- D, Match bed.
- g, 1 and 2 same, though ribbon—viz., 1, Cerastium; 2, Aubrietia; 3, mixed Anemones, from seed sown in the previous spring.
- H, To match G.
- K, 1, Cerastium; 2, Aubrietia; 3, Arabis alpina variegata, mixed here and there with Van Thol Tulips (scarlet), or single scarlet Anemones.

I have drawn my plan with a view of making a simple and inexpensive experiment to meet these requirements. I could very easily have put on paper a much more imposing array, but I have rather aimed at an easy, practical, and inexpensive plan. Will you kindly tell me whether you think it will answer my expectations in this respect, and offer me any suggestions upon it which may occur to you? I ought to tell you that the continuous edging of Cerastium tomen-

tosum does double duty, because it is used this summer for bedding, and will remain in its place for the spring edging, and with a little trimming will look fresh and well this time next year.

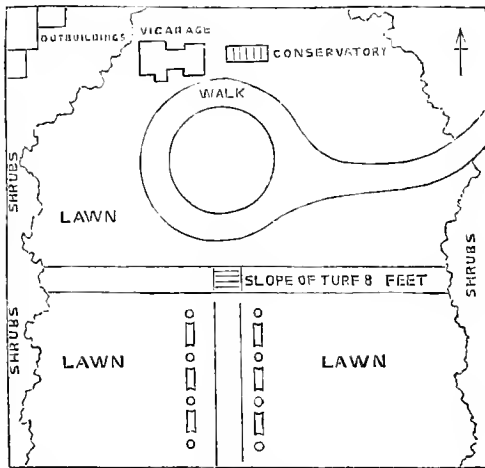

Twenty acres of water here.

This subject is one which is, I feel sure, becoming interesting to your readers—a further proof of the growing love of gardening among us; and I should rejoice to see some further light thrown upon it, and some instructions given in your Journal for the propagation and culture of plants suitable for the purpose, and within the reach of those who have neither more spare time nor a longer purse than your old but willing pupil—A COUNTRY PARSON.

[We admire your plan very much, and have no doubt that the simplicity and the comparative commonness of the plants will be great recommendations. After all those plants are the best—aye, and even the most beautiful—which the peasant's wife can rival the duchess in cultivating. The greatest blessings are those which can be and are enjoyed by every living thing. We owe you and Mr. Fleming thanks for showing how much beauty and taste may be combined with but little cost except the labour. We feel very shy to say a word in criticism, but we would venture to hint that simplicity, and economy too, might be combined if all your edgings were of a whitish tint and all were lasting for the season. Your idea of so using the *Cerastium* for the season through is good. With good trimming the *Cerastium* might do for a couple of seasons; but if it showed any signs of raggedness it could be removed in November, some of the soil at the sides changed, and a double row planted with little bits, say 4 inches apart. These would be nicely rooted and make neat plants by the spring. A piece might be planted on a border to supply young plants, if any in the rows or the beds should fail. So far for the edgings to the long beds. We would do the same with the circles by making the variegated white *Arabis* the outside row instead of the *Daisies*. We have also another reason for this. These eight circles are to be planted in a similar manner—thus: centre of *Cheiranthus alpinus*, ring of white *Arabis*, and outside ring of red *Daisies*. Now, the *Cheiranthus* is a sweet creamy yellow, and the white next it will make both somewhat insipid to the eye, which would be done away with by placing the red *Daisy* next the yellow, and the white round the *Daisy*, and then again for summer planting the edgings would be left undisturbed. The Variegated *Arabis* is pretty hardy; small pieces planted in a sandy border in the end of autumn will be nicely rooted before spring, especially if a few evergreen twigs are stuck among them, or they may be rooted anywhere in a shady place in summer after the flowering is over. This will make better plants than dividing the roots.

These eight circles being planted alike, perhaps it would be as well if the six long beds between them were also planted alike; or, if variety were the object, each pair of circles and each pair of long beds might be different. Sup-

pose the circles were planted as proposed this year, and that next year they were to be centred with *Cheiranthus alpinus* and *Cheiranthus Marshalli* alternately, or one of each and yellow *Violets* or *Heartsease* alternately, and ringed with purple and blue *Heartsease* alternately, whilst the edging was the same, the beds would look very nice, and the *Violets* would be almost as easily propagated as the *Cheiranthus* or the *Aubrietia*. The simplicity of the eight circles is somewhat departed from in the planting of the six long beds, the two outside rows being the same, but the centres different; and in that case the centres of A, B, C, D, E, F, would run in a line of colour, like a ribbon, as well as the outside rows. Except for departing from the charm of simplicity in arrangement there can be no fault found with the proposed planting. The simplest remedy would be to have no yellow in these long beds, but to centre them with your mixed and scarlet *Anemones* and *Tulips* on a ground-work of pink *Virginian Stock*, which you could sow on the ground late in autumn; and if you also sowed some in a border that you could protect a little, you would have plenty with which to make up all deficiencies. This we think would look better than varying your planting, unless every pair of beds were to be planted differently. The ribbon idea would be better carried out when looked at from the terrace if the centres of all the beds, as well as the edgings, were similar in colour, and, more especially, if you made seven lines instead of five. Thus, beginning at centre—blue, yellow, purple, white: the blue being *Nemophila insignis* or blue *Heartsease*; and the purple, purple *Heartsease* or *Aubrietia*; but the turn of the circle would so far destroy the unity that we would prefer your plan of arrangement. We shall be glad to know what you finally decide upon for the first year, and will be happy to give any help we can.

Annuals for early work, as those named—*Collinsia bicolor*, &c., do best when sown on a poor border that has just been moved a little on the surface, and the seeds covered with sandy soil, and some evergreen twigs stuck in to break the force of the wind and protect from frost, and then lifted in pieces and planted about February after the ground is nicely mellowed and pulverised. *Heartsease* may be struck in a shady place in summer with or without a hand-light; but the best way is to divide the plant so as to secure a bit of root to each division, they will thus make nice plants before winter. The *Aubrietia* will strike after flowering in a shady border with or without a hand-light. The shoots of the *Alyssum saxatile* strike best in light soil under a hand-light. A shady border should be in readiness for removing all these plants to in summer when the summer planting is to be proceeded with. The *Anemone* roots, *Tulips*, &c., may be dried and kept in sand, or in a dryish place, until planting time in the winter.

We consider, like you, that nothing is gained by turning out bedding plants too early, if the plants do not become stunted too much beforehand. We generally begin about the 20th of May. We have begun much earlier, but we generally gave ourselves extra trouble and obtained no benefit. A friend of ours who turned out *Calceolarias* and *Verbenas* last year on the 18th of April, was at great trouble in protecting them, and good plants they were. We turned out plants half the size on the 10th of June, and before the month was over they were far a-head of the April-planted ones. We hear every day of this gentleman and that lady planting their scarlet *Geraniums* and yellow *Calceolarias*, and are told we will be nowhere this season. One thing we know—we have had fine plants made black by frost after the 14th of May; and though a few beds may be protected easily, it is no joke to try and protect a whole flower garden. The fact is, unless in warm spots, plant when you will, there will be no very vigorous growth until the ground is heated by the sun. We admire very much the picturesque outline of the shrubbery at the sides of the lawn.—F.]

FEMALE SCHOOL OF ART.—Her Royal Highness the Princess of Wales has graciously consented to open the fête and bazaar, which will be held, by permission, in the Royal Horticultural Gardens, in aid of the building fund of the Female School of Art, Queen's Square, on Thursday, the 23rd of June next.

ROYAL HORTICULTURAL SOCIETY'S FLORAL COMMITTEE.—MAY 4TH.

A POSTPONED meeting of the Committee was held this day in the Council-room at South Kensington. An unusually limited number of plants were sent for examination, the cause of which we cannot explain, excepting that the original day fixed for the meeting had been changed, and sufficient notice might not have been given.

Mr. Bull sent a fine specimen of *Astrocaryum mexicanum*, which when a small plant in 1862 received a label of commendation—this very beautiful Palm had greatly improved in its general appearance, and from its distinct and handsome form was awarded a first-class certificate—also *Amaryllis Sparkler*, a pretty small-flowering *Amaryllis*, with bright orange scarlet flowers, but not of good form; *Pelargonium Eve*, a very promising bedding variety, with bright pink flowers in compact trusses, the plant itself of compact habit, and when seen in its proper season it will doubtless prove worthy of special notice. Bedding plants cannot fairly be judged at this season of the year, as the difference of colour and habit between plants grown under glass and those planted out in the open air may often mislead as to the true merits of the plant. He also sent *Mimulus Unique*, a very pretty and distinct variety, one of the crosses from *Mimulus cupreus*. There appeared a distinct character about this flower, which is a brownish orange minutely spotted all over the surface—second-class certificate. From the same came also *Pinus Albertiana*, one of the handsomest of Conifers, well known throughout the country.

Messrs. Smith, Dulwich, sent *Nepeta (Glechoma) variegata*, with golden variegation. This appears to be the old *Glechoma hederacea*, or Ground Ivy, with a new name. This plant had been often exhibited before.

Mr. Salter, Hammersmith, had *Sedum Sieboldii* variegatum, a very interesting plant, having in the centre of each leaf a creamy white mark surrounded with a bright green margin. This will make a very showy plant for baskets or rockwork, and very distinct from any other variegated plant—first-class certificate. *Ranunculus repens variegatus* was also shown by Mr. Salter. This pleasing form of the common *Ranunculus* was much admired from the extreme whiteness of the variegation. It will be found most useful for rockwork, especially in dark or shady situations, where its bright foliage will be very conspicuous—second-class certificate. *Geranium pratense foliis reticulatis* came from the same.

Messrs. Downie, Laird, & Laing, sent *Pansy Mrs. H. Dombain*, one of the Fancy division of Pansies, a large rough-edged flower, with a creamy ground blotched with very large deep purplish central spots—second-class certificate.

Mr. Turner sent *Pelargonium Duchess of Somerset*, a seedling of the Fancy varieties; also a seedling *Auricula Rev. J. Bramhall*, small flower and very starry; *Auricula Buckstone*, a very fine green-edged flower of first-rate qualities—first-class certificate; *Auricula Miss Giddings*, a green-edged rough flower; *Auricula Mrs. Jamieson*, with very dark black ring which cut through the green edging; and *Auricula Earl of Shaftesbury*.

From Messrs. Fisher, Holmes, & Co., came a seedling *Berberis* named *Handsworthiensis*, a plant of dwarf habit and very free-flowering—first-class certificate.

Mr. Parsons exhibited a few flowers of a seedling *Tropæolum*; flowers large and circular, bright orange; one of the Crystal Palace section of *Tropæolum*: a very promising variety should it prove free-flowering when planted out.

A few plants recently sent home by Mr. Weir were placed on the table, but not in a condition for examination after their long voyage.

STRIKING GERANIUM CUTTINGS IN SPRING.

"AGNES" would feel obliged if Mr. Thomson would give full directions for striking and managing *Geranium* cuttings taken in spring from the plants preserved alive through the winter. Also, if he would mention specially, when he speaks of giving heat, whether it should be bottom heat or that of a common vinery; how far the parent plant can be cut down

without spoiling it; and the treatment to bring it soon into flowering when bedded out. She alludes specially to the *Variiegated* and *Golden Chain* kinds. How soon should the autumn cuttings struck in the open air be brought under glass?

[To strike *Geranium* cuttings in spring, from plants that have been preserved through the winter, with the greatest possible success, the old plants should be put into a house or pit where they can have a temperature of 60° or 65°, about the end of January or beginning of February, to make a month's growth before the cuttings are taken. This is much preferable to taking the cuttings from the old plants while in a comparatively dormant state—first, because root-action is excited, and the old stools break more freely and strongly than if the cuttings were removed while in a dormant state; and second, because the cuttings root more freely after having made a fresh growth than when put in when in a less fresh and growing condition. The early part of March is a good time to put in cuttings in spring. Well-drained cutting-pans, boxes, or eight-inch pots filled up with equal parts sand, loam, and leaf mould sifted through a quarter-inch sieve, are excellent materials for striking *Geraniums* in spring. When the cuttings are put in a watering should be given sufficient to wet the soil through and through, so that it may not be necessary to water frequently. The best place for striking them is in a temperature of 65° to 70° near the glass, and shaded only when the sun is very bright in the middle of the day. Bottom heat is not indispensable, although such sorts as *Golden Chain* and all the variegated section root sooner with a little than without it. They do very well in a vinery or any structure where there is a heat of 65°. When rooted they should be potted off singly into three-inch pots, and kept in heat till the roots reach the sides of the pot at least, then they should be turned into cold frames where they can have the protection of glass, and by the middle of May almost all *Geraniums* make fine plants in this way from spring cuttings. We do not approve of cutting down the old plants too closely; a few leaves should be left to each branch or limb after the cutting is taken from it. They should be kept in heat till they break into fresh growth, and when the growths are an inch or two long they should then be put into a lower temperature. *Golden Chain* and all the variegated sorts succeed very well in this way, and the gorgeously marked *Mrs. Pollock* and *Sunset* are as free as any, and more free than many of the strongest-growing sorts. When any new and scarce sorts are to be multiplied with the greatest possible rapidity it is best not to plant them out in the borders but to plunge them, say in six-inch pots. They can then be lifted in autumn without a check, and forced and propagated from all winter and spring; whereas if planted out and lifted they sustain a check, and do not yield so many cuttings. The autumn-struck cuttings are put under glass about the middle of September, or before there is danger from frost and cold rains. When housed a light place and abundance of air should be given them.—D. T.]

PIT FOR STRAWBERRY FORCING.

I PURPOSE building a pit for forcing Strawberries from about the beginning of February. A common brick flue will pass along the front, across the far end, and return along the back, rising a little all the way, and the furnace considerably lower than the bottom of the flue.

I wish to know whether it would be the best for the success of the Strawberries to place the pots on an open trellis or platform all over the pit about 6 inches or so above the top of the flue, or if it would be better to place rubble about and over the flue, making a nice even surface of gravel all over the pit for the pots to stand upon close to the glass—i. e., so near that the tallest leaves when full grown will not quite touch it. This latter plan would save the expense of a wooden platform, and be very convenient for the pots to stand upon; but the question is, Would it afford sufficient top heat in cold weather, especially at the end farthest from the furnace? and then how troublesome to get at the flues to repair or clean them.

The former plan of the wooden platform of open work would permit the heat to come up freely between the pots

and play among the foliage, as Mr. McEwen speaks of its being so beneficial. When the Strawberries are placed on a shelf at the upper part of the back of a Pine-stove, a little air being constantly admitted at top, there would be plenty of moisture from beneath the platform, arising from the water passing underneath from watering and syringing, and when in blossom and ripening the place would be drier by withholding syringing and being more careful in watering. The pit is to be a narrow one, so that a person pushing down the lights will have full command of the plants without pushing up from the bottom; also to get at those in front. I am not confined for the length of the pit, but I wish it to be just so long that a moderate fire will heat it properly, so that the Strawberries will have sufficient heat at the extreme end, farthest from the furnace.—CLERICUS, Northamptonshire.

[Such a pit as you propose may be from 30 to 40 feet in length, 6 feet wide, from 5 to 5½ feet in height at back, and 2 to 2½ feet in front. Such a pit may be most easily attended to from the front, except the back rows. A less height of pit would do if the flue were sunk a little, and the pit could also be sunk from 12 to 18 inches if there is nothing in front to shade it. All things considered, we would decidedly recommend a sloping moveable wooden stage, the shelves to be about 16 or 18 inches from the glass. This should be made in pieces to suit one or two lights, so as to be moved easily. A stay along the back wall would receive the back, or a brick ledge an inch wide might be left jutting out at the requisite height. The same may be done in the front wall, or the stage could rest on a brick placed over the flue. The shelves, 7 inches wide and pitched in summer, would last a long time. The floor of gravel would not do so well for early forcing; and you would not have heat enough in the atmosphere of the house unless you threw some kind of a chamber over the flue, however rough, with means for letting the heat up. Even then the plan would not answer so well as a stage with air above and below. The expense of such a chamber would be something, and if the gravel floor is made you could use the pit for nothing but low things. Generally clergymen like to make the very most of such a little building. With the stage, you could fill with low things in winter; you could remove the stage and place taller plants in the pit. In summer you could remove the stage, and have a first-rate place for Melons or Cucumbers and ever so many other purposes. In putting in the plants of Strawberries in January and February we would clean the pots, remove a good portion of the old decayed and spotted leaves, freshen the surface, place the pots on the shelves, and water very carefully until the flower-trusses appear. Then the pots may be set in saucers, but the water must never stand in them above the third of an inch. We prefer a thin layer of moss that has been scalded with hot lime water, or a thin turf cut to the size and placed in a barrel and steeped in hot lime water before using. This in both cases is to destroy slugs. As soon as the truss shows you may use weak manure water of different kinds. Commence with a heat of 45°, rising gradually to 55°, and from that to 60° with fire heat until the fruit is swelling, when a little more may be given. At all times, but especially when in bloom, a current of air should pass over them. In bright sun allow 10° to 15° more, with air given early.]

GROWING POTATOES AND GREENS CONJOINTLY.

I AM only too glad to have it in my power to reply to Mr. Bevan Fox's inquiries, and I trust what I write may prove useful to him. I owe him compensation for hours of pleasant reading, and for many ideas gained from time to time from his apicultural essays in this Journal.

Mr. Fox inquires, firstly, "When the trenches between the rows of Potatoes are to be occupied by plants of the Broccoli or Cabbage tribe?"

There is a capital sort of Brussels Sprouts called the Roseberry, which I find very appropriate to be grown in the trenches between the rows of Potatoes. The plants ought to be now ready to prick out from the seed-bed. I do this

in rows across the garden wherever space offers, and place the plants at 6 inches apart. In about three weeks they will have become strong and sturdy, when I transplant them into the trenches at 1 foot 6 inches from each other. Some epicures think this variety too coarse, on account of the French-Walnut size which they attain, but for the parlour table some of smaller size can always be singled out; so for general use and flavour commend me to them. The mere points of their crowns cut off in October are simply delicious. We have been well furnished with a continual supply of sprouts of this variety since that time, and dating from this 25th of April, we shall be furnished with Greens from them a week longer. What plants of them that remained in the trenches at the middle of March, were forked up and laid in by their heels, in order that the ground might be made to undergo its tillage for Potatoes and Sprouts again. Turner's Eclipse Cabbage, Grange's Canliflower, or Walcheren Broccoli, can be grown very easily between the medium tall sorts of Potatoes, such as Daintree's Seedling, and the sooner robust plants of these are planted out in the trenches at 2 feet 6 inches apart the better. Early Turnips should be sown in rows on the site whence the Potatoes are taken up, or Swedes or Yellow Bullock Turnips may be transplanted then and there. The latter is a hardy, well-flavoured Turnip, having a cream-like colour, not so objectionable in appearance on the dining-table as a Swede, and both may be turned to excellent account by being boiled for the pig.

Mr. Fox will not have to complain of the 42-inch distance between the rows if his ground is in tolerable heart. I am a great advocate for pure air, and I allow it to circulate very freely amongst all kinds of vegetable and animal life under my charge.

As a chief means to the end, I will next give precedence to Mr. Fox's questions as to the matter of "seed." Experimentally I am led to conclude that Potatoes reared from whole "sets" produce a greater bulk of crop, and are more able to contend against disease than those raised from the seed which is cut. I always take especial care that the seed which I plant has been grown upon a light soil of a different nature from my own, which may be termed an artificially-made, dark-coloured, gravelly loam, and that the tubers are the progeny from undiseased stools. Coupled with this, I choose middling-sized sets at taking-up time, and since I have been particular in attending to this, I have never experienced anything approaching to a failure of crop. A medium-sized Potato may be termed scarcely ripe when taken from the soil, which is a great recommendation to it for seed. My seed may be said to undergo a perpetual preparation for planting, although giving comparatively little trouble, for as soon as it is taken out of the ground it is laid in the sun for a day or two, to become slightly greened, and it is then disposed of in single layers upon shallow wooden trays, secure from damp and frost, in an underground cellar, having a temperature ranging about 40°. Its dimensions are 9 feet by 18, and it has a fair twilight admitted to it through a glazed aperture, measuring 3 feet by 1.

I take especial care that the first shoots which spring from the sets are not maimed or bruised, and, agreeably to the size of the set, I allow two or three shoots to grow. If an excess of these form, they are rubbed off in their infancy, and I follow up this disbudding process, when, by planting time, the proper number of shoots which were allowed to remain have become robust, sturdy, and strongly attached to the tubers, plainly pointing out the advantage gained over the old enervating "spurting" and cutting method. Nothing is here lost to the Potato: whatever nourishment has gone out of it remains stored up in the hearty young shoots, and the seed is delivered to the soil with all its powers about it, with incipient leaves ready to expand and compete for the light of day, and to begin to exercise their powers immediately. It should be known that each succeeding series of shoots, consequent on disbudding, is weaker than its predecessor, and that, when this is done three or four times, the leaf-buds are destroyed. Who, then, can wonder at the great loss to the crop through the destruction even of the first shoot? But, as I stated above, it is not the loss of the sprout alone, but with it goes a quantity of food intended by nature to nourish the

buds in the act of germination, or until they can cater for themselves. Besides, it is pretty well understood that the upper end of the Potato bears the shoots which bring the heaviest produce, and this end generally buds first, and the consequence is that, instead of two or three original stems, we have in their place a host of sprouts of secondary power; and the result will happen that, instead of a superior produce, there will arrive an inferior sample. But under the system of carefully protecting two or three first shoots these are sure to become the monopolisers, and the result mostly happens that the weaker sprouts will not be able to make growth at all, and the consequence will be a superior weight of an even quality not only for market and personal eating, but for the pig also, which I fancy will prefer and thrive better on a good sample of Potatoes than on bad small ones.

Now, as regards the "best mode of keeping and storing Potatoes." I remember once reading about a man who made a wager that he would get a hundred receipts for the tooth-ache within an hour. He took his stand upon London Bridge and began distorting his face and uttering piercing cries, and truly receipts poured in upon him from all sides. He won easily. So with our Potatoes. I could go on giving Mr. Fox receipts for storing them, such as they have been related to me, and such as I have read of, almost to infinity, and all according to their detailers, "the best." But I will simply confine myself to three plans which I have practised according to circumstances during thirty years. The first I was under the necessity of adopting for part of our crop in Shropshire, previous to 1845, where I cultivated the Potato on a larger scale than I do now—viz., fix on a dry and rather sloping situation, mark out a parallelogram having a breadth of 4 feet for its base, and when storing the tubers, which should be in a dry state, narrow them gradually to an apex. Make a trench around them by digging out sufficient soil to form a layer over the Potatoes quite 6 inches thick, and finish the mound off by thatching it with straw or Fern-fronds to prevent danger from wet or frosts. Allow the eaves of the thatch to hang down into the trenches in order to carry the drip water well away and leave the tubers high and dry. Never place the straw next to the Potatoes, as it would be apt to rot them and impart a musty flavour. I do not approve of the pitting system, however, though I know for want of convenience numbers of people must adopt it; but I can confidently say I lost more tubers through that off-hand system before the advent of the disease than I have ever done since, disease included. When a substantial shed or other small outhouse is at command, such an one as Mr. Fox says he has, sufficiently closed in to keep out all frosts and wet, and to be made dark at pleasure, decidedly give that place a preference, and use dry sand or finely-sifted cinder-ashes, either of these, placing it an inch or two in thickness, alternately with layers of the tubers; and when this is done all I can say is, one may depend upon having sound, first-rate Potatoes to sell or otherwise till late in the spring; the result will well repay the extra care and labour.—UPWARDS AND ONWARDS.

(To be continued.)

WORK FOR THE WEEK.

KITCHEN GARDEN.

Now that most of the seeds of weeds lying near the surface of the soil have germinated, every part of the garden should have a deep hoeing in dry weather; the cleanliness of the garden for the season will depend in a great measure on a complete destruction of all seedling weeds at this time. *Broccoli*—the Cape—and *Cauliflower* may still be sown for a late supply, but there must be no delay. Continue to plant out *Cauliflowers* and *Cabbages* from the nursery-beds as they become large enough, and keep the earth well stirred about those advancing. Look out for slugs, they are very numerous this season; the frequent application of quicklime is the most effectual plan for their destruction. *Celery*, attend well to advancing crops; stir the surface of the soil in which it is pricked out, and give occasional waterings with liquid manure. *Cucumbers*, towards the end of the week get a ridge prepared for turning out these, and also Vegetable

Marrows, under hand-glasses. There is no better way than the usual one of throwing out a trench 3½ feet wide, and filling it with fermenting materials, such as leaves, dung, and short grass, and returning the soil; but if this is not of a light nature there had better be some prepared light compost laid where the glasses are placed. *Capsicums*, these, as also *Chilis*, *Basil*, and *Tomatoes*, should now be undergoing the process of hardening previous to planting out. *Dwarf Kidney Beans*, about half those that have been forwarded in heat may now be transplanted in light rich soil, and means must be at hand to cover them up at night whenever there is any appearance of frost. The other half may be kept in a cold frame or other shallow place till about the 20th of the month, after which we may consider the danger from frost over. *Peas*, attend to former directions respecting these, which are growing unusually strong and healthy this season, and will require some attention in keeping the surface soil well loosened to maintain them in a free-growing state. *Radishes*, sow every ten days. A few of the earliest should be left to seed for pods for pickling.

FLOWER GARDEN.

Now that a change has taken place in the weather, every exertion should be made in filling up the flower-garden beds and clumps, intended for the summer and autumn display, with all possible dispatch; premising that the plants intended for each bed have been previously determined on and hardened-off, no great difficulty will be felt in filling up the beds. If it is wished to have an early display of flowers the plants will require to be planted more thickly than when a late display is required. To judge from the modern arrangement in planting flower gardens, the principal object is to produce a striking effect by employing plants only of a decided colour, principally red, blue, yellow, and white. When the colours are well contrasted this plan is very effective, particularly when viewed from a distance, and in situations where the beds are not numerous, and where there is a considerable breadth of either grass or gravel to overpower. But a repetition, however brilliant, is seldom so pleasing on a close examination as where variety, both in form and colour, has been called in, and where the gradations into which the primary colours run have been arranged in accordance with the rules (which I endeavoured to explain in THE JOURNAL OF HORTICULTURE last year) governing their distribution. There is now no want of colour to effect this, as nearly every class of bedding-out plants presents sufficient variety for this purpose. See that the standard *Roses* are properly secured against high winds, and the caterpillar and green fly. Those which were budded last season to be again gone over, and all the buds and suckers which proceed from the stock destroyed. The inserted buds which have made shoots to be stopped back to three joints to cause them to take a firmer hold of the stock and to increase the size of the head. From those which are intended for budding upon this season rub off all the buds with the exception of those well-placed at the top of the stock.

FRUIT GARDEN.

The prolonged duration of fine sunshiny weather has produced a marvellous and delightful change in the face of nature. The healthy and vigorous development assumed by vegetation under these circumstances, combined with the fine autumn of last year, may reasonably induce us to hope for abundant crops of all sorts of fruits, more especially as we never recollect to have seen fruit blossom in such a bold, healthy, and promising condition. The moderate dis-budding of *Peaches*, *Apricots*, &c., or rather thinning the shoots, must still be persevered in; but they must now be removed with a sharp knife, and not broken off, as the shoots are acquiring consistency. Some of the strongest shoots intended to remain to be tacked-in. Stop the strongest shoots of *Vines* at a joint beyond the fruit, and commence nailing-in. *Apricots* being generally used for tarts, to be left until they are large enough for that purpose.

GREENHOUSE AND CONSERVATORY.

Liberal shifts will now be required for growing specimens of choice things. The *Pelargoniums* will now be showing bloom. As soon as this occurs, unless of gross habit, a little

weak and clear manure water may be given. Such may also be applied to the Azaleas making their wood, also to the Camellias. Get a reserve stock of Pelargoniums, Calceolarias, Heliotropes, Verbenas, Salvias, &c., potted-off in three-inch pots, and kept by themselves; such will serve to keep up a continual gaiety through the latter part of the summer and autumn. Fuchsias for late blooming must not be kept too warm, but should be placed in a moist shady house, where they will grow much more freely than in a high temperature. As New Holland plants go out of bloom pick-off their seed-pods, cut back the shoots, and arrange them in the form most favourable to secure compact growth, place them in an airy part of the greenhouse until they fairly start into growth. When the buds have fairly started will be the proper time for shifting such as require more pot room; to be then kept rather close for a fortnight to encourage a free root-action and the healthy development of the buds.

STOVE.

As regards the inmates of this house thorough cleanliness, free ventilation, plenty of atmospheric moisture, and slight shading in bright sunshine, are at present the chief requisites. Have an eye to the propagation of stock for succession or winter flowering in due time. Take care to secure cuttings of Brugmansias, Clerodendrons, Erythrinas, Poinsettias, Eranthemums, and of those useful winter-flowering plants Euphorbia jacquiniiflora and Gesnera bulbosa. Achimenes should now be placed where more air can be given; stake-out neatly as the shoots advance. Gloxinias require a partially-shaded situation and moist heat. Gesneras may be treated in the same way, with the addition of more light. No means should be neglected to encourage a fine growth at this period in Orchids in order to get their pseudo-bulbs firm, well nourished, and well ripened betimes. Centradenias now exhausted with flowering should be shaken out of their pots and repotted. Fibrous loam and fibrous heath soil, with coarse sand, make an excellent compost for them.

W. KEANE.

DOINGS OF THE LAST WEEK.

KITCHEN GARDEN.

THE dripping weather of the week has left little to do in this department, beyond sowing Broad Beans in the beginning of the week. Of these we will make only two more sowings, as they do little good when planted or sown late. Have any of our readers tried these Beans, when young, cut up and boiled like Dwarf Kidney Beans? If not, there is what some consider a great luxury in store for them. When so used, the beans inside should not be larger than peas. Pricked out Cauliflower, Celery, &c.; and hunted for slugs among young plants. Went over most of the walks in the kitchen garden, weeding, hoeing, and preparing for soon rolling them down, and keeping them smooth and nice for the season. To help this, will cut out the alleys in the fruit-borders, so as to make them nice and straight, and then give them a thin covering of sawdust, that the alleys may be used by the workmen instead of the walks. A scraper at each corner is very useful for keeping walks nice and clean. Two things are very annoying to a gardener who likes to see his walks in good order. The first is seeing lumps of earth on the gravel, carelessly brought out of the quarters on the boots of the workmen; the other is seeing a soft place marked as if a dozen people had been dancing over it. Walks, when carefully kept, should be studiously used as walks; and in that case it would be money saved to give an extra sum to the labourers, so as to dispense with nails in their boots. In damp weather every nail mark is apt to show, even when a plain sole would leave no impression whatever. We shall never forget seeing one of the greatest gardeners of the age almost mad about his gravel. A large square of gravel was in front of the entrance to the mansion; only a small part was ever used by horses or carriages. Whenever used, the marks were taken out the last thing at night or the first thing in the morning. The whole piece had been beautifully cleaned and levelled, and, after a heavy shower, had been well rolled, so that it was almost as smooth and as shining as a polished mahogany table. Some visitors came on horseback, unattended by grooms, and some in-door servants were called to hold the horses. Tired of the un-

exciting occupation, they resolved to mount and exercise the horses; and, instead of doing this on the carriage road, or even in the park, they must, not from any evil purpose, but from sheer thoughtlessness, have their hard trot and gallop on this fine-rolled gravel, leaving a torn-up mass behind them, which could not have been worse if a hundred wild horses from an American prairie had stamped over it at full gallop. Of course a proprietor may ride or drive, or have a carriage chair over his own walks, as he must pay for putting them right again, but no other person ought to take such a liberty without previous permission. If walks are very weedy, the centres may be salted, but in a kitchen garden it is not safe to go near the Box edging; and if the edgings are of ornamental tiles, or stone, it would scarcely be more safe, as the salt, in time, will rise through such edgings, and crumble them to a certainty. We have more than once seen the stone balustrading of gravel terraces crumbling and wasting, because salt had been used freely to keep the gravel without a weed. We may also mention, though salt water is pretty good, and soda better, for cleaning stone pavement or flooring from green deposit or mildew-like surface, that if used at all freely the stones will get soft and wear away in films, and, in close weather, they will yield an efflorescence of the salt on their surface. There are few things so safe for cleansing as plenty of manual labour.

The general work being of a routine nature, the chief business has been making up a hotbed for a couple of two-light frames for Cucumbers. The plants in the first four lights have done and are doing beautifully; but we must not say much, for they did well last year until the middle of July, after which we had less or more of disease all the autumn in Cucumbers, Vegetable Marrows, and all that tribe, except Melons; and as it is best always to confess failure, we found we were powerless in subduing the disease except by fresh soil and frequent planting. But about the bed just named there could scarcely be more unpromising materials. These were the remains of a bed for a two-light box, used for late Melons last autumn, and for the earliest Radishes, and a sprinkling of Lettuces afterwards, a couple of good loads of long dry litter from the stables from which the droppings had been shaken for Mushrooms, a little half-worked dung, and a few of last winter's tree leaves. The old bed was first cleared out and all the very rotten removed, leaving a nice little piece of half-decayed material. With such substances, instead of waiting and working, we have made the bed at once, thus—dry litter and wet grass, and old hotbed stuff alternately, say 3 inches of each, in successive layers, until a depth of 2 feet was attained. We were certain that the grass would make all heat, and that the moisture from it and the half-decayed matter would be quite sufficient to set the dry litter fermenting freely. Over this we placed 6 inches of half-wrought dung and leaves, and then 6 inches of sweet leaves, leaving the trench in the centre for the soil. Previous experience enables us to say that we have no doubt of such a bed giving a fair and lasting heat for what is required. Of course the steam from the green grass would make havoc of the plants if it came in contact with them, but it must not do so. With short grass in a heap we never feel at a loss for a little bottom heat provided the grass is buried far enough down and the heat must pass through a foot of some sweet and healthy substance. Had we worked the little material we could command in the usual way, we would not have had anything like enough for two lights instead of four. Such grass is also useful for packing round frames, especially if there is some litter above it; but care must be taken that no steam from such lining pass inside the box. On this account we would rather have shallow frames than deeper ones with joints in the wood. Pulled some laurel boughs through old hurdles, and set them against the bed made, to prevent the wind acting too freely upon it. We are thus minute to suit gardeners with little means; and for their encouragement we would say in conclusion that they are likely to be more successful with a simple hotbed than if they had heat from a flue or a hot-water pipe. Easy as it seems, more practice is necessary for managing such heating than the old plan of hotbeds.

FRUIT GARDEN.

Planted out more Strawberry plants from pots where the

ground was dry enough. All such pots are wanted at this season as soon as they are empty. Found that the Strawberry plants, taken up and potted as mentioned lately, and plunged in a bed of tree leaves out of doors, have now filled the pot with fine fresh roots, whilst the large trusses are swelling but not yet opening their blooms. These now may go to any place that we can spare for them. We have managed to get rid of half the upper shelf in the Peach-house, which will let more light to the back wall. In a week or so the other half will be gathered, and that, besides the additional light to the trees, will enable us to attend to the three shelves that will then be left without the assistance of a ladder. As soon as we can do so, we will next thin, and then remove altogether the shelf that gives the next greatest shade; but that will not be just yet. Many schemes must be resorted to to keep up a constant daily supply after the vineries become too dark to be suitable. We may here allude to several matters. First, owing to getting runners late last season, our plants, with single plants in a pot, have done best when grown in 40-sized pots. Second, where time can be given, it is best to remove the smaller fruit, and even the blossoms, after six or seven are set and swelling. Where Strawberry ices are used, the thinning is of less consequence, as the smaller ones would do for that purpose. Third, even under the best treatment it is not often that every plant will come up to your expectations. We recollect some time ago, a gentleman being astonished at our reply when, on looking at a fine row of seventy plants in full fruit, he said, "Of course every pot you put on that shelf has succeeded in this admirable manner; not a bad one among them." We replied, "Oh no, as far as we recollect, some five or six per cent. of that shelf were weeded out, because they were not worth keeping." Aspiring beginners may as well know that the most experienced are yet very far from perfection. They should have more courage to persevere, when they know the most practised have their failures. The gentleman replied, "Well, in my little house I have a few plants almost, if not quite, as good as yours; but then they are mixed with those that have little or nothing, and that spoils their appearance." "Exactly so; but why keep them? Plants of the same age, the same sort, and the same kind, will throw up their trusses about the same time. If they show no signs of doing so, it is waste space, waste time and labour to keep them for nothing." This leads us, lastly, to notice a rather singular characteristic in the young gardener which has come under our observation for a good number of years, as respects these pots of forced Strawberries; and that is extreme reluctance to move a senseless pot out of its place when once it has been set there. Even the playfully threatening to launch a pot, like a bullet, at their heads, will not quite conquer the seeming hope and anticipation that the flowerless plant may become covered with bloom if it only have a little more time. We can honestly say that we have had rows in which every pot first placed was good; but these were exceptions rather than the rule. The earlier the forcing, the greater the per-centage of failures we generally make allowance for.

We find our orchard-house will give us a great help with Strawberries, keeping up the connection between the forcing-houses and the open air.

The dull days gave us an opportunity of pruning and tying in the Peach-house, disbudding and stopping, and thinning in the orchard-house, regulating late Vines, thinning Grapes in second vinery, &c. Very small Grapes make good tarts, especially if a few Gooseberries go with them. They should be used when the size of duck shot; when as large as peas, or larger, they need too much sugar. Peaches less than Walnuts, as well as Apricots, also make nice tarts; but will any one tell us what young Nectarines from the size of horse beans, and onwards, are good for? Regulated, stopped, and watered Figs, and uncovered the Fig trees out of doors.

ORNAMENTAL DEPARTMENT.

Chiefly mowing when fair above. The grass has been made use of, as already detailed. A portion was also put round the box of Verbena cuttings referred to last week, as from there being no sun there has been less heat than we expected. They are, however, looking well, and though not by any means all rooted, we find a good many of the tiny

bits have made roots in the seven days. In wet days the chief work was pot-washing, tally-making, stick-pointing, and potting, and pricking off young plants. We shall as soon as fair turn out a great number of plants into Celery trenches, that we may get the pots and the room for things more tender.—R. F.

COVENT GARDEN MARKET.—MAY 7.

The market is now very well supplied, and trade is very brisk. Pines are sufficient for the demand, and English Grapes plentiful. Of forced Strawberries there is a fair supply, and of very good quality. Good forced Peaches have begun to make their appearance; also a few May Duke Cherries from the continent. Pears are now over, and good dessert Apples very scarce. Large importations continue to arrive from the continent, and include Lettuce and other salading, Asparagus, Peas, and Potatoes. Spring Cabbages are now plentiful, notwithstanding that large quantities are sent off to the great towns in the north.

FRUIT.

	s.	d.	s.	d.		s.	d.	s.	d.
Apples.....	½	sieve	2	6	to 4	0	0	0	0
Apricots.....	doz.	0	0	0	0	0	0	0	0
Figs.....	doz.	0	0	0	0	0	0	0	0
Filberts & Nuts	100 lbs.	0	0	0	0	0	0	0	0
Grapes, Hothouse.....	lb.	8	0	14	0	0	0	0	0
Foreign.....	2	0	4	0	0	0	0	0	0
Muscats.....	0	0	0	0	0	0	0	0	0
Lemons.....	100	4	0	10	0	0	0	0	0
Melons.....	each	0	0	0	0	0	0	0	0
Nectarines.....	doz.	8	0	0	0	0	0	0	0
Oranges.....	100	8	0	14	0	0	0	0	0
Peaches.....	doz.	30	0	40	0	0	0	0	0
Pears.....	bush.	0	0	0	0	0	0	0	0
dessert.....	doz.	0	0	0	0	0	0	0	0
Pine Apples.....	lb.	6	0	10	0	0	0	0	0
Pomegranates.....	each	0	0	0	0	0	0	0	0
Strawberries.....	oz.	0	6	1	6	0	0	0	0
Walnuts.....	bush.	14	0	20	0	0	0	0	0

VEGETABLES.

	s.	d.	s.	d.		s.	d.	s.	d.
Asparagus.....	bundle	4	0	to 8	0	0	0	0	0
Beans, Broad.....	bush.	0	0	0	0	0	0	0	0
Kidney.....	100	2	0	3	0	0	0	0	0
Beet, Red.....	doz.	1	0	1	6	0	0	0	0
Broccoli.....	bundle	0	9	2	0	0	0	0	0
Brussels Sprouts.....	½ sieve	0	0	0	0	0	0	0	0
Cabbage.....	doz.	1	0	1	0	0	0	0	0
Capsicums.....	100	0	0	0	0	0	0	0	0
Carrots.....	hunch	0	6	0	0	0	0	0	0
Cauliflower.....	doz.	4	0	8	0	0	0	0	0
Celery.....	bundle	2	0	3	0	0	0	0	0
Cucumbers.....	each	1	0	2	6	0	0	0	0
Endive.....	score	1	3	2	6	0	0	0	0
Fennel.....	bunch	0	3	0	0	0	0	0	0
Garlic and Shallots, lb.	0	8	0	0	0	0	0	0	0
Herbs.....	bunch	0	3	0	0	0	0	0	0
Horseradish.....	bundle	1	6	4	0	0	0	0	0
Leeks.....	bunch	0	4	0	0	0	0	0	0
Lettuce.....	doz.	1	0	2	0	0	0	0	0
Mushrooms.....	pottle	1	0	2	0	0	0	0	0
Mustd. & Cress, punnet	0	2	0	4	0	0	0	0	0
Onions.....	bush.	4	0	7	0	0	0	0	0
pickling.....	quart	0	6	0	8	0	0	0	0
Parsley.....	½ sieve	2	0	3	6	0	0	0	0
Parsnips.....	doz.	0	9	1	6	0	0	0	0
Peas.....	quart	4	0	8	0	0	0	0	0
Potatoes.....	sack	6	0	9	0	0	0	0	0
Radishes doz. bunches	0	6	0	9	0	0	0	0	0
Turnip.....	0	9	1	6	0	0	0	0	0
Rhubarb.....	0	4	1	0	0	0	0	0	0
Savoy.....	doz.	0	0	0	0	0	0	0	0
Sea-kale.....	basket	1	6	2	6	0	0	0	0
Spinach.....	sieve	2	6	4	0	0	0	0	0
Turnips.....	bunch	0	6	0	8	0	0	0	0

TRADE CATALOGUES RECEIVED.

Sutton & Sons, Reading.—Priced List of Farm and Flower Garden Seeds.

Dray, Taylor, & Co., 4, Adelaide Place, London Bridge.—Catalogue of Horticultural Implements.

TO CORRESPONDENTS.

FLOWER GARDEN PLAN.—Messrs. Major & Son, of Knosthorpe, near Leeds, have obligingly written to us as follows:—"Your lady correspondent, 'MAY,' in her close imitation of our first design for a flower garden in a work of ours recently published, entitled 'The Ladies' Assistant in the Formation of their Flower Gardens,' and whose plan appears in THE JOURNAL OF HORTICULTURE, April 26th, 1861, has not fully attended to the directions there given as to the dimensions of the scroll-beds. 2 feet wide is much too narrow. We recommend 3 feet 6 inches, which we think quite narrow enough for three rows of plants—i. e. (as you suggest), a strong centre line of one colour, bordered on each side with another colour; and, in addition, we recommend that the nob-ends of all the scroll-beds should form a circle of some distinct colour, and that these circles should be of one uniform colour. If your lady correspondent has not already formed her garden, perhaps these few hints may be of service to her.

COCA-NUT FIBRE REFUSE FOR FERNS (E. M.).—Mix the powdery portion with the soil in the same proportion that you would add to it peat. We find Ferns grow luxuriantly in the mixture.

IMAGE FOR FOUNTAIN (I. M. O.).—Any local statuary could carve one. In the Marylebone and City Roads, London, there are several such statuarys, and they have figures of all descriptions ready sculptured.

PLANTS FOR HOTBED OVER HOT-WATER PIPES (C. D. E.).—We do not know what kind of plant would not do well in a little bottom heat, but if we understand you aright you wish for some plants of annual growth to render the bed gay during the summer. If so, you may grow Cockscombs (Celosias), Sensitive Plants, Thunbergias, Balsams, Amaranthus melancholicus ruber, A. bicolor and tricolor, Globe Amaranths, and any tender annuals if there is light sufficient. You may grow Cucumbers or Melons if you choose, either in pots or planted out.

VINERY GLASS AND WIRE (H. W.).—Squares of 21-ounce glass, 18½ inches by 15 inches are not too large for a vinery, but you must take advantage of the great sun heat these sizes will give you to provide extra ventilation, which will be all the better for your Vines than if more wood and less-sized glass were employed. We have not found anything better than quarter-inch iron wire, well painted, for fixing to the rafters to train the Vines to. Galvanised wire is as good, if not better, but common iron wire will do well if kept well painted.

APHIS DESTROYING (*Wyeside*).—We do not know of a more efficacious remedy for the attacks of aphid than filling the house with tobacco smoke, but there is little gained by employing it unless the house be densely filled with it: we never found it fail when the smoke could be confined about the plant. If you fill your house with tobacco smoke when the trees are quite dry, so that you cannot see the trees within the house, and syringe them early in the morning with Laurel water, made by bruising a large handful of Laurel leaves and placing them for twenty-four hours in 3 gallons of rain water, you will find this answer your purpose. We do not know of a better remedy than this, nor are we acquainted with Mr. Rivers' method of freeing his large houses of this plague. We think he would gladly answer any inquiries. Rubbing the leaves infested with aphid, and crushing the insects between the finger and thumb is certainly a good remedy. A house may be kept pretty clear by this process, but it is tedious, and the trees require to be well washed with a syringe after each operation to clear the leaves of the filth.

HOYA IMPERIALIS (*W. W.*).—It is most decidedly a stove plant, but may be placed in a warm greenhouse during the winter if kept dry at that season. Your plants should now be starting into growth, and ought to do well in your vinery at a temperature of 70°; but we fear from your description of them that they are dead. If you have a house with a little bottom heat and a place to plunge the pots in, the plants if alive would soon grow; if they did not, you might safely throw them away.

CERASTIUM TOMENTOSUM and **C. BIEBERSTEINI CULTURE** (*Idem*).—We have not experienced any difficulty in raising these plants from seed, and all we do is to sow in pans filled with light soil, and cover the seeds lightly with fine soil. The pans are then set in a cold frame, which is kept moist and close until the plants appear, when air is abundantly admitted, and they are watered lightly until they gain strength. When sufficiently strong they are pricked out in any light in the open garden, and beyond a watering or two after pricking out do not require any further attention. The great difficulty we experience with these plants is to keep them within reasonable limits, for they extend so much in light soils as to be weeds. Get a plant or two and grow them in a light soil in the open garden, divide the roots into as many plants as possible in the following April, and in a year or two you will have enough to plant an acre. We think the seed you have sown has not been good, or it may have been buried too deeply in the soil and kept too wet, whereas the *Cerastium* is a rock plant or alpine.

DIELYTRA CUCULLARIA, &c. (*A. R.*).—Mr. Abbey informs us that he has bloomed this plant, and found no difficulty in doing so. The plants grew in an open situation in an herbaceous border, the soil being composed of sandy peat, the border being originally intended for hardy Heaths. A little loam was added to it, and in this the herbaceous plants were grown, and amongst them the plant in question. It, with the other plants, received no attention beyond that of weeding in summer, and forking the border neatly over in spring. Early in autumn the border was covered with an inch or two of the previous year's leaves, which were partially decomposed, and yet afforded a sort of protection to the crowns of the plants. This was neatly forked into the border the April following. The plant produced its peculiar-shaped flowers in June, and increased very fast, but this did not interfere with its blooming freely. The plant grew so fast that it was found necessary to divide it, and some of the pieces were planted on a rockery close by in light loamy soil, and these flowered equally well with that in the border. He mentions a peculiarity about the border which may be the key of the whole affair. The site of the border was originally a sunk fence, and this was filled in with the *débris* of some old buildings, and on this was placed the sandy peat a foot deep, to which a little turfy loam was afterwards added. The plants were therefore kept free from stagnant water at the root, and the well-drained condition of the border kept it warmer in winter, and for this reason plants of doubtful hardiness were planted in it.

NORTH AMERICAN CYRIPEDIUMS (*Idem*).—They should be taken up from their native habitats when at rest, with a little of the old soil about them, and they travel best in a box tightly packed in sawdust. The soil about the roots (if any) should be dry, and the sawdust dry also, or the roots are apt to decay owing to the moisture. Moss when dry is also a good material to pack them in, and so is chaff, the main point being to pack them so that the roots will not move about in the boxes and so get bruised, or they are certain to decay. A white variety of *Viola canina* or Dog Violet is certainly uncommon. We have had them very pale—closely approaching white when grown under the shade of trees in poor light soil, but we never heard of a pure white variety before. We presume the flower is inodorous. If scented, it will be, we should imagine, a pretty little acquisition; in any case it will be desirable on account of its novelty. The painting of chalk and milk recommended for shading, will not injure your plants if it be washed off into a tank; but any doubts on this head may be removed by putting the paint on inside the house on the glass.

AMARANTHUS MELANCHOLICUS RUDEI CULTURE (*A Lady*).—Your strong seedlings should be potted singly into 60-sized pots in a compost of light turfy loam two-thirds, leaf mould one-third, with a liberal admixture of sharp sand. They should then be gently watered and placed in a vinery at work, or any house or structure with a gentle heat. They will require to be kept rather close for a few days until they become rooted, when air should be admitted on all favourable occasions, and water given as may be necessary. Care should be taken not to let them suffer from the want of water, otherwise the lower leaves turn yellow or fall, and the plants are then ugly. A wet condition of the soil on the other hand is equally baneful, and is due to too copious waterings or an imperfect drainage. As the plants advance in growth they should be potted into 32-sized pots, and placed in a frame or warm situation in the greenhouse, and near the glass, so that the colour of the leaves may be brought out. In either situation they should be kept moderately supplied with water, and be sht up early; if in a frame, previously bedew them overhead, thereby affording a nice atmosphere in which no plant with which we are acquainted will not delight. If this treatment be persevered in they will be fine plants by the beginning of June, when some of the best should be shifted into 18-sized pots and be removed to the greenhouse, where they require abundance of light and copious watering, but in other respects no more attention than is accorded to greenhouse annuals in general. Those remaining in the frame should be gradually hardened off, and may then be employed for decorating the flower garden. Their chance of thriving will be better if they are planted out when the temperature of the ground has considerably increased, than if they were planted out earlier in the season.

GARDENER'S COTTAGES (*J. W. G.*).—We cannot provide plans for these. There are many works on the subject, from which a choice might be made.

FLOWER GARDEN PLAN (*C. H. J.*).—The successful "PATELIN," page 334, can know but little of the pleasures of answering inquiries when he thinks they must be so troublesome; and must have also forgotten that the works from which he derives his information would have been much less satisfactory but for the many inquiries which are made from time to time. We think, however, it is perfectly fair that correspondents, editors, and coadjutors should divide the matter fairly between them. In other words, whilst the latter do their best to meet the wishes of their correspondents, these correspondents should not ask for the time and labour in looking out for dates, &c., which they can accomplish themselves, and should so manage it as to lessen the trouble involved as much as possible. For example, our correspondent, "C. H. J.," gives us a sheet of note paper—the first page closely filled with the generalities of a flower garden, and the fourth page as closely filled with the proposed planting of some twenty-seven beds of that flower garden. The inside, or the second and third pages of the sheet, are occupied with a very rough sketch, in pencil, of that flower garden, which seems divided into something like four quarters, two of these quarters being on gravel and two on grass. Now, every time we turn over the leaf, to note what a certain bed is filled with, we are apt to forget what another bed near it was filled with; and, therefore, thoroughly to see ourselves the proposed system of planting, so as to be able to give an unbiased opinion of praise or the reverse, we would require to write over again for ourselves the whole of the fourth page, so as to keep it before us whilst analysing the plans on the third and the fourth pages. Now, this our correspondent should have done for us. Besides having a fountain in the centre, and cross and transverse walks, the four divisions of the garden seem to have nothing in common; for, though two divisions are on grass, and two on gravel, there is little or no sameness in the laying out of the quarters. Under such circumstances, the simplest mode of planting would be to make each quarter a distinct parterre in itself, and the side borders might either contrast or pair with the border or the other quarter, with the dividing walk between them. We presume that this has been the idea of "C. H. J.," and we think it is very successfully carried out. The difficulty of doing it in any other way will at once be seen, if you divide a square piece of paper into four squares, and then make the design in each quarter as different as possible from all the rest. We have often admired the inventive and artistic genius of our friend Mr. Robson, and perhaps never more so than when looking at the beautiful tracery at page 332. We could fancy how we would plant such a figure, and what we would choose as the ground colour. We could fancy taking two transverse lines through it, and yet the unity of the plan and the uniformity of the planting be untouched; but only take two transverse lines + through that oval, and make the plan of each quarter as different as possible from the other three, and then, we think, it would puzzle even Mr. Robson to please himself in the planting of it for summer. Of course the plan at 332 is better fitted for mere colouring in winter, than for planting in summer; but its uniform beauty has supplied us with an argument why our correspondent will not easily satisfy himself with his arrangements, when his four distinct divisions come to be looked at as a whole. Just to show that, notwithstanding the difficulty, we have really examined his proposed arrangements, we shall take the first quarter, which has a border next the dividing walk, proposed to be filled with Purple King and edged with *Cerastium*, which will look well. This quarter is on grass. Besides the border there are 2 4 five clumps, one in the centre, and four round it; the centre, 1, to be filled with Tom Thumb, edged with *Lobelia* (blue); 2 and 3, Flower of the Day, edged with *Perilla*; 4 and 5, Christine, edged with Brilliant. Now, we have no objection 5 3 whatever to find with this arrangement; but as the ground-work is green grass, something bright or white will tell best next to it. The *Lobelia* for the centre bed will be too low for the *Perilla*, unless the latter be well cut, and also for the *Geraniums*. With the same materials, what would you think of the following?—1, Tom Thumb, with broad band of Flower of the Day; 2, 3, *Perilla* and Christine; 4, 5, Purple King Verbena and Brilliant *Geranium*. A little yellow would lighten up the figure; and two or three plants of different shades might go in the centre of these four beds. There might be no end to the combinations. The *Lobelia* might be more freely used in the quarter above, on gravel. The only fault we find with that, is that there is no match bed to it, though seemingly plenty of room for it; and in border 13 (5 feet wide), you seem to have seven rows, whilst of such strong-growing things five rows ought to be sufficient. On the whole, considering your difficulties, we think you are making the most of your materials.

BOOKS FOR A GARDENER'S LIBRARY (*A Subscriber*).—The books for a gardener's library in a gentleman's establishment should contain "McIntosh's Book of the Garden," "Thompson's Gardeners' Assistant," "The Cottage Gardeners' Dictionary," "London's Encyclopedia of Plants," "Johnson's Science and Practice of Gardening," and "Hogg's Vegetable Kingdom;" "The Journal of Horticulture" in weekly numbers, "The Florist and Pomologist" monthly, and "The Gardeners' Year Book" annually.

LARGEST WELLINGTONIA GIGANTEA.—Could you, or any of your correspondents, inform me of the size, height, and circumference of the largest *Wellingtonia gigantea* at present growing in England, and who is the possessor of it?—W. BILL.—[This is rather a wide question; but any one knowing where a fine specimen is growing, will oblige us by furnishing the relative particulars wished for.]

INSECTS (*A Subscriber*).—The grubs which have destroyed your Strawberry-bed are the larvae of the common Daddy long-legs, *Tipula clarea*. Watering the earth round the roots of the plants with gas-tar water, or a decoction of quassa, may be serviceable by driving the grubs away, but the best remedy is to kill all the flies when they appear in the winged state.—W.

PEACH-HOUSE BUILDING (*A Constant Subscriber*).—Your proposed arrangements will do very well, only an eight-inch smoke-funnel will be better than a six-inch. You will have heat enough to commence forcing in January or February. We would use your pure loam and no dung for the borders; you can give what strength you want by top-dressings and manure-waterings. For trips, smoke with tobacco, syringe well, and keep a moist atmosphere. You must present the smoke cool, and very likely you may have frequently to repeat the dose. If the plants are small, wash each leaf with a sponge and soap water. Much obliged for confirming the efficacy of Furze in preventing caterpillars on Gooseberry trees.

GAS TAR ON HOT-WATER PIPES (*H. P.*).—We know of no other means but scraping off the tar. Coal tar is the worst application for such a purpose.

PELARGONIUMS BLOOMING PREMATURELY (*A Lady Gardener*).—We should think that they have been over-potted, and in rather rich soil. Give the succession lot no more water than they absolutely require.

DISEASED CUCUMBERS (*N.*).—1, The white spots of mildew may be cured by dusting the places with fine flowers of sulphur from a pepper-box, washing the walls with sulphur and lime, with a little soot, to prevent its being too white, and giving more air and a drier atmosphere. If the spot is brownish, it is the spot disease, and as your plants are young, the best thing would be to get rid of them and plant afresh. 2, Such appearances as the young Cucumbers without stalks, are frequently caused by too much and too little heat at the roots. If the hot-water tank is covered with iron or slate, there should be 6 inches of rough rubble at least between the cover and the soil. Over-heating and over-drying roots under such circumstances often does great mischief. It is a good plan to have simple contrivances for throwing moisture among the rubble on the tank-cover. If there is no speedy change, we would certainly remove the plants and use fresh, with fresh soil, after thoroughly cleaning the house.

FLOWER-BED PLANTING (*A Lady Subscriber*).—Of the plans, we consider 1 and 2 preferable to No. 3. In 1, if the eight rays were filled with Perilla, we would make the central circle a strong-growing yellow Calceolaria. The eight beds might then be filled with a plain-leaved and a white variegated-leaved Geranium, in alternate beds, with the edging as decided on. Supposing you put Fuchsias in the centre, then we would alternate the beds with yellow and white-leaved Geraniums, and run a ring of Lobelia inside of the Cerastium. We like No. 2 best, but that is a mere matter of individual taste. The same remarks will apply to the arrangement. It would be as well if the Lobelia angles went right up to the circle. The plants there must be strong, so as to be as high as the Geranium. Purple King Verbena would be better for height, and come in as well with the Geraniums. You might then spot the Cerastium-border with blue. In fig. 4, Defiance Verbena is too strong to be next the Cerastium. We would substitute Purple King; thus—Cerastium, Purple King, Defiance, Mrs. Holford, pink Verbena, &c.

FLOWER GARDEN PLAN (*R. H. D.*).—We do not think your group will look well. 2, 3, 4, 5, being figures of an artistic shape, will not agree with a plain oval for a centre, as 1. We would much rather have a figure in the centre, the same as the other four. Then, as a whole, if you make the centre scarlet, and the other four figures, some of one and others of two colours, the centre will rob the others, and there will be a want of unity in the arrangement. Thus, if you had one colour to each bed we would propose—1, White; 2, Scarlet; 3, Blue; 4, Purple; 5, Yellow. Did we decide on two colours, and cross planting, we would fill 1 with centre of Scarlet Geraniums, as you propose, and a broadish band of white—as Verbena, Variegated Alyssum, or Cineraria maritima, &c. 2 and 5 we would centre with lilac, or greyish Verbenas or Heliotropes, and surround with scarlet Verbenas. 3 and 4 we would centre with yellow Calceolaria, and surround with Purple King Verbena. The last, or the edging and crossing plan, would perhaps be the best.

MELON-HOUSE (*An Aberdeenshire Subscriber*).—The pitch of the roof (30°), will do very well. We presume the house stands north and south, at least that would be best. We would not bring the soil so high against the side walls as shown in the plan, and then more room will be left for the plants. Some small ventilators in the wall there would also be of use in warm days in summer. Your idea of bringing ventilating pipes over the flue is a good one. But we see no means you have of heating the atmosphere of the house except through the bed of soil. We would prefer upright pipes in connection with the surface of the flue, or rather a few inches above it, or else slides in the passage to let out top heat when necessary. By heating entirely through the soil there is danger of the roots being scorched, whilst the atmospheric temperature is too low. By keeping the stones moist at the sides of the flue, not over it, the atmosphere of the house as respects moisture may be regulated at pleasure. When, however, heat is admitted from such a flue into the atmosphere of the house, the flue ought to be good and secure, and for early Cucumbers and Melons, it should at least for half its length be brick on bed, with stout covers at top. We think, also, that instead of having one side for Cucumbers and the other for Melons, you had better divide the house, and thus have a whole department for each.

SCARBOROUGH LILY.—The *Vallota purpurea*, often called the Yorkshire Lily, is probably the plant intended by the inquirer at page 287. It is, I believe, by no means uncommon in the East Riding of Yorkshire; and it is said to have been first introduced there from a vessel wrecked off the coast.—*W. D. PAINE, Keigate*.—I beg to inform "AMARYLLIN" that the Scarborough Lily is the *Vallota*. It was grown in great quantities in that part of Yorkshire; and I barely know any one that has visited that charming place who has not brought one home with him. I had mine from there at first. I found it was *V. minor*; but *V. major*, which I believe is the same as *Amaryllis purpurea major*, is by far the better.—*JACKSON GILLBANKS, Cumberland*.

BOOKS (*W. F.*).—"Flower Gardening for the Many," and "Florists' Flowers for the Many," can be had from our office, free by post, for ten postage stamps. They contain probably what you require.

INDECS (*A Gardener*).—You can have them from our office by sending your address and three postage stamps.

NAMES OF ORCHIDS (*W. H.*).—The whitish-flowered Dendrobe with the lip tinged with yellow, is *D. Picardi*, Roxb. The other Orchid is not a Dendrobe at all, but *Cattleya Skinneri*, Bateman. (*F. C.*).—We are much obliged for the information about the *Oncidium*, and hope that it will produce similar flowers at some future time. *Dendrobium fuscatum* is certainly not in general cultivation. It is a Himalayan species discovered by General Cathcart, and also by Drs. Hooker and Thomson.

NAMES OF PLANTS (*A Young Gardener*).—1, The Burning Bush, also called the Artillery Plant or Pistol Plant. Its botanical name is *Pilea all-triechoides* (see Vol. XX. of THE JOURNAL OF HORTICULTURE, page 383). 2, *Nephrolepis exaltata*; 3, *Phlebodium percossum* (?); 4, *Phlebodium Billardieri*. (*J. B. H.*).—1, *Edwardia chrysophylla*; 2, *Muscari racemosum*; 3, *Leucojum aestivum*. (*J. H. S.*).—A species of *Crimum*, but the specimen is not sufficient to determine which. (*A Subscriber, J. A.*).—Wretched specimens; some quite unexamined. 1, *Arabis alba*; 2, *Iberis sempervirens*; 3, *Pteris hastata*; 4, *Athyrium Filix-*

femina depauperatum. (*H. T. K.*).—1, no leaves; 2, *Epimedium alpinum*; 3, *Mercurialis perennis*; 4, *Luzula campestris*. (*Min*).—A seedling of *Lastrea dilatata*.

POULTRY, BEE, and HOUSEHOLD CHRONICLE.

EGGS.

An egg is in itself a wonderful thing. We have often thought of it. Take that of the Goldfinch or the Humming Bird, or the Carolina Duck, or the Impyan Pheasant. The little thing contains the beautiful yellow wing and crimson velvet head of the first; the magnificent plumage of the second; the varied hues and stripes of the third; the indescribable shades of the last. Its organisation is so perfect, and the principle of life within it so strong, that with proper precaution and painstaking it may travel thousands of miles without injury, and hatch in another quarter of the globe. But there are curious things connected with them, such as we read of in "AN INQUIREE'S" letter last week.

Some years since when everything that happened was supposed to be connected with the end of the world, the eggs laid in certain places had inscriptions, bidding people prepare. We have heard of a poultry maid who had long scorned a shepherd, "not because she disliked him, but because she had not made up her mind." She gave in at once when the egg took part in the affair. Two days in succession she found them bearing the inscription, "Crude gal. Marree Tummas."

Eggs play a far more important part abroad than they do here, and those that are sold at Easter show how easily they take colour. We believe anything in the way of decoration is possible with a new laid egg. At the moment of being laid its shape may be altered, and it will take any colour or inscription.

Eggs have their eccentricities. Some years ago a large egg was called a double one, declared useless, and looked upon with dislike; but it has been proved such will at times produce two chickens. Not only have these results appeared in England, but the same is recorded in France, and two good, sound birds, have appeared from within the same shell. We would, however, advise our readers to eschew the seeking after marvels, and to content themselves with ordinary eggs and chicks. Eggs were not beneath the notice of the learned of old. They studied them closely, they endeavoured to detect the sex of the produce by the shape of the egg. Thus the pointed was to produce a cock; the round a pullet. We have tried it and it failed; they have allowed others to select eggs, and they failed. The inmate of a lunatic asylum was so far sane, he was allowed to conduct visitors over the establishment. He descanted ably and with much feeling on the different weaknesses of those they saw. He pitied and laughed at them. Arrived at the outer gate, the visitor would thank him and say he would be happy to see him at any time. "Stay, sir," said the Cicero, "all these people I have shown to you are insane, but I really am the Virgin Mary, and if I left these walls the effect would be to upset all the religions in the world." So, we tell our readers, Columella is wrong; Game-breeders are wrong; those who look to the shape of the egg are wrong; but we, we can tell how to select cocks:—Set the early eggs, and you will have nearly all cocks. We were told it years ago; we have tried it every year with the same result. We set eggs of three different breeds to come out on the 4th of January, so they did. Be it known we did not want all cocks; the result is, we have a fine lot of chickens, all cocks but one. We cannot explain these things, we only notice and record them as singular and interesting facts in connection with eggs. We are sure that from a pullet's eggs you will have twice as many cocks as from an equal number laid by a hen; and from hens and pullets both, the earlier eggs will produce more cocks than later ones.

Good eggs are often condemned as bad when there is no fault in them, but they are spoiled by being kept too dry. Every egg that is to produce a chicken should be wetted for days with cold water, otherwise the inner lining becomes as hard as india-rubber, and however strong the chicken may be, it cannot emerge from its prison.

It may be taken for granted that the fresher the eggs are

that are put under the hen, the stronger the chickens will be that are produced.

Four days before eggs hatch they should be tested in warm water. It is most amusing. Take a pail and fill it with quite warm water; take the eggs and put them in it, they will float. In less than five minutes an egg will move, then another, then another, till all the good ones are in motion. The bad ones do not move; but the good when they feel the warmth of the water move vigorously and dance about the surface, performing all sorts of evolutions and figures, bobbing about and ducking like a light cork float attacked by an energetic minnow, or a very small gudgeon. So ludicrous are the movements of these shell-bound prisoners, that it is hard to believe they are not aware of what they are doing, and when one elbows himself into the centre, and the others out, we almost listen for the complacent chuckle that should follow the exploit.

We fancy we are discoursing on eggs without much method in what we say. We were led to the subject by the extraordinary occurrences noted in our columns, of two eggs produced at different places and times, each having a shelled egg within another. We tried to explain it scientifically and we could not: it was useless to look for the natural causes of an unnatural occurrence, so we were led to a wandering paper on eggs. All the most beautiful cups and vases of antiquity are modelled from the egg. Many most elaborate cornices and mouldings owe the beauty of their outline to the same faultless shape. We have spent many an hour in the shade on a hot day, with a lump of clay and some eggs. Put on a top, then a foot, then two handles, and you have a vase; put one handle and a spout, and you have a classic beaker; so on, &c. We have passed the morning in this way till we have been summoned to dinner. There had been tribulation about that meal. That lazy butcher boy had not called, he never did when he was wanted; there, it was no great loss, for the last mutton was so hard no one could eat it; and the weather was so hot, it was impossible to keep anything from day to day; so there was only an omelette. Only an omelette! what so nice in hot weather?

Let your pan be scrupulously clean. Cut some fat bacon into very small pieces, and fry them till there is enough liquid to moisten and cover the bottom of the pan. Have your eggs ready in a basin well beaten up; pour them into the pan; turn the edges up with a fork that it may not spread unduly, and thereby become dry and thin. Be careful it does not burn. As soon as the under side is rich, deep, golden colour, and the upper part shows the action of heat, turn it for a minute or two, and then eat it. For our own parts, having done so, we can paraphrase Sydney Smith:—

"And then, though ven'son's dear, and mutton tough,
Chickens and Ducks are not quite old enough.
Of om'lette full, the epicure may say,
'Fate cannot harm me. I have dined to-day.'"

THE BEST MODE OF MAKING ARTIFICIAL SWARMS.

"PHILISCUS" requests the opinions of apiarians on the above interesting subject, and appeals more particularly to the kind offices of Mr. Woodbury, than whom there is, probably, no one more competent to give advice and instruction on this, as well as most other departments of apicultural economy. At first, therefore, it seemed as if it would be a work of supererogation in me to write anything on this question. But on further consideration, having had considerable experience during the last few years, I have decided on jotting down my views, even at the risk of a repetition of Mr. Woodbury's remarks on the same subject.

Being so situated that business occupations require my close attendance at home during the daytime, and my apiaries (three in number) being situated at a distance of some miles apart, I find the practice of keeping up the required number of stocks by the formation of artificial swarms, to the exclusion, or at any rate, attempted exclusion, of natural swarms, is an immense advantage, if not an almost imperative necessity. This will be easily understood from the fact that five natural swarms were totally lost to me last season. These issued from hives which had been duly

supplied with super accommodation, of which the bees had largely availed themselves prior to swarming.

But the formation of artificial swarms can be easily effected before business hours in the morning. A great amount of anxiety is consequently removed from the mind. There is not the same fear on a burning hot day, of, at any moment, some messenger from one or other of the outlying apiaries rushing in out of breath to notify the issue of a swarm from some hive that has been exhibiting symptoms of such an intention for a week or two past. I would not now be subjected to such an annoyance without having taken means to prevent it. If swarms are required, they are made at my own convenience; if they issue naturally, it is against my will, from stocks that have been supplied with supers, or other extra room, with the hope of preventing swarming altogether.

When I state that out of twenty-five stocks which comprised my collective apiaries in the autumn of last year, there were seventeen stocks artificially formed, it may be considered that I do not speak without good reason for preferring this mode of keeping up or increasing the numerical strength of my apiary. The greater proportion of these artificial swarms were founded in the summers of 1861 and 1862. Last year, as swarms were not much wanted but few were made. For the last three or four years I have wintered from nineteen to twenty-one stocks; and as in that period only one stock has been lost during the winter, and having no desire for a larger number, there was little necessity last season for many swarms, and there will be but little in the present. But, as a few young stocks are always useful for supplying any deficiency that may occur, or substituting in the place of any worn-out colonies, some will be raised for that purpose only. Therefore, it will be seen that the greater part of the strength of my apiary is devoted to the obtaining of honey, and the chief features of my mode of management consist in keeping up a certain number of colonies in the highest and fittest condition for this purpose.

To prove that artificial swarms will answer in both a honey and a money point of view, the attention of "PHILISCUS" is drawn to the already published account of the last year's doings of some of the best hives in my apiary; but as he may not have seen that, I now give a short report of some of the best artificially-formed stocks of which it consisted.

No. 3. Artificial swarm, 1861. Filled a super of 25 lbs.; fine honey.

No. 5. Artificial stock of 1861, having a young queen raised in 1862. Threw off a large swarm, no honey.

No. 6. Artificial, 1861. Swarmed, and gave 10 lbs. of honey in a super.

No. 8. Artificial, 1861. Young queen raised in 1862. Gave two swarms.

No. 10. Artificial, 1861. Ligurian queen of same year. Filled a splendid super of 54 lbs., nett, besides combs removed from the stock for an artificial swarm.

No. 14. Artificial, 1861. Ligurian queen, 1862. Honey of the primest quality taken in a super of 50 lbs., nett weight.

No. 19. Artificial, 1862. An artificial swarm made, and queens raised from this stock last year.

No. 20. Artificial, 1862. Formed with one of Mr. Woodbury's rejected Ligurian queens placed at the head. Filled a large super chiefly with brood, and a few pounds of honey, and then swarmed.

No. 21. Artificial, 1862. Dark queen from Ligurian brood. Honey taken, 35 lbs., besides about 10 lbs. from the stock-box.

The above is a rough sketch of what was effected by the best of my artificial stocks last year; and it is worthy of note, that my strongest hives at present are those that then afforded me the most honey. Having said this much to prove that the system of artificial swarming may be adopted with success, it is now time to advert to the last query in the letter of "PHILISCUS," as to the best manner in which it may be carried out. There are admirable directions to be found in the work of Mr. L. L. Langstroth, and to him am I chiefly indebted for the general principles of the practice which I now adopt, aided in no small degree by Mr. Woodbury's extensive experience.

In the year 1861, my apiary comprised a large proportion of common straw hives, with which hitherto I had been well satisfied, as affording every requisite for obtaining large sup-

plies of good honey, chiefly in glass supers. Meeting with Langstroth's book, the applicability of, and many advantages attached to, the proper carrying out of the bar-and-frame system very forcibly took possession of my mind. Immediately I had made a large number of hives on this principle; but with considerable modification of the directions given by Langstroth. Being anxious to stock as many of these as possible the first season, I had a two-fold object in view in the plan of working the straw hives, which was satisfactorily carried out. First, I desired to obtain the best and largest swarms from them; second, I proposed transferring the combs and contents of each straw stock into the frame-hives. The first hive was driven for a swarm on the 23rd of May. The plan adopted is as follows:—We will suppose it is desired to operate on three straw stocks, A, B, and C. If possible, commence ten days before it is intended to force an artificial swarm by raising in a nucleus box a few royal cells, which should, by the time they are required, be properly sealed over. Choose a fine day when the bees are out well. Drive every bee out of A, first placing an empty decoy-hive on its stand to amuse the returning foragers. Put the new swarm in the old position, adding to it the bees collected in the decoy-hive. Then take one or two of the royal cells, and carefully fix among the combs of the old stock, either by cutting out a small piece in one of the brood-combs, or in any way that may seem best to the operator. Having done this remove populous hive C to another part of the garden, and place the driven stock A, containing plenty of brood and the added royal cells in C's position. The bees returning home will after a bit settle quietly in A, and with the hatching-out of the brood will soon make it very populous. In about ten days drive B in the same manner. Insert royal cells, or put in the young queen, now most probably at large, in the nucleus, and stand B in the place of A, which must be removed to another part of the garden. Soon after this C will have become full of bees. This, then, may be driven and put in B's place. Thus far the hives are exactly doubled in number. If more are required the changes can be rung in the same manner; but this would satisfy any apiarian who desired his colonies to be in the best working condition. It is by no means necessary that royal cells should be given to the driven stocks, but it saves a very considerable amount of time at the most important period of the season.

The foregoing is the system which was adopted by me in 1861 and subsequently. Having doubled my straw stocks they speedily became so populous that I was enabled to drive them a second time. The combs were carefully cut out, inserted in the frames of the Langstroth-boxes, the bees returned, and a number of strong and successful colonies established.

But to carry out the artificial system of multiplying hives in the most satisfactory manner, recourse must be had to bar and frame-boxes. The bars and frames must of course be all made exactly similar in their dimensions; the boxes may vary so as to be capable of containing from three up to ten frames. The smaller ones are to be used as nuclei for the raising of young queens. The method which seems to have afforded me the most satisfactory results, is what may be styled the gradual building-up system, and is practised as follows. A nucleus is formed by removing a suitable brood-comb with the clustering bees from any strong stock. This and two frames of empty comb are inserted in a nucleus-box and carried off at once to a distance of a mile and a half, where the bees may be set at liberty: or, if destined to remain in the same garden, they must be confined to their quarters in a dark room for thirty-six hours. Royal cells will by this time, most probably, be in the course of formation, and the bees will remain tolerably quiet. When the young queen is hatched, then may commence the building-up of this nucleus into a full-sized colony. One or more combs of brood in an advanced stage may be taken from any stock, shaking off the bees, and substituting empty combs for those removed. These are generally almost directly filled by the queen with eggs, and a great stimulant to breeding it proves. As the brood hatches out in the nucleus, additional sealed brood-combs may be given, shifting the entire stock into more capacious boxes, say of seven or eight frames. By this means, in the course of a few weeks a very fair colony of bees is established.

Another plan which has proved equally successful, is to find the queen, remove the comb with her and the bees, with another in addition. One at least of these combs should be of brood whose time for emerging from the cells has nearly arrived. These are placed in the small box, and either confined or carried off as the case may require. It is also advisable to give one or more empty combs to the nucleus, so that the laying of the queen may not be checked. As in the former case, the hive may be strengthened by an occasional addition of a brood-comb from any hive in the apiary. If this plan is adopted, care must be taken to insure—1st, that a number of bees be removed with the queen, sufficient to cover well two full-sized brood-combs; 2nd, that suitable empty worker-combs be provided. If these two requisites are not attended to, the breeding of the queen will be materially lessened; and as these changes are effected at a time when the queens are in the full height of their egg-laying, if their fecundity is seriously checked from either of these two causes, I believe they never quite recover their full breeding powers. At any rate this has occurred in more than one instance in my experience. 3rd, It is also necessary that the parent stock, from which the queen and her attendants have been removed, should have a population large enough to cover the brood left in the hive. If not, there is danger of a portion of that brood becoming chilled. But a sufficiency for all purposes can hardly fail to be insured, provided the hive was originally in a fit condition to be thus operated on. It is usually the case, where this latter plan of raising artificial swarms is adopted, that a large number of royal cells is the result. The superfluity may be made available should further increase of stocks be required, or the opportunity taken for removing old or poor-breeding queens from other colonies, and substituting royal cells. The young and vigorous queens which are then placed at the head of such as these, will very quickly alter the state of affairs, if done early enough in the season.

It is obvious that, to insure success in these several operations, drones should be plentiful in or near the apiary, and that none but populous hives be selected for division. If a stock is not strong enough to throw off a natural swarm, how can it be expected to thrive if an artificial swarm is forced from it?

Where a very large multiplication of swarms is desired for scientific purposes, or the increase of a particular species or breed (as the Ligurian), a somewhat different course of procedure has to be carried out. In this my friend Mr. Woodbury can best enlighten "PHILISCUS" and other readers of the Journal.—S. BEVAN FOX, *Exeter*.

OUR LETTER BOX.

OLD POULTRY (*A. Novice*).—You will do little good with old poultry. It is possible the Ducks when well fattened and fasted, and kept as long as may be consistently with goodness, may eat tolerably well, but nothing will make old fowls tender. You must send them to the house two or three at a time as they are wanted for soup and stock-pot purposes. It is useless to attempt to send them for table purposes.

WHITE BANTAM COCK (*J. C., jun.*).—The bird submitted to our inspection is certainly a very indifferent specimen.

BLACK-CRESTED WHITE POLANDS (*W. Horsepool*).—Although there are no prizes offered, yet you would be sure to have an extra one anywhere if you can show such birds. They have long been desiderata. We do not know where they can be had.

DUCKS DISORDERED (*Cochin*).—Your Ducks are out of condition. Shut them up in a pigstye or such place, feed them on oats, and give them plenty of gravel in the water with the oats.

TURKEY SITTING WITHOUT LAYING (*J. C. Perry*).—We should be disposed to think she laid and ate her eggs. It is hard to fancy a hen broody if she has never laid any. A damaged hen, one disqualified for laying, becomes a hen cock—a mule—an anomaly; but she never sits, as she assumes, so far as she can, the properties of the cock. A castrated cock would do exactly as you describe the hen to do.

SMALL DOVES (*T. C. H.*).—These, received from Barbadoes, are probably either the *Chamepeila passerina* or *C. Talpotei*. They are about the size of larks; are chiefly found upon the ground, near underwood, preferring that near farmyards in South America. They are easily kept and bred in an aviary.

RABBITS (*E. W. J.*).—We do not know to whom you can apply, but we have no doubt an advertisement in our columns will answer your purposes.

TRANSFERRING BEES (*E. H.*).—You had better let the hive swarm, and place the swarm by the side of the old stock. If a second swarm issue, place it on the other side. Three weeks after the issue of the first swarm expel the bees from the old stock by driving, and unite them to the second swarm in the manner described in page 59 of the fifth edition of "Bee-keeping for the Many." If no second swarm issue, add the bees to the first swarm.

WEEKLY CALENDAR.

Day of M th	Day of Week.	MAY 17—23, 1864.	Average Temperature near London.			Rain in last 37 years.	Sun Rises.	Sun Sets.	Moon Rises.	Moon Sets.	Moon's Age.	Clock after Sun.	Day of Year.
			Day.	Night.	Mean.	Days.	m. h.	m. h.	m. h.	m. h.	m. s		
17	Tu	WHIT-TUESDAY.	65.5	42.0	53.7	15	7 af 4	46 af 7	26 3	59 1	11	m. s 49	188
18	W	EMBER WEEK.	63.2	42.8	54.0	16	5 4	47 7	34 4	28 2	12	3 47	139
19	Th	Midge appears.	66.5	43.1	54.8	12	4 4	48 7	45 5	47 2	13	3 45	140
20	F	Mulberry in leaf.	66.6	43.3	54.9	17	3 4	50 7	54 6	17 3	14	3 42	141
21	S	Soft Brome Grass flowers.	66.3	44.9	55.6	16	1 4	51 7	1 8	55 3	○	3 28	142
22	SUN	TRINITY SUNDAY.	65.7	43.5	54.6	17	0 4	53 7	3 9	40 4	16	3 34	143
23	M	White Clover flowers.	67.9	45.4	56.6	13	59 3	54 7	57 9	35 5	17	3 30	144

From observations taken near London during the last thirty-seven years, the average day temperature of the week is 66.2°, and its night temperature 43.6°. The greatest heat was 89° on the 22nd, 1847; and the lowest cold, 30°, on the 18th and 19th, 1854, and 19th and 20th, 1856. The greatest fall of rain was 0.58 inch.

MY ORCHARD-HOUSE.

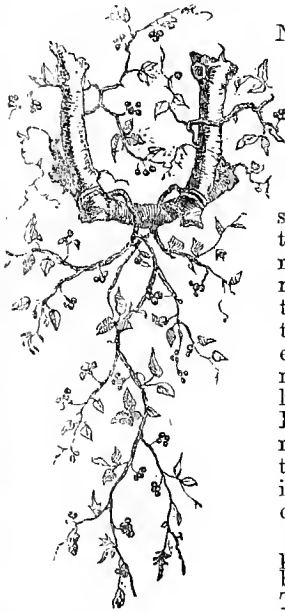

UNDER the above title it is proposed to furnish a series of brief notes on purely orchard-house matters. Having commenced the system in question seven or eight years ago, and being a firm believer in its utility, its simplicity, and its adaptability to most situations, it is with much pleasure that I communicate to my brother amateurs the little I know. In doing this no plan has been found equal to that of describing matters as realised by myself: hence the title of this article. Having been enabled to assist many friends in organising their orchard-houses, some idea has been thus obtained of their wants in this respect.

Just at present is an important period for the well-being of the orchard-house. Thinning has begun—is even nearly ended in very forward

houses. Watering requires the greatest attention to sustain the growing fruits. Syringing must be regularly looked to; while insects are a daily plague. Ventilation if neglected for even a few sunny hours will cause great loss; and the summer pinching-in of the new shoots must now be attended to. The amateur should have all these matters well in hand if he wish to secure a crop. The trees must not be suffered to sustain any check from any of these causes. Especially would I urge the not letting the trees flag for want of water, even for two hours. I am an old pupil of that most clever horticulturist Dubreuil, and shall endeavour to inculcate some of his minuteness of detail, which suits so well for trees in the artificial and highly stimulating condition of the orchard-house.

We will suppose, then, that everything has been prepared during their winter rest for the welfare of the trees; the pots, plunged more or less into the earth, are clean, and stand perfectly level. The more you plunge the pots the less water the trees will require; but it slightly retards the maturity of the fruits, for they lose the heat of the sun's rays on the surface of the pots. Now, in some cases, three or four days are too many to sacrifice; for early fruit is very valuable, and we look to these houses to be well in advance of the open wall.

But to leave this point and many others at present, thinning demands our immediate attention. Here it is extremely difficult to lay down precise rules, for every gardener knows that it is to him practically a matter of experience and feeling. The first thing, however, to be considered by the amateur is how many fruit the tree

can bear, and to do this argues a considerable amount of information respecting the condition and habit of the tree itself. The age, size, sort, and last year's crop must be taken into account. An example or two will aid me to show this. Here, before me, is a splendid *Violette Hâtive* Nectarine bush in an 18-inch pot. It is ten years old, the stem is not more than 1½ inch thick, and it stands, pot and all, about 6 feet in height. From the stem rise three divergent branches, which are surmounted by a network of less branches, thickly clothed with very short fruitful spurs, the result of many seasons of close summer pruning. Its wood is dark, not very thick, rich in vitality and power, and the new growths are not too luxuriant; in short, it is a perfect specimen. Visitors linger near it. But it has a will of its own: it will only bear forty full-sized and well-coloured Nectarines each year. Once, tormented by dissatisfied visitors to let it bear more, I tried sixty; they ripened well, but they were only medium-sized. Thus I know what the tree can do, and if it looks healthy do not exact more than forty annually. But forty Nectarines look well in a basket after all. The next tree is a Crawford's Early Peach. This is quite a different kind of tree; it grows rampantly, and is very difficult to restrain. It is smaller and younger, nevertheless I shall allow twenty-five Peaches to exhaust it. Alongside is a *River's Orange Nectarine*. This is nearly of the same size as the *Violette Hâtive*, but generally of feebler growth. From thirty to thirty-five full-sized fruit is all that it will bear regularly every year. The next is *Hunt's Tawny Nectarine*. As old as the last, it is hardly half so large. It is subject to white fungus, grows irregularly, but bears about twenty annually. The diagonal cordon trees along the back wall (125 feet long) have fine fruit at intervals of 6 inches. This is too much, 9 inches would be safer. Spiral cordons round the pillars bear in the same way.

It is best to thin at three intervals of, say, ten days each. At the first thinning remove about one-third of the whole crop, but observe the greatest caution. At the second thinning it is easier to proceed. Some have fallen, others look evidently small and sickly, and a slight touch removes them. At the third thinning regulate the distances between what you have decided on retaining. Unless the whole crop be small do not leave two fruits together. If three are close together remove one at the first thinning, and a second at the next. Equalise the whole crop. Do not allow one side of the tree to bear much more than the other side. Remove those not well placed for light and air first. Where there are no leaves beyond the fruit there is little chance of these ripening. If the tree look feeble sacrifice the whole crop at once. What is the value of the crop of a potted tree more or less? This constitutes one great advantage of orchard-houses. By having a small reserve you can replace any such tree at once. This seems a good Apricot year. By assiduous watering now the crop may alone be secured. Thin regularly and gradually. Space forbids saying more about thinning.

It strikes me that valuable data might be obtained

by amateurs furnishing notes as to the period when their orchard-house trees came into bloom this year, the difference between the period in this and preceding years, the present length or diameter of the fruit, &c. By such means the difference of "ripening power" might be discovered, and useful comparisons between the northern, midland, and southern counties be made. Many apparent errors might be rectified, and confidence obtained. Such communications might be tabled out and added to this article without much labour to myself. Of their value there can be no doubt, as is apparent in Professor Ansted's work on the Channel Islands, where the difference between the period of ripening similar fruits in my house and in those of Mr. Rivers served to characterise our climate.—T. C. BRÉHAUT, *Richmond House, Guernsey.*

CULTIVATION OF THE PINE APPLE.

(Continued from page 342.)

SUCCESSION PLANTS.—In pursuing the treatment of early-shifted succession stock, and presuming that the middle of April has arrived, and that the plants with increased temperature both at top and bottom have commenced to grow, I would first remark, that one of the most desirable points connected with this fruit is to maintain the proper temperature with as little fire heat as possible. The night temperature by the end of the month should range at 70°, and with a proportionate amount of atmospheric moisture the plants will commence to grow freely. The increase of light and solar heat will render a less amount of fire heat necessary, and, as a general rule, the state of the weather admits of a more liberal supply of air being given. This will enable the cultivator to push forward his early plants without the danger of drawing them, which would be the case at an earlier period of the season. In order to keep up the temperature with as little fire heat as possible, air should be given early in the morning, almost as soon as the sun strikes the glass, and I would recommend that the shutting-up should take place at an earlier hour than is usual in order to have the maximum temperature while there is yet a strong light, and to husband the natural heat of the sun as much as possible. The steaming-troughs should be filled up every day when the pits are shut up, and at the same time the paths and walls damped with the syringe. Without a moist atmosphere the growth will be deficient in broadness, texture, and that dark hue which indicates that all is going on well. I have never found any means of giving a fine dark green to the foliage of Pines equal to the evaporation of guano water from the steaming-troughs. I am not an advocate for heavily syringing young growing Pines, and much prefer that the moisture should be supplied by evaporation. On the afternoons of very hot days they may occasionally have a gentle dewing over through a very fine rose. Regular heavy syringings have a tendency to keep the soil in a puddled state, as the leaves conduct all the water that falls on them into the pit, and they have, moreover, a tendency to produce soft unfruitful growth.

With increased air, light, and heat, and the very moderate syringings recommended, the state of the soil as to moisture must be carefully and constantly watched. An equable and healthy amount of moisture must be maintained. Just sufficient water should be given to keep up an active and healthy state of growth. No amount of attention should be considered too much to prevent the soil from becoming dust-dry on the one hand, or over-wet on the other, otherwise a check may be the result, and an amount of mischief that no after-management can retrieve. It is a great mistake to suppose that a check is more likely to arise from plants being kept too dry than from the opposite extreme. A puddled soppy state of the soil is one of the greatest errors that can be committed in Pine-growing, and it is just one of those that beginners are most apt to fall into.

When bottom heat depends on leaves and tan it not unfrequently occurs, although the heat may be just right in March and April, that the hotter sun of May causes an increased bottom temperature just at a time when the young roots are reaching the sides of the pots and are most susceptible of being burned. The safest way is to have a thermometer in the plunging material, and as so on as it exceeds

90° to take steps at once which will secure the safety of the roots. To shake the pot from side to side will let the heat escape, and after the heat falls the tan can be pressed to the sides of the pots again. From 85° to 90° is sufficient heat for the Pine, and anything over that is not safe.

By the middle of May they will be growing freely, and moisture and air will require to be increased in proportion to the progress they are making, otherwise they will make a drawn growth. The house should be steamed or damped the first thing in the morning as well as at shutting-up time. A little air should be given at 7 A.M., and gradually increased till, at eleven o'clock, there is an amount which creates a free circulation about the plants. Air should be given at the back or highest part of the pit, but never at the front, as currents of dry air are too much for the tissues of the plant, and rob the pit of moisture to a great extent.

Although very much opposed to shading Pines in a general way, it is necessary, however, should the weather become very bright and scorching, as is not unfrequently the case in May, to shade for a few hours in the middle of the day with some thin material—such as tiffany or hexagon netting; but if all is going on right at the root and a moist atmosphere is steadily kept up, there seldom occurs much necessity for shading, and it is much better done without if possible. It is, however, very undesirable that Pines should become browned and wiry, and slight shade and more frequent gentle dewing at shutting-up time should be resorted to as preventives as soon as signs of it appear. I find the true Smooth-leaved Cayenne more impatient of bright sun, in the early part of the season particularly, than Queens and others, and to grow it to perfection it should never be allowed to become much browned.

The temperature should now be carefully regulated, and fire heat applied in the evening just in time to prevent the heat from sinking below 75° at 10 P.M., and 70° at 6 A.M.; and when the morning gives evident signs of a bright day the fires should be damped down the first thing, and be kept as low as possible all day. There is nothing more injurious than to have hot pipes, a hot sun, and a maximum supply of air, and such a combination of circumstances will give a check to Pines as soon as anything.

With increased light, air, and the progress the plants will now be making, more water at the root will be required, and the water should always be at a temperature of 85°, and coloured with guano every time it is given. It often occurs at this season that the centre leaves stick closely to each other for a longer time than is good for them, and they should be separated either with the hand or a slight touch with a stick where they cannot be otherwise reached.

In favoured localities and with fine summer weather after the longest day, the temperature can be kept up sufficiently high without the aid of fire heat, more particularly where bottom heat is derived from tan and leaves. In a close pit or house there will be no difficulty, by shutting up early in the afternoon, of so husbanding the heat that it will range from 70° to 75°, and when such can be accomplished without fire heat so much the better in all respects. These remarks are not universally applicable, for there are many localities in which the climate renders necessary more or less fire heat all the summer.

Should any of the plants throw up suckers from the axils of the lower leaves they should be removed at once. The best way of doing this is to have a pair of long iron pincers with which they can be easily twisted out. Another way of doing away with them is to drill the hearts out of them with a chisel-pointed piece of wood, but the former mode is the better. Where much syringing is practised suckers, frequently, will show themselves in abundance, in Queens particularly, and this is one of the many evils resulting from too much of the syringe.

As the stock of which I am now speaking is that intended to start into fruit for the early supply for the next season, the plants should have well filled their pots with roots and made a stocky well-matured growth by the middle of August, otherwise there will be no hope of their starting in time for ripening their fruit in May and June. If grown on the shady wet-at-the-root system they will not be in a fit state for the purpose now named; and even with the best of management to induce them to start without first making a growth in spring, it is necessary that they should complete

their growth early under the influence of plenty of light and air, otherwise they will make a fresh growth when the temperature is raised with the object of starting them, instead of coming up at once into fruit. True, those which make a growth first always throw the finest fruit, but where an early summer supply of fruit is required, it must be had from plants that start without making a growth. In properly preparing plants for this there are two evils to be guarded against: the one is that of having them too early in autumn over-much pot-bound, and kept growing too late—in that case the fruit comes up slowly in winter a hardened knob about the size of a thimble and worthless;—and the other is a watery, immatured growth which nothing that can be applied will start early.

Towards the beginning of September water must be most judiciously applied—no more than is needed to keep the plants from suffering either from aridity of atmosphere or dryness of soil. Towards the end of September they must be in a complete state of rest. The temperature at night should range about 60° by the middle of October, after which time no more water at the root will be required for the winter, and the bottom heat should decline to 70° or 75°, just enough to keep the roots healthy, and much less is enough for that purpose than has been long imagined. In the next two months the temperature at night must not exceed 60°; the atmosphere should be dry, and air given moderately on all favourable occasions. During severe frosts the heat is as safe at a few degrees below 60° as above it.

D. THOMSON.

CULTURE OF CHINESE PRIMULAS.

THE Chinese Primula (*Primula sinensis*), is not only an autumn, winter, and spring ornament to the mansion, the dinner-table, the conservatory, and the greenhouse, but, more than this, it is of easy cultivation, and thrives equally well in the humblest cottage window as in the best position in the palace gardens. Under these circumstances it cannot be expected that I should have anything new to offer as to its cultivation; but, from a letter lately received, it appears that there are some of your readers unacquainted with the modes of cultivation usually practised, and to these I now address myself.

This plant is raised from seed, as is well known, not because it is an annual or even biennial (every way a perennial, it may be increased by division of the root), but because stronger plants and better varieties result. It is of great importance to sow seed that will produce fine large heads of bloom, and fringed, individually large, rich-coloured flowers, and round withal, so that they will bear examination even by a florist's eye. Any nurseryman can supply seed of first-class quality, if told that a good article only is wanted. One-half the seeds sold of this flower are not worth sowing, and it is vexatious to spend time, labour, and money on plants which must ultimately go to the rubbish-heap. Better pay a little more for a good article than purchase cheap seed.

For flowering in autumn the seed should be sown in March. A seed-pan is best for the purpose. It should be well drained, and the rougher parts of the compost placed evenly over the drainage, so that the latter and the rough compost may occupy one-half the depth of the pot. The compost I prefer is turfy light loam two-thirds, and one-third leaf soil from leaves well rotted, with one-sixth of silver sand. With this compost, passed through a half-inch riddle, the pan is filled to within half an inch of the rim, and when the surface is levelled the seed is sown thinly over it and lightly covered with fine soil. A gentle watering is then given, and the pan is placed in a frame with a temperature of from 60° to 75°. The soil is kept regularly moist until the plants are up, when they are placed near the glass so as not to become drawn up weak, and watered moderately as their necessities determine. In this state they remain until furnished with two pair of leaves besides the seed-leaves, when they are potted singly into 60-sized pots in the same compost as that in which the seed is sown, care being taken to lift them with some earth, so that they may not suffer from the potting more than can be helped. They are kept in the frame for ten days or a fortnight after

potting, and are not allowed to suffer from want of a little shade from bright sun, or water at the root, but none is given overhead. At the end of that period they will have filled the pots with roots, and be ready for shifting into 48's; they are potted in these, and afterwards kept in the frame a week longer. They are then removed to a warm part of the greenhouse, and after becoming hardened they are placed in a cold frame on coal ashes to prevent worms finding their way into the pots. Here they are well supplied with water at the root, and the inside of the frame kept moist and cool by sprinkling the ashes and all available surface with water twice daily, and a gentle bedewing overhead from a fine rose will contribute to their vigour in hot dry weather, if the water be tepid (75° to 80°), and applied in the evening.

By midsummer the plants will be strong, and will need potting into 24-sized or six-inch pots; and now must be determined how many plants will be required for decorating the dinner-table, or for filling small vases in the house. Select a number of strong bushy plants and transplant them into 24's, employing a compost of turfy light loam, leaf mould from a wood, or that from oak or beech leaves, in equal proportions, with about one-sixth of silver sand intermixed. In potting, the pot may have a large crock or oyster shell placed over the hole, and half an inch of bruised or half-inch bones placed upon it. A little rough compost being placed on the bones, and a little, very little, soil laid on that, the plant is placed in the pot, and it should be potted so that it will be 1 inch below the rim of the pot, placing the soil carefully round the ball and pressing it gently down. After potting give a gentle watering and place in the frame, having reversed the latter so that it slope to the north, and not to the south as is usually the case. Plants which it is desired to grow large for conservatory or greenhouse decoration should be potted into 24's, employing the same compost, to which add a 24-sized pot full of half-inch bones to every six plants, mixing the bones with the compost. The pots should be well drained, and having been gently watered placed in the frame with those previously potted. In the frame they should be well supplied with water, but none should be given until the soil gives unmistakable evidence of watering being necessary, then enough should be given to run through the pot. The frame is kept close for a fortnight, after which air is freely admitted, and the lights drawn up at 9 A.M., and kept over the plants by day and when heavy rains occur, at the same time admitting air back and front by tilting the lights there. The lights are to be taken off by night, except in rainy weather, when they must be kept over the plants, so that these may receive the refreshing dews. Should the plants throw up bloom-stems these must be removed, for they have a tendency to stop growth, and it is that we are seeking to encourage.

By the middle of August the pots will be full of roots, and we can, if there is any likelihood of a scarcity of bloom in September, place a number unpotted in a frame exposed directly to the south, and when they begin throwing up for flowering water them at every alternate watering with liquid manure made very weak by dilution with soft or rain water. These, if properly attended to with water, will flower finely by the middle of September. Presuming, however, that those potted for the decoration of the house are not wanted to bloom before October, we top-dress these with a compost of sheep-droppings and leaves which have lain in a heap to rot for twelve months. The inch cavity left is filled with this, having previously removed as much of the old surface soil as can be done without injuring the roots. The plants are kept moderately watered as their wants determine, and towards the end of September they are taken to the potting-bench for the last time, the top-dressing is removed to the extent of an inch in depth, and its place supplied with fresh. When this has been done the surface of the pot is covered with small white pebbles, quartz, or sandstone, and these materially improve the appearance, and are at once supports for the neck of the plant, and a means of preventing its damping-off at the collar. This done, the plants are placed in a light, airy situation in the greenhouse, and will flower finely in a short time, and be immeasurably superior to those which are never potted nor cared for beyond a shift once or so after sowing, and drawn up weakly and poor in a

shady unsuitable position in heated houses. When in flower no plant can rival these; and by the system above described we obtain the same result, or nearly so, as if we employed larger pots, which are too cumbersome for house decoration generally.

Those intended to ornament the greenhouse in autumn and winter should be transferred by the middle of August into pots varying in size with the plants. The strongest may be potted in 12's, and the next strongest in 18's, using the same compost as at the midsummer potting, with this difference—a third of the compost employed for top-dressing those in six-inch pots is added to it, and an inch of half-inch bones is placed at the bottom of the pot in the place of crocks, only one good-sized crock being employed for drainage. When potted they are placed in the frame, and kept there properly attended to as regards water, abundance of air and light being admitted, and protection afforded from heavy rains. All early blooms are nipped off; and in the last week of September the pots are surfaced with small pieces of white stone, and placed on a shelf near the glass in the greenhouse, where the plants are carefully watered, and allowed to go to flower; they will bloom finely in the dark dull days of autumn and winter.

I have occasionally selected a few of the autumn-flowering plants that were extra vigorous, and which appeared not disposed to bloom, given them a shift into a larger pot, and placed them in a slight hotbed to get the pots full of roots, when the plants were transferred to their situation in the greenhouse; and by this system I have obtained extra-sized plants with larger flowers and in greater profusion. In the dull winter months these plants should be carefully watered—rather sparingly, as, when over-watered, they damp-off at the surface of the soil.

For blooming in spring the seed should be sown early in June, and be set in a Cucumber-frame or any place having a gentle heat. When fairly up the plants are transferred to the greenhouse, Peach-house, or some such light well-ventilated structure, for they are apt to become drawn, and are liable to damp-off if kept in a confined atmosphere at that period of the year and at that stage of growth. When furnished with a rough leaf or two they may be potted into 60-sized pots, or be pricked out into seed-pans to gain strength. I prefer placing them in pots, for it is scarcely possible to take them out of a seed-pan for potting without doing serious injury to the roots. When fairly established in pots they are best kept in a cold frame, and they should be in 48-pots by the beginning of September. Early in October they will require their final shift for the season, and should be put into six-inch pots, efficient drainage being provided, and the surface of the soil covered with small pieces of quartz. The compost I employ for spring-flowering plants differs slightly from that used for those intended for autumn bloom, and it should consist of turfy loam, leaf mould, and sandy peat in equal parts, with about one-fourth of silver sand, though river sand when clean will do quite as well. This compost contains less stimulating matter, and does not create so much humus in the soil; and as these plants are liable to damp-off, I give it the preference as the demands of the plants are not so great, and under no circumstances can they be grown so fine in winter to flower in spring, as during summer to flower in autumn. During winter they should be kept near the glass in the greenhouse, and be watered sparingly, and only when necessary, and all early flower-stems nipped off as they appear. Such plants flower well in March and April, and if placed in coal ashes out-doors after blooming (June), they will flower again well in autumn.

The double varieties are very pretty objects, but not half so fine in habit though more profuse-blooming, nor so generally useful as the single varieties. They are increased by cuttings, which are the side divisions of the plants. These, taken off with a sharp knife immediately below the lowest leaves, and inserted singly in small pots in peat and sand, placing them in a frame on a gentle hotbed (75°), and keeping closely shaded, soon root. The plants or plant-like cuttings are best taken just when the old plants have done blooming and are beginning to grow. All the double varieties require is an annual potting, the period at which this is done varying according as the plants are grown for blooming in autumn or in spring. If grown for spring bloom

they should be potted in June, and be kept in a cold frame on an east border, and all flower-stems nipped off as fast as they appear. If large plants are desired another shift may be given in September, placing them in a gentle heat to cause free root-action, and removing them in a fortnight to the shelf of a greenhouse. They should be sparingly supplied with water in winter, care being taken to keep all bloom-stems removed, for these plants are more prone to flower than grow, and will soon flower themselves into mere pygmies. After January they should be allowed to go to flower; and if due care has been taken to prevent their flowering they will bloom most profusely in March and April, for the nutriment which would have been otherwise expended on flowers will go to the production of fresh growths.

If they are required to bloom in autumn and winter the plants are potted in April, and kept in a cold frame through the summer, all bloom-stems being removed until August, and every encouragement to growth given—as shade from bright sun, and a moist condition of the atmosphere round the plants, but not water on the leaves. In potting, sandy peat and turfy loam in equal parts, with a free admixture of silver sand is the most suitable compost, and this with free drainage and proper regard to admitting air on all favourable occasions, will do all that is necessary to keep these "miffy" plants in good order. Rich compost is not good for them, for they are far from being so strong in constitution as the single varieties from seed.—G. ABBEY.

BEAUTY OF WALTHAM ROSE AND MADAME C. CRAPELET.

THE readers of THE JOURNAL OF HORTICULTURE will now see how much credit is due to Mr. Wm. Paul's assertions. He made two distinct charges against me, one of a general, the other of a particular character. I proved that those charges were not true; but instead of even saying that he was mistaken, he reiterates a statement which I have shown that I never made. He must excuse me for saying I shall not again trouble him with regard to any observations, however hostile, that he may make. The letters which I have received from perfect strangers expressive of their entire confidence in my judgment as to florists' flowers, are a sufficient proof to me that my course is a right one.

With regard to the observations of Mr. Prior, I would remind him that I do not maintain the identity of Beauty of Waltham and Madame Charles Crapelet, but their great similarity (in this I have since found I am borne out by Mr. Rivers in his catalogue for 1863), and their sometimes being undistinguishable the one from the other; and I am not shaken in that opinion by Mr. Prior's observations. I quite agree with him that there is a difference in the growth of the two, but I have never found any difficulty in growing Madame Charles Crapelet (I do grow both, and I dare say under different conditions to Mr. Prior as far as purity of air, &c., is concerned); nor can I complain of its inconstancy or of its want of freedom in blooming. Mr. Prior, too, passes on from a particular to a more general charge, and thinks I am sometimes inaccurate. It may be so; but it is from want of judgment if it be so, not from want of desire to be correct. But I do not quite see that he has been successful in fastening that charge upon me in his present letter, or do I misunderstand him? Does he regard Mr. Rivers's catalogue as the ultimate court of appeal as to the qualities of Roses? for if so, I think he will see that Mr. Rivers's opinion as to new Roses is sometimes wrong, and that by his own confession. For example: I find that in his catalogue for 1862 the following Roses, which are in his list No. 1 as those which are distinct and good, are in his list of 1863 placed in his lowest list, No. 4:—Monsieur Dunant, Robert Fortune, Triomphe d'Alençon, and Vainqueur de Solferino, although he described Robert Fortune as one that would probably prove a remarkable Rose; while Jean Bart, described in 1862 as one "with shell-like petals, lasting and beautiful," is in 1863 consigned to list No. 3. Mr. Rivers stands deservedly high as a Rose-grower, and his judgments generally are correct, but he is not infallible, and in new Roses one may very well be mistaken; and therefore, although L'Eblouissante and Madame J. Daran are in list No. 1 this year, I am not sure that they will

remain so. My own judgment is that they are not first-rate Roses. I find Margottiu, whom I regard as the Rivers of France, does not admit the latter into his catalogue. Then with regard to Vainqueur de Goliath, let me remind Mr. Prior that it is yet an untried Rose. It came out in the autumn of 1862, and when I wrote those words it was not in the hands of Rose-growers generally; and even if it were I have always maintained that it is not until the second year that we can form anything like an accurate judgment, so worked are the plants. It may be the best Rose of the season, and no one esteems Mr. Wood more than I do; but he, too, may be wrong, for I recollect that he pronounced Reine des Violettes the best dark Rose of the year, when it came out; it does not hold much of a place now. As to Deuil de Prince Albert, I ascribed it to Ducher, I believe, the author of a French list, but I may have been in error.

I do not thus in answering Mr. Prior mean for a moment to say that my judgments may not be incorrect; but they are not, I can assure him, hasty, although it may well happen that sometimes errors will creep in, especially when to write about flowers is neither the sole nor the main object of one's life; but let him rest assured that it will never be my object to lead any one astray. I wish to be no blind guide. It is not a matter of business with me to praise or dispraise. I aspire only to be somewhat of a guide in my own especial department to many who are glad to obtain information.—D., *Deal*.

Those whose knowledge of Roses has been derived from growing plants will, of course, laugh at the notion that Beauty of Waltham cannot be distinguished from Madame C. Crapelet. I have grown both (the latter I have a dozen plants of), and I have no hesitation in saying that they are perfectly distinct. Tastes differ, but I much prefer the Beauty to Madame.

I think "D.'s" experience of Roses must have been chiefly confined to cut blooms, as I recollect he insisted when Comtesse C. Chabrilant came out that that flower could not be distinguished from William Griffiths, a statement which greatly amused me at the time, but which I afterwards accounted for by "D.'s" subsequent statement as to the sort of soil which his garden is composed of. "D." evidently loves flowers, and no doubt is a reliable guide as to many kinds, but I have great doubt whether he is a safe authority with regard to Roses.—P.

My good friend, "D.," of Deal, is not the only one who has declared his belief that "these two Dromios are one in semblance." The Pope of Rosierucians speaks from the Vatican (Rose Hill, Sawbridgeworth) and says (see his encyclical letter, or catalogue for 1863 and 1864), "Beauty of Waltham, light rosy crimson, much like Madame C. Crapelet;" and Mr. Cant, of Colchester, describes the two varieties as "scarcely distinguishable" from each other. Mr. William Paul, on the other hand, a very accurate painter of Rose portraits, as his catalogue proves, maintains a distinct individuality; and my own recollection, as a censor at some of our principal Rose shows last summer, induces a similar belief.

Let both sides have a month's armistice, and then we shall have the two beauties before us, and can finally resolve the doubt. I fancy that the Rose-grower will find that he "could be happy," like Captain Macheath, "with either," without wishing the removal of "t'other dear charmer" from his garden.—S. R. H.

COTTON-PLANT IN THIS COUNTRY.

CAN you give instances of the Cotton-plant having been successfully cultivated from seed, in greenhouses, in this country? If so, was it the perennial Tree Cotton (*Gossypium arboreum*), or the annual Sea-Island Cotton (*G. herbaceum*)? I tried to raise plants from some seeds from Jamaica last year, which I believe to have been *G. herbaceum*, but was not successful, the young seedlings damping off while in the seed-leaf. I am this year trying some Egyptian seed. If

any of your contributors or readers have had any experience in the culture of this plant they would greatly oblige by communicating it.—EATON CLIFF, *Liverpool*.

QUESTIONS ON HOTHOUSE BUILDING.

(In answer to Correspondents.)

1. No. Iron is not preferable to wood, exclusive of durability. When there was a heavy duty on glass, and small squares were used for cheapness, iron was an object, as permitting of more light from the roof than wood. This is of less consequence now, when large squares of glass can be obtained at from 2*d.* per foot and upwards according to quality. An iron roof wants much more careful glazing than wood, as if glazed at all tight there is apt to be cracking both by the expansion and contraction of the iron, more especially if the latter is attended with previous wet or condensed moisture. Under such circumstances we have listened to the sound of one pane of glass cracking after another, and felt powerless to prevent it, unless we could have thrown a shade over the house. Such roofs are also more expensive to keep than wood, as if the paint wears off rusting will proceed with great rapidity, and that rust, mixed with condensed moisture, is pretty sure to spot and kill the leaves of the plants on which it falls. Where lightness, efficiency, economy, and the moving of sashes are to be combined, we would recommend iron columns and rafters, and wooden sashes. Copper would be better than cast iron, but much more expensive. Whenever metal is used not only for main supports, but also for sash-bars, the glazing must never be tight.

2. Circular roofs, or more or less curvilinear, have this decided advantage, that they admit more direct rays of light during the day than any other plan. Mere lean-to or span-roofed houses receive these rays most directly at certain periods of the day and seasons of the year, according to the slope of the roof, a steep roof being best for spring and late autumn, and a flatter roof for summer. A circular or curvilinear roof cannot be so easily made of wood as of iron cast at once into the necessary shape. One objection as respects economy is, that the more rounded the roof and the larger the squares of glass used, the more the necessity for having glass made suitably bent on purpose. It would also be necessary to keep a stock of such in reserve in case of breakage. This would be less likely if strong glass were used—say from 20 to 27 ozs. All theory and appearance are in favour of these roofs. In practice we cannot say that we have found them greatly superior to the common sloping roof. As buildings of ornament they are certainly superior.

In a late volume, two years ago, there was a description, with an engraving, of a mode adopted by Mr. Cranston, architect, 1, Temple Row West, Birmingham, which by making the roof consist of a number of sloping planes according to width and height gave most of the advantages of the circular roof, with the convenience and economy of fixed roofs and the using of wood and straight glass. Mr. Cranston's method also supplies the means of giving air, more or less regularly all over the house. About the same time a descriptive section and photograph appeared of some new houses put up by Mr. Niven, of Drumcondra, near Dublin, in which the roof was also thrown into several planes of glass, the roof being all fixed and straight glass used. These roofs, neat as they are, would most likely not please an artistic eye so well as a fine sweeping curvilinear one; but there can be little question as to their combining many of the advantages of that form, and still less, of the greater economy in erection and possible repairs afterwards, as almost any labourer at a pinch can put in a square of straight glass when an accident occurs. For elegance and other advantages, then, we prefer the circular roof. For practical utility we question if a light sloping roof has been much surpassed. For getting out of the common track and combining something of the elegance and a good many of the advantages of the circular form, with first and ultimate economy, we would advise our correspondent to study these sections before building, or deciding for himself by a personal investigation of the houses.

3. In common lean-to houses nothing suits better than shelves sloping one above the other for setting plants on

and growing them. Such shelves would also answer well enough under a curvilinear roof where utility was the main object. But the more artistic the roof, and the more ornament and display wanted inside, the more unsuitable would such shelves appear. The form would depend on the space and the width. The table form in general would be best, whether made of wood, spars of wood, flags of slate or stone. In the case of either of the latter a small ledge should go round, so that a little moisture might lie on the slates when desirable. The worst thing to use is metal of any kind, it is so easily heated and so easily cooled. Of course, the supports may be of iron. One of the neatest table-stages in a span-roofed house we ever saw was at Mr. Bewley's, near Dublin, and we mention it because Mr. Bewley is so deservedly famed for allowing his horticultural and botanical treasures to be seen by respectable visitors. This table-stage was made of wood, well pitched and covered with small, clean-washed pebbles or shingle, and the plants seemed to stand so nice and cool upon them. A rim of about 1½ inch went all round the table, and the boards round the sides were boldly curved into vandykes, and painted, we think, with dark green, relieved by broadish sweeping lines of bright yellow. The vandyked boards prevented you seeing much of the pebbled floor beneath the stage, and as far as we recollect there was a skirt of Helvetian moss on the ground, close to the pathway.

4. For a very ornamental house, close to a mansion and communicating with it, we would recommend hard-burned tiles of various patterns. Hard as they are, however, they are scarcely suitable for workmen going much on them with nails or tackets in their shoes. The next best are flagstone and slate; and the most common, hard flooring tiles either of a red or a whitish colour. In houses where there is no stage or table, and the plants stand on the floor, then it should be all floored. In such a case, however, there should be some consistency between the flooring and that in which the plants at least seem to grow. In a show place not a great distance from Dublin we once noticed an elegant conservatory floored, as far as we recollect, with the finest marble, and a number of flimsy wire stands placed here and there, ornamented with plants in the common red pots. Such stands and pots were sadly out of place where nothing but the richest marble and china vessels or vases would have been in character. The more artistic the house, the richer the flooring, the more beautiful ought stands and vessels to be. For a number of years we had a house in which all the plants stood in beautiful vases of different sizes—not a common pot was seen. If we could hardly get rid of the sight of a rim now and then we painted and sanded it to make it look like stone. We grieved when the style was stopped, as there was such harmony between the house, the position, the plants, and the vases.

In a large house a better effect will be produced by a number of tables or stages of different sizes and shapes, instead of one principal table occupying the centre of the house. In either case, where one or several tables or stages are used, we would be inclined to confine the flooring to the pathways, or the spaces between the stages. In that case the neatest boundary would be a rim an inch or two above the pathway, ornamental or plain. The simplest mode would be to have the pathway 1½ to 2 inches higher than the beds beneath the stages. We advise this arrangement not so much on account of saving something in flooring as for saving in cleaning, for, whether tile, slate, or stone is beneath the stage, it is sure to become green and dirty-looking. A clean-raked bed of earth would look much better. That bed would do for growing creepers for the rafters, and the interior of the bed might be concealed by a line of Ferns and Mosses planted near the sides. Both of these latter objects could be gained were the bed covered for 2 or 3 inches with clean-washed small pebbles, or gravel clean and of uniform size. Very neat pathways might also be made of fine gravel edged with stone or tiles; but this would not answer near a mansion. For vineries and forcing-houses nothing is neater than flags or slate for paths. If well raised above the ground they are easily kept clean. For practical utility nothing beats a wooden sparred trellis.

5. There is no objection whatever to your collecting the rain water into a metal tank 9 feet by 5 feet, and 5 feet deep, and having it beneath the stage or stand of the con-

servatory, to be supplied with a force pump. If at all scarce of water, we would rather have two of that size than one, or a tank considerably larger. Of course, you will have an overflow from it when full. In building we would secure another object; we would have a hot-water pipe to go through the tank in winter and spring, in order to have warm water at all times—at least, a little heated, and at these seasons, when the tank was nearly full, we would turn the rainfall into the overflow-pipe at once, after securing as much as would keep the water in the tank fresh and sweet. Your tank will not take half the water from a hundred-foot range if that is moderately wide and lofty; and with a small tank, if you depended wholly on it, you might find a deficiency when the water was most needed.

6. Here we must stop. We cannot recommend a builder. We have no doubt there are good tradesmen in Dublin. We fully believe that those who advertise in our columns would do the work well. It is best carefully to consider what you would wish to have done, and the mode of doing it, and then obtain a general outline of the expense. Unpleasantnesses: sometimes occur when they ought not, when the plan decided on is departed from. All such deviations must be paid for. It is best every way to employ one tradesman to do and finish the whole—that is, to take the whole job. It would be wrong in us to mention one in preference to another; and you may judge also of the difficulty when we state, that though we know some eminent builders, we have that good opinion of them all, that we should have trouble in fixing preferentially on one to do a large job for ourselves. But for coming in our way, and the principle and novelty of the designs being so applicable to your inquiry, we might not even have alluded to Messrs. Niven and Cranston so prominently.—R. FISH.

GROWING POTATOES AND GREENS CONJOINTLY.

(Concluded from page 352.)

THE way in which I have managed to preserve my Potatoes exceedingly well during the last sixteen years, is as follows:—I do not store them till after they have undergone a preparatory sorting course, which means, as soon as the Potatoes are lifted, keep them not more than 2 feet thick in a dry sheltered place, and covered over with some dry litter, for it is necessary that the light should be excluded from them in some way. Continue sorting them over every few days till diseased ones cease to appear, which will, probably, be in about a month or six weeks. I have found that those which are beginning to become rotten generally do so in that space of time, and those that are then unspotted can be depended upon for store. I then place them away in a dark cellar, next to and having a temperature similar to the one already quoted, minus the sand or ashes, in trays formed of old doors having slabs about 9 inches in depth nailed to their ends and sides. The tubers are thus kept immediately under my eye to scrutinise them at any time, and to enable me to "spurt" them at any opportunity, which I never neglect doing, or the consequence would be, that as with other folk who keep them in confused masses, they would become heated, forced into germination, and produce lanky, premature shoots to the length of one's arm; in fact, as Mr. Fox observes, "a great proportion of them become soapy and disagreeable." It is but a short time ago that I sent Mr. Daintree a portion of my growth of his Seedling preserved in the trays. I grew them, of course, on the ridge-and-trench plan, and I wanted his judgment between them and some of his own grown on the flat, or in the common way, and I will now quote the passage from his letter in answer to my request:—"Thanks for your splendid specimens of my Seedling, which only came to hand on Saturday afternoon. I never ate such; and the skins, where are they? That ridge system of yours is no myth, and must be adopted when once tried."

I cannot feel quite satisfied with my reply to Mr. Fox's questions unless I explain to him the *rationale* of my cultivation of the soil in connection with the above rotation.

Formerly I used to introduce fresh dung as each trench was formed, and dug it in with a spade; but now I merely fork up the bottoms of the trenches with a narrow three-

tinued fork which I had made at the blacksmith's for the purpose; for the rector three years ago caused an extra large tank to be made, and I have now a constant supply of liquid manure (house-sewage), which I use bountifully to the Cabbageworts in the trenches, and, in fact, to all growing crops, to the Roses, and to all the fruit trees when swelling off their fruit, and the effect is surprising. What a lucky affair that was of Mr. Fish's pouncing upon the liquid-manure receptacle last year! When I read of it I felt quite glad it was a want of water that impelled him to unearth the tank, because I fancied he previously used to write rather dubiously when treating on liquid manure. There can be no doubt now about his opinion on the subject.

I fancy also that Mr. Robson does not enter into the cloaca application quite heartily. At any rate here we have a perfect set of soft-water tanks (we had an extra one holding upwards of 1000 gallons made last autumn), which catch almost all the rain water that falls on the roofs of the house and outbuildings. For drinking and cooking the water is filtered, and the whole after being used for household purposes is caught again by the liquid-manure tanks, water-closets included, to be from thence pumped out by a Warner's pump, and distributed wherever it is wanted in the garden, through the agency of one of Read's galvanised water-harrows, made to run upon three wheels, and the watering-can. The whole thing is marvellous; and yet within a stone's throw almost, at a new police station erected here but the other day, a sewer was made to carry the sewage into the river! When I consider that the sewage of the town mostly goes the same way, I am thankful that the inhabitants of this house are now no more under the necessity of drinking the water from that polluted stream. As I should be charged 6s. for a cartload of littery dung I can contemplate my manure-tanks with complacency, and with confidence recommend the plan to others.

I know not whether Mr. Mechi was before me or no in this liquid-manure matter. It is thirty years since I caused our first tank to be made in a cow-house in the vicinity of Ludlow.

Allow me just to mention here that the voided fecal matters of animals must be used with more caution than human excreta. Slightly diluted the latter may be applied to vegetation almost with impunity, but the former should have the addition of four or five times their bulk of soil or water, as they are of a much hotter nature. Well, the sediment from our tanks is emptied once a-year and mixed with road-scrappings, in a large opening dug out in a back yard for the purpose; and I have this spring, for the first time, added what I call my muck-pie—that is, the refuse from the gardens, and all the sweepings that collect from time to time about a small house and grounds in the country and are tossed into the mixen. I need never despair about my land becoming exhausted of humus, as the above will be wheeled into the garden in the autumn, and the site whereon it is to be applied, now occupied with Potatoes and the Cabbageworts, will be then thoroughly trenched, and the mixture well worked into the body of the soil. Once in three years is sufficient for this application.

It is best systematically, for economical working, to divide one's Potato ground into three. The ground is bastard or half-trenched, as soon as convenient, when the Cabbageworts are cleared away, and then I cause mortar rubbish, if near at hand, to be spread over the soil on the compartment which was thorough-trenched the autumn before last; and quicklime from the kiln, at the rate of seventy bushels per acre, to be slacked upon and spread over the soil, and immediately worked into the surface of the third division, or that which was thorough-trenched two autumns back, about the middle of March, to let loose the gases from stubborn organic matters, which, without being subjected to the action of the lime, would remain there in an inactive state perhaps for years. When trenching do not obliterate the pieces of stout stakes, but allow them to continue to point out where the rows of Potatoes were last year, in order that the tubers may be made to occupy the sites of the trenches where the Cabbageworts grew. That will prove a change of soil to the uttermost that we are enabled to give, besides preventing the operator having to mark out the ground over again. Now plant at the first favourable dry time; and should the soil, from very recent trenching, prove loose,

when forming the ridges, in lieu of finishing them off at once (when a superincumbent weight of earth might cause a troublesome displacement of their sides), cast part of the crumbs from the trenches upon them, and bury the sets merely 3 inches or so. In a fortnight or so, when the ground has settled, shovel out the remainder of the soil from the trenches, and the ridges may then "rest and be thankful," though the mind of the worker must at once think about how the trenches are to be occupied, as I previously explained.

I have yet another tangent to fly off at relative to the prosperity of their future occupants. About a month ago I received a box from the office of this Journal containing a disinfecting powder. When the box arrived I thought to myself "Ah! some more Potatoes." On wrenching off the lid I said "It is a disinfectant," but on taking the bag out of the box I saw the outlines of an orchard-house pencilled on the piece of deal which formed its bottom, and it struck me as being very like the fine new one I saw being erected when I last visited the nurseries at Sawbridge-worth. Then I imagined it might have come from Mr. Rivers, who had thus kindly treated me to a bag of powder for the destruction of the aphid family. I happened to have a Calceolaria infested with the green fly, and I at once suited the action to the thought by giving the foliage a good dusting over. The pests evidently did not like it, but I saw by next morning that they were mostly proof against it, so on the day after I set myself to work with it at the tanks. I was enabled to give it a fair trial, for up to that time I had applied none of the powder I keep by me for the purpose of fixing the ammonia, and it was also the first time I had disturbed the tanks this spring. The gases issued very strongly, as I purposely routed the liquid about, to make the worst of it. I began upon the tank which catches all the dish-washings and waste water from the scullery, when the following sentence in a shrill treble distinctly smote upon my ear, "Ah, that nasty tank!" I do believe I have educated the noses in this house till they have become quite spoilt. Even so, because our housekeeper has latterly declared that the disinfecting powder I have used so long and satisfactorily to myself, smelt so strongly of tar that the odour made its way up the drain from the tank into the kitchen and constantly gave her a headache, I am very thankful to say that the new powder I have received from some person unknown has made peace between me and the women, and what greater thing can I say in its favour? I will say, however, that the composition is the best of its kind I ever used. It is equal to the deodorisation of the strongest ammoniacal issue whatever. The rate I applied it was about two ounces to a gallon of liquid, by stirring a quantity of it at once into the whole body of the sewage. If I had qualified the powder, in the same way one does with soot or lime, in a certain quantity of water in a tub, and applied it dissolved in that form to the sewage, and allowed twenty-four hours to elapse before emptying the tank, no doubt it would have been the proper way; but I was too impatient for that. It killed the effluvia almost entirely in a very short space of time, and what scent it has of its own is as sweet as a nut. Had I attempted to empty the tanks without the application I should have run the hazard of being indicted for a nuisance. The disinfectant applied with a large dredging-box to recent fecal matters prevents all unpleasant smell directly. I trust I shall soon learn whence it came and where it is to be had; and I shall be glad to find out if it possesses as a part constituent phosphate of lime, as that when applied to house sewage is an addition which enhances its value immensely.

Allow me now to conclude by stating how happy I am to learn that Mr. Bevan Fox is giving the ridge-and-trench plan a trial, forming his parallels and working in his trenches on account of the Potato. I can assure him it is a step in the right direction, and much more likely to benefit the human race than those other trenches and parallels we are so sorry to read about on the other side of the water. It is a great many years since I began to beleaguer these pages on the subject; and twelve years ago I rushed pen in hand against some of our greatest horticultural authorities, who were foreboding the disappearance of the Potato from off the face of the earth; and I quote a passage from the article I then wrote, expressing that I intended to persevere in its cul-

tivation—a determination I have now no cause to regret, and one in forming which I cannot say I have erred:—“Nov. 1852.—Notwithstanding the general failure of the Potato crop this year, what I have formerly urged relative to its culture I still maintain. Perseverance in its cause must be insisted on; and in defiance of all that grim foreboders may sing or say against it, I for one intend to plant Potatoes. Let men say all that they can possibly say in foretelling its certain destruction. I reply, We do not live in the times when wiseacres are prophets. What though we are tossed at sea in this matter, without a compass to guide us! I, for one, at least will make an attempt to steer. Failing in this, I can at least pull a rope; and so long as the vessel continues to float I will not be the person to encourage despair. Until she evidently does become a wreck and all hope is cut off, then, and not till then, will I cast myself from her.” And two years after I penned that I began siege operations in this corporate borough; and in my enthusiasm I was prompted to deliver a lecture on the Potato in the Town Hall. I believe the subject fell dead; albeit I gave it for the benefit of a young literary institute here that I then, along with a few others, felt peculiarly interested in firmly establishing. I was gratified to learn, however, that a young curate said he “did not see what good a lecture on growing Potatoes could do.” And again—merely forearming me for the way that the cat was going to jump—a hirsute Bombastes-Furioso-Sir-John-Falstaff-rolled-into-one sort of a man, gave it as his opinion that he “knew how to eat a Potato, and that was sufficient for him!” The former, I am happy to say, since then is married, and has a living and a family, so in all probability his ideas have become modified; but as to the latter, I can well believe his instincts remain the same up to this very day.

I have this year thirty-four sorts of Potatoes growing in the garden, including the new variety from Huntingdonshire, an “early Potato” from Scotland, a new Regent from Berkshire, and thirteen seedlings which never saw the outside of these premises.

I hope Mr. Fox will let us know the result of his enterprise; for the more private experiences of the sort are laid open to the public, so much the more easily are people enabled to take stock of ideas for their personal benefit. And if I were to fill a whole JOURNAL OF HORTICULTURE with an article advocating the cause of the Potato I should not consider I was doing an unwise or unnecessary act; for surely pointing out every exertion and precaution that can be made is no mean employment in a writer striving to impress upon his countrymen the necessity of employing every means in their power for the preservation of this necessary esculent which a bountiful Providence has presented to us for food.—UPWARDS AND ONWARDS.

FURZE OBNOXIOUS TO CATERPILLARS.

It may be interesting to your readers to learn that I have tried this as a remedy, or rather preventive, to the Gooseberry caterpillar. I was recommended to try it at the instance of my employer, who said it was a certain remedy. Just as the Gooseberry bushes were in flower, or a little prior, when Furze was in flower, a goodly-sized branch was placed in the centre of each Gooseberry bush, and as near to the bottom as possible. The whole of the bushes were free from the caterpillar that season. In the following season there was no flower on the Furze in the neighbourhood, therefore a green branch only was placed in the bushes, and the ravages of the caterpillar were not prevented, though the bushes were not so much affected as those without the Furze bushes.

On naming this to those recommending the remedy, I was told that the Furze was most efficacious when in flower; but that the green branch itself was not relished by the caterpillar, and so mitigated the evil to a certain extent. I give this as I found it, and think it not unworthy of a more severe trial.—G. A.

INFLUENCE OF FLOWERS.—During the raid of General Quantrell in Kansas, and the sacking and ravaging of Lawrence, the Confederate force came to the residence of George

Ford, whose neat house was surrounded with flowers. The soldiers appealed to their leader to spare the place “as it was too pretty to burn;” he assented, and the house was spared, being almost the only building left.—(*Boston Cultivator*.)

A VERY USEFUL GLASS STRUCTURE.

In your Journal of April 19th, page 297, one of your correspondents asks for suggestions as to shading Ferns from hot sun, if green or other coloured glass be not employed. I effect this object by placing mine (not exotics) on a platform 2 feet from the ground on the under part of my flower-stand; the lowest shelf for the flower-pots being again 2 feet 7 inches higher than the Fern plant-stand.

There are four shelves for plants, each about 10 inches wide, except the top one, which is 2 feet wide. Of course, they become gradually shorter as they rise to the central or top one. The shelves, as well as the lower portion for Ferns, are made of strong deal laths instead of boards. Besides the water usually required by Ferns, they of necessity receive additional water when the plants above are watered; but for my common Ferns this is rather a benefit than otherwise.

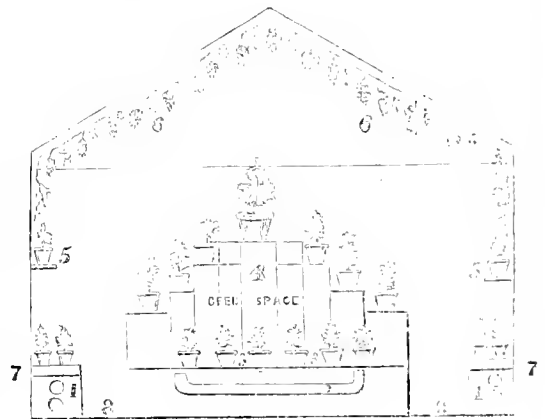

- | | |
|---|---------------------------------|
| 1 Four-inch hot-water pipes. | 5 Strawberry-shelf. |
| 2 Glazed drain-pipe for flue round or under Fern-frame. | 6 Vines. |
| 3 Fern-platform. | 7 Glass rises from here. |
| 4 Flower-stand. | 8 Flagged path, 30 inches wide. |

The conservatory is built on arches, and the Vine roots run both outside and inside.

The house is lofty, being 11 feet to the springing of the span-roof, which, to the apex, again rises 4 feet 6 inches. It is placed with one end to the south-west, the other end opening by the glazed folding-doors into the library, and it has the sun on it from 9 A.M. for the rest of the day.

There are Vines trained on the roof which answer well, and afford a good shade for flowers and Ferns. In cold weather I heat the house both by hot-water pipes and by a twelve-inch flue of glazed drain-pipes.

It is 20 feet square, has a flagged walk round the plant-stand, and round the sides, at 2 feet high, a zinc trough 20 inches wide and 4 inches deep, to hold sand, in which plants for propagation and planting-out are placed; and at 7 feet from the ground a shelf 12 inches wide runs round for Strawberries or other plants.

At the south-west end a glass door opens into an orchard-house 30 feet long. The potted trees are now beautiful, and setting well.

You will thus perceive that I have four tiers, and five purposes to which I apply my conservatory:—the Fern-platform, and on the same level the propagating-shelf, the stand for plants above the same, Strawberry-shelves at the sides, and Vines on the glass roof.—E. S.

CRYSTAL PALACE.—On the 10th of June next the Crystal Palace will have been opened ten years. During that period it will have been visited by the extraordinary number of

more than fifteen millions and a quarter of persons. There can be little doubt but that with the increased facilities of reaching the Palace, the numbers during the coming ten years will greatly exceed those of its first decennial existence.

CULTURE OF THE FIG TREE.

NOTICING in THE JOURNAL OF HORTICULTURE under the heading "Doings of the Last Week," by "R. F.," a short note on the culture of Fig trees in pots, I am reminded to bring under the notice of the readers of the Journal a subject which I have for some time thought of; but before doing so allow me to say the management of Fig trees planted out and of Fig trees in pots appears to me to be identical, except in the necessity of frequently watering potted trees. Neglecting this for a few days only, the whole crop will be destroyed.

I have under my care some trees planted out on open walls, and others under glass. Three large Fig trees are covered in and trained to a wall facing the south-east, the front lights being 5 feet from the trees and 9 feet high. Two of them are Brown Naples, and they every season produce a quantity of fine fruit; and the third (a branch of which I forwarded to you by a friend last Friday), grows in the same house, and, as you will perceive, fruited. Year after year it shows the same, but on attaining a little larger growth than at present the fruits turn yellow and drop off, and not one arrives at the state of perfection attained by those produced on the other trees. The three are treated exactly alike, being watered with manure water two or three times at this season when they are bursting into bud, and syringed every day.

Fourteen or sixteen years ago, I am informed, this tree was planted in a vinery and trained up the back wall, where it received the benefit of fire heat and the same treatment as the Vines. There it did not bear, and in consequence it was removed to an open wall; but for the last three years it has been under glass without fire heat, as above stated, and still no fruit fit for table is gathered from it. I am ignorant of the cause, and should be very glad of the opinion of yourself or any of your readers as to what it is.—THOS. NEWMAN, *Tory Hill, Sittingbourne.*

[Fig trees in pots and others planted out are so far identical when both are under glass, no artificial heat given, and only one crop taken. In either case short stumpy wood well ripened is the chief point to be aimed at, and no stopping, except of the leading shoot as it swells in spring. Under glass and with heat, where several crops are taken at least double stopping is desirable. Out of doors summer stopping on the whole is inadvisable, as it would give either a forest of shoots or cause the fruit to show in the end of the summer only to fall in winter. From summer-made shoots we can get a good crop under glass, especially if assisted with a little heat. Out of doors such crops do not come to anything north of London. We saw a wall nicely covered with young fruit in August from summer shoots, but not one came to anything. Some kinds of Figs with all the care possible are inferior in fertility to others. If your tree suffers from overluxuriance the remedies for keeping the fruit on are ringing or root-pruning. We some time ago reported finding part of a tree extra fruitful, short wood, short joints, &c., whilst the rest of the tree was vigorous and next to barren. On examination we found that mice had nibbled the bark from the fruitful branches. See "Doings of the Last Week."]

NEW BOOK.

Window Gardens for the People. By the Rev. S. HADDEN PARKES. London: S. W. Partridge, 9, Paternoster Row.

THE first idea which will occur to many after a perusal of this book, will be that the author is evidently of opinion that the establishment of flower shows for the poor will remove nearly all the evils which at present seem to be inseparably connected with the crowded habitations of the poor of London and other large towns. We own to some such feeling ourselves; but may honestly add that we have for some time past entertained the same opinion, and the

perusal of Mr. Parkes's book has only strengthened a conviction which was already pretty firmly rooted.

Three years have elapsed since we first drew attention to, and unhesitatingly expressed our approval of, the scheme which was first started in Bloomsbury for establishing flower shows for the poor; and now we have before us the whole history of their establishment, and the experiences of the gentleman who originated and has been mainly instrumental in carrying them out.

At the risk of being thought by some of our friends to be a little extravagant in our ideas, we do not hesitate to express our opinion that they will ere long be found one of the most powerful agencies yet brought into play for the amelioration of the condition of the working classes, for we believe that both directly and indirectly they are capable of effecting an incalculable amount of good. We cannot, therefore, content ourselves with dismissing this subject and the book which treats on it with one of those short stereotyped sentences which seem to be written only for the purpose of being inserted in advertisements. Did we attach less importance to the subject we might be content with saying, "This is a most readable little book, and we strongly recommend it to every one who has to superintend a parish or a district."

We feel sure that none of our readers will complain if we devote some small portion of our space to the consideration of the objects and effects of this modern institution of flower shows for the poor, any single one of which is calculated to do more real good than all the exhibitions held under the auspices of our great societies. It is certainly true that the majority of people in the upper classes have a strong natural liking for plants and flowers, and we cannot suppose that the poor are differently constituted from other people. We cannot but think that one great reason why the efforts of so many benevolent people are attended with so little success is because they proceed on exactly the contrary principle, and in all their dealings with the poor act as if they belonged to a different order of beings.

We think that the poor are in many respects rather like children as compared with the upper classes, for they often have the same fine sensitive feelings and the same affections and inclinations, and, if these be only carefully and delicately brought out and encouraged, they will become as strong in the poor as in ourselves, and will exercise the same influence for good. The last few years have shown most clearly that the working classes have a great taste for music, and it is daily becoming equally clear that a large proportion of them have a natural affection for plants and flowers; and in the little volume before us we not only find strong instances of their interest in plants, but also how best it may be encouraged and turned to good account. One poor woman, speaking of her Geranium, says, "I did not believe that I should ever care for anything again in this world as I have cared for that Geranium. Indeed, I've got almost to love it as if it could speak." In another case a poor man, who never left his room and shunned all society, was in the first instance induced to come out for the purpose of bringing his plant to the flower show, where it won a prize, and has since without solicitation been a regular attendant at the Sunday evening service held in the neighbourhood. Many similar instances might be adduced, all tending to show that the influences exerted by the love of plants are of the most various kinds.

We have not space to touch even briefly upon the details of the system on which the flower shows for the working classes of Bloomsbury are conducted, but they will be found at length in Mr. Parkes's book, together with the reasons which suggested their adoption. We do not suppose that the system has as yet been by any means brought to perfection; but the main difficulty is not so much to make great improvements each year as to keep up the interest of the class for which the shows are intended.

In order that as few as possible may be discouraged by failure, we think some pains should be taken to instruct the poor in a few of the simplest rules which have to be observed in the treatment of their plants. At first the prizes should be more numerous than valuable, in order that as many as possible may be encouraged to persevere; and we have little doubt that in a short time the inducement of prizes will no longer be required, but a few window

plants will become a necessary piece of furniture in every poor man's room, and will in many instances be looked upon as members of the family.

The number of these shows is largely on the increase, and we hope that in a few years there will be at least one every year in each poor London parish; but before the experiment is made for the first time in any parish we strongly recommend that Mr. Parkes's book should be carefully studied, as it fully sets out the difficulties which have to be encountered, the way in which they may best be met, and the good which will in all probability follow.

ENTOMOLOGICAL SOCIETY'S MEETING.

THE April meeting of the Entomological Society was very fully attended, the proceedings possessing unusual interest. The chair was occupied by F. Pascoe, Esq., F.L.S., President of the Society. Donations from the Natural History Societies of Munich, Brunn, Stettin, &c., to the library, were announced, including also the eighth volume of Mr. Stainton's beautiful illustrated work on the "Natural History of the Microlepidoptera." A new part of the Society's "Transactions" was announced as ready for distribution among the members.

Mr. F. Smith made a further communication on the supposed luminous powers of the *Fulgora candelaria*. It was stated that the insect was known in China under the names of the Star of Eve and the Star of Confucius; and Sir J. Barrow had also affirmed that the insect possessed luminous powers. On the other hand, Mr. Bates stated that, during his long residence in the Amazon Valley, he had had repeated opportunities of observing and keeping alive the *Fulgora lateraria*, the species reported to be luminous by Madame Merian, and that the natives had no rumour or tradition of its emitting a light.

Mr. Newman exhibited, on the part of Mr. Butler, a series of insects preserved in amber and gum anime (similar to those described by Mr. Hope in the "Transactions" of the Society), and made some observations on the species exhibited.

Mr. Pascoe exhibited a box containing forty new species of Australian Longicorn Beetles, additional to those described in his memoirs read to the Society at previous meetings. He also made some remarks on the peculiar structure of the abdominal segments in various species, as affording specific and sexual indications.

Mr. A. R. Wallace exhibited a magnificent series of Butterflies belonging to the genus *Papilio*, captured by himself in the islands of the Eastern Archipelago, and remarkable as exhibiting various instances of dimorphism, trimorphism, and even polymorphism, in the females of species, the males of which were known only under one form. Thus, whilst the male of *P. Pammon* is a black insect, with white spots on the wings, the females are either quite like it in colour and markings, or they are parti-coloured, forming the so-called species *P. Polytes* of Linnaeus, of which no parti-coloured male is known. In *P. Ormenus* there were exhibited three different forms of the female, without any connecting link between them; and it was stated that the males paired with the different forms of the female, and that the brood in each case assumed the different forms, and was not confined to the form of the female parent. "The phenomena exhibited by these insects might be paralleled by supposing the discovery of an island inhabited by white men, and black, red, and yellow women, and in which the union of these varied parents produced children which always resembled one or other of the above forms, no intermediate forms ever occurring—the boys being always white, but the girls black, red, or yellow, without any necessary connection with the colour of their mother; so that, for instance, a black girl might be the offspring of a white father, and either a black, red, or yellow mother."

Professor Westwood exhibited a splendid Butterfly from Ceram, recently forwarded to the Museum of Oxford, from the Leyden Museum, which he was induced to regard as a large local variety of *Papilio Peranthus*, but which Mr. Wallace considered to be a distinct species. He also exhibited a new species of Walking-leaf insect from the Feejee Islands, and read the description of a gigantic Phasmidon, under

the name of *Heteropteryx Hopei*, of which a unique specimen is preserved in the Oxford Museum, having formed part of the Bell collection, acquired and presented to the Museum by Mr. Hope shortly before his death.

The Rev. Hamlet Clark read some entomological extracts from letters recently received from Mr. John Gray, who is engaged in collecting insects at the Cape de Verd Islands and St. Vincent's.

Mr. Douglas Timmins sent some notes on the insects observed in the neighbourhood of Cannes during the past winter months.

General Sir J. B. Hearsey exhibited a volume of drawings of the transformations of Indian Butterflies and Moths, made by one of the members of his family.

Mr. S. Stevens exhibited a collection of Lepidoptera and Orthoptera, sent by Mr. Diggles from Moreton Bay, Queensland.

Mr. D. Sharp exhibited *Stenus Kiesenwetteri*, one of the Rove Beetles, new to this country.

Mr. F. Smith read a memoir on the hexagonal construction of the cells of Wasps and Bees, in opposition to the theory of Mr. G. R. Waterhouse, who had read an elaborate paper on that subject at a recent meeting of the Society.

DOINGS OF THE LAST WEEK.

KITCHEN GARDEN.

HOED amongst Peas, Beans, Potatoes, Cauliflower, Cabbages, &c. Earthed-up forward Cauliflower, and covered over the ground with short grass to prevent evaporation. Scattered ashes and lime over beds of seedlings. Hoed between Carrots, which are as yet not large enough for thinning. Find that early September-sown Onions are now useful for many purposes, though too strong for bulbing nicely. Those sown in the end of September are bulbing well, but the transplanted ones we always fancy do best. Of our early Beet not a plant is left above ground. We were served three times the same way last year by the birds, and so in self-defence we have sown a lot under protection and mean to transplant. Until last year the birds never troubled them, but now no sooner does half an inch appear above ground than it is nipped off for a salad, and nothing seems sufficient to stop them. We dare say they have found the little red seedlings very sweet, and the young progeny are instructed in what is good for them. We planted the other day a nice edging of a fine, dark Spinach, the colour very much like Beet when young. A single thread stretched along has pretty well saved them—only a few of the plants had been pulled up and left lying, as they had discovered the mistake in time, if they thought the plants were Beet. Had we not seen sparrows and other birds at the Beet, we should not have known who were the depredators, as they do not leave a vestige of the plant above ground. It is fortunate that Beet transplants well, and after the plants are 2 or 3 inches high nothing will meddle with them.

Planted out Lettuces for succession. Where there is plenty of ground it is best to sow where the Lettuces perfect themselves; but where there is scarcity of ground the best plan is to make a small seed-bed and transplant. Those in the orchard-house were valuable this spring. Regulated Cucumbers, thinning out the vines, and shortening the shoots by pinching the ends, and will plant a bed with struck cuttings in a day or two. The rains have done great good to all crops, and will do much to secure a good hay crop, which must have been deficient if the dry weather had continued much longer. Took up a piece of Potatoes under protection that we might plant a lot of Dwarf Kidney Beans started into stout plants in boxes. These will precede a row sown in the orchard-house. Sowed succession Turnips and Radishes. It is best to sow often and but little at a time. A sweet Turnip 2½ inches across is always crisper and sweeter than one of 5 or 6 inches.

FRUIT GARDEN.

Run the hoe again through the *Strawberry-rows* that no young weed should be left, and scattered the ground thinly with lime to keep all slugs and worms at a distance. If there is any chimney-sweeping we will follow in a week with a sprinkling of soot, and then cover slightly with straw or

litter to keep the fruit clean and moist. Took out Strawberry plants done bearing, and put about the last row in-doors. These were taken up about three weeks ago, potted singly in 40-sized pots, and plunged out of doors in a heap of leaves that gave a gentle bottom heat. The trusses are now opening their blooms, and the pots are crammed with fine fresh roots, and the ball as firm with them as a piece of cheese. These can hardly help doing well. We have a fine show in 32-sized pots now, but, on the whole, during the season the 40-sized pots have produced most plentifully according to their size. We mention this chiefly for the benefit of those in cold places, who prefer the runners of this year for forcing early next season. Farther north, when large pots are used, either the plants are forced two years, or the late small runners of 1864 are planted out thickly, and are potted in 1865 and forced in 1866. For all early work much of the success will depend on having the pots full of roots early in autumn, and it is easier filling a 40-sized pot than a 32 or a 24, as some gardeners use.

We must disbud a few Peach trees out of doors as soon as possible, as the little shoots are crowding each other; but we will not overdo it at once, as these leaves shelter the young fruit, and we may yet have frosts pretty sharp. Removed the last of the covering from some *Fig trees* out of doors. One, from a little neglect, will not have so much fruit as usual, and the two others, like those of one of our correspondents this week, will have a good supply. We noticed a little peculiarity in these two trees worth mentioning. To save covering, the outside branches were unnailed and fastened loosely over the central ones, which remained nailed as they stood last summer. A little straw was stuck among the branches, and that was kept in its place by thin spruce branches tied on. The covering was not thick enough to prevent the wind and air passing pretty freely among the branches, but quite sufficient to prevent injury from any common frost, and if it had come very severe we could have put a little more covering on. The trees seem all right; but here is the fact worth chronicling—the branches that remained nailed to the wall are much more forward than those fastened over them. The crisp young fruit on the first are as large as peas—some of them as large as a horse bean, whilst the young fruit on the other branches are just peeping at the joints, not much larger than pin-heads, and some not so large. With the exception of one set of branches being close to the wall, and the other 2 or 3 inches from it, there was no difference as to the protection, &c. The shoots on these trees are beginning to show the necessity of root-pruning, or root-curbing, as they are getting longer than we like to see them; and when that is the case fruit is sure to show in the autumn near the base, and it will drop in winter, or at least be of little use next season. When these shoots of last season are allowed to run on now from their terminal buds, there is the risk that a good many of the fruit well back on the shoot will never come to anything, but will drop long before they swell much. To lessen vigour, and throw back the natural sap of the plant to benefit the fruit at this critical stage, we have, for many years, nipped across, or cut across the terminal bud of the shoot when it is, say, three-quarters of an inch long. This arrests, for a little, mere growing, and the young fruit receive a greater amount of help to start them. The nipped bud will soon push again, and frequently give three shoots instead of one, and these will require thinning-out, retaining only the best. In luxuriant trees we have seen heavy crops obtained by ringing the stems, taking out about one-eighth to one-quarter of an inch. We liked best to do this when the fruit were a little larger than beans. In such ringed shoots all the fruit we have seen came to maturity; and on the extra-luxuriant unringed shoots most of them would drop at the second swelling. In all such cases of too great luxuriance, root-pruning and confining the roots to little space are the best and most efficient remedies.

Watered Figs, planted in a shallow bed in-doors, now swelling freely. There is so much drainage and a hard bottom below that there is little risk of overwatering at this season, if the plants have not become too dry. These Fig trees generally bear most abundantly with little trouble. In their case we remove the fruit that we do not mean to swell—that is, those no bigger than large pin-heads, in No-

vember, nip the points of the shoots early in the spring, and stop the young shoots in summer for the second crop.

Thinned and tied wood in orchard-house, and thinned a great many of the fruit. Removed the Peas in pots to the bottom of a wall, as they are getting too forward for our wants. We have others planted out to succeed them. Thinned Grapes, which is just now a serious task, choosing for the work mornings and evenings and some of these dull days. In very sunny days such work is slow murder. The young man who goes to such work late and early of his own accord ought never to be refused the full complement of time for visiting places or seeing his friends when time is less valuable. Regulated and pegged down the shoots of late Melons. We could not find room for very early ones this season. We find that few people will venture on Melons. We have been told repeatedly, "The fruit looks nice, and smells nice; but, then, we would rather have something we can eat." A Fig, too, is a most luscious fruit, but it is only worth growing where there are Fig-eaters. In the general run of company we should suppose that those who are partial to Figs will be something like one in a dozen. We have omitted one thing about pruning and pinching Fig-tree shoots, and that is that all who have tender skin should use gloves. This season we have escaped pretty well. Last year we happened to draw the back of our hand over our brow, and brow and the back of the right hand got inflamed and unpleasant as if spread over with the nettle brash. The juice is very acrid. It will also disfigure clothes where it drops.

ORNAMENTAL DEPARTMENT.

A good many *Hollyhocks*, old stools, notwithstanding all our care, have bid us farewell, though the roots are all sound enough. Properly speaking the *Hollyhock* is a biennial, and something like three or four years may be their general duration, though we have known some stools for ten years, and then throwing fine spikes every season. By thinning some of the old stools, and planting seedlings and cuttings of last season, we have made all regular and trim, and would like to give them what we cannot afford—a good dressing of rotten dung and a manure-watering a fortnight hence. Thinned also all the extra shoots. Those from 4 to 8 inches long will make fine plants next season if firmly planted in a border in rows a foot apart and 4 inches in the row. Seed may also be now sown, but if of fine sorts it is best to sow under the protection of glass and then transplant in a similar manner. These, with a few evergreen branches among them in winter will stand well and will flower next season. Attended to herbaceous plants as we could. The principal work, however, has been fresh edging with the iron all flower-beds and borders, so that they may be clipped easily all the summer, digging and turning over the beds, and preparing for planting, and actually planting a few things, as we wanted the pots they stood in to forward other plants that were rather backward. All bedding stuff that is large enough is now fully exposed. Some are still driving along, such as the *Verbenas* lately put in, and which, though tiny bits, are doing well and growing fast. The weather is so dull and warm withal, that we expect to have a good many thousands out before this is read. To do so we will turn out the hardiest first, and when beds and borders are to have something in them more tender than others we will delay these for a fortnight or more. For instance: we will not turn out the *Amaranthus melancholicus ruber* nor the *Centaurea candidissima* just yet. As a general rule we plant thickly: it is easier to thin than to make up a thin bed. There is, certainly, as Mr. Keane says, no great difficulty in filling the beds when you have decided on what is to go into them, and have the wherewithal for the purpose; but there is difficulty in getting such numbers of plants in good order, and also in deciding how to make the most of them, and yet change the cropping and, to a certain extent, the appearance every year. Gardening thirty years ago was a sinecure in many respects compared with what it is now.—R. F.

TRADE CATALOGUES RECEIVED.

J. Stewart & Sons, 21, Nethergate, Dundee, and Fort Nurseries, Broughtly Ferry.—*Catalogue of Dahlias, Hollyhocks, Cinerarias, Fuchsias, and Bedding Plants.*

E. G. Henderson & Son, Wellington Road, St John's Wood, London.—*Spring List of Plants, with three plates.*
Carter & Co., 237, 238, and 261, High Holborn, London.—*The Gardener's and Farmer's Year-Mecum. Part III. Plants.*

COVENT GARDEN MARKET.—MAY 14.

Supplies are abundant, and the demand brisk. English Grapes and Pines are very good, and quite sufficient for the demand. Forced Strawberries are easier. Peaches are excellent for the season. All kinds of vegetables are plentiful; and as home-grown Lettuce and other salads are coming in more abundantly, there is a corresponding decline in imports from abroad. Cut flowers mainly consist of Orchids, Heaths, Pelargoniums, Roses, Violets, and Mignonette.

FRUIT.

	s.	d.	s.	d.		s.	d.	s.	d.
Apples.....	½	6	to	4	Nectarines.....	0	0	to	0
Apricots.....	doz.	0	0	0	Oranges.....	100	8	0	14
Figs.....	doz.	12	0	20	Peaches.....	doz.	30	0	40
Filberts & Nuts 100 lbs.	0	0	0	0	Pears.....	bush.	0	0	0
Gooseb. Green ½ sieve	6	0	10	0	dessert.....	doz.	0	0	0
Grapes, Hothouse...lb.	8	0	14	0	Pine Apples.....	lb.	6	0	10
Foreign.....	2	0	4	0	Pomegranates.....	each	0	0	0
Muscats.....	0	0	0	6	Strawberries.....	oz.	0	6	1
Lemons.....	100	4	0	10	Walnuts.....	bush.	14	0	20

VEGETABLES.

	s.	d.	s.	d.		s.	d.	s.	d.
Asparagus.....	bundle	4	0	to	3	Leeks.....	bunch	0	4
Beans, Broad.....	bush.	0	0	0	0	Lettuce.....	doz.	1	0
Kidney.....	100	2	0	3	0	Mushrooms.....	pot.	1	0
Beet, Red.....	doz.	1	0	3	0	Must. & Cress, punnet	0	2	0
Broccoli.....	bundle	0	9	2	0	Onions.....	bushel	4	0
Cabbage.....	doz.	1	0	1	6	pickling.....	quart	0	6
Capsicums.....	100	0	0	0	0	Parsley.....	½	sieve	1
Carrots.....	bunch	0	6	6	8	Parsnips.....	doz.	0	9
New.....	1	0	1	6	8	Peas.....	quart	3	0
Cauliflower.....	doz.	4	0	8	0	Potatoes.....	sack	6	0
Celery.....	bundle	2	0	3	0	Radishes doz. bunches	0	6	0
Cucumbers.....	each	0	9	2	0	Turp.	0	6	1
Endive.....	score	1	3	2	6	Rhubarb.....	0	4	1
Fennel.....	bunch	0	3	0	0	Sea-kale.....	basket	1	6
Garlic and Shallots, lb.	0	8	0	6	6	Spinach.....	sieve	2	0
Herbs.....	bunch	0	3	0	0	Turnips.....	bunch	0	6
Horseradish.....	bundle	1	6	4	0	New.....	1	0	

TO CORRESPONDENTS.

* * We request that no one will write privately to the departmental writers of the "Journal of Horticulture, Cottage Gardener, and Country Gentleman." By so doing they are subjected to unjustifiable trouble and expense. All communications should therefore be addressed solely to *The Editors of the Journal of Horticulture, &c., 171, Fleet Street, London, E.C.*

N.B.—Many questions must remain unanswered until next week.

BOOKS (*J. F. Goring*).—Consult Mr. Fleming's "Spring and Winter Flower Gardening," it gives all the information you require. You can have it free by post from our office for thirty-two postage stamps. (*G. Reynolds*).—Sowerby's work on Grasses, published, we believe, by Pamplin, Frith Street, Soho Square, will probably suit you.

ADVERTISEMENTS FOR GARDENERS (*O. O.*).—We charge for each 2s. 6d.

SCOTCH KALE (*H.*).—Mr. Fish is not certain whether the Scotch Cabbaging Kale is the name he had with it at first. He used to grow the Tall and the Dwarf Scotch Borecole, and beautiful Curlies they are—quite as hardy, and more beautiful than the Cottager's Kale and other praised novelties. In habit, the Cabbaging Kale is between the Tall and the Dwarf as respects height. In winter there is less difference between them, but in spring the heads and the side shoots are much closer and more compact. Even now, the second week of May, when Brussels Sprouts, Cottagers' Kale, &c., have all bolted, these cabbaging ones are very good, and come in for the hall in turas with Broccoli, Cabbage, Spinach, &c. In Messrs. Carter's list, there is one named the New-headed—which may be the same. The Feathered, we presume, is identical with a pretty dwarf Curly that stands the winter well, and is very late in giving sprouts. It yields much less than the mild Scotch Curled Borecoles, that used to be called German Greens. Buda Kale, or Asparagus Kale, is very nice in spring, when it throws out its many young shoots that are nearly as sweet as Asparagus; but this is sown early enough in June, as, if planted out early, the shoots will be made in the beginning of winter, and the frost will kill them, when strong plants that have not thrown out the side shoots would stand uninjured.

VINES MILDEWED (*A New Subscriber*).—The predisposing cause to mildew in Vines is insufficiently ripened wood. The summer of 1861 was cold and wet, and doubtless the wood of your Vines was indifferently ripened. Among the accelerating causes may be mentioned principally, a low temperature, an over-moist border, a crowded state of the wood and foliage. Your best course to follow this year will be to see that there is no stagnant moisture about the roots, to train the shoots thinly, and protect the border from soaking rains. Should the malady again appear dust the first indications of it with flowers of sulphur, and paint the wall with sulphur mixed in water; and if you could protect with canvass in cold damp nights it would be beneficial. Cold and damp, without a full play of air and light about the foliage, are very favourable to mildew.

MANURE (*C. E.*).—If you send four penny postage stamps to our office, and direct "Matures for the Many" to be sent in your address, you will find that had more directions than we could afford space for in an answer.

FORCED VINES (*Grape Vine*).—We do not think you have any reason to be so alarmed. You have done quite right to stop steaming the house, and a little sulphur on the hot-water pipes or flues will act as a check on the mildew, only you must be cautious not to let the pipes or flues become too hot, or the sulphur fumes will kill the Vine foliage and destroy your crop. By all means cease syringing the Vines after the Grapes change colour, and give air freely early in the morning, shutting up early in the afternoon, and if you could leave a little air on at night, even if you have to keep a briske fire, that would materially assist their colouring well. We would advise you to keep the covering on the border until the Grapes are thoroughly ripe, and then the border should be protected from heavy rains if the Grapes are expected to hang for any length of time.

PEAS AND BEANS DESTROYED BY BEETLES (*Ler*).—We have grown Peas and Beans for many years, and never knew them devoured by beetles such as you describe, so that we do not know what beetle it is, and cannot, therefore, name a remedy. Send us a specimen in a pill box. We know of no better early-hearing Cabbage than the true Kenfold Market.

PELARGONIUMS FROM SEED (*Perio*).—Seed sown now, or during next month, ought to give plants that will flower well another year. The seed should be sown now, and the seedlings grown on, pricking out or potting them when large enough, pursuing this treatment so as to have them strong before winter. A shilling packet of seed may give you some good flowers, but we very much question whether many of them will be equal to existing varieties. It is very rare indeed that flowers of good form and substance can be had even by preferred Pelargonium-growers from seed of their own saving; but we do not wish to be understood to say you need not expect fine flowers from purchased seed. We have had fine kinds from seed at times, but at others we have found them very indifferent.

SOWING CALAMPÉLIS SCABBA (*Idem*).—The seed should be sown in a compost of loam and leaf mould, and be placed in a hotbed to get it up, after which the young plants should be hardened off, and then potted off into small pots, and grown on to a frame until they become sufficiently large to plant out. If you sprinkle guano round the pots of Cinerarias you will find ants will not remain long in the frame, or, if they really have taken up their abode in the pots, you may dislodge them by placing the pots in a bucket of lime water; or watering the plants with guano water, 2 ounces to the gallon of rain water, will prove equally efficacious.

TULIPS IN FLOWER-BEDS (*H. S. A.*).—The mode of culture you pursue is the cause of the flowers coming poorer year after year. You do quite right to grow them in pots plunged in the beds, for this enables you to move them in order to fill the beds with bedding plants, without taking up the bulbs before the growth has been completed, which weakens the bulbs, and we are not quite certain whether those grown in pots and plunged in the beds are not also weakened if taken up before the leaves turn yellow, especially if the roots penetrate much through the pots into the soil. We advise you to allow the bulbs to remain in the beds as long as possible, and when you move them to replunge the pots in an open, dry, sunny situation, for by placing them in a shady spot you prevent the thorough ripening of the bulbs, on which depends next year's flowering. When the leaves are quite yellow take up the bulbs, and store them away in a cool dry shed. In September they should be potted in a compost of turfy loam half, leaf mould one-fourth, and well-rotted manure one-fourth, with a sprinkling of sharp sand intermixed. The bulbs should then be plunged in an open situation in the garden, and in their final quarters as early as circumstances will permit. We do not know of any method adapted to your case that will enable you to make them bloom so finely year after year as they do the first year or two after they are received from Holland.

RHONODENDRON DALHOUSIANUM BLOOMS SPOTTED (*K. T.*).—The deficiency of colour in the bloom of your plant may be owing to some deficiency in the compost, imperfect drainage, or too little pot room. The blooms probably are spotted by syringing them when expanded, or by a close confined atmosphere. Want of shade, or exposure to too much light and heat, we consider, cause the early falling of the flowers. We advise you to repot in some good sandy peat, providing efficient drainage, and to give the plant no more heat than is absolutely necessary for it, or to place it in the coldest part of the conservatory. When in flower the shadiest part of the conservatory is most suitable, and this with a dry atmosphere will prevent spot, besides prolonging the beauty of the flowers. At other times the plant cannot have too much light.

VINES SLIGHTLY MILDEWED (*An Old Subscriber*).—Dust the Vines thoroughly with flowers of sulphur, and let it remain on the leaves. Also ventilate more freely, and keep the air of the house rather less moist.

FERNERY (*T. G.*).—We incline to believe that the Ferns become brown and die owing to the gas stove being inside the fernery, which renders the air too dry for them. For heating a fernery we much prefer hot water, either in pipes or a tank. Perhaps a vessel of water on the stove, the evaporation of which would mitigate its drying tendency, might be remedial. Are your Ferns properly shaded?

HEATING GREENHOUSE FROM SITTING-ROOM FIRE (*A Lady Gardener*).—Unless you keep a good fire in the room during cold nights you will not have heat enough for the greenhouse. It would be better if the air-pipes were close to the front wall and one in each corner at the front, as this will promote the circulation of the heated air. If these pipes are kept moist the air will be moist enough.

FLOWER-BED PLANTING (*Calcearia*).—It will much depend whether your bed is to be sown from both sides or only in front. If the latter, the planting will do with small plants. If to be looked at from both sides, three rows will answer better, and our plan would be to have a centre line of one colour, and a band all round. When many colours are wanted in such a narrow bed, it is best to throw the bed into a parterre of small beds in the planting, making some neutral flat the connecting link. Your circles will no doubt look well planted with Christine in the centre, banded with Madame Vaucher, and edged with Cloth of Gold; but, perhaps, the last-named will be apt to make Madame Vaucher look washy and mean. Were we to plant, we would prefer Cloth of Gold for the second band, and Madame outside. Or if the plants of Madame are strong place that in the centre, then Christine, followed by Cloth of Gold.

GERANIUM MRS. POLLOCK (*T. Sampson*).—It is a good hedder, and endures the sunshine well.

WEEDS ON WALKS (Inquirer).—Sec "Doings of the Last Week" lately. Nothing is safer than salt, but kept a foot from the Box. If you do not mind the appearance the simplest plan is to sow it on a sunny day so as just to whiten the soil. The dews will melt it, by degrees.

PLANTS TO GROW IN OLD OAK STUMPS (Idem).—The Canary-creeper, *Tropaeolum canariense*, will be very effective allowing it to dangle at will. *Lophospermum*, *Maurandya*, *Cobaea*, &c., would also do, but you would require good plants of them. Any of the *Nasturtium* and *Convolvulus* tribe might also be sown now and do well. The rougher the pollard, and the more natural, these creepers grow the better. In placing such old stumps "in a prominent place," much judgment is required, or there may be as much inconsistency as there would be in placing a rustic porch at the entrance of a Grecian mansion.

TRANSPLANTER (G. White).—We have seen the tool you mention, but do not know the maker's name, and are quite sure that it is not to be preferred to a good garden trowel for the purpose.

Kew Gardens (An Amateur Florist).—Any one is admitted into the houses at Kew Gardens which we noticed.

LARGE WELLINGTONIA GIGANTEA.—I have a *Wellingtonia gigantea* 14 feet high and about 11 feet in diameter at bottom, with thick foliage close to the grass.—C. Woodlands, *Red Hill*.

FLOWER-BED PLANTING (J. G. S. Lee).—Your object seems to be to have a white edging for the five beds, to suit the white edging of the border on the other side of the walk, and we can find no fault with it. In another year you might contrast the edgings of these five beds with blue, yellow, and purple, all of which would contrast with the border edging.

GLASS FOR VINERY (An Amateur).—Nothing answers better than 21-oz. sheet glass, of good quality. 16-oz. glass answers perfectly, and is about 1½d. per foot less in price, but is more liable to breakage from frost and hailstorms. Taking all things into consideration, we prefer, for horticultural purposes, 21-oz. glass of good quality, but would employ Hartley's rough plate if it could be afforded. It is the best glass for any purpose whatever, and would be more extensively employed if its price could be reduced. The difference between good and bad glass amounts to this—the latter is worthless, and the former does not scorch the leaves, or obstruct the solar heat and light, from the impurities which are ever present in glass of bad quality. We think you will be able to manage a vinery 60 feet long by 15 feet. Such a house would give you employment for about an hour and a half in the morning in syringing, firing, &c., and the same in the evening; and would require an hour's attention for giving and taking off air during the day. We may just give you a hint. The distance you name, 2½ feet, is too little to allow from Vine to Vine. They should not be less than 3 feet apart, and 4 feet if you expect to grow plants under them. We know amateurs who manage vineries 100 feet long by 18, and do most of the work before and after business hours. Without a knowledge of the time you could devote to your vinery we cannot speak more decidedly.

SEEDS FROM AUSTRALIA (Lex).—No one could tell the species from the seeds. The three probably are of a *Dolichos*, and the more numerous seeds of an *Acacia*.

STAND FOR FERNS (E. M.).—We know of nothing more suitable and substantial than that you name—viz., galvanised iron wire. You may have it made in any desired shape, only it should hold a fair amount of earth (9 inches), and if the bottom and sides be covered with moss to hold the soil in its place until the roots take hold, you may safely plant the Ferns in it. They look much better planted out than grown in pots.

LATERALS ON PEACH TREES—VINES INJURED BY GUANO-WATER (A Constant Reader).—Pinch them back to the last leaf or first from which they proceed, and so on if they break again from the lateral. We cannot imagine how your Vines could be injured by the ammonia generated by watering your plants with guano-water four or five times a-week; but you may have syringed the Vines themselves with guano-water at the rate of 2 to 3 ounces of guano to a gallon of water, which is much too strong for the foliage. If this is not the cause of the leaves being spotted we think it must be a deficiency of air in the early part of the day; or the spots may be attributed to the scorching qualities of the glass. It is just possible you may have syringed them rather late some morning, and the sun unexpectedly shone forth on the leaves when covered with pearly drops of water. The sun suddenly drying up the moisture would cause the leaves to decay where the water stood. We think you apply the guano-water in too powerful doses to your *Fuchsias* and *Pelargoniums*. 2 ounces of guano to a gallon of water is quite strong enough, and this should not be applied oftener than twice a-week.

COMPOST FOR BALMS AND COCKSCOMBS—PIMELEAS DONE FLOWERING (Another Constant Reader).—Turfy loam from rotted turves three-fourths, and one-fourth cow or sheep manure one year old. If manure water be at hand the manure may be omitted. *Pimeleas* done flowering should be reared for a short time, a fortnight or three weeks, by placing them in a cool, well ventilated, and light situation in the greenhouse. After this cut them back to within an inch or so of the old wood, always securing a nice-shaped plant, and cutting out shoots that cross each other. When the shoots have grown an inch or so repeat the plants if they need it, being careful not to destroy many of the delicate fibres, and to secure good drainage.

MELON CULTURE (Idem).—Melons in houses should be syringed lightly at shutting-up time, or a little afterwards, and every available surface syringed in the morning to keep up a moderately moist atmosphere until the fruit attain its full size, when syringing overhead should be discontinued, and a drier atmosphere secured by gradually reducing the sprinkling of the house. The temperature should not be allowed to fall below 65° at night at any stage of growth, and if that can be secured without employing much fire heat at that time, a little air at night will be all the better for the plants.

NAMES OF PLANTS (E. Noxon).—1, a very dark Wallflower; 2, *Anemone nemorosa*, or common Wood Anemone. (*G. D.*)—1, *Erys pollicata*; 2, *Marrubia bicolor*; 3, *Bossia linophylla*; 4, a crushed *Oncidium*. (*F. Z.*)—1, *Pteris serrulata*; 2, *Adiantum cuneatum*; 3, *A. capillus-Veneris*; 4, *A. acrostichum*; 5, *A. filix-mas*; 6, *A. alatum*. The Orange blossoms were decayed. (*J. Pearson*)—1, *Berberis japonica*; 2, *Spiraea lavigata*. (*A Lady at Winchester*)—1, too young to recognise; 2, *Lastrea dilatata*, perhaps the *var. collina*, but too young; 3, *Lastrea Filix-mas*; 4, *Asplenium trichomanes*; 5, *Polypodium vulgare*; 6, *Oxalis*, not recognisable. (*L. N.*)—Plants not numbered! *Potamogeton crispum* and *Anacharis alismarum*. (*F. C.*)—The specimens enclosed are of the Hornbeam (*Carpinus betulus*), and the Ring-leaved Sallow (*Salix annularis*).

POULTRY, BEE, and HOUSEHOLD CHRONICLE.

POULTRY SHOWS.

MAY 26th and 27th. WOODBRIDGE. Secs., Messrs. Dallsger and Whistock, Market Place.

JUNE 1st. BEVERLEY. Secs., Mr. H. Adams and Mr. J. Kemp, jun. Entries close May 21st.

JUNE 2nd. NORTH HANTS (BASINGSTOKE). Sec., Mr. Henry Downs. Entries close May 11th.

JUNE 13th to 17th, 1864. BATH AND WEST OF ENGLAND, AT BAISTOL. Steward, S. Pitman, Esq., Bishops Hall Manor, Taunton. Entries close May 19th.

JUNE 15th. THORNE. Sec., Mr. Joseph Richardson. Entries close June 4th. JULY 14th and 15th. EASTERN COUNTIES. Secs., Messrs. Ranson and Simpson, Stowmarket. Entries close July 1st.

JULY 19th, 20th, 21st and 22nd. NEWCASTLE-UON-TYNE. Secs., Mr. Wm. Trotter, Bywell, and Mr. J. Shortrose, Shieldfield Green, Newcastle-upon-Tyne.

AUGUST 17th. COTTINGHAM. Sec., Mr. Joseph Brittain. AUGUST 22nd, 23rd, 24th, and 25th. ALEXANDRA PARK. Poultry, Pigeons, and Rabbits. Sec., Mr. William Houghton. Entries close July 16th.

AUGUST 27th. HALIFAX AND CALDER VALE. Sec., Mr. W. Irvine, Holmfield, Ovenden, near Halifax.

POULTRY SHOWS, JUDGES, AND EXHIBITORS.

"A chiel's amang ye takin' notes,
An' faith he'll prent them."

ALL my life long I have been a lover of beasts, and all cattle, worms, and feathered fowls—in fact, of all that has animal or vegetable life; but it was not until about this time last year that I became a breeder of poultry and a reader of your Journal. From both I have derived pleasure, and in different senses profit also.

In November last I first ventured to write in your Poultry Chronicle, being moved to do so by a communication which appeared in your paper from "AN EXHIBITOR IN A SMALL WAY," of which class I am one. My contributions to your Journal excited some attention from your correspondents, but none of their communications gave me more satisfaction than a notice from the "WILTSHIRE RECTOR," who endorsed the remarks of "EGOMET," as "MERISUM." Gladly would I see the rivalry of poultry exhibitors, and the decisions of judges, carried on in that spirit of fairness and brotherly love which always pervades the communications of your reverend correspondent. Experience has shown us that another spirit too often prompts us all. Scarcely had I attempted to assure "AN EXHIBITOR IN A SMALL WAY" that his groans were somewhat without cause, and that a remedy was in his own hands, when I was involved in a hot discussion of a matter where unfairness and positive dishonesty on one side or the other existed. I met the question fearlessly, and was ably supported by others. The result may have been unsatisfactory in its extent, but knavery was placarded, and honest men were aroused.

We are now entering on another eventful season of poultry shows, where unfairness, knavery, and disappointment will have the opportunity of raising ill blood. What is to protect us from knavery? Who is to satisfy disappointment? There are no rules in poultry matters as there are of the Marylebone, the Jockey Club, and even of the prize ring. An appeal to THE JOURNAL OF HORTICULTURE, the *Field*, or even to *Bell's Life*, would not be recognised. Poultry exhibitors are at the mercy of the various opinions and tastes of honest judges, the dodges of dishonest ones, and the grumbings of unsuccessful exhibitors. A Poultry Club, at least as far as I have been made acquainted with it, has not solved the difficulty, although this is the only method by which uniformity and satisfaction can be attained. Of this and a plan for working out the scheme I hope to write to you at another time. In the meantime it is better to consider what can be done under existing circumstances.

A suggestion from one of your correspondents in your Number of January 13th, 1863, is worthy of repetition. He says, "Why should not each show publish in the catalogue of prizes the particular points of the fowls in each class requisite to enable them to take a prize?" This would avoid all difficulties as to qualification, and prevent the appearance of unfairness with honest judges, because the exhibitor would know what was expected of him, and could strain to reach that mark, or decline the competition altogether. If

judges were not honest, and past experience has shown us that they are not all so, then I would recommend the plan which I proposed last year, and from which I did not shrink when it was necessary to use it—namely, that of ventilating thoroughly the suspected fraud, a plan which will not be found to be without its beneficial effects, and in support of which I am as ready now as I was then to be foremost at the cost of much trouble, and notwithstanding an aversion to disputes.

With regard to the various opinions and tastes of honest judges, who can tell, for instance, how he is to exhibit Game fowls with any certainty of success, unless a notice be put forward by each show of what will be required? What protection can be obtained against dishonest judges and exhibitors, except by a combination of honest men, and the publication of facts which shall make the names of the offenders stink in the nostrils of the world, and cause the right-thinking to avoid those shows where dishonesty and unfairness are tolerated?

I will hope that the suggestion as to what will be required in shows will be adopted, and that the other suggestion will not be needed; but let us be ready, and determined vigorously to put it into execution if wanted. It is better that poultry shows should be broken up altogether than that knavery should be tolerated. It is better that poultry-keeping should sink into the promiscuous breeding of cocks and hens for food, than that it should be a source of dissension.—EGOMET.

ROOKS.

THE young rooks in the trees close by are beginning to be very noisy in their nests (I write on the 4th of May), so that soon these birds of the sable plume will have their annual attention paid to them by the sportsman. He will soon "pop" the disagreeable question, "Come down and be plucked," in a loud and most displeasing manner, and will have the negative from all the Master and Miss Rooks who can by any means "get off." But putting the sportsman's love of rooks out of the question, it being a brief and mercenary love, yet everybody blessed with high trees likes rooks to build in them, and no bird throughout a large portion of the year is more interesting to the naturalist. For instance, what lover of birds has not listened with delight to the rooks cracking their wings above him in the bright clear atmosphere—an infallible sign, say the country folks here, that the weather will not continue fine for long. The gathering together of the rooks above their trees late in the evening is another pleasing sight; "the rooks saying their prayers," as a little girl remarked to Gilbert White.

But I am wandering from my purpose. Let me give the history of two rookeries, one at this present time almost deserted, the other crowded with birds. In regard to the former there has been every care bestowed for years to avoid frightening the birds: not a young rook was killed, not even a gun pointed at them, yet this rookery has become thinner, and now there is scarcely a nest, to the great sorrow of the gentleman who resides near. As to the other rookery, the plan adopted for many years was to kill a certain number, not very many, but still the rooks did not greatly increase. After a while a new proprietor came, and a much larger number of young rooks were killed, to the great horror of the old inhabitants around, who feared that their feathered friends would be exterminated. But, lo! the rookery became fuller and fuller, as if, at any rate, all the young rooks spared remained. What I want to know is whether this a common occurrence. I find there is a strong belief among some, that if you do not shoot the rooks at all, they, as if fearing they will be overcrowded, migrate, and the more you shoot the fuller will be your rookery. Can any lover of rooks who has long watched their habits, throw any light upon this subject? Have my two cases any others that resemble them?—WILTSHIRE RECTOR.

BUFF COCHINS.—A few amateurs propose to raise, by a subscription of £1 1s. each, a fund, to be awarded to subscribers' birds only, at the next Birmingham Show, in cups

or money, to the best pen of chickens and adult birds of the above breed. Subscriptions must be sent in on or before the 1st of July next to Mr. J. B. Lythall, Temple Street, Birmingham. When it is taken into consideration that this variety of domestic poultry is one of the most hardy and remunerative of the many breeds exhibited, we cannot doubt but that this additional inducement to competition will insure a great increase in the number of entries. We understand that a sale of fifty birds of the above variety, the stock of the late Mr. Statham, is to take place at Bingley Hall on the 24th inst.

COMPARATIVE ENTRIES.

In my remarks in No. 162, I see in the little table some errors have crept in, possibly they were my own. They do not affect the value of the table. Under Islington, No. 3 is omitted, and under Halifax, No. 6.

The only effect of these errors is to make Game, Cochins, Bantams, and Spanish one less in the aggregate, and Hamburgs two less. Their position is the same, except that Hamburgs are now one point better than Cochins, the breeds standing thus:—Dorkings 21, Brahmas 25, Game 27, Hamburg 28, Cochins 29, Bantams 31, and Spanish 33.—Y. B. A. Z.

A SWARM WITHOUT DRONES.

ONE of the hives referred to in No. 162, has this day (May 6th), sent out a very large swarm. There do not seem to be a dozen bees left in the old stock; but what puzzles me most is, that there is not a single drone in my whole apiary, nor have any of my neighbours any at present. Was I right in living it in a fresh hive, or should I have returned it?—F. W.

[You have done quite right. There is in all probability plenty of drone-brood in an advanced stage in the old hive. If not, the young queen will still have no difficulty in finding a mate, since it has been proved that two miles distance, and probably even more, is no obstacle in such a case.]

MODE OF DRIVING BEES.

I OBSERVED a description of "A DEVONSHIRE BEE-KEEPER'S" method of driving bees in the last volume of THE JOURNAL OF HORTICULTURE, page 423, and I see that he again refers to the same article by way of recommendation in his instructions to "PHILISCUS," upon artificial swarming, in your impression of April 26.

Summing, therefore, that he may not have seen the open method of driving, which according to my ideas is far preferable to the plan recommended by him, and which I have now practised for many years in preference to the covered and closed-up system as described by your correspondent, I now beg to offer him and your apiarian readers a description of the plan, hoping they will put it in practice; and I feel confident that they will ever afterwards do as I have done—leave off the wrappings-up, and enjoy a rich treat by having under their eyes the whole process of "a bee-fitting," the tractable, contented, and happy manner with which the bees leave their well-stored habitation for an empty one; and all that, with the freedom of taking wing and flying away, cannot fail to prove a source of pleasure and interest to the operator.

Those who may not have seen this practised may think the plan a rather bold and daring one, and that in attempting to force them into an empty hive open, the bees would either take flight and give battle to the operator, or otherwise fly back to their place in the apiary. Such is, however, very far from being the case; indeed, such is the peaceable manner in which they succumb to this sudden surprise, that I never use anything to cover my face and hands excepting my pocket-handkerchief and gloves. These are again removed as soon as the bees have filled themselves with honey and commenced their exit towards the top of the empty hive. This uncovering of the face enables me more perfectly to get a sight of the queen in her transit thither, and this I seldom fail in doing. It is a fact, probably not known even by many clever apiarians, that all the bees before leaving the hive, either in case of driving or swarm-

ing, fill themselves with honey—an instinct of nature against a rainy day. It is this circumstance which gives them so happy and contented a disposition, and which enables the operator to push and poke them about without resistance. It is, indeed, the freedom which may be used with them in this happy state that gives the principal advantage to open driving over the covered system, as they can be immediately put right when they have gone wrong. In the latter plan they are apt to cluster round the tops of the combs and the edge of the hive, so that no amount of beating will force them up, and there is, consequently, a good deal of after-work to do, and, moreover, if they do not go freely away at their first march they have always a tendency to get down amongst the combs afterwards and prove troublesome to get clean out.

A clear fine day, when the bees are principally abroad, I need hardly say, is the best time for the operation; although I have frequently done it on the open plan both

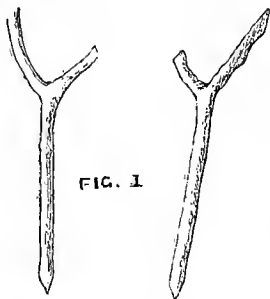

to be driven; scoop out a place for the head of the full hive, if the place is not suitable three brickbats will do to steady the hive while beating. Proceed next to the apiary with the other hive and board, cover the face and hands, then lift up the hive and board from the apiary, setting it on the ground in front, while the empty hive and board is substituted in its stead. Next remove the hive from the board, turning it bottom upwards. In this position hasten with it to the place where the hive and sticks were left, set it down on the spot selected, and give the sides a few sharp strokes with the hands. This will set all the bees in the hive to work filling themselves, excepting a few which will rise and fly off to their place in the apiary. During the interim of feeding make ready the hive to receive them by adjusting it on the edge of the hive which contains the bees, and supporting it at the back by the two forked sticks, keeping its crown at a sharp elevation (see figs. 2 and 3). This done, use the short sticks and

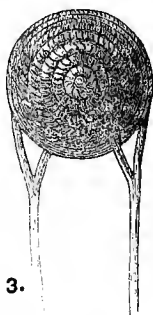
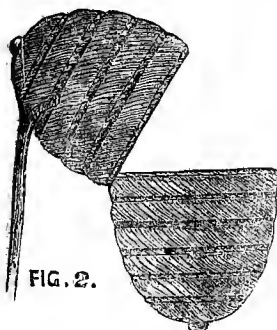

go on beating, when the bees will soon rise. Care must be taken at this stage to keep the empty hive at the side they make the first rush to, which is easily done by turning round the full hive, and, at the same time, keeping the upper one steady by the other hand. It is at this stage of the proceedings that I take off the covering from the face, so as to get a sight of the queen in going to her new residence. Any of the bees that rise at the commencement will, by this time, have gone all back to their places. There is now nothing more to contend with than in placing a natural swarm into an empty hive, and all will seem as happy and

well disposed. In the rapid rush upwards they are apt to get over the edge and round the sides of the hives; but if a strong feather or small twig be drawn over them a few times, they will soon make their way up. The same should be applied between the combs if they are inclined to linger, as the quicker the work is performed the more perfectly it will be done. When all is right remove the bees in their new hive to their former place in the apiary, turning the substitute-hive bottom upwards in the front, when they will soon rise and be all together again.—J. W. G. C.

FIXING COMBS IN BOX-HIVES.

Will you inform me which is the best and most expeditious way of fixing empty combs in a hive; and also what would be most proper for full combs, if any difference, I having box-hives, and not frame-hives, in my apiary? Having several empty combs I am anxious to let my bees fill them, but cannot get the combs to adhere to the roof of the boxes.—T. S.

[Empty combs are readily affixed to bars by means of melted wax, and full ones may be suspended by wires, as described in page 18 of the fifth edition of "Bee-keeping for the Many" (in which, however, the printer has inverted the woodcut); but we know of no method of doing this with simple box-hives. Might it not be worth while to add bars to your boxes?]

BEES ACCEPTING A FOREIGN SOVEREIGN.

LAST year I recommenced bee-keeping with one healthy stock which I brought from a distance of eight miles. All went well until the middle of April, when my attention was attracted by a great uproar in the interior of the hive as when about to swarm, the bees at the same time running in and out in the greatest state of excitement.

This was repeated a few days afterwards, and from that time all working operations ceased. Notwithstanding the beautiful weather of last summer not a bee could be seen going either in or out until about three o'clock in the afternoon, and then not one in three minutes on the average.

From past experience I gave them up as lost, considering them to have slaughtered their queen, and to be unprovided with a substitute.

Some time, however, in July, I read in your Journal that our apiarian friend, Mr. Woodbury, would, on application, supply the deficiency, and, thanks to that gentleman, my letter met with a ready response in the shape of a queen, surrounded by a dozen or so of her faithful subjects, being sent by rail a distance of upwards of eighty miles. These I introduced into their new abode on, I believe, the night of the 25th of July, and from that time all has gone on well with the exception of my having had to feed them through the winter (the operation having been performed too late to admit of their laying up a sufficient store). This I did by supplying them with a plate of honey at intervals of about three weeks or a month, and they consumed in all about five pints. The colony is now in full vigour, and little, if anything, inferior to two others standing near.

As the above facts may be useful to others of your readers, I send them for insertion, and am—A CORNISH BEE-KEEPER.

ARTIFICIAL SWARMS.

I HAVE much pleasure in corroborating what has been advanced by your esteemed correspondent "A DEVONSHIRE BEE-KEEPER" upon the advantages of artificial swarms, and can affirm that my swarms thus raised have far outstripped those of my neighbours which have come off naturally. My attention was first directed to the subject on account of the delay and uncertainty experienced in natural swarming.

I purchased my first stock in February, 1856, and the season though late proved very favourable. In the middle of June the bees began to cluster outside, and I, a novice, daily expected a swarm. It was not, however, before the

5th of July that it ultimately came off, after losing three weeks of most splendid weather. The following year the same stock began to cluster out early in June, and after waiting a week I resolved to try my hand at making an artificial swarm.

In the first instance I adopted the plan recommended by Dr. Bevan, in "The Honey Bee;" and having placed a comb full of brood and eggs in an empty hive, put it on the stance of the refractory stock, removing the latter to a new situation. This attempt proved a failure; the bees reared the brood, and then left the hive *en masse*, without having constructed a single royal cell. The old stock meanwhile again began to cluster out, so I resolved to attempt driving, and this my first operation of the kind proved perfectly successful; and I made a rule, from which I have never deviated, to at once drive any stock kept for swarming as soon as ever they begin to cluster outside the hive. I found the stock had made no preparation for swarming, and a friend had five strong stocks which persisted in hanging out during the whole summer without swarming, and proved lighter in the autumn than stocks which had sent out one or two swarms.

I do not remember a single failure in attempting to raise artificial swarms since the one already alluded to, and, with a little practice, do not see how Langstroth's plan, so ably advocated and successfully adopted by your valuable correspondent "B. & W.," can fail of success. If the stock from which the swarm has been forced is left to itself, after it has been placed on the stand of another stock, a strong swarm will probably issue forth under one of the young queens in from fourteen to sixteen days, and possibly a second swarm in two or three days afterwards, but the latter had better be returned to the parent hive, unless the proprietor wishes to raise young queens.—J. E. B., *Wolverhampton*.

FOUL BROOD, AND WHAT HAS BEEN WRITTEN ABOUT IT.

(Continued from page 307.)

SINCE last writing on this subject, I have succeeded in purchasing a copy of the French translation of Schirach's work on bees, written in 1770. This distinguished apiarian was pastor of Little Bautzen, in Upper Lusatia; and there can be no doubt that if we had access to his treatise in the language in which it was originally written, we should find the disease therein named, "*foul-brood*," as it is called by German apiarians of the present day, which name the French translator has rendered "*faux couvain*," whilst we approach more nearly to it in sound, if not in sense, by the appellation of "foul brood."

He says, "Foul brood is exceedingly dangerous. It is one of the most fatal maladies to bees, a true pest when the disease has attained a certain stage." He considers that it may arise either from the bees giving the brood unsuitable food, or from the queen depositing her eggs in a reversed position, so that the young bees, being unable to extricate themselves from their prison, die and putrefy. "Sometimes, also, the cold kills the young brood, and occasions putrefaction; but it is then, properly speaking, an accident, and not a disease." His remedy for foul brood consists of cutting out all the combs, and compelling the bees to fast for two days, after which they may be furnished with other combs, and fed either with honey and water spiced with nutmeg and saffron, or sugar and water flavoured with the same condiments, or we may give them simply "a cup of Spanish wine."

This, then, appears to be the origin of the crude ideas which English apiarian writers have entertained on the subject. Here we find the first mention of the whimsical notion of young bees being placed with "their heads where their tails should be," and the suggestion of feeding adult bees on "port wine," which if they would accept it appears to me very likely to reduce the elders of the hive to a similar condition. Coupled, however, with these preposterous ideas we have the foundation of the mode of treatment recommended by the first German apiarians of the present day.

Next in importance to Schirach's revelation of the extraordinary power possessed by bees of raising a queen or

mother-bee from a worker egg comes Dzierzon's discovery of the wonderful fact of parthenogenesis in the honey bee, or, in other words, the power possessed by virgin queens of laying eggs which will hatch into drones.

Like his great predecessor in the path of apiarian investigation and discovery, Dzierzon, by far the most distinguished apiarian of this the nineteenth century, is also a country clergyman, being pfarrer or pastor of the village of Carlsmarkt, in Upper Silesia. He commenced bee-keeping in the common way with twelve colonies, in 1835, and after various mishaps which taught him the defects of the common hives, and the old mode of management, his stock was so reduced, that in 1838 he had virtually to begin anew. At this period he contrived his improved hive in its ruder form, which gave him the command over all the combs, and he began to experiment on the theory which observation and study had enabled him to devise. Thenceforward his progress was as rapid as his success was complete and triumphant. Though he met with frequent reverses, about 70 colonies having been stolen from him, 60 destroyed by fire, and 24 by a flood, yet in 1846 his stock had increased to 360 colonies, and he realised from them that year 6000lbs. of honey, besides several hundredweight of wax. At the same time most of the cultivators in his vicinity who pursued the common method had fewer hives than they had when he commenced. In the year 1848, that fatal pestilence foul brood prevailed among his bees, and destroyed nearly all his colonies before it could be subdued, only about ten having escaped the malady which attacked alike the old stocks and his artificial swarms. He estimated his entire loss that year at over 500 colonies. Nevertheless, he succeeded so well in multiplying by artificial swarms the few that remained healthy, that in the fall of 1851 his stock consisted of nearly 400 colonies. He must, therefore, have multiplied his stock more than three-fold each year. His first Italian colony was obtained from Mira, near Venice, late in February, 1853.—A DEVONSHIRE BEE-KEEPER.

(To be continued.)

OUR LETTER BOX.

ROUF (*Black Bantam*).—There is no roup without discharge from the nostrils, and in that malady the swelling is generally around the eye and soft to the touch. If the malady you describe is what we imagine it to be, you will find on pulling the eyelid down and squeezing it gently that a yellow cheesy substance will come out whole. Ascertain that none remains, and wash freely and often with cold water and vinegar in equal parts.

CHICKENS DEAD IN THE SHELL (*Idem*).—If, when the time of a hen is up, you find dead chickens in the shell fully formed, the cause is, that the eggs have been too dry and the chickens could not get out, but if the chicken is only barely formed, the natural opinion will be that the hen sat badly. That which commenced life would have brought it to perfection if it had been continued. It is no injury to moisten eggs.

COCHIN-CHINA COCK (*C. D.*).—We can hardly think it is a case of leg-weakness. We presume he is an adult bird. As you say one leg is decidedly swollen, we should be disposed to think there is the seat of the mischief, and that it is to rest that leg he constantly sits down. Feed on oatmeal mixed with raw milk. You must watch and give castor oil when necessary. Let him have green food, heavy sods of growing grass. If you think him worth it, give him raw yolks of eggs. If the foot swells, and the thigh wastes, there is little hope of recovery.

VARIOUS (*Esser*).—When an egg is non-productive, for want of impregnation, it never emits any smell if broken. We have seen them perfectly clear after five weeks. In the offensive egg the germ has existed, and has been partially developed, and organised substances are more prone to offensive putrefaction. We know of no cure for egg-eating hens, except to give them hard-composition eggs to peck at. This sometimes cures them, as they tire of attempting to break them. Dorkings will sometimes come four-clawed, and are, nevertheless, pure; but if Brahmas have five claws they are unquestionably cross-bred.

PIGEON DISEASE (*J. F. D., Dewsbury*).—I beg to inform your correspondent that I have very little practical knowledge of the disease he mentions, of which his cock Owl Pigeon died; but if the case had been mine I might have tried something like the following:—a purge of jalap, infinitesimal doses of tartar emetic to act on the mucous membrane, and a solution of chloride of lime to counteract the putrid discharges.—B. P. BURN.

FOOD FOR YOUNG SWANS (*J. Higgins*).—Meal is the best thing to feed cygnets upon, and the way in which they prefer it is in a vessel about 7 inches deep, the bottom covered with a sod of grass, then a little fine gravel, and then oatmeal, the whole covered with water. A lettuce or two added to it will be an improvement. As they get older oats may be substituted for meal and put in a deeper vessel.

OBSERVATORY-HIVE (*R. N., Oxon*).—An observatory-hive might doubtless be constructed on the plan you describe, but the mechanical difficulties to be overcome would, we believe, render it complex and expensive, and we doubt its being so convenient as the hive with moveable combs invented by Mr. Woodbury. Inch shutters might do in warm weather, but you must bear in mind that the difficulty of guarding against changes of temperature is the weak point in all hives of this description.

WEEKLY CALENDAR.

Day of M th	Day of Week.	MAY 24—30, 1864.	Average Temperature near London.			Rain in last 37 years.	Sun Rises.	Sun Sets.	Moon Rises.	Moon Sets.	Moon's Age.	Clock after Sun.	Day of Year.
			Day.	Night.	Mean.	Days.	m. h.	m. h.	m. h.	m. h.	m. s.		
24	Tu	QUEEN VICTORIA BORN, 1819.	68.3	44.4	56.3	11	58 af 3	55 af 7	42 10	41 6	18	m. s	145
25	W	PRINCESS HELENA BORN, 1846.	66.5	44.5	55.5	15	57 3	57 7	21 11	54 7	19	3 19	146
26	Th	Mignonette flowers.	66.9	43.3	55.1	17	56 3	58 7	52 11	10 9	20	3 13	147
27	F	KING OF HANOVER BORN, 1819.	65.4	45.2	56.8	21	55 3	59 7	morn.	28 10	21	3 6	148
28	S	Common Sorrel flowers.	67.2	44.7	55.9	15	54 3	0 8	18 0	48 11	22	2 59	149
29	SUN	1 SUNDAY AFTER TRINITY.	66.3	44.5	55.4	13	53 3	2 8	45 0	after.	23	2 51	150
30	M	Yellow Rattle flowers.	69.0	45.4	67.2	15	52 3	3 8	8 1	21 2	24	2 43	151

From observations taken near London during the last thirty-seven years, the average day temperature of the week is 67.5°, and its night temperature 44.6°. The greatest heat was 91° on the 23th, 1847; and the lowest cold, 30°, on the 24th, 1854. The greatest fall of rain was 0.97 inch.

THE ROYAL HORTICULTURAL SOCIETY.

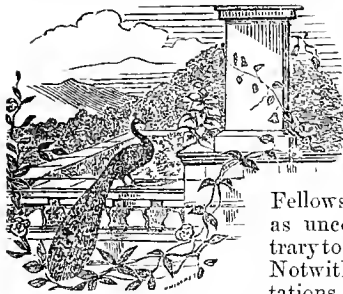

It will be remembered that at the annual meeting of the Royal Horticultural Society in February last certain proceedings took place, which at the time the horticultural Fellows of the Society regarded as unconstitutional, and contrary to the terms of the Charter. Notwithstanding the representations that were made to the

Council on that occasion, they thought fit to persevere in their headlong course, and set not only the Charter but the Society at defiance. Impressed with the conviction that the course the Council were pursuing was illegal, a number of the horticultural Fellows, to justify the position they had taken up, determined to take the opinion of an eminent counsel on the point, and we have just been favoured with a copy of the case and opinion, which has been laid before the Council of the Society. For the benefit of our readers and the Fellows of the Society we subjoin the case and opinion, with a copy of the correspondence that has taken place on the subject.

“Re THE ROYAL HORTICULTURAL SOCIETY.

“At the annual meeting of this Society held on Tuesday, 9th February, 1864, certain unconstitutional acts on the part of the Council in the election of members of the Council for the ensuing year, took place, of which a number of the Fellows of the said Society complain; and it is considered that, having regard to the Charter and Bye-laws, these acts or proceedings are of such a character as to render the election which took place a nullity.

“The attention of counsel is drawn to the 10th clause of the Charter, a copy of which is sent herewith, and marked A, to the 57th, 59th, 61st, and 62nd clauses of the Bye-laws of the Society, and to the schedule (Appendix 3) to the said 59th clause, a copy of which Bye-laws is sent herewith, and marked B, and to the following statement of the proceedings which took place at the annual meeting.

“Before the calling of the said annual meeting it became known to the dissentient Fellows of the Society, that five of the members of the Council had sent in their resignations—viz.,

- Earl Ducie, Mr. R. Cooper, Mr. J. Veitch.
- Dr. Lindley, Mr. J. Fleming,

“Now, in the 10th clause of the Charter, these words occur, ‘Any such annual meeting as aforesaid may accept the resignation, or for incapacity remove any one or more of the members of the Council for the time being, and elect in manner aforesaid, any person or persons from amongst the Fellows, in the place or places of the members so retiring or being removed, in addition to the member or members which the Fellows present at such meeting are hereinbefore authorised to elect.’

“Now, from these words it would appear that the resignation, to be complete, must be accepted by the Fellows

present at the annual meeting, and that upon such resignation being accepted, the Fellows present at such annual meeting are to supply the places of such resigning members by ballot; the Council having, as it would appear, no power to accept such resignations.

“By the first part of the 10th clause it is provided that the Fellows shall remove some three members forming one-fifth of the Council of the preceding year, and by method of ballot elect three other discreet persons from amongst the Fellows.

“There would, therefore, be eight vacancies to be filled up.

“It is, indeed, provided that in case of death or incapacity, ‘the number of members of the Council to be balloted out at such meeting shall be proportionably reduced,’ but nothing occurs in the said 10th clause of the Charter to extend this to resignations.

“On this state of facts the Council prepared a paper, a copy of which is sent herewith marked C,* containing the names of the five members who had resigned as above-mentioned, and headed the paper as follows:—

“Members of the present Council RETIRING from the said Council at the election of the 9th February, 1864.’

“Whereas, if reference be made to Appendix 3, referred to in the 59th clause of the bye-laws, it will be found that the names of three members only should have been inserted, and that the paper should have been headed—

“Three members of the present Council recommended to be removed from the said Council at the election on the day of

“The Fellows present, therefore, had no option of removing three members from the Council, and supplying their place from among their own body, nor had they the right of requiring that the resignations should not be accepted, and the resigning Fellows asked to reconsider their intention of resigning; and thus, through the unconstitutional proceedings at this last annual meeting, any member of the Council who might be objectionable to the Fellows was enabled to retain his place, the Council treating the resignations as removals, which it is submitted was ultra vires, as they must be bound by the Charter and Bye-laws.

“At the annual meeting on the 9th February, the Chairman announced five vacancies in the Council, but letters from two only of the five resigning members were read—viz., from Lord Ducie and Dr. Lindley. Balloting papers in the form above mentioned, marked C, were handed to the Fellows.

“These two resignations were put to the meeting for their acceptance, and it was voted that they be accepted.

“On one of the Fellows inquiring of the Chairman whether the other three were resignations or removals, he received the following answer—‘They are removals, at least they are recommended for removal.’

“A member of the Council then stated that they were all unqualified resignations, as in fact they were.

“An objection was then taken to the balloting lists as handed round to the Fellows, when the Chairman said—‘If

* “Members of the present Council retiring from the said Council at the election on the 9th of February, 1864—viz., Earl Ducie, Dr. Lindley, Robert Cooper, John Fleming, James Veitch. Members recommended to be elected—The Earl Grosvenor, M.P., Lord Henry Gordon Lennox, M.P., Henry Cole, C.B., James Bateman, Major Trevor Clarke. Any Fellow who disapproves of the names recommended above is requested to strike out such names as he does not approve, and to write opposite to each one so struck out the name of the person for whom he chooses to give his vote.”

they were going to discuss legal points they should frame them properly, and take them to some court of law and have them decided.'

"A verbal protest was then made.

"Balloting papers sent herewith, marked D* and E,† were then handed in for the purpose of being put in the ballot jars by some of the dissentient Fellows.

"Paper 'D' it will be seen follows the form given in the Appendix 3 to the 59th bye-law.

"No form of balloting paper in the case of resignations is provided for by the Bye-laws. But by these papers as handed in, the distinction between resignations and removals is brought clearly before the meeting, as should be done both by the spirit and letter of the Bye-laws and Charter.

"During a discussion which took place before the ballot, a question was put to the Chairman by the same Fellow who had put the former question—Whether a Fellow could be proposed and seconded at the meeting as a candidate in the place of any of the members nominated by the Council? To which the Chairman answered, That that would invalidate the ballot.

"This closed the discussion, and the ballot proceeded.

"Accompanying this case is a printed report of the proceedings of the annual meeting contained in THE JOURNAL OF HORTICULTURE AND COTTAGE GARDENER, to which counsels' attention is drawn (marked F). This report is from a shorthand writer's notes, but owing to the confusion in the meeting it is not sufficiently full.

"The Chairman having ruled as above-stated no nomination of a member was made by any individual Fellow, but some Fellows (as they were entitled to), struck out two of the names on the list prepared by the Council, and inserted two others in their place.

"On the announcement of the result of the ballot by the scrutineers, the names on the balloting list prepared by the Council were declared to be elected.

"The meeting was adjourned.

"It is a fact that the accompanying lists D and E were, on being handed in by the dissentient Fellows, allowed by the Council and counted in the number of votes in the ballot jars by the scrutineers, and notice was immediately after the election given to the Secretary to preserve all the lists used on the day of meeting.

"1st. It is considered that the Council's list is bad, as treating resignations as identical with removals.

"2ndly. That it is an illegal and unconstitutional departure from the form provided by Appendix 3 to the 59th bye-law.

"3rdly. That it is an 'irregular' and 'void' list under 62nd bye-law.

"And that a systematic, violent, and unconstitutional attempt to deprive the body of Fellows of their freedom of choice has been adopted by the Council.

"Counsels' opinion is requested—

"As to whether the proceedings adopted by the Council at the annual meeting render the election of the members in the Council's list irregular and null?"

"We are of opinion that the course adopted by the Council was irregular and a violation of the terms of the Charter and Bye-laws, and that a Mandamus will lie to compel the Council to proceed to a fresh election.

"ROBT. LUSH.

"JAMES EDWARD DAVIS.

"The Temple, 23rd April, 1864."

[COPY CORRESPONDENCE.]

ROYAL HORTICULTURAL SOCIETY.

"27, King Street, Cheap-side, London, E.C.

"26th April, 1864.

"To ANDREW MURRAY, Esq.,

Assistant Secretary, Royal Horticultural Society, South Kensington.

"Sir,—I am directed by the Fellows of the Society who, through one of their number, protested in writing against the illegal conduct pursued at the annual meeting on the 9th February last, to forward the original

* Three members of the present Council to be removed from the said Council at the election on the 9th of February—Sir C. W. Dilke, Mr. J. Clutton, Mr. John Lee. Three members to be elected in room of the above—Earl Grosvenor, Sir Joseph Paxton, Major Trevor Clark.

† Names of persons recommended to supply the places of resigning members of the Council at this election—Mr. Bateman, Mr. T. Rivers, Mr. R. Fortune, Mr. W. Paul, Mr. C. Edmonds. In place of—Earl Ducie, Mr. J. Veitch, Mr. R. Cooper, Dr. Lindley, Mr. Fleming.

opinion of Mr. Lush, Q.C., and Mr. Davis, for the consideration of the Council.

"You will be so good as to inform the Council that no steps will be taken in pursuance of this opinion, and the opinion itself will not be made public before Monday next, that the Council may have time to decide on the course they should adopt in order to satisfy the legitimate rights and wishes of the horticultural portion of the Fellows of the Society. The continued absence of counsel on the circuits has prevented this joint opinion being written earlier, though the papers have been some weeks before them. The former opinion of Mr. Davis, mentioned in the protest sent soon after 9th February, entirely coincides with the joint opinion of himself and Mr. Lush.

"You have the original balloting lists referred to as C, D, and E in the case. I will thank you to favour me with the final decision of the Council by Monday morning next.—I am, Sir, your obedient servant,

"JOHN KYNASTON, Junr."

"Accountant's Department, Royal Horticultural Society.

"South Kensington, W., 27th April, 1864.

"Sir,—As the Assistant Secretary with the chief members of our Council are now absent in Belgium, it will be quite impossible for an answer to be sent to your letter of the 26th by Monday next, as wanted therein.

"I expect them to return in the course of a week or ten days, when I will lay your letter and enclosure before them without delay.—I am, Sir, your obedient servant,

"John Kynaston, Junr., Esq."

"JAMES RICHARDS, Accountant.

"27, King Street, Cheap-side, London, E.C.

"2nd May, 1864.

"Sir,—I have submitted your letter of 27th April to my clients, and they have instructed me to say that in so important a matter they think every member of the Council ought to have the opportunity of being present. They will therefore refrain from taking any proceedings until Saturday next.

"They request me to desire you to acquaint the Assistant Secretary of the nature of the case and opinion, if you have not already done so, in order that there may be no delay in laying the same before the Council.—I am, Sir, your obedient servant.

"JOHN KYNASTON, Junr.

"To James Richards, Esq., Royal Horticultural Society, South Kensington."

"Royal Horticultural Society, South Kensington.

"May 5, 1864.

"To JOHN KYNASTON, Esq., Junr.

"27, King Street, Cheap-side.

"Sir,—I have laid your letter of the 26th April and 2nd of May, and the case and opinion which accompanied them, before the Council; and am directed in reply to inform you that the Solicitors of the Society are Messrs. Tatham & Proctor, 36, Lincoln's Inn Fields, and that they will receive service of any action your clients may think proper to bring against them.—I am, Sir, your most obedient.

"I return the case and opinion."

"ANDW. MURRAY.

It would appear, then, that the whole proceedings in the opinion of these eminent counsel are simply illegal, and notwithstanding this opinion, the Council mean to set the Society at defiance. How men of honour can accept such a position is for them to explain; but the fact of their doing so is an indication of what the Society may in future expect of a Council so constituted. It is gratifying to know that this is not the opinion of all nor even of a majority of the Council, but that the decision has been tolerated upon the dictation of two or three, who, we believe, are the very members illegally on the Council, and who seem to attain their objects by that bluster and arrogance which gentlemen do not care to place themselves in antagonism with, and, consequently, these two or three are allowed to have their way.

What course the horticultural party will now take we do not know, but we should advise them to remain content with the advantage they have gained. They have placed the Council, or rather the Council have placed themselves, in anything but an enviable position; and as they will maintain that position at any cost out of the already-crippled funds of the Society, we are of opinion that it will be consulting the interests of the Society not to cause any useless expenditure of its funds; for, seeing the Council do not intend to retire honourably from a position they hold illegally, it will be no satisfaction to obtain their removal at a cost which will only tend to bring the Society more rapidly to its fall.

THE ROYAL BOTANIC SOCIETY'S SHOW.

MAY 21st.

A MORE magnificent display of flowering plants than that which was made on this occasion it would be difficult to conceive: the plants were immense, and the blaze of colour which met the eye was almost overpowering. Indeed, had the day been as bright as those we have had lately instead of cloudy and threatening rain, this preponderance of colour would have been more felt; it was, too, a fault which one could well look over in a show in early summer, when the eye is not wearied by masses of colour out of doors, and

gladly seeks rest in green sward, leafy shrubs, and umbrageous trees. Still a greater proportion of foliage would have been an improvement; so, too, would it have been desirable that there had been less of art and more of nature in the specimens shown. They were grand examples of skill in cultivation, and of skill in training; but that mode of training was in almost every instance so stiff, so formal, and so smooth as to give an idea of constraint. This is an evil not peculiar to the particular show of which we write, but to all our metropolitan exhibitions. It has gone on increasing, and increasing, and it is time that a change should be inaugurated in which there will be less of sticks and tying-in and more of the natural growth of the plant.

STOVE AND GREENHOUSE PLANTS.—Collections of sixteen came from Mr. May, gardener to J. Spode, Esq., Hawkseyard Park, Rugeley, Mr. Peed, and Mr. Wheeler, who had respectively first, second, and third prizes. In Mr. May's collection were fine examples of *Acrophyllum venosum*, *Ixora crocata*, *Epaeris miniata splendens*, a very good *Gompholobium polymorphum*, a fine *Leschenaultia biloba major*, *Eriostemons*, *Aphelexis purpurea superba*, *Chorozema varia nana*, with fine orange and crimson flowers. Mr. Peed had nice plants of *Leptodactylon californicum*, *Aphelexis*, *Adenandra speciosa*, *Tetratheca ericeifolia*, and a large *Erica Cavendishii*. Mr. Wheeler had *Medinilla magnifica* very fine. Mr. Baxendine was also an exhibitor.

For collections of ten, prizes were taken by Mr. J. Fraser, of Lea Bridge; Mr. Rhodes, Sydenham; Messrs. Lee, Hamersmith; and Jackson & Sons, Kingston; and in the Amateurs' Class by Mr. Green, gardener to Sir E. Antrobus, Cheam; Mr. Chilman, and Mr. Kaile. *Leschenaultia biloba major* and *Medinilla magnifica* from Mr. Fraser were very fine; he had, also, a good *Stephanotis floribunda*, *Epaeris grandiflora rubra* very large, *Adenandra fragrans*, *Eriostemons*, an *Erica*, and *Azalea*. In Messrs. Jackson's collection the beautiful white and scarlet-flowered *Clerodendron Thomsoni*, and *Medinilla magnifica* were conspicuous; there were, also, *Labichea heterophylla*, and a very fine *Erica tricolor Wilsoni*. Mr. Rhodes had some excellent specimens, among which *Chorozema cordata splendens*, *Hedaroma tulipiferum*, and *Erica tortuliflora* were noticeable. In Messrs. Lee's lot, *Acrophyllum venosum* was decidedly the finest example shown of that plant.

Mr. Green exhibited a very fine *Stephanotis*, fine specimen *Azaleas*, *Rhododendron Gibsoni*, *Hedaroma fuchsoides*, and a very good *Erica depressa*. From Mr. Chilman came a very large *Erica Cavendishii*, and very good specimens of *Hedaroma tulipiferum*, *Chorozema coccinea*, *Acrophyllum venosum*, *Aphelexis*, and *Leschenaultia*; and from Mr. Kaile a very good *Tremandra ericeifolia*, *Erica depressa*, and *Pimelea spectabilis*.

In sixes, Mr. Page, Streatham, had a large *Hedaroma* and a very fine *Pimelea decussata*; Mr. Penny, St. Dunstan's, Regents' Park, *Statice profusa*, the heads of small purplish lilac flowers looking very well; and Mr. Kemp, gardener to Lord Lovaine, Albury Park, *Allamanda nerifolia*, and a good *Stephanotis*.

For mixed collections of flowering and fine-foliaged plants, prizes were awarded to Messrs. Lee, Williams, A. Henderson and Co., and Young, the last two being equal third. Messrs. Lee's *Cordyline indivisa*, *Alocasia Lowii*, and *Cibotium princeps*, were remarkably fine; and noticeable among the other plants were *Pandanus elegantissimus*, *Oreopanax dactylofolium*, and *Neottopteris australis*. *Laelia purpurata*, from Mr. Williams, had five spikes of its magnificent flowers; and from the same exhibitor came *Alocasia metallica*, *Cordyline indivisa*, *Gleichenia spluncue*, and *Cycas revoluta*, all of which were very fine specimens. Messrs. A. Henderson had *Crotos angustifolia* and variegata, a *Cyanophyllum*, with immense leaves, *Alocasia macrorrhiza variegata*, *Dieffenbachia maculata*, *Pandanuses*, *Caladium Belleymei*, much diversified with white, *Medinilla magnifica*, and *Oxylobium arborescens*, with small lanceolate dark green leaves and yellow flowers. In Mr. Young's fifteen were *Caladium bicolor splendens*, and *Chantini*, the foliage of both being very pretty; in the former as if powdered with a bright carmine, in the latter vermilion and white on an emerald green ground. *Begonia parvifolia*, with white flowers, and a variegated *Hoya carnosa*, were also noticeable.

ORCHIDS.—Of these there was a fine bank. In twenties

the prizes were taken by Mr. Baker, gardener to A. Basset, Esq., Stamford Hill, and Mr. Milford, gardener to E. McMorland, Esq., Haverstock Hill. In the collection of the former were the rare *Odontoglossum gloriosum*, remarkable for its rich colour; *Angulea Clowesii*, with nine fine flowers; the fine orange red *Saccobolium retusum*, with ten spikes; *Cypripedium villosum*; the fine variegated *Phalenopsis Schilleriana*, with a spike of its pink flowers; also the older and better-known *amabilis* and *grandiflora*, *Oncidium crispum* and *Dendrobium nobile pendulum*, very fine. From Mr. Milford came those splendid *Laelias*, *purpurata* and *Schilleriana*, *Cypripedium villosum* with twenty blooms, *Hookeri* with finely variegated foliage, *Odontoglossum Phalenopsis* and *navium*, the latter with nine fine spikes of its shred-like flowers, white and yellow, spotted with crimson, *Chysis Limminghi*, *Vandas tricolor* and *suavis* with fine spikes, *Cattleyas*, and *Phalenopsis*. Mr. Bullen, gardener to A. Turner, Esq., Leicester, contributed *Phaius Wallichii* fine, several showy *Dendrobiums*, among which *nobile* was remarkably fine, *Cypripedium Hookeri* and *barbatum nigrum*, and *Odontoglossum Pescatorei*, bearing its beautiful white, crimson, and yellow flowers.

For collections of twelve, prizes were awarded to Mr. Penny, Regent's Park; Page, Streatham; and Peed, Norwood, in the order in which they are named; and for sixes, to Mr. Williams, Messrs. Jackson, and Mr. Rhodes, among nurserymen; and to Mr. Wiggins, gardener to W. Beck, Esq., Isleworth, Mr. Green, Mr. Chilman, and Mr. Wheeler. In the above collections we noticed *Chysis bractescens*, *Cypripediums barbatum superbum*, *hirsutissimum*, *barbatum giganteum*, and *villosum*; fine examples of *Vandas insignis*, *suavis*, and *tricolor*; *Dendrobiums nobile*, *densiflorum*, *Dalhsonianum*, *Daganum*, *Paxtoni*; *Oncidium phymatocilium*, *ampliatum majus*, with two very fine spikes, *sphacelatum*, and *sarcodes*; *Saccobolium retusum* and the beautiful rosy lilac *Lobbi*; *Arides*, *Laelias*, *Cattleyas*, and *Phalenopsis*.

We must defer our remarks on the other objects exhibited until next week, but we cannot do so without noticing the magnificent *Azaleas* of Messrs. Veitch and Turner, which were glorious masses of bloom. The plants of the former were trained as pyramids, and from 6 to 7 feet high, with scarcely a leaf to be seen.

(To be continued.)

ROYAL HORTICULTURAL SOCIETY.

FLORAL COMMITTEE, MAY 17TH, 1864.—Many very interesting plants were brought before the Committee this day, and the certificates awarded were very numerous.

Messrs. Carter exhibited a basket of cut specimens of *Ornithogalum thyrsoides*, not a new plant, though not in general cultivation. Its noble handsome clusters of white flowers with a shaded centre formed a very interesting object, and as a decorative plant it will be most useful. The flowers were produced from imported roots—a special certificate was awarded.

Mr. Williams, Paradise Nursery, Holloway, sent a very curious variety of the *Aloe*, *Agave schidigera*. The character of this plant was remarkable from the delicate white cuticle, which appeared as if torn from the thick leaves, both on the edges and surface. This gave the plant an appearance of variegation—first-class certificate. *Dieffenbachia Baraquiniana*, a very singular plant, the base and footstalks of the leaves being pure white—this is a new plant, and considered valuable among fine-foliaged plants—a second-class certificate was awarded, but it will doubtless prove a first-class plant. *Dieffenbachia grandis*, differing from the other plant from its mottled markings of the footstalks and base of the leaves—this will also be useful to collectors of fine-foliaged plants—second-class certificate. *Amaryllis Excellent*, a deep crimson medium-sized flower. *Amaryllis Neptunc*, one of the striped varieties. *Aucuba japonica elegans* (? *latimaculata*), a Japanese plant which had been exhibited and noticed before. The plant was too small to form a correct opinion of its merits. *Cattleya* species from Brazil; *Coleus marmoratus*, a new hardy bedding plant, with light green foliage marked with reddish brown spots. This is supposed to be a useful variety for bedding purposes—second-class certificate.

Mr. Bull sent *Dieffenbachia Baraquiniana* and *Dieffenbachia gracilis*; also *Coleus marmoratus*, *Gynerium argenteum variegatum*, a beautiful variegated form of the Pampas Grass—first-class certificate; Lilac Dr. Lindley; *Pelargonium Clipper*. This promises to be one of the finest of the scarlet section. The plant had been evidently cut very close for propagation. The trusses were small, but the bright scarlet petals and perfect-formed flowers of great substance claim for it great merit. This will not, probably, be used as a bedding-out variety, but under careful treatment it cannot but be admired—first-class certificate. *Calceolaria Temple de Versailles*; *Aucuba japonica foliis marginatis*—this is known also as *Aucuba limbata*, one of the handsomest of the Japan varieties, and quite hardy—first-class certificate; *Gleichenia hecistophylla*, a very beautiful Fern—first-class certificate; *Euonymus japonicus var. latifolia*; *albo-variegata*, too tender for out-door planting.

Messrs. Veitch, Chelsea, *Acer species nova*, Japan, one of the most elegant of the family. The green leaves are finely cut and palmate. The plant was grown as a dwarf standard, and formed a very pretty specimen—first-class certificate. *Rhaphiolepis ovata*, a very beautiful evergreen, with dark ovate leaves of great substance, producing spikes of white flowers with pink stamens. This as a hardy-flowering shrub is of great value, and will doubtless be sought after by all lovers of evergreen shrubs—first-class certificate. *Camellia sasanqua, fol. var.*; *Camellia japonica fol. var.* Should this plant prove hardy in our changeable climate it will be very useful: the white variegation is very distinct. *Genetyllis sp. nov.* from New South Wales, resembling *G. tulipifera*, a promising variety—first-class certificate. *Cypripedium Pearcei* from Peru, an entirely new form of *Cypripedium*; flowers greenish white, deeply spotted on the slipper; the narrow side petals veined with green. This is probably an undescribed species. The foliage was very remarkable, being grass-like, also the manner in which its offsets were produced—second-class.

Mr. Smith sent plants of a seedling *Tropæolum* named *Pet*, and a *Mimulus*, *Purity*, both far behind others in cultivation.

J. Bird, Esq., Hammersmith, sent four flowers of tree *Picotees* and *Carnations*.

Messrs. Lee, Hammersmith, sent *Rhododendron Carnarvonianum*, very much like *Rhododendron azaloides*. *Cordylone Banksii*, this was a most charming specimen, its foliage most graceful, the plant throwing up a long branching spike of small delicate white flowers. As a decorative plant for the conservatory or greenhouse there cannot be one more graceful or elegant—first-class certificate.

Mr. Parsons brought two small plants of his seedling *Tropæolum Mars*, the bright scarlet circular flowers of which we noticed at the last meeting. He has kindly left them for trial at the Society's Gardens at Chiswick.

Mr. Eyles sent four plants recently received from Mr. Weir, the Society's collector, *Piperomia arifolia*, with mottled foliage, was awarded a second-class certificate. *Physurus*, new sp., very distinct and promising; three plants of an *Anthurium*; also, a *Dieffenbachia*.

After the meeting broke up an excellent and interesting paper on Ferns was read before the Fellows of the Society by Mr. T. Moore.

BEAUTY OF WALTHAM AND MADAME C. CRAPELET ROSES.

I AM not surprised to find that "D., Deal," wishes to get rid of this business. But he has made a statement which, if true, seriously compromises me with the public, and I think that I have a right to demand that he should either withdraw or substantiate it. "D., Deal," wrote, "Beauty of Waltham not distinguishable from Madame Charles Crapelet." These are his words, neither more nor less. (See *JOURNAL OF HORTICULTURE*, page 295.) My reply was, "It is not so." (Page 314.) "D., Deal," rejoined (page 328), endeavouring to qualify that opinion, but not retracting it; and, again (page 344), "Beauty of Waltham, confirming my opinion of it." It is a pity that he had not the moral courage or manliness to retract so damaging an assertion. But, no!

In the *Journal* of last week (page 362), he says he has *proved* so and so. This is "cool." "D., Deal," evidently mistakes assertion for proof. He has, as yet, *proved* nothing, although he has *asserted* a great deal. But I very much over-estimate the mental calibre of the readers of *THE JOURNAL OF HORTICULTURE* if they are misled thus. Mr. Prior (page 344) has quoted the old proverb "The proof of the pudding is in the eating," sagaciously adding "In like manner the proof of the Rose is in the growing." Well, we have not long to wait. The Roses will soon be in bloom, and will themselves *prove* what credit is due to the *assertions* of "D., Deal."—WILLIAM PAUL, *Waltham Cross, N.*

[Here the controversy had better conclude for the present. Let Mr. Paul and other Rose-growers exhibit the two flowers side by side, and let the public judge for themselves.—Eds.]

MR. MURRAY'S REASON WHY.

In the last Number of the "Proceedings" of the Royal Horticultural Society, I see a correspondent under the signature "F.," has written to Mr. Murray, at South Kensington Gardens, to ask him why he should call the tent that is now being erected there "a mast tent;" and Mr. Murray replies, "I call the tent a mast tent in order to mark its special character. Tents are supported by poles—this one is so big that poles won't do, and we had to get masts; and these masts so much out of the common way (being iron), that it seemed to me doubly legitimate to invite attention to the masts as a speciality."

Now, sir, is not a pole a pole whether it be a maypole 60 feet or a tent-pole 6 feet high? Are not masts part of the furniture of ships only, and are not masts as well as tent poles made of wood? What sort of logic, then, is this of Mr. Murray's, which calls a tent-support a mast because it is made of iron?—J. DENNES.

ON THE CRITICAL JUDGMENT OF NEW ROSES.

I FEAR your readers will have had more than enough of this little controversy about what my excellent friend, "S. R. H.," calls the "two Dromios;" but I think, before the controversy quite closes, I may be permitted to say a few words on the general aspect of the subject, especially as "P." has touched on another point which strongly bears on the subject, and has entirely mistaken the position I have maintained all through.

I have always said, and do still say, that it is a most difficult matter to decide on the merits of new French Roses, and that until they have been grown over here for two seasons we are not able to come to a just decision. Either they improve or they deteriorate; and so worked are the plants, so forced and cut about, that they have really no chance until that time has elapsed. Thus the French Roses, which came out in the autumn of 1862 will not be fairly known until this summer, when they are in everybody's hands. There are some so unmistakeably good that we at once set them down as A1, others so inferior that we at once discard them; but in the meantime the public want to know what they are like. We see them in the stands of "growers for sale," and give our judgment according to what they are there; and so far from an error or two in judgment being a proof that one is no guide, I do not think that I should have the slightest difficulty in proving that there is no Rose-grower in England who is a safe guide if failure in judgment on new Roses makes one an unsafe one, as all have been mistaken. Does not my worthy friend, "S. R. H.," who is *par excellence* the champion of the Rose queen, remember writing me a note once "*in re* Jean Baptiste Guillot," and questioning my condemnation of it as a hard bullet thing? Yet now it is not even in the "Rose Pope's" list—not even in No. 4; and every catalogue that I have ever seen has been misleading in this respect, that the compiler's judgment of new Roses is frequently at fault. Take, for example, "P.'s" statement about my disparagement of Comtesse Cécile de Chabillant. When I gave that opinion of it it was quite a new Rose. I had then only

seen it as a cut bloom, and that in the stands of one or two nurserymen; but when it had been generally distributed then its real character came out, or else it manifestly improved. It may not be uninteresting to say that Marest, the raiser of it, himself fell into the same error; for he told Mr. Standish and myself that he only made £50 of it, and that had he thought it so good as it really was, he might have made £200.

Then there is another Rose which in the same way improved—Duchess of Norfolk. It was raised by Margottin, but he did not think it worth sending out, and gave it to his friend Mr. Wood, of Maresfield, saying it might become better here. It did so improve, and, as we know, is often now to be seen in our winning stands.

Take an example on the other side of the question. Madame Furtado was unanimously pronounced one of the best Roses ever shown; but in a few years, owing to its delicate habit, it will hardly be, I fancy, in many rosaries. "P." says persons who grow Roses may well laugh at what I said about the two "Dromios." Mr. Rivers and Mr. Cant surely "grow" Roses, and they have said stronger things of Beauty of Waltham than I have done; for whereas I only pronounced of it in certain conditions that it was undistinguishable from Madame Charles Crapelet, they affirm that under all conditions the similarity exists.

What, then, I endeavour to do with regard to new Roses is this. Seeing the anxiety there is to arrive at some knowledge of them, I have taken the lists as they have come over to us from France, and given a guess as to what the varieties may prove to be from either my knowledge of what the raisers have done and their character as sound judges and honest tradesmen, or from what information I have been able to glean during my periodical visits to Paris. When the plants come over and blooms are exhibited by our leading nurserymen in the stands for new Roses, I then give my judgment as to what I see there; for as the Secretary of the Floral Committee wisely said the other day, "judgment must be given on what appears before one, not on the representations of what it might be under other conditions;" and hence if a Rose be out of character it must bear the brunt of its inconstancy. When I have had a fair opportunity, either from growing them myself or from seeing them more generally grown, I then pronounce what in my judgment they are. In this, as I say, I may be wrong; but the opinions are not recklessly given. I think, without much self conceit I may say that those who know me will, to use "P.'s" expression, rather smile at his assertion that I do not know much about Roses. I might fill columns of THE JOURNAL OF HORTICULTURE with the letters which I have received on this subject of debate expressing the very contrary opinion, but I forbear; and am now willing, as my friend "S. R. H." suggests, to leave the matter until the blooming season; and I believe that if this hot weather continues, we shall see many a bloom of both these Roses undistinguishable from one another.

I should wish to correct a paragraph in my communication of last week, which reads thus (my bad writing being in fault): "As to Deuil de Prince Albert, I ascribed it to Ducher, I believe, the author of a French list." This should have been "on the authority of a French list."—D., *Deal*.

MUSSETT'S HOT-WATER APPARATUS.

RED SPIDER—BEANS *v.* GOOSEBERRY CATERPILLAR.

I OFTEN see inquiries in your Journal regarding boilers to heat a small house. Such an apparatus I am in great want of myself, and could I learn anything practical of the working of "Mussett's portable hot-water apparatus," I fancy that would suit me exactly, as we should be glad to have it carried in the autumn into the vinery, as in our moist climate (Cornwall) we lose a great quantity of Grapes every year from their damping-off. Could any of your correspondents inform me as to the working of this apparatus?

From our own experience we can speak of getting rid of the red spider effectually, by syringing with water of the temperature of the house for five or six consecutive evenings.

For several years we have successfully kept off the Goose-

berry caterpillar, by planting the Broad Bean between the bushes. This year it has in a degree failed, though we have less of the pest than our neighbours who have not had recourse to the Beans planted soon after Christmas. We have now tried, from your recommendation, the Gorse blossom: if with success you shall hear.—S. C.

THE NURSERIES OF MR. B. S. WILLIAMS, HOLLOWAY.

IT should be understood that an increasing trade has necessitated Mr. Williams to extend his premises. To do so, however, he was obliged to choose an additional site at least a mile away from the original home, or "Paradise Nurseries." This he has named the "Victoria Nurseries;" and here, in good keeping with the name, he has built a right regal conservatory, which is to be set apart for the exhibition and more successful growth of large specimens of greenhouse and decorative plants generally. It already contains some fine specimens of Palms, tree Ferns, Camellias, Azaleas, Cordylines, &c. Conspicuous amongst these has been the magnificent-flowered Rhododendron Nuttallii, which has already been noticed in these pages, and is likely to be the parent of other Rhododendrons equally beautiful and distinct, as there are already discernible upon it a number of seed-pods, which show unmistakable signs of successful impregnation.

I think the mode of shading adopted here, and which works well, is worthy of note. In so extensive a structure the width of the sashes is unusually large, it may be some 7 or 8 feet. Inside the house, at the very top of the sashes, and touching the centre woodwork, is placed the roller with the canvass, the roller being attached to the rafters skirting each sash by proper appliances in which it revolves. The lath or drawing end of the blind has a rope attached within reach from the interior side walk, and when the shading is to be let down the rope is drawn, and the blind is seen to run down, having attached to each end a harder piece of wood, which works in properly constructed grooves placed against the sides of the rafters. Then, by drawing another rope it re-ascends those grooves and becomes folded, and is at all times in the dry. The house, it would appear, ranges nearly north and south, thus a shading would seem to be only necessary upon one—namely, the east side. A feature in this house is the width of the walks, the main or central one especially. They are all skirted by as simple an edging as possible of iron, let into the composition of which the walks are made.

In other houses attached to the "Victoria Nurseries," was a very extensive and healthy stock of the new Grape which Mr. Williams is preparing to send out, the Royal Vineyard, about which I think there cannot be two opinions as to its being a late white Grape of first-class merit. It is conspicuous as being exceedingly thin-skinned, firm-fleshed, of excellent flavour, with good keeping properties. In form it approaches the nearest to the Muscat of Alexandria. The leaf is very distinct from that of any other Vine I know, being covered almost entirely with a woolly substance. I also perceived a good stock of the new Pine named Charlotte Rothschild, Beck's new Geraniums, some eighteen sorts, new Achimenes, &c., &c.

Turning to the home, or Paradise Nurseries, amongst the most conspicuous and meritorious features I noted a superior collection of exotic Ferns. Of Gleichenias there is a fine collection of specimens; *G. hecistophylla* being, perhaps, the finest-growing of the whole, 10 feet by 6 wide. The mode of propagating this is interesting. A row of small pots is placed secretly around the pan in which the parent plant is growing. Into these, when filled with soil, the more advanced creeping rhizomes are pegged down, where they readily root, and soon form independent plants. *G. spluncea*, a fine and more compact kind, is 4 feet through; *G. microphylla*, 5 feet by 3. Perhaps no plants, from their extreme gracefulness, are better adapted than these Gleichenias, and especially *dicarpa*, to place by the side of those masses of colour which form so prominent a feature at our metropolitan shows, and from which the eye would gratefully turn to these Ferns for relief.

The *Pandanus reflexus* has a peculiarity exclusively its

own. The leaves not only reflex, but have also the singularity of twisting themselves, as they rest upon the pot, back around the main stem, all lying recurved in one direction. It will be interesting when the main stem has risen so that the leaves do not rest upon the pot, to note whether the plant will, under these circumstances, still retain this marked peculiarity.

The olive green, shining-foliaged *Cycas revoluta* grows here most luxuriantly. Plants of it are pushing up no less than a score of young leaves each. It thus fully bears out its original character, as one of our most noble and striking fine-foliaged plants. *Cycas circinalis*, though a kindred plant, is in its more prominent features very distinct. Its leaves are in colour very milky, whilst each leaflet upon its singular winged leaf is possessed of two strong determined-looking prickles, very characteristic in appearance of a stag's antlers. I also noticed some noble specimens of *Cyathea dealbata*, the under part of the frond being more or less silvered; *Cyathea Smithii*, a very distinct beautiful species; *Lomaria cycadifolia*, a very handsome species, likely to prove sufficiently hardy for the greenhouse; the stem of this, as compared with its height, is very thick, whilst the *Lomaria*-like leaves, are but a small tuft overspreading the crown. *Lomaria L'Herminieri*, is a very distinct smaller kind, with deep red young fronds continually pushing forth; and the extremely graceful *Todea pellucida*, when good specimens have once been produced, will prove one of the most desired amongst Ferns.

The Orchidaceous plants (old acquaintances), and of which I was prepared to see a good collection, surpassed my expectations. Of *Vandas*, including six or seven distinct varieties of tricolor, *Saccolabium*, *Epides*, not omitting the Foxbrush variety, there is an excellent stock grown in, as compared with some establishments, a very moderate temperature, especially for this season of the year, and presenting no trace of the leaf-destroying spot.

In bloom were a very superior variety of *Dendrobium Dayanum*, which in some respects resembles *anostum*; a very superior variety, also with large flowers, of *Dendrobium Dalhousianum*. The wings, &c., are a pale yellow, slightly tinged throughout with purple; the lip, large and full, ladle-like in form, is most distinctly marked with the richest chocolate, inclining rather to purple. *Dendrobium macrophyllum* is also worthy of notice, being richly marked, and having the lip more elongated and pointed than the latter, and densely covered with a soft woolly substance.

Amongst *Cypripediums* there is a variety in bloom distinguishable apart from *barbatum nigrum*; it is darker, and the lip or slipper is very much narrower. In all probability its colour will render it the most desirable representative of the species. I noticed also in full bloom a fine specimen pot of *Cypripedium barbatum*, there were at least thirty blooms expanded upon it. The pretty little *Phalænopsis roseum* was here in flower, having a pointed lip of a rosy mauve colour. *Cypripedium Hookeri* is, I believe, the most distinctly marked in the leaf of any; the leaves are beautifully and unevenly blotched all over with a good white upon a light olive-green surface; the flowers of this are curious also. I noticed in flower what seemed to be a distinct *Cattleya*, an imported bit, which has a very richly-coloured lip of the richest lake, with beautifully-pencilled veins, the lip decidedly cut. In habit the plant mostly favours the species *Leopoldi*. Here is also the best specimen of the old *Goodyera discolor* it has been my fortune to see, it covers very evenly and nicely the surface of a No. 8-pot.

I also remarked a thriving young plant of the *Dracæna grandis*. It is a great advance upon *pecta*. The leaves are much wider, of greater substance, and more erect; the habit is compact, and the colouring all that can be desired. An *Alocasia metallica*, in a No. 2-pot, was in the most vigorous health. It had some twenty leaves averaging 18 inches long, and possessed the peculiarity, not often observable, of having the extremity of the larger leaves elongated and of even width throughout some 2 inches in length. Two other stately plants belonging to this class are conspicuous; they have each a bolder and more erect petiole, which in *A. zebrina* is beautifully striped, or what possibly an artist would call marbled with very pleasing effect. *A. macrorhiza variegata* has very distinctly variegated foliage. The leaves

of each of these, as with *Lewii*, vary in form from *metallica*, being arrow-head shaped. *Sphærogyne latifolia* is another of those majestic, bold-foliaged plants in the way of the now well-known *Cyanophyllum magnificum*. Like the latter, it has the very distinctly-marked triple midrib; the leaf, stem, and stalk are tinged more or less with red, and very hirsute, though, as the name implies, its leaf is not in form so elongated and tapering as in *Cyanophyllum magnificum*, neither has it that very dark glossy foliage characteristic of the latter.

Among variegated plants, not omitting even the *Anæctochilus*, which it resembles both in form and manner of growth, and especially when grown under a glass, the *Bertolinia marmorea* is a perfect gem, and essentially a lady's plant. As such it will, doubtless, soon become better known, especially as, though a stove plant, it has the merit of being a pretty free grower.

Pitcher-plants are here well represented. I perceived no less than three or four distinct varieties of the *Sarracenia Drummondii* form, independent of the *Nepenthes*. Two plants of *Drummondii* were still conspicuous, with their most singular flowers. There were also *variolaris, flava*, and *rubra*, each having colour at the upper mouth of the pitcher-like leaves, characteristic of their different names.

Calamus Verschaffelti is another strange and startling plant. As the name implies, it was introduced originally by M. Verschaffelt, of Ghent, who exhibited a plant of it at the exhibition lately held at Brussels. The leafstalks of this plant are thickly set all over with needle-like thorns, varying from 2 to 3 inches in length. The leaves themselves are in form bi-pinnate, each leaflet resembling closely in form, colour, &c., that upon some species of the Bamboo.

Aralia Sieboldi is another plant well represented here. It has a thick-set tropical look, and one main stem. The leaves of the current season's growth remain erect, whilst those of last season droop and hang down closely around the main stem. They are in addition beautifully variegated.

Mr. Williams has become, deservedly, one of the best-known cultivators of the *Amaryllis*, as he has constantly for a number of years kept strictly to their advancement as a tribe. Amongst those which he produced himself, I may name *Hawkensiana*, *Unique*, and *Williamsi*, as being an advance upon many older varieties, though, and as Mr. Williams justly remarks, the *Ackermani* strain is not yet beaten. Much remains to be done with this very beautiful class of plants. Perhaps, however, the most assured step to success would be first to weed out from amongst a few such as those which I have named, very many older varieties which have nothing to recommend them, being so deficient in colour, whence arises the idea that they are a dull-looking class of plants. I have myself had to deal thus with some eighty-two varieties—a collection probably not again to be got together, being composed of those older varieties alone.

I cannot conclude without noticing two new variegated plants likely to be of use for bedding-out, and which I found amongst the hardwooded greenhouse plants, of which there is here an extensive variety. These are *Mimulus cupreus variegatus*, a very distinct variegated form of the well-known *cupreus*; and *Polemonium variegatum*, this being distinct from any variegated form we yet have in use for bedding, and if it can once be brought to stand the sun it will prove a decided acquisition. The form of the leaf is not unlike that of the *Clianthus*, though if anything the leaves are more graceful, the individual leaflets being narrower. I must not close these few notes without acknowledging the great courtesy of the proprietor of these nurseries, and his energetic foreman, Mr. Burton.—WILLIAM EARLEY.

BIRMINGHAM ROSE SHOW.—The third annual Rose Show, at Birmingham, will be held, as heretofore, in the Town Hall. The days fixed are Thursday and Friday, July 7th and 8th.

LARGEST WELLINGTONIA GIGANTEA.—W. Bill is obliged by the insertion of his inquiry relative to the largest *Wellingtonia gigantea* growing in England. W. Bill is anxious to know if there is a larger specimen of this species in England than the one under his care, which is a perfect

specimen, considerably more than 13 feet high, 10 feet 10 inches through, and 4 feet 4 inches in girth of stem.

[One at Fairlawn, near Sevenoaks, Kent, is stated by Mr. Robson to be 17 feet 11 inches high, with a girth of stem near the ground of upwards of 4 feet.]

ORCHARD-HOUSES.

MR. PEARSON, at page 346 of THE JOURNAL OF HORTICULTURE, admits that he commenced the cultivation of fruit trees in pots with an orchard-house having wooden sides and ends, and managed to obtain fine crops in it every year, and states he will be able to show good fruit on the trees in this house the present year. Though fine crops were grown in this house, built after Mr. Rivers's original plan, yet it seems he was not satisfied with obtaining "fine" and "good" crops, for he tells us he wrote a book "to persuade people to build good houses, and convince them a little knowledge was requisite to insure success." His "Hints on Orchard-Houses" I knew were written *apropos* of this, and as this is one of the points I contend for, his admitting the fact shows us to hold the same opinion on the subject; but in the next paragraph he contradicts himself, and takes up other ground. He would not build the same style of house in the cold north as that which has answered so well in sunny Hertfordshire. He was at the trouble of writing a book which had for its express object to persuade people to build better houses than those first originated; but he now tells us "it would be a bad house indeed from which he should not expect to get good Peaches; and where failures occur it is generally, if not always, the man who is in fault." In his first reply, page 246, to my first letter he ascribes my failure to the house, now to the man. "Bad workmen complain of their tools," says Mr. Pearson, quoting an old saying. This is exactly the cap that fits his own head, for he ridicules himself by complaining of his old house, or for writing his book to persuade people that such houses are not the proper description to succeed with; and the cultivation of the trees, so easy to him and his men, who had never before grown a fruit tree in a pot, seems to have induced Mr. Pearson to write his little book to convince people that "a little knowledge was requisite to insure success." "Hints on Orchard-Houses" do not exhibit any trace of being written by one who had never before grown a fruit tree in a pot, but appear to be the brief condensed notes and argument of one conversant with the subject written upon. I have Mr. Pearson's "Hints," and Mr. Rivers's "Orchard-House," and they do not disagree with each other, nor I with them, though I peruse them frequently.

Mr. Pearson, in illustrating his argument, takes us to an unheated orchard-house—the whereabouts of which is left to the imagination—managed by an amateur. It is a small house, and not very well built; but 2700 Peaches and Nectarines were produced in it. I am much pleased at this, for it seems other persons have been equally foolish in building objectionable houses, and have obtained "first-rate prospects" after a few years' experience with such houses, and the produce is almost incredible at the beginning for a house of small dimensions. Surely the 2700 Peaches and Nectarines were not produced in one year by the trees of a small house! It would take thirty-seven trees, presuming each to carry six dozen fruits, and one tree more with two dozen upon it; and these trees certainly would not occupy less than a square yard, or 38 square yards, equal to a house 23 feet by 15, or nearly, without allowing for paths. But what Peach tree in a pot, occupying a square yard, produces six dozen full-sized Peaches? and where shall we find them with that number upon them? If three dozen only were borne by each tree, which is quite ample for the ordinary-sized trees we see in orchard-houses, we have a house 46 feet by 15, and this produce even beats that from Peach trees trained to trellises in houses. It would take 2700 feet of covered trellises to produce the quantity named, or a Peach-trellis 225 feet long and 12 wide. This is really wonderful for a small house, and I should like to know whether it was the produce of one year or a series.

I have a set-off against Mr. Pearson's case of non-success through the fault of the man at Liverpool. It was in smoky Bradford, within a mile of my own place of abode. A gentleman built a house 70 feet by 18 feet, and had at

the time a gardener of no mean abilities, but though well up in the regular modes of fruit-tree culture, he did not know nor profess to know much about fruit cultivation in pots, in mixed collections as orchard-houses are. I was asked to furnish a list of the choicest Plums, Apples, Pears, Peaches, Nectarines, Cherries, and Apricots, which I did, assisted or in concert with my friend, and to these the gentleman added a few Vines. Mr. Rivers furnished the trees. The gardener obtained Mr. Rivers's "Orchard-House," and went to work. All went on flourishingly for a time, and I believe nothing was wrong with the trees themselves; but the gentleman going into a neighbour's viney saw some seven Peach trees carrying on an average three dozen very fine Peaches, some of which measured 8 inches round, for I measured them, and left the place chagrined at his own failure and his neighbour's success. He used harsh words to his gardener, and told him it was through his incompetency that he had no Peaches in his orchard-house, whilst his neighbour over the way had a good crop. The gardener said it was owing to the trees he had seen being grown in a heated house, whilst his were grown in an unheated orchard-house. The result was the gardener was dismissed, and another came in his stead, who was a professed pot-tree cultivator, but he, too, failed. This gardener, and he is an unpretending clever man, ought according to the precedent laid down in the former case, and advocated by Mr. Pearson, to have been dismissed for incompetency like the first, but he was not. The house has been divided by a partition of glass into two compartments, the one heated for the production of Peaches and Nectarines, and the other unheated for Plums, Pears, &c. I could give more cases of this kind where gardeners have been dismissed and subjected to considerable inconvenience, through their inability to make an unheated orchard-house produce Peaches and Nectarines equal to the representations of enthusiastic cultivators and authors practising in another part of the country. I think these facts will bear comparison with the case Mr. Pearson relates of the house and gardener at Liverpool, for it seems he has to travel over a large extent of country before he can find a case suited to his views. The house named above is one of the best I have seen, and a model of what an orchard-house should be—high, light, and substantially built with brick walls and glass ends.

I think it avails Mr. Pearson very little to say, "Whenever gentlemen make up their minds they *will* have Peaches every year, gardeners will be found able to produce them." I do not suppose he means that there were no gardeners that could grow Peaches every year before the introduction of orchard-houses; but, let him mean what he may, I know this much, that at nineteen out of every twenty gardens in this country Peaches are grown to the satisfaction of the proprietors without the aid of orchard-houses.

Then, as to orchard-house fruit being superior in flavour to that grown on walls, I have only to repeat I do not understand such an assertion, and should like an explanation of the cause of this superiority in flavour. What I mean by its being opposed to the laws of vegetable physiology is, that light being the great agent in the maturation of fruits and seeds, anything that diminishes that light must detract from the flavour of the fruit. I know that fruit of all kinds lose their flavour in sunless weather and rainy periods, and that this circumstance is due to the light and heat of the sun being obstructed by the clouds, and if this occurs outdoors why should it not apply to fruit under glass? All horticulturists agree in recommending a diminished temperature in sunless weather, thereby showing that heat is injurious without light. Physiologists tell us light is necessary for vegetable existence, growth, and maturation, and all men agree in considering light contributes more to the flavour of fruit than any other agent. When I find fruit grown in a dark house inferior in flavour to that grown in one much lighter, is it not perplexing to learn that fruit grown in an orchard-house under glass obstructing much light and sun heat is superior in flavour to that grown outside in a climate warm enough to insure ripening, and where the fruit receives the sun's light and heat undiminished? I suppose home-grown Oranges are finer-flavoured than the best St. Michaels; our Grapes richer than they could be grown in the native country of the Vine; the Fig, Peach, &c., better when grown under glass than in the full sun; Straw-

berries richer-flavoured if forced or grown in an orchard-house; and even Apples never eaten in perfection unless from trees under glass. When I find Mushrooms grown in the dark catacombs of Paris equal to those grown naturally in our pastures, and when I can find no fruit on the sunny side of a tree equal to those on the north, then will I admit that fruit is improved in flavour by being ripened under a glass roof, which reflects or wastes a considerable portion of the sun's light and heat. If Mr. Pearson can prove artificial heat with a diminished light better suited for vegetation than the light and heat of the sun, or will be at the trouble to enlighten my darkness, I should be obliged to him, for neither Lindley nor Johnson, my authorities in matters of this kind, furnish the information.

"PENDLE" next enters the field, and he comes forward with the statement that in a lean-to orchard-house not thirty miles from Bradford, he grows fine, well-ripened Peaches and Nectarines without difficulty. The situation is within cannon shot of famous Pendle, which certainly is about as dreary a place as can be desired, even by those who subsist on herbs. We are not told whether it is some sunny spot on the southern side of that mountain, or situated at the foot to the east, west, or north. He does not know the altitude of the place, but for excessive rain and cloudy weather few places equal it, and yet we are left in ignorance of the rainfall, and the calculated amount of cloud is not given; alas! left to grope again in the dark. We learn that the fruit trees thrive well with air-giving through sheer necessity. Plums, it seems, cannot be grown on walls well, and yet Peaches can be grown fine and well-flavoured in unheated orchard-houses! Apricots, it is admitted, are a failure; and though "PENDLE" does not know why, yet he says it is not from the causes to which I attribute failure in Peaches and Nectarines. I suppose "PENDLE"

is not aware that within twenty miles of him Apricots are grown on a heated wall, and that two thousand fine, well-ripened fruit have been gathered from one tree in a season, and these not small Bredas, but full-sized Moorpark. Within the same circle I think "PENDLE" would hear of an amateur placing his orchard-house trees in the hands of a nurseryman for sale, and though he gave 5s. each for them, they were sold for 2s. 6d., and I bought some of them for a trifle more off the nurseryman. This amateur had grown these trees for five years, and he told the nurseryman he had not had so many fruits as there were trees in the house. They were Peach and Nectarine trees. The house is now a heated vinery.

I can readily comprehend the high estimation in which amateurs hold orchard-houses. They are to them a source of interest and pleasure, and if a few fruits are grown in them they make as much to do about it as if they were supplying a whole city. Most people set a high estimate on their own doings, but it is another question what other people think of them. It is very nice to partake of fruit of your own growing, and to hear people sound your praises on a high note; but how would you feel if asked to supply Mr. So-and-So's table daily with Peaches from your orchard-house? Why he would, aided by his friends, eat them all in a day, unless you grew more in one house than I have seen in a score of such houses all put together. I now put it to your readers to decide as to whether the points I contended for have been refuted by my opponents or not—viz.:—1st. Orchard-houses for the production of Peaches and Nectarines in the north must be heated. 2nd. That an unheated wall covered with glass is preferable to an unheated orchard-house. When Mr. Pearson gives me anything to reply to on these points, I am prepared to follow him.—G. ABBEY.

THE LEROY NURSERIES—CORDON TRAINING.

ON the 18th of April last I visited the extensive fruit nurseries of M. Leroy at Angers, which, as probably many of your readers know, are among the first in France; indeed, the country round Angers seems especially fitted by soil and climate for the growth of Peaches, Pears, and most of the ordinary fruits: it may be called the garden of France,

and the neighbourhood abounds beyond most others in establishments of high character. M. Leroy employs several hundred hands, and his nurseries extend over several hundred acres. A pupil of M. Dubreuil, one of the greatest living French authorities on arboriculture, has the superintendence of the pruning and training operations. The

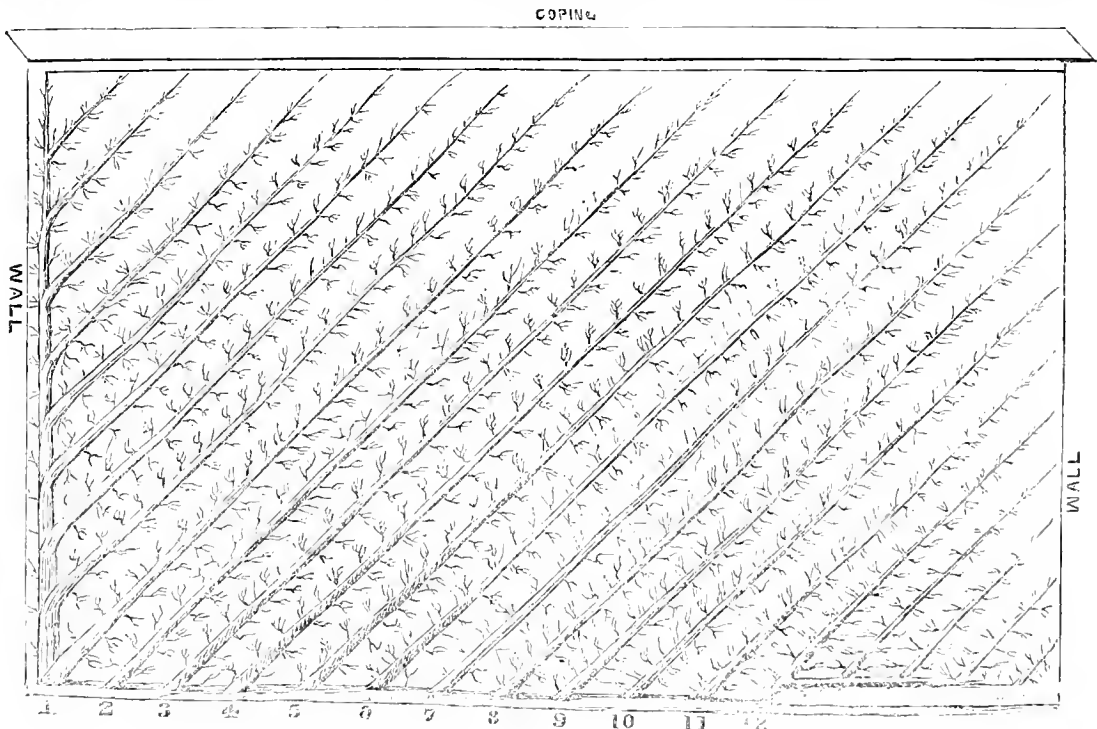

Fig. 1.

soil is a rich loamy clay, and the climate is so far in advance of England that on the day I was there many of the pyramid Pear trees, of which there is a magnificent collection, had set their fruit.

Many trees were grown with a high single stem or *cordon vertical*, and some *en vase*. Great pains had been taken, by means of small sticks and ties, to keep the branches in the proper direction, and sufficiently clear of each other to admit abundance of light and air. On the walls the Pear trees, as well as the Peach trees, were trained upon splines in the

favourite French mode, called *cordon oblique*, as indicated in fig. 1.

I was very much pleased with the rows of dwarf Apple trees grafted on the French Pomme de Paradis stock, which differs from our Paradise stock in being smaller and more tender; indeed, Mr. Rivers tells us that he found it very difficult to preserve these stocks in our colder climate. These Apples are grown as follows:—A galvanised wire is drawn tight in a horizontal direction on supports about 2½ feet high, placed about 12 feet apart; the Apple trees

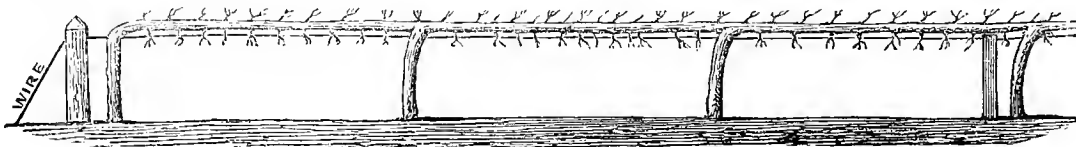

Fig. 2.

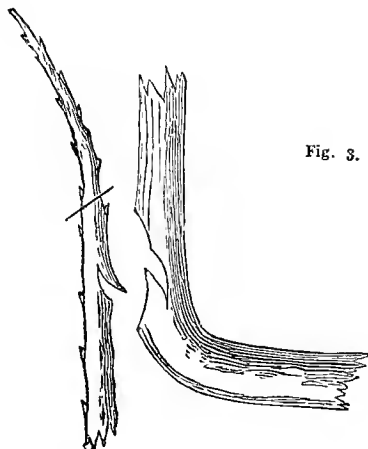

Fig. 3.

are planted about 4 feet apart, and only the leading shoot is allowed to grow. This is bent down and fastened along the wire. When the first Apple tree reaches the next this horizontal leader is grafted on the bend of the latter, and so on through the whole series, so that the sap flows equally along the vessels of all the trees in the same row. Above are diagrams showing a row of trees thus trained, fig. 2, and the mode of grafting by approach, fig. 3.

The favourite table Grape at Angers seems to be the Chasselas de Fontainebleau or Royal Muscadine, and I was surprised to find that the Black Hamburgh, which is confounded with the Frankenthal, does not seem very highly prized. There is no glass, except for Melons; I believe even the Muscats are ripened on walls in warm aspects in the open air. The Magnolias in this establishment are very fine, rising with a clear stem to about 7 feet, and then terminated by a beautiful well-shaped head. I saw, too, quite a hedge of crimson Camellias about 6 feet high, full of flowers.

Here, as elsewhere in France, the regular training of fruit trees and Vines on walls is brought to a high degree of perfection, and I think we have much to learn of our neighbours in this particular.—JAS. C. BARNHAM, *Norwich*.

THE HORTICULTURAL CONGRESS AT BRUSSELS.

April 24.—After the ceremony of opening the Great Horticultural Exhibition by the King was over, and which we reported on the 26th ult., there took place in the afternoon of the same day the inauguration of the Congress of Horticulture. The object of this Congress was to assemble from all parts of Europe men who are eminent in horticulture and in botany to discuss subjects that are of common interest relating to these pursuits; and perhaps even with the more special object of bringing together those persons who have hitherto known each other only by reputation.

The Congress met at three o'clock on the 24th of April at the Palais Ducal, in which a splendid hall was placed at their disposal, and there for three days did a more or less numerous assemblage meet to discuss the subjects set down in the schedule. Unfortunately M. Edonard Morren, Professor of Botany at Liège, who was to act as secretary, was taken ill, and to this unfortunate circumstance was to be attributed what was by many considered, and which we ourselves are unwillingly compelled to designate, a failure of the project. The chair was taken by M. De Cannart d'Hamale, a senator of Belgium, who was elected President; and the Vice-President was M. Van den Hecke de Lembeke. Altogether there were 175 members present, 13 of whom were from England, 17 from Germany, 95 from Belgium, 1 from Spain, 30 from France, 12 from Holland, 2 from Italy, 5 from Russia, 1 from Switzerland.

The President, in proceeding to open the meeting, said, "The Federation of the horticultural societies of Belgium, strengthened by the support of the Government, has seized with eagerness the call that has been made to it by the Royal Society of Flora to unite, in one constellation of luminaries, men for whom study is agreeable and presents a useful relaxation. The Congress numbers about five hundred members, among whom figure so many distinguished men

who have consecrated their studies and their labour to the profit of science. We hail with honour the presence among us of *savants* of all countries, illustrious representatives of foreign horticulture. Thanks should be rendered to these excellent and devoted men who consecrate themselves to progress—thanks, above all, to the botanists who have so willingly raised the *éclat* of the Congress by associating themselves with works which bear happy fruits, and which germinate in all soils, particularly our own, which is the native country of Flora. Already the circle of horticultural science is considerably extended, and the period approaches when the art of gardening will rest on bases essentially scientific. In fact, all the sciences expand, but that which dominates above all others is botany. It is on the facts that it establishes that the science of horticulture is based. In our days it is necessary to know the principles that govern the life of plants and the law upon which they are distributed in all regions of the globe. Let us be grateful, then, to those distinguished botanists who, notwithstanding the fatigues of the journey, have not feared to come and associate themselves in our labours. Henceforth the bond will be intimate and indestructible. In the name of the federal societies of Belgium I wish to address you from the bottom of my heart the welcome to you all, horticulturists and botanists, who have come to guide and enlighten the Congress with the torch of science."

After a desultory consultation, in which several members took part, it was arranged that the representatives should meet at Vauxhall in the evening.

April 25.—The Congress met this morning at ten o'clock. M. Piré, the Secretary, read the analysis of a paper read before the meeting by M. Bastin on the necessity of establishing a uniform nomenclature for vegetables. The author of the paper proposed to establish that nomenclature in the

Latin language, so that it might be rendered universal. He inclined to the necessity of establishing generic denominations, which should be rendered in the adjective form to express varieties. After a debate, in which many members took part, the proposition was referred to a committee consisting of MM. Hulle, Rodigas, father and son, de Selys Longchamps, Planchon, Pynaert, and Count de Lambertye, who afterwards reported that the scheme was impracticable and undesirable.

The meeting then proceeded to the consideration of the first question in the programme—"Acclimatation, Naturalisation, and Domestication of Plants." M. Cordier, Vice-President of the Botanical Society of France, suggested some considerations on the possibility and utility of acclimatising some species of *Agaricus*. M. Planchon protested against the term "acclimatation." In his opinion that meant change of temperature. M. Von Siebold was of the same opinion as M. Planchon, and cited as an illustration the introduction of certain plants from Japan, and which have been acclimated here only because they have found conditions of culture advantageous to them. M. Lecocq asked M. Cordier if he knew of certain means for the cultivation of Mushrooms; he himself had made the attempt, which did not tend to good results. M. Cordier said he did not know of any certain means, and indicated the systems followed in England, in Italy, and in the Landes.

M. Planchon contended against thermometric means as the expression of temperature in its relation with vegetation. M. Hoffman, of Giessen, enlarged upon the benefits of thermometric means. M. Regel treated of the sense which is given to the term "acclimatation." He could not ridicule the ideas developed on this point by M. Planchon. M. Planchon admitted partially the observations made by the preceding speaker. He recognised that there is acclimatation by selection, and acclimatation by adoption. Baron Hügel ridiculed the observations expressed by M. Regel. M. Schneider, of Berlin propounded his astrometeorological theory on the influence of the stars on vegetation. M. Baltet, of Troyes, read a paper on fruit-production, in relation to the double objects of the culture and the commerce of fruits. This closed the second sitting of the Conference.

A second meeting commenced at three o'clock. The Ministers of Home and Foreign Affairs, and the Governor of Brabant were present. After the preliminary formalities had been gone through. M. B. Dumortier announced to the Congress, that the *Cercle artistique et littéraire*, of Brussels, had opened its rooms for the use of the Congress.

M. Santo Garavoglio, Professor of Botany, and Director of the Botanical Garden at Pavia (Italy), made some observations on the vegetation of the north of Italy, and upon the culture of Mushrooms. He also reported the various observations that he had made in the north of Italy, and especially in the town of Carlotta, on Lake Como, where his attention was especially directed to Conifers.

M. Fée, Professor of Botany at Strasbourg, (Bas Rhin), read a work relative to acclimatation and naturalisation.

The meeting then proceeded to the consideration of the second question in the programme, which was hybridising, crossing, and artificial fertilisation in general; the characters of hybrids, their barrenness, their polymorphism; preservation of pollen, &c.

M. Wesmael, Assistant Secretary, read a letter from M. Belhomme, containing some details relative to the preservation of pollen. This communication drew some critical remarks from M. Fée. He did not understand how, as the writer of the letter asserted, pollen could be preserved so long, and yet its vitality be ascertained. For his part he had operated with pollen which could pass for being completely dried up, and with good results. He thought that the pollen not only acted by the more or less normal development of the pollen-tubes, but that it could act without it; it is the same with flowers which have no stigma. Numerous other considerations must also be taken into account.

No one desired to speak on the third and fourth questions in the programme, which were—3. Theory of variation from species, and the original type of varieties and races; theories of Van Mons, Vilmorin, and others; reform in the nomenclature of varieties. 4. On vegetable dynamics, and the periodical phenomena of vegetation; influence of tempera-

ture on the germination, foliation, flowering, and fructification of vegetables; forced and unseasonable flowering.

With regard to the fifth question—The food of plants, the action of the atmosphere, the influence of nitrates, ammonia, and the phosphates; theory of manures, composts, &c., M. Pynaert, Professor, School of Gentbrugge, read a long work on the preparation, composition, and the action and use of peat earth.

The Assembly then proceeded to the sixth question—Floral aesthetics, points of excellence in single and double flowers, and harmony of colours.

M. Koch, Professor of the University of Berlin, and Editor of the *Wochenschrift*, gave, in German, his theory of "Beauty in Nature."

7th Question.—Coloration of plants. On variegation, and the dimorphism of which it is the consequence. Is variegation perpetuated by seed and continued by grafting?

M. Von Siebold stated the observations he had made during his stay of twelve years in Japan, whence we have received more variegated plants than from any other country. He described the country geographically and meteorologically, and took the fact of its northern latitude as a basis for his argument that variegation is a disease. As proof of this opinion, he stated that in the tropics green and variegated plants of the one kind are never found in the same place. In Siberia there are no variegated plants. Variegation is an affection which belongs to the leaves of plants transported from their natural climate. "I will show you," he said, "a work containing eight hundred variegated plants from Japan alone. Whence this great number? It arises from a simple fact, that in Japan horticulture is a thousand years old, while with us it is centenary, which explains why our normal forms have become so little variegated." The speaker then alluded to the large number of Japanese plants which he had introduced. He might say that he had even himself made three that were variegated. Each of these sprung from plants that were originally green, but which by some accident had become variegated. This, along with others, was the case with *Sedum Sieboldi medio-variegatum*, which has been sent out by the trade, and has been supposed to be a variety from Japan, although in reality this is not exactly the case. "This *Sedum*," he said, "does not come from Japan, since, to tell the truth, I have made it." There is, besides, another fact, that variegation is not directly produced by disease of the seeds, but by that of the plant while exposed to sun and air. To sum up, the mother plants are healthy and green, the striped plants are suffering from chlorosis. "These are," said M. Siebold, "the observations I have made in my travels, and I shall continue to apply them with success in the manufacture of variegated flowers" [laughter and applause].

The theory of M. Von Siebold occasioned an animated discussion, in which many members took part. Among others were, MM. Planchon, Reichenbach, Regel, Baron Hügel, Hoffmann, Rodigas, André, Kelle, B. Dumortier, &c. The Assembly rose at 5 o'clock.

April 26th.—The meeting opened at ten o'clock, when the President read a letter from Count Vander Straten Ponthoz, expressing His Majesty's satisfaction at the success of the exhibition, his hopes that the Congress would be also successful, and his regret that he could not be present at its sittings.

M. Bommer addressed the Congress upon the introduction of hardy plants.

M. Bossin made some additional remarks on the nomenclature of vegetables.

M. Fritsch gave in a note on the dynamics of vegetables.

Dr. Van de Corput sent a note on the utility of squares and public gardens.

A debate again took place on variegated plants, in which Hügel, and MM. Von Siebold, Rodigas, Planchon, and André, took part.

M. Bommer was of opinion that there is a distinction to be made between variegated leaves and coloured leaves. He then drew attention to the utility of *Vaccinium amœnum*, which produces excellent fruit, and is at the same time an ornamental plant, and to *Urtica nivea*, the fibres of which are used to weave a fine Chinese cumbic. This plant has endured two winters in the Botanic Garden at Brussels.

M. B. Dumortier spoke of the desirability of introducing

new fruits. He asked M. Von Siebold if it were not possible to introduce the famous sky-blue Grape, of which so much had been said.

M. Von Siebold replied that he had received twelve Vines of the kind alluded to. When he left Yeddo on the 17th of May, 1863, they were in a promising condition. He had promised to send a box of cuttings to the *Société Royale de Flore*, on his return to Japan. He was convinced that Belgian horticulturists would turn them to advantage.

M. Planchon thought that *Urtica nivea* was not the plant from which the Japanese obtained the fibre for their fine cambric, in his opinion it is the *Boehmeria utilis* of Blume.

M. Kobb gave a long dissertation (in German) on the introduction of plants among the ancients.

M. Entz Ferenez, Director of the National Nursery, at Buda (Hungary), gave a history of horticulture in Hungary.

M. Hednielsky, Doctor of Sciences, and Professor of the Imperial Horticultural Society of Moscow, made some remarks on the history of horticulture in Russia.

M. Depuydt, Secretary of the Horticultural Society, Mons, spoke of the necessity of giving a uniform signification to the words "hothouse," "greenhouse," "conservatory," &c. He then entered into some matters connected with the geography of plants.

M. Rodigas, junr., insisted upon the necessity of knowing the degree of dampness necessary for the different sorts of hotbeds indicated by M. Depuydt.

M. Wesmael directed attention to the defective manner in which the catalogues of horticulturists are drawn up.

M. Rodigas presented the report of the Commission nominated the previous day to take into consideration the proposition of M. Bassin, to establish a uniform nomenclature for vegetables. The Commission whilst admitting the desirability of such a uniformity, rejected the proposition, as they did not consider it could be carried out by the Congress.

WORK FOR THE WEEK.

KITCHEN GARDEN.

UNDER the system of cultivation which we have constantly recommended—viz., that of continual surface-stirring, weeds will never make their appearance amongst growing crops; but there are some parts of the garden, such as those quarters where there are Gooseberries, Currants, and Raspberries, which are apt to be neglected. The hoe should be kept constantly at work among these whenever the sun is powerful enough to wither the weeds as fast as they are cut up. *Beet*, the first sowing must now be thinned out, and if there are any vacancies the thinnings may be successfully transplanted, if they are carefully lifted, a long dibble used, and the root placed perfectly straight in the hole. With such favourable weather as we have had there ought now to be a good breadth of Cauliflowers and Cabbages. Keep the earth well moved amongst them, and water them when needful. Cauliflowers in a forward state must still be supplied with liquid manure. *Celery*, a few trenches should now be got ready for the earliest crop. Give the rows a good width, but the *Celery* should never be earthed-up until it has nearly attained a size fit for use, and, therefore, the intervening spaces may be cropped with Lettuces, early dwarf Cabbages, and Cauliflowers, all of which would come off before the final earthing. *Carrots*, where young ones are continually in request another sowing may now be made, and advancing crops of the same must be kept well surface-stirred and thinned-out from 4 to 6 inches, as very large Carrots are seldom required. *Cucumbers*, the ridge recommended for them will now be in a proper state to receive the plants; let them be planted without delay, and shade the glasses for a few days. At the same time a few glasses may be sown with seeds of Vegetable Marrows and Cucumbers for succession, and for Gherkins, for the latter purpose. On warm soils seeds sown in open borders will suffice; but on colder soils it is better to forward them in pots, and have a sloping bank thrown up facing the south, plant them near the top, and train the vines downwards, stopping them occasionally. *Peas*, stop the early sorts as soon as the first blossoms are well set. *Parsnips*, they require to be thinned to 9 inches, or more if the ground is rich. *Tomatoes*, plant out in light compost under a south wall, also Chilies, Cap-

sicums, and Basils, in doing which, if they are at all pot-bound, let the roots be gently loosened and spread out.

FLOWER GARDEN.

All climbing plants should now receive particular attention in placing the shoots in regular order, and in nailing or tying them to walls or trellises. Standard Roses that had been budded last summer should be gone over again, and all buds and suckers of the stock removed, and the inserted buds that have made shoots to be stopped back to three joints to lay the foundation of a bushy head. Any stocks intended for budding this season to be looked over, and where there are six or eight well-placed buds or shoots on the stalk to be retained for the purpose of budding upon. This manner of growing standards is now becoming general, and to our thinking is a great improvement upon the lumpish, mop-headed appearance of standard Roses, that always look so naked and unsightly in the stem, and so apt to be broken by high winds. Many of the coniferous trees of modern introduction are well worthy of a place on the lawn or pleasure grounds. If it were in contemplation to add such a noble feature of interest to the home grounds, we would advise, from some experience on the subject, this as the most favourable season for planting them on slightly raised mounds of loamy soil, to be watered and staked after planting. Do not tie up the leading shoots of the Deodar Cedar, and other such naturally drooping shoots, for if you do they will die.

FRUIT GARDEN.

During the process of nailing-in the shoots of Peaches, Nectarines, and Apricots, examine if there are any nails so placed as to be likely to injure the swelling fruit, and remove it. Vines will now require constant attention in stopping and nailing-in.

GREENHOUSE AND CONSERVATORY.

As summer weather has set in, a good number of plants in the conservatory, such as Diosmas, Myrtles, and other plants which have done blooming, may be removed to the reserve garden, and, being cut back and repotted, will, if properly attended to, make fine plants for the autumn. These old things are very valuable when cut flowers are required for drawing-room decoration. Plants from the greenhouse and stove will now be very plentiful to decorate the conservatory; but trust more to good plants set thinly for producing a satisfactory effect than to a crowd of comparatively inferior productions. Give air both night and day, and damp every available part of the house twice or thrice a-day. Fuchsias should now be growing rapidly, and Pelargoniums and Calceolarias all in bloom; supply them liberally with weak manure water. Discretion is to be used in the application of liquid manure. It may be given once or twice a-week, in accordance with the state of the weather or the healthy and luxuriant growth of the plants, from which it is to be inferred that plants in a sickly state, or such as have been newly potted, will not require it; indeed, to such plants it would be a positive injury. It is best to commence with the liquid manure weak, and to increase its strength with the strength of the plants and increasing temperature of the summer's sun. Go over the creepers frequently, so as to direct their growth and to prevent their getting into confusion, which, without attention, will soon be the case.

STOVE.

The plants here will now be growing freely, and will require frequent attention as to stopping, training, &c. Keep them properly supplied with pot-room, and afford them all the sunshine that they will bear without scorching, with a moist atmosphere, admitting air freely on mild days; also afford them sufficient space for the perfect development of their foliage. Afford the Orchids in growth a thorough moist atmosphere, giving them a good steaming every bright afternoon by syringing and shutting up early. Admit air in moderate quantities on mild soft days, but carefully avoid currents of drying winds.

PITS AND FRAMES.

Persevere in airing, watering, stopping, and keeping down insects, and attend diligently to maintain a brisk heat to Cockscombs, Balsams, &c. These require to be shifted into larger-sized pots, placed near the glass, with sufficient air to prevent them being drawn.

W. KEANE.

DOINGS OF THE LAST WEEK.

KITCHEN GARDEN.

In all departments carried on much the same work as was mentioned in last and previous weeks. Last week we spoke of being prepared for frost, and that we have known them pretty sharp at this time in May. Could we have foreseen the weather we should have much altered our work in many respects. For a week we have had the weather of the dog days. On Thursday morning at 9 o'clock A.M., a thermometer hung on the north side of a wall was between 79° and 80°, a wonderful temperature in May. We hope there will be a change before long, and if not, we would advise all readers to do, what we should like to do ourselves—that is, give Peas, Cauliflower, and Strawberries a good soaking of manure water. We have only managed as yet to do this with our *Cauliflower* which is coming in nicely, at least the part that was protected with hand-lights. Our ground being stiff holds the water very well. This season we put our *Cauliflowers* two glasses deep on a narrow, steep, sloping border. This has been thrown up artificially for a number of years; the south side forwarding all sorts of vegetables, and the north side retarding them, and answering admirably in summer for Turnips, Lettuces, &c. In earthing-up the *Cauliflower* a trench is cut out across the border between the rows of two lights, and this trench comes in well for early Celery, as the large leaves of the *Cauliflower* partly shade it. When we can manage it, we like to put a foot of hot dung in the bottom of the trench, and 9 to 12 inches of rotten dung and soil on the top to plant in. In cold soils a little of this bottom heat does marvels. Short grass would give this heat as well as anything, but for very quick-rooting things there is rather too much nitrogenous matter to suit the roots, and when thus buried it takes a considerable time to become sweet. Where the grass from a small lawn cannot be used for such purposes, it becomes a most useful agent when taken to the *rubbish-heap*, mixed with the rougher materials, and covered thinly with soil to arrest the escape of ammonia. By this means, and throwing all slops and soapsuds, &c., over it, a most valuable heap is formed that will prove of great service in securing sweet, crisp vegetables. Just now we have pulled up the stems of *Broccoli* from which the heads are cut, and will leave them a few days lying, not because we think the plan the best, but because we thus lighten the weight in taking them off—a matter of importance now when it is an object to avoid one useless step being taken. These stumps we sometimes char and sometimes burn, but no more profitable way for bringing them to a good account exists than packing them firmly in the *rubbish-heap*, mixing them with short grass, and covering over with earth. The grass will furnish heat enough to decompose the hard stems thoroughly and well, so that in cutting down such a heap in autumn and winter, much as you would take slices of a large cheese, not a bit of the old stump will be seen, but it has left some valuable properties behind it. Many of our readers who bother themselves, lessen the money in their pockets, and get into endless trouble from the imprudent use of artificial manures, might be safer and more successful gardeners from looking after their *rubbish-heap*. Well managed it becomes a mine of fertility.

Covered the ground about the early *Cauliflower* with grass and litter, to keep the drought out. The *Peas* in pots, removed to the bottom of a wall, are still bearing pretty well, and have furnished somewhat hard peas for soups. The *Tom Thumbs*, sown in the orchard-house, are now in full bearing; and when thus sown at once the pods are always much larger, and, we think, the peas more juicy, than when grown in pots; but the pot system beats the sowing for earliness, and also admits of their moving about, according as a place can be found for them. The *Peas* transplanted, or rather laid in rows from turves, are a perfect blaze of bloom, and young pods setting; whilst the earliest spring-sown *Peas*, out of doors, are not at all full in bloom as yet. As a general rule, we found that *Peas* sown in November were generally some seven or ten days behind those sown under protection in the beginning of March, and transplanted, and the trouble of guarding the *Peas* from excessive frosts and vermin during the winter is avoided. Last week we stopped our first *Broad Beans* in full bloom, to cause them

to set and swell freely. Sowed also *Beans*, *Peas*, *Turnips*, and *Radishes*. The bed for *Cucumbers*, made chiefly of dry litter and short grass, as described the other week, has yielded a nice mild continuous heat, in which the plants are doing well. Gave *Capsicums*, *Chilis*, *Tomatoes*, &c., another pot; for we can hardly expect this hot weather to continue, or we might plant out of doors at once. We have had *Tomatoes* all blackened as far on in June as we are yet in May. It will, however, take a great deal of cold weather to extract the heat the ground has obtained from the sun during the past week.

FRUIT GARDEN.

Strawberry plants, in full bloom, are now calling out for the water-pail. Those in pots, even when set on, and half packed in moss, have required watering mostly twice a-day. But for the bright sun so much watering would injure the flavour. Set a good many of the pots, with fruit about ripe, out of doors, where we could protect them a little, if necessary, by stretching a cloth over them. Here, in such weather, they will require less attention, and be better flavoured, than if kept under glass; and the plants, if neglected as to watering in-doors, are apt to be infested with red spider, and soon will communicate the pest to other things. If ever you see a trace of the little imp on a *Strawberry leaf in-doors*, the sooner the plant is removed carefully the better. A quick eye will often save much trouble and annoyance in this way. Some seasons we have had a little green fly on the *Strawberry plants* that were forced. We said the other week we had not seen one this season; but, going along the orchard-house last week, though the plants were a good distance from us, we saw there was something singular with some of the footstalks of the fruit, and, on examining them, found little colonies of green fly. We could find none on the leaves, nor on any other part of the plants. A couple of fingers and thumb soon went over all the leafstalks, making very short work of the insects that were touched; and a good syringing with clear soot water has sent every trace of them adrift. We mention this summary mode of dealing with such pests, because not seldom such work could be all done in the time required for arranging all the paraphernalia of smoking, washing, &c. We have known gallons of stinking tobacco water used for killing insects, and pretty well killing the shoots as well, when the whole affair might have been more efficiently managed from the free use of the fingers and thumb—those invaluable pieces of mechanism—and a liberal application of the syringe for removing all the filth of the dead remains of the insects, which, we own, are about as poisonous to the plants as tobacco water itself.

In the early forcing of *Strawberries* green fly is apt to show if at all clustered in the centre of the expanding bud, and a little nibbling will soon make short work of them if taken in time. No *Strawberries* will be worth gathering if ever the fly or the spider get ahead, and after the second free swelling of the berries no water overhead should be used except the cleanest. We were just late enough in the use of the clear soot water in the case mentioned above. We think it also right to state, that the sulphur lime water we have several times referred to as so valuable for syringing, does not answer for *Strawberries* after the fruit begins to swell freely. It seems to harden them too much and thus arrest the free swelling.

If fumigating with tobacco must be resorted to, two things are essential to success—first, the leaves of the plants must be dry; and secondly, the smoke must reach the plants and leaves cool. The fumigators of Epps and others are useful in this respect, as their construction insures cool smoke. They are thus most valuable for careful amateurs. They are too fine for common labourers. We think we had a couple of them some time ago, and they were of little use to us as the machinery was soon put out of order. In using pans, kettles, or pots, a thick covering of damp moss, or long grass, &c., is essential to secure the smoke rising cool. We notice that the very hot weather has brought green flies on some of the *Cucumber* leaves, and a few bruised laurel leaves have been shut up in the frames and pits. The *Cucumbers* will stand a stronger dose of these bruised leaves than *Melons* will, just as the smoking that will not injure one plant, will kill outright one more tender. Where nicety and economy are to be combined, it is useful to have a small

smoking-box in which the infested plants may be placed. The smaller the place the greater care is necessary not to give too strong a dose. The economy of the thing will be seen when we state, that one quarter of an ounce of tobacco will be as effectual in a small box as a pound or more in a large house. It is safer to repeat the dose than to give too much at a time, and if it is deemed proper to smoke at all, it should be done whenever the fly shows itself. If the leaves are plastered all over, smoking is pretty well toil and trouble in vain.

We know not exactly how it came to pass, but several cases have come under our observation in which houses of plants were next to permanently injured by fumigating the house after the plants had been well syringed. As a matter of economy it is well to cover pits and frames with some wet material whilst smoking is going on. Where that cannot be done, as in large lofty houses, it is a good plan to syringe or engine the outside of the glass roof all over, as the water fills the laps of the glass and keeps the air in. Once more. One of our lads is very careful not to shake or move a plant more than can be helped when it is to be smoked. He says, what is very true, that if a few insects fall on the ground they will pretty well escape the smoke and live to fight for the life of the plant another day. Even after smoking syringing should not be resorted to until pretty sure that every fly is killed. A little shading will be necessary next day, as the smoke always does a little to injure and stupefy the plants. A rather close moist atmosphere will also act in favour of the plants and to the disfavour of the insects. The chief causes of mischief in smoking plants by beginners are too large doses, and presenting the smoke hot. It is better to give several weaker doses than to injure a favourite plant. It is better still to avoid all risk by using when practicable the finger and thumb. We have known young ladies sigh and sigh again over the woe-begone appearance of some favourite plant, identified with many memories of the loved though absent, when a little water, a sponge, and a pail would, to the poor plants, be worth more than thousands of unavailing regrets.

The varied and frequent application rather than one or two strong doses we likewise advocate in the case of liquid manure, whatever be its composition. We have been applying farmyard liquid manure to Figs, to Peaches, Nectarines, Cherries, &c., in pots. It was so strong that we would rather have demurred giving it to Cauliflower. In its full strength we should have expected it would have thrown the fruit from our trees in pots. Doubly and trebly diluted it answered admirably, and the very sight of the leaves told you they liked it. In no other respect, except as to being careful as to strength, would we say a word against liquid manure. It is not often that house sewage is too strong for the ranker vegetables, such as Cabbages, but it is chiefly useful for growing crops. Some time ago we gave a watering with house sewage to a quarter of Cabbages, and we could almost conclude we saw them growing, the leaves getting a very dark tinge. We believe that by looking after such resources our cottagers might pretty well double their crops. We are glad the matter is so prominently alluded to by "UPWARDS AND ONWARDS" at page 365. In our case the difficulty is the getting enough of it. We should like to soak the Strawberry ground with it to-morrow; and just as it is the ground will soon take away all the effluvium, and the Strawberries will be as fine as if they had been moistened by the pearly drops of dew. Of course, in all such waterings, the foliage must not be watered if the liquid is at all strong.

VINES, BARREN.

Attended to Grape-thinning, &c., as we could get at them. Thinned Peaches, &c. Some years ago we gave an outline of the different modes of growing and pruning Vines, according to the circumstances and position of the roots. The gist of the article amounted to this:—Where the Vines were in good order, and the roots near the surface, it mattered little how the Vines were pruned—there would be sure to be fruit. In that case spur-pruning would be the best and easiest managed every way. When the Vines were very luxuriant, and the roots deep, spur-pruning would require more care in disbudding, and more artificial heat thoroughly to harden the wood. In lateish houses, where the roots had got into a deep rich border, and the leaves were large and the wood luxuriant, and but little fire was

used for extra hardening the wood, then the rod system would be better than the spur system, because a Vine would ripen a few shoots for the following year sooner than a great many. Of course we are taking no notice just now of remedying this evil by root-lifting, draining, &c.; but merely making the best of the unpleasant circumstances without any new board of works or workers. Last year, and again not long ago, we met with instances in confirmation of these ideas. Last year we were asked to look at some houses of Vines that were strong and luxuriant, but almost entirely barren. The borders had a good slope, and, we understood, were well made, but deep. Little firing was given to the Vines. We advised selecting a couple of shoots for the width of the house, giving them as much light as possible, and, as they grew, cutting out the barren spurs, and depend for fruit on these young shoots instead of spurs—in fact treat the Vine shoots like a Raspberry. Singular enough, in the last house we entered, there was a fair crop, but every bunch was on shoots of last season's growth, that had been left at the winter pruning from 3 to 8 feet long, some longer than that; and almost every bud had thrown out its fruitful shoots, whilst scarcely a bunch was produced on the shoots close spurred-in. This house came in to clinch the propriety of the advice given as to the other Vines. Lately we saw the same houses, and, as the advice was not followed, the same state of things may be seen now, with this exception, that many of the old stems spurred-in showed little signs of breaking at all, and those that broke regularly were next to barren, as last year the house with a fair crop had the bunches on long shoots of last season. We mention these Vines as an instance that, in the same unfavourable circumstances, a difference of treatment, as to growing and pruning, may make a great difference as to results.—R. F.

COVENT GARDEN MARKET.—MAY 21.

There is a good supply of all kinds of fruit and vegetables in season, and the demand is also good. Foreign importations are rather heavy. English Grapes and Pines are sufficiently plentiful, and Muscats have begun to come in. Strawberries are abundant; and good dessert Apples and Pears are now over. Spring Cauliflowers are bringing from 8s. to 12s. per dozen. English Peas 12s. per half sieve. Cut flowers are nearly the same as last week.

FRUIT.

	s.	d.	s.	d.		s.	d.	s.	d.
Apples.....	½	sieve	0	0	Lemons.....	100	4	0	10
Apricots.....	doz.	0	0	0	Nectarines.....	12	0	24	0
Cherries.....	lb.	1	0	2	Oranges.....	100	8	0	14
Figs.....	doz.	12	0	20	Peaches.....	doz.	24	0	40
Fiberts & Nuts	100 lbs.	0	0	0	Peas.....	bush.	0	0	0
Goosebrrs, Green	½ sieve	6	0	10	dessert.....	doz.	0	0	0
Grapes, Hothouse	lb.	8	0	14	Pine Apples.....	lb.	6	0	10
Foreign.....	2	0	4	0	Strawberries.....	oz.	0	6	1
Muscats.....	10	0	15	6	Walnuts.....	bush.	14	0	20

VEGETABLES.

	s.	d.	s.	d.		s.	d.	s.	d.
Asparagus.....	bundle	3	0	to	6	0	4	to	0
Beans, Broad.....	bush.	0	0	0	0	Lettuce.....	doz.	1	0
Kidney.....	100	2	0	0	0	Mushrooms.....	pottle	1	0
Beet, Red.....	doz.	1	0	3	0	Mustd. & Cress,	punnet	0	2
Broccoli.....	bundle	0	9	2	0	Onions.....	bushel	7	0
Cabbage.....	doz.	1	0	1	6	pickling.....	quart	0	6
Capsciums.....	100	0	0	0	0	Parsley.....	½ sieve	1	0
Carrots.....	bundle	0	6	0	8	Parsnips.....	doz.	0	9
New.....	1	0	1	6	6	Peas.....	quart	3	0
Cauliflower.....	doz.	4	0	8	0	Potatoes.....	sack	6	0
Celery.....	bundle	1	6	2	0	Radishes doz.	bunches	0	6
Cucumbers.....	each	0	6	1	6	Turnip.....	0	6	1
Endive.....	score	1	3	2	6	Rhubarb.....	0	4	1
Fennel.....	bunch	0	3	0	0	Sea-kale.....	basket	0	0
Garlic and Shallots,	lb.	0	8	0	0	Spinach.....	sieve	2	0
Herbs.....	bunch	0	3	0	0	Turnips.....	bunch	0	6
Horseradish... bundle	1	6	4	0	0	New.....	1	0	

TO CORRESPONDENTS.

GRAFFS DECAYED (H. Hallett).—The Grapes are very severely affected with what gardeners call "the spot." It is a gangrene, and, in your case, most probably caused by the roots having descended deeply into your "cold stiff soil." The remedy is to lift the roots very carefully in autumn, spread them at about 9 inches from the surface, and keep them there by protection in winter and mulching in summer.

SETTING OF GRAPES (Tills).—If you refer to our Number published April 19, p. 294, you will see full directions for artificially impregnating—that is, "setting" Grapes. Pollen from the Muscat of Alexandria, or from any other Grape, would do for the Canon Hill Muscat. Leave only one bunch on a shoot; and thin the berries of the remaining one, so soon as you can perceive which are the finest, and should be left.

MILDEW ON PEACHES AND NECTARINES (J. J.).—The fruit enclosed was spotted with mildew. Dust flowers of sulphur over the trees, and be particular to let it reach every part affected. You must let the sulphur remain on for a week, keeping up the moisture of the atmosphere by sprinkling the paths, walls, &c., with water morning and evening. After this syringe the trees as usual; but if the mildew is not quite gone continue to dust the infected parts with sulphur until the mildew disappears.

MILDEW ON ROSES (Ribby).—Dust the infected parts with flowers of sulphur, and wash it off with a decoction of elder leaves, made by pouring a gallon of boiling water on a large handful of them, covering the vessel until cool, then apply the liquor with a syringe. In future apply sulphur whenever a trace of the enemy presents itself, and thus prevent such desperate cases as yours appears to be. We would pot the seedling *Fuchsia*, employing turfy loam two-thirds, leaf mould one-third, with a free admixture of sand. Grow on in the greenhouse, and keep moderately supplied with water, placing it in a light airy situation. It ought to flower with this treatment before autumn.

TROPEOLUM AZUREUM CULTURE (M. D.).—Sow the seed when fully ripe in light turfy loam and leaf mould in equal parts, with a free admixture of silver sand. Provide perfect drainage in the pot, fill it to within half an inch of the rim with the compost, and then sow the seeds, covering lightly with fine soil. Give a gentle watering, and place in a mild hotbed (75°). Be careful to keep the soil always moist, but not wet, so as to sodden the soil, and when the plants appear admit air freely, and keep near the glass. When the plants are sufficiently large to handle put them singly in small pots, and keep them in the frame until well established. Afterwards remove to a light airy situation in the greenhouse, and keep well supplied with water, yet never watering until the soil be dry, then give enough to wet it through. Continue this treatment until the foliage begins to turn yellow, then gradually reduce the waterings, and keep the plants dry when at rest, or for three months. In future years pot the plants in August, or whenever they show signs of growth, varying the size of the pots with the size of the bulbs.

CROCUSES, TAKING UP (E. E.).—There is no necessity to take them up unless you wish it; then they must not be taken up until the foliage begins to decay. We should leave them where they are, deferring taking them up until the autumn, and not then unless the clumps were too large; even then we would plant them again the same day. It would be too late to sow *Mignonette* when the Crocuses were taken up; but if you sow the seed now, and cover it lightly with soil, putting it in between the Crocuses, the seed will germinate none the worse for being shaded with the Crocuses; and by the time the foliage of the Crocus turns yellow, which is the time to cut it off to the ground, the *Mignonette* will be ready to take their place. If you prefer taking them up you can easily sow the *Mignonette* seed in pots now, and plant it in the place of the Crocuses when they are removed.

STRAWBERRIES UNFRUITFUL (G. F. B., Scalding).—We should very much like to see a Strawberry three weeks earlier than others, and if this proves continuous, we will thank you for a few runners if you have any to spare, and the fruit keeps its early character. We would plant some of the present year's runners when ready, still keeping the old bed, and from one or the other we think you will obtain fruit another year. As your other Strawberries promise well, we do not think it necessary to trouble you with any particulars, especially as we do not know a variety called "French Pine," which requires some peculiar soil and situation.

TRITONIA ADREA FROSTED (Ribby).—Place the pots in a little heat, and the bulbs will soon start into growth if they have any dormant ones upon them; but if they do not they are dead, and may be thrown away after being in a house kept at 60° by night, or in a hotbed for six weeks, if no signs of growth are presented at that time.

PEAR LEAVES BLIGHTED (W. Armstrong and C. J. M.).—The leaves of both your specimens are blistered in consequence, we think, of the roots getting into a bad subsoil. Such appearances are generally presented by the leaves when the roots are deep in the soil, and beyond the reach of atmospheric air. We know of no remedy beyond taking away all the old soil down to the roots, cutting off those roots that strike down perpendicularly, and then covering them with some moderately rich and rather heavy loam, but not deeper than 9 inches, nor less than 6 inches. Pears are most subject to rust on the leaves and fruit when they grow in light soil over gravel.

BACK NUMBERS (S. R., Bromley).—You can have the three Numbers free by post if you enclose twelve postage stamps with your direction.

PRIZE ESSAYS OF THE ROYAL AGRICULTURAL SOCIETY (Tasmania).—If you write to Mr. Ridgway, Bookseller, Piccadilly, and give him a London reference, he will probably be able to obtain them.

SPOTS ON VINE LEAVES (A Constant Reader, Clapham Common).—They are caused by a Puccinia, one of the parasitical fungi. We do not think it will injure the crop; but to check it dust the under side of the leaves with flowers of sulphur, admit more air and have the air less damp. Deepening the surface soil of the border 6 inches was unwise. We should prefer taking off 6 inches, keeping the border from getting wet and cold in winter by some covering, and tempting the roots to the surface by a little manure laid on the border, and mulching in summer. Let there be no digging or forking.

PELAGONIUMS BLOOMING INDIFFERENTLY (A Lady Gardener).—The plants evidently have become drawn and weak owing to a want of sufficient light and air during the winter, or from being kept too warm, and too far from the glass at that season. The result is a deficiency of sturdy growth, and on this depend their blooming qualities. To prevent this defect in future, cut the plants down in August, and keep them in a cold frame until the young shoots are an inch long, exposing them to the full influence of the atmosphere on all occasions except when heavy rains occur, then the lights must be put on. Pot the plants when the growth named is made, replacing them in the frame, and keep it close for a few days to favour root-action, afterwards giving all the air possible by taking off the lights, replacing them only to protect the plants from heavy rains. The last week in September remove them to a dry, light, airy situation, and near to the glass in the greenhouse. Here they will need but little watering, but abundance of air and more heat than is necessary to keep them gently moving through the winter. They will need potting into their blooming-pots by December if wanted to bloom in May, and not later than February if for a June display. With this treatment we think you will be better satisfied another year.

PRESERVING SPECIMENS OF ANIMALS (H. S.).—The details are too long for our columns. You can buy the "Taxidermist," which gives full directions, for a shilling.

BEETLES ON ROSES (An Old Sailor, but Young Gardener).—The beetles which destroy the bark of the scions probably are small weevils. They come out of their hiding-places at night to feed. Spread a sheet, or other white cloth, beneath the trees after dark, shake the trees, and your lantern will enable you to gather up the fallen, which we leave to be disposed of as discretion dictates.

HEATING BY GAS (H. W. M.).—In our No. 588, at p. 210, you will find a drawing and description of such an apparatus as you require. Instead of a tank we would recommend you to have a three-inch pipe round your house.

FORCED HYACINTHS, &c. (R. A. Bayswater).—Place the pots outside in a sunny situation, and give them but little water after this, only enough to prevent the leaves flagging. If you have a border we should plant the bulbs out in it and leave them there. They bloom moderately well out doors the second season, but are not worth house-room the second year in pots. If you keep them in pots take up the bulbs when the leaves are yellow and withered, removing the offsets, storing them away on a shelf in a cool dry place. They may then be planted in borders in September, or, if you think proper, in pots as before.

AUBRETTIA AND CHEIRANTHUS SOWING (C. D.).—The first is not to be depended on from seed, and we should, therefore, procure a few plants and divide them into as many as possible, planting in an open situation about 6 inches apart. Keeping them well watered and shaded for a few days until well rooted, then remove the shade, and they will need no more attention beyond an occasional watering in dry weather and weeding. The *Cheiranthus* seed should be sown now in an open situation, and the seedlings when sufficiently large should be transplanted into beds to gain strength and become bushy. They should, therefore, be planted 6 inches apart in rows, and the same between the rows. When the bedding plants are removed in autumn, the *Aubretia*, *Cheiranthus*, and *Heartsease* should be taken up with balls of earth, the former so near together that they will cover the bed, or with 4 inches space between the plants from foliage to foliage. The *Cheiranthus* should be placed about 9 inches to 1 foot apart according to the size of the plants, planting them quincunx; the *Heartsease* 6 inches, if small plants, and from 9 inches to 1 foot according to their size; but so near as to cover the bed or beds.

WINTER CUCUMBERS (J. B. Clarkson).—If your seed of Lord Kenyon's *Favourite* was true, we think your failure is attributable to something more than the kind. It is one of the best winter kinds. *Monro's Prolific*, or *Sion House Improved*, is a prolific winter variety; and, if something large and handsome be desired, there is *Kirklees Hall Defiance*. *Reynold's Winter Cucumber* is a remarkably prolific kind, and a good user, but not very regular in shape. Any nurseryman that advertises in our columns can supply seeds. We never recommend dealers. The seed should be sown at the beginning of September, so as to get them planted out in a strong before dark weather sets in.

PEAR BLIGHT (X.).—Wash the trees every other night with water, and twice a week with soap-suds, omitting the water on the nights when the soap-suds are used. It is best applied with a garden engine, throwing it against the trees forcibly. This will mitigate the evil to a certain extent; but the best remedy is to paint the trees in winter, and wash the wall with a composition made by dissolving 8 ozs. of Gih-starch compound in a gallon of water, applying it with a brush, so as to reach every hole or crevice, at a temperature of 160°. Paint the trees and walls in winter with a peck of quicklime, and a like quantity of soot, forming it into the consistency of paint with a sufficiency of urine. The trees should be syringed with the soap-suds and water immediately after the bloom is set.

WEEDS ON GRAVEL WALKS (Idem).—We know of nothing better for destroying weeds than salt. This, strewed on the walks in dry weather, so as to resemble a sprinkling of snow, will kill them, and prevent others growing for a time. We do not know a weed called *Eltret*; send us a specimen.

INDIAN CORN (Bouchurch).—We have no doubt you could ripen Cobbett's *Indian Corn*, or *Maize*, in the Isle of Wight. You could obtain it from any large agricultural seedsman in London. It ought to have been sown at the end of April.

BEETLES IN VINERY (M. J. M.).—They are Weevils, *Curtellio sulcatus*; and there is no other mode we know of getting rid of them than by searching for them at night. Spreading a sheet under the trees and shaking them usually brings down all the insects.

PRUNING ROSES IN POTS (Statham).—You should not prune your Roses till they have ripened their wood and shed their leaves. All the cutting that should be performed now is to remove the decayed blooms and seed-pods, should they have formed any, and to thin-out weak and superfluous shoots. Dust with sulphur to cure mildew, and keep your plants well aired and exposed to light, and see that the drainage is in good order.

NAMES OF PLANTS (P. Crowley).—*Staphylea pinnata*, (J. B.).—*Arbutus andreae*. Native of the Levant. It is propagated by seed and budding in this country. (A Young Gardener).—1, *Davallia*, insufficient—perhaps *polyantha*; 2, *Nephtolepis tuberosa*, 3, quite insufficient; 4, *Pteris longifolia*; 5, *Platyloma falcatum*; 6, 4 *Ipopsis signatica*; 7, *Pteropeltis squamulosa*, (J. T. C.).—The silvery-leaved tree is *Elaeagnus argentea*. Mr. Hancock is the maker of wove hosiery, and it may be had double or treble. We do not know the price. To preserve it from chaffing on gravel it is wound on a reel. However, we use vulcanized india-rubber tubing, which is perfectly flexible and does not leak.

POULTRY, BEE, and HOUSEHOLD CHRONICLE.

A LITTLE MORE ABOUT EGGS.

DEAR MR. EDITOR, or, upon second thoughts, ought I not to address you in the plural, as editors and emperors speak of themselves as "we?" besides you own in print each week that there are two of you. Still one hand only is visible

in that capital article (May 10), entitled "Eggs;" perhaps one of you is taking his Whitsuntide holiday.

We had, indeed, a dispute about the receipt for the omelette. My wife said, "It was written by Mrs. Editor, of course it was; for no gentleman knows anything about cooking." I said, "No, the style is the same." This was tolerably decisive, save that the governess was heard to say, "Fiddlesticks about style," but this was hardly audible. Then how did you learn to make the omelette. Several suggestions were made. "It was part of a certain lecture." "Impossible," said I: "for they are always forgotten." "Well, then, the cook came in at breakfast-time and explained the whole affair." "Perhaps he went into the kitchen and saw it done." "Perhaps he did it." "Spoilt one at least," said my wife. "I think Mrs. Editor told him three times on the doorstep before he left home for 171, Fleet Street." "Nonsense; it came out of Miss Acton," said my mother-in-law. "No, that I am sure it did not." Long this ovarian dispute had lasted, when at length we settled it that Mrs. Editor wrote it out, and Mr. Editor turned it into his own English. "But then," said the governess, the last to give up, "How badly they manage the butcher boy; they ought to punish him as we do here, by making him take the indifferent-looking meat back again."

We, Mr. Editor, have also a butcher boy, a beefy-looking youth; you see beef in his over-ruddy cheeks and in his horrid red hands. He gives the gate an impudent swing, and whistles—yes, actually whistles as he passes my study-window; and is never civil but once a-year, that is when he asks for his Christmas-box. Now, we make this youth take the coarse legs of mutton back again, and that beats him, for he has to come again all the way from —.

But I have wandered far from my purpose, which was twofold—to tell you the pleasure your article gave us at Hilltop Rectory. I read it alone first, then summoned the whole family, and read it aloud in my best manner amid great applause. "Crule gal, Marree Tummas," was pronounced excellent by a lady critic, aged six. Well, we thank you heartily; poultry shows are out, and editorial articles are in, the more of them the better. But I would also add an additional word on eggs. Deities came out of eggs, if we believe Nigidius, who says, "There was found an egg of huge bigness, which, being rolled about, was cast upon the earth, and, after a few days, Venus, the goddess of Syria, was hatched therefrom, and hence the Syrian gods are called by Arnobius "the offspring of eggs." Macrobius resembles the world to an egg. By Hesiod and other Greek writers mention is made, saith Grotius, of a chaos signified by some under the name of an egg. Aristophanes in his play called the "Birds," tells us—

"There was no earth, nor air, nor heaven, till dusk night
By the wind's power on the wide bosom of Erebus brought forth an egg."

And according to this good gentleman, "mankind, and sea, and earth, and the blessed abodes of the immortal gods," all sprang from an egg.

Now, here is a mass of learning for the "Poultry Chronicle." Let none despise that wondrous thing an egg. If eggs have a little come down since those days, still we have a proverb to show their truthfulness; for we say "As true as eggs are eggs." Then, collections of eggs, the beautiful little things, tiny golden wrens', pale blue redstarts', many-speckled finches' eggs, rich brown eggs of the raptors, and that egg of eggs, that bit of pure porcelain the kingfisher's. By the way, this very morning I tried some soon-to-be-hatched eggs in a bucket of very warm water, according to your directions. Down went the addled ones to the bottom; those with dead clicks in stayed at the top, but were quite stationary, while the good ones soon began moving.

"Each walked (danced) the water like a thing of life."

Merry little grigs every one.

You speak, Mr. Editor, of the shape of eggs, how pleasant it is to the eye. I have a friend who rejoices in a drawing-room chimney ornament, an egg-shaped vase; on one side, the proper side to be seen by company, is a prettily-painted bunch of flowers, on the other nothing but the egg of one uniform blue colour. He always turns the bunch of flowers to the wall, the better to enjoy the pretty oval shape unbroken.

"A late very successful landscape painter," says Mr. Weigall, used to remark, "I know nothing about the draw-

ing of animals, what is the use of it? An egg is my model, and I find it quite sufficient for the purpose. If I want to introduce a sheep or goat, I put the narrow end first, and put horns where required, and it does for a goat or a cow. If it be a dog I put the thick end foremost, add a long tail and there you have it. I am a landscape painter, and only want to use animals as spots of colour in the make-up of a picture."

And, now, to conclude this rambling egg eclogue. May you and I, and all our readers never have aught but pleasant associations with eggs. May the dainty dears be pure buff or pure white, fresh if eaten, and may we never with the top of the egg decapitate a chick. May the omelette, by whomsoever made, be always excellent, and if required of a nestful of eggs, may each produce its chicken.—WILTSHIRE
RECTOR, Hilltop Rectory.

WHAT IS BONA FIDE PROPERTY?

This would seem to be a question not difficult to answer, yet "*bona fide* property" is, in the poultry world, a matter of very doubtful signification. Last year it was a cause of much difficulty, and in its present unsatisfactory state in poultry matters it will cause much discussion.

The greater number of poultry shows already advertised either directly or indirectly require that birds exhibited should be *bona fide* the property of the exhibitor; and yet so loosely is this regarded, that I have lately had an offer to exhibit another man's bird and a request for the loan of a bird, and this from quarters of high repute in the poultry world. I am far from making any charge of dishonourable and unworthy motives, but I give the instances to show what men well versed in exhibitions and birds are ready to do. I, of course, civilly declined the offer.

Either the rule with regard to a *bona fide* property in birds exhibited should be abolished or it should be rigidly observed. If it is to be abolished I do not care to exhibit again, nor do I think any one but a dealer would. In that case exhibiting becomes simply an advertisement, and such a one as many dealers I could mention would be ashamed to use. It would be an advertisement under false pretences, for birds and eggs might be sold at exorbitant prices from yards which had never seen and never would see the prize bird.

In the case of a *bona fide* purchase for exhibition there are reasons for prize-taking which, though shorn of the honour due to a breeder of prize birds, are quite justifiable;—the purchaser may wish to test the merits of his purchase; he may desire to sell the produce of the birds.

A receipt written on a sheet of note-paper, which was folded, sealed, and passed through the post-office without an envelope, would afford in the post-mark a guarantee of the period of purchase, and also of the repurchase of the birds should they pass back again into the hands of the seller. Of course birds might be passed off as those bred at home that were really hired or borrowed; but a little close inquiry and observation would soon lead to detection as they became recognised by experienced and conscientious judges, and by those exhibitors who would take the trouble to observe and make known any suspicious cases.

If the names of dishonest exhibitors are posted, and if shows carry out their threat of exclusion, the numbers of those who exhibit other persons' birds in their own name will become fewer, and the pleasure and the profit of honest exhibitors will be enhanced.

Both committees of shows and judges, to whom I will add exhibitors, would do well in the coming season not to attempt, nor to sanction, any unfair dealings; and I exhort all to co-operate in making known suspicious cases, that the competition of poultry exhibitions may be worthy of the ladies and of the clergy who contend in friendly rivalry with the laity of high and low degree. We want none of the dodges of the turf or the ring, and we do not wish to be thought sporting characters because we enter a Game cock for a cup or a sweepstakes.—EGOMET.

EARLY HIVING.—Three skeps of bees threw off top swarms in this neighbourhood on May 13th, at Millbrae, Alloway; at Doonside; and at Laigh Corton, Ayrshire.—*Glasgow Daily Mail*.

ARTIFICIAL SWARMS.

THE mode Mr. Woodbury adopts of making artificial swarms in the case of common straw hives, as communicated in his reply, is extremely simple and of easy performance, and may be practised by a mere tyro in bee-husbandry. The beauty of a thing often lies in its simplicity; but I question much whether driving the whole bees—queen, drones, and workers—into an empty hive, can justly be called a swarm in the common acceptation of the word. It is, in fact, an entire exodus—a thorough and complete eviction. I make no cavil, however, with this part of the process. I am somewhat averse from employing a second stock-hive in the process, and removing it to a new site in order to supplement the desolated hive. I should be disposed to view this part of the plan as tampering with the hive, not using it fairly, and risking its prosperity at least, if not its very existence. I had occasion a few years ago to remove a very strong hive from my attic window (to which it had migrated the preceding season and taken possession of a glass hive full of empty combs), to my garden some hundred yards distant, for the purpose of rendering its swarming more convenient, and the result was extremely prejudicial to the hive. It remained doggedly inactive for several days. The bees continued to leave the hive, but did not return. It then set to work and exterminated every drone in the hive; larva, pupæ, and full-grown drones strewing the ground with thousands of dead carcasses. Eventually I removed it to its original site in the attic window, and in the course of a short time it so far regained its pristine vigour, though too late to swarm. Mr. Woodbury, however, has proof from experience that the second hive is not materially injured by his process, and we are bound to believe him.

The process I adopt in the formation of artificial swarms is also extremely simple. It can be performed at any period of the day, and by a mere novice in the art of bee-husbandry. I only partially drive the bees into an empty hive—about three-fourths, leaving about one-fourth to hatch out and nurse the young brood. Supposing the stock to contain twenty or twenty-five thousand, I drive about fifteen or twenty thousand, leaving five or six thousand to the stock-hive. The queen generally moves into the empty hive at an early part of the process. If the operation is performed in the forenoon of a bright and mild day the whole hive may be driven, as a sufficient number of bees will be abroad in the fields wherewith to supply the old hive. I then place the artificial swarm about 2 feet to the right of the original site, and the stock about 2 feet to the left of the same position. It is advisable to shut up the stock-hive for the next day or two, removing it to a dark and cool situation, and affording it abundance of ventilation. The best method, however, is to convey at once the young swarm away to the distance of a mile and a half or two miles, and plant the stock-hive on its original site. The beauty of this plan consists in the circumstance that you require but one stock-hive, and you do no injury to any other hive. An observant and skilful apiarian has a good guess as to the time when a hive will swarm, and the greater certainty he attains in such knowledge the more correctly will he know the proper period for making an artificial swarm. It is of the utmost importance that the old hive have royal cells sealed, or in process of being sealed, when an artificial swarm may be made, as the operation will be then most successful. I have had instances where, when this was not the case, the old hive failed to rear a queen, and of course went to ruin. This may arise from the stock having no eggs or larvae from which to rear a queen, or from the bees not becoming sensible of the loss of their queen until too late. In making artificial swarms it is of great moment, too, to have a supply of supernumerary queens. I have to thank Mr. Woodbury for his account of his mode of making artificial swarms, and to state that I intend to adopt his plan with at least one hive in my apiary in order to test its efficiency.

In conclusion I may be permitted to state, that to me the natural swarming of bees in all the preliminary preparations, and in all the excitement connected with the actual rush from the hive, with the swarm in the air and on the bush, possesses an indescribable interest, in comparison with which all artificial plans and processes are tame and insipid.—PHILISCUS.

[“PHILISCUS” has doubtless perceived ere this that my

friend Mr. S. B. Fox stated, in page 357, that he had tested and approved of the mode of making artificial swarms recommended by me in page 323. I need not remind the readers of THE JOURNAL OF HORTICULTURE that Mr. Fox is one of the most able apiarians of the day, and that a plan which is endorsed by him and by “B. & W.” can scarcely fail to be good. Whenever an artificial swarm is to be formed I always expel the whole of the bees. Setting aside the great difficulty of arriving at even an approximate estimate of the proportion of bees remaining in a partially driven hive, it is but seldom that the queen is seen to quit her original domicile; and therefore the only means of being certain on this essential point is to drive the whole, since I have often known her nearly the last to depart. It is, of course, a great advantage to have royal cells in progress, but in their absence the risk of failure with perfectly healthy stocks and at the proper season may be deemed infinitesimal. Its repeated recurrence in an apiary would, in point of fact, appear to me to argue the existence of foul brood in some of its stages. “PHILISCUS” has not, however, divined the difficulty hinted at by Mr. Lowe, which, he states, is not dependant on the want of royal cells, but “because of the absence of certain other conditions.” As I said before, I hope Mr. Lowe will be kind enough to enlighten us on this point.—A DEVONSHIRE BEE-KEEPER.]

QUANTITY OF PORK A BUSHEL OF CORN WILL MAKE.—At the meeting of the Farmers' Club of the American Institute on the 1st of March, a communication was received from a man in Illinois, giving an account of some experiments made by him to ascertain the quantity of pork which could be produced from a bushel of corn, fed in different states. As young pigs require food other than corn, he took for experiments swine more than four months old. He says that, with hogs in clean comfortable pens, supplied with plenty of dry straw—

50 lbs. of corn, whole and raw, will make	10 lbs. of pork.
50 " do. ground	15 " "
50 " do. ground and fermented	17 " "
50 " do. cooked and fermented	21 " "

—(Canada Farmer.)

OUR LETTER BOX.

VARIOUS (Cecil).—We believe Mr. Baily supplies eggs of all descriptions for sitting. It is getting late for Turkey's eggs. The book he has published is that which is the professed to be: it is a work on fowls only.

SINGLE-COMBED PENCILLO HANDBRAGS (Bolton Gray).—It is not certain that your birds are of inferior strains, but you would do well, if you could, to get rid of the offender. It is often the case that the single-combed bird is very superior in colour or in marking, and that induces amateurs to keep such, and to breed from them, in the hope of perpetuating only the good points. The same is true of the Sebright Bantam. The attempt is never more than partially successful, and every now and then the single comb shows itself, as in your instance. We have little doubt that the breeder would recollect the origin, however long it may be ago.

BRADING SPANISH FOWLS (H. M.).—If we desired to breed perfect Spanish fowls, we should not allow any other breed to run with them. It does not in any way affect the cock; but we have known sports in Spanish chickens from the presence of coloured hens. This would also be an answer to your second question. You can only succeed when all is in your favour. It is, therefore, unwise to incur even an imaginary risk. Having said that, we now give our own opinion—that there would be no mischief: we do not believe Bantams can interfere with Cochins.

BEES NEAR WOLVERHAMPTON.—Several hives have swarmed during the last few days, which is earlier than I ever remember in this district. One of my hives swarmed May 18th.—J. E. B. [The “grub” you enclosed is an immature young bee.]

DEATH OF A LIGURIAN STOCK—PREMATURE DRONE EXPULSION (A South Lancashire Bee-keeper).—The demise of the queen was the evident cause of the loss of your Ligurian stock; but this accident proves nothing either for or against the value of the new species. Premature drone expulsion argues some check (probably but temporary) in the prosperity of the hive. We have known wet weather in June cause the destruction of every drone in an apiary.

ARTIFICIAL SWARMS (T. S. Peckham).—We very much doubt the success of the proposed plan. Nutt's collateral-hives are so ill adapted for this purpose that we should prefer natural swarming, or, if compelled to resort to artificial means, should opt for driving, as in the case of common straw hives.

SWARMING IN SURREY.—The swarming season commenced early in Surrey; on the 1st of May a swarm being taken on Kingston Hill. In a neighbouring garden there was one on the 7th, and since that time they have been numerous; while the lovely summer weather we are now enjoying, added to most luxuriant vegetation, gives every promise of a fine honey season, and much pleasure to the apiarian.—A.

GLOVES FOR APIARIANS (E. H.).—You need not trouble yourself about procuring photographers' diaphragm gloves. Any leather gloves, with the cuff of the coat tied close over them at the wrist, will protect you from the stings of the bees.

GOLD FISH CHANGING COLOUR.—“M. G.” would be obliged by being informed what is the cause of gold fish turning black about the head and fins, and also if there is any cure for it!

WEEKLY CALENDAR.

Day of M th	Day of Week.	MAY 31—JUNE 6, 1864.	Average Temperature near London.			Rain In last 37 years.	Sun Rises.	Sun Sets.	Moon Rises.	Moon Sets.	Moon's Age.	Clock after Sun.	Day of Year.
			Day.	Night.	Mean.	Days.	m. h.	m. h.	m. h.	m. h.	m. s.	m. s.	
31	Tu	Flat-stalked Meadow Grass flowers.	69.1	45.3	57.2	14	51 af 3	4 af 8	34 1	37 3	25	2 34	152
1	W	Common Elder flowers.	68.0	44.4	56.2	13	50 3	5 8	2 2	32 4	26	2 25	153
2	Th	Red Poppy flowers.	68.0	44.7	56.4	16	49 8	6 8	34 2	2 6	27	2 16	154
3	F	Rye Grass flowers.	68.7	44.5	56.6	17	48 3	7 8	13 3	8 7	28	2 6	155
4	S	Deadly Nightshade flowers.	68.9	45.0	57.0	14	48 3	8 8	57 3	5 8	●	1 56	156
5	SUN	2 SUNDAY AFTER TRINITY.	70.5	46.9	58.7	21	47 3	9 3	48 4	55 8	1	1 46	157
6	M	Pheasants hatch.	66.5	48.1	57.3	19	47 3	10 8	45 5	34 9	2	1 35	158

From observations taken near London during the last thirty-seven years, the average day temperature of the week is 68.5°, and its night temperature 45.5°. The greatest heat was 90° on the 6th, 1846; and the lowest cold, 32°, on the 31st, 1857. The greatest fall of rain was 0.91 inch.

DISTRIBUTION OF PLANTS IN GENERAL, AND ALPINE PRIMULAS IN PARTICULAR.

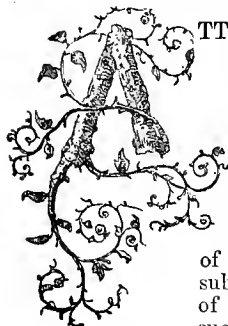

ATTENTION to the conditions in which Nature has placed her numerous offspring, and the imitation of those conditions, have enabled man to bring within a limited space almost enough of lovely forms to make our dear country a second Eden. There is scarcely a plant (and do we not obtain them from every region of the globe?) but what has been subdued by the enterprise and skill of British gardeners, and brought to such a state of perfection as to rival

the species in its native country. It seems, however, whilst we are so particularly successful in cultivating the gems of other lands, that there is one charmer in our own that has hitherto defied all attempts at keeping it in a state of cultivation. I allude to an extract in this Journal, No. 160, page 300, taken from the "West of Scotland Horticultural Magazine," in which it is stated that the Scotch Alpine Primrose (*Primula scotica*), one of the loveliest of our native plants, "would be highly prized by the cultivator if it could only be induced to submit to the restraints of cultivation." I am prepared to reply to this that it can; but what restraints of cultivation mean I do not so clearly understand. Surely it is not intended to convey an impression that man seeks by restraints on Nature to show her in all her loveliness. Man undoubtedly has the power to cause her to rest and to work when he pleases; but all these restraints must be used in strict accordance with the nature of the subject. He cannot make an alpine grow in water, nor a Sedge on the shelving rock. He may take away year after year the tendrils of the Vine, but it will show its tendrils nevertheless. He may take a plant from the mountains, and get it to luxuriate in the valley; but make a plant flourish under unnatural conditions he cannot. It may be the nature of alpine to grow on mountains whilst nobler verdure clothes the valleys; but cannot all vegetation be had in perfection by artificially providing the same conditions as Nature provides her offspring? It is immaterial whether the subject be brought from the tropics to the temperate regions, or from hill to dale, or *vice versa*; only create an artificial climate, soil, &c., equal to that enjoyed by the subject in its native habitat, and it flourishes equally well in its artificial as in its natural habitation.

Why a plant should be found only in a certain place, and yet thrive equally well in another diametrically its opposite, whilst another refuses to accommodate itself to a situation other than its natural habitat, certainly is likely to draw the reply, "It is just its nature." I cannot, however, bring myself to see any mystery in this; but am inclined to think that non-success in the

cultivation of any plant is due to man's not providing certain conditions of soil and temperature, with the other elements enjoyed by it in its native home, rather than to there being some peculiarity about the plant or its situation which man cannot provide for artificially. For instance: *Asplenium marinum* is nowhere found in a wild state except in moist shady parts of rocks near the sea; but it does not leave the shore of its own accord, nor will it grow inland exposed to the open air for any length of time. Why does it grow near the sea, and nowhere else? The plant's nature may forbid it to do otherwise. But this is not an answer to the question. An inquiry will solve this problem, and practice prove it correct, if we put the question thus—What prevents its growing inland? We have to discover what are its natural conditions and requirements; but being a plant found naturally on the borders of the immense reservoir of salt we may unintentionally come to an incorrect conclusion by imagining the plant owes part of its existence to its peculiar natural situation, and derives nourishment from the saline sea breezes. This, however, is only conjecture, for we find salt water will not assist in its cultivation. The plant does not perish away from the sea because of a want of any nutriment afforded by the air, for the atmosphere is equable throughout the world, so that a plant breathes air composed of the same elements at Moscow as at Cape Clear. We find the plant most luxuriant and abundant on the coast of Wales, and it, like Ireland, is indebted to the Gulf Stream for much of its warmth in winter; and it is well known to be warmer on the western coast than the eastern, also that the temperature at the seashore is some degrees higher than further inland. This plant, then, feels the loss of the warmth afforded by the sea when it is subjected to cultivation inland. It will do well if exposed in summer and protected in winter from the severity of the weather, and it grows in the greenhouse with a luxuriance never equalled in its native home, and revels in the heat of the stove. It would seem as if it had in England reached its utmost northern limit, and that temperature alone fixes its limits; for though found most abundantly on the rocks by the sea in Wales, and we find it again on the east coast, at one or two places in Durham, and I believe in Northumberland, yet it has never, I believe, been found on the coast of Scotland.

The same remarks apply equally to the Maiden-hair Fern (*Adiantum capillus-Veneris*), a plant indebted to the warm sea breezes for its existence naturally in this country and the Sister Isle; and the same holds good of the Killarney Filmy Fern (*Trichomanes radicans*). The former attains much larger proportions in the warm climate of Madeira, grows in a greenhouse with a luxuriance far surpassing its natural growth, and becomes quite rampant in a stove. There is nothing in the atmosphere that can possibly hinder our cultivating by artificial means plants from any part of the globe.

It would materially assist us in the cultivation of the plants we receive from abroad if collectors were more particular in giving us an account of the localities in which

the species were generally found. It is really remarkable what an amount of ill-usage a plant is subjected to before its natural requirements are discovered. To say a plant is found in China, for instance, is giving us a very extensive range of country to investigate. It may be a native of the hills, luxuriating on the verge of perpetual snow, or situated a little lower down, enjoying in summer the cold waterings of the melting snow above, or a native of the valleys with their tropical climate; to say nothing of geographical distance from north to south, with the collateral influences produced by propinquity to the sea or to rivers, to lakes or to mountains, of most of which we are left ignorant, and so have to grope our way in the dark. The conditions of soil, situation, climate, &c., are all points required to be known, and then cultivation is an easy matter. Many plants now cultivated in greenhouses were, even in my memory, grown in stoves, and many plants formerly grown in the greenhouse are as hardy as a Dock, and this through the inattention of collectors to the situation in which the plants were found. It is only to mere chance that we owe our discovery of the mode of cultivating many plants.

Even so also with our native plants. Considering the way in which they are abused by inattention to the conditions of their natural requirements it is really wonderful how they are enabled to exist at all under cultivation. There is scarcely a lover of plants but is anxious to bring some plant away with him or her from the places visited. The plant itself may attract attention on account of its being in flower, and because it is a lovely thing it must be taken to serve as a reminder of the visit. Do those persons know anything of the habit of the plant? Is the soil, the understratum or subsoil, considered? the situation—shaded, exposed, sheltered, wet, or dry—noted? the temperature of the locality known, and the species, general time of growth and rest ascertained, with a view to successful cultivation in an artificial climate? Seldom indeed are these things considered. I have received *Orchises* in full bloom with a ball of earth, but without the bulbs in it, Ferns taken or plucked from the rock without one morsel of root to them, and lovely alpine plants literally stubbed so as to be dead before they came to hand.

Persons desirous of cultivating wild plants will do well to mark the species when in bloom, to note minutely where the best specimens grow, also the soil and situation, and the conditions of shade, shelter, moisture, and other peculiarities of the locality, and then depute some person to send the specimen to its new domicile when inactive or when on the point of starting into growth. By the time the plant is received a suitable situation, soil, &c., will have been provided, and by perusing works on the subject, which with the knowledge gained by a personal inspection of the situation the plants naturally grow in, the cultivator will be enabled to commence asking questions of Nature on the arrival of the plant, to which she never responds falsely. The species, be it what it may, grows with a luxuriance equal if not superior to what it did in its native habitat, and Mr. A. becomes noted for its cultivation. "It grows well with him," says Mr. B., "but I cannot get it to live, or only for a few months, and then it dwindles away and dies. What can be the reason?" The one has studied the subject, the other's knowledge is superficial; the one knows fully what he is about, but the other imagines and reaps accordingly.

But my object in this communication was to tell those having a liking for those lovely alpine Primroses of our own and other lands, that they need not give up their cultivation in despair, for *Primula scotica* and others I shall enumerate may be seen luxuriating amongst a number of others in the extensive collection of alpine plants at the nurseries of Messrs. Backhouse, York; and of A. Stansfield & Sons (the elder of whom is very kind and communicative, in addition to being one of the best botanists in the kingdom, and President of the *Podmorden Botanical Society*), *Podmorden*, Lancashire, and other nurseries which do not strike me at the moment. In the smoky atmosphere of Bradford, Yorkshire, I grew it myself for six years, having in the first instance received it in a pot from a nurseryman, and judging from its strength it evidently was in fine health. This was the first plant I received in a growing state, and though told it was difficult to cultivate, I planted it out in a patch of *Primula farinosa*, which I had from the limestone meadows of Craven, forming a nice bed on an east border

some 5 feet by 3, and containing over three hundred plants, flowering finely in the beginning of June each year.

Now for a hint or two on alpine Primroses, but *P. scotica* in particular. They all delight in a cool, moist, but well-drained soil, and a situation exposed from all points. Growing in pastures, they require the shelter which is afforded by the thick short grass having a mossy bottom. Most thrive best in yellow or hazel loam which is retentive of moisture and yet contains a quantity of silicious matter; but any strong loam will do if an equal quantity of cocca-nut dust be incorporated with it. It is immaterial whether they are planted out or grown in pots. If in the latter, use good drainage to fully one-third of the depth of the pot; but if grown in beds, place some rubble at the bottom of the bed, and then cover with soil to the depth of a foot. A six-inch pot is large enough for a good specimen. The parings of a field, the soil of which is of a proper description, taken off 3 inches thick, chopped with a spade, and put in whilst fresh, and slightly trodden down, answer perfectly. If an east border can be had, and it is fully exposed, a better site could not be had; but if not, a northern aspect must be selected in preference to a southern one; for we are not seeking shelter from cold, but from the burning rays of the sun. If the plants are grown in pots they can easily be accommodated in a frame as their necessities require. Thus, in February and March the frame should be on a south border, in April and May on an eastern one, and in June and July on one with a north aspect, and the remainder of the year it should have an east or west aspect, preference being given to the former. From the first appearance of growth the frame should be tilted on bricks at each corner, and the lights need not be employed, except to save the plants from being deluged with rain and snow, and the flowers from being dashed. In winter the pots should be protected from frost with cocca-nut fibre or some such material, or ashes, and the lights should be drawn over them. Repotting is best done in March, placing the plants so that they may be slightly elevated in the pots, for they do not like to be buried or planted deep. It is not necessary to pot them every year, but a top-dressing of fresh soil, after removing some of the old, will do every other year, instead of potting; but should a plant look at all sickly pot it immediately, removing as much of the old soil as practicable without injuring the roots, and if it is very wet and sodden remove it all, and pot again in sweet compost. For potting purposes the compost is best a year old, but for beds I like it fresh from the pasture. Water will be needed rather sparingly in spring, increasing the quantity as the plants advance in growth, giving copious supplies when they are in flower, and then reducing the quantity with the progress made towards a state of rest. When at rest it is only necessary to keep the soil just moist. G. ABBEY.

(To be continued.)

EDINBURGH BOTANIC GARDEN.—This garden is about to receive an extensive addition by the incorporation with it of the Experimental Garden adjoining it to the south. The Experimental Garden was established by the Caledonian Horticultural Society, but was assisted by a Government grant of £200 from 1833 to 1858. In 1857 the Society finding itself in difficulties memorialised the Board of Works to take the lease off their hands, and in 1858 these difficulties were increased by the withdrawal of the grant. After repeated delays the Council of the Society have received an offer of £1000 from the Board for surrender of the lease, and for the large hall, winter garden, and gardener's house, on condition of the Society paying the arrears of rent due to the office of Woods, which have accumulated to nearly £850. At a meeting of the Society, held on Thursday, it was resolved to accept the offer. Sir W. G. Craig, who presided, expressed his confidence that the Board of Works would use the additional grounds in such a way as to confer a great boon on horticultural science. The great herbarium in the Botanic Garden, second only to that of Kew, was almost destroyed for want of accommodation, but in the great hall of the Experimental Garden would be admirably exhibited for study and consultation. The winter garden, when filled with the half-hardy plants of the Botanic Garden, would be one of the most beautiful resorts for the public during the

winter; and a great part of the new ground would be set apart as an arboretum, which would be of great importance to proprietors of land and to the numerous students of botany in Edinburgh University, which was the greatest medical school of the kingdom. Although the arrangement was not an altogether favourable one for the Society, it was one which would be of great benefit to the public, and would render the Botanic Garden of Edinburgh one of the best equipped establishments of the kind in the world.—(*Times*.)

CRYSTAL PALACE SHOW.—MAY 28TH.

COMING so soon after the Royal Botanic Show, as might be expected, a large proportion of the plants exhibited had already appeared there; and it is almost superfluous to add that the display was both extensive and fine, though scarcely equal to that of the same season last year.

Stove and Greenhouse Plants were both numerous and fine. Among them we remarked fine specimens of *Pleroma elegans*, *Allamanda cathartica*, *Aerophyllum venosum*, *Stephanotis floribunda*, *Leschenaultia*, *Aphelexes*, *Vincas*, *Pultenea Paxtoni* (a fine bush covered with yellow and red flowers), *Chorozema cordata*, and *Ixoras*.

In collections of fifteen, Mr. Whitbread, gardener to H. Collyer, Esq., Dartford, took the first prize; Mr. Peed the second; Mr. Fraser, Lea Bridge, the third; and Mr. May, Hawkesyard Park, the fourth. In twelves, Mr. Green was first; Mr. Whitbread second; and Mr. Kaile, third. In eights, Mr. Carson was first; Mr. Chilman second; and Messrs. Lee, third.

Orchids made an extensive and fine display. *Oncidium Lanceanum*, *Cypripedium Stonei*, the new hybrid *Cattleya Dominiana*, *Ceratopetalum punctatum*, and *Cypripedium caudatum*, with its long tail-like appendages, were a few of the most remarkable of those not already noticed as being at the Regent's Park. For sixteen, Mr. Baker, gardener to A. Bassett, Esq., was first; Mr. Page, and Mr. Bullen, Leicester, equal second; Mr. Milford, gardener to E. McMorland, Esq., third; and Mr. Wooley, Cheshunt, the fourth. The first prize for ten was taken by Mr. Penny, Regent's Park; the second by Mr. Milford; the third by Mr. Baker; and the fourth by Mr. Wilson, gardener to W. Marshall, Esq., Enfield. In sixes, Mr. Penny was first; Mr. Whitbread, second; and Mr. Milford, third.

Heaths were not numerous, but some of the specimens were very fine. In collections of six, Mr. Peed was first; Mr. Rhodes, Sydenham Park Nursery, second; Mr. Chilman, third; Mr. Page, Streatham, and Messrs. Jackson & Son, fourth.

Azaleas made a good display, the most remarkable being Mr. Turner's large plants, which distanced all competitors. In tens, Mr. Turner, Slough, was first; Mr. Page, second; and Mr. Peed, third. In sixes, Messrs. Penny, Fraser, and Page, were the principal prizetakers.

In Roses in pots, Mr. W. Paul took the first prize for a fine collection of ten, in which we noticed *La Reine*, *Paul Perras*, *Charles Lawson*, and *Souvenir d'un Ami*. Messrs. Lane were second. For ten plants in pots not exceeding 8 inches in diameter Mr. Turner took the first prize with healthy vigorous plants in splendid bloom. Among them *Victor Verdier* was noticeable for its brilliancy and freshness; *Juno*, *La Reine*, *Charles Lawson*, and *Catherine Guillot*, were also very fine. Messrs. Paul & Son were second; Mr. W. Paul, third; and Messrs. Lane, fourth. Of cut blooms, numerous fine boxes were exhibited in the Miscellaneous Class by Messrs. Paul & Son, and Mr. W. Paul.

Pelargoniums consisted of nearly the same kinds as shown at the Regent's Park, and the plants were equally remarkable for their size and profusion of bloom; in fact, most of them were the same plants. Mr. Bailey, of Shardeloes, had the first prize, and Mr. Fraser the second; and in Fancies, Mr. Fraser and Mr. Turner were equal first, the former also taking the third prize.

Calceolarias, nearly the same as shown at the Regent's Park, came from Messrs. Dobson & Son, who received a first and a second prize. Of other objects, Messrs. Hooper & Co., Covent Garden, sent a collection of *Ixias*; Mr. Turner, *Bougainvilleas* and *Fuchsias*; Messrs. Ivory & Son, an extensive and interesting collection of British Ferns; Mr.

Williams, Mr. Bull, and Mr. Fraser, new and rare plants. Some seedling *Azaleas*, *Pelargoniums*, &c., were also shown, which may be the subject of comment hereafter.

FRUIT.—Of this there was a small but good display. A few good Pines were shown, among which we observed a Smooth-leaved *Cayenne* from Mr. Wallis, Astle Park, Cheshire; and a *Queen* and *Black Antigua* from Mr. A. Henderson, Trentham, for which prizes were awarded.

Among Grapes, several excellent dishes of *Black Hamburghs* were exhibited: those from Mr. Meredith of Vine Cottage, Garston, which took the first prize, were splendid; Mr. A. Henderson's, which received the second prize, were also very fine. Prizes were also awarded to Mr. Petch, Mr. Wallis, and Mr. Hill, Keele Hall, who had three fine bunches, weighing 8½ lbs., but not sufficiently coloured. Some very fine baskets were also shown. Mr. Meredith had a first prize for a splendid basket of 18½ lbs., in which the berries were very large and beautifully coloured. Mr. Hill, Keele Hall, was second; Mr. Clement, East Barnet, third. Muscats were not sufficiently coloured. Mr. Horwood had both the first and second prizes, Mr. Embury being third.

About two dozen Melons were shown, which as far as appearance went were very satisfactory. The best Green-fleshed was a hybrid *Cashmere* from Mr. Meredith; and Mr. Eustone was first in *Scarlet-fleshed*.

Peaches were very good for the season. *Grosse Mignonne*, from Mr. Joyce, was very large and fine, and was awarded a first prize; the second and third going to Mr. Taylor, East Barnet, and Mr. Turner, Slough, for the same kind.

Nectarines were also in good condition. Mr. Evans, gardener to C. Newdegate, Esq., M.P., and Mr. A. Henderson had second prizes; the former for *Ehruge*, and the latter for *Violette Hative*.

In Figs, of which several very good dishes were shown, Mr. Cross, The Grange, Alresford, was first with *Brown Turkey* and Mr. Dawson, Broadlands, second with the same kind.

A few good dishes of *Cherries* were shown, *Circassian* from Mr. A. Henderson, taking the first prize, and *Elton* from the same, the second.

Strawberries were very fine, Mr. R. Smith, of Twickenham, was first in single dishes, with *Sir Charles Napier*, and in three dishes with the same kind, *Empress Eugénie*, and *British Queen*, the berries in all of remarkable size. Mr. Budd, of Cobham Hall, was second. Mr. Smith had also some very good plants in pots bearing well. Lastly, Mr. Mortimore, gardener to A. Smee, Esq., Carshalton, had an extra prize for *White Juneating Apples* and *Citron des Carmes Pears*, but it was not stated where they were grown.

THE ROYAL HORTICULTURAL SOCIETY'S FLORAL FETE.—MAY 24TH.

IF plenty of glass and a quantity of fading flowers constitute a Floral Fête, then this was one. But it would be unfair not to add that there were additional attractions, which, as the advertisement set forth, were "Cascades and Fountains, also, Minton's Majolica Fountain from the Exhibition of 1862; Mast Tent for *Rhododendron* Show; New Orchard-houses; Military Bands. Hours 12 to 7. Admission 1s." This is such an admirable example of the travelling showman's style that we have preserved it.

Then the arrangements for the admission of visitors, what were they? There was nothing to indicate the whereabouts of the Show, and people had to hunt all over the grounds to find it—even having found it, they might pass through it without knowing that it was a show, for of such it did not deserve the name.

In consequence of the low charge for admission, much to the annoyance of the Fellows, flocks of nursemaids and children were admitted—certainly with the effect of swelling the numbers, but not of increasing the comfort of the company, for whose delectation three volunteer bands performed; the more refined music of the Guards being reserved for larger and more aristocratic gatherings.

The only plants shown for the decoration of halls and churches came from Mr. Bull. Among these were a fine *Rhopala corcovadensis*, and a *Dracæna australis*, each about 17 feet high; *Alsophila excelsa*, 8 feet across; *Dracæna rubra*, with two of its long racemes of violet flowers; *Nor-*

folk Island Pines; *Latania borbonica*, *Musas*, *Dracenas*, *Stadmannia australis*, &c. For these a £5 prize was awarded. For the decoration of churches the only exhibition came from the same exhibitor. It consisted of *Seaforthia elegans*, *Chamaerops Fortuni* and *Palmetto*, and various other Palms, *Araucaria Cookii*, *Dracenas*, &c.

Plant cases came from Messrs. Barr & Sugden. These were in a variety of forms, round and oblong, covered with bell-glasses, and with upright sides and curvilinear tops. They were very tastefully filled; one, in particular, called the *Alexandra* plant case, containing an imitation rockwork, planted with Ferns, *Begonias*, *Bertolinia marmorea*, &c. Another, containing *Campylobotrys refulgens*, and *Sonerila margaritacea*, also looked very well. In some, too, were shells suspended from the roof. Mr. Bull had some very pretty vases of alabaster paste, with classic designs, and flowers and fruit on the sides, and which looked very well, filled, as they were, with lively green Fern fronds.

Of dinner-table decorations the best came from the Viscountess Holmesdale, and consisted of three glass stands branching from near the base, and reuniting in a bouquet holder at the top, the interval between them forming an ellipse. These were neatly filled with *Adiantums*, Yellow *Banksian* Roses, Scarlet *Geraniums*, *Stephanotis*, *Deutzia gracilis*, and Grasses. With the exception of Miss Wint's design none of the others were to our taste. Miss Wint's consisted of a basket supported by three twisted glass pillars, and the materials used were Ivy, Ferns, *Geraniums*, *Roses*, *Forget-me-nots*, and *Azaleas*. Mr. Robson had a design for a table ornament, but the glass stand had a heavy appearance; *Lady Hume Campbell*, a plateau of flowers for the centre of the dinner table, the sides of gilt wicker-work, with a tin inside for holding wet sand. Miss Alice Sutherland, Coombe, sent a design for a Christmas screen for the chancel of a church. It was simple and effective, being formed of wires crossing each other in a transverse direction, so as to form lozenges or diaper work; Holly leaves and berries being placed at the intersections. A similar design for Easter, in which *Cinerarias*, *Wallflowers*, and *Geraniums* were used, also came from the same exhibitor. Mrs. Stoddart exhibited artificial flowers beautifully executed in rice paper.

From Messrs. Dobson & Pearce, 19, St. James' Street, came an extensive assortment of flower-glasses, and stands for dinner-table and drawing-room decoration, and among others what was called the Holmesdale stand, being the same as that used by Lady Holmesdale in her table decoration. Messrs. Banting, St. James' Street, had March's crystal jardinières, now well known for their great beauty; Mr. Helbrouner, 265, Regent Street, flower-baskets, and a flower-tray, having an inner casing for wet sand in which cut flowers may be stuck, and the stem hollow to act as a receptacle for waste water; Messrs. Naylor & Co., 7, Prince's Street, Cavendish Square, glass stands for table decorations, and some very ornamental flower-glasses and vases; Messrs. Claudet & Houghton, 89, High Holborn, plant and Fern cases and ground glass flower-glasses; and the Coalbrookdale Company, garden chairs, fountains, and vases. As prizes and honourable mentions were awarded to almost all the exhibitors it is needless to particularise the recipients.

We may add that the new entrances, absurdly called orchard-houses, are now finished. They are span-roofed houses, about 200 feet long, and 12 feet high, with a walk passing down the centre. On each side of this walk orchard-house trees are to be planted and grown in pots, whilst on the roof climbers are to be trained.

The orchard-house entrance from Prince Albert's Road was erected by Mr. Ormson, of Stanley Bridge, Chelsea; and that from the Exhibition Road by Messrs. Smith & Co., of South Street, Grosvenor Square.

I CAME to town on Tuesday last purposely to see the great attraction that the Council had prepared for the Fellows of the Royal Horticultural, and with the expectation of having my ideas greatly enlarged on the metropolitan modes of making bouquets, decorating dinner-tables, and the floral adorning of churches. I am no great advocate for the last of these, but still I thought I might see something that would have, at least, gratified the senses if it did not excite the religious feeling. To say that I was

disappointed would be to use a term infinitely short of the feeling it is intended to express. I had come a great way, and disgust rather than disappointment is the more correct term to make use of to express the feeling that the whole affair created. The bouquets, of which there were not more than half a dozen, appeared to have come from Covent Garden, where visitors to London may see them in greater profusion and variety any day of the year. The dinner-table decorations were a poor attempt at what I had seen more fully carried out at previous exhibitions of the Society, and were altogether a complete failure, besides their being few in number and meagre in design. The church decorations must have excited a smile from all country visitors to see such poor imitations of what we are so much accustomed to find at all our village-school festivals. The "Easter Cross" of 18 inches high, made of white Pinks tied over a framework of wood, was not a very great effort at "decoration," and far less so was the emblem of the Holy Trinity, composed of three incorporated circles made severally of red *Pelargoniums*, *Gueldrés* *Roses*, and *Laburnum* flowers, stitched first on brown paper, and that tacked on a piece of board! As to the "swags," I looked for them in vain, and when I inquired after them nobody seemed to understand what I was talking about.

Had it not been for the counter of glass ornaments sent by Dobson & Pearce, and which I was told were ornamented with flowers sent from Chiswick Garden, and the Fern cases of Messrs. Barr & Sugden, which you may see any day at their shop in King Street when you go to look at the bouquets in Covent Garden, there would have been but a sad exhibition. It was sad enough as it was.—J. E. M.

THE ROYAL BOTANIC SOCIETY'S SHOW.

MAY 21ST.

(Concluded from page 377.)

AZALEAS.—The magnificently-bloomed specimens from Messrs. Veitch and Mr. Turner, of Slough, have been already noticed. The towering pyramids with which Messrs. Veitch took the first prize in the Nurserymen's Class for eight, were perfection in their style of growth. They consisted of *Extranei* and *Trotteriana*, violet rose; *Chelsoni* and *Perryana*, orange scarlet; *Criterion*; *Carnea superba*; *Magnifica*, and *Iveryana*, white. Mr. Turner, who was second, had plants which, though not so large as Messrs. Veitch's, were also of great size and in splendid bloom. The kinds were—*Perryana*; *Glory of Sunninghill*; *Murrayana*, rose; *Optima*, dark orange scarlet; *Arborea purpurea*; *Alba magna*; and *Variiegata*. Excellent plants were also shown in the same class by Mr. Fraser and Mr. Rhodes.

In sixes, Messrs. Veitch were again first with plants nearly if not quite equal to those already referred to, and which being placed along with Mr. Turner's fine collection of six in the centre of the large tent, were conspicuous from every point of view. They consisted of *Herberti*, white; *Criterion*; *Broughtoni*; *Standard of Perfection*, bright rose; *Barclayana*, white flaked with violet rose; and *Trotteriana*; while Mr. Turner's, which took the second prize, were *Criterion*, *Empress Eugénie*, *Gem*, *Gledstanesi*, *Perryana*, and *Conqueror*. Prizes were also awarded to Messrs. Lane and Fraser.

In the Amateurs' Class for eight, Mr. Carson, gardener to W. R. G. Farmer, Esq., Nonsuch Park, was first with the yellow *Sinensis*, of which we have never seen a finer specimen; *Broughtoni*, also very fine; *Rubra plena*; *Formosa*; *Murrayana*; *Triumphant*, and others. Mr. Melluish, gardener to J. Chaffin, Esq., Grosvenor, Bath, was second; and Mr. Page third. In sixes, fine exhibitions came from Mr. Green and Mr. Penny.

CAPE HEATHS were as fine as usual, but exhibited no novelty. Several fine plants of the *ventricosa* varieties were shown, and among the others we noticed fine specimens of *Alberti major*, buff; *Spenceri*, *tortulaeflora*, and *eximia superba*. Messrs. Jackson, Mr. Rhodes, and Mr. Baxendine took prizes for collections of ten; Mr. Peed and Mr. Page for eights; Messrs. Chilman, May, and Wheeler for sixes.

ROSES in pots were remarkably fine, particularly those from Mr. W. Paul, who took the first prize for ten. These were in splendid condition, the plants more especially notice-

able being Louise Odier, Général Jacqueminot, Comtesse de Chabillant, Charles Lawson, Baronne Prevost, Coupe d'Hébé, Teas President, Souvenir d'un Ami, and Souvenir d'Elise Vardon.

Messrs. Lane, who were second, had finely-bloomed specimens of Madame Willermoz, Souvenir d'un Ami, Jules Margottin, Charles Lawson, and Chénédolé. Messrs. Paul and Son, who ran Messrs. Lane very closely, were placed third. Gloire de Dijon, Paul Ricaut, Madame de St. Joseph, Madame Julie Daran, and Niphetos, were conspicuous in this collection. In the Amateurs' Class, Mr. Terry had a first prize; Mr. Cross a third, for exhibitions a long way behind those above noticed. Cut blooms were shown in great perfection by Mr. W. Paul and Messrs. Paul & Son, the former having eight, and the latter eleven boxes.

PELARGONIUMS.—Plants of extraordinary size and beauty were shown by Mr. Fraser, of Lea Bridge, and Mr. Turner, of Slough, in the Nurserymen's Class; and by Mr. Bailey, of Shardeloes, in that for Amateurs, some being not less than 4 feet across, whilst the Fancies were upwards of a yard, and this, withal, in eight-inch pots. Messrs. Fraser took the first prize in twelves with Empress Eugénie, Beadsman, Festus, Leviathan, Osiris, Desdemona, Sanspareil, Etna, Fañest of the Fair, Sir Colin Campbell, Rose Celestial, and Peacock. Mr. Turner, besides kinds above named, had Guillaume Severyns, Nestor, Viola, Lord Clyde, and Bertie, richly spotted rose. In tens, Mr. Bailey was first with splendid plants of Etna, very glowing scarlet and maroon; Sir C. Campbell; Rose Celestial; The Belle, very beautiful, white and carmine; Monarch, Lord Clyde, Ariel, Sanspareil, and Floribunda. Mr. Nye was second with some excellent plants, and Mr. Weir fourth.

The Fancies were, as usual, very beautiful, both in the Nurserymen's and Amateurs' Classes. In the former Mr. Turner and Mr. Fraser stood first and second; in the latter Mr. Bailey and Mr. Weir had first and third prizes. Among the varieties shown were Acme, Lady Craven, Ellen Beck, Roi des Fantaisies, Delicatum, Modestum, Clara Novello, Crystal Beauty, Clemanthe, Crimson Pet, and Carminatum.

NEW PLANTS were shown in considerable number, but the most of those which were remarkable having been submitted to the Floral Committee on the 17th inst., to save repetition we will refer our readers to the report of that meeting at pages 377 and 378. *Ornithogalum thyrsoides*, *Agave schidigera*, *Raphiolepis ovata*, *Coleus marmoratus*, *Dieffenbachias Baraquimiana* and *grandis*, and *Cordylina Banksii*, were again exhibited; also, *Dracæna Cooperi*, Messrs. Veitch's new *Genethyllis* and variegated-leaved *Camellia*, Mr. Bull's variegated Pampas Grass, and several varieties of *Aucuba*, with leaves variegated in different ways. One called *limbata* or *aureo-marginata*, was very handsome, having broad, well-defined marking. Messrs. E. G. Henderson & Co., Wellington Nursery, had first-class certificates for *Sedum Sieboldi medio-variegatum*, the leaves having a yellow centre; for *Aubrietia Hendersoni*, a handsome rock plant of dwarf, compact, free-flowering habit, with violet purple flowers; and for a pretty variegated Saxifrage, having the leaves rose-coloured, with a small green centre. A pretty variegated *Acer*, the leaves much cut, yellow, red, and green, also attracted attention. *Stuartia grandiflora*, a hardy Japanese shrub with large white flowers and yellow centre, came from Mr. Standish; and a new double scarlet Thorn from Messrs. Paul & Son, with very double and bright red blossoms, appeared to be a desirable variety. In addition to the above, *Pitcairnea tabulaformis* from Mr. Bull, with leaves lying flat on the soil in the pot, and orange flowers, came from Mr. Bull; also, *Massonia cannaefolia*, with a white spadix and spathe. *Anthurium Scherzerianum*, with its beautiful bright red spathe; and the striped New Zealand Flax, were also shown.

Among seedlings, Mr. Noble, of Bagshot, had *Rhododendron The Queen*, having large trusses of white flowers, and decidedly of great merit, apart from which it is said to possess the desirable properties of hardness and lateness. Among seedling *Pelargoniums*, *Reubens*, from Mr. Nye, a brilliant scarlet, shaded with violet crimson at the eye, was very striking, and received a first-class certificate; and a similar award was made for *Edgar* (Turner), *John Hoyle* (Hoyle), *Cicero*, from Mr. Nye, and *Commander* from Mr. Wiggins.

MISCELLANEOUS.—Several stands of Pansies in good condition were shown by Messrs. Downie; Hooper; Watson, Dunse; Hawse, Slough; Wyness, and James. Seedling *Calceolarias* came from Messrs. Dobson & Sons: among them we noticed *Incomparable*, a brilliant crimson scarlet, and *Prince of Wales*, buff spotted with crimson. Also, from Mr. James, *Isleworth*, who had among others, *Conqueror*, a good crimson scarlet on a yellow ground; *Cluster*, very large, crimson spotted on buff ground; and Mr. Eyles, clear yellow. Mr. Williams contributed a fine collection of *Agaves*, *Yuccas*, *Dracænas*, and *Cordylines*; Mr. Young some fine pans of *Lycopods*, and a small collection of exotic Ferns; Mr. Fraser, *Lea Bridge*, a group of new *Azaleas*; Messrs. Lane & Sons, cut *Rhododendrons*; *Treen*, *Verbenas*; Mr. Bull, new and rare plants; Mr. Turner, *Bougainvillæa*; Messrs. A. Henderson & Co., plant baskets, &c.; and Messrs. Barr & Sugden, neatly-filled plant cases of various forms. For most of the above objects awards were made to the exhibitors. Messrs. Backhouse, of York, sent a terra-cotta basket of alpine plants, which were originally arranged among moss and stones to imitate rockwork, but unfortunately the whole got mixed together, owing to rough treatment in carriage, and some of the plants were much damaged, and had to be removed. Among those left were *Gentiana bavarica*, a lovely deep blue, and for which a certificate was awarded; *Myosotis alpicola*, an alpine Forget-me-not; *Primula farinosa*, a very fine plant with pink flowers; the free-flowering orange and lilac *Linaria alpina*, and *Goodyera pubescens*, a hardy North American Orchid.

We may just add that Mr. John Waterer's show of American plants gave promise of being very fine, and that in another week they will probably be in perfection.

FURZE VERSUS GOOSEBERRY CATERPILLARS.

FOR the last three years my garden has been greatly infested with caterpillars. Ten days ago I inserted pieces of Furze in the centre of the usually-attacked Gooseberry bushes, in the hope that they would prevent or cure, but they have done neither. Eggs have been laid in abundance. Hundreds have been hatched, and numerous larvae very near to the Furze have been perforated by the larvæ.

One particular has, however, attracted my attention— that is, two-thirds of the caterpillar eggs have proved abortive, and changed from a pure clean white to a dirty brown. Has the Furze influenced the eggs? I think not; but I believe the east winds and the frosty nights have done so to a very great extent.—R. S.

HARMONY OF COLOUR AS APPLICABLE TO FLOWER GARDENING.

THE following paper on the above subject by Mr. Crittenden, an artist by profession, but at the same time an ardent admirer of horticulture, and a very able and efficient member of the Maidstone Gardeners' Mutual Improvement Association, was read by him at a public meeting of that body, held on the 11th of March at the Corn Exchange, Maidstone, before an audience of upwards of a thousand people, the Mayor of the town presiding.

After a few introductory observations, Mr. Crittenden said:—

"Harmony of colour is too great a subject to be thoroughly discussed in all its theories and intricacies in so short a paper as I propose to inflict upon you this evening. There are many reasons why I should not dive into abstruse theories—such as want of time, their non-applicability to garden decoration, and, not the least of them, my own inability to grasp so vast a subject in all its scientific bearings and details: therefore those of our friends who are not gardeners will, I trust, pardon me if I only treat of that part of the subject which may, perhaps, be instructive and useful to those who are bearing this in mind, that the primary object of this Association is mutual improvement and instruction. If it be said I am not a gardener, and cannot, therefore, impart to those who are any instruction in the art of growing either Cauliflowers or *Calceolarias*, and that I scarcely know one from the other, I own to the soft impeachment,

and plead guilty. But gardening, like everything else, cannot stand still, and to the art of raising and cultivating flowers ought to be added—I say it again—ought to be added a knowledge of their best and most harmonious arrangement as to colour. If, therefore, I can in my small way only assist you to acquire a portion of that knowledge, I trust I shall have established a claim, if not to be a gardener, at least a gardener's friend, and in that capacity I beg to offer a few remarks about colour. I wish to state, also, at the outset that I shall avoid technicalities as much as possible, and say what I have to say in a popular rather than a scientific manner. Of course a gardener's concern with a knowledge of colours will be brought more into play in the bedding-out of his plants than in any other way, though it will be found to be of use to him in the conservatory or greenhouse. I hope you do not expect that I am going to teach you harmony of colour all at once to-night in one lesson. I only hope to be able to get in the thin end of the wedge, and to send you home with a few cuttings from the tree of colour, which you will carefully plant deep in your craniums; and as it is a hardy plant, and grows fast when it has once taken root, and assumes many varieties, I hope when we next meet on such an occasion as this that I may be thrown aside like an old Geranium, and your next year's cuttings may be taken from those now about to be planted, so that you may be able not only to keep up and improve your own stock of knowledge of colour but give to your neighbours. A gardener's palette is very different from a painter's palette of colours: hence, perhaps, my inability may be shown in trying to deal with it in a practical way; but I trust you all understand that there are many practical difficulties with which I must leave you to deal yourselves. If a painter wishes, in painting a picture, to make a purple he takes blue and mixes a portion of red with it to his fancy or requirements. If he wants a particular tint of any description he can get it by mixing; but if a gardener requires to plant a bed with orange flowers he would be thought to be rather a-head in his knowledge of colour if he took a couple of dozen scarlet Geraniums and a half-dozen Sun-flowers and smashed them up together for his orange: therefore you will see if his range of colour is not a very limited one, it is certainly an arbitrary one; and though, now and then, a new colour appears, he is bothered with the size and habit of the plant, and does not see clearly how to form a nice bed with Dahlias and Verbenas. All this only goes to show that the gardener's colours are not like the painter's, but are beset with arbitrary conditions.

"Hayter says, 'It is worthy of consideration that inasmuch as a gamut is not any distinct tune of itself, so a chromatic display of the formation of colours is not any distinguishable picture. Yet so perfectly do each develop that systematical order by which nature has determined harmony, that without them painting [planting], with regard to colours, as well as music with regard to sounds, would remain to all as they still do to all those who are unacquainted with them.' Luckily the gardener is not called upon to paint pictures, either landscape or portrait, but he is called upon to display his plants and flowers to the best advantage, and in conformity with the natural laws of harmony and contrast of colour. The comparison between music, or sound, and colour, which I have just quoted from Hayter, might be carried still farther. A composer will write his music in keys, B flat or C sharp, as the case may be. So can a gardener or a painter arrange his colours in a cold, cool, neutral, warm, or fiery key. It is said some persons have an ear for music. I believe it; some appreciate sweet sounds more than others. But it may equally be said that some have an eye for colour. Then, as there are natural laws of harmony, does it not behove the gardener, though I do not believe there is one who has not a good eye for colour, to become acquainted with those laws, so that he may not bewilder the optics of those that have? Harmonious contrast of colour does not by any means involve the necessity of strong opposition of light and dark colours, though this may occasionally occur. The contrast of white and black is of course the strongest that we can get, and represents the extreme of contrast without reference to colour, but only as to lightness and darkness. As neither black nor white are colours their use infringes no law of harmony of colour, and they are only to be viewed as con-

trasts of light and dark; but the proper and harmonious contrast of any particular colour with another is its opposite; or, as it is termed, its complementary colour—a method of ascertaining which I will explain to you in as simple a manner as I can. Do not forget that black, white, and their mixtures neutral, can always be used without offence to harmonious propriety with any colour whatever, always recollecting their service in contrast is only as to lightness and darkness. They pay no compliments to any one colour more than another, neither do they quarrel with any colour, but uphold the doctrine of non-intervention, and have concluded a treaty of peace with all.

"I will now explain the origin of colour in a slight way, the number of primary, secondary, and tertiary colours, their harmonious contrasts, &c.; but if any gardener should say to me, We have not a true blue, or, We want a pure white or black, and have not got them, I can only say to them, Approximate as nearly as you can with the arbitrary conditions you are hampered with. We all know, that however good the colour of the blossom, its general appearance is modified, to a very great extent, by the foliage when viewed in bulk. This will simply prevent your making the colours of your beds pure scarlet, pure blue, or yellow, but will not alter the laws of harmony of colour, which apply to secondary, tertiary, and all shades of colours alike. It would be altogether beyond my purpose to-night to go into a scientific analysis of the division of the rays of light as exemplified by the spectrum, and also by the rainbow. You all know that if a ray of light be intercepted and divided by a cut glass prism, all the beautiful colours of the rainbow can be thrown on a screen or a sheet of paper. Now, no one will attempt to deny that these are the true natural colours of which light is composed; and if we base our calculations on these, and succeed in proving an assertion that the division of light will produce all the natural colours, we need not go much further to find a foundation on which to build our laws of colour. I think Sir Isaac Newton's rainbow gives seven colours—red, orange, yellow, green, blue, dark blue, violet. But these for our purpose are better reduced to three only; for it is clearly proved that there are in reality but three colours, the others being produced by the mixture of the one overlapping the other—as for instance, the yellow blending with the red on one side gives orange, and with the blue on the other side gives green, and so on.

"To start, then, we will boldly make the assertion at once and say there are but three colours—blue, red, and yellow. It is important that you should remember this, and I will, therefore, repeat, that there are but three primary or original natural colours—namely, blue, red, and yellow.

"Neither of these three colours can be produced by any mixture whatever of other colours, and yet they—that is, blue, red, and yellow, contain the sole properties of producing all other colours whatsoever by mixtures entirely among themselves, without the aid of a fourth. Now, this is a great fact; and in order to prove and illustrate in a homely way without going to the optician, that these three primary colours contain all the coloured properties of a divided, analysed, broken up, or, plainly speaking, a smashed ray of light, we have only to collect the fragments together in the proper proportion to bring them to light again, and thus prove our position, as we did at school our multiplication by division. The component parts are 8, 5, and 3; 8 of blue, 5 red, and 3 of yellow. Take a circle of card and colour it thus—half blue, and the remaining half five parts red and three yellow, put it on a pivot, and with great rapidity of motion it will lose its colour, and the white of the card only be left. This is only a rough experiment, but it is sufficient to demonstrate our position.

"We gardeners now want a few plain rules for harmony of contrasts, for which purpose we will just go through the colours and find out where they are friendly, and how and why they quarrel, and agree. And, first, we will take the three primary colours and find the proper and harmonious contrast to each of them; and that will give us the three secondary colours, whose harmonious contrasts will be found in the same way; and that will give us the three tertiary colours or tints, and the same rule will hold good *ad infinitum*. Blue, red, and yellow. Take blue first, its complementary or contrast is orange, which is a combination of the

other two, red and yellow. Take red, its complementary colour or contrast is green, which is a combination of the remaining two, blue and yellow. Take yellow, its complementary or contrast is purple, which is a combination of the two left—namely, of red and blue. Now, this is simple, and is easily remembered, and ought to be well remembered, because the same rule applies through the secondary colours, and so on. You have three primary colours, and the colour that harmonises with and delights to show either of them off to the best advantage is the colour produced by the mixture of the remaining two.

"We have now come to the secondary colours produced by the mixture of any two primaries, and they are, as you see, orange, green, and purple. It would be but a repetition of what I have said before, to show how each of these secondary colours would provide a complementary contrast to a still lower scale of colours formed by the remaining two combined; but, perhaps, I had better say that the three tertiary colours would stand thus—orange and green would make olive, whose foil or opposite would be purple; purple and orange would make brown, whose contrast would be green; green and purple would make slate, whose opposite in the secondaries would be orange. It would be absolutely impossible in this short paper to enumerate the infinite variety of shades of colours, and the colours best adapted to act as harmonious contrasts to them. The rule I have laid down for your guidance is simple and clear. I have given you the first nine most distinct varieties of colour in three grades of three each, the mixtures of any two of the first forming the second, and of the second the third, and they stand thus—

"*Primaries*.—Blue, red, and yellow.

"*Secondaries*.—Orange, green, and purple.

"*Tertiaries*.—Slate, brown, and olive.

"Now, all that I have said is assuming the blue, red, and yellow to be pure and true, and the pure and true primary is that part of the coloured spectrum that is the centre of its colour, for it becomes modified, as I have shown you, by approaching the next colour in the rainbow or spectrum: thus, the red changes from scarlet to orange as it approaches the yellow, and from scarlet to crimson as it approaches the blue. The same with the blue; it changes from blue to purple or violet as it approaches the red, and green as it approaches the yellow, and so on. Thus under the simple denomination of red, for instance, may be included everything from the end of orange to the end of crimson. Then there is light red and dark red, and included must be the pink and rose colour, which are simply mixtures of the varieties of reds, with white more or less, and not with colour. The true red is that nice point between scarlet and crimson, for the scarlet is a red leaning to the yellow, and the crimson is a red leaning to the blue. What I have said of the red may also be said of the blue and the yellow. So, besides what I stated of the mixtures of the primaries proper, we have the infinite variety of colours, shades, and tints of the mixtures of the modifications of these primary colours; and if any of you know how many thousand changes may be rung upon a peal of eight bells, you may begin to have a faint notion of how infinite must be the possibility of changing these varieties of tints.

"But the rule of harmony for contrast that I have laid down for the primary colours is modified as easily to suit all cases as possible. Orange complements blue, and yellow complements purple. So a modification of this rule would be this—the deeper the blue the paler the yellow, and so on with the other colours. I do not see how I can make it more simple than this. In fact, perhaps I have said too much, and made it appear more complicated than it is by going into these modifications of positive colour; but one word more, and then it will be clear, I think. All departure from the true red, blue, or yellow, in either colour, must lean to one or other of the others, and in that case its own true contrast must also lean to the contrast of the colour it favours. But you cannot expect in gardening to be able to do what an artist can with paints. I only wish to give you a rule to go by that you may follow as well as conditions will allow you; and that is a very great deal, for an approach to the true harmony of contrast in your arrangement of bedding plants is as much as you can expect in some cases.

"I will now inquire what is discord, since we have been so harmonious. Red and orange, that is discord; red and purple, not much better; yellow and orange, queer; yellow and green, bad, but not the worst; blue and purple, great discord, perhaps not to be wondered at; blue and green, this is dreadful. Now, in this list, I have taken the three primaries with secondaries. Theoretically one is as bad as the other, though some, I think, are more calculated than others to make work for the Ophthalmic Institution. Fancy a lady's blue bonnet with green ribbons—it makes one blink to think of it. Now, I gave you a rule of harmony for the primaries. Now for the rule of discord. Why does not blue contrast well with green? because blue is a component part of green. This rule, then, is the converse of the other for harmony of contrast, and proves both cases. Therefore it resolves itself into this, that the proper complementary or contrasting colour to any primary or other colour, has none of that primary or other colour in its composition. I might say the same thing over again, repeatedly, in other words, but it would only occupy valuable time. Harmony of colour is a most delightful study, and beyond its peculiar application to the gardener's calling or craft, it leads us into a higher path, and opens to our view an endless series of those wondrous beauties of Nature created by the Great Architect of the universe, who has given us light, the source of colour, and endowed us with vision. What further inducement need we, then, to enter upon the study of a subject of which the further pursuit only reveals more wonders, imparts more knowledge, and at every step gives us greater cause for thankfulness?"

PORTRAITS OF PLANTS, FLOWERS, AND FRUITS.

ALSTROEMERIA CALDASII (Caldas's *Alstroemeria*).—*Nat. ord.*, Amaryllidaceæ. *Linn.*, Hexandria Monogynia. Native of the Andes near Quito. Probably hardy if bulbs are planted deep. Imported by Messrs. Veitch. Flowers orange, spotted with crimson.—(*Botanical Mag.*, t. 5442.)

WAITZIA CORYMBOSA (Corymbose *Waitzia*).—*Nat. ord.*, Compositæ. *Linn.*, Syngenesia superflua. A very beautiful native of Swan River, raised by Mr. Thompson, of Ipswich. Probably an annual. Produced in open ground three coloured flowers—white, rose, and yellow—the disk in all being deep yellow. Probably a valuable bedding-out plant.—(*Ibid.*, t. 5443.)

DENDROBIUM BARBATULUM (Bearded-lipped *Dendrobium*).—*Nat. ord.*, Orchidaceæ. *Linn.*, Gynandria Monandria. Native of Moulmein, introduced by Messrs. Low, Clapton Nursery. Bloomed in January. Flowers white, tinged with purple at the base. Should be grown on a block of wood, and requires a decided season of rest.—(*Ibid.*, t. 5444.)

ECHINOACTIS SCOPA (Broom *Echinocactus*).—*Nat. ord.*, Cactaceæ. *Linn.*, Icosandria Polygynia. Native of Brazil. When full grown more than a foot high, and quite club-shaped. Flowers lemon-coloured, with purple radiating centre.—(*Ibid.*, t. 5445.)

DENDROBIUM INFUNDIBULUM (Funnel-lipped *Dendrobium*).—*Nat. ord.*, Orchidaceæ. *Linn.*, Gynandria Monandria. Native of Moulmein mountains, at an elevation of 5000 feet. Imported by Messrs. Low, and called *D. moulmeinense*. Flowers white, with lip yellow-blotched.—(*Ibid.*, t. 5446.)

AZALEA FORGET-ME-NOT (Ivery's).—Raised by Mr. Ivery, of Dorking. Flowers purplish crimson.—(*Floral Mag.*, pl. 193.)

HYACINTH ROBERT FORTUNE.—Exhibited by Messrs. Cutbush, Highgate. Colour quite new, and difficult to describe; dark puce in centre of each segment, softening to nearly white at the edges.—(*Ibid.*, pl. 194.)

ITALIAN VERBENAS.—Originated by Messrs. Carvagnini, at Brescia. Their peculiarity is having the corolla striped and splashed irregularly. *Pallavicini di Brescia*, white, splashed with crimson. *Conte Bernardino Lecchi*, white, striped with purplish crimson. *Caroline Carvagnini*, white, striped with deep rose.—(*Ibid.*, pl. 195.)

CAMELLIA CONTE DE GOMER.—Raised in Italy, by Conte Bernardino Lecchi, a well-known horticulturist of Brescia. Beautiful rose colour, striped broadly, and dotted with dark crimson.—(*Ibid.*, pl. 196.)

BOMAREA MULTIFLORA (Many-flowered Bomarea).—*Nat. ord.*, Amaryllidaceae. *Linn.*, Hexandria Monogynia. "It is scarcely possible to conceive a more beautiful object than this, with its clusters of richly-coloured blossoms (orange,

spotted and tinged with crimson), gracefully hanging from its climbing stems." Introduced from the Quito Andes (?) by Messrs. Veitch, who state that it may be treated as a greenhouse perennial.—(*Florist and Pomologist*, iii., 97.)

PICTURESQUE GARDEN PLANS.*

THERE has recently been published by M. R. Siebeck, Superintendent of the Public Gardens at Vienna, a work on this subject, and the plans and descriptions are so useful that a translation of the work, and the whole adapted to

our requirements in England, has been re-issued by Mr. Newton. We recommend it to such of our readers as need suggestions in arranging their gardens and grounds.

The volume is formed of twenty-four coloured folding

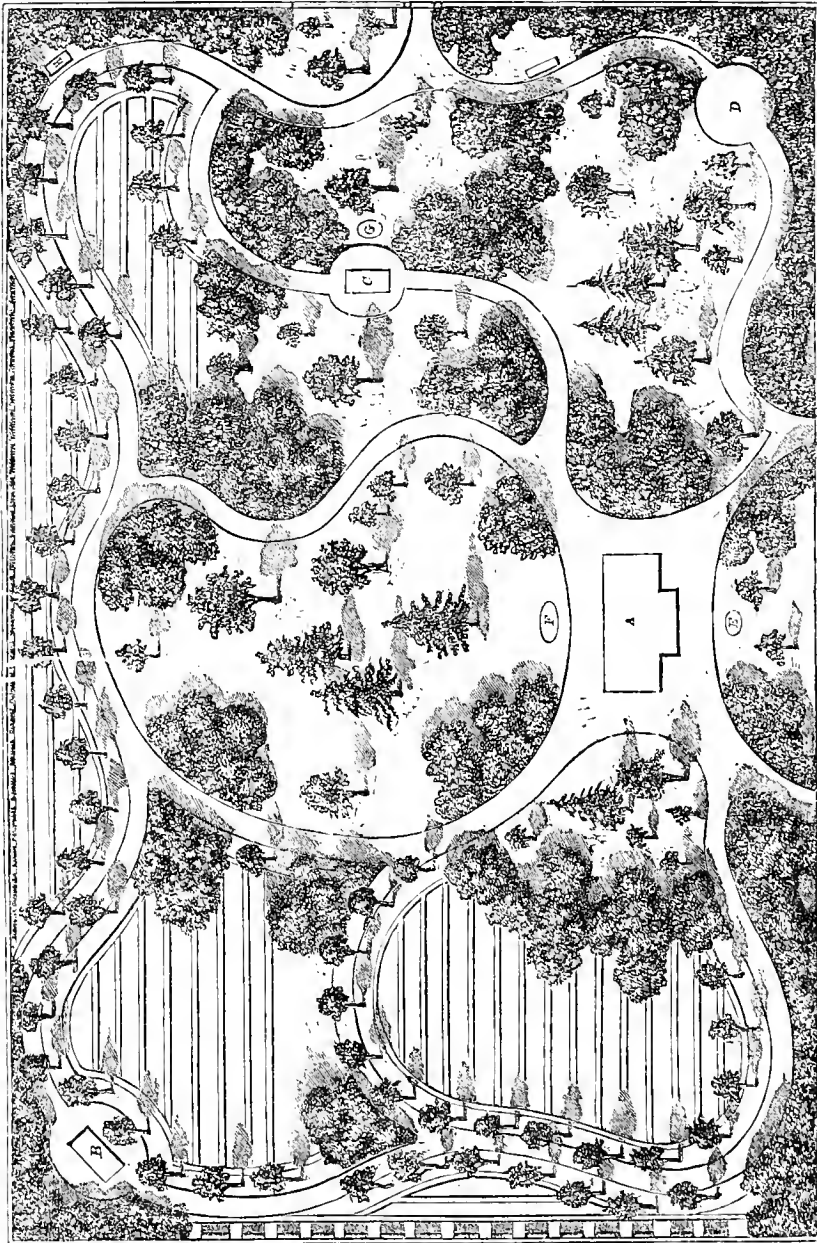

SCALE OF FEET.

The single rows of fruit trees; the borders on which they are planted may also be advantageously ornamented with herbaceous plants.
The lined quarters are the vegetable department.

Seats at the curves command various views of the summer-house and grounds.
The whole is enclosed by walls for fruit trees.

B Is the gardener's lodge.
C A summer-house.
D A round spot surrounded by shrubbery.
E, F, G Are flower-beds.

plates of a large size, and the best idea we can give of its utility is to publish a reduced copy of one of the plates with some of the references. We can only give some of the references, because in the large original drawings they are very numerous, and detail the kinds of trees and shrubs planted in the places referred to.

In this plan the ornamental ground is bounded on two

sides by the kitchen garden; and the house (A) is situated so as to be out of view, or nearly so, of the latter, the principal prospect being on the garden side.

* *Picturesque Garden Plans. A Practical Guide to the Laying-out, Ornamentation, and Arrangement of Villa Gardens, Town Squares, and Open Spaces from a Quarter of an Acre to Four Acres.* By R. SIEBECK. &c. Adapted, &c., by J. NEWTON, F.R.H.S. Twenty-four Coloured Plates, London: R. Hardwicke.

BEAUTY OF WALTHAM ROSE.

ALTHOUGH you have wisely said that this controversy had better cease, yet, as I have been appealed to by Mr. W. Paul, I must claim a few lines in reply. The case is this—Mr. Paul, in order to give piquancy to my statement about his Rose, asserted firstly that I never could praise anything of his; and secondly that I had pronounced his Rose undistinguishable from Madame C. Crapelet, and asks me to retract because I have explained my meaning. I have nothing to retract.

In answer to his first assertion I gave a long list of extracts from my reports of last year, to show that I did praise his productions, and to that, occupying three-fourths of my letter, he never gave one word of reply. As to the second, if he argues "*a particulare ad universale*" I cannot help it. I maintained that on the 9th and 30th of April the blooms then exhibited were undistinguishable from Madame C. Crapelet, and I say so still. He separated my words from their context, on which principle one may be made to say anything. As to those who have gone much further than I did, I must leave Mr. Paul to settle his account with them.—D., Deal.

[Here the controversy must cease. Let the Roses be exhibited side by side, and then every one will judge for themselves.]

MR. WARNER'S ORCHIDS.

THE other day we had the pleasure of visiting Mr. Robert Warner at Broomfield, near Chelmsford, and of seeing his magnificent collection of Orchids, which we believe is one of the richest and most valuable in this country. On entering that which is appropriately called the Vanda-house we were struck with the number and beauty of the plants. Here were forty-nine great plants of *Vanda suavis* and tricolor with their varieties, some of them 5 or 6 feet high, and in some instances three plants in enormous pots. Only a few of these of course are now in bloom; but still there were one or two very beautiful plants of what Mr. Warner calls his own variety, which is finely marked. Besides these *Vandas* we counted no less than 43 specimens of *Arides*; 65 of *Phalænopsis*, among which are many plants of *amabilis*, *Schilleriana*, and *grandiflora*; 50 *Cœlogyne cristata*, all in fine health; and besides these there were upwards of 100 *Arides* and *Saccolabiums* hanging from the rafters of the house. Here we also observed a splendid specimen of *Dendrobium fimbriatum oculatum*, and the lovely *Phalænopsis intermedia Portii*, which is somewhat in the way of roseum. In the great *Cattleya*-house, 53 feet long, were numerous fine plants of *Cattleya elegans*, *Leopoldi*, and *Warneri*, *Lælia gigantea*, *purpurata*, *crispa superba*, and *Lawrenciana*.

But the greatest treat of all was "the Show-house;" and here Mr. Warner had concentrated such a blaze of beauty as would of itself have constituted a flower show. When we state that besides the other plants in bloom there were thirty-one great specimens of *Cattleya Mossiae* of unusual brilliancy of colour, it will give some idea of the effect. This variety of *Cattleya Mossiae* that Mr. Warner grows is peculiar to himself, and we believe it was obtained from a large importation of this species that Mr. Warner introduced himself some years ago. In colour it far exceeds in richness and brilliancy any other variety we have seen; and what adds still more to the interest is, that there are scarcely two of them alike in their shades and markings. Besides these there were large specimens of the following:—*Phalænopsis amabilis* and *grandiflora*; *Oncidium papilio* and *sphaacelatum majus*; *Dendrobium chrysotoxum* just coming into bloom, a large and handsome specimen; *Dendrobium tortile*, a pretty and interesting plant with twisted sepals and petals, and a fine specimen; *Lælia purpurata*, with ten spikes, and bearing thirty flowers, each 8 inches across; *Odontoglossum citrosamum*, showing seven spikes of bloom upon it; *Anguloa Ruckeri* with three fine spikes; and a fine large specimen of *Trichopilia tortilis*. But these are only the most prominent subjects, for there were others innumerable which lost their attractions among their more showy neighbours, and but for which they would themselves have made a very creditable appearance.

We then entered the "cool Orchid-house;" and when we

state that this is a vinery with a capital crop of Black Ham-burghs overhead, as yet as green as bullaces, and not more than half their size, gradually undergoing the developing process till the season of maturity arrives, and with no other heat than the sun affords, our readers will be able to form an opinion as to Mr. Warner's notion of a cool Orchid-house. In fact, the house never has any artificial heat at all, except in winter, and then only enough to keep out frost; the temperature never being allowed to sink below 40°. For five years Mr. Warner has followed this system with the most perfect success in the cultivation of *Lycastes*, *Odontoglossums*, *Pleiones*, *Cœlogyne*, *Arpophyllums*, *Anguloas*, *Cypripediums*, and for the last three years he has had a finer show of bloom than can be seen anywhere else. As a proof of the luxuriance with which they grow in this way we measured leaves of *Lycaste Skinneri* upwards of a yard long, and on one plant of the same species there had been no less than thirty blooms. A plant of *Odontoglossum nævium* had been completely broken up, and Mr. Warner was fearful he should have lost it entirely, but every portion of it has recovered in this vinery, and is now making pseudo-bulbs.

After such success for so many years as Mr. Warner has been following this practice we must regard him as the pioneer of cool-Orchid-growing, and we must acknowledge the result of his system of cultivation under Vines is an evidence of the soundness of his views on this subject. Mr. Warner strongly objects to growing these plants in pits with a northern aspect; "for," as he justly observes, "what is the use of growing them so when they will do far better in a vinery where you can always see and admire them?" These should be called "vinery-Orchids."

At the extremity of the range of houses is a captivating little fernery, with an aquarium in the centre, and here are some fine specimens of such plants as *Dicksonia antarctica*, a noble plant of *Adiantum cuneatum*, and numerous others, all creating a beautiful effect, and as if enticing you to be seated on the adjoining large couch there to sit and ruminate on their beauties.

STRAWBERRY PLANTS GOING BLIND.

COULD you assign any reason for my Strawberry plants having gone blind this year? My stock consists of Trollope's *Victoria*. I took runners as usual last summer, put them in small pots, potted them in due time into 32-sized pots, kept them well watered until about November; then, instead of keeping them covered up out of doors as usual, I put them on a dry bottom in an old vinery. They had no water during the winter, and the house was never closed night or day until the plants were taken out about the 20th of February. They were then placed on shelves in greenhouses, and watered when necessary. No fire was used except to keep out frost. They grew very gradually, and were healthy and strong; but, to my sorrow, I find I have not two dozen fruiting plants out of six hundred.—J. R. S.

[Yours is certainly a bad case. We have no doubt that if fruit-buds were formed they suffered from frost and dryness in winter. You would find suitable notes some time ago in "Doings of the Last Week."]

SUMMER PRUNING FRUIT TREES.

MY gardener and I differ as to the object of summer-pruning or finger-pruning, and as to the time when it should be performed, and I appeal to you for information on these points. My theory is, that by preventing the formation of leaves, and so checking the vigour of a fruit tree, the tendency to form wood in place of fruit-buds is diminished; and accordingly that pinching should be commenced as soon as the young shoots show four or five developed leaves, and should be continued as long as such shoots are produced.

My gardener, on the other hand, says that the secondary shoots which are produced from the terminal bud after pinching are of no use, that fruit-buds are formed only on the primary shoot, and that the object of summer pruning is to concentrate the sap at the ripening period in the lower buds, and prevent its waste in that part of the shoot which must at all events be removed at the winter pruning. He

therefore breaks off the upper part of the shoot towards the close of summer; and if any secondary shoot should then start it does not ripen, and is pruned off with other dead snags in winter.

My impression is that Mr. Rivers's practice accords with my theory; but if so, I should like to know whether secondary or tertiary shoots become fruit-bearers with him. Is it possible that these may ripen in Hertfordshire and yet not do so in the north of Scotland? If this is the case it would account for the difference between my gardener's practice and my theory.—MONTICOLA.

["MONTICOLA" and his gardener are both right according to circumstances. For instance, here is a Peach or a Cherry tree in a pot which we wish to be compact-headed, and we nip the shoots as "MONTICOLA" proposes, and keep on nipping, satisfied if the first and some of the secondary shoots are fruitful next season. Here are similar trees on walls, young and vigorous, out of doors, and which we wish to fill the wall soon. We would stop them little until after Midsummer. In such trees as the Peach and the Morello Cherry out of doors, that bear freely on last year's wood, we would stop an extra strong shoot as early as "MONTICOLA," to get several bearing twigs instead of one too vigorous to bear at all; but were we to do this generally when a tree was vigorous, we should expect the most of the buds below to break into wood shoots, and therefore we would have to depend on secondary shoots instead of primary ones for fruit, whilst we would rather depend on the latter. If a tree is of very moderate growth and is all pinched in, there is more likelihood that the point-buds will start into, and the buds farther back will be matured into fruit-buds. The stopping system is chiefly applicable to small standards or pyramidal trees, or to those on trellises. For instance, take an Apple or a Pear in the orchard, and we will find that generally the young shoots of 1864 will not bear until the year 1866. The wood-buds of this season will form fruit-buds in 1865, and produce in 1866. But now here is an Apple tree that we wish to get as much as we can from in little room as a low standard, bush, or pyramid. Left to itself, it will follow the above rule. Stop the shoots as the gardener proposes at the end of the summer, and you will do something to ripen the back part of the shoots, but not enough to cause fruit-buds to form there. Nip out the points of these shoots now, when 6 or more inches long, and though two or three of the shoots that start will be useless and may be cut back in the winter pruning, the effect of the early stopping will be to mature many of the buds behind into fruit-buds for 1865. If stopped too soon these buds would be started into late summer shoots and retard fruitfulness.]

LIPARIS LÆSELII.

On accidentally taking up THE JOURNAL OF HORTICULTURE for October 27th, 1863, my attention was caught by the following passage in the report of the Todmorden Botanical Society:—"From C. J. Ashfield, Esq., of Preston, announcing his discovery in the fens of Norfolk of the very rare British flowering plant *Liparis Læselii*." In one fen certainly, Roydon, it grows in considerable abundance, and numbers of plants have been sent thence to different collections. It also, I believe, grows at Horsford, but I never sought for it there. If I recollect rightly, Withering, on the authority of Woodward, gives Burston as a locality. In this he was probably mistaken, as there is no suitable locality for it there; and his mistake is easily accounted for, as many plants were collected for him by a friend who was then curate of Roydon and Burston. Its occurrence, therefore, in the fens of Norfolk is no novelty.

I take it that this plant may be almost considered as a link between terrestrial and epiphytal Orchids, as, though it grows on the ground, its roots do not run into it, but spread through the cushion of wet moss which covers the peaty soil.—DUCKWING.

THE WEATHER.—Notwithstanding the late intense heat we have lately experienced, there were on the morning of this day week, in the vicinity of London, no less than six

degrees of frost, which in some parts has done great damage to the Potato crops; and in some places the young shoots of *Rhododendrons* have suffered severely.

NEW BOOK.

Our House and Garden: What we see, and What we do not see in them. By CUTBERT W. JOHNSON, F.R.S. London: Ridgway.

THIS is one of a class of books always popular—it tells the "why" of what is hourly occurring at our homes, and, moreover,

"Finds tongues in trees, books in the running brooks,
Sermons in stones, and good in everything."

It combines also utility with its science, and gives "modern instances," as well as "wise saws." Take for example this quotation:—

"There are many advantages from the use of rain water for domestic purposes. This is felt even at the wash-hand stand, less soap is needed, the cleansing is more rapid, the softness of the skin is preserved. Still greater benefits attend its use for other domestic purposes, such as in tea-making, brewing, and in washing clothes. On this last head Professor Clark observed:—'The inhabitants of London are probably not aware so much as visitors from the country are, of the amount of destruction to clothes in consequence of the hardness of the water, and the use of soda in order to get rid of the hardness. I remember an occasion, which I may mention, where the amount of wear and tear was brought out in a very conspicuous manner. Two young men, brothers, in Glasgow, were put into counting-houses—one in London and the other in Glasgow. They had each a similar assortment of shirts given to them. Some time after, when the brother in London came back on a visit to Glasgow, the lady of the house pointed out, to the wonder of her female friends, the difference there was in the wear of the shirts of the two brothers, that had been given at the same time; those that had undergone the London washing were so much more worn than the others which had been washed at Glasgow. Yet I can state from experience, that linen gets soiled from the atmosphere rather more readily in Glasgow than in London. The hardness of the Glasgow water was about 4°, and that of London about 12°.'

"From the result of various inquiries, instituted by the Board of Health, it appeared that, for every 100 gallons of water used for washing, 2 ounces of white curd soap are needed for every degree of hardness in the water; that 100 gallons of water, of 5° of hardness (or containing five grains per gallon of the salts of lime) require 10 ounces of soap, and with 15° of hardness, 30 ounces.

"As we learn from the results of these inquiries that every person uses, with hard water, on an average, about 11 lbs. of soap during the year for washing and domestic use, costing about 6s., so the use of soft water, or even of 5° of hardness, reduces the cost to about 2s. per annum.* And, as the Board of Health remarked long since—'The extra cost incurred by the use of hard water shown by the chemist is demonstrated in domestic practice.' A lady recently come to reside in London has found the following difference in the quantities of soap and soda required to wash the clothes of the same household. In the country rain water was used; in London the water from the Chelsea Water Works is used:—

COMPARATIVE COST.

Material and Labour.	Country, with soft water.		Town, with water from Chelsea Water Works.	
		<i>s. d.</i>	<i>s. d.</i>	<i>s. d.</i>
Soap	½ lb. at 6d.	= 0 3	1½ lbs. at 1d.	= 0 9
Soda	½ ,, 1½d.	= 0 0½	1½ ,, 1½d.	= 0 1½
Labour, say		5 0		10 0
		5 3½		10 10½

"The difference does not, however, end with the additional cost in material and labour, inasmuch as the hard water requires twice the time, which is probably the greatest tax and inconvenience, as the whole house is disturbed during the process; but beyond this there is the additional wear and deterioration upon all clothes, especially those of a fine texture, such as muslins and cambrics. The destruction of these is doubled by hard water; so that if five shillings represent the cost of washing a certain amount of clothes with soft or rain water, four times this sum, or 4l. sterling, will be the cost of using hard water, such as the Chelsea Works supply—namely: 10° of hardness, according to Dr. Clark's soap test."

The author does not confine his notes to what is observable under the roof-tree, but extends them to things out of doors. Our example from this portion of the work must be brief.

"THE GRAVEL WALK.

"We leave the threshold of our dwelling—we are on the gravel walk—is there anything here to inquire about? Our first foot-step in our garden is on gravel. What is gravel?—Why does it bind?—What is it commonly composed of? Its binding properties are owing to the presence of some clay mixed with oxide of iron, and these set when exposed to the atmosphere; and again, the binding properties of gravel are considerably influenced by the shape of the flints or pebbles which it contains. When these are round, or little boulders, they have little or no hold of each other; they are easily displaced by our walking upon them, or by the action of alternate wet and drought, or frost. The best garden-walk gravels, such as those of Kensington and other places, have their flints of an angular

* As the average cost of washing per head in the metropolis is calculated to be about 50s. yearly, it would seem that, in a population of 2,000,000 of persons, at least £500,000 per annum is spent amongst the washer women!

shape. We are, most of us, aware of the infinite variety of gravels which are to be met with in most parts of England, all varying in composition."

The quotations we have given are evidence that this volume combines two qualities which merit success—usefulness and clearness; and our readers will not reprove us if our commendation induces them to become its purchasers.

A WORD TO AMATEURS.

I BEG permission to offer a few remarks on the subject so agreeably commented upon by "PATELIN."

In the first place, I greatly admire his cleverness, as set forth by his own words: he says he is "only an amateur." Now, I happen to belong to the more practical class of gardeners, and, like him, never yet had occasion to ask your advice on any subject whatever; but, were I to find myself in any difficulty, I should not hesitate for a moment about asking a question.

I know there are many gentlemen, who, like "PATELIN," take a great interest in gardening, and who look very sharply after the poor gardeners. In many such instances the gardener is not permitted to do anything without his master's orders. Now, this is all very well when a master understands the work better than his gardener, but this is seldom if ever the case. More frequently the master does not know one-half the work his garden requires; and in consequence of this the gardener, who sees three days' work where his master sees only one, is continually at his wit's end to keep all going on smoothly, and is frequently obliged to neglect work which he knows ought to be done, but for which he is not allowed time by his master. If he were left to manage according to his own better judgment and experience, he would be able to do his work much more comfortably to himself, with greater satisfaction to his master, and without losing so much time in explaining how he would like to do such and such things for the best.

Many amateurs on turning their attention to gardening, commence where they ought to finish—that is, by interfering with, and giving orders about things they do not understand. Now, were I an amateur, I would first of all learn to use the spade, hoe, rake, &c., and when able to dig, plant Potatoes, or cast out a Celery trench, I should know how such operations ought to be done, and not till then would I consider myself qualified to superintend that description of work.

A man may read all his life, but that will not make him a gardener. Moreover, there are plans of operation recommended in some of the best works on horticulture, which are unsuited to particular localities and the requirements of some particular families, &c. Thus amateurs are very frequently led astray, not from any fault in the books, and, probably, not from any want of sagacity in themselves, but simply because they have not had any experience in the business, while a good gardener is never thus misled, but recognises the best mode of procedure at once, as to him it is all travelled ground.

It certainly is advisable for an amateur to make himself thoroughly acquainted with every department of the science, as "PATELIN" recommends, although I have some doubts as to whether he himself has yet attained that dizzy height on the great horticultural tree.

Another word and I have done. Let it not be forgotten that the situation of a working gardener frequently involves great responsibility, and requires a considerable amount of skill and practical knowledge. He is too often overworked, and is sometimes not remarkably well paid for all his trouble, so that he can very well do without being continually interfered with and tantalised by a meddling and misguided, although well-meaning master.—TRISTRAM SHANDY.

THE RED LOCUST TREE.—We have been favoured by M. Decaisne, of the Museum of Natural History at Paris, with some flowers of a red variety of *Robinia pseud-acacia*, which was raised by M. Villeveille, a nurseryman at Manorque (Basses Alpes). Judging from the few flowers that M. Decaisne has sent us, and for which we take this opportunity of thanking him, it will prove a very valuable acquisition among our ornamental trees. The old white

variety is of itself a great beauty when in full bloom, but a red variety will be more beautiful still; and as M. Decaisne also informs us that it is as fragrant as its parent, it will be eagerly sought after by all lovers of flowering trees.

HOW TO CUT A CABBAGE.

SUCH a very simple matter as the above may seem hardly worth notice; but as, like many other things, there are two ways of doing it, it is as well to know the right way. And first, the ordinary, and wrong way is this: The left hand is put under the large lower leaves, the Cabbage pressed a little on one side, and a straight cut made across the stalk, thus removing the whole Cabbage; the short stump is then slit downward, crosswise, which touch of art finishes the operation. The right way is this: Press the left hand between the hearted part of the Cabbage and the large lower leaves, so as to give room for the use of the knife, and then make a clean, slightly slanting cut close under the hearted part, thus removing the Cabbage, but leaving as long a stump as possible. Then cut off the large leaves, half an inch or an inch from the stump, and you have finished. By the first way you only leave stump enough for one or two sprouts to grow from, while the needless split lets in the rain, and induces rotteness. By the second you get the same amount of Cabbage, and leave stump enough for four or five or half-a-dozen good sprouts to grow from; while the clean, slanting cut, without the split, sheds off the rain, and saves the stump much longer from rotting.

I am aware that the practice of growing Cabbage sprouts at all is condemned by some; but as it is very generally done, I write the above lines that others may profit by the wrinkle.—C. L.—(*Irish Farmer's Gazette.*)

[We assent to all "C. L.'s" directions except that which bids us "cut off the large leaves." Without intending a pun, we say, Leave them, and do not remove them until the sprouts are of some size.

Let no one sneer at this matter as "trivial," but let every one bear in remembrance that whatever has to be done should be done in the best way. We would snub any one who laughed at the man for saying, "Soda in the water in which Cabbages are boiling is like Hammersmith."]

PROPAGATION OF UTRICULARIA.

In compliance with your request, I proceed to put upon paper my observations on the propagation of *Utricularia* major and minor by means of detached buds. If we place at this season a plant of either species to float in an aquarium, we perceive that it consists of a mass of roots suspended in the water by its well-known curious bladders; from this grow a number of thread-like stalks, set round at intervals of three-quarters of an inch or thereabouts with whorls of linear leaves, giving to the plant a certain similarity to *Tremandra verticillata*; the spaces between the whorls nearest to the base having arrived at their full development, and those more distant gradually diminishing as they approach the loose terminal growing bud. As the number advances the growth becomes more sluggish, and the space between the whorls shorter, while the leaves of the terminal bud are much smaller and more closely knit together. In the autumn the leaves die off from the stalk, and the terminal bud, losing its outer leaves, is left at the extremity of the stalk, a little green ball about the size of No. 3 shot, looking like a miniature Brussels Sprout. About October the stalk itself decays, leaving the close compact bud to float freely in the water, ready to be carried to a new home by the winter's floods.

In the spring the process is reversed, the almost obsolete stalk which has been concealed in the globular floating bud elongates, the leaves grow larger, the whorls detach themselves from one another as the portion of stalk between them grows. From them the new roots descend, and the plants gradually assume their summer appearance.

I have seen the process in both species, major and minor. Is this mode of propagation common? It seems allied to the formation of buds or bulbs in the flower-head or axils of the leaves in some sorts of Onion and Lily.

No one seeing for the first time these little green balls floating in an aquarium would suspect their nature.—DUCKWING.

[Although our correspondent adopts this "shadow of a name," he is a clergyman and naturalist.]

SIKKIM AND OTHER INDIAN RHODODENDRONS.

WHEN the Sikkim Rhododendrons were first introduced into this country, with glowing descriptions of the magnitude of some, and the beauty of all, as seen in their native habitats, great interest was created amongst the lovers of hardy ornamental plants, which led to free discussion as to their probable adaptation to our climate. Many were of opinion that they might succeed to some extent in the southern counties of England, and possibly in some of the warmer districts of Ireland; but that elsewhere in these islands they could not be expected to thrive. This was the impression not so much on account of the severity of our winters, as the want of warmth in our comparatively cold and ungenial summers to ripen their wood and mature their flower-buds. It was argued that the late spring frosts on the one hand would injure many of their tender shoots, and that on the other hand, the cold summers would leave the growths that might escape unripe, and, consequently, without flower-buds.

Experience, the best guide in these matters, has shown that some of the species at least, if they do not grow with the vigour they are represented to do in their native country, are hardy even in Scotland, and flower freely. Others are less so, and are liable to suffer occasionally from late spring frosts. Very probably this defect will be greatly modified as they increase in age and size, as is the case with many species of the rarer Conifere, such as the *Picea cephalonica*, *P. Webbiana*, &c.; also by surrounding those species which start early into growth with Spruce Fir or other branches, so as to partially shade them about the period they are bursting their buds and coming into leaf, leaving the protection undisturbed till all chance of frost for the season is past. In some localities the middle of June will be found early enough to remove the protection.

The following species start early into growth, and are greatly benefited by some such protection as I have indicated above; at least, for a few years after being planted, when it is possible they may outgrow that tendency from being less excitable, and from the habit of coming later into growth—*Rhododendron Wightii*, *Wallichii*, *Acklandii*, *robustum*; and somewhat later, *R. campanulatum*, *campylocarpum*, *cinnamomeum*, *lanceifolium*, *argenteum*, *barbatum*, and many others.

Sometimes when I have small plants of Sikkim, Himalayan or other Indian Rhododendrons, of which I have any doubt as to their being injured by late spring frosts (for after all this is the great difficulty we have to contend with), I have them planted amongst larger and taller plants, so as partially to shade them, particularly on the south side, taking especial care that the space is not confined, always allowing plenty of room for light and air freely to pass around them.

The Rhododendron delights in a little shade, and in this position the plants make rapid growth, scarcely ever suffering from late spring frosts, being thoroughly shaded from the morning sun. Grown here in this way *Rhododendron Thomsoni* is double the size that it is when planted in a warm and sheltered situation, but fully exposed to the sun's rays. In the former case a flower-bud has never formed; in the latter, about sixty trusses of magnificent flowers have this season been produced, forming for some weeks past an object of great interest in the American ground. The same plant flowered last year, but not so abundantly.

Rhododendron barbatum is just going out of flower. The bloom somewhat resembles that of *R. Thomsoni*, but is much smaller, and less striking for a decorative plant. Some Indian seedlings are at present in flower, or just passing out of it. A milk white one is in bloom just now, with campanulate flowers as large as those of *Thomsoni*, far surpassing for decorative effect any of the old white varieties in cul-

tivation, and, when used for cut flowers, as a light-coloured variety it has no equal. These Indian varieties when raised from seed appear to sport as much as the old varieties, showing this tendency largely in the foliage as well as the flowers.

Soil and treatment such as is generally given to the finer sorts of Rhododendrons, seem applicable to the varieties from Sikkim, the Himalayan mountains, and other elevated districts of India. Grow them when young in slightly shaded and warm situations, and when old enough and large enough to flower, remove them to the full blaze of the sun, always selecting a well-sheltered and warm situation.—ARCHIBALD FOWLER, *Castle Kennedy, Stranraer.*

WORK FOR THE WEEK.

KITCHEN GARDEN.

TRENCH-UP every spare piece of the garden for the first plantation of winter stuff; let the trenching be 2 feet deep in the first instance, after which give a coat of manure, and dig it in, when the ground will be ready for planting with Broccoli, Brussels Sprouts, Buda Kale, and such like. Plant the former 2 feet apart each way, if fine heads are desired; the other two will do well with a few inches less space. After the plants are put in attend to their protection from slugs: for doing which the simplest means is to place a ring of hot lime round each plant. *Asparagus*, give this good soakings of liquid manure, keep the surface of the beds free from weeds, and well pulverised by frequent hoeings between the rows. No plant pays better for good management than *Asparagus*, and none is more sensible of neglect. *Broad Beans*, make another sowing of Longpod if they are much in request, and take off the tops of those in blossom. *Broccoli*, make another sowing of Miller's Dwarf White Russian, this will come into bearing in the end of April and beginning of May. *Jerusalem Kale*, sow, and also the Old English Colewort, both are very useful for planting after Potatoes. *Peas*, sow, also, in smaller quantities for succession; the north side of a sloping bank is well adapted for them, being naturally cooler and more retentive of moisture. Keep the surface well loosened amongst the Peas just coming up, and earth-up and stake others as they become ready. *Scarlet Runners*, sow, and Dwarf Kidney Beans for succession, and transplant those that have been forwarded, if not already done. *Sea-kale*, thin-out the buds, so as not to allow them to crowd each other, and water once or twice in the season with a weak solution of salt and water, which will benefit the plants, and dislodge snails and other vermin. Two ounces of salt to a gallon of water will be sufficient. *Spinach*, keep up a succession. *Turnips*, sow another good breadth, and thin-out those advancing. Prick-out Cape Broccoli and late Cauliflowers, and keep all seedling crops of this kind well dusted with lime to save them from the slugs.

FRUIT GARDEN.

Peach and Nectarine trees affected with green fly and curled or blistered leaves, should be well syringed with strong lime water from a garden engine. Continue to nail in the young shoots of all kinds of fruit trees as they become sufficiently advanced, and keep the finger and thumb at work amongst the superfluous ones. Give the Strawberry-beds a final stirring, and have some available material at hand for laying upon them to prevent the fruit from getting dirty: wheat straw is often used for the purpose.

FLOWER GARDEN.

The Verbenas and Petunias turned out into the beds should have their shoots pegged-down. Many plants are lost through want of attention to this practice. Plant out the Dahlias that have been grown in pots into the flower-borders, fill up the holes with some good compost, and finish with staking each plant. As the shrubbery will soon present a gay appearance, activity and attention must be the order of the day in this quarter, that the deciduous and evergreen flowering shrubs may appear to the best advantage. The Pæonies, Phloxes, Delphiniums, Lysimachias, and other tall herbaceous plants, must be properly staked. Keep the hoe and rake unceasingly at work till all weeds are removed. Roll, mow, and clip the edgings of grass lawns once every ten days, and use the daisy rake at intervals.

Do not neglect to stir the ground after heavy rains, thin out annuals, stake plants in borders as they grow, remove all decayed leaves and flower-stems, and everything offensive to the eye. Continue to destroy insects on Roses.

GREENHOUSE AND CONSERVATORY.

Camellias should now be placed in a little warmth to make wood and set their flower-buds. Be careful never to allow them to suffer for want of water. Keep up a gentle moisture by occasional syringings. Azaleas as they go out of flower may also be similarly treated. Indeed, all kinds of greenhouse plants are benefited by being kept rather close and warm when making their wood. Rhododendron arboreum and its varieties should be fully exposed to sun under glass if you wish to have perfect foliage and abundance of flower-buds. Partial shading is the ruin of these plants, both as regards the foliage and the forming of their flower-buds. Keep the conservatory shaded and cool to prolong the flowering of all plants brought there, and none should be permitted to remain after the bloom begins to fade. Keep the borders slightly moist, which will assist in prolonging the bloom. Very young stock of Ericas, Epacrises, and small fancy New Holland plants will be best in a pit or frame, placing the lights to the north. Attend to the plants for autumn and early-winter decoration—such as Japan Lilies, Chrysanthemums, scarlet Salvias, tree Carnations, and things of that sort. Give them plenty of pot room, good rich compost, a moist atmosphere, and plenty of space for the proper development of their branches and leaves. Go over twiners frequently, and regulate their growth before the shoots get entangled, but avoid keeping them tied too closely, for they are never seen to advantage unless they are allowed to hang in a natural and graceful manner. After the bedding-out is accomplished a reserved stock should be immediately taken in hand, and should receive high cultivation in order to fill up blanks the moment they occur, either in the houses or the borders. The best Verbenas, Fuchsias, Calceolarias (especially the shrubby kinds), Petunias, Phlox Drummondii, &c., will be found most useful things, and too many can be scarcely provided. These may be plunged by themselves in a sheltered situation. Get some young Thunbergias put into their final pots for trellising. These are useful things and keep up a late display.

STOVE.

Continue to stimulate the plants, repot any that may again require it. Attend to the training and stopping of such as are making rapid growth, syringing every afternoon, and letting everything be kept clean and in perfect order. As the weather still continues changeable, take especial care that the young shoots do not become checked or injured by cold draughts, or scorched by sudden bursts of sun. Every attention should now be paid to keeping down insects among the Orchids, nothing short of extermination should ever satisfy the zealous cultivator. Some of the free-growing kinds of Orchids will be benefited by increased pot-room, and those on blocks of wood and in wire baskets may have a little additional moss supplied over the roots.

W. KEANE.

DOINGS OF THE LAST WEEK.

KITCHEN GARDEN.

MUCH the same as in previous weeks. The work was chiefly confined to hoeing and forking amongst vegetables. Except in rare cases, such as preparing for small seeds, rakes should never be seen in a kitchen garden; and we have long banished them from the flower garden except for two purposes, namely, common wooden rakes for collecting the bulk of the grass after mowing; and the heads of small iron-toothed rakes, using the iron of the head only for running round the sides of flower-beds, and slightly pressing down the soil close to the edging. The teeth reversed just touch the soil a little. This gives enough of a finished appearance, and is done nearly as fast as a man can walk round. But for birds scratching this would prevent the lawn or walks being scattered with nodules of earth. Some time ago we saw men raking as smooth as the surface of a mahogany table, the spaces between rows of Cauliflowers, Onions, and Strawberries. We would prefer the surface being left porous and open. After such fine raking the first

heavy rain that came would leave a hard, battered, scaly surface, which would keep out all ameliorating influences pretty well as successfully as a coating of sealing-wax. Sowed Turnips and Radishes on a north bank—the former chiefly American Red-topped, the sweetest of all white-fleshed Turnips; and though some of the yellows, as the Maltese, are very fine, it is of little use speaking about them, as there is such a prejudice in favour of the white-fleshed kinds. For the cottager who looks to nourishing properties we would recommend first a pinch of the Early Stone or Snowball, then American Red-top, followed by Maltese and Swedes. Watered Cauliflowers and early Peas with sewage water.

FRUIT GARDEN.

As we expected, we had a heavy rain and an alarming thunderstorm on the night of Friday week, which did good service to the Strawberries and other crops. The sun, however, soon evaporated a portion of the valuable moisture, and we followed as we could get at them with sewage water and manure water from drainings from the farmyard. The appearance of Strawberry plants turned out of forcing-pots last season is magnificent. Plants so turned out and now bearing the second year are very fair, but nothing like those alluded to above. Some Queens of the second year that had no litter on the ground in winter are very poor—in fact, were intended to be dug down in spring and the ground used for other crops. Some rows beneath Apple trees, similarly treated, that will soon be giving their third crop will furnish a good supply for preserving purposes, but will be of little use for the table as compared with those now bearing out of doors for the first time. Where extraordinary results are expected from these turned-out forced plants only one crop should be taken. Of course we count as nothing the useful gatherings such plants afford the first autumn after being turned out. We perceive no runners coming as yet. We have now got all the Strawberries from the forcing-house, except the front of the Peach-house and the cool orchard-house. For many years we had a sort of breathing time for several weeks in May, and therefore the aim was to have plenty of Strawberries before the first week in May and again plenty by the 1st of June. This season it was desirable to have a continuous supply in May, and therefore we raised and potted some hundreds of nice young plants. We would have also planted some on a slight hot-bed, but we exhausted the supply. Even with this we begin to see that if the weather should be cold we may have a few days' interval between those under glass and those in the open air; and to prevent that, if possible, we have set hand-lights over good rows on a sloping bank, and some old sashes over others on the flat; and if the weather be sunny such contrivances will forward them a week, but if dull it will not forward them much. Having some long narrow old sashes at liberty, we made a curate's vinery of them by setting them against each other hipped roof fashion, so as to take in two rows of Strawberries. With such moveable sashes it is easy to make a Strawberry-house.

Proceeded with disbudding and stopping the shoots of fruit trees, thinning fruit, thinning Grapes, pinching and thinning Fig-tree shoots. Have pretty well cleared all the houses of flowering plants, and our pits of Dwarf Kidney Beans in pots in full bearing, plunging the pots in earth-pits, from which the bedding plants have been taken, and giving them protection. Strawberry-pots with fruit about ripe have also been set in similar places, and the additional light they thus receive gives the fruit a better flavour. Some had glass over them, others were exposed during the day, with a cloth or mat thrown over them at night, a few sticks keeping the covering from the plants. When far on in May lofty shelves of Strawberries stand in hot forcing-houses, the accidental omission to water a single pot may bring a visit of the red spider. Whenever a single leaf is seen to be affected the plant should be as carefully removed as if you had found some great rarity in natural history. The shaking of a leaf may leave a fine progeny of red imps to annoy you. These, to be sure, are very trifling matters, and though, if we try at all we try to be simple, complaints still come that we do not dwell enough on the simple matters. This reminds us of getting into great trouble last year from a friend scorching his best Strawberries, and, as he persisted in saying, by acting according to our advice.

Like a correspondent this week, he had put out his plants in patches of fours, intending to thin them as they grew larger, and being on a nice border, he was anxious to bring in a part before the others. Having at liberty eighteen 20-inches-square glass hand-lights with moveable tops, we advised setting them over as many patches, and to shut the top close by three or four o'clock in the afternoon. It seems we omitted to tell him to partially open for air by breakfast-time at latest; and the glasses remaining close through some sunny days the fine serrated edges of the leaves were scorched, and the young fruit was burned so hard that it never swelled afterwards.

ORNAMENTAL DEPARTMENT.

A great deal has been done in pruning, potting, &c., greenhouse plants; but the chief work has been finishing cutting the edges of the walks in the pleasure ground, and planting out lots of bedding plants. Where there is much bedding out to do a man is more prepared to go to bed than to write about the work being done. Luckily our men are as anxious about it being done as ourselves, or we should find a difficulty in getting through with it, and keeping other departments from falling into arrears, for we must never forget that, in the majority of cases, pleasing the eye with masses of flowers will be poor compensation for the want of vegetables and fruit. The whole, or nearly all the cropping is changed, and, if anything, though some of the larger beds are chained, curved, and quartered, the planting is as simple as possible. Most of the principal parts near to, and in sight of the mansion, are finished. The two square groups below the terrace will be chiefly filled with Verbenas. The terrace border, from 600 to 700 feet long, and 5 in width, though having Cerastium on each side, will this season slope to the terrace lawn and mansion, and is otherwise planted with four rows. The farthest-off and tallest row is *Salvia fulgens*, which, in the same place years ago, we have had a dense hedge of scarlet 3½ to 4 feet high up to the end of November. The second row is tall *Ageratum mexicanum*. The third row is *Aurantia multiflora* *Calceolaria*; and the fourth row, next the broad band of *Cerastium*, *Tom Thumb Geranium*. The *Salvias* and *Ageratums*, strong plants, are 15 inches apart. The *Calceolarias*, fine plants, are 12 inches apart, and *Tom Thumb* 10 inches. None of these had ever been in a pot, but were lifted from earth-pits. Our large ribbon-border some 340 feet long is thus planted with eight rows, commencing at grass verge—*Geranium Brilliant*; 2, dwarf *Ageratum*; 3, *Prince of Orange Calceolaria*; 4, *Stella Geranium*; 5, *Amplexicaulis Calceolaria*; 6, to be *Perilla*, not yet planted, but coming on in pots; 7, white single Chinese Daisy or *Chrysanthemum*; 8, *Trentham Rose Geranium*, strong plants struck last autumn, and turned out of 32-sized pots. The opposite border is double, facing the walk on one side and the lawn on the other, and has fifteen rows. The centre row which runs in a line with the chains, to be covered with *Cobæa* and *Eccremocarpus*, consists of *Scarlet Defiance Geranium*, to balance *Trentham Rose* on the opposite side. The other planting on both sides is similar. These are planted so as to make banks of massive, distinct lines of colour, and so as to need little or no attention in the way of regulating heights. *Defiance* and *Trentham Rose* are large plants from pots, the latter having had the assistance of a little bottom heat for a fortnight under glass, which improved them amazingly. The *Brilliant* and *Stella* are good plants, showing bloom, struck from small cuttings in the autumn, placed about an inch apart in moveable wooden boxes; early in March they were potted singly in small 60's, and kept in one of the houses until rooted, when they were turned out of the pots into an earth-bed, and these have made nice roots and heads. The *Calceolarias* were placed as cuttings in a pot in October, kept there all the winter, and turned out into earth-pits about the middle of March.

We have done these borders in waved lines, and in parterre style; but we have put them in straight lines this year for two reasons—first, to save time in planting, and chiefly in future training; and secondly, because eight-tenths of the visitors who gave an opinion preferred these massive straight lines to any more artistic arrangement. A lady has been at great trouble in cutting out sharp-pointed stars on her lawn. No planting will make these stars so effective as old-fashioned circles.

The warm weather led us to begin a little earlier than usual, as the ground was getting so nice and warm. The heat in the ground has generally determined the season of planting. We do not think we have suffered in anything from the frost of last Tuesday morning, unless in the case of the *Amaranthus melancholicus ruber*. We had previously made up our mind that we would not plant out this until about the 10th of June, but the nice plants and the hot weather beguiled us, and many of the larger leaves are whitened and blotched, even though protected with laurel twigs. Unless this increased heat in the ground is obtained little is gained by early planting. Much more depends on getting the ground well turned and aired. We have seen plants inserted among bulbs, &c., in the end of April and the beginning of May, and we have seen similar plants taken to well-turned beds in the beginning of June, and they beat the early plants hollow before a month had elapsed.

With two more observations we will finish this week. We had a little disadvantage in planting in such hot weather, as most of our plants came out of beds instead of pots, and therefore were more liable to flag. We gave them, however, but a little water each. We knew that the more water given the cooler would the roots be and the cooler the soil about them from evaporation. To prevent the strong action of the sun on the foliage some boys, who were taught the knack, were kept gently dewing them from the syringe or engine several times a-day. Any moisture that escaped on the surface soil was soon raised as a warm vapour about the leaves, and did much to arrest flagging. We do not like to say how many yards a single potful of water would thus dew or sprinkle. The finest-pierced rose of a syringe could not put on water so fine as may be done by regulating the discharge by the thumb from the nozzle of a garden engine. Some, no doubt, would dread doing this, and the sun shining so powerfully. Well, we never found out the bad effects, and we have seen a good many bright natural sunny showers. It always struck us that plants seemed to luxuriate in such natural showers.

The second observation is, that we often act wrong when we are pretty well convinced we are doing wrong. The delightful rains of Friday week moistened our dry beds, but we did not think them much too wet for planting on the Saturday, more especially as boards were used for planting, and we were anxious to take advantage of the moisture thus beneficently sent. Some of the beds planted on Saturday had better been left until Monday, presenting now a sodden, caky appearance, instead of the kind open texture of the other beds planted before and subsequently, and confirming what we have often alluded to—the impropriety of moving ground at all stiff when wet. It will hardly get right again during the season. A little piece in the kitchen garden was dug rather wet, and now it hangs together like bird-lime. The air will not enter it freely, and the water will not pass through it readily, but remains suspended in it like a sponge. Ground by the side of it turned up when dry is as friable, open, and healthy as need be. Working out in all weathers and circumstances is anything but economy, did we overlook the health of the operator. On beds raised as baskets the planting was done well. On a few other beds rather freshly turned over the planting would have been better deferred for a day or two, until the surface was nice and dry.—R. F.

COVENT GARDEN MARKET.—MAY 28.

The Market continues to be well supplied; and heavy consignments of Carrots, Endive, Artichokes, Kidney Beans, and Cherries are kept up from France. Hothouse fruits are sufficient for the demand. Forced Strawberries are getting over, but a few out-door-grown ones have made their appearance. New Potatoes are both good and plentiful. Cut flowers are in brisk demand. They mainly consist of Roses, Pelargoniums, Orchids, Azaleas, Rhododendrons, Cinerarias, and Heaths.

FRUIT.

	s.	d.	s.	d.		s.	d.	s.	d.
Apples	½	0	0	6	Melons	each	8	0	15
Apricots	doz.	0	0	0	Nectarines	doz.	12	0	24
Cherries	lb.	1	0	2	Oranges	100	8	0	14
Figs	doz.	12	0	20	Peaches	doz.	13	0	35
Filberts & Nuts	100 lbs.	0	0	0	Pears	bush.	0	0	0
Goosehrs. Green	½ sieve	3	0	6	dessert	doz.	0	0	0
Grapes, Hothouse	lb.	8	14	0	Pine Apples	lb.	6	0	10
Muscats	10	0	15	0	Strawberries	oz.	0	6	1
Lemons	100	4	0	10	Walnuts	bush.	14	0	20

VEGETABLES.

	s.	d.	s.	d.		s.	d.	s.	d.
Asparagus bundle	3	0	6	0	Lettuce..... doz.	1	0	2	0
Beans, Broad..... bush.	0	0	0	0	Mushrooms pottle	1	0	2	0
Kidney.....100	2	0	0	0	Mustd. & Cress, punnet	0	2	0	4
Beet, Red..... doz.	1	0	3	0	Onions bushel	7	0	10	0
Broccoli bundle	2	0	3	0	pickling quart	0	6	0	8
Cabbage doz.	1	0	1	6	Parsley $\frac{1}{2}$ sieve	1	0	2	0
Carrots bunch	0	6	0	8	Parsnips doz.	0	9	1	6
New.....	1	0	1	6	Peas..... quart	1	6	3	0
Cauliflower doz.	4	0	8	0	Potatoes sack	6	0	9	0
Celery bundle	1	6	2	0	New.....lb.	0	4	0	8
Cucumbers each	0	6	1	6	Radishes doz. bunches	0	6	0	9
Endive score	1	3	2	6	Turnip	0	6	1	0
Fennel bunch	0	3	0	0	Rhubarb.....	0	4	1	0
Garlic and Shallots, lb.	0	8	0	0	Sea-kale basket	0	0	0	0
Herbs..... bunch	0	3	0	0	Spinach.....sieve	1	0	2	0
Horseradish bundle	1	6	4	0	Turnips.....bunch	0	6	0	8
Leeks..... bunch	0	6	1	0	New.....	1	0	2	0

TO CORRESPONDENTS.

* * We request that no one will write privately to the departmental writers of the "Journal of Horticulture, Cottage Gardener, and Country Gentleman." By so doing they are subjected to unjustifiable trouble and expense. All communications should therefore be addressed solely to *The Editors of the Journal of Horticulture, &c., 171, Fleet Street, London, E.C.*

We also request that correspondents will not mix up on the same sheet questions relating to Gardening and those on Poultry and Bee subjects, if they expect to get them answered promptly and conveniently, but write them on separate communications. Also never to send more than two or three questions at once.

N.B.—Many questions must remain unanswered until next week.

THINNING COE'S GOLDEN DROP PLUM (*W. Sumner*).—They should not be left closer than from 6 to 9 inches from each other.

HOUSE SEWAGE, &c. (*T. C. F.*).—In "Manures for the Man," which you can have at our office for 4s., you will find full directions for its application. Having no particulars we cannot say why your fruit trees are failing. The roots, perhaps, have descended into an ungenial subsoil.

PACKING STRAWBERRIES, &c. (*An Old Subscriber*).—Fold a leaf around each berry, and place in single layers in the box—that is, have a false bottom between each two layers, and so propped that it does not press on the layer beneath. The Strawberries will then travel a great distance if picked dry, not over-ripe, and unbruised. Write to Messrs. Neighbour, Italian Warehousemen, 149, Regent Street, and ask them about the disposal of the kat-sap.

APRICOT TREES DYING (*Henry G.*).—The roots of the specimens sent had long ceased to supply any sap to the branches. They seemed as if the soil in the house was kept too dry; but not knowing the treatment we cannot be positive. If it is as we guess, then give more water, and cover the surface for 2 feet around each stem, and an inch deep, with cocoa-nut fibre refuse.

INSECTS ON VINE LEAVES (*E. S.*).—We think your leaves are holed by a small caterpillar, or Cynipis. You must take a candle and hunt for them at night. A sheet spread below them will catch them as they fall when you shake the plant.

PLUNGING GERANIUMS (*S. E.*).—You are quite right as to plunging pots of Geraniums between the Rose plants. The Geraniums will bloom better, and injure the Roses less. The Harry Moore system of Scarlet Geranium growing consists chiefly in keeping the plants year after year in the same pots and boxes, merely giving a little top-dressing every year. They will want much less pruning than those planted out in pots in the ground. The same system, however, may be pursued with them by taking up the plants early in autumn, and shortening any very vigorous shoots. The advantages of this system are, giving a great amount of bloom, and but little growth, and avoiding the trouble of frequent shifting. We would not fresh-pot the plants you turn out. The more full of roots the pots are the better; a little soil and lime put below the pots will keep the worms from them. If a few should come, lime water will settle them. You will have to water these pots in dry weather.

PERILLA NANKINENSIS MANAGEMENT (*X. D.*).—Perilla does not like pinching when very young, but as soon as the side shoots break freely you may pinch and cut with perfect safety. You may thus have the plant 24 or 6 inches high, and both will be equally nice if the pinching and cutting are concealed. It also bears pegging, or tying down. Plenty of twiggy shoots should appear in any case, as the wrinkled small leaves are the prettiest.

SPRING BULBS FOLLOWED BY BENDING PLANTS (*Agnes*).—The first week in June will do for bedding plants if they are kept growing and not stunted and starved till then. By that time all the Anemones, Tulips, &c., may be taken up with some earth attached and placed on a moist border with leaf mould between them, and when the foliage is quite gone store the bulbs in the usual way in a cool dry place.

STRAWBERRY PLANTS FAILING (*A. M. S.*).—We have no doubt that you have over-manured your Strawberry plants, and used the same ground too long. We would advise a fresh plantation in fresh ground. Our Strawberries are generally fine, but a few are going off a little as you mention, only we know the reason. They were turned out of forced pots in 1862, here immensely in 1863, and had no protection on the ground in winter. These being Queens felt the frost. Those turned out last year with litter between the rows in winter have now each of them armfuls of bloom.

ORCHARD-HOUSE TREES' LEAVES INJURED—SIZES OF POTS (*C. P.*).—Some of the holes seem made by a little Cynipis, and for these you must watch at night. The little brown spots seem more like being burned by small nodules in the glass, and these should be looked for and daubed with putty or paint. They may also be made by drops on the leaves and a bright sun shining on them. We find no trace of insects. Why smoke the house if there are no insects? Tobacco smoke will injure the flavour of the fruit after they are swelling to ripening. Tobacco water will make them dirty and discoloured. We think clean water would be best, and if containing a little soap in clear solution it would be better than tobacco water; but we see no need for either. Clean water is safest. The following are the diameters of London sizes of pots in inches:—

Thumbs	60	L.60	54	48	40	32	25	24	16	12	8	6	4	3	2	1
" "	3 $\frac{1}{2}$	4 $\frac{1}{2}$	5 $\frac{1}{2}$	6	6 $\frac{1}{2}$	7	8	9	10 $\frac{1}{2}$	11 $\frac{1}{2}$	13 $\frac{1}{2}$	15	16 $\frac{1}{2}$	17 $\frac{1}{2}$	19	

FLOWER-GARDEN PLAN (*S. M. C.*).—Flower beds well filled, place them how you will, will look well, and no doubt yours will be very nice. As to the arrangement of the plan, we can say nothing better than refer you to many plans of gardens previously given. With the plan adopted we think you have made the very best. Your sloping border, which you have divided by Perilla into six beds of a similar size, and all, we presume, planted alike, will, no doubt, look well; but it strikes us it would have been more imposing if the lines had been carried on throughout without being cut up by the cross lines of Perilla. We think, also, a yellow Calceolaria would improve that border; and if Perilla were used for the lines we would thus plant—Dahlia, dwarf, Scarlet Geranium, strong, Bijou, Perilla, Yellow Calceolaria, Purple King Verbena, and then as you propose, only we do not know Lady Jersey Geranium. We think the other beds will look very well.

BORDERS FOR LATE VINERIES (*P. P.*).—For a late vinery 13 feet wide we would prefer having all the border inside. If made outside have it as wide as the house. The soil should be from 18 to 24 inches deep, with a foot of rubble below it over good drainage. As your fresh loam is light, we would use chiefly cow-manure, fresh and dry, in the proportion of one load to twelve or fourteen, one load of rough brick rubbish, and one bushel of rough broken bones. If the soil is very sandy and poor, give two bushels of bones, if not too new. The great thing is to have the border rather open. There will be no difficulty as to richness from top-dressings and manure-waterings.

PROPAGATING GERANIUMS (*M. H.*).—Keep them in pots in the greenhouse and grow them on. The plants will grow more, and you will be able to obtain more cuttings from them than if they were planted out, especially the kind you name, which is somewhat tender. Liberal treatment is the promoter of a supply of cuttings. You may plant them out in your greenhouse if you have a place near the glass and not shaded.

RHODODENDRON GRAFTING (*An Irish Subscriber*).—The proper time to graft these is when the stocks are beginning to grow in the latter part of May or beginning of June. Clematis azurea grandiflora is increased by layers, and may be raised from seed. Lastrea opaca is probably hardy in Ireland, but we have not proved it to be so in England. It would be safer to grow it in a greenhouse until you have a stock, and then try a plant or two. It is very distinct from Lastrea (Pycnopteris) Sieboldi, which is what you perhaps mean.

FAILURE OF MELONS (*W. W.*).—We are sorry to hear of your misfortunes but recommend you not to despair. You may yet obtain a crop this year, for we have a bed to prepare and plant yet, and we shall have a crop in September. We advise you to thin out the branches if thick, so that they will be 9 inches clear of each other—that is, if they are still showing fruit; but if not, cut out the old vines and train some young ones from the centre of the plants, distributing them 9 inches apart over the surface, and stopping them at about 6 inches from the stem of the plant if they are not sufficient to cover the space, so as to induce the requisite number of vines. When these have advanced to within 9 inches of the sides of the frame, take the point out of each, which will induce laterals, and on these appear the female blooms. When in bloom impregnate each flower, and when the corolla closes shorten the laterals to one joint above the fruit. Then as to watering: make holes in your dry bed, so that water will not run off the surface without wetting the soil, and thus bring it into a moist condition. After this, whilst the plants are growing, water twice a-week, and when the flowers are nearly ready for blooming give a good soaking with tepid water, and no more until the fruit is set and swelling, then give water as before until the fruit begins to ripen, after which little or no water is necessary. The main point in getting the fruit to set is to have the bottom heat brisk at the time of flowering.

LYCOPONS (*B. B.*).—We purpose publishing some notes on these next week.

MONSTER APPLE BLOSSOMS (*W. Brown*).—They are very large and very double, some of the stamens and the pistils being transformed to petals. If the spur producing them were used as a scion, it is probable that an ornamental tree might be obtained. The stock had no influence in causing such a metamorphosis.

CUCUMBERS (*W. C.*).—If by "creepers" of Cucumbers you mean their tendrils, it is perfectly immaterial whether they are nipped off or allowed to remain.

TRUFFLES.—A correspondent "*C. L.*" wishes to be informed what are Potatoe Truffles (as a substitute for Perigords), and the way to grow them.

FERNS (*A Constant Reader*).—We never recommended Ferns to be grown in cocoa nuts! We have often recommended the dust from the fibre of the husks of cocoa nuts to be used in the compost in which Ferns are grown.

VARIOUS (*W. W.*).—Cut off all the flower-stems of the Sea-kale as soon as they appear. Strawberries may be watered at all times of the growing season if the water is poured only between the rows? You may syringe the Grapes until they begin to change colour. How is it possible for us to tell you where you can obtain turf near Cheltenham? You had better sow the mound and banks with a mixture of Grass seeds. The following will suit—Crested Dog's Tail (Cynosurus cristatus), Hardish Fescue (Festuca duriuncula), Evergreen Meadow Grass (Poa nemoralis sempervirens), and Suckling (Trifolium minus).

NAMES OF PLANTS (*Loughborough*).—It is Luzula campestris, and though not the best of herbage for a lawn, yet if this is kept well mown, and a little leaf mould sifted over it every spring, the Grasses will keep the Luzula without bounds. It is one of the plants which may be said to blend the Rush and Grass genera together. (*D. H.*)—Your salt marsh plant is one of

the Arrow-Grasses, *Triglochin maritimum*. (*Verna*).—Sweet-scented Wood-roof, *Asperula odorata*. (*J. D.*).—1, *Potentilla alba*; 2, *Arenaria balearica*; 3, *Dryas octopetala*. (*T. S.*).—1, 2, and 3, varieties of *Polygala vulgaris*; 4, no flower, perhaps a *Cypripedium*. (*J. M.*).—All the specimens were much crushed. 1, one of the *Brassavolas*; 2, not known; 3, *Lycaste Baringtonia*; 4, apparently *Gomezia recurva*.

POULTRY, BEE, and HOUSEHOLD CHRONICLE.

"WE MUST DRAW A LINE SOMEWHERE."

THE Crystal Palace can have mountebanks, swings, hobby-horses, or wild beasts, but cocks and hens were "*de trop*." "That horrid crowing!" "Those odious cocks!" One declares it is a desecration of the Palace to make a farmyard of it, quite as bad as a Noah's Ark. Now the dear delicious Saturday concerts, which cost nobody knows how much, and which are so exclusive, and confined almost to the season ticket-holders; or, better still, Blondin on the high rope, and the dread lest he should fall. And another says she knows he must fall some day, and that compels her to go whenever he performs. There was fascination about it; she should scream, she should faint, but she must see him when he fell. It made her sweetly giddy to see him, as a friend said, with only a rope between him and eternity; but the crowing of the cocks spoiled it—just like the eternal chatter and noise of the children while she was reading "*East Lynne*." She would never rest till poultry shows were done away with, and the Palace became more select.

Well, well, "we must draw a line somewhere," and we will not have them at the Crystal Palace. It is a terrible thing to be common, but all common things are not alike neglected by all people. What fills Bingley Hall with half the nobility of England, with members of the learned professions, and the very *dite* of society? Poultry, pigs, sheep, and oxen. But it is certain the first is the most attractive. It has built a hall, paid off debts, and distributed thousands of pounds.

Poultry is a boon to many. It affords amusement to invalids who are incapable of very active exertion. It is a pleasing pursuit for ladies, for professional men, and for children. It is humanising, healthy, and instructive. There is, however, in the heart of every one the desire to excel and the thirst for competition. Happy the pursuits in which it can be indulged without objections even from the most fastidious. This is one of them.

The presiding genius of the late poultry exhibitions of the Crystal Palace, finding his occupation gone there, has pitched on another locality—the Alexandra Park, Hornsey. We confess we are not acquainted with the spot, but we think Mr. Houghton's name will be a guarantee that everything will be done that can be accomplished by activity and anxiety, coupled with the experience of many years. We are informed that in some respects the new show will have great advantages over that formerly held at the Crystal Palace. Every one is aware of the wretched arrangements on the railway. The delay in delivering the birds at the Palace was lamentable. While the Judges were at work there were constant arrivals. The same disagreeables attended their departure. The line is essentially one from London Bridge to the Crystal Palace, and the transit through London often occupied more time than that from the metropolis to the north. Senders of valuable birds were compelled to have people in charge to take them from London Bridge to King's Cross, Euston, or Paddington, as might be. Passengers were no better off on an ordinary full day: the price of a seat in the evening was two flights, a torn coat, and a half-crown bribe; lucky if with all this your first-class return got you into a third-class carriage. All these annoyances will be obviated by having to do with the best-appointed of all railways, the Great Northern. There will be direct communication with a great part of England. The directors will bring and return the poultry (if unsold) free of charge.

We alluded to the experience Mr. Houghton has had in these matters. We have proof of it in some alterations he has made in the prize sheet, and which we will refer to. He has supplied that which has been asked for by Brahma exhibitors—he has given prizes for two classes, light and dark. He has also given an extra class for foreign Rabbits.

We most heartily wish the undertaking success. We go with those who go with all classes, and our sympathies are with those who enable the schoolboy to show a Rabbit, and the artisan a Pigeon. Hundreds can show a pen of poultry who can enter into no other competition. The good that is done to a place like the Crystal Palace, or the Alexandra Park, is not to be meted by the increased attendance on the show days only (although that is remunerating), but by the fact that the pleasures of thousands become associated with the place, and the interest that attaches itself to the locality where a prize has been taken leads to many after-visits.

Places of public amusement that are open all the year can only be supported by the body of the people, and they must be propitiated by indulgence in their tastes and hobbies, when they are as harmless and amusing as a Poultry, Pigeon, and Rabbit Show.

RULES FOR POULTRY JUDGING.

I BEG to thank "EGOMET" for his kind remarks about my humble self. I own it is very agreeable to a man who means well to have his good intentions allowed. I now wish to say a few words concerning this fact, that there exists no code of laws by which the merits of poultry are decided. Let me put aside all thought of dishonest judges, if such exist, and speak only of what will apply to honest men. Let us suppose a few cases. Mr. A's idea of perfection in a Game fowl differs from Mr. B's; Mr. C prefers Turkeys of one kind, Mr. D those of another; Mr. E likes such a look provided Bantams are not too coarse; Mr. F abhors coarseness of all things, "Only avoid that," says he. Now, suppose these good gentlemen act as judges, one at one show, another at another, and so on, and the same exhibitors send to all the shows. The end is utter perplexity; a first here, none there, "commended" at this show, passed over at that, and so on. I have heard an exhibitor remark, "I do not know whether I shall take any prizes at this show, they depend upon who is the judge. Mr. A likes my sort of birds, but if Mr. B is judge I shall not have a chance." In this case let me add, that the judges and the exhibitors were wholly unknown to each other.

I think what we need in the poultry world is a set of rules for all shows, and less left to individual fancy. With rules in hand or head let each judge decide, and with rules in hand let each breeder select his birds for exhibition, then on each side perfection-point would be known.

Next. Where are we to get the rules? Those given at the end of Mr. Baily's book are not full enough. Why should not the Editors of this Journal publish a code? They, when issued, would, perhaps, lead to a discussion, but even if so, each succeeding edition would, as in rules of cricket, be an improvement on its predecessor.

In the "Poultry Book" issued at the office of THE JOURNAL OF HORTICULTURE, there are some points in each kind of fowl, &c., noticed. Here, then, is a beginning to start from. A twopenny pamphlet might contain all that would be needed, and be in every breeder's hands. I think these rules once issued would in time be accepted, gladly by judges I am sure; and then there would be no need, in the words of "EGOMET," "of each show publishing in its catalogue the particular points of the fowls in each class requisite to enable them to take a prize." This, then, is my suggestion. We want to know on all points what the standard should be in order to work up to that standard, and, too, the judges' standard should be ours.—WILTSHIRE RECTOR.

WOODBIDGE POULTRY EXHIBITION.

ALTHOUGH the meeting just closed constituted only the third annual show of the "Suffolk Poultry Society," it was carried out not only in a manner reflecting the highest credit on the management, but such as many other committees might follow as a model for their especial guidance.

The poultry exhibited were treated as well as the most anxious owner could desire, and quiet and comfort throughout the whole of them seemed the universal order of the day. It is also a matter of congratulation—as this is one of the

first, if not the very first show of the present season—that with one slight exception every pen was shown in first-rate health and spirits, and even in this one case not so ailing as to justify their removal. We hail this as good news to all intending exhibitors of the coming season, for the competition at Woodbridge last week not only embraced birds from most of the English counties, but even Scotland was well represented also.

It is well known to poultry-breeders that the latter end of May is invariably an inopportune time of year to show *Spanish* fowls to advantage, and so it proved at Woodbridge, condition being of necessity wanting. The three prize pens of birds were nevertheless very superior, though the class generally was defective.

In *Dorkings* any colour was admissible, consequently a very capital class—in fact, the best class in the Show—embraced dark *Dorkings*, Silver Greys, White *Dorkings*, and even the now almost extinct Cuckoo *Dorking*. As is invariably the case where all are good of their respective kinds, the Coloured *Dorkings* maintained supremacy, not without many commendations and high commendations being conferred, however, on the varieties that thus competed to so manifest a disadvantage. Mrs. Fergusson Blair, of Inchmartine, Scotland, gained the principal honour in this class with fowls very creditably exhibited.

The Buff *Cochin* class was very sparsely filled, but the winning birds were really good. The same remark applies equally to the class for Partridge-coloured *Cochins*, though this class proved far more extensive.

In the class for the White or Pile *Game* fowls, the latter colour took all the prizes, the White ones being rarely able to succeed in such competition; Mr. S. Matthew, of Stowmarket, Suffolk, taking the lead not only in this but again in the Black or Brown Reds, and also in the Duckwings. It was this gentleman's excellent pen of Black Reds that obtained the Society's silver cup (in lieu of a first prize), for the best pen of any kind of *Game* fowls exhibited; Mr. Fletcher, of Stoneclough, Manchester, with a first-rate pen of Brown Reds running in very closely. One of the best cocks in the Show was exhibited in this class (pen 39), but with a hen so utterly worthless, that a good chance (if entered in the single *Game* cock class) was entirely thrown away.

The good folks at Woodbridge seem quite disposed to encourage the *Brahma* class, and they as certainly did succeed in drawing together such a competition as can but rarely be met with, and such as it will be some time before we find again.

The *Hamburgh* classes were good, but these varieties always show to disadvantage just prior to moulting; and we may here digress to say, that with the solitary exception of a pen of White *Dorking* chickens, every pen of fowls throughout the whole collection were adults. It is generally supposed that with the ever-changing temperature this spring, the early chickens have, under the pressure of outward circumstances, given the go-bye to their owners (one by one) long since; consequently the show of January and February hatches at our few next shows will doubtlessly be more select than at one time anticipated. Chickens most undoubtedly bear even severe if constant cold, far better than sudden atmospheric changes.

The "Any variety" class was of great merit, a pen of wonderfully good White *Cochins* standing first, Indian *Game* second, and La Flèche third. Not only were these pens of unusual excellence, but the competition also embraced perfect Silk fowls, Crève Cœurs, Rumpless, and Malays. This class proved one of the gems of the Show. The sweepstakes for Single Cocks brought a very limited entry, as is now the almost universal rule, except at our largest meetings.

The white *Aylesbury Duck* class was the best of any of the Ducks, Mrs. Seamons taking her customary place of heading the list, in fact sweeping all the prizes.

Mrs. Blair, of Inchmartine, showed some marvellously good specimens of both *Geese* and *Turkeys*. They were perfect giants in their way; but a little more attention to matching the *Geese* for feather would be advisable.

In *Pigeons* all varieties competed for two general prizes; the first prize falling to a good pen of Black Mottled Short-faced Tumblers, and the second to Blue Powters.

The Abbey Grounds, at Woodbridge, are very suitable

indeed for the purposes of holding such a meeting, and we are glad to hear the Show was well attended throughout.

SPANISH.—First, A. R. Postans, Brentwood, Essex. Second, F. Crook, Forest Hill, London. Third, J. H. Cuff, Cattle Market, London.

DORKING (Coloured or White).—First, Mrs. E. F. Blair, Bathayock, N.B. (Coloured). Second, W. Syon, Debach, Suffolk. Third, H. Payne, Stowmarket. Highly Commended, J. Frost, Parham, Suffolk; S. Alexander, Woodbridge (white). Commended, H. Payne; H. Lingwood, Needham Market.

COCHIN-CHINA (Buff).—First, Mrs. E. F. Blair, Bathayock, N.B. Second, H. Lingwood, Needham Market.

COCHIN-CHINA (Partridge).—First, W. Bowly, Siddington House, near Cirencester. Second, J. Wright, Woodbridge. Third, Mrs. E. F. Blair, Bathayock, N.B.

GAME (White and Piles, Black and Brassy-winged).—First, S. Matthew, Stowmarket (Piles). Second and Third, Rev. F. Watson, Messing, Essex (Game Piles). Commended, S. Matthew (Piles).

GAME (Black-breasted and other Reds).—First and Third, S. Matthew, Stowmarket (Duckwing). Second, J. Fletcher, Stoneclough, near Manchester (Duckwing). Commended, S. Matthew.

GAME (Duckwing and other Greys and Blues).—First and Second, S. Matthew, Stowmarket. Third, R. Goodwyn, Woodbridge. Highly Commended, R. Goodwyn. Commended, E. Pettitt, Colchester, Essex; J. J. Hazell, Bromley, Essex.

BRAHMA PUOTRA.—First, Mrs. E. F. Blair, Bathayock, N.B. Second, R. White, Broom Hall Park, Suffolk. Highly Commended, J. Hinton, Ilinton, near Bath; J. Pares, Chertsey, Surrey. Commended, J. Wright; Mrs. M. Seamons, Hartwell, Aylesbury, Bucks.

HAMBURGH (Golden-spangled and Golden-pencilled).—First, Mrs. Pattison, Maldon, Essex (Golden-spangled). Second, Rev. T. L. Fellowes, Norfolk. Commended, J. W. Knight, Suffolk; Rev. T. L. Fellowes.

HAMBURGH (Silver-spangled and Silver-pencilled).—First, Rev. T. L. Fellowes (Silver-spangled). Second, Mrs. Pattison, Maldon, Essex. Commended, Mrs. E. F. Blair, Inchture.

ANY VARIETY.—First and Third, Mrs. E. F. Blair, Inchture. Second, P. Cother, Salisbury (Pheasant Malay). Highly Commended, Mrs. E. F. Blair; S. Catt, Ipswich; Mrs. Holland, Suffolk. Commended, W. Syon, Suffolk.

DORKING COCKS.—Prize, J. Frost, Suffolk. Highly Commended, H. Lingwood, Suffolk.

GAME COCKS.—Prize, E. Pettitt. Commended, S. Matthew.

COCHIN-CHINA COCKS.—Prize, Mrs. E. F. Blair, Inchture. Commended, W. Dowling, Woodbridge.

BANTAM COCKS.—Prize, Highly Commended, and Commended, G. Manning, Essex. Highly Commended, J. Wright. Commended, C. Wood, Suffolk.

GAME BANTAMS.—First, R. Goodwin, Woodbridge. Second, R. W. Allen, Woodbridge. Highly Commended, R. Goodwin. Commended, H. Payne, Suffolk.

SWEEPSTAKES.

GAME COCK.—First and Second, S. Matthew, Suffolk.

DORKING COCK.—Prize, H. Payne.

COCHIN-CHINA COCK.—Prize and Commended, G. Manning, Essex.

BANTAMS (Any variety).—First and Commended, T. Newson, Suffolk. Second, H. Girling, Melton, Suffolk.

DUCKS (White *Aylesbury*).—First and Second, Mrs. M. Seamons, Aylesbury.

DUCKS (Rouen).—First, Mrs. E. F. Blair. Second, J. F. Wigg, Woodbridge.

GEESE.—First and Second, Mrs. E. F. Blair, Inchture.

TURKEYS.—First, Mrs. E. F. Blair. Second, C. Capon, Suffolk. Highly Commended, R. Garrett, Saxmundham.

PIGEONS (Any variety).—First, H. Bunce, Walworth. Second, A. G. Alexander.

The Judge was Mr. Edward Hewitt, of Eden Cottage, Sparkbrook, near Birmingham.

DRIVING BEES AND PREVENTING THEIR SWARMING.

BEING on a visit to a lady on the 13th of May, I found she had a stock of bees in an old common bell-shaped straw hive. They were very strong, and hanging-out in large numbers. She did not want any swarms, but wished the bees put into one of my improved bar-frame hives. About the middle of the day, when large numbers of the bees were out collecting food, having placed an empty straw hive bottom upwards in a bucket, I lifted the stock upon it, and placed the bar-frame hive on the floor-board from which we had removed the stock. I removed the cluster of bees and placed them upon the floor-board, and then tied a cloth round where the two hives joined, and having carried them a few yards to a chair, I turned the stock-hive to the bottom and placed it upon my knees. We beat the hive at the bottom for about five minutes until we heard the bees had gone up. The stock-hive being placed in the bucket, I untied the cloth and found the bees had all gone up into the empty hive except about a score. I then carried the bees to the bar-frame hive, and having removed the cover, I struck the straw hive a smart blow or two, when the bees all fell out upon the bars, and soon ran down between, and I replaced the cover. We then proceeded to cut out the combs, and found them filled with brood and eggs in all

stages of development. We fastened them into my improved bar-frames, and found my wedge-shaped frames a very great improvement in fastening the combs. When we had done half of the combs we put them into the hive, and then cut the remainder out and placed them in the frames, and these into the bar-frame hive. When I cut the last comb out I found the queen surrounded by the score of bees that were left in the stock-hive. I caught her and placed her on the alighting-board, and she soon ran into the box. This shows that great care should be used in cutting out the combs lest the queen be left, and so get injured. In this case the bees had all gone up into the empty hive except about a score and the queen; but she generally is nearly the first to go up. I removed the royal cells and part of the drone brood, and the next day we placed a large bar-frame super on the stock, when they soon commenced to work; and the probability is, that no swarm will issue from it this year, and my friend will be able to take nearly four times the quantity of honey from them that she would have done had she allowed them to swarm, besides getting rid of an old straw hive.—WM. CARR.

CONVERSION OF BAR-HIVES INTO FRAME-HIVES.

Will you oblige me by saying if boxes with bars, which I call Taylor's, being 8½ inches deep including the bars, and 11½ inches square, would possess room sufficient to be worked on his plan if I were to attach frames to these bars? I have an excellent bee-house just adapted to hold nineteen of these boxes, and I could not make them larger without deranging the whole. I could make them a little deeper if that were necessary. My first swarm was on Saturday the 7th.—EDWARD FAIRBROTHER.

[If you deepen your boxes to 12 inches inside, and put eight frames in each at equal distances apart, they will form useful frame-hives. The top, bottom, and sides of each frame, should be three-eighths of an inch from the crown and floor-boards as well as from the sides of the box.]

PREVENTION OF SWARMING.

LAST summer a swarm of bees was given to me in a common straw hive, with a hole in the top. I did not put on a cap, nor take any honey. The bees seem now, as far as I can judge, strong and healthy. I want to prevent them swarming as I am away from home all day, and my garden being small I am fearful of losing the swarm.

In the recent articles on artificial swarms in THE JOURNAL OF HORTICULTURE I do not find what quite suits my case, the instructions being generally applicable to those who have more than one stock of bees, who have not common straw hives, or who can convey the hive with a driven swarm in it a mile or more away from the old hive.

I have been told that by placing an empty hive close to a full one, opening a communication between them, and stopping up the entrance of the old hive, so as to compel the bees to go in and out through the new hive, a colony will take possession of the latter when their old quarters become too crowded, and the two hives may afterwards be separated. This seems only natural to one who, like myself, knows nothing about bees; but before trying this, or any other plan, I should be much obliged if you would furnish me with a little advice in the matter. I am a complete novice in bee-keeping, and should not know the queen bee or a royal cell if I saw them.—S. E., Hampton Court.

[The plan you contemplate is the one described in page 80 of the last edition of "Taylor's Bee-keeper's Manual." The two hives should be placed side by side, the added hive and its entrance being put exactly in the place of the old one. Swarming may probably be prevented in this way, but in this case the stock will remain one colony, and on removing one of the hives in the autumn the queen and brood will most likely be found in the new apartment, so that the harvest will consist of dark honey deposited in discoloured combs. No means that can be adopted will at all times prevent the issue of a swarm.]

LIGURIAN BEES IN AUSTRALIA.

In the second annual report of the Acclimatisation Society of Victoria we find it stated that "As a contribution of very particular interest to the cottager, the introduction of the Ligurian bee may be adduced—that insect being, probably, from its industrious and wonderfully prolific properties, the most valuable in the world. This bee is multiplying with almost incredible rapidity, and will soon be accessible to all classes." It will be remembered that several colonies of Italian bees were successfully transmitted to Australia by me in the autumn of 1862. These were consigned to the Victoria Acclimatisation Society, and I need hardly say that the above assurance of their well-doing and rapid dissemination throughout the colony has been perused with much satisfaction by—A DEVONSHIRE BEE-KEEPER.

BEE-GLOVES.

WITH all due deference to editorial opinions, I must dissent from the reply to "F. H." in page 390 with regard to the efficiency of leather gloves for apiarian purposes. If thin and flexible, they are really no protection whatever; if thick, they render their wearer liable to all kinds of accidents by depriving him of the free use of his hands; whilst in either case they cause the death of numbers of unfortunate bees by leaving their stings in them. Although I now always operate in my own apiary with uncovered hands, I can speak from past experience as to the great superiority of photographers' indiarubber gloves. Not only are they sufficiently flexible to permit the apiarian to manipulate with freedom, but they spare the lives of his bees, which from some unexplained cause rarely attempt to sting them. These gloves are, I believe, sold at most indiarubber warehouses; if not, they may be obtained from Messrs. Neighbour & Sons, 149, Regent Street.—A DEVONSHIRE BEE-KEEPER.

[With all due deference to "A DEVONSHIRE BEE-KEEPER," we can only reply that we never used anything but kid gloves, and never were stung through them during our apiarian manipulations.]

BEEES ACCEPTING A FOREIGN SOVEREIGN.

THE letter under the above heading, which appeared in page 373, has produced so many applications for Ligurian queens, that I must beg permission to explain that the queen in question was one of the ordinary species, and that the attempt to supply Ligurian queens has long been abandoned by—A DEVONSHIRE BEE-KEEPER.

OUR LETTER BOX.

HEN WITH SORE BACK (*Cochin*).—No application to the wound is necessary. Remove the hen for a time from association with the cock, and the feathers will come again.

GRASS FOR POULTRY (*T. M.*).—Graze your land with sheep by all means. It is every way better for the fowls. There will be grass enough till next November to harbor insects; and fowls do not require high grass, as it is injurious rather than otherwise in wet weather.

CORNS IN COCHIN-CHINA FOWLS (*Cochin-China*).—We know no special reason why they should be so affected, unless the flooring of their house is a hard one. If it is, remove it. Sand or earth frequently stirred is the only fit flooring for poultry-houses. All heavy birds are very liable to have corns when they get old.

BULFINCH MOULTING DEFECTIVELY (*W. Barlow*).—Your bird has not had a sufficient change of food. Nothing but hempseed is terrible regimen. We would recommend you to give it canary and rape seed with a little hemp and lin seed; also, a bath every warm day. If it will not take it give it one through a small watering-pot. Continue this for two or three months. We doubt if it will moult its feathers before autumn; keep it in a warm corner. Are you sure that there are no lice in the joints of the cage, as they do not annoy the bird until night time?

LONDON MARKETS.—MAY 30.

POULTRY.

Trade has much improved, and the supply is below the average. Prices are maintained, but we doubt whether there will not soon be a reduction.

	s. d.	s. d.		s. d.	s. d.
Fowls	3	6	4	0	0
Smaller do.	3	0	3	6	0
Chickens	2	0	2	6	0
Geese	6	0	6	6	0
Ducklings	3	6	4	0	0
Pheasants	0	0	0	0	0
Guinea Fowls ..	0	0	0	0	0
Rabbits	1	4	1	5	0
Wild do.	0	8	0	8	0
Pigeons	0	8	0	8	0

WEEKLY CALENDAR.

Day of M th Week.		JUNE 7—13, 1864.			Average Temperature near London.			Rain in last 37 years.	Sun Rises.	Sun Sets.	Moon Rises.	Moon Sets.	Moon's Age.	Clock after Sun.	Day of Year.
		Day.	Night.	Mean.	Days.	m. h.	m. h.	m. h.	m. h.	m. h.	m. h.		m. s.		
7	Tu	Cocksfoot Grass flowers.	68.7	47.3	58.0	14	46 af 3	11 af 8	46	6	9	10	3	1 24	159
8	W	Brome Grass ripe.	70.1	47.1	58.6	14	46 3	12 8	50	7	35	10	4	1 12	160
9	Th	Meadow Clary flowers.	70.0	47.8	58.9	19	45 3	13 8	54	8	22	11	5	1 1	161
10	F	R. BROWN DIED, 1858.	71.2	47.5	59.4	17	45 3	13 8	57	9	2	11	6	0 49	162
11	S	Rough-stalked Meadow Grass fl.	71.8	48.4	60.1	12	45 3	14 8	0	11	43	11	7	0 37	163
12	SUN	3 SUNDAY AFTER TRINITY.	71.0	49.3	60.2	17	44 3	15 8	after.				9	0 25	164
13	M	Trinity term ends.	71.9	48.7	60.3	17	44 3	15 8	10	1	3	0	9	0 12	165

From observations taken near London during the last thirty-seven years, the average day temperature of the week is 70.7°, and its night temperature 48.0°. The greatest heat was 90° on the 7th, 1846; and the lowest cold, 34°, on the 9th, 1862. The greatest fall of rain was 1.48 inch.

LYCOPOD CULTIVATION.



LYCPODS are fitting companions for Ferns, and grow well under the same conditions of soil, shade, and moisture. They delight in a moist atmosphere, porous soil, and shade from bright sun.

The most suitable soil is turfy brown peat one-half, leaf mould one-fourth, and turfy loam one-fourth, with a little silver sand intermixed. This compost should be taken under cover a few days prior to potting, and should then be chopped with a spade, but not sifted, unless it be to free the peat and loam of the finer particles. It is scarcely possible to have the soil too rough, but it is best when the lumps are the size of a large walnut. Good drainage should be provided; and a layer of sphagnum, cocoa-nut fibre, or some such material placed over the

crocks materially aids in keeping the drainage open. The drainage should occupy one-third of the pot or pan, and on this should be placed 3 inches of compost, which will answer perfectly for such kinds as *Selaginella denticulata*, *densa*, *obtusata*, *brasilienensis*, and all those having creeping branches. For these nothing is so suitable as ordinary seed-pans 4 inches deep; but such as *S. africana*, *umbrosa*, *stolonifera*, &c., do best in pans somewhat deeper—6 to 8 inches being the most suitable depth; and a few are best grown in pots, as *S. paradoxa* and *lepidophylla*. All may be grown in pots, but dwarf plants look much better in pans. It is a common practice to grow these plants in pans 2 feet or more wide, which in my opinion is no improvement. A large patch of anything may be essential to gain a prize at an exhibition, but for decorative purposes one-foot pans well filled with finely-grown plants are quite large enough; and as these only occupy one-fourth the space, I consider four fine specimens of four distinct kinds more interesting than one large unwieldy panful of one kind. With Ferns and Lycopods it is preferable to have a great variety of kinds in character, than to have those huge masses which are only so many plants put into one pot; yet such carry the day everywhere, and against them those who cannot afford to put half a dozen Ferns in a pot or fifty pieces of Lycopod in a pan have no chance of competing. I think the time has arrived when it is desirable to limit the sizes of pots or pans in which Lycopods are shown at horticultural exhibitions, for it often happens that the prizes are given to those having the heaviest pocket and greatest convenience. Nice handsome young specimens are consequently passed over, and the prize awarded to

an enormous specimen made to appear young by putting a dozen young plants around it to take away its bad appearance.

For private establishments where these plants are grown for decorative purposes nothing looks handsomer than a fine collection of Lycopods grown in moderate-sized pans, 18 inches wide for the largest kinds—as *Selaginella Lyalli*, *Lobbi*, *inaequalifolia*, *africana*, *Wildenovi*, &c., which are of a Fern-like habit; twelve-inch pans for *stolonifera*, *Martensi*, *dichotoma*, &c.; and nine-inch for those that do not grow more than a couple of inches high. By this plan a number of varieties can be grown in a less space than it takes to grow a dozen monster specimens, which really take up more room than is sufficient for all the species.

In whatever way grown they should have light equally from all points, or they will draw towards the light: hence out-of-the-way corners are not proper situations for them; and to have them fine, compact, and strong in habit they should be placed about 18 inches from the glass, and not be kept in a close confined atmosphere, nor be made weak by too high a temperature.

March is the best time to repot them. This is a very easy operation. Have a clean pot or pan of the required size in readiness, place a large crock over the hole or holes, and on it an inch of sifted smaller pieces of pot if a pan is used, or one-third the depth of a pot, and on these place a thin layer of sphagnum or cocoa-nut fibre. Fill the pan with the compost already named, and with a large label, or some such appliance, take the plant or plants out of the old pan, and when this is done divide into pieces with a little root attached to each. With these before us on the potting-bench we have to consider whether the kind creeps, as *Selaginella densa*, *denticulata*, &c.; if so the pan must be covered with a little fine soil, and raised a little in the centre, but not too high, and holes made with the finger, and the plants introduced, so that they will be little, if anything, below the surface level. The plants should be evenly distributed over the surface, and the same distance from the edge of the pan as they are placed from plant to plant, so that the surface may be equally covered as they grow. If the kind has a branching habit, as *Selaginella stolonifera*, it is necessary to insert the divisions in the soil, so that some part of the stem may be covered, and the young roots placed in immediate contact with that which is to afford them support, placing about half an inch of fine soil over the surface around the plants after they have been inserted in the rough compost. Those that are placed on the surface and run over it should not have any soil placed over them; but after being planted as above they should be gently pressed with the hand, having previously sprinkled the surface with a little silver sand. Such species as *Selaginella umbrosa*, *S. Wildenovi*, &c., that have underground creeping stems, require to be planted like Ferns, with their creeping roots level with or a little below the surface, and in potting they should not be deprived of so much soil, nor be divided into such small pieces as those that emit roots from their branches or stems above the surface.

A little fine soil placed between the divisions, after planting, may be employed with advantage; but in no case should they be covered more than half an inch.

The plants of the respective kinds being potted, place them in their proper situations, giving a good watering, and shading from strong light, which is as common a cause of the plants flagging as bright sun. Dryness of the atmosphere being the bane of these plants at any time, it must be guarded against at this period, and a moist atmosphere insured by syringing the plants lightly morning and evening with water of the temperature of the house; and every available surface should be sprinkled with water twice daily—in fact, where Ferns and Lycopods are grown a moist atmosphere is at all times essential to their well-being. If convenience be at hand, it would materially assist the plants if they were placed for ten days or a fortnight after potting in a house with a temperature, and corresponding moisture, a few degrees above that necessary for each when established. Whilst the plants are making new roots or becoming established, the sprinkling overhead will be sufficient to keep them moist at the root; but when they begin growing water must be given copiously, it being next to impossible to overdo it; for, with good drainage and a porous soil, these plants would almost endure a stream of water running over them.

When established and beginning to grow more light and air should be admitted; but in giving the former it must not be admitted so as to dry the atmosphere much, or the plants will flag or become stunted in growth, and if the light is too powerful they become browned in the foliage and the growth is poor. About half the air given to greenhouse plants in general suits these, and after March whenever the sun shines a shading of tiffany should be employed over the plants from 8 A.M. until 5 P.M. From September to March they will bear the light of the sun without becoming browned; but whilst light browns the foliage, too little light causes a weak unnatural growth, and is as carefully to be guarded against as too strong a light. It is the extreme of the two that is to be avoided, and any person with a little experience will soon understand how and when to shade, or admit more light and air.

These plants should be kept well supplied with water, but it is not necessary to water them so long as the soil remains moist, for nothing is gained by treating them as aquatics, but the soil becoming sour and sodden will sooner or later cause a sickly condition of the roots, and the leaves are not long ere they show unmistakable evidence of bad health. In summer, from March to October, they should be sprinkled overhead twice daily—very gently at night, to imitate the falling dew, and in the morning to supply the moisture necessary to keep them moist during the day. In winter it is only necessary to syringe the plants in the morning, and not then if the house is moist, and the soil in a healthy moist condition; but if fire heat be employed to keep up the required temperature, the plants if in a greenhouse should be sprinkled overhead in the morning, or if in a stove twice daily, for dryness from fire heat is more injurious to these plants than anything I know of. In autumn a little fresh soil may advantageously be placed between the stems of the plants, which will much invigorate them; but it should be done so that no trace of such an operation may be seen.

The most suitable situation is a fernery, but where this is not at hand some of these plants may be grown very well, in the greenhouse, in the shadiest part; and the stove varieties do well in summer under the shade of Vines, and may be wintered in a stove or warm greenhouse with the thermometer seldom below 45°.

Though I have given the essentials necessary for the cultivation of these ornaments when it is desired to have them very fine, yet those having a shady place in a stove or greenhouse may succeed tolerably well, whether the plants are grown in pots or pans, or planted out in rockwork, or, otherwise, associated with Ferns in baskets. They will, indeed, grow almost anywhere, and they have charms which no other plants possess wherever placed, yet they must not be expected to do so well in such situations as if they were grown in places more suitable for them. For surfacing some of them are really indispensable, and for making something very beautiful of what is otherwise very ugly, we have one specially adapted for the purpose. I allude to the ugly

walls of some ferneries that are out of all character with the appearance of such houses. To make such ornamental provide some strong galvanised wire netting, inch-mesh, and fasten this at the lowest point of the house with tenter hooks galvanised. The upper edge should also be made fast with the same description of hooks, but only driven so as to allow the netting to be 1 inch from the wall required to be covered. There will thus be a cavity between the netting and the wall an inch wide, which is to be filled tightly with peat and sphagnum in equal parts, and to prevent the wire bulging out more hooks must be driven into the wall to keep it in its place. The netting may be carried to any height, and be made to fit into corners by fastening more netting on with small copper wire. When the interval between the netting and the wall has been filled with compost we have to force some fresh sphagnum between the meshes, and it should be done so that the wire may be covered, and the whole present an even surface of moss—a moss wall, of course it will be when finished.

We next make holes with the finger between every third mesh of the netting, and introduce a small piece of *Selaginella denticulata* into each, and fill the hole or cavity left with a little sphagnum. The plants or divisions are planted in straight lines 3 inches from the bottom, and the same distance from plant to plant in the rows, and a like distance from row to row, arranging them in quincunx fashion. We have now provided for a surface of the loveliest green, and will improve the same by dotting a few Ferns up and down it, and some stiff yet graceful-habited Lycopods. The Ferns most suitable are such kinds as *Pleopeltis stigmatica*, *P. nuda* (Fortuni), *P. pustulata*; *Pteris serrulata*, *P. scaberula*; *Platyceium albicoeruleum*; *Nipholobus prupestris*; *Nephrolepis exaltata*; and *Cyrtogonium flagelliferum*. The last-named bears small plants along the fronds, and a large one at the rat-tail points of the fronds which root in the moss, themselves again producing fronds of a like nature, and soon covering a wall when once well established, and this renders it one of the most curious Ferns in cultivation. There are, indeed, so many Ferns suitable for such situations which have either creeping stems or will thrive in a small quantity of soil, that any one with a little judgment will not fail to find subjects. I may, however, further note, that a *Stenochlaena scandens* or two planted at the foot of the wall, and a plant of *Selaginella levigata* (but it requires a stove), will soon commence ascending, and are really beautiful; and if a plant of *Goniophlebium* be placed at the top, about 1 foot from the glass, its splendid wavy fronds will droop to the extent of 6 to 10 feet; and thus, with the carpet of *Selaginella denticulata*, various branching Lycopods and Ferns peeping from its surface in all directions, we have one of the handsomest things conceivable. Then for covering iron tie-rods in span-roofed houses, or for surfacing out-of-the-way places anywhere, forming margins to walks in glass houses, no other plant adapts itself so well to circumstances as *Selaginella denticulata*. To hide a rod of iron first cover it with sphagnum and make it fast with copper wire, then wreath it with pieces of the plant named, fastening them with matting. If something extra be desired fasten a few plants of the Killarney Filmy Fern (*Trichomanes radicans*), upon it, and if these be kept sprinkled with water twice or thrice daily so as to keep them continually moist, and the wall also in like manner syringed morning and evening, or watered always from the top downwards so as to keep it and them in a thoroughly moist condition, we have a little ornamentation in addition to that generally seen in ferneries.

The majority of Lycopods are suitable for a greenhouse temperature; but as such structures are ventilated too much, and are neither shaded sufficiently nor kept moist enough for them, it sometimes occurs that the plants become stunted in habit, and browned for want of shade. Those having a viney will find the extra heat, shade of the Vines, and copious syringings admirably adapted for the greenhouse kinds generally, and if they be kept there until the Grapes change colour they will be in fine condition according to the attention bestowed, and for the sake of themselves must then be removed to their proper quarters. The stove kinds do well in a viney in summer, and may be wintered safely in a temperature of 45° to 50°, otherwise they do not

do well without stove heat. Many kinds are lost under cultivation by inattention to providing the proper temperature for each, and to obviate this I append a list of a few distinct species. Those marked with an asterisk do well in Wardian cases; G signifies that the kinds require the protection of a greenhouse; whilst S are stove; and the sign † indicates those that do well in unheated ferneries or are almost if not quite hardy. The figures indicate the height in feet of each, unless of prostrate habit or otherwise not easily determined.

SECTION I.—*Lustrous metallic blue-shaded foliage.*

**Selaginella uncinata* (cassia of gardens), long wiry stems, nearly prostrate, much branched, and clustering; leaves light blue. A handsome kind. 1½ foot (G.).

S. *laevigata*, a magnificent climber (S.).

S. *inæqualifolia*, erect stems, supporting medium-sized variable fronds; not unlike an *Arbor Vitæ* foliage, but of a blue colour. 1 to 1½ foot (S.).

SECTION II.—*Green and succulent in texture, erect in habit, the branches close and compact, roots being emitted from them which become plants.*

Selaginella formosa, thick close habit, forming a handsome massive specimen. 1 foot (G.).

S. *stolonifera*, the type of the group. Fronds small, nearly heart-shaped, much branched, and spreading. 1 foot (G.).

S. *flexuosa* (*dichotoma*), fronds small and much branched; the points being pale it has a spunged aspect. 1 foot (G.).

S. *microphylla*, dense habit, but slender; pretty, and very distinct. 6 to 9 inches (S.).

S. *Martensii*, erect close habit, little, if anything, different from S. *stolonifera*.

S. *Pæppigiana*, branches broad, close, and curving down to the soil; dry though succulent-looking-texture; colour grass green. This kind is difficult to keep in winter, and should be frequently potted, as it is impatient of a soddened soil. 3 inches (S.).

S. *serpens*, light green, handsome; habit dense and compact. 9 inches (S.).

SECTION III.—*Prostrate, green fronds, of succulent texture, and humble growth.*

**Selaginella jamaicensis* (*mutabilis*), prostrate, fast-spreading stems, with small leaves. This is remarkable for the various colours it assumes: in the morning it is bright green, at night whitish or yellowish at the points of the branches, and green in other parts, giving it the appearance at dusk of phosphorescence (S.).

*S. *densa*, forms a pigmy patch of crowded slender stems and small leaves (G.).

S. *brasiliensis*, leaves thickly set; long, slender, wiry stems; close and prostrate habit; little differing from S. *denticulata*. 3 inches (G.).

*†S. *denticulata*, everybody's favourite; it will grow in all soils and temperatures; almost, if not quite, hardy. 6 inches (G.).

*†S. *helvetica*, simply a less form of the preceding, in comparison to which it is but a pigmy (G.).

*S. *Burghallii*, prostrate, pendant, branching stems, light green leaves, with white tips, and flat; very pretty (G.).

*S. *apus* (*apoda*), a gear, of moss-like habit, very dense (G.).

*S. *delicatissima*, and so it is—delicate and pleasing. An exquisite pigmy (S.).

S. *increscentifolia*, an annual. The soil should be left undisturbed, and it reappears the following summer. Curious and pretty (S.).

SECTION IV.—*Creeping wiry stems, erect stalks, Fern-like fronds, and of dry texture.*

Selaginella Lyallii, fern-like, distinct, and handsome. 1½ foot (S.).

*S. *viticulosa*, wide, triangular, drooping, plummy fronds, rising plentifully from underground stems. 6 inches (S.).

*S. *fabellata* (*plumosa*), handsome, fronds triangular and drooping. 9 inches (S.).

*†S. *Willdenowii*, much-divided triangular fronds, on long wiry stems. A fine, spreading, drooping kind. 1½ foot (G.).

*S. *erythropus* (*umbrosa*), close compact habit, triangular and elegantly divided wide green fronds; fine. 1 foot (S.).

*S. *dichrous*, nearly related to S. *erythropus* at first sight, yet very distinct from it. Fronds overlapping, appearing undivided. Very beautiful. 1 foot (S.).

S. *africana*, four-inch wide, triangular, much-divided fronds, having a blue metallic lustre. 1 foot (S.). (In habit this belongs to this group, otherwise its proper place is Sec. I.)

SECTION V.—*Brown or red-tinted.*

Selaginella rubricaulis, leaves small, habit close and compact, stems and branches rich coral red, points of the branches whitish, divisions bright green; fine. 6 inches (S.).

S. *rigida*, rich brown purple in summer, changing to a variegated state in winter; fine. 1 foot (S.).

S. *Galeotti* (*Schottii*), straggling spare habit, stems brown, leaves green, prostrate-growing. 1½ foot (G.).

SECTION VI.—*Fronds rising from a crown or centre.*

Selaginella lepidophylla, a small handsome kind; fronds bright green, radiating horizontally from the centre, growing profusely and close. It is seldom seen in good condition, and then it is not more than 6 inches in diameter (S.).

*S. *euspidata* (*circinalis*), small, long, much-branched fronds, forming a bird-nest. It gets out of character in heat. 9 inches (G.).

*S. *elongata* (*cordifolia*), a dwarfier form of the preceding, but very elegant. 6 inches (G.).

S. *paradoxa*, nearly prostrate in habit, deep green fronds, the points minutely branched and clustered, which gives the plant a viviparous appearance; fine. 6 inches (S.).

G. ABBEY.

THE ROYAL HORTICULTURAL SOCIETY'S SHOW.—JUNE 1ST AND 2ND.

THIS Show was much the same as its predecessors at the Regent's Park and the Crystal Palace, both as regards the plants exhibited and the extent of the display. Being held partly in the conservatory and partly in the two adjoining arcades, the fronts of which had recently been glazed to adapt them for the purpose, it did not appear so extensive as it really was; whilst from being thus cut up into three or, rather, four portions, its effect as a whole was inferior to that of the shows already referred to. Notwithstanding that the day was fine and that their Royal Highnesses, the Princess of Wales and Prince Arthur visited the Exhibition between one and two o'clock, the gardens were by no means overcrowded with visitors.

STOVE AND GREENHOUSE PLANTS.—Among these a fine collection of fine-foliated and flowering plants came from Messrs. Veitch in competition for the Duke of Buccleuch's prize, which they took. It contained a gigantic *Dicksonia antarctica* in the centre, flanked on each side by *Croton variegata* and *pieta*; *Ixora amboinensis*; *Pandanus reflexus*, with its beautiful deep green reflexed foliage; *Alocasia macrorhiza variegata*, with its conspicuously splashed leaves; *Allamanda cathartica*, with very large flowers for that species; *Latania borbonica*, *Dipladenia crassinoda*, and others. The prize offered by the Council for the second best collection of the same kind was taken by Messrs. Lee, of Hammersmith, with *Alocasia Lowii*, *Theophrasta imperialis*, *Cordylone indivisa*, a very fine *Ixora coccinea*, and other plants, most, if not all, of which have been noticed as having appeared at previous exhibitions.

Among the plants in flower were fine examples of *Ixoras*, *Pinneleas*, *Dracophyllum gracile*, *Hederosas*, *Stephanotis floribunda*, *Pleroma elegans*, *Rhynchospermum jasminoides*, *Apulexes*, *Ericas*, and *Epacris*. For twelve, Mr. May, gardener to J. Spode, Esq., Hawkesyard Park, took the first prize; Mr. Peed, and Mr. Morse, gardener to F. Canning, Esq., Westbury-on-Trym, Bristol, second prizes; Mr. Green, gardener to Sir E. Antrobus, Bart., the third.

In the Nurserymen's Class for twelve, Mr. Fraser, Lea Bridge, was the only competitor and took the first prize. He had among others a large plant of *Prostanthera lasiantha* in fine bloom, fine specimens of *Phœnoconna proliera* and *Boronia serrulata*, and an immense *Epacris grandiflora rubra*.

In collections of six, Mr. Chillum, Ashtead House, was first; Mr. A. Ingram, gardener to J. J. Blandy, Esq., Reading, second; and Mr. Page third. In the Nurserymen's Class for the same number, Mr. Rhodes, of Sydenham Park Nursery, had the first prize, as he also had at the Crystal Palace in the corresponding class. Messrs. Jackson were second, again showing their beautiful *Clerodendron Thomsoni*.

AZALEAS.—For nine plants Mr. Turner, of Slough, was first. These were immense plants, nearly 6 feet high, and densely covered with bloom. The kinds were *Juliana*, *Sir C. Napier*, *Criterion*, *Chelsoni*, *Gledstanesi*, and *Gledstanesi formosa*, *Arborea purpurea*, of dazzling brightness, *Gem* and *Perryana*. Messrs. Veitch's plants, which took the second prize, were also without exception very fine; *Empress Eugénie*, a beautiful bright rose, was particularly remarkable. The other kinds were *Iveryana*, *Magnificent*, *Stanleyana*, *Juliana*, *Extranei*, *Ardens*, *Rosea superba*, and *Perfecta elegans*. The Amateurs' collections were generally much inferior to those of Messrs. Turner and Veitch. For nine kinds Mr. Morse was first, Mr. Carson second, and Mr. A. Ingram third. In the Open Class for six, Mr. Turner was first, and Mr. Penny, Regent's Park, second. For three new kinds sent out in 1862 and 1863, Mr. Turner had a first prize for *Elegantissima*, white, flaked with red; Charles Enke, rose, edged with white; and *Advance*, rosy lilac, dark crimson blotch. Mr. Turner also took the prize for the best three in six-inch pots; and for the limited space the plants had to grow in these were marvellous plants, both as regards their size and profusion of bloom. *Duchesse Adelaide de Nassau*, violet crimson, was especially fine; the other two were *President* and *Flower of the Day*.

CARE HEATHS made but a limited display, and the kinds were the same as on previous occasions. Mr. Rhodes was first, and Mr. Peed second, with fine bushy specimens.

ORCHIDS were placed in the conservatory, and, being extensively shown, had an excellent effect, though, from being to a great extent arranged according to their genera, there was not that variety which mixed collections present. In the Class for *Ærides*, *Vandas*, and *Saccolabiums*, six kinds. Mr. Baker, Stamford Hill, took the first prize, with *Vanda tricolor* and *suavis*, two fine plants; the beautiful *Ærides crispum*, with five spikes; *Saccolabium retusum* and *curvifolium*, and *Ærides virens*. Mr. Penny was second, with *Vanda suavis* and *Roxburghii*, *Ærides Warneri*, *Fieldingii*, *affine roseum*, and *Saccolabium guttatum*. Mr. Milford was third with *Vanda suavis Veitchii*, *Vanda tricolor*, fine, and the beautiful *Ærides Lindleyana*, &c.; and the same exhibitor took a first prize for *Cattleyas* and *Lælias*, with *Mossia*, very fine; *lobata*; the hybrid *Dominiana*, and *Lælia purpurata* and *cinnabarina*.

For *Cypripediums* and *Uropediums* Mr. Penny was first, with the new *Cypripediums Stonei*, *Lowii*, and *Hookeri*, the latter remarkable for its beautifully variegated foliage. Mr. Milford was second, and Mr. Baker third. In the Amateurs' Miscellaneous Class, for nine kinds, the prizes were taken by Messrs. Milford, Baker, Penny, and Wilson of Enfield; and in the corresponding class for nurserymen, by Mr. Williams, Messrs. Jackson, and Mr. Woolley, in the order in which they are named. Among these exhibitions we remarked fine examples of *Vanda tricolor*; *Dendrobium nobile*, *macrophyllum giganteum*, and *Dayanum*; *Anguloa Clowesii*; *Cypripedium villosum*, with nineteen blooms; *caudatum*, with ten very fine flowers, the tail-like appendages of which were nearly 2 feet long; the Foxbrush *Ærides*, with a spike 20 inches long; *Lælias*, *Cattleyas*, *Phalenopses*, &c. In the Miscellaneous Class for six, Mr. Page was first; Mr. Penny, second. *Dendrobium primulinum*, from the latter, with flowers springing from every joint, had a pretty, though somewhat formal, appearance.

PITCHER-PLANTS.—Prizes were offered for *Sarracenias* by Lady Dorothy Nevill, and the result was that a few of these remarkable plants were exhibited. The first prize was taken by Mr. Baines, gardener to H. Nicholls, Esq., Bowden, with *flava*, *variolaris*, and *purpurea*, the latter having large purple-veined pitchers; the second and third by Mr. J. Veitch and Mr. Williams with the same kinds. For three Pitcher-plants, not being *Sarracenias*, Mr. Veitch had a first prize, the kinds being one of Mr. Dominy's hybrids, *Nepenthes Rafflesiana*, and an unnamed species with small pitchers.

MISCELLANEOUS.—In this class, usually so large, there were few exhibitions, most of the objects with which it is swelled being provided for elsewhere. By far the most interesting contribution was a beautiful basket of Alpine plants arranged among rockwork, sent by Messrs. Backhouse, of York. Many of them were very rare as well as very beautiful, and the whole must have delighted the eyes of the lovers of these pretty but seldom-seen plants. Among them we remarked *Gentiana verna*, *Cypripedium calceolus*, *Goodyera pubescens*, *Ophrys apifera*, *Myosotis alpina*, *Dianthus alpinus*, *Saxifraga Hirculus*, and *Primula denticulata*, &c. For these Messrs. Backhouse had a second prize, and a similar award was made to them for a group of North American *Osmundas*. Messrs. Barr & Sugden took the first prize for plant cases of different forms, and variously filled. One case, filled with Cacti, attracted much attention on account of the novelty of these plants being employed in this way. Messrs. Ivory & Son had also a prize for a collection of fifty British Ferns. *Asplenium lanceolatum microdon*, a very handsome and scarce variety; *Blechnum spicatum imbricatum*; *Athyrium Filix-femina plumosum*, with beautifully divided fronds; the rare *Lastrea Nowelliana*, *Osmunda regalis cristata*, *Polystichum angulare sub-tripinnatum*, and *cristatum*, were a few of the most remarkable. Prizes were also offered to ladies for single plants grown in a drawing-room, and strange to say the only exhibitor was Mrs. Dombain, of Deal, who sent a nice healthy plant of *Adiantum cucumatum*, in a wire basket. It had been growing in a living-room where both gas and fire were used since last August. Further details respecting its treatment will be found at page 195 of our present volume. Although three prizes were offered for the best-arranged group for decorating a small conservatory or greenhouse, only one competitor came forward—namely, Mr. Turner, of

Slough, but his arrangement was of such merit that a first prize was awarded.

Florists' flowers, floral decorations, and Floral Committee subjects will be noticed in separate reports.

THE AMERICAN SHOW of Messrs. Waterer & Godfrey filling an immense tent 350 feet long, by 150 feet wide, was a blaze of bloom. A standard *Roseum elegans* could not be less than 8 feet in diameter, in fact it was a tree. Of new kinds we remarked Mrs. W. Bovill, a fine, bright, rosy crimson; *Beauty of Surrey*, crimson, distinct dark spots; *Old Port*, mulberry crimson; *Lady H. Crossley*, rose; and Mrs. John Clutton, a beautiful pure white, of fine form.

FLORISTS' FLOWERS.

COMING immediately after the Royal Botanic and Crystal Palace Exhibitions, it must necessarily happen that many of the flowers, sent as they are by the same exhibitors, should be the same as those at the former Shows; yet, although in some classes exhibiting a great falling-off, there can be no doubt as to the general excellence of the Exhibition. There was enough there to suit all classes of amateurs and all lovers of flowers, and marvels of growth and beauty many of them were; but I only repeat that which I believe hundreds expressed—that the Exhibition owed everything to the plants and nothing to their arrangement. Improvements have indeed taken place: the bare walls of the arcades have been distempered with a warm shade, and the front openings have been glazed, thus securing a freedom from cold winds. But with all this there was only a side light, and this is as bad for flowers as for pictures; and the bare stages without any green baize covering were a great eyesore, and certainly did not tend to set off the *Pelargoniums*, *Roses*, &c., with which I have more specially to do.

Most notable was the absence of amateurs amongst *Pelargonium*-growers. Where were Mr. Nye and Mr. Bailey? Where those splendid plants exhibited at the Botanic? and was the second-rate collection of Mr. Wiggins all that the amateurs of *Pelargoniums* in the neighbourhood of London could do? Or was it the two-days exhibition which frightened them? Or is there a screw loose somewhere?

In the Nurserymen's Class there were but two exhibitors—Mr. Fraser and Mr. Turner; the latter coming down from his high pedestal and being second in both Classes, but bearing his defeat without imputation on the Judges, as is too often the case, and acknowledging the fault was with himself. Mr. Fraser's twelve of large-flowering sorts were *Osiris*, *Sanspareil* (two splendid plants), *Bacchus* and *Pizarro*, *Empress Eugénie*, *Rose Celestial* (fine), *Viola*, *Candidate*, *Lord Clyde* (somewhat thin of flower), *Mr. Marnock*, *Desdemona*, and *Etna*. Mr. Turner's were *Fairest of the Fair*, *Rose Celestial*, *Symmetry*, *Lucifer* (very bright and beautiful), *Prince of Prussia*, *Nestor*, *Lilacina*, *Beadsman*, *Lady Canning*, *Etna*, *Desdemona*, and *Candidate* (very fine).

In Fancies Mr. Fraser was also first with fine plants of *Reliance*, *Delicatum*, *Multiflora*, *Hebe*, *Clara Novello*, and *Cloth of Silver*. Mr. Turner was second with *Lady Craven*, *Ellen Beck*, *Mrs. Reynolds Hole*, *Edith*, *Clemanthe*, and *Cloth of Silver*.

In Amateurs Mr. Wiggins was, as I have said, the only exhibitor; and the only noticeable plant in his collection was *James Lodge*.

Roses in pots were well shown; and as I have said before, the plants exhibited by Mr. Wm. Paul and Messrs. Lane are great improvements on the overgrown monsters of former years. They were bushes, and in some instances very beautiful ones. Mr. Wm. Paul's were *La Reine*, *Madame Willermoz*, *Anna de Diesbach* (with some very large pæony-looking flowers), *Charles Duval*, *Juno*, *Lælia* (very large and beautiful), *Lord Raglan* (in fine condition), *Oriflamme de St. Louis*, *Niphotos*, *Bougère*, *Madame Domage*, and *Triomphe des Beaux Arts* (the only ineffective plant in the collection). Messrs. Lane's were *Jules Margottin*, *Charles Lawson* (very fine and beautiful), *Coupe d'Hébé*, *Triomphe d'Elise*, *Paul Perras*, *Paul Ricaut* (very fine), *Madame Damaizin*, *Louise Peyronney*, *Général Jacqueminot* (very fine), and *Baronne Prevost*.

Of *Roses* in small pots there were some real beauties. Mr. Turner was first with *Victor Verdier*, *Senateur Vaisse*,

La Reine, Prince Camille de Rohan (very dark and curious), Beauty of Waltham (with some fine flowers), and Louise Odier. Messrs. Paul & Son were second with Souvenir de la Reine de l'Angleterre, Général Jacqueminot, Cardinal Patrizzi, Professor Koch, Lord Raglan, and Anna de Diesbach. Both of these collections were excellent; the plants symmetrical, foliage bright, and flowers good.

In six Teas Messrs. Paul & Son were the only exhibitors. Their set comprised President, Marquise de Foucault, Homer, Niphetos, Julie Mansais, and Souvenir d'un Ami—all very pretty, but too little variety of colour to make a pleasing group.

The only collection in pots from amateurs came from Mr. T. Terry, and contained moderate plants of Charles Lawson, Chénodolé, Sylph, Devoniensis, Paul Perras, and Paul Ricaut.

Of Cut Roses, twelve boxes shown by Mr. Turner, and I believe the firstfruits of the open air, contained some very magnificent blooms of well-known varieties. Madame Furtado, Grand Prince Noir, Baronne Hallez, Le Rhône, Prince Camille de Rohan, Turenne, Lord Raglan, François Lacharme, John Hopper, Madame Villermoz, Madame Place, Abd-el-Kader, Eugène Appert, Mademoiselle Bonnaire, Anna Alexieff, Victor Verdier, Sénateur Vaisse, and others were in great perfection. Messrs. Paul & Son had also a large collection, but they looked pale alongside of their more brilliant out-of-door companions.

In seedling Pelargoniums I noticed John Hoyle, described in the account of the Crystal Palace Show; British Sailor, ditto; Mary Hoyle, soft rose colour, dark spot, and white throat; Pretty Mary, dark cherry, white throat, a little rough; Profusion, purplish rose, very free bloomer; Sunny Memories, smooth, with white throat; Leonidas, second-rate; Violetta, washy; Exhibitor, a very free bloomer, and a capital market plant.

In Fancies there was Ann Page, bright cherry, and very good; also Blair Athol, rough; Juliet, rough; Silver Mantle, rather too light and rough.

Of the three best Pelargoniums of last year Mr. Turner was first with Aristides, Diadem, and Philo, all good plants.

In Zonale Pelargoniums there was nothing in any way remarkable. Mr. Bull's Eve promised well as before, and all were pretty, but not better than those now out; and the marked absence of Messrs. E. G. Henderson & Son made a great blank in this now very popular class.

Messrs. Downie, Laird, & Laing exhibited some fine Pansies, both Show and Fancies. The box of the former contained Lord Clyde, Miss E. Cochrane (a smooth and beautiful pure white ground flower), Chancellor, Prince of Prussia, Isa Craig, Mr. T. Scott, Mr. J. Martin, Invincible, Francis Low (good), Princess of Wales, Miss Carnegie, Attraction, Reine Blanche, Eclat, Lavinia, Cherub, Telegram, Serena, Mary Lamb, Alexander McNab, C. W. R. Ramsay, and Alice Downie. Mr. Hooper also exhibited some good flowers.

TABLE DECORATIONS.

The entries for the prizes offered by Sir Wentworth Dilke were numerous, and exhibited every variety of taste, from the purest to the most vulgar. How any one could have got up some of the abominations, called decorations, I cannot conceive, when we have seen what has been done in former years. The exclusion of birds, beasts, and fishes, tended greatly to the purity of taste, and set the exhibitors on a more legitimate way of filling their stands. The first prize was, I think, most deservedly given to Mrs. Worthington Bliss, of 26, Eccleston Square, for a stand of three, in which most thorough artistic taste was exhibited, combined with a genuine appreciation of colour. The centre consisted of a tall glass with arms, from which hung small glass baskets. The bottom plateau had Roses all round, with some bunches of Grapes in the centre, and a bloom of the white Arum, while dotted over the stand were Lilies of the Valley and Adiantums, &c. The base of the side stands was surrounded with alternate bunches of Corn-Flowers and yellow Azaleas, with some red Cherries in the centre, thus completing the primary colours on a green base. I am quite sure that an artist's eye had something to do with this. The second prize was given to Miss March. It seems heresy to question this lady's taste; but considering the time of year for which these decorations are most needed, that the season is during

the bright and sunny months, I would venture to say that I thought it too dark and heavy for the object in view. Had it been for autumn, it would have been more in accordance with the season. The dark Begonia leaves were somewhat out of keeping; something lighter would have set off the Grapes better. Miss Wint, of 8, Gloucester Terrace, South Kensington, was third. Her stand consisted of glass stands, with three glass cornucopias, in which flowers were placed. Roses decorated the base, and Fern leaves were laid all round, as in Miss March's original plan. Lady Holmesdale's group was highly commended. Some of us thought it ought to have had a higher position. The centre was a glass plateau, with three glass vases, and three glass shells on it. These had Geraniums, Ferns, &c., placed in them, and fruit and flowers were intermixed. The side ones had no fruit. Mrs. James Cuthbush's was also in excellent taste, there being for the top of the stand branches arranged with four pendants, and the arrangement of the flowers was excellent. Lady Emily Peel's was also commended, but I thought the white lace was a sad violation of good taste. It is impossible to give any correct notion of these decorations without a more detailed description, than it would be possible to give in a short report. There was considerable departure from the original design of Miss March, which set everybody into that groove, and, perhaps, if the prizes are continued something more novel still may be thought of. It is evident from even those set up that good taste is not universal.—D., *Deal*.

FLORAL COMMITTEE, JUNE 1.—The florists' flowers and new and rare plants exhibited were more numerous than usual, and occupied much of the time of the Sub-committees appointed to examine them. Among the florists' flowers seedling Pelargoniums prevailed, which, though numerous, presented but little novelty and improvement. The Scarlet Pelargonium section was numerous represented; among them were some very nice flowers, but not equal to many well-known varieties in cultivation. Had they made their appearance four or five years ago, they would have doubtless been highly appreciated. The imported French and Belgian varieties are now so beautiful both in form and their varied shades of colour, that it requires something specially good to beat them, and we fear we have already far too many flowers of the same or nearly the same shades of colour.

Mr. Bull sent several seedling Scarlet Pelargoniums, as Glitter, Umpire, Fanny, Eve, Snowflake, and Vivid. This last was worthy of its name as to colour, but one of those delicate-petalled flowers which scorch when exposed to the sun. It might be as well to change the name of this seedling, as there is already an old and excellent variety under the same name.

Messrs. Downie, Laird, & Laing, sent seedling Pelargoniums which seem rather to have receded than advanced in their properties and quality. They were Nelly, Princess Alice, Harry (not equal to Roi de Feu), Julia, Helen, Countess Russel, Lilac, Model, Emma, and Peter Barr. The last was remarkable for its dark spots on dull pinkish petals; not effective nor useful. When we have noticed the extraordinary strong growth of these seedlings we can say no more for them.

Mr. Hill, Harrow Road, had a seedling Verbena, Miss Lee, but there was nothing to commend this seedling, not even its unnatural growth as a standard; also, Fuchsia Flower of the Day, known as Aucubæfolia.

From Mr. Halley, Blackheath, came seedling Scarlet Pelargonium Enamel, of the Zonale division, too much like but not equal to Blackheath Beauty; Princess of Wales, a variegated seedling, foliage nicely zoned, with clear white edge like Fontainebleau and many others.

Mr. Allen, Hammersmith, sent Azalea The Baron, a white, thin, badly-formed flower; and Mr. J. Woods, Esher, Scarlet Pelargonium Comtesse de Paris, a rosy salmon flower, not new nor equal to many others.

From Mr. C. Southey, Clapham, came Petunia multiflora, light crimson purple with white stripes—no other merit than freedom in producing its flowers; and from Mr. Holland, Spring Grove, Petunia Striata purpurea, a pretty and promising flower; the plants were small, and not in condition to display its merits. It is desirable this plant should be seen better grown. Scarlet Pelargonium seedlings, Fanny

Alice Peake, Roseum, Rosalie, none of them equal to others in this section, were also exhibited by Mr. Holland.

Mr. Groom, Ipswich, sent Scarlet Pelargoniums Sir Fitzroy Kelly, a pretty light scarlet flower, but not distinct from others; Miss Martin; and Brilliant, a bright scarlet loose-petalled flower.

Mr. Turner, Slough, had Fancy Pelargonium Mrs. Dorling, dark rosy carmine upper petals, lower petals white, slightly tinted with carmine; good truss. It received a second-class certificate. Also, Arcadia, Juliet, Blair Athol (flowers dark ruby red; the plant had passed its prime, the flowers were fading; this seedling has some merits), Silver Mantle. Ann Page, from the same, was a very distinct and pleasing variety, the best we should say of its class; medium-sized flower, upper petals bright rosy carmine, lower petals lightly shaded. A first-class certificate was awarded for it.

Mr. G. Hoyle, Reading, exhibited several seedling Pelargoniums of his well-known and beautiful strain, but it was difficult among these good flowers to find any equal to some of his older varieties either in colour or form. Among them we noticed Mary Hoyle; Violetta, not equal to Viola; Exhibitor, a free-flowering variety, upper petals deep rose with dark blotch, white throat, pale pinkish under petals. This was commended. British Sailor much resembled Diadem in colour, but was of darker shade and not equal to Diadem in form, but it may some day be seen in better condition. For this a second-class certificate was awarded. Also, to Profusion, upper petals soft rosy carmine with dark blotch, clear white throat, good form, lower petals pale rose. Sunny Memories, another of Mr. Hoyle's seedlings, had the upper petals orange scarlet with deep maroon blotch, clear white throat, pale tinted lower petals. A second-class certificate was awarded. Mr. Hoyle sent in addition, Leonidas, a spotted variety, upper and lower petals orange scarlet; Flourish, dark orange scarlet, veined white throat; and John Hoyle. This was the best of all the seedlings of the day, upper petals dark maroon, clear white centre, lower petals rosy scarlet shaded and veined, fine form, and very effective. It had a first-class certificate.

From Mr. Morris Young, Milford Nursery, came Rhododendron Princess of Wales, a purplish shaded flower, centre of the flowers white and spotted, novel in colour and general appearance—second-class certificate.

From Messrs. Veitch came Azalea Vesuvius, one of the most beautiful of its class; form excellent, colour bright orange scarlet, upper petals shaded with violet and spotted. The effect of the blending of these two colours was very pleasing—first-class certificate.

Among the new plants, many of which had received awards from the Floral Committee, but have now made their public appearance, we noticed from Messrs. Veitch, *Drosera* sp., with curiously elongated hairy fly-traps—second-class certificate; *Eranthemum* species, already noticed in the Journal—second-class certificate; *Lastrea Standishii*, a Fern of great excellence—first-class certificate; *Prumnopitys elegans*, a Conifer—a first-class certificate; *Aucuba longifolia*, long narrow green leaf—first-class certificate; *Stephensonia grandiflora*—first-class certificate; *Maranta striata*—second-class certificate; *Dracena robusta*—commendation.

From Messrs. Jackson, Kingston, came *Stangeria paradoxa femina*—second-class certificate; from Mr. Williams, Holloway, *Gymnostachium Verschaefeltii*—first-class certificate; *Lastrea Standishii*—first-class certificate; *Phalenopsis grandiflora aurea*, with bright yellow lips—first-class certificate; *Sarracenia rubra*—first-class certificate; *Phormium tenax variegatum*—first-class certificate; *Cypripedium Hookeri*—second-class certificate. Mr. Bull sent *Inantophyllum striatum pictum*, light orange flowers, shaded with yellow, a very beautiful plant—first-class certificate; *Dracena Ehrenbergii*—commendation; and *Cycas Ruminiana*—first-class certificate. Mr. Ivery had *Athyrium Filix-femina Fieldii* variety—second-class certificate. Messrs. Carter exhibited a basket of their handsome *Ornithogalum thyrsoides*, which was much admired.

THE WEATHER.—On the morning of the 30th ult. the thermometer fell to 7° below the freezing-point, and again next morning to 4° below freezing. The result was that many things which had withstood the frost in previous weeks

were severely injured. We noticed a field of Potatoes, ten acres in extent, completely blackened, with the exception of a portion lying on a slope to the south-west; and Scarlet Runners and Dwarf Kidney Beans were much injured, and, in some cases, would do no more good. A letter from Dumfriesshire, dated June 1st, says, "We have had very intense frost last night and the night previous. The Potatoes are entirely destroyed." Mr. William Thomson, of Dalkeith Park, N.B., says, "We had a most severe frost here on the morning of Tuesday last, which has cut down our Potatoes and done wall fruit a great deal of damage."

FLORISTS' FLOWERS AT THE CRYSTAL PALACE SHOW.

WHATEVER misgivings may have worried the minds of the officials relative to the arrangements and prospects of the Show under the change of management, they were found to be, if they existed, quite groundless. Never have the comfort, convenience, and advantage of the exhibitors been better cared for; and when I say that the Crystal Palace Show was never better arranged, it will be at once seen by all who frequent it and know the excellence of its management how much credit is due to Mr. Wilkinson, who has taken on himself the arduous post so long and ably filled by Mr. Houghton; and I feel sure he must have felt gratified by the opinion so freely and gratefully expressed on this point. The company, too, was brilliant in the extreme; and notwithstanding that the volunteer review in Hyde Park took place on the same day, there was no diminution in the numbers of visitors as compared with former years.

The other features of the Show having been dealt with by other hands, I must confine myself to florists' flowers; and while the Exhibition was confessedly rich in stove and greenhouse plants and Orchids, it was not equally so in florists' flowers. The absence of Mr. Charles Turner in Pelargoniums (he only exhibiting in one class—Fancies), the entire absence of Tulips and Cinerarias, occasioned by the hot sunny weather, as also of Verbenas, made a great blank, which was hardly compensated for by the excellence of the Roses and Pansies.

Of Roses in ten distinct kinds in pots, no limit being placed on size, two collections were staged, one by Mr. Wm. Paul and the other by Messrs. Lane. There was no comparison between the two; and I was glad to find that the huge unwieldy plants formerly exhibited have given place in the collections of both exhibitors to plants of a more shapely character, and the eye was not, consequently, offended by a forest of sticks as formerly. Mr. Wm. Paul's collection, which was deservedly first, contained several fine plants of Tea Roses.

Roses in ten-inch pots were contributed by Messrs. Turner, Wm. Paul, Paul & Son, and Lane: and these plants are to my mind the size in which the greater number of visitors wish to see pot Roses. Anything more beautiful than Mr. Turner's collection, which obtained the first prize, could not possibly be conceived. They were *Souvenir de Comte Cavour*, dark crimson, and extremely beautiful; *Prince Camille de Rohan*, very dark and peculiar in its shade of colour; *Charles Lawson*; *President*, with some exquisite blooms on it; *Victor Verdier*, most charming; *Beauty of Waltham*, with two or three excellent flowers on it; *Gloire de Dijon*, the only defective plant in the set; *Catherine Guillot*, very good; *Juno*, a marvel of beauty with six blooms, each of which was exactly in tune; and *La Reine*. I do not think higher commendation can be bestowed on this collection than to say that there was not a plant in it from which blooms might not have been cut fit for any stand.

Messrs. Paul & Son were second with *Général Jacqueminot*, *Cardinal Patrizzi*, *Madame Julie Daran*, *Senateur Vaisse*, *Madame Rivers*, *Niphetos*, *Belle de Bourg-la-Reine*, *Triomphe de Lyon*, and *Marquise de Foucault*. Mr. Wm. Paul was third, and Messrs. Lane fourth.

Cut Roses were exhibited in the Miscellaneous Class. Messrs. Paul & Son obtained the first prize. There were in their collection some very fine blooms of such well-known flowers as *Madame Charles Wood*, *Prince Camille de Rohan*, *Virginal*, *Alphonse Damaizin*, *Madame Falcot*, *Géant des Batailles*, *Celine Forestier*, *Oriflamme de St. Louis*, *Gloire de*

Dijon, François Lacharme, Viscomtesse de Cazes, &c.; but I did not notice anything of the new Roses. Mr. Wm. Paul's collection also contained some very fine blooms.

Pelargoniums were not so numerous, nor, in my opinion, so good in quality as I have seen them, although some were marvels of bloom and growth.

In the Class for ten Mr. Bailey, of Shardeloes, was first with Glow-worm, Monarch, Etna, Lady Taunton, Sanspareil, Guillaume Severyns, Sir Colin Campbell, Desdemona, Lord Clyde, and Spotted Gem. Mr. Fraser was second with Desdemona, Mr. Marnock, Rose Celestial, Fairest of the Fair, Saracen, Sanspareil, Viola, Leviathan, Lord Clyde, and Beadsman.

In the Class for six for amateurs only, Mr. Bailey was first with Ariel, Rose Celestial, Mulberry, Leviathan, Lady Canning, and Flora.

In the Class for six Fancies a tie was run by Mr. Turner and Mr. Fraser, whose collections were placed equal. Mr. Turner's contained Evening Star; Modestum and Ellen Beck, these two plants were perfect gems; Lady Craven, Delicatum, and Roi des Fantaisies. Mr. Fraser's were Acme, Roi des Fantaisies, Delicatum, Lady Craven, Celestial, and Cloth of Silver. Two more beautiful collections of this class of flowers could hardly be imagined.

Of Seedling Pelargoniums there was not a large display. They came from Mr. Hoyle of Reading, and Mr. Wiggins, gardener to W. Beck, Esq., Worton Cottage, Isleworth. The best were John Hopper, a fine painted flower of good substance and high colour, and of large size; British Sailor, in the style of that fine flower Diadem, and as like it as possible; High Admiral, a large thick-petalled flower of a rosy colour; and Naomi, a soft Mrs. Hoyle style of flower, large and good.

Amongst a number of new Pelargoniums sent out by Messrs. Barr & Sugden, and raised by their "Sardinian correspondent," was a flower of striking appearance—Peter Barr, a soft peach blush ground, with very dark and well-defined spots in all the petals: this obtained an extra prize. There was also Novelty, a curiously veined flower, of good shape, which will, I doubt not, be a favourite stage flower.

I cannot pass by a very beautiful Zonale Geranium exhibited by Messrs. F. & A. Smith, of Dulwich, in the style of François Desbois, but certainly the very best of its class.

Some fine plants of Herbaceous Calceolaria were exhibited by Messrs. Dobson & Son, of Isleworth, raised from their seed, which is now so well known and so widely distributed. They were, many of them, very beautiful and curious in their marking, and brilliant in colour.

Pansies did not strike me as being very good, and this will be easily accounted for by the long dry weather that we have had. The best were contributed by Messrs. Downie, Laird, & Laing, who also sent a box of curiously marked Fancy Pansies.

Tulips, as I have said, were not there, the bloom this year having lasted a very short time.—D., Deal.

MY ORCHARD-HOUSE.—No. 2.

DURING the past fortnight the extreme heat has been very favourable for the orchard-house. It came just as the trees, pushing rapidly into their first vegetation, have made their spring shoots—those valuable shoots on which mainly depends next year's crop. I say mainly, for second growths made, possibly, early in June, though often capable of being ripened sufficiently to bear next season, should not be relied upon for the regular crop. Therefore the present time is a very important one for the orchard-house, and every exertion must be made to profit by it. Every warm breath of air must be caught and stored up, and the roots of the trees must also receive their due attention. Always supposing, then, that last autumn we have duly renewed the exhausted top soil of the pots and borders with rich matter, not too fresh, and mingled with some calcareous substance (which is of the highest necessity for Peach trees as well as for Vines), that top soil will now, by the influence of cold and evaporation, have become a friable black loam suitable for our purpose. The pots standing perfectly level, let the earth be gathered up round the stem of the tree into a slight mound, somewhat higher than the margin of the pot. At about

6 inches from the stem let there be a gentle depression, so that the soil may rise again near the edge of the pots. The object is to keep the rush of water immediately from either the stem of the tree or the sides of the pot. Neither of these places is the proper one for the water to reach at first. If it be directed with force to the centre it will not be of much use to the roots near the edges; and it is not to be imagined that any servant to whom this apparently unimportant work is generally confided, will, in the hurry of his task, reason on the subject. If, on the other hand, by the slope of the soil, the rush of water be directed chiefly to the edges, this plan wastes a very large portion of that water which the trees are so very thirsty for just now. There should also be about an inch left all round the pot to prevent any loss of moisture. These apparently minute details become of great importance where, as must sometimes occur, the cisterns or tanks fail. A large house, filled with full-grown trees, requires far more water than is at first sight expected. Indeed this part of the system becomes somewhat formidable to the amateur, requiring expensive apparatus for watering, and also for the frequent copious syringings of the foliage.

It is, therefore, with the view of suggesting a cheap and simple mode, which I have adopted for several seasons, that attention is now called to this point. There are many excellent apparatus in use, and where the slope of the ground allows a good flow of water, then a hose or two will enable us to keep the trees well supplied, and there is no simpler way than this one. But where this cannot be adopted for some reason or other, I should suggest to amateurs a trial of the following mode.

Down the centre of the potted trees runs a gutter about 6 inches broad and as many deep. This gutter, which is of wood (and when neatly painted is not unsightly nor conspicuous), runs, at a perfect level, just about 3 inches above the top of the rims of the pots. At every 2 feet cuts have been neatly made in the main gutter about an inch deep and broad. In these cuts are nailed pieces of lead 3 inches long, and to these, and communicating with each pot, are placed other slighter gutters. These last are of several different lengths, and removeable for convenience at the autumn top-dressing, &c. My orchard-house is long, and faces two sides of a square, so that the gutters of the southern part are worked by pumping water into them, while those of the eastern end are worked by simply turning on the water of a tank. Thus both modes are in daily use, and they answer perfectly. So many minutes' flow constitutes a hogshead of water. There is no risk of these gutters getting out of order, though in changing heavy potted trees I have often seen them rested on the main gutter. They might, perhaps, be better made of zinc or iron, provided that the lateral gutters were moveable.

I merely suggest this plan, and, doubtless, some amateur would kindly furnish an improvement on it. At any rate, 120 large trees can and have been well watered by a mere child in five minutes.

While on the subject, it is astonishing what a quantity of water a large well-fruited Peach tree will absorb on a hot day: some large ones in pots will take two gallons during a very hot day. And as to Apricots, I can only say that the leaves droop unless kept just now quite moist. This very delicate tree is impatient of the confined air of an orchard-house, and should have peculiar attention paid to its position, with respect to free circulation of air and moisture at the roots. As to syringing Apricots, except to wash off dusty particles, it is not needed. I commence watering my trees before they show bloom, gradually increase the supply till the first colours, then diminish rapidly, unless the autumn be very warm or the trees unhealthy. Very little during the winter is required.

I am no advocate for plunging pots to save watering. Such a plan seems to show that the orchard-house trees are not considered worth the trouble. As an aid to watering, syringing strongly the under sides of the leaves is of great value. Candidly speaking, I know no other way of keeping down that "atra," or rather "rubra cura," the red spider. It seems as if the shock of the water snarply applied shook the insects off. The other day a syringing of Gishurst compound, of 2 ozs. to the gallon of water, was applied to one or two trees. On examining the leaves with a microscope afterwards, about half of the spiders were found dead, but

the other half were as lively as ever, probably not reached by this odorous compound. But an unexpected result followed: nearly every Peach became stained with black, and finally dropped off. This had not occurred last year,

and the same solution applied to a bunch of hothouse Grapes, uncoloured, did not hurt them in the least. Sulphur I find powerless, and have no faith except in steady syringing.—THOMAS C. BRÉHAUT, *Richmond House, Guernsey.*

CLIVEDEN.

No part of the Thames is more beautiful than that between Maidenhead and Cookham, and of that part nowhere is the scene so picturesque as at Cliveden. Elsewhere the river's banks are generally flat and tame—here a peep may be caught of a pretty cottage nestling among trees—there of a close-shaven lawn stretching down to the water; but at Cliveden Nature becomes grand. You pass by the side of a hill with old Yews and Scotch Firs densely clothing its steep face to a height of some 300 feet, and presenting a scene so wild and beautiful, that one might fancy that the foot of man had never trodden there. But if such an illusion existed it would be soon dispelled by a glimpse caught here and there of the elegant mansion built by Barry, the original one erected by the dissolute favourite, Villiers, Duke of Buckingham, having been destroyed by fire, and another, raised in its stead, having shared the same fate. Strange tales are told of the doings here in by-gone days, of intrigues of court and intrigues of love, and of a fatal duel fought on the lawn. On traditions such as these the oarsman may pause and think whilst he admires the scene; but romantic as it is, he does not see all the beauties of the place. Below on the river he sees Nature wild and grand, but above in the grounds it is Nature subjected to art, fair and in perpetual bloom.

About three weeks ago we made a journey down to Cliveden on purpose to see the flower gardens, which we were told were then in the height of their spring bloom, and we made a few notes of the materials used, and the arrangement, which may prove of interest to our readers. And here we may observe that Mr. John Fleming has been the first to bring prominently forward the winter and spring planting of flower-beds, and that he has not confined himself to theorising on the subject, but he has practically carried out the system, and with the most happy results. How these results are attained he has fully shown in his excellent work on "Spring and Winter Flower Gardening," which all would do well to consult who are desirous of having their flower-beds gay at seasons when the majority of flower gardens are little better than bare ground.

Entering by the avenue leading to the north or principal entrance to the mansion we passed between hedges of Laurels and Rhododendrons, and, as we approached nearer, through a glade of Rhododendrons, with many Lilacs and Thorns in fine bloom; and intermixed with these were beds of early-flowering Azaleas, which are lifted to make room for Cannas and large-leaved tropical plants in summer. By the sides of the walks among the Laurels, &c., were the remains of numerous beds of Primroses and Polyanthus of various colours, which, we were told, had early in the season been in magnificent bloom. We then entered a broad avenue of lofty Lime trees, planted so as to shut out the view on either side, and between which and the gravel there was a breadth of 15 yards of close-mown grass. In a direct line with this avenue, and in front of the main entrance to the mansion, was a very striking circle represented in the accompanying figure, the wavy band of *Cerastium* being conspicuous even when seen a long way off.

The Pansies were put in in autumn, had flowered all the winter, and when we saw them the divisions which they occupied were still covered with bloom. The whole formed an appropriate termination to the avenue, and had a very good effect.

We next entered what is called the Duke's garden. This is situated on the east side of the mansion, and contains about forty beds variously filled with the different Pansies employed at this place, Yellow Auri-

cula, Polyanthus, Evergreen Candytuft, Yellow Alyssum, *Gilia tricolor*, mixed Belgian Pansies, Red Daisy, Tulips, *Cardamine pratense flore pleno* with an edging of blue Scillas, *Saxifraga granulata* (very pretty), *Virginian Stock*, and *Cheiranthus Marshalli*. Many of these beds had been filled twice—first with bulbs, and as these went off annuals were introduced to form the display which we saw. They will next be followed by bedding plants. In front of the conservatory and along the wing was a border having a broad edging of *Aubrietia purpurea*, then *Virginian Stock* and mixed French Pansies, and behind these *Polyanthus*, *Scilla*, *Jonquil*, *Narcissus*, and *Italian Wall-flower*.

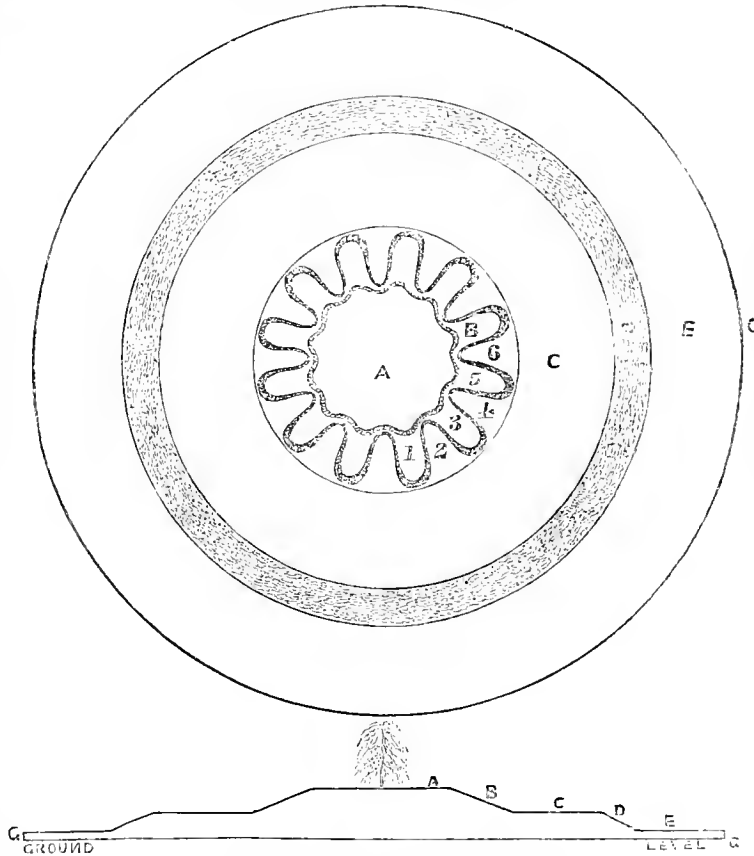

SECTION.—Scale, one-sixteenth of an inch to the foot.

- A, Grass, with *Cedrus deodara* in the centre.
 B, Beds of Pansies:—
 1, Cliveden Yellow.
 2, Cliveden Dark Purple.
 3, Cliveden Blue.
 4, Magpie.
 5, Cliveden White.
 6, Mixed Belgian.

Repeated all round.

- c, Grass.
 d, Ivy slope kept close.
 E, Grass.
 G, Gravel drive.
 The wavy band between the beds of Pansies is *Cerastium tomentosum*.

Ascending some steps Mr. Fleming led us on to the terrace on the south side of the mansion, and there lay before us the most beautiful flower garden in England—one in which simplicity of design and artistic colouring were combined, while the Thames far beyond came in like a silvery ribbon in the background. Of this garden a coloured plan was given in No. 70, July, 1862, and it forms, moreover, the frontispiece of Mr. Fleming's book, so its outline at least must be tolerably familiar to our readers; but without seeing it no adequate idea can be formed of its beauty. The whole extent occupied by this part of the flower garden is about five acres.

The beds are edged with evergreen Privet and common Spruce, and those in the centre are filled with Ghent Azaleas and Rhododendrons alternately. At the sides, all round the garden, are white and scarlet Thorns, and Lilacs white and red to harmonise with the Azaleas and Rhododendrons in the beds. The inner circles all the way down were filled with Honesty in the centre, Blue Myosotis, Pansies, and Cerastium as an edging. Taking the beds, eight in number, on each side—namely, four inside and four outside, their planting was—1 (inside), Blue Myosotis and White Tulips; 2 (outside), Limnanthes Douglasii and Anemones; 3, Red Silene and mixed Tulips; 4, White Silene and Rex Rubrum Tulip; 5, Pink Silene and Yellow Rose Tulip; 6, Blue Myosotis and mixed Tulips; 7, Limnanthes Douglasii and Narcissus poeticus; 8, Blue Myosotis and late dark Tulips. The beds on both sides correspond.

The circle at the end is divided into four beds, each consisting of four subdivisions, separated by Honesty pegged down. They were planted as follows:—1, Lasthenia californica; 2, Pink Silene; 3, White Myosotis; 4, Blue Myosotis.

Returning towards the mansion, and passing two baskets prettily filled with White Candytuft, and Yellow Alyssum hanging down to the ground, Blue Pansies, Anemones, and Tulips, we again reached the terrace wall, which is covered with Roses, Clematis, &c. In front of this, facing the south, are wavy borders on each side of the steps. These are 60 yards long, following the curves, and 6 wide, and are raised above the level of the walk. The outline of one of these ribbons is represented in the annexed woodcut, the planting being—1, Pink Daisy; 2, White Daisy; 3, Cliveden Blue Pansy; 4, Cliveden Yellow Pansy; 5, Cliveden Dark Purple Pansy; 6, Virginian Stock and Limnanthes Douglasii mixed; 7, Italian Wallflower and Queen Stocks. The half circles next the wall are filled with Red and White Honesty. The edging to these ribbons is Ivy kept close to the slope. The small beds in the bends of the ribbon were filled with mixed Anemones, Tulips, Hyacinths, &c., and edged with Cerastium; and in summer they are occupied by standard Orange trees. These ribbon-borders have an excellent effect when in bloom, and there is not that formality about them which straight rows of plants would give in the same space.

Leaving the flower-garden, Mr. Fleming took us by a romantic path along the face of the hill, which forms so picturesque a feature from the river. There, from amidst old Yews, probably three hundred years old, their gaunt roots running down the sides of the hill, fine views are obtained of the surrounding country. Descending to the edge of the water, passing along a level piece of grass, and again ascending, we regained the pleasure-ground on the west side of the house. Here, winding on the grass amidst a group of Evergreen Oaks, is a ribbon 2 feet wide and

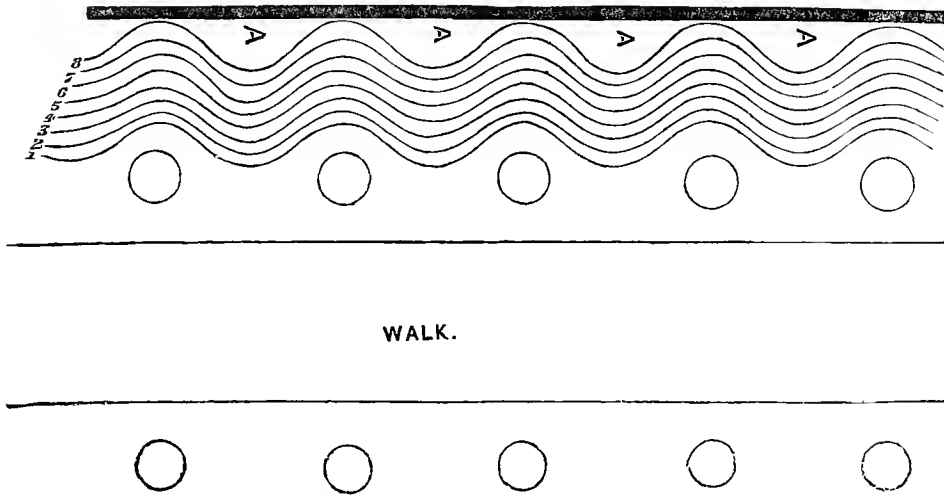

upwards of 300 yards in length, with bows and ties where the space permits. In the interior a chain is formed by White Daisies, the intervals in the centre being filled, the first with Dark Pansies, the second with White Myosotis, the third with Blue Pansies, the fourth with Pink Silene, and the fifth with Yellow Pansies, and the same series is repeated to the end. Between the chain and the grass Pink Daisies are planted. There is much difficulty in getting this ribbon perfect, as the portions exposed to the drip from the trees are apt to go off.

In looking through some of the houses we noticed in wall-

cases similar to those in use at Trentham, fine crops of Figs in 13-inch pots, Peaches loaded with fruit swelling for ripening, and splendid Black Hamburgh Grapes, the bunches and berries large, fine, and black as sloes. In a late viney we were informed that the last bunches had been cut on the 15th of March. Cherries, also, were here, showing good crops Mr. Fleming's practice being to take up the trees and introduce them into these houses as required, and he thus obtains excellent crops. In another case not heated, being in fact a kind of orchard-house, were good crops of Apricots and Plums.

MR. SALTER'S NEW DOUBLE PYRETHRUMS.

LAST year we called attention to the new and beautiful race of double Pyrethrums raised by Mr. Salter, of Hammersmith; and on visiting his nursery the other day we found he had added many fine varieties to his stock. Among dark kinds we noticed Fulgens plenissima, a deep rosy crimson, which when fully out would be about 3½ inches across; Maxima plena, a beautiful deep rose; Michael Buch-

ner, rosy lilac; Prince of Wales, carmine, very fine; Rev. Mr. Dix, peach, very full; Floribunda plena, pink, white centre; Rose Perfection, carmine shading off to pale rose, very pretty; Imbricata plena, fine rosy crimson; Rosea alba, white tipped with rose; and Iveryana, a large and very fine peach-coloured variety. Among light varieties the best we saw were Carneia plena, flesh, very double; Brides-

maid; *Candida plena*, pure white; *Madame Billiard*, blush white; and *Princess Alexandra*, pure white, very fine. Many of the single varieties are also very ornamental; *Kleinholz*, a very rich deep crimson with a yellow centre, was particularly noticeable; and *Tom Pouce*, deep rose, being very dwarf and free-flowering, seemed well adapted for bedding. In addition to the above there were large groups of seedlings, amounting to some thousands we believe, which at the date of our visit were just opening. The *Pæonies*, of which there is a large and fine collection, will also soon be in full bloom.

In the greenhouse we remarked *Lord Palmerston*, *Cybister*, and numerous other new *Geraniums* in full bloom. For the growth of these Mr. Salter remarked that he found river sand much better than silver sand. Mr. Salter also has an immense number of variegated plants, most of them hardy, many of which are very curious and ornamental—in fact, he seems to have discovered M. Von Siebold's secret of "making" variegated plants.

A LITTLE-KNOWN FRIEND OF THE GARDENER.

PERHAPS there are some of your readers who are not aware of a small mollusk called *Testacellus haliotidens*. It lives on earth worms. It is about 2½ inches in length when stretched out, is of an ash grey colour, very much like a common slug, but has a small shell on the tip of the tail. It frequents lawns, and is very useful, and should be spared. The small shell is a good mark to distinguish it from the common slug. I opened one of them and found a whole worm about 3 inches in length.—P. M., *Putney Heath*.

[In the "Penny Cyclopædia," vol. xxiv., article "Testacellus," a good description and illustration of this genus of testaceous mollusks is published.]

NOTES ON A FEW ROSES.

I DO not know how it may be with the rest of your numerous readers, but when I get the current Number of your Journal I always first turn to the index to see whether there is anything about *Roses*. I have obtained so much information and so many "wrinkles" from the valuable papers of your very clever contributors, that I think it is only fair that I should give any scrap of information which is at all likely to be of use to your *Rose-growing* readers.

With regard, then, to blooming *Isabella Gray*. Believing that the reason why this *Rose* is so shy a bloomer arises from the fact that its wood is generally imperfectly ripened, I last spring (1863) cut down close a pot plant of this variety, and then encouraged the rapid growth in a forcing-pit of three or four strong shoots. When these had attained a length of from 4 to 5 feet, I placed the plant, with the shoots carefully tied up, full in the sun, and then kept it short of water almost to starvation-point. The result was, the wood became quite hard and brown, and when I introduced the plant into the forcing-pit this spring, almost every eye which broke produced a flower-bud. Many of these, it is true, dropped before expanding, but I attribute that to the plants having been shifted too late, and to the pot being then placed in too hot and dry a position. Nevertheless, I had some splendid blooms.

With regard to *La Boule d'Or*, I have two plants worked on *Manetti*, each stock about 5 inches out of the ground—both plants in the same-sized pot, in the same sort of soil, and about the same size—yet the one always opens its beautiful flowers perfectly, whilst the other seldom opens a flower at all. I have had some blooms on the first-mentioned plant edged with pink almost like a *Carnation*. Sometimes they are remarkably fine. I had one bloom in particular that almost rivalled that notable specimen which Mr. Hedge exhibited at the *Rose show* last year, a bloom which I cannot think has ever been equalled in this variety.

With regard to *General Washington*, though it grows vigorously enough with me on the *Briar*, yet from eight or nine strong plants I last year scarcely got a bloom worth looking at—they almost all split and died "hard." Thinking that the *General* might feel more at home on his own legs,

I struck several cuttings in the autumn to try the experiment. I have reason to hope that it will succeed, as the very first bloom opened as well and freely as *Senateur Vaisse*. Talking of these two *Roses*, and *apropos* of the late discussion, I may state that I had last season one bloom of the *General* so like the *Senator*, that I am certain not one critic out of a hundred could have told the difference. There was no mistake about the matter: the foliage tallied, and the other split buds attested the fact.

Again, *Le Rhone* bloomed with me last autumn as a bright, clear, vivid scarlet crimson *Rose*. Now, a bloom on the same plant just expanding is a rich deep scarlet crimson, with dark maroon markings; in fact, it is so like *Louis XIV.* in his usual garb, that I do not believe any man in England could tell the difference except from the stouter footstalk to the flower. I believe *Le Rhone* will prove a very great acquisition, and that it will quite supersede *Louis*.

To those who force *Roses* I would confidently recommend *John Hopper* on his own roots. He strikes as freely as a *Tea Rose*, and is of a healthy medium growth. I struck about two dozen last summer, and having cut them down to three or four eyes in the winter (the wood was well ripened), placed them in the forcing-pit in January. The result was, that I had three or four beautiful *Roses* on each plant. They were mostly a vivid carmine in the centre, like that grand *Rose Victor Verdier*, shading off to lighter rose on the outer petals. I never was more pleased with any *Rose* than with this. I find, too, that on the *Briar* out of doors it is growing with a vigour which surpasses anything that I budded last year. But I must stop this rambling communication.—P.

BEDDING PLANTS WITHOUT ARTIFICIAL HEAT.

I DO not think that the most enthusiastic rosarian, or the lover of any other particular flower, can be indifferent to the gorgeous display effected by masses of scarlet *Geraniums*, the rich yellow of the *Calceolaria*, and the brilliant colours of the *Verbenas*. Many are satisfied with a glance at them without taking particular interest in their culture, or desiring to have them in their own gardens on account of the trouble of raising them; nor should they, in my opinion, be brought into contrast with such a flower as the *Rose*. We must attribute, too, the general and increasing admiration bestowed upon the *Rose*, not only to its own intrinsic beauty and the additions of new and beautiful varieties constantly being made, but also to the fact that many of the best of them can be kept out of doors all the year round—the *Rose* is, therefore, one of the people's flowers; the *Geranium* can never become such to the same degree.

I am an advocate for popular gardening to the fullest extent, and sympathise with the owner of the little modest-looking plant in the cottage window as strongly as I admire the magnificent *Orchid* and *Azalea* in the stove and conservatory of a more wealthy neighbour.

The gay beds in front of the drawing-room window are attractive in the extreme. A desire may be indulged in to have something like them. Is it possible? It is, and if any one doubts the possibility of raising and preserving bedding plants through the winter without artificial heat those doubts may be set at rest. By bedding plants I do not mean to intimate all such, but the most conspicuous and most general kinds—viz., *Verbenas*, *Calceolarias*, *Geraniums*, scarlet *Lobelias*, and *Gazania splendens*. Now, these are no particular hobby of mine. I admire them as flowers, and because of their display I desire to fill a few beds with them on a small lawn adjoining the house, where, on account of exposure and inadaptability of soil, *Roses* will not grow.

The readers of *THE JOURNAL OF HORTICULTURE* have had at various times ample information from the practical departmental writers how and when to propagate, when to pot and repot—in fact, full particulars, from the cutting to the perfect plant placed in the bed, and how to keep them in perfection when there. Such information is, of course, needful in the present state of floriculture, and no one can appreciate more than I do the ability and intelligence of the eminent horticulturists whose names are familiar to the readers of this Journal; but while so carefully instructing the uninitiated how to raise the required plants, it seems

to me to be generally implied that the same or similar means are at the disposal of the reader as of the informant. That is far from being the case, judging from the opinions of the majority of the amateur horticultural readers it has been my lot to meet with. Nor must the supposition arise that if all the conditions of potting and repotting and housing be not fulfilled parties neglecting must, or had better, go without the plants; and, again, it must not be supposed to be possible to raise and keep through the winter without the aid of artificial heat plants in so fine a condition and form as those raised by the means usually adopted and approved.

My case is simply this: I have some eight or ten small beds, with a narrow border on the lawn adjoining the house, which I wish to fill with plants affording a good floral display during the summer months. I know of nothing better than scarlet Geraniums, yellow Calceolarias, and Verbenas in variety. To effect my object properly I ought to follow certain approved modes for propagating and keeping these plants till the time arrives for putting them in the beds. I have not the means of following the prescribed plan, being not only entirely without apparatus for furnishing artificial heat and in-door shelter, but the situation is an eminence 400 feet above the sea level, and winter when it does come is felt severely. These beds require about 400 or 450 plants to fill them properly, and the border about 100 more. To buy is out of the question; but for the last three years I have managed to fill them.

From the 7th to the 20th of May I have planted out 35 scarlet Geraniums, 64 Calceolaria Aurea floribunda, 12 C. amplexicaulis, 8 Gazania splendens (all I propagated), 12 scarlet Lobelias, 32 Purple King Verbenas, 50 Lord Raglan ditto, 60 Defiance ditto, 24 of a white variety (the name of which I do not know—indeed, I am careless altogether about the endless nomenclature of this class of plants), 20 Géant des Batailles, 20 of a light pink or rather blush variety, the name not known to me, 30 Coronet, 30 Impératrice Elizabeth for edging, and a sort of hodge-podge consisting of 100 plants of different varieties of Verbenas, &c.

The winter of 1860-61 was a most severe trial for this class of plants without further protection than I have, the loss in consequence was great—probably 75 per cent. of the number propagated. Last year, owing to the previous mild winter, the keeping of the plants was a comparatively easy matter. If we assume last winter as an average of English winters the bill of fare given above is a tolerably good one, the total loss being about 12 or 15 per cent. of the total number propagated. They are thus far doing well, and I have a prospect of having my beds well furnished with flowers for the remainder of the season. They appear to have taken root, and are in good health; but, as may be readily inferred, smaller than those usually turned out by gardeners.

When I began penning these notes I intended to state the manner of propagation and keeping, obviously the chief part of the information; but having already exceeded the limits I anticipated, and time also forbidding further scribbling at this moment, I am compelled to stop. Should the Editors deem the foregoing worth insertion, it is to be understood that what remains unwritten will follow at the first opportunity.—ADOLPHUS H. KENT, *Betchingley, Surrey.*

[That we do consider it worth insertion now needs no assurance from us, and we shall be very much obliged by full particulars of the mode adopted for wintering the stock of plants.]

HEATING BY GAS.

As many communications have lately appeared in your columns as to the best mode of heating small houses, &c., the following hint may, perhaps, be acceptable to some of your correspondents, especially to amateurs, who, like myself have experienced the great inconvenience of having to give unremitting attention to their fires during a long and severe winter. A friend of mine has recently put up a frame—say, 20 feet by 8 feet, divided into compartments for the various purposes to which such a structure is applicable, and heated by a small boiler (containing some three or four gallons of water), and three-inch hot-water pipes.

I suggested heating it by gas supplied to a Bunsen's

burner, a contrivance well known to chemists as admirably adapted to insure the perfect combustion of the gas, and, consequently, the maximum of heat.

The result is very satisfactory, any reasonable degree of heat being obtainable from one small burner, all trouble of stoking being obviated, and the heat being perfectly manageable with the least possible trouble.

I am about to substitute iron pipes and a similar burner in a small house here, and shall, I expect, get a still more economical result, as a vast deal of heat is wasted in the hot-water apparatus. I am certain that one small burner of this size will keep a house of small dimensions at any temperature which may be desired, either that of a cool greenhouse or a stove, at a far less cost than can be done by the application of gas in any other way. I shall be happy to give any of your correspondents further information as to Bunsen's burner.—A. W. W.

[We shall be obliged not only by a drawing of Bunsen's burner, but also of your friend's hot-water-heated frame and apparatus. You will also further oblige us by particulars, and the results of your own mode of heating.]

THE FIRST BANKSIAN ROSE SEED.

A short time since your valuable Journal had an interesting article on Mr. Ward's experience respecting the raising of new Roses from seed in this country. This brought very vividly to my mind my first early attempt at Rose-growing when a lad, which I would here record for your juvenile readers.

On the front of my father's house in Essex grew an immense Banksian Rose tree, which, early in spring, literally perfumed the dwelling with its delicious violet-like scent. My father had told me the Banksian Rose was never known to produce seed in this country. One day, I believe in the spring of the year 1828, on walking past this tree my attention was arrested by the peculiar sound of a fly in distress, entrapped by a large spider: immediately up the Banksian Rose I climbed, without regard to nails or shreds, and set the captive free. In scrambling down I observed hanging on the spider's web a little dried calyx with three plump seeds projecting from it, quite unlike the seed-vessel of a Rose.

I seized my prize and ran to my father, whose spectacles were immediately in requisition, and he pronounced it a veritable Banksian seed. No time was lost in transferring it to a pot of earth in the hothouse, and after a few weeks of anxious watching I had the delight of seeing two charming little Rose plants appear. My young readers will imagine the interest with which I watched them grow, and when strong enough my brother planted and trained them against the end of a greenhouse wall. About four years afterwards I had the pleasure of seeing one of them flower, the sweetest little semi-double white Banksian: to my mind far prettier and sweeter than the parent.

Thus I was rewarded for this, perhaps the smallest act of kindness that could be shown; and it was, doubtless, this little incident which first gave me a true love for the cultivation of Roses—a love which has followed me through life. And so it is on looking back we often see how slender was the thread which first directed our life's pursuit—unseen at the time, and called accidental, but undoubtedly guided by a Mighty and All-wise Hand.—HENRY CURTIS, *The Devon Rosery, Torquay.*

FAIRY RINGS ON A LAWN.

CAN you inform me whether there is any cure known for "Fairy Rings" on a lawn? You are aware that they are caused by a fungus which grows in a circle, rendering the grass very green for a time, but exhausting the ground, disintegrating and eventually destroying the turf.—C. A. SAINTHILL.

["Fairy Rings" are caused by more than one species of fungus. Dr. Wollaston says—

"The broadest rings that I have seen were those of the common Mushroom (*Ag. campestris*); the narrowest are the most frequent, and are those of the Champignon (*Ag. or-*

cares of Dr. Withering). The Mushroom accordingly makes circles of largest diameter, but those of the Champignon are most regular. There are, however, as many as three other fungi that exhibit the same mode of extension, and produce the same effect upon the herbage. These are the *Ag. terreus*, *Ag. procerus*, and the *Lycoperdon bovista*, the last of which is far more common than the two last mentioned *Agarics*.

"There is one circumstance that may frequently be observed respecting these circles, which can satisfactorily be accounted for. Whenever two adjacent circles are found to interfere, they not only do not cross each other, but both circles are invariably obliterated between the points of contact; at least in more than twenty cases, I have seen no one instance to the contrary. The exhaustion occasioned by each obstructs the progress of the other, and both are starved."

We have found watering the rings with a solution of common salt, 4 ounces to the gallon, destroyed the fungus. It makes the grass brown for a time, but it soon recovers its verdure.]

MR. WARNER'S VINERY ORCHIDS.

WE have received a communication from Mr. Robert Warner calling our attention to an error in our report on his Orchids that appears in our last Number. We there stated that Mr. Warner had practised his cool system by growing Orchids in a vinery under Vines for three years: whereas we find that it is *nine* years since he first commenced the practice. "I have had a fine show of bloom for five years, not three as in your notice. *Odontoglossum grande* has been in the same house for eight years." We must, therefore, regard Mr. Warner as far in advance of all others in the cool treatment of Orchids. He further states, "The cost of growing has been comparatively *nil*, as they are under Vines, the fruit of which is almost all the labour and fuel expended on the Vines and Orchids."

DAHLIA FLOWERS VARYING IN COLOUR.

A LADY who lives in Cheshire all the year round, and takes great interest in her garden, managing it entirely herself, purchased four Dahlias, purple, white, sulphur, and yellow. All flowered true the first year; second year there was no purple, though all the roots were alive; third year three were yellow, and one tipped with white, all being still the same roots, and planted each year in the same place, with no variation of soil, beyond the annual manuring of the ground.

A constant subscriber will be much obliged if she can be told how this is to be accounted for.—H. A. D.

[We have had so many similar complaints, that we shall be obliged by some who grow Dahlias extensively informing us whether they have observed the same phenomenon, and if so, to what they attribute the change.]

IS GISHURST COMPOUND POISONOUS?

I SHOULD be obliged by being informed if Gishurst compound administered at this season, the strength of 2 oz. to a gallon of water, would poison the fruit of Gooseberries, Apples, Currants, and wall trees. I am led to this inquiry by observing that a hedge sparrow fell dead after eating the green fly off a Rose tree watered with a weaker dilution of the compound, about 1 oz. to a gallon.—R. A.

[We do not think that Gishurst compound would render the fruit deleterious. At all events, after it has been employed, and has effected the purpose for which it was applied, it might be washed off by water applied by the syringe. Have any of our readers had any experience on this point?]

PRUNUS TRILLOBA.—I enclose fruit of this most beautiful hardy spring-flowering tree. They appear to be Almonds rather than Plums. If they are woolly-coated Plums they

add another curious feature to Chinese productions, but I really forget if it was received from China or Japan.—PRUNUS.

BEDDING-OUT AT THE CRYSTAL PALACE.

I WENT to the Crystal Palace the other day with the principal object of seeing what progress had been made with bedding-out. The principle of the manager of the garden department seems to be upwards and onwards, and I look forward to the effects of the bedding-out this year very sanguinely. I would, however, suggest that to the majority of visitors it would be a great advantage that the names of the plants were legibly printed. The same applies to many of the rarer shrubs, &c., in the grounds. I should have wished to know what kind of *Verbena*, *Calceolaria*, *Lobelia*, &c., was being planted out, but I had no means of ascertaining, and so judging of the effect that will be produced by colour, as I did not choose to disturb the gardeners, who were as busy as bees.

Can you inform me what is the name of a Yew growing in the Crystal Palace grounds, the young shoots of which are of a golden yellow? It forms a most effective shrub.—DE FOIX.

[The Yew is *Taxus baccata elegantissima*, a variety of the common species.]

ORCHARD-HOUSES IN THE NORTH.

THE controversy going on in your columns respecting orchard-house cultivation has much interested me. Any facts bearing upon the question may be useful. A few months ago I had an orchard-house erected, a good substantial structure, 32 feet by 16, thoroughly ventilated through and through, semi-spanned roof, with a nine-foot wall at the back.

The situation is one of the bleakest in the North Riding of Yorkshire, 240 feet above the sea level, and a rainfall the lowest in the kingdom. The Peach and Nectarine trees were supplied by Mr. Smith, of Worcester. They have bloomed well, set their fruit admirably, have required frequent thinning, and promise at the present to bring an abundance of fruit to maturity. The house is not heated, and following Mr. Rivers's suggestions the windows have been open from early morning to nine o'clock at night. The ventilation is I believe perfect, and the trees have had no lack of fresh bracing air. Many of them have now from forty to fifty finely swelling fruits. What amount of success may be due to the well-ripened wood of Mr. Smith's trees I do not know, but so far the house is a picture of fruitfulness and health. I have no gardener. My wife has managed the trees. We have had a succession of pests—caterpillars, aphides of all colours and kinds; but plenty of syringing with cold water, and a liberal supply of fresh air, with an occasional "Gishurst wash," or a sprinkling of sulphur, have sufficed to rid us entirely.—A YOUNG AMATEUR.

[We shall be glad to be informed not only how the fruit ripens this year, but whether it sets well next spring.]

PLANT-EXCHANGES.

WHEN THE COTTAGE GARDENER was young, there were, if my memory does not deceive me, several attempts made to establish friendly plant-exchanges amongst its readers. Will you facilitate one more such attempt? I am an admirer of the Bromeliaceae, stove plants often of stately port, with highly ornamental foliage, frequently striped or barred in contrasted colours, in general producing noble spikes of gorgeous blossom. These qualities make them desirable; but they are for the most part somewhat high priced. On the other hand, they are generally easy to grow and quick of increase by offsets, which will bear handling and the delays of travelling before planting with impunity. Thus this order seems very well adapted for friendly exchange; and if any of your correspondents who possess examples would like to communicate with one who likewise has a few species, with this view, would you, Messrs. Editors, kindly allow the first reply to be addressed, under cover to your office, to—BROMELIA?

GOOSEBERRY CATERPILLARS DESTROYED BY FURZE BLOOM.

You expressed a wish that some of your subscribers would try the Furze bush for destroying the Gooseberry caterpillar, and let you know the result.

My Gooseberry trees were attacked by caterpillars in such numbers that I feared the foliage would soon be all devoured. I directed my man to place a sprig of Furze in bloom in the centre of each Gooseberry tree—the result was that in a week the caterpillars were all dead. Many crept to the end of the branch they were on, and in a few days were shrivelled up and dead.

Thanking your correspondent for the information.—
PEAKS BANTON, *Vicar of Duston, Northampton.*

WORK FOR THE WEEK.

KITCHEN GARDEN.

Now is a good time to carry on a vigorous crusade against weeds. The hoe ought never to be at rest in a well-ordered kitchen garden till these pests are all destroyed. Embrace the present opportunity afforded by the ground being moist for thinning Beet, Carrots, Onions, Parsnips, and succession crops of Turnips; and as it is presumed they are all sown in drills, let the hoe be run through between the drills—not merely skimming the surface of the soil, but moving it an inch or two in depth. This, while it roots out the weeds, at the same time checks rapid evaporation and pulverises the ground. *Carrot*, make a small sowing of the Early Horn. *Celery*, give that recently-planted copious waterings once or twice weekly. The method frequently pursued of giving plants in the open ground a small drop of water every evening or morning cannot be too much deprecated: such sprinklings cake the ground and lower the temperature of the soil without any corresponding benefit to the plants. *Red Beet*, make a small sowing. When sown early on rich soil it becomes too large and coarse, and does not retain its colour in boiling, nor look so well in salad as that which is smaller of the same variety. *Scarlet Runners*, stake, after drawing a little earth to them with a hoe: where it is intended to keep them dwarf and not to stake them, let the leaders be pinched off. By constant attention of this stopping of the leaders as they advance above three or four joints in height they will be induced to bear well. This mode of culture should only be resorted to where stakes cannot easily be procured.

FRUIT GARDEN.

In the summer management of Apple trees on walls or espaliers, it will be now necessary to go over them carefully to pinch off or to cut out all foreright, ill-placed, or superfluous shoots, and wherever there is a vacant space the next strongest shoot to be now cut back to a few eyes, from which shoots will spring during the season to fill up. Apricots to be treated in a similar manner, taking care to retain a sufficient supply of well-placed side-shoots with a good leader to each branch. The summer regulation to be commenced early that the superfluous shoots may be removed with the finger and thumb; but if through any neglect or oversight they are too firm for that operation, they must be removed with the knife. As the Morello Cherry bears principally on the shoots of the last year, therefore it is necessary to have a supply of last year's shoots on all branches from the bottom to the top of the tree for next year's bearing, and to cut out the old wood to make room. The engine employed daily will assist in effecting the destruction of insects.

FLOWER GARDEN.

Plant out Dahlias. Although they are easily cultivated and will grow almost in any soil, nevertheless they require a compost of equal parts of loam and rich vegetable earth, with good drainage, to bloom them to perfection. Plant 4 feet apart, four shoots to be allowed from each root, train to stakes, keep watered and well mulched during the summer. We do not often advise about the general routine of flower-garden operations, as we suppose that whoever has grass will not neglect to keep it in neat order by frequent mowings, sweepings, and rollings, and the edges

trimmed neatly, the gravel walks free from weeds, swept and rolled, and the edgings of Box clipped close and even; for whatever the expense and labour may have been to furnish the garden with all that is beautiful, the effect is spoiled if order and neatness do not exist. The rambling and irregular growth of shrubs to be pruned, and evergreens may now be layered. The thinning of the shoots and flowers of many herbaceous and other plants, such as Dahlias, Phloxes, Delphiniums, Hollyhocks, &c., is recommended to increase the size of the flowers. Cuttings of Roses grown under glass will root freely in any light sandy soil under a hand-glass. Put in Pink pipings. The most successful mode is to prepare a border on the north side of a wall or fence, to dig it over one spit deep, to rake the surface fine, and to cover it about 4 inches deep with about a barrowful of light, sandy soil; then water with a fine-rose watering-pot. Instead of cutting the piping it is pulled out at a joint, and being held between the finger and thumb it is pushed into the soil, not a blade of the grass to be cut, nor a knife to be used in the operation. By such a mode a dozen pipings can be pulled out of the main stem and inserted in the soil in a shorter space of time than it will take to prepare one piping on the old system of cutting-off and trimming the grass. In a month or five weeks they will be struck and fit to plant out in beds in showery wet-her. Pipings of Carnations and Picotees will strike freely if treated in a similar manner.

GREENHOUSE AND CONSERVATORY.

Hardenbergias, Kennedyas, &c., may be slightly cut back after blooming to induce a new growth. Water should now be given liberally to plants in the open borders of the conservatory, excepting, perhaps, plants very recently planted. The stock of Balsams and other annuals grown for filling the vacant places in the greenhouses, &c., should be encouraged by frequent shifts. Keep them in bottom heat and near the glass; pick off the early-formed bloom-buds, as the plants should attain a considerable size before being allowed to bloom. Kalosanthos, continue to train neatly and water with liquid manure occasionally. Specimen Scarlet Geraniums should likewise have liberal encouragement to grow them on. Common and Fancy Pelargoniums for late blooming will thrive better in a somewhat shady situation. Fumigate whenever green fly appears, as if suffered to get numerous it soon disfigures the plants. Fuchsias, if not in their blooming-pots, should be potted forthwith. Train in the desired form, and pinch back weak and straggling shoots. The glass must be taken entirely off Japan Lilies, Gladioli, &c., unless very early blooms are desired. The principal part of the greenhouse plants may now be safely transferred to an out-of-door situation. Select if possible shady situations open to the east and protected from high winds. Take care that the plants stand on a bottom carefully prepared to exclude worms from getting into the pots.

W. KEANE.

DOINGS OF THE LAST WEEK.

KITCHEN GARDEN.

SPINACH is an excellent vegetable in summer; and, if we have said little about it, it is because it is so usual to keep sowing on from March to August and September, choosing such open spaces as will be found between rows of Peas, and sowing a row or two as soon as the previous sowing is above ground. When such sowings begin to run, we never trouble ourselves by removing them, but merely cut them up, and leave them to shade the Pea ground for a little. For such summer work we prefer, as the tenderest, the Round Spinach; for winter, to be sown in autumn, we prefer the Prickly-seeded or Flanders Spinach. We have still some of the Winter Spinach left. We have the other day pulled up the last of the Cabbaging Kale, as Cabbages were coming in in abundance. The last Broccoli was also pulled up and removed, except one row that has refused to form heads, from being planted rather late. We are very doubtful if they will form heads if kept over the next winter. What say our practical friends on the subject? We once kept a few such plants, and they grew like trees, but they yielded us about as much profit as a forest tree would do in a garden. We have not a bit of spare ground for winter stuff as yet,

bnt will prick out a large bed, and then they can be moved at any time. We will find a little room for some between some rows of Potatoes, where the distance is fully 2 feet from row to row. A few Peas could be gathered from the Sangster's turned out in turves, after being sown under protection. We are having a regular supply from the cool orchard-house. We have not heard of gatherings in this neighbourhood from mere out-of-door sowing. We shall not get a good dish out of doors until a day or so before this is in print. Merely having Peas, and a dish worth looking at, are very different things. A most worthy old clergyman, now deceased, and who, years ago, lived in a very warm sheltered place, used to run us very hard with out-door Peas, generally beating us by two or three days. The last encounter we had, it so happened that we expected to get a good dish in two days, and he told us he had Peas the day before; and that, "but for the Peas getting old, and wounding our keen susceptibilities, he would help us to a few." "Oh, thanks," we replied, "we shall be greatly delighted; for even if a little old they will do admirably for soups." The Peas never came our way; and a little gentle inquiry brought out, from the *artiste* of the kitchen, that the fine dish of Peas consisted of a nice little nodule in the centre of a teaspoon! This was our last encounter. The good man sometimes used to shake his cane at us, and say, "You had no business to use your inquisitive bump on my housekeeper." There can be no question that, in many places, the first dish of Peas is of greater importance than a fine flower-bed. We have seen an old general go round, day after day, and examine the Broad Beans until they were about as large as peas inside. He was the first who told us that the pods, before the beans inside were as large as that, when cooked whole, or cut up as Dwarf Kidney Beans are, was a dish fit for an emperor epicure. We have not as yet the beans inside of the pod large enough. We mention this as a sort of test of the climate. We have no doubt that, farther south, they are much more forward. Those we have most forward were planted out, when 3 inches high, at the foot of a wall. The second crop was stopped a fortnight ago; and the third crop will have the tops nipped off some of the rows in a few days. Staked-up Peas, and prepared ground for another sowing, putting short grass on the surface, trenching it down two spits, and then cutting out narrow trenches about 9 inches deep, putting a good layer of mushroom dung, and forking over again a foot deep, and then sowing. Late Peas require more nourishment and moisture in dry autumns than early ones, and in most places they are quite as much valued. Crops sown now, on shallow poor soil, are so sure to be mildewed in the autumn, that the Peas can have little flavour.

Will only cut a bit of Asparagus now and then for soups. Have salted the beds a little, the salt will wash in by degrees. Removed the stubble and pots from the last of the Sea-kale. A few plants had suffered from the confinement, but none of this part will be forced early next season. A good bundle came in handy several times as a change at the servants' hall table; but we learn that though it was appreciated it was not esteemed nearly so much as the flowering-heads of the Sea-kale, which now want removing, and which make a beautiful, tender dish, though too often wasted. The same may be said of Leeks, now beginning to throw up their flower-stem. How healthy and nice a dish of large Leeks! Change is always desirable, and however pleasant it may be to find a useful manurial rubbish-heap accumulating, it is worse than carelessness and indifference to place there what is fit for human food. Took the opportunity after the rains of Tuesday to thin out the Onions, laying them thickly in by the heels for use for salads, and some we will prick-out thinly on a sandy surface, to cause them to button. Thinned also Carrots, Parsnips, and planted-out Beet, some under glass, having failed to keep a single plant sown in the open air, the birds whisking the seedlings off as soon as they were above ground. They used to do the same with Prince's Feather and Love-lies-bleeding; but a thread along the rows tied to little sticks, the thread black too, has saved them; but the thread was of no use in keeping them from the Beet. Cleared some of our Celery-trench beds of bedding plants, from which they lifted nicely, and planted them with Celery plants four rows in each trench, the plants being about a foot apart, quite enough for the White In-

comparable. If we can manage it we will put a slight hot-bed under a two-light box, cover with some rotten dung, and then fine soil, and fill it with nice Celery plants from 4 to 6 inches apart. These grow rapidly, and earthed-up with coal ashes come in very useful for soups and stews, and are preferable to the green plants, which must in early summer be used instead.

We cannot always accomplish what we would wish to get at, and it is often amazing how many things are put off from day to day, because something else more pressing demands attention. A little of this is a capital thing for keeping us up to the mark in continued anxious activity. Whoever else may have quiet times of it in a gentleman's establishment, it is rare that there is much repose for the gardener. Much may be done by carefully-considered systematic action, so that there shall be no waste of time, no doing and undoing; no two steps when one would do; no pulling up and scything weeds, when the dash of a Dutch hoe at an early period would enable a man to do more in the way of clearing off weeds in a day, than when large and seeding he could accomplish in a fortnight. But of all morbid, depressing things for driving everything like active energy out of a man, we know of nothing worse than being placed over a large garden and with such insufficient labour power, and that labour help so uncertain, that there cannot be a hope entertained of mastering the work, from the 1st of January to the last of December. In all such circumstances proprietors would act wisely in throwing a part of their gardens into fallow or field crops. A small space well kept is far more satisfactory than acres which conjure up no ideas but poverty and neglect. A man will do great things so long as he has the hope of surmounting difficulties, but when this hope dies he succumbs to the feelings of the impossible, and his actions insensibly will become a counterpart of his mind. As the matter has thus dropped incidentally from our pen, and as from correspondence this labour question is becoming an engrossing one, we would suggest two rules for the efficient management of gardens that require much labour help.

The first is, let the men allotted to the garden be kept to that work. Of course we do not mean that a man or men should not go from the garden in the case of an emergency, such as at times getting in hay or corn before an anticipated storm; but what we mean is that there should be no systematic plan of taking the men from the garden for everything that is wanted about a demesne; or that, if there should be certain outside work to be done at certain times, the gardener should have a clear understanding of it, so as to regulate his work accordingly. Without this, if men are taken for this, and for that, and for everything, so that the superintendent can never depend on his help, it is *absolutely impossible* that there can be mutual satisfaction between employers and employed. Just fancy a man with, nominally, five or six assistants; but in the months of May and June he finds he has rarely more than two, and often only one. In order to get forward he may toil pretty well from sunrise to sunset for a time. But will he continue to do so? Can it be expected he should do so? If worth his salt he will try and shift his quarters.

The second rule is, let proprietors and employers never interfere with the assistants of the gardener, such as taking them from the work he has appointed, and setting them to work they may fancy wants doing more. Such divided command will soon destroy alike discipline and responsibility—not but that the employer has the right to employ as he pleases the men on his property. We question not the right, but the propriety for his own interests of using it, unless, indeed, he is head gardener. To our great advantage many ladies and gentlemen enter with great zest into some department of gardening, and have a pleasure either in doing the necessary work themselves or seeing it done by a workman of their own choice. This is all right enough and desirable; but if the machinery of management is to go right, in all such cases there ought to be a man appointed to the work with whom it is understood the gardener is to have little or nothing to do, or in every case the gardener should be asked for the necessary help, instead of exercising the right of taking men indiscriminately from the work assigned them. Of course we look at the matter from a gardening point of view; but we are also sure that in what we have

said we have also studied the employer's interests. We are also certain that if these two rules were clearly acted out there would be fewer unsatisfactory gardens and fewer short servitudes. No intelligent respectable man, unless tied in a peculiar way, will long stand such fretting annoyances, which interfere with all his plans of management.

FRUIT GARDEN.

Much the same as in previous weeks. The wet of last Tuesday gave us an opportunity of going over the orchard-house, thinning and tying shoots, thinning the fruit very much, and nipping the points of shoots of trees in pots. On nice little plants of Peaches and Nectarines in pots we have left from a dozen to two dozen fruit to swell. On close scrutiny we found a few twigs infested with the brown beetle, but only a few, so we hope to get over this annoyance of last year. Of course such twigs were carefully removed, or if much wanted the insects were crushed in an instant, and the twigs washed, as their remains are nearly as bad as themselves to the health of the shoots. Thinned Grapes, attended to Melons, &c.

ORNAMENTAL GARDENING.

The great work of the week has been bedding, and we hope this week will see about the last of it. In another season, if spared to do it, we will much lessen our flower ground; if by no other means, grassing some of it with turf. With our thousands of Stocks, we have run rather short, and have used scrolls and other devices in a group, which several good judges have said will be very pretty, without knowing that the prompting cause was the concealment of the scarcity of plants. For this purpose the partering or lozenging of a clump or border enables a person to work in somewhat systematically endless varieties of things, though individually few in number. Much has also been done in shifting fine-foliaged plants, as Coleus, Caladiums, &c., into large pots, Scarlet Geraniums, &c., to come in for the conservatory. If the latter receive a little bottom heat, they will grow rapidly and with great robustness. We mentioned some time ago the raising of a low house used for stove plants, Ferns, &c., and Figs in one division, and chiefly that in the first division there might be the ability given of walking round it, instead of going to the end or the middle, and coming back again. We did the floor with common paving tiles, and the damp made them green and slimy, and it was troublesome, and like washing a blackamore white to attempt to keep them clean. Our young man has hit upon an expedient, and carried it out, so that the floor will look well, at least for a time. We are careful in getting what sand we can from the highway, that has been washed by a storm of rain. This washed through a fine sieve left a lot of small black stones and flints. These he has used for the centre of the pathway. The siftings we use for the pleasure-ground walks, being of a whitish colour from chalk. These washed in a similar manner gave whitish little shingles for seeds. The stones are put three quarters of an inch thick above the tiles, and look very neat, and seem more appropriate for a cool, moist house than any fine flooring. We know how to keep the shingle from getting green. We think it worth mentioning among those little matters that cost little and yet yield a degree of gratification.—R. F.

COVENT GARDEN MARKET.—JUNE 4.

The demand is brisk, but in consequence of the late cold weather the supply is not more than equal to the requirements of purchasers. Pine Apples, Grapes, and Strawberries are sufficient for the demand. Arrivals, from abroad continue heavy, and include Artichokes, Tomatoes, Cherries, and Peas. Flowers chiefly consist of Orchids, Heaths, Pelargoniums, Calceolarias, Cinerarias, Heaths, Azaleas, and Roses.

FRUIT.

	s.	d.	s.	d.		s.	d.	s.	d.
Apples.....	½	0	0	0	Melons.....	6	0	10	2
Apricots.....	0	0	0	0	Nectarines.....	10	0	20	0
Cherries.....	1	0	2	0	Oranges.....	100	10	0	16
Figs.....	12	0	20	0	Peaches.....	18	0	36	0
Filberts & Nuts 100 lbs.	0	0	0	0	Pears.....	0	0	0	0
Goosebrrs. Green ½ sieve	2	0	4	0	Pine Apples.....	6	0	10	0
Grapes, Hot-house.....	6	0	14	0	Strawberries.....	0	6	1	0
Muscats.....	10	0	15	6	Walnuts.....	14	0	20	0
Lemons.....	100	4	0	10					

VEGETABLES.

	s.	d.	s.	d.		s.	d.	s.	d.
Asparagus.....	4	0	8	0	Lettuce.....	1	0	to	2
Beans, Broad.....	0	0	0	0	Mushrooms.....	1	0	2	0
Kidney.....	2	0	0	0	Musht. & Cress, punnet	0	2	0	4
Beet, Red.....	1	0	3	0	Onions.....	7	0	12	0
Broccoli.....	0	0	0	0	pickling.....	0	6	0	8
Cabbage.....	1	0	1	6	Parsley.....	1	0	2	0
Carrots.....	0	6	0	8	Parsnips.....	0	9	1	6
New.....	0	9	1	6	Peas.....	1	0	2	0
Canflower.....	6	0	12	0	Potatoes.....	0	8	12	0
Celery.....	1	6	2	0	New.....	0	4	0	8
Cucumbers.....	0	6	1	6	Radishes doz. bunches	0	6	0	9
Endive.....	1	3	2	6	Turnip.....	0	6	1	0
Fennel.....	0	3	0	0	Rhubarb.....	0	4	1	0
Garlic and Shallots, lb.	0	8	0	0	Sea-kale.....	0	0	0	0
Herbs.....	3	0	0	0	Spinach.....	1	0	2	0
Horse-radish.....	1	6	4	0	Turnips.....	0	6	0	8
Leeks.....	0	6	1	0	New.....	1	0	2	0

TO CORRESPONDENTS.

LAND IN JAMAICA.—Could any of your correspondents state in THE JOURNAL OF HORTICULTURE, what could be cultivated on one acre of land in Jamaica, so as to give the cultivator the greatest amount of profit? And what is the value of an acre of Cotton? The acre of land is offered as part wages to one who is to fill a situation there.—A YOUNG GARDENER.
[We shall be obliged by replies to these inquiries. We would suggest the cultivation of superior varieties of Pine Apple for the London market.]

PELARGONIUMS (W. H. H.).—The petals were all shed, and consequently the varieties unrecognisable. Pelargonium trusses for travelling should be cut when the flowers are only half opened.

STRAWBERRIES DYING (A. M. T.).—The grub of the cockchafer, or the leather-coat or under-ground grub, probably eat the crowns of the plants. If so, you will find the grubs in the soil adjoining the plants. It is useless to send a plant. Your only remedy, if grubs are the marauders, is to turn up the soil and search for them.

VARIOUS (J. D.).—Chrysanthemum culture you will find in "The Garden Manual," which you can have free by post from our office for twenty penny postage stamps, and it contains all the directions you require in each department of your garden. Solanums are so numerous that it is impossible to tell what they are. The Egg Plant, the Tomato, &c., are all Solanums, and "fruit-bearing." In Nos. 147 and 148 of this series of our Journal, and published in January last, is a long essay on the culture of Amaryllis, with a list of the best.

CATERPILLARS (H. Bell).—What are the trees? If Gooseberry, try the Furze in bloom, of which we publish a remarkable testimony to-day. Dusting thoroughly with fresh white hellebore powder is fatal to the vermin. When the powder has effected its purpose, the bushes should be well syringed, for the powder is poisonous.

ICE-HOUSE CONSTRUCTION (A Tyro).—If you will send four penny postage stamps, with your address, and order No. 583 of this Journal to be sent to you, you will find a very full essay on the subject by Mr. Fish.

ABORTIVE PINE APPLES (Inquirer).—Your having so many abortive fruits is the result of having your spring-fruiting plants too forward in autumn. They have filled their pots with roots and completed their growth too early to be kept from forming fruit before the dead of winter was past, and consequently they have started at a dull season, and probably under a resting temperature, and the consequence is that they do not bloom nor set properly, and they get malformed and hard like the samples you have sent. The fruit often forms thus in winter although not noticed, and under a low temperature, dull weather, and dry state of the soil—which is suitable for plants in a proper condition—they assume this malformed character. In hot bright autumns, fine, strong, forward plants are much more likely to go wrong in this way than later fruit. To have plants in a properly ripened and forward state to come up after the turn of the year without making a fresh growth of leaves, is one of the nicest points in Pine-growing. Plants that make a growth in spring before starting always throw the finest fruit, but for early work it is necessary to have a lot in a more forward state; while the danger to be avoided is that of having them too forward, and so forming fruit at a season when it cannot be properly developed, as yours have done in this case.—D. T.

GRAPES RUSTED (Nescio).—The berries are affected with what gardeners term "rust," caused in your case, probably, by sudden cold currents of air. It is a disfigurement, but will not injure the fruit. The Pear blossom, if on trees out of doors, was, perhaps, injured by the frosts at night, and easterly winds. If they, the trees, were in-doors, their wood was probably not well ripened last year.

PELARGONIUMS (T. Collins).—Trusses of twenty-three Pelargoniums to name; and "the boy to wait for them!" It would require a whole day to discriminate them, more especially being without foliage. We cannot spare the time to name more than three or four specimens at once for any correspondent.

SEEDLING CALCEOLARIAS (H. Major, Knottshorpe).—We have received your very beautiful blooms: they are even better than those you sent last year, both in shape and brilliancy of colour; and we wish that some of them could be seen at our London exhibitions. You have certainly obtained a good strain.

HANDSOME-FOLIAGED CANNAS (C. M.).—Reevesii, villosa, Warzewiczii Lindleyana, Hookeri, and leptophylla.

OUT-DOOR GRAPES WITH MUSCAT FLAVOUR (M. S. T.).—The Muscat Ottonel and Muscat Citronelle will most probably succeed on your slated roof.

VARIOUS (J. B.).—Some of the Numbers are out of print, but we shall shortly publish a cheap manual including the whole of Vine culture. There is no such periodical as you inquire about. Either of the qualities of glass you mention would do for ainery.

SWEET ALYSSEUM SEEDLINGS (S. M.).—Plant them at once in the place where they are to remain.

HEDYCHUM IN GREENHOUSE (B. E).—The *Hedychium* should be repotted if necessary, but the plant blooms all the better for being kept rather pot-bound. Free growth and the thorough ripening of the growth made, are necessary to insure blooming. The plant should be placed in the warmest and lightest situation in the full sun, and be kept well supplied with water until the shoots attain their full size or they cease growing, when less water should be given—in fact, no more than to prevent the leaves flagging. The old, yellow, or dead and useless shoots should be removed at once, and every encouragement given the plants to get the shoots strong and well ripened, without which there is little prospect of the plant blooming. The plants should be well watered whilst they are in bloom. They should be kept rather dry during the winter. They require moderate pot room, but it is better to have them rather under than over potted. If you sow the seed of *Tropaeolum Jarratti* immediately it is ripe, in a compost of sandy peat half, light loam and leaf mould, equal quantities, the other half, with a liberal quantity of silver sand intermixed, providing abundant drainage, and covering the seeds lightly with compost, you will find the seeds, if good, will come up freely if placed in a gentle hotbed, 70° to 75°; or they will germinate, but more slowly, if the seed-pot be kept in the greenhouse. They require gentle watering until the plants gain strength, when they should be potted singly into small pots, and after they become established they require the same treatment as old plants.

SHRUBBY CALCULAEARIAS (A. mateur).—It is now high time but not too late to procure seed for sowing to obtain good plants for blooming early next year. The seeds of half-shrubby *Calcularias* are not more difficult to raise than the herbaceous. We prefer the herbaceous, many of which have a half-shrubby habit, little differing from the so-called half-shrubby, which are a class of plants quite undesirable, for neither plants nor blooms are anything remarkable.

GREEN FLY ON WALL TREES (B. M. K. Admiral).—We fear you have not applied the tobacco water strong enough, otherwise it destroys this pest. We advise you to try again, employing one gallon of tobacco water of the shops diluted with five gallons of rain water, and apply this with a fine-rosetted syringe so as to thoroughly wet every part, doing this in the evening after a hot or dry day, and when the air is calm. The following night syringe the trees with soap-suds if at hand, or forcibly with water, and do this every other night for a week. If the pest still remains, which we question, repeat the application of tobacco water, and continue the syringings every other night, discontinuing syringing with soap-suds after the middle of June for Currants, and after June for other fruit trees. The trees may be syringed with water with the garden engine until the fruit changes for ripening, after which it must be discontinued. If tobacco water cannot be had it may be made by pouring half a gallon of water on every ounce of the strongest shag tobacco.

PHILODENDRON FRUIT.—A correspondent says, "The *Philodendron* perticum that was figured in the *Journal* some time ago is now in fruit at J. N. Clarke's, Trowbridge, Wilts. It is a stove plant. Wanted to know if it is scarce, and whether the fruit is eatable?" We do not know a species so called. Our figure was of *P. Simsii*. We are quite sure, however, that the fruit is not eatable. The whole natural order to which it belongs is more or less poisonous.

BONES FOR MANURE (A Seven-years Subscriber).—Write to the London Manure Company, Bishopsgate Street, stating exactly what you require.

NAMES OF PLANTS (J. Smith).—It is impossible to name the varieties of *Begonias* from fragments of their leaves, they are too numerous and too similar. The following, however, appear to be some of yours. 1 and 5, forms of *B. xanthina*; 2, *B. Rex*; 4, *B. Griffithii*. The Ferns are, 1, *Adiantum cuneatum*; 2, *Asplenium bulbiferum*. (*Three-years Subscriber*).—1, *Ulmus montana*; 2, flowers fallen; 3, *Geranium phæum*; 4, *Meconopsis cambica*. (*R. J. G.*).—1, *Clematis Fortuna*, but a poor flower; 2, *Poly-stichum angulare*; 3, *Ceterach officinarum*. What is the history of the *Clematis*? (*K. R.*).—The tree is the Flowering Ash, *Ornus europæa*, commonly called *Fraxinus ornus*.

POULTRY, BEE, AND HOUSEHOLD CHRONICLE.

BEVERLEY SHOW OF POULTRY, PIGEONS, AND CANARIES.

FOR many years past the town of Beverley has enjoyed a reputation for one of the best annual meetings of its Poultry Society of any local show in the kingdom; and certainly the Exhibition on the 1st ranked quite as highly as any of those preceding it. No effort that can be made to promote its success is ever neglected by the Committee of management; and the townsmen of Beverley show, also, every possible inclination to support it by all the means in their power. This year has, pecuniarily considered, been a most successful meeting, the weather being as fine as could be desired, and that, too, without the excessive amount of heat that at this season so frequently accompanies it.

The grounds most kindly placed at the Committee's disposal, immediately adjoining the Assembly Rooms, for holding a Floricultural Fête in connection with the poultry, by Charles Reynard, Esq., added no doubt to the attraction in a very material manner. It was, perhaps, the most numerously attended of any show that has yet taken place. We hear that the worthy proprietor of these grounds permitted a grand display of fireworks to take place in the evening.

The neat little town of Beverley bespoke a general holiday, flags, evergreens, and bannerets being quite the order of the day. The Assembly Rooms are excellent for the display of every pen of poultry exhibited to an equal advantage as to light, &c., whilst the best of ventilation is carried out.

Our readers will hardly be surprised to find the name of one of the most reputed Game-breeders here holding the highest position. We allude to Mr. Harry Adams, of great Game note, not only in this neighbourhood, but at most of our principal shows. Reference to the appended prize list will best bespeak the excellence of this gentleman's stock; but we cannot forbear mentioning the simple fact that the disposal of the Society's silver medal, given to the best pen in the leading Game classes, was quite a sincere to the Judges, for having won all the first prizes in each of such classes, together with not a few of the inferior ones to boot, of course Mr. Adams distanced all competitors.

Although the classes of *Game* fowls throughout were so very good, it is pleasing to note the almost total absence of even a single indifferent bird, consequently there were no drawbacks, and all visitors were placed in a position to examine, at leisure, one of the best collections of Game fowls brought together for many years. The *Spanish* and *Dorkings* were classes of the greatest merit, the pairs of single hens in each of these varieties being especially commendable. The *Cochins* were very good, but as is always the case about this time of year, almost every hen was indomitably broody. In every variety, Buffs, Whites, or Partridge-coloured *Cochins*, there was an excellent display. In *Hamburghs*, the Spangled varieties took a decided lead, and left little room for improvement, though of Pencilled we have seen much better in times past. The *Polish* class was one of the best in the Show. *Bantams* showed well and numerously in almost every variety, the Black ones, perhaps, being the highest perfection. It is now too late in the season for *Sebrights* or *Game Bantams* to show to advantage.

The *Aylesbury*, *Buenos Ayrean*, and common *Wild Ducks*, were well shown.

At Beverley Show, the *Pigeons* are always a chief feature, and this year a capital competition ensued, every class being far better than those we customarily meet with. We noticed particularly some exceedingly good *Carriers*, *Fantails* whose carriage was perfection itself, *Barbs* remarkably well bred, some capital *Owls*, and a great variety of *Toy Pigeons*.

The *Canaries* and other small birds were not without admirers, and this compartment of the Show was constantly well filled with visitors.

GAME (Black-breasted or other Red).—First and Medal, H. Adams, Beverley. Second, H. Beldon, Bradford. Third, Sir St. G. Gore, Bart., Hopton Hall, Wiltshire. Commended, T. Robinson, Poplar Grove, Ulverston.

GAME (Duck wing and other Greys).—First and Second, H. Adams, Third, W. Boyes, Beverley. Commended, H. Robson, Beverley.

GAME (Any other variety).—First and Second, H. Adams. Third, W. Taylor, Sheffield.

SPANISH.—First, W. Cannan, Bradford. Second, H. Beldon, Bradford. Third, W. Harvey, Sheffield. Commended, R. S. Brantort, Sunderland.

DORKING.—First, Sir St. G. Gore, Bart., Hopton Hall. Second, M. Hunter, Green Hammerton Hall. Third, Rev. J. F. Newton, Kirby-in-Cleveland. Highly Commended, Rev. J. F. Newton.

COCHIN (Buff, Lemon, and Cinnamon).—First, E. Yardley, Wisewood, Sheffield. Second, T. H. Barker, Hovingham. Third, C. T. Bishop, Lenton.

COCHIN (Any other variety).—First, E. Smith, Middleton. Second, W. Dawson, Hopton, Mirfield. Third, R. White, Sheffield. Commended, C. Kershaw, Ashton-under-Lyne.

HAMBURGH (Golden-pencilled).—First, T. Birch, Sheffield. Second, H. Pickley, jun., Earby. Third, J. E. Powers, Biggleswade. Commended, W. Cannan, Bradford; S. Smith, Northwram.

HAMBURGH (Silver-pencilled).—First, E. Yardley. Second, A. Nicholson, Walkley. Third, W. Cannan.

HAMBURGH (Golden-spangled).—First, Sir St. G. Gore, Bart., Hopton Hall. Second, W. Cannan, Bradford. Third, H. Beldon, Bradford. Highly Commended, W. Cannan, Bradford. Commended, H. Carter, Upperthong.

HAMBURGH (Silver-spangled).—First W. Cannan, Bradford. Second, F. R. Pease, Darlington. Third, H. Beldon, Bradford. Highly Commended, T. Davis, Newport; Sir St. G. Gore, Bart. Commended, W. Cannan, Bradford.

TOLANIS.—First, H. Carter, Upperthong. Second, F. R. Pease, Darlington. Third, H. Beldon, Bradford. Highly Commended, J. Heath, Nantwich. Commended, H. Beldon, Bradford.

ANY OTHER VARIETY OR FARMYARD CROSS.—First, H. Lacy, Lacy House, Hehden Bridge. Second, F. R. Pease, Darlington. Third, E. Smith, Middleton. Commended, W. Cannan, Bradford.

BANTAMS.—First, R. M. Stark, Hull. Second, Sir St. G. Gore, Bart., Hopton Hall. Third, Master T. Eulby, Beverley. Highly Commended, W. Wood, Walkley, Sheffield.

BANTAMS (Any other variety).—First, H. Beldon, Bradford. Second, W. Cannan, Bradford. Third, E. Smith, Middleton. Highly Commended, W. Cannan, Bradford; R. M. Stark, Hull. Commended, W. Cannan, Bradford; J. R. Jessop, Hull.

SINGLE COCKS.

SPANISH.—First, H. A. Hudson, Ousecliffe, York. Second, R. M. Stark, Hull. Commended, W. Cannan, Bradford.

DORKING.—First, Rev. J. F. Newton, Kirby-in-Cleveland. Second, W. Watson, Bishop Burton.

COCHIN-CHINA.—First, R. White, Sheffield. Second, E. Smith, Middleton. Highly Commended, W. Harvey, Sheffield. Commended, H. Beldon.
HAMBUROH (Gold or Silver-pencilled).—First, S. Smith, Northwram. Second, W. Harvey, Sheffield. Highly Commended, W. Cannan, Bradford; H. Pickles, Earby, near Skipton.
HAMBUROH (Gold or Silver-spangled).—First, H. Beldon, Bradford. Second, S. Campling, Cottingham.
BANTAM (Any variety).—First, R. M. Stark, Hull. Second, C. W. Wilson, High Park, Oxenholme. Highly Commended, J. Crossland, Wakefield. Commended, W. H. Wordsworth, Chesterfield.
GAME (Black-breasted and other Reds).—First, H. M. Julian, Hull. Second, J. A. Aykroyd, Bradford. Third, W. Boyes, Beverley. Highly Commended, F. Sales, Crowle; H. Adams, Beverley. Commended, Sir St. G. Gore, Bart.; H. Adams.
GAME (Duckwing and other Greys).—First and Second, H. Adams. Third, J. A. Aykroyd. Highly Commended, A. Allsop, Baslew. Commended, Sir St. G. Gore, Bart.
GAME (Any other variety).—First, W. Taylor, Sheffield. Second and Third, H. Adams.

SINGLE HENS.

GAME (Black-breasted or other Reds).—First, H. Adams, Beverley. Second, J. A. Aykroyd, Bradford. Highly Commended, W. Boyes, Beverley; H. Adams, Beverley.
GAME (Duckwing or other Grey).—First and Second, H. Adams, Beverley. Commended, W. Taylor, Sheffield.
GAME (Any other variety).—First, H. M. Julian, Hull. Second, H. Adams, Beverley. Commended, H. Adams.

PAIRS OF HENS.

SPANISH.—First, J. Holmes, Hotham. Second, S. Robson, Brotherton, Yorkshire. Highly Commended, W. Cannan, Bradford; R. M. Stark.
DORKING.—First, F. Key, Beverley. Second, Rev. J. F. Newton, Kirby-in-Cleveland. Highly Commended, E. Smith, Middleton; F. Key.
COCHIN-CHINA.—First, T. H. Barker, Ilvingham. Second, R. White, Sheffield. Commended, W. Cannan, Bradford; E. Smith, Middleton.

DUCKS (Aylesbury).—First, O. A. Young, Driffeld. Second, Sir St. G. Gore, Bart., Hopton Hall.

DUCKS (Rouen).—First, W. Cannan, Bradford. Second, O. A. Young, Driffeld.

DUCKS (Any other variety).—First and Second, J. R. Jessop, Hull. Commended, W. Cannan, Bradford.

PIGEONS.

CARRIERS.—First, H. Beldon, Bradford. Second, H. Yardley, Market Hall, Birmingham. Third, G. Pashby, Hull. Highly Commended, H. Yardley.

POWTERS.—First, W. Taylor, Sheffield. Second, H. Brown, Walkley, Sheffield. Third, H. Beldon, Bradford. Highly Commended, S. Robson, Brotherton.

TUMBLERS (Any variety).—First, H. Beldon, Bradford. Second, H. Yardley, Birmingham. Third, G. R. Potts, Sunderland. Highly Commended, F. Else, Bayswater, London. Commended, T. Statters, Hull.

BARNS.—First, H. Yardley, Birmingham. Second, W. Massey, Gedney, near Wisbeach. Third, G. Robson, Hull. Highly Commended, H. Beldon, Bradford. Commended, J. Firth, Dewsbury; H. Yardley, Birmingham.

JACOBS.—First, H. Beldon, Bradford. Second and Third, Mrs. Ellington, Woodmansey. Highly Commended, T. Ellington, Woodmansey; M. E. Jobling, Barras Bridge, Newcastle.

TRUMPETERS.—First, Master H. Key, Beverley. Second, Master J. Key, Beverley. Third, S. Robson, Brotherton. Highly Commended, H. Beldon, Bradford; W. Young, Howden.

OWLS.—First, H. Beldon, Bradford. Second, F. Else, Bayswater. Third, H. Yardley, Birmingham.

TURMIS.—First, F. Else, Bayswater. Second, J. R. Jessop, Hull. Third, Master T. Key, Beverley. Highly Commended, M. E. Jobling, Barras Bridge; H. Yardley, Birmingham. Commended, G. R. Potts, Sunderland.

FANTALS.—First, T. Ellington, Woodmansey. Second, T. C. Taylor, Middlesborough. Third, J. R. Jessop, Hull.

ANY OTHER VARIETY.—First, H. Yardley, Birmingham. Second, B. Leason, Driffeld. Third, G. Robson, Hull. Highly Commended, H. Beldon, Bradford; M. E. Jobling, Barras Bridge; J. R. Trenam, Helmsley.

SELLING CLASS.—First and Second, B. Leason, Driffeld. Highly Commended, H. Yardley, Birmingham. Commended, T. Statters, Hull; H. Beldon, Bradford; Master B. Key, Beverley.

CANARIES.—*Belgian.*—First, J. Holmes, Beverley. Highly Commended, R. Jameson, Wood Lane. Commended, L. F. Charlton, Market Place; Miss A. Rippon, Minster Moor Gate; J. Holmes. *Marked.*—First, R. Jameson. Second, Mrs. Pottage, Fleming Gate. Highly Commended, Mrs. W. Robson, Mill Lane; J. Pearson, Walker Gate; Mrs. W. G. Drewry, Beverley. Commended, Miss S. A. Simpson, Tiekton. *Any other Variety.*—First, J. Campey, Well Lane. Second, Miss J. Campey. Highly Commended, Miss J. A. McCoy; Mrs. T. Dunning. Commended, Mrs. J. Pearson; W. G. Drewry. *Nest of Young.*—First, E. Campey. Second, Mrs. Rippon. *Fales.*—First, W. Campey. Second, J. Widdall. Highly Commended, Miss A. Brigham. *Redcaps.*—First, Mrs. Campey. Second, J. Holmes. Highly Commended, G. Coates. Commended, Miss Johnson; J. Armstrong, Beverley.

The Judges of Poultry were Mr. Thos. Challoner, of Barborough, near Chesterfield; and Mr. Edward Hewitt, of Sparkbrook, Birmingham. Pigeons were judged by W. W. Boulton, Esq., of Beverley; and Fergus Ferguson, Esq., of Walkington. Mr. J. Smith, of Hull, officiated as the arbitrator for Canaries, and other small birds.

NUN PIGEONS.

Among other special prizes offered at Cottingham Show August 17th, is one given by W. A. Summers, jun., Esq., for "Nuns with white head, flight and tail, and black body;"

and a correspondent, "F. K., Beverley," inquires "if there are such Nuns?" In answer to this question, Mr. Brent says:—"I beg to reply that Nuns, like all other Toys, are Pigeons of feather only, and, if their marking is altered the variety is lost. Nuns are white Pigeons, with hoods, and dark veils; and according to the colour of the head are they designated—Black-headed, Blue, Dun, Red, or Yellow-headed Nuns. They generally have the flight and tail coloured like the face, though some have white flights, and others are all white except the face only; but if the colour is reversed they are not Nuns. The Pigeons here mentioned, with white head, tail and flight, and black body, must be some variety of Capuchin, Monk, or Priest. Some of these are white-headed only; others have head and tail white; while many have head, tail, and flights white, the body being black, or some other colour.

"These Toys are but little esteemed in this country, but are common enough in Germany. Some are bred with white wing-bars or spangled shoulders; some are clean-footed, while others are booted; some are smooth-headed, others are hooded, and a few have moustachios like Trumpeters. 'F. K.,' if ambitious, may easily breed the variety between Baldhead Tumblers and Jacobin Pigeons, but they are not worth the trouble; and the prize offered is probably nothing more than a whim of W. A. Summer, jun., Esq., and not likely to be repeated.—B. P. BRENT."

A HEN PHEASANT ASSUMING A COCK'S PLUMAGE.

THERE is now at Sutton Hill, near Shifnal, Salop, a hen Pheasant acquiring the plumage of a male of the same species. She does not seem so lively as the other birds, nor has she laid this season, although she did so freely last season. Do you consider the above at all curious, as it is the first instance of the kind that I have known? Thinking that some of your correspondents may have met with something of the kind before, I am induced to send the above for publication.—C. D.

[Old hens of the Dorking breed of fowls we have known gradually become of masculine plumage. We shall be obliged by information how near the hen Pheasant's plumage approaches to that of a cock Pheasant.]

ARTIFICIAL SWARMS.

"PHILISCUS" objects to the employment of a second stock, and its removal to a new site for the purpose of obtaining a sufficient population to carry on the hive from which all the bees have been expelled, on the ground that it is liable to become almost denuded of bees, which will leave it for their old locality. I confess that in the course of my practice, a few instances of this character have occurred to me. Bees occasionally leave a stock, under such circumstances, to what might be thought, an alarming extent. But with a careful bee-master no real injury from this cause need occur. When this excessive depopulation is observed, it is only on the following day, when the bees are working briskly, to remove the driven stock, confine the bees, and put it in a cool dark place for twenty-four hours, returning the depopulated hive to its old stand. If the weather is dull and the bees not working very briskly, I merely transpose the stocks without confinement. I wish my swarms to be as large as possible, therefore all the bees are driven out. It is impossible to tell how large a proportion of the population is expelled, if any are left; and the presence of the queen in such circumstances must be generally a doubtful matter. If a large number of bees join the driven stock they may again be expelled in a fortnight, provided sealed royal cells had been inserted at the time of the first expulsion, or in about three weeks if left to raise queens for themselves. If it is feared that excessive desertion will attend the removal of a strong stock, I see no reason why the bees should not be at once confined, and the hive taken within-doors for twenty-four hours. Then being removed to a new stand, but a very few bees will leave it. A sufficient population no doubt will be obtained for the driven stock from the bees which are returning from the fields at

the time of removal, with the addition of a few which will unite with them after the liberation of the prisoners.

Perhaps a few extracts from my note-book for 1861 will not be without interest.

April 21st.—No. 10, an excessively weak stock, which it was desired to strengthen. No. 9, a flat straw hive with octagon super, left on all the winter as the stock-hive had no stored food. Both super and stock contained a good deal of brood. Expelled the bees from the super, which was placed under No. 10. Transposed Nos. 9 and 10.

April 23rd.—No. 9, much impoverished by the double deprivation of brood and bees. The two hives restored to their respective positions.

April 28th.—No. 9, working briskly.

July 16th.—No. 9, a super taken with 20lbs. (nett) of honey.

May 7th.—Removed No. 16 to a distance of nearly a mile. Put No. 10 on its stand. Gain in bees but small.

May 17th.—No. 6, straw hive. Drove all the bees, a very fine swarm, lived in a Langstroth-box. Cut out combs of No. 6, crammed with brood and honey, fitted in frames, and united the bees, frames and queen, of the very weak hive No. 10 to them.

May 18th.—Took out a comb of brood from No. 6, inserted in a nucleus-box, and put in the place of No. 12, removed a few yards off. Enough but not too many bees joined the nucleus, which raised royal cells, &c. (No. 12 was still populous enough to require a super to be given on the 25th.)

May 23rd.—No. 16, drove all the bees, a fair-sized swarm. Driven stock put in place of No. 13, removed about 20 yards. In the evening four royal cells were fastened among the combs. (This became a remarkably good stock. The swarm No. 3 filled its large ten-frame box very quickly.)

May 28th.—Had a Ligurian queen presented me by Mr. Woodbury. Drove all the bees out of No. 12—a good swarm. Confined queen in a small box, which was inserted among the combs of old hive. This was placed on stand of No. 13, which was removed for No. 16 only five days previously.

May 28th.—No. 16, driven on the 23rd, is extremely populous. (Super put on June 16th.)

June 19th.—No. 13.—Drove all the bees. Good swarm (notwithstanding two previous removals), put in place of No. 12 (driven on May 28th).

June 20th.—No. 12, appears to have lost most of its bees. Restored the balance of population by retransposition of the hives.

June 27.—Transposed Nos. 6 and 10 to strengthen No. 10.

June 28th.—No. 6, considerably depopulated. Many of the bees joined No. 11 instead of No. 10 as desired. (No. 6 quickly became populous as the young bees emerged from the cells. No. 11 filled two supers, 25 lbs.)

July 2nd.—No. 15, swarm driven from No. 13, has filled its box with combs, brood, and sealed honey.

July 9th.—No. 3, artificial swarm driven from No. 16, nearly full. Two beautiful frames of sealed honey removed from the sides.

The foregoing extracts from my note-book have been selected as being likely to give a fair idea of my practice. "PHILISCUS" will see that cases are mentioned in which what he states he fears may occur, actually did so, but the evils were easily rectified. In other instances all the manipulations were attended with complete success. I can enter into sympathy with "PHILISCUS," in his enthusiasm respecting the excitement and interest attendant on the issue of natural swarms; but as I am situated it is a pleasure with which I never indulge myself unless a swarm comes off in spite of every exertion to prevent it. But to me there is something intensely interesting in the manipulation of artificial swarms, and the feeling that the operator has of being able to do pretty much what he wills with these little creatures. Certainly there is infinitely more of continued interest accompanying the management of bees on these more scientific principles, which I would not exchange for the shorter interest and excitement accompanying the issue of natural swarms.—S. BEVAN FOX, *Exeter*.

BEEES IN YORKSHIRE.

A CORRESPONDENT writing from the neighbourhood of Leeds, under date of the 2nd instant, says—"In all my ex-

perience of bee-keeping, I have never before known bees to gain weight so quickly as in the hot days of last month. Some of my strongest hives increased their weight by from 20 to 30 lbs. in about nine days; and I know of one hive that gained 40 lbs. weight in the same time. Since then we have had cold weather, and they have done little. We have a few swarms here, not many, but most of mine only require a few warm days to bring them out—in fact, I gave room to most, or I might have had swarms in May."

ARTIFICIAL COMBS.

MESSES. NEIGHBOUR & SONS, 149, Regent Street, and 127, Holborn, have submitted to me some specimens of artificial combs, with which they are now prepared to supply their customers. Whilst they are in every respect equal to those imported by me from Germany in 1862, they have the advantage of being expressly manufactured of a shape and size to suit the Woodbury-hives. Immediately on receiving them in the evening of the 29th ult., I placed one in a strong Ligurian and one in a common stock. On examining them this morning (2nd June), I found the Ligurians had worked one-half of theirs into beautiful comb, which the queen had already filled with eggs. The black bees had also partially fabricated their sheet of embossed wax into comb, but had not made so much progress as their Italian brethren, nor had their queen yet deposited eggs in the cells. It must be borne in mind that the weather during the past week has been so chilly as entirely to put a stop to comb-building under ordinary circumstances. Had the temperature been warmer, I have no doubt that both combs would have been completed before this.—A DEVONSHIRE BEE-KEEPER.

EARLY HONEY.

TO-DAY (June 1st), I lifted off the finest super of honey it has ever been my lot to obtain so early in the season. The hive was supered early in May with an octagonal glass box 13½ inches in diameter by 7 inches in depth. By the 18th of May this super was so nearly filled that I ordered my carpenter to make a second glass box corresponding in size and depth. In the meantime the super was lifted temporarily on a wooden octagon eke of 3 inches in depth. The bees rapidly continued the combs down into the space thus given. To-day (June 1st) I proceeded to take off the super for the purpose of removing the temporary eke, and raising it on the new and deeper octagon glass box. The whole of the combs were attached to the adapter, and filled with honey, a very small part, and that in the eke, being unsealed. The nett weight of honey in the super is nearly 40lbs. Perhaps I ought to be contented with this, and after removing the super either replace it with another or force a swarm. But I am anxious to obtain a very large and ornamental glass box of honeycombs, so after detaching the eke the original super was lifted on the new box, the 3 inches of exposed combs depending so far down into it. The combined octagons now form a single box of nearly 15 inches in depth, and I have little doubt will be easily filled by the bees, provided they do not swarm. This same stock gave me 50 lbs. of honey in supers last year.

Thanks to a few puffs of tobacco-smoke I was enabled to remove and reverse this heavy super crammed with bees, cut through the combs attached to the sides of the wooden eke, remove that, and restore all to the proper position with hardly any annoyance from a single irate bee. A few more of my stocks are working pretty well in supers, but only one other is doing anything nearly approaching to the foregoing.—S. BEVAN FOX, *Exeter*.

OUR LETTER BOX.

IMITATORS OF THE NIGHTINGALE (*Nightingale*).—Of the birds mentioned in your note, the Linnet, Mule, Goldfinch, Mule, and Canary, I should think, would be the most likely to learn the Nightingale's song, but they must be placed in hearing of the Nightingale while quite young, and great care is necessary not to let them hear any other birds, or they will not sing the more difficult notes.—B. P. BREST.

WEEKLY CALENDAR.

Day of M'th	Day of Week.	JUNE 14—20, 1864.	Average Temperature near London.			Rain in last 37 years.	Sun Rises.	Sun Sets.	Moon Rises.	Moon Sets.	Moon's Age.	Clock before Sun.	Day of Year.
			Day.	Night.	Mean.	Days.	m. h.	m. h.	m. h.	m. h.	m. h.	m. h.	
14	Tu	Mosa Rose flowers.	72.8	48.5	60.4	16	44 af 3	16 af 8	16 2	24 0	10	0 0	166
15	W	Henbane flowers.	72.9	49.0	60.9	16	44 3	17 8	25 3	48 0	11	0 13	167
16	Th	Bitter Vernal Grass ripe.	72.7	48.9	60.8	16	44 3	17 8	34 4	15 1	12	0 26	168
17	F	Corn Cockle flowers.	72.8	48.2	60.5	21	44 3	17 8	42 5	48 1	13	0 38	169
18	S	Bee Orchis flowers.	72.6	49.9	61.2	18	44 3	18 8	48 6	30 2	14	0 51	170
19	SUN	4 SUNDAY AFTER TRINITY.	72.9	49.1	61.0	20	44 3	18 8	46 7	21 3	15	1 4	171
20	M	QUEEN VICTORIA ACCESSION, 1837.	72.0	49.3	60.7	18	44 3	18 8	35 8	24 4	16	1 17	172

From observations taken near London during the last thirty-seven years, the average day temperature of the week is 72.6°, and its night temperature 49.0°. The greatest heat was 93° on the 19th, 1846; and the lowest cold, 30°, on the 15th, 1850. The greatest fall of rain was 0.80 inch.

LATE CROPS OF PEAS.

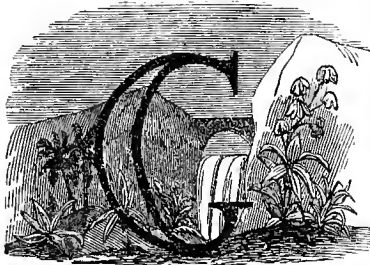

REEN Peas will have been plentiful even in gardens of no great reputation for earliness long before this article comes before the readers of THE JOURNAL OF HORTICULTURE, so that the subject of early Peas and how to

obtain them need not be touched on, further than to remark that the many difficulties there are in some gardens in obtaining them early ought to be duly considered, and the gardener should not be inconsiderately blamed who is unable to furnish them so soon perhaps as some of his neighbours. The fact is that Peas, like many other things grown out of doors, are more influenced by the soil and situation than by the mode of treatment they are subjected to, so that in an adverse soil it is impossible with ordinary means to obtain them so early as they can be had in one of a more suitable kind.

A particular friend of mine well versed in all departments of the cultural art, and having the management of a large garden that for ordinary purposes would be pronounced a good one, told me he never could obtain a dish of Peas so early as a neighbouring farmer who grew his in a field, and who always beat him by five or six days. The reason was obvious—the one was on a rather cool clay bottom, the other on a dry gravel, and the latter more than compensated for the want of shelter, so that there was always the above difference. I merely mention this in order to remove an erroneous idea that is sometimes entertained—that a sheltered garden ought always to be earlier than an open field; in the matter of Peas it is not. I am not prepared to say that some crops, the growth of which takes place mostly in winter, may not be earlier and better in the garden than in the field, even where the latter has the advantage of a drier soil; but when the sunny weather of early summer sets in, the dry warm bottom tells then, and in some cases severely too; for though it may and does cause the production of an earlier crop of Peas than in a cooler soil, the latter has the advantage of supporting a continuation of the crop, which the other would not do excepting in a showery season. This digression on the subject of soils necessary to insure a succession of crops of Peas may therefore be excused, as it is of the utmost importance when Peas are wanted in good condition during the latter part of August and September that there should be a suitable soil, or something afforded as compensation for the lack of what is so essential to their well-being at that time.

By the above it will be seen that the dry early soils favouring the early maturity of Peas are not those likely to afford a dish late in the season: therefore, such must not be expected; and if the dry chalky soils of some of

the counties surrounding London furnish its markets with Peas in June, the supply for the after-months is often obtained from a moister district. The north and north-west, where more rain falls, are so much better for late crops that it is not unusual, nay, even an almost every-year occurrence, to see whole rows of Peas in a bearing state until the sharp frosts of autumn check their further development. The cooling of the ground and the greater amount of humidity in the atmosphere tend to prolong a healthy growth instead of hastening that immature ripening, so fatal in soils of a contrary description. Peas, therefore, for table purposes after the end of July, ought to be grown in cool moist situations—not in stagnant swamps, certainly, but in such deep kindly soils as furnish the plants with the amount of nourishment required at a period different from that in which Nature intended them to be in an active growing state. Even this state of the soil is not sufficient to secure fruitful growth without an equally or, I might say, more important condition of the atmosphere, which ought to be liberally charged with moisture. To effect this by artificial means is impracticable, but something may be done to assist the plant in producing a nice healthy crop of pods well filled with Peas of a suitable kind.

As all gardens do not alike possess a good site for early Peas and a suitable one for the late crop also, it becomes necessary, when the soil is unfavourable to the growth of the latter, to secure some of the best ground that is at command, and trench it well during the preceding winter, adding some dung deep rather than near the surface. On ground of this description sow some of the hardiest and most robust varieties at the suitable time, and give more room between the rows than is usually allowed. When they are up about 18 inches or so, and in a strong growing state, give them some liquid manure at a time, if possible, when there is a little rain falling. This will encourage their growth, and also conduce to their fruitfulness. Deluging with cold spring water in dry sultry weather is apt to cause the production of gross haulm rather than pods; the ground, however, near the Peas might be moistened with such water during hot weather. The situation being open it will be all the better if even what wind we have at this time be at liberty to play on the plants, as it will tend to keep away mildew, that pest to the Pea in the latter part of summer, and which admits of little or no cure when it has once laid hold of its prey. Keeping, therefore, a healthy growth is the only preventive, and the best remedy is deep cultivation and the application of liquid manure, not too strong, at a time when the plant is most in want of food, which is, as stated above, when rain is falling. Should there be no fall of rain when it seems to be most wanted, some dull evening may be selected for supplying the liquid manure; but more importance must be attached to the deep and healthy action of the roots than to such unnatural feeding, although to secure a dish of Peas every day in September is worth any trouble that may be necessary.

Of the variety of Peas for sowing late in the season I

have little to say further than that it ought to be hardy, and capable of withstanding as far as possible the hot dry weather of the dog-days. Some growers prefer the early sorts for this purpose, but they are certainly not all well fitted for it; neither are the very tall Marrow class, which rarely fill their large pods. For general purposes I have found the Champion of England and British Queen pretty good, and others of similar growth. In Peas late in the season, as in the case of early ones, the quality of the Pea as a table favourite must not be too strictly inquired into, as some of the varieties most popular at table in the best part of the season are by no means the best for late work. There is another condition I would advise the inexperienced not to forget, and that is, not to overtop them with stakes; too great a quantity of stakes deprives them of much of the night dews, which are so beneficial to their growth and so detrimental to insect life. Another condition which I fear cannot be enforced, as I find it difficult to comply with myself, and that is, not to plant or grow other crops between the Peas, but to give them all the advantage of a good circulation of air, frequent stirring of the soil, and the other conditions noticed above. Though in seasons like 1859 it may be difficult to preserve a healthy growth in Peas so late in the season in the dry soils of some districts, there are others in which it may be secured, and even under adverse circumstances much may be done in ordinary years to prolong the bearing of the Pea. J. Robson.

CULTIVATION OF THE PINE APPLE.

(Continued from page 361.)

To start Pines into fruit at any given time, and more especially in early spring, it is necessary, to do so satisfactorily, that they should have a period of rest previous to their being subjected to the treatment required to start them. Plants that have completed their growth, and well filled their pots with roots in autumn, with the view of supplying ripe fruit in the following May and June must have ten or twelve weeks rest before attempting to start them. The conditions necessary to insure almost a cessation of growth, and at the same time to continue the plants in a state of thorough health, I need scarcely say are few and simple. They are a comparatively low temperature, and a dry atmosphere, with a proportionately dry state of the soil in which they grow.

From the middle or end of October onwards to the beginning of January, it rarely occurs that Pines are the better of a drop of water at the roots, providing that the plunging material is kept in a medium state of moisture, and that the bottom heat is not too high. The night temperature during the months of November and December should range as steadily at 55° at night as possible during cold weather; with very mild weather it may safely range a few degrees higher. The bottom heat should be proportionately low, just enough to maintain the roots in a white, healthy condition, without exciting them to action, and a temperature ranging from 70° to 75° is sufficient for this. When with sun heat during the day, which may occur with clear frosty weather, the temperature exceeds 65°, air should be given, and, in fact, a little should be admitted on all favourable opportunities for a few hours every day. When it is necessary to fire sharply during cold, frosty nights, in order to maintain the desired temperature, the fires should be checked the first thing in the morning, especially if, as is usual, a cold night is succeeded by a sunny day. Where it can be so arranged that coverings can be used over the glass at night, in order to husband the heat and maintain the proper degree with less fire heat, the atmosphere can be kept in a condition much more congenial to the Pine than when more fire heat is necessary. For although a damp atmosphere, which would lead to an accumulation of moisture and drip on the leaves and into the centres of the plants, is by all means to be avoided, yet a parching atmosphere produced by highly-heated pipes is very prejudicial, and cannot be properly counteracted during the winter months by the application of moisture to the pipes without producing the opposite evil. When, however, it may become necessary to apply moisture to counteract the too drying effects of Lard firing, it is safest to sprinkle the paths, from

which the moisture will find its way more gradually into the atmosphere, and is not, therefore, so likely to accumulate and drop into the centre of the plant, causing spotted leaves, and not unfrequently deformed fruit. This is more particularly applicable to pineries and pits with flat roofs from which moisture is more likely to drip.

Treatment the reverse of what has been recommended—a high temperature and more water at the root and in the air—will end in causing the plants to grow all winter, and from the want of light and air they will become drawn and weakly, in fact worthless; or probably many of them may start at the dead of winter, when they will not bloom nor set properly, and will either way be useless. An instance of such treatment once came under my notice, when the whole winter, instead of a low temperature, 75° of heat was kept up with moisture in abundance; and the consequence was, that when the time that they should have started arrived, they were tall, tender, and only fit for the waste heap.

Ripe Pines being required by the early part of June, it will be necessary to set a batch of Queens in motion in January, to succeed those that are generally termed winter and spring fruited, and which consist of Cayennes and Jamaicas. Presuming that the bottom heat is derived from leaves and tan, it will be necessary to add some fresh material to increase the bottom heat to from 85° to 90°. But in doing this particular attention must be paid to the state of the bed, as overmuch bottom heat at this stage would prove fatal to anything like success. The roots of the plants being principally at the bottom and round the sides of the pot, they are particularly liable to suffer from too much heat, and great caution is necessary; should there be any doubt about the heating of the bed after it is prepared, it will be safer to stand the pots on the surface of the tan till it be certain that the heat will not rise above that already named. Those who have the superior appliances of hot-water pipes or tanks for the supply of bottom heat, will be spared the trouble and risk of a fermenting-bed, and can regulate the heat to a degree.

In selecting the plants for starting at this early season, those only which have matured their growth early in autumn, and have their pots full of healthy roots should be taken, because it is those plants which start into fruit without making a fresh growth that can be started and ripened very early in the summer. Plants that are not so forward in this respect, make first a fresh growth and then start into fruit, and always show larger and finer fruit than the former, to which they make a succession by starting in March and April.

In arranging and plunging the plants, a few of the bottom leaves should be stripped off round their collars, and if the soil be low in the pots a top-dressing of loam firmly pressed to the stems and round the sides of the pots should be applied. The plants being kept dry through the winter, they will require to be watered twice in order to properly moisten the ball, as loam once dry is not very easily moistened thoroughly. The atmospheric heat should be raised to 65° by night, with a rise of 10° by day when there is sun. Moisture must also be increased in due proportion by keeping the paths well sprinkled, but avoid much evaporation from hot pipes for the first month. A little air should be given in the early part of the day, shutting up early in the afternoon to husband sun heat, when such can be had.

As the season advances the heat should be increased 5° more, with at the same time an increased amount of moisture. The plants should be examined occasionally, and watered just sufficiently to keep the soil in a medium state of moisture. If allowed to get over-dry the embryo fruit will become stunted, while on the other hand, an excess of moisture will be equally fatal to healthy root-action.

The principal part of the plants should show fruit before the end of February. The centres of the plants will be observed to open-up by degrees, and on examination the young fruit will be seen emerging from the centre. Whenever this is observed the plants, if dry at the roots, should have a good watering with weak manure water sufficient to thoroughly moisten the whole ball.

Throughout the month of March, supposing the plants to be all in fruit, the night temperature should not range under 70°, nor over 75° when the weather is not more than usually cold. Atmospheric moisture should now be freely given as

soon as they are all out of flower, and on fine afternoons a sprinkling overhead with tepid water will much refresh and invigorate the plants. Early shutting-up with a high sun heat must now be practised, presuming that the fruit is required to be ripe as soon as possible. When April arrives with its longer and generally brighter days but with chilly nights, I would not advise an advance on the temperature directed for March, only let the forcing be done as much as possible by day with sun heat. They should be shut up by two o'clock with abundance of moisture in the atmosphere, and the heat may be allowed to run up to 90°, or even more for an hour or two. The fires, which should be low through the day, should be quickened in sufficient time to prevent the heat from falling below 70° by 10 p.m. The fruit will soon begin to swell rapidly, and careful attention must be given to the plants in the matter of moisture at the roots, and they should have the water coloured every time with good Peruvian guano, which I prefer to anything else that I have tried for the Pine.

The plants should be gone over and the suckers reduced to two on each plant, and all suckers and gills which appear on the stems or under the base of the fruit should be removed immediately they are observed. The month of May generally brings comparatively warm and sunny weather, and vegetation gets into full play, and I am not sure but what May is one of the best, if not the best month in all the year for swelling Pines. It is not generally so hot and scorching as the succeeding three months, less air is necessary, the pineries can be shut up earlier, so that less evaporation goes on, and the swelling fruit can have a longer period of sun heat and moisture in the afternoon than when summer is farther advanced, and when it is not safe to damp and shut up before four o'clock. Advantage should, therefore, be taken of this, and the house should be shut up early in the afternoon, at the same time sprinkling the plants with tepid water and filling up the evaporating-troughs. But syringing must not be carried to excess, or the result will be an undue growth of crowns and suckers. Some say that suckers rob the fruit, and that larger fruit can be had by removing them all before the fruit is matured. I have not found that such is the case, and apart from the absolute need of strong suckers, I consider the theory not generally correct. The extra foliage of the suckers only causes an extra root-action; so that, especially when the suckers are not on the stems of the fruit, the latter are not likely to suffer from one or two on each plant.

When the fruit begins to change colour it is necessary in order to insure fine flavour, to admit an increased amount of air and to decrease the moisture both in the air and soil. This, however, must not be done abruptly but gradually, and as soon as the fruit shows the least signs of turning yellow at the base. The soil when the fruit is fully ripe should be quite dry.

It is a good plan to remove the suckers before this change of atmosphere and decrease of moisture at the root is commenced, otherwise they are likely to receive a check which stunts their growth. I do not approve of drying half the life out of suckers after they are potted, but have found that the finest plants are always obtained from the suckers that are potted in a fresh and growing condition.

D. THOMSON.

(To be continued.)

PEARS.—The enormous crop of Pears which set freely this spring bade fair to injure the trees; but Nature has stepped in to thin them, for in every cluster of fruit are several that, like those enclosed, are swelling more rapidly and look more fair and promising than others. On cutting them open the core is found full of small grubs. In a week or two the fruit thus affected will drop, and leave on many trees a poor crop, for these promising Pears on many trees can be counted by thousands. A word or two as to when the insect deposited its eggs, and what it is will oblige.—SUBSCRIBER.

[The Pears are infested by the minute yellow larvæ of *Sciara Pyri*, usually called the Pear Midge. It is described in detail in Kollar's "Treatise on Insects," translated by Miss Loudon. All the dropped Pears should be burnt, or in some other way destroyed.]

THE ROYAL BOTANIC SOCIETY'S SHOW.

JUNE 11TH.

EVERYBODY looks for a fine show at the Regent's Park, and rarely, indeed, is it that any one is disappointed. That of Saturday last was no exception to the general rule: the Stove and Greenhouse Plants, the Orchids, the Pelargoniums, the Heaths were all fine; the fruit was excellent; the American plants of Mr. John Waterer a glorious spectacle; and in addition to all this, the day was fine without being so hot as to render locomotion unpleasant even in the show-tent, so it cannot be wondered that the company should be numbered by thousands.

STOVE AND GREENHOUSE PLANTS, as regards the kinds exhibited, were much the same as at previous shows, and some were hardly so good after the service they had seen. The finest collections of sixteen came from Mr. Whitbread, of Dartford; and Mr. May, of Hawkesyard Park. The former had the beautiful *Pteroma elegans*, a very fine *Stephanotis*, *Allamandas grandiflora* and *cathartica*, the bright blue *Leschenaultia biloba major*, *Aotus gracillima* covered with its yellow and red flowers, *Ixora coccinea* (very fine), the showy *Dillwynia rudis sanguinea*, and an immense *Erica Cavendishii*. Mr. May had among others two fine *Ixoras*, a very large *Pimelea* in fine bloom, *Rhynchospermum jasminoides*, the white *Dracophyllum gracile*, and *Dipladenia crassinoda*. Mr. Peed was third, Mr. Wheeler fourth.

For collections of ten, in the Nurserymen's Class, Mr. Fraser, Lea Bridge, was first, Mr. Rhodes second, Messrs. Lee third, and Mr. Cutbush, Barnet, fourth; and in the Amateurs' Class Mr. Chilman and Mr. Green were first and second. For a collection of six Mr. Page had a first prize. Among the plants of these exhibitors *Gompholobium polymorphum splendens* was noticeable by its numerous scarlet blooms; *Allamanda grandiflora*, with its large clear yellow flowers; *Prostanthera lasiantha*, covered with bloom; *Hoya bella*; *Erica obbata*; *Hedera tulipiferum* and *fuchsoides*, very fine; and *Phœnecoma prolifera*, a large bush.

Collections of fine-foliated plants came from Messrs. Lee, A. Henderson & Co., and Williams, who had prizes in the order in which they are named. From Messrs. Lee came fine specimens of the Bird's-nest *Neottopteris australasica*, *Cyathea Smithii*, *Pandanus utilis* and *elegantissimus*, and *Cordyline indivisa*; from Messrs. Henderson a very large and fine plant of *Pandanus utilis*, *Anthurium leuconeurum*, the singular zebra-stemmed *Alocasia zebra*, the large splashed-leaved *Alocasia macrorrhiza variegata*; and from Mr. Williams *Alocasia metallica* (very fine), the fine broad-leaved *Cyanophyllum-like Spharogyne latifolia*, the new *Agave schidigera*, *Cycas revoluta* and *Cyathea dealbata*, both very large plants.

FERNS.—Mr. Williams and Mr. Bull each contributed remarkably fine specimens of exotic Ferns. From Mr. Williams, who had the first prize, came handsome plants of *Gleichenias semivestita*, *speluncæ*, and *dichotoma*, *Todea africana*, a noble plant of *Cibotium princeps*, *Cyathea Smithii*, *Dicksonia antarctica*, a very pretty plant of *Adiantum cuneatum*, and some others. Mr. Bull sent *Dicksonias culcita*, *antarctica*, and *squarrosa*, *Cyathea dealbata*, *Marattia elegans*, *Lomaria cycadifolia*, *Blechnum brasiliense*, *Todea australis*, &c. These, too, were fine specimens. Mr. Young, of Highgate, took the third prize.

Of hardy British Ferns Messrs. Ivery contributed two collections, one of twelve, for which they had a prize, and another of upwards of fifty, comprising many very rare varieties.

ORCHIDS were extensively shown, but looked scarcely so fresh as on the last occasion. *Lælias*, *Cattleyas*, *Vandas*, *Phalænopsis*, *Dendrobiums*, *Cypripediums*, *Ærides*, and *Saccolabiums*, were well represented. Of *Ærides Lobbi*, *Larpenæ*, and *crispum*, there were several fine examples. *Cypripedium villosum*, and the varieties of *barbatum*, were shown in fine condition; and we noticed two or three plants of *Stenei* and *Hookeri*, the rare *Odontoglossum Phalænopsis*, two fine pots of *Orchis foliosa*, and *Dendrobium Parishii*, from Mr. Williams. Mr. Baker and Mr. Milford were first and second for collections of twenty, Mr. Peed taking a fourth prize. Messrs. Penny, Page, and Green, were the prizetakers for collections of twelve; and Mr. Williams, Messrs. Jackson, Mr. Wooley, and Mr. Rhodes, in the Nursery-

men's class for six. In the corresponding class for Amateurs Mr. Fairbairn, gardener to the Duke of Northumberland, Syon, was first; Mr. Wilson, Enfield, second; and Mr. Wiggins, Isleworth, third.

HEATHS are a class of plants which have gone out of fashion of late years, but any one seeing the fine specimens exhibited at our metropolitan shows must agree that they deserve a greater share of popularity. Numerous plants of the *ventricosa* and *tricolor* varieties were exhibited, also *Candoleana*, *obbata*, *floribunda*, *nobilis*, *Bergiana* and *Masoni*, &c. For ten Mr. Rhodes was first, Messrs. Jackson second; for eight Mr. Peed first, Mr. Page second; for six Mr. Chilman first, Mr. Wheeler second.

AZALEAS were much inferior to those at the previous show; those of Mr. Turner, however, were still fine, especially his large plants of *Criterion*, *Juliana*, and *Gledstanesi*. Mr. Turner was first, Mr. Fraser second, Mr. Rhodes third. In the Amateurs' Class, of Mr. Whitbread's, who had the first prize, the most noticeable were *Extranei* (fine), *Striata formosissima* (a fine white, in the specimen shown very little striped), *Chelsoni*, and *Gledstanesi formosa*. Mr. Carson, who was second, had very good plants of *Apollo*, *Modesta*, *Iveryana*, and *Optima*. Mr. Cross was third.

FUCHSIAS.—Mr. Cannell, gardener to J. Watson, Esq., took the first prize with *Sir E. Peel*, *Madame Cornelissen* in fine bloom, *Lord Elcho*, *Fair Oriana*, and *Prince Alfred*. Mr. Cross, who was second, had large plants, but not sufficiently covered with bloom, of *Comet*, *Bo-peep*, *Victor Emmanuel*, *Rose of Castille*, *Fair Oriana*, and *Queen of Hannover*. Mr. Young was third.

PELARGONIUMS.—In the Amateurs' Class Mr. Bailey, of Shardeloes, was again triumphant, with immense plants in splendid bloom. They were *James Lodge*, *Spotted Gem*, *Patroness*, *Guillaume Severyns*, *Lord Clyde*, *Glowworm*, *Sanspareil*, *Desdemona*, *Nestor*, and *Flora*. Mr. Nye, who was second, had also excellent specimens, one, *Sanspareil*, being particularly remarkable for its great size and profusion of bloom. Mr. Wiggins, who was third, had also very good plants. The only exhibitor in the Nurserymen's Class was Mr. Fraser, who, in addition to kinds already named, had *Bacchus*, *Rose Celestial*, *Roseleaf*, *Fairest of the Fair*, *Excelsior*, *Prince of Prussia*, and *Madame Furtado*. Coming from such a well-known exhibitor, it is almost unnecessary to say that the plants were first-rate. For Fancies, first prizes were awarded to Mr. Fraser and Mr. Bailey, the former being again the only exhibitor in the Nurserymen's class; Mr. Cox, gardener to Captain Cahill, and Mr. Donald Leyton, were second and third. *Delicatum*, from Mr. Fraser, was a beautiful mass of bloom. *Arabella Goddard*, *Clemantle*, *Lady Craven*, *Crystal Beauty*, *Princess Royal*, *Roi des Fantaisies*, and others in the two first-prize collections were all that could be desired.

To the other objects exhibited we shall return next week, but the opportunity of noticing Mr. J. Waterer's American plants must not be lost, as they are now at their best. They occupy an area of about 100 yards across each way, and are arranged so as to contrast their colours, and produce an excellent effect from different points of view. The scene, when viewed from the high end of the tent, is such as no one who has not seen the magnificent display of former years can form the faintest conception of. Of new kinds *Joseph Whitworth* is a very fine dark rosy purple, and with excellent foliage; *Annihilator* is a magnificent rosy scarlet, with large trusses. Mrs. John Penn, salmon pink, edged with crimson; *Lady Emily Peel*, rosy crimson, with black spots; *Princess Mary of Cambridge*, rosy purple, with almost white centre, are also fine. To these may be added *Raphael*, Mrs. T. Brassey, Duchess of Sutherland, and Mrs. Fitzgerald, the last very bright in colour, which are likewise new varieties of great merit. Of older varieties there is an abundance, and most of them are in great perfection, and some of the plants are of very large size. Altogether the Show reflects much credit on Mr. John Waterer, from whose nursery alone the whole of the plants have been taken.

HOW TO SET GATE POSTS.—The *Ohio Farmer* gives the following directions on this subject:—Take equal quantities of water lime, and quick lime, and mix with sand as usual; put 2 or 3 inches of mortar and coarse gravel in the bottom

of the hole, so that the end of the post will not come to the ground; then set your post in, top end down, fill in several inches of the mortar, then several inches of coarse gravel; pound it down, then more mortar and more gravel, and so on until the cement is raised above ground several inches around the post. Slant it away from the post in every direction, so as to turn off the water; char the bottom of the post, before inserting, and fill the interstice between the post and cement with coal tar. Only mix enough mortar for one hole at a time.

FURZE VERSUS GOOSEBERRY CATERPILLARS.

HAVING tested the insertion of Furze in full blossom in the centre of my Gooseberry bushes as a remedy for caterpillars, and found it completely fail, I next applied the wash recommended at page 246 of the Journal. The proportions of soap, soda, and water used were the same as given. All I can say is that the prescription may have mitigated but has by no means cured the evil. The caterpillars dislike the wash, but it does not kill them; and one result attending its application has been to injure a great many of the leaves, giving them the appearance which potato leaves present when first affected by the blight. Both a syringe and water-pot were used, and the time chosen for the operation was during brilliant sunshine about midday. Two hours afterwards rain and thunder followed.—R. S.

[It is curious to note how the evidence varies on this alleged remedy. In our Number last week a clerical correspondent states that the Furze was quite effectual. This subject deserves elucidation. Can it be that the odour of the blossom of the Furze is only fatal to the caterpillars whilst they are very young?]

DISTRIBUTION OF PLANTS IN GENERAL,

AND ALPINE PRIMULAS IN PARTICULAR.

(Concluded from page 392.)

IN beds alpine Primulas require very little care, but do not like that exposure to the sun which they too often receive in mixed borders; and the hoe and rake should not be continually used near them. A little moss placed round them after dry weather sets in will be beneficial, and if a tuft of grass spring up near them they very soon incline towards it. I have them in beds, on an east border, and they get no sun after eleven o'clock, but all the light and fresh air possible. The beds are 4 feet wide with two-foot alleys between them, and are raised a little in the middle. We plant in spring, the strongest growers nearest the alleys, and the smallest on the ridge, the bed itself being formed into terraces: that next the alley is 1 foot wide, the next the same width, but 6 inches higher, and then a centre one. Thus there are five terraces, on each of which there is a row of plants exactly in the centre, and at such distances that the plants may stand clear of each other. The terraces should incline towards the centre of the bed, and the side be made sloping between the terraces. In dry weather the plants will require watering about twice a-week, and when the leaves have risen so as to admit of an inch of moss being placed around the plants do so, covering the whole of the surface, and if it be done nicely you will have some charming things rising, as it were, from a terraced bed of green velvet. Before putting on the surfacing of moss it is well to give a good watering, and one every week after the moss is put on in dry weather is all that is needed, for the moss keeps the soil moist and the roots cool. When the flowering is past no water is needed, and no attention beyond removing decayed leaves and pulling up weeds.

In autumn the moss should be removed, and a little fresh soil placed around the plants, but not so as to come above the collar, for if buried too deep they are apt to damp off, and to prevent this I have found a little sharp sand placed round the neck of each very effectual. This surfacing of soil is rendered necessary by the crowns of the plants being higher from an additional year's growth, for the crowns get higher every year, and would, were no soil placed round them, grow nearly out of the ground. Most persons who grow *Auriculas* and double *Primroses* in borders will have

noticed this—the plants getting higher every year, and in a year or two appearing as if standing on a hillock, with the roots exposed. These plants naturally grow in meadows, and their roots are not then exposed, for the moss and decayed herbage annually form a deposit of vegetable matter by which the roots are protected in winter, and through which the new roots can penetrate freely in the spring. *Primula farinosa* and some others occasionally throw themselves out of the soil in winter when not top-dressed in autumn. The best of all autumn dressings is covering the bed with half an inch of cocoa-nut dust, pressing it tightly round the plants, and spreading stems of Fern over the surface, not so as to cover the plants and deprive them of air and light, but to give a sort of shelter like that afforded by decayed herbage. In March the Fern should be removed, and about half an inch of fresh compost placed evenly over the bed, and this neatly forked over, but not so deeply as to injure the roots, will mix the cocoa-nut dust with the old surface soil and new compost, and the plants are not long before they show how much they like it. In May the bed is again covered with moss, and even if there were no plants in the bed the mossy terraces would look well; and when the plants rise above the moss with beautiful silvery, mealy, or shining bright green leaves, the appearance is charming. When in bloom a shading of tiffany or some such material, will materially prolong its duration, and contribute to the vigour of the plants. With this, and the moss kept moist, they will continue in bloom six weeks or more.

Although the above treatment is such as I would advise, yet where there are rockeries, with nice nooks and corners situated to the east and near the foot, these plants may be grown well. The openings should be filled with a sufficiency of the compost named; and the plants being put in they will need watering in dry weather, keeping clear of weeds and the encroachments of their neighbours, and a surfacing of fresh soil early every spring.

Another good way of growing these plants is to form a bed 4 feet wide, and to cover the bottom with rubble to a depth of 6 inches. A row of bricks on edge is then placed all round the bed, then some more bricks are placed lengthwise across—one at each of the joints between the bricks placed round the bed, which will require three-quarters of a brick at each corner to make them fit properly. This done we have some openings resembling a rectangle open at one end, and these are to be filled with compost, and the space within the bed raised level with the brick by placing some rubble on that below it. It is better to defer putting in the compost until all the openings are prepared, and to fill in the space with rubble level with the bricks, leaving the rectangular spaces to be filled in when the whole is completed. After the first row of openings has been made by the bricks arranged along the bed, and then across it, place more bricks lengthwise along the bed, with their ends resting on the cross bricks at each end, and standing them on these, so that the edge of the bricks will be even with the ends of the cross bricks at that end towards the inside of the bed. This row, like the first, runs all round the bed, and does not differ from it, only the first is placed on the rubble, the second on the cross bricks. We now place the cross bricks as with the first row, then add more rubble, bringing up the middle of the bed level with the bricks, then more bricks again, then rubble, and so on till a terrace is formed at top, which is to be divided by pieces of bricks to correspond with the other openings in the terraces below them. We have now several terraces divided by the cross bricks into square openings which are to be filled with compost, and a plant placed in each. In this way every plant stands by itself, and so can be specially accommodated with the soil most suitable for the kind, and can be afforded different treatment from its neighbour. Moreover, the terraced bed is really ornamental if neatly constructed, and stagnant water cannot by any means lodge there. In short, it is just the right thing for plants that like a free exposure to the atmosphere and a moist soil but free from stagnant water. Drainage is afforded by the rubble, and the bricks being porous hold about a pint of water each, and this prevents the soil from becoming suddenly dry; and it materially assists in keeping the bricks cool if they are sprinkled with water on the evenings of hot days. In this way a small space is made to hold a great number of plants, any one of which can be treated indepen-

dently of its neighbour. Such a bed is very useful for affording a supply of Parsley in winter and early spring.

I cannot conclude without mentioning a few of the kinds most worthy of cultivation.

- Primula suaveolens*, a sweet-scented, yellow-flowering kind, from Italy, blooming from March to May, 6 inches.
- P. brevistyla*, a pretty yellow-flowering French species, with short styles, as its name implies, flowering from May to July, 3 inches.
- P. calveina*, a charming pink-flowering species, from Switzerland the flowers appearing in June and July. (Requires a compost of peat and loam.) 3 inches.
- P. ciliata*, pretty rosy purple flowers, appearing in April and May, Switzerland, 3 inches.
- P. nivalis*, flowers purple, in April and May, Dahuria, 6 inches.
- P. villosa*, flowers purple, showing in April and May, Switzerland, 3 inches. (Peat and loam are most suitable for it.)
- P. altaica*, pretty deep rose-flowering variety, blooming in June and July, Altai Mountains, 3 inches. (Peat and loam.)
- P. finmarchica* (*P. norvegica*), lovely violet-flowering species, from Norway, April to June, 3 inches. (Peat and loam.)
- P. decora*, a comely kind indeed, having pink flowers from April to June; rather tender and impatient of stagnant water. 3 inches. (Peat and loam.)
- P. nivea* (*P. nivalis* of some), from Switzerland, flowers pure white, Siberia, 6 inches. (Sandy peat)⁴
- P. amœna*, flowers pleasing purple, in May, Caucasus.
- P. marginata*, the leaves edged with silver. It has pink flowers in May, and is from Switzerland, growing 4 inches high. There is a variety of this, *P. marginata major*, much finer, if it be possible, with larger flowers.
- P. viscosa*, purple-flowering, Piedmont, 3 inches.
- P. latifolia*, with blood red flowers, 4 inches. (Peat and loam.)
- P. carniolica*, a curious-flowering purple species, blooming in April, Carniola, 3 inches.
- P. denticulata*, purple-flowering; very pretty on account of its toothed leaves. It flowers in June.
- P. longiflora*, a fine species of the *P. farinosa* breed, with bright rose flowers in June and July.
- P. longifolia*, deep rose flowers, appearing in May; rather tender, from the Levant, 6 inches.
- P. farinosa*, a lovely gem, flowers deep pink, in June, Britain.
- P. scotica*, charming, flowers between a red and purple. It blooms in June and July. From the alpine heaths of Scotland. Requires free exposure, but protection from the burning rays of the sun.
- P. minima*, plants 1 to 2 inches high, producing very large rose flowers in May. It is from the South of Europe, and is rather tender. There is a purple-flowering variety of this—viz., *P. minima angustifolia*, or *P. truncata* of some.

In addition to the above there are a number of others, and amongst new or rare ones may be named: *P. pubescens* (?) with large Auricula-like heads of deep purplish rose colour; *P. purpurea*, from the Himalayan mountains; *P. sikkimensis*; *P. Fortuni*, from China; *P. Stuartiana*, and many others well worth looking after. There are also some decent alpine Auriculas—as Sir Colin Campbell, Comet, Dazzle, Conspicua, Brutus, and Delight—which, with a number of seedlings to be had at a cheap rate, may be added to the list; and a few of the named Auriculas are really handsome amongst a collection of Primulas, and I think indispensable. —G. ABBEY.

HUMEA ELEGANS AND BOUVARDIA LONGIFLORA CULTURE.

UNLESS very large specimens of *Humea elegans* be the object of our correspondent, "J. L.," the end of May is the proper time to sow the seed. For the largest possible specimens it should be sown six weeks earlier. Presuming the former to be what will suit your case, the seed should be sown about the 24th of May in a pan or pot well drained. The soil should consist of equal parts of loam and leaf mould with enough of silver sand to make it sparkle. Sow on an even surface, and the seed being small cover very lightly with finely-sifted soil, water through a fine rose, and place in heat till the seedlings appear above ground. A Cucumber or Melon-frame where the pot or pan can be shaded will answer very well. When the seedlings are well up remove it to a cooler place, such as a cold frame or pit, and when the young plants can be handled prick them off into a box or pan according to the number required. When they meet in the pan they should be potted-off into three-inch pots, preserving a little ball to each plant. The soil for potting them off should consist of equal parts of rather light loam and thoroughly decomposed cowdung, and a little sand. When potted they should be returned to the cold frame and shaded for a few days. After this they should be gradually hardened-off till placed in the open air. Here they must be well supplied with water, and when the roots reach the bottom of the pots be shifted into six or

seven-inch pots, using the same compost and growing them on hardily as already directed. They must be kept in a regularly moist state at the root, for if subjected to severe droughts they will become rusty and lose some of their bottom leaves. They may remain in the open air till there is danger from frost, when they should be placed in their winter quarters in any cool dry place from which frost is excluded. Early in March they will require a shift into ten-inch pots, using the last-named compost. Light, air, and a cool temperature are indispensable in order to grow them into sturdy plants. Water must be freely given after they take; and an occasional watering of weak dung water will give them a fine dark green colour. In ten-inch pots they will make nice plants, large enough for ordinary purposes; but when large plants for any particular purpose are the object, then they will require, about the middle of May, a shift into larger pots. We grow quantities of them for back rows to flower-borders, and for that purpose they are never put into anything larger than eight-inch pots, and are planted out when 3 feet or more in height about the end of May, and in that way make fine plants.

The *Bouvardia* does not require more than an ordinary amount of water, and, of course, will suffer from any excess. See that it is well drained. Loam, leaf mould, and a little peat, the former in proportions equal to the two latter, will do well for it.—D. T.

FAIRLAWN.

AMONG the many seats of the nobility and gentry around the pleasant little town of Sevenoaks not the least important is Fairlawn, the residence of J. Ridgway, Esq., a gentleman ardently devoted to almost every branch of horticulture, but more especially to the cultivation of shrubs and trees, both indigenous and foreign, as well as of the many improved varieties which owe their existence to the skill and perseverance of cultivators who, like Mr. Ridgway, find a pleasure in waiting year after year to prove the merits of plants they have been instrumental in raising.

Although many other departments of gardening are equally well attended to at Fairlawn, the success of Mr. Ridgway's enterprise in planting out of doors classes of plants but rarely met with, has been so great that I need hardly offer any apology for making some of the features of the place known to the general reader before giving a few notes of the many interesting plants to be met with there.

The pleasant and commodious mansion of Fairlawn stands near the base of the southern slope of one of the many eminences by which the western part of the county of Kent is diversified. A considerable tract of tolerably level country spreads out to the south of it, over which the mansion is still sufficiently elevated to have a commanding view; while the high ground to the north is so well clothed with timber as to give all the shelter required. In front, as well as to the right and left, the undulations of the ground are of that easy and agreeable kind which unites the often discordant requirements of the farmer and landscape gardener. Judging from the appearance of the trees, hedges, pasture fields, and other kinds of vegetation that receive no particular artificial assistance, the soil would seem to be good, although, probably, much of the success here attained may be due to climatic influences, since a similar description of soil elsewhere would not be held in much estimation by farmers or others who assume to be judges of such matters. However, results always tell the most correct tale, and the many descriptions of plants which here prosper so well prove that their wants are supplied by the soil common to the neighbourhood; and where that has been insufficient for the purpose, importations of a more suitable kind have been liberally made. The natural soil seems to contain much that is necessary for the growth of the class of plants vaguely designated American plants, although in its composition it is so nicely balanced as not to have such an undue proportion of these elements as to prevent other things requiring a soil of an opposite character doing well also. In other words, it may be designated a somewhat loose stony soil, resting on a gravel more favourable to the roots of trees than that substance usually is.

The approach to the mansion is from the north-west, and

I believe also from an opposite direction, the park and grounds being agreeably diversified both ways. The kitchen garden is on a sort of raised terrace to the north of the house; while to the north of that another terrace of some three or four acres presented a good example of a cultivated orchard of mixed fruit trees, which no doubt consist of choice kinds. A large plot to the east of the mansion is occupied by a shrubbery, with some slopes and landings of turf descending to the south and terminating in the fine level base, which probably may have given the name to the place; for it would be difficult to look upon a lawn more fair than this. It is an oblong of about an acre, with a very slight inclination one way, but looking perfectly level. Excepting that a chain of flower-beds, edged with Box, and paths rendered cheerful with coloured gravels, extend along the north side of it next the mansion, the oblong presents an unbroken and uniform level, most tempting for the many games now so fashionable on the lawn. The shrubbery and kitchen garden running in a line on their eastern boundary, Mr. Ridgway has formed on that side the fine *Rhododendron*-border which I shall next endeavour to describe.

The series of slopes and terraces which give the kitchen garden and lawn a level appearance are here formed into an inclined plane falling uniformly to the south for a distance of 250 yards or more, there being a straight walk of that length some 10 or 12 feet broad, margined with grass verges of 2 feet wide. On each side of this walk are borders from 20 to 30 feet wide, planted with choice *Rhododendrons* and similar plants, all being in the most robust health. The strongest growers were put at the back, and still further back were the best varieties of Holly, some *Berberis*, and other shrubs. When I mention that such plants as *Berberis Darwinii* had attained the height of 10 or 12 feet, and would have been much more than that through had they not been cut-in to make room for others, I need hardly say that the whole were in excellent health. Even that difficult and generally shabby plant, *Berberis japonica*, had attained upwards of 4 feet in height, and was more healthy-looking than I had even seen it; while in the front were scores of Indian *Azaleas* in excellent health, and some had assumed a prostrate habit, and were rooting into the ground like the *Cotoneaster*, so as to afford abundance of plants, all being of the most luxuriant green. Accompanying these were several *Camellias*—one, the old Double White, was 5 feet high and nearly as much through, and had furnished a great quantity of blossom. The deciduous *Azaleas* and the various species of *Andromeda* were equally sturdy.

The *RHODODENDRONS* were unquestionably the most attractive feature; and in giving a list of a few that were in flower at the time of my visit, I must apologise for the limited number by saying that it was in April, somewhat before the hybrids in most repete come into flower; and although the promising condition of others not expanded might warrant my saying much in their favour, I will confine my remarks to those I saw.

Cinnamomeum (hybrid).—Fine white flowers in a large truss, very conspicuous. The plant, being 6 feet or more high, was an attractive object a long way off, even amongst others also claiming attention; and whatever may be the merit of other light-coloured kinds flowering at a later period, this will be difficult to beat at the time it is in perfection. The habit of the plant and its freedom of growth and flowering are alike good.

Album multiflorum.—Though not so white as the above, this is a good light kind, and deserves a place. It also seems to flower freely, and unlike some of the hybrids which only flower well in alternate years, it seems to do so every season. A large plant of it was very showy, and looked well.

Jackmanii.—This is also light-coloured, differing materially in the marking from the last-named. It is also good.

Favourite.—This is of the scarlet or crimson class, and amongst such ranks high, but it belongs to a section that has so many representatives that I am not prepared to say it is the best. On the contrary, I have seen *Alarm* in fine condition at another period; but at the time I saw them it was not in flower, and *Favourite* deserved its name.

Medora.—Resembling the last, and by some thought to be superior; the habit of the plant being somewhat different; it may also be pronounced good.

Vestitum roseum.—This is one of the rosy scarlet class, approaching the tint which is fashionably called Solferino, or that of a healthy flower of the old double Candytuft. It is certainly a very desirable variety of the hardy hybrid class.

Campanulatum superbum.—This differs so much in habit and appearance from the ordinary hybrids, that Mr. Ridgway thinks it not unlikely that one of its parents may have been of the Sikkim class. Whether this be so or not, it is a highly desirable variety, the flower being a fine white, and having more substance than is usually met with in the ordinary hybrids from older species. It is certainly useful in the smallest as well as the largest collection.

Louis Philippe.—This is certainly the finest of the hybrid class of the crimson-scarlet hue; and the large fine plant at Fairlawn was studded all over with the half-bursting buds that revealed the rich treat of gorgeous colouring that was forthcoming. By the kindness of Mr. Ridgway I have been since favoured with blooms of this and other varieties; and can only say, that in its colour nothing more could be wished for, unless, perhaps, it be the substance possessed by a species that will be mentioned hereafter. I would by all means advise those about to form a collection to include this in the list.

In naming the above hybrids I by no means assert that they are the best of their respective classes, but they with some others being in flower at the time I saw them, I can speak of their merits with every confidence. Hybrid varieties, as every one knows, bloom at various times, and I believe a greater number would have been out ten days after my visit than at the time. I was, nevertheless, well repaid by a sight of a splendid species in full flower, which belongs to a section which Mr. Ridgway was amongst the first to try out of doors—the Sikkim kinds. These are unquestionably destined to impart a distinct feature to our out-door Rhododendrons at no distant period, and those who live to see the results of hybridising now going on in that way, will witness a class of ornamental shrubs differing widely from the old *R. ponticum* of bygone days, the difference being alike perceptible in the foliage and habit of growth as in the flower. It is, however, needless to speculate on this; suffice it to say, that no one goes more ardently into this matter than the energetic proprietor of Fairlawn, and seedlings of various sizes, conditions, and appearances, carefully labelled and duly attended to, were to be met with in sundry odd corners. A considerable breadth of those more advanced in size occupied a plot in the kitchen garden, and will, I have no doubt, produce something valuable in due time, more especially as I expect much of the character of some of the Sikkim class will be exhibited by them. I believe Mr. Ridgway has been very successful in flowering specimens of this class; one or two, which were in flower when I was there, showed peculiarities much wanted in the hybrids heretofore regarded as the most imposing of our out-door Rhododendrons. The first in the list in point of excellence, and, perhaps, the most conspicuous of all hardy Rhododendrons, is the one described below.

Thomsoni.—Those who have not had the good fortune to see this splendid Sikkim variety, or rather species, in flower, can have but a faint idea of the glossy carmine hue of its blooms. Nor is that its only good property, for the individual flowers possess more substance than is met with in any of the older class of hybrids; in fact, they are in texture of a leathery substance resembling in firmness some of the Stanhopeas, and contrasting strongly with the flimsy texture of the older kinds. This peculiarity will doubtless enable the plant to maintain its blooms longer in perfection than most others, which is a great point; and the glossy varnishing may no doubt contribute to the same result, as it certainly renders them conspicuous amongst others that are also beautiful. Individually the flowers are larger than those of the ordinary hybrids, and the plant in point of habit seems all that is desirable. The foliage is about three-fourths the size of the leaves of the common Laurel, and, like the flower, fleshy and firm, though, perhaps, not so thick as in some other species from the same region. The plant at Fairlawn had stood out several winters unprotected, and, when I saw it, had about fifty trusses of finely formed flowers. It was about 4 feet through, and, perhaps, 3½ feet high; it was certainly the most striking plant in the Rhododendron-border.

Wallichii.—This is also a Sikkim species, but of a pale colour, and the substance of the flowers being thin compared with the last described, it is far from being so valuable; its foliage is, however, good, and being quite hardy it is possible it may become the progenitor of a race having flowers of a firmer texture.

Fulgens is also a Sikkim species, but not being in flower when I was at Fairlawn, I cannot do more than record its hardness. Like the above and the following species it was planted in the border promiscuously amongst other kinds.

Wightii.—This, I believe, had not flowered, but had stood out two or three winters.

Robustum.—I omitted to take any note of this, further than that it was amongst the out-door ones.

Nightii.—This not being in flower I could only judge of its capabilities of resisting cold.

Edgworthi.—This was expected to become very fine in a few years, but it had not been long enough out-doors to attain the size of some of the others. There seems, however, to be every reason to believe it hardy.

Of the Rhododendrons which had not been tried out of doors, the most magnificent one pointed out to me was *Dalhousianum*, a creamy white, of large size, and in substance resembling stiff leather. In its way it leaves little to wish for excepting that it were more hardy. Fancy a number of flowers clustered together, each almost as large as those of *Datura arborea*, of a white free from any stain or greenness, and yielding a most delicious odour. It is easy to imagine the delight of those who for the first time saw this noble plant expand its blooms, and it will ever continue to be a favourite if its flowering qualities be as great as its merits in other ways. I should much like to hear of any one having succeeded in wintering it out of doors, and flowering it in perfection there. If this be found impracticable, I hope at least to hear of it being the progenitor of a class of hybrids partaking of its qualities as a flower, with the hardier habit of some other kind.

Gibsoni.—This I omitted to take further note of than that it, also, was kept under glass.

J. ROBSON.

(To be continued.)

TREES AND SHRUBS IN MANUFACTURING TOWNS.

1. WHAT evergreen shrubs and forest trees has smoke in our manufacturing towns the most effect on?
2. What trees do the best in a smoky town?
3. What trees will smoke kill, and how long will it take to do so?
4. Will the effects of smoke be perceived sooner on newly planted trees than on those that have been growing many years?
5. Will the effluvia from gas-manufactories have an injurious effect on vegetation, and how is it perceived?—L. H. S.

[1. Smoke has the most effect on the whole tribe of Coniferae, such as Pines, Firs, Capressus, Arbor Vitæ, Junipers, Yews, &c., which contain resinous juices; for the smoke adheres to their leaves and closes their respiratory organs. Oaks generally do very indifferently; and the same remark applies to the common Ash, the Black, Ontario, and Balsam Poplars. Common Laurels we could never get to grow in towns.

2. We have grown the following trees and shrubs in one of the largest manufacturing towns in England, and think we are justified in recommending them as the best for such situations:—Limes and Elms (we had the latter 60 feet high), which are the two best forest trees. Sycamore does well until August, when the leaves are apt to fall. Lom-hardy, Abele, and White Poplars thrive moderately, especially if the soil is moist; and so do Willows if the soil is suitable for them. The Beech, common and purple or copper-leaved, holds second rank well. The Tulip Tree, *Ailanthus glandulosa*, Mountain Ash, Birch, Plane (*Platanus occidentalis*), also succeed; and Pear trees, though seldom yielding fruit, are useful and handsome when in bloom, and so are Apple trees. Thorns, of which we have cultivated more than thirty sorts, bear smoke well, and when grown as standards are fine objects on a lawn. Syringas and Lilacs

were fine with us; and so were Guelder Rose, Fly Honey-suckle, Cornelian Cherry, Bird Cherry, Wild Cherry (fine), Snowberry, Dogwood, Siberian Crab, and Azaleas. Ribes were very fine, blooming splendidly. Of evergreens the Rhododendron is pre-eminent, and is indeed the Laurel of towns. Hollies do moderately, Aucubas well; Berberis Darwinii and aquifolium, white and yellow Portugal Broom, and Pernettya mucronata did fairly. Besides the above, we found that the following succeeded:—Pæonia Moutan, Laurustinus, Genista tinctoria, Forsythia viridissima, Mezerion, Deutzias, Corchorus japonicus, Elders, Pyrus japonica, Salisburia adiantifolia, Spiræa, Vaccinium buxifolium, Kalmia glauca and latifolia, hardy Heaths, Andromeda floribunda, Weigela rosea, Vincas, Prunus of sorts, and the double-blossomed French Cherries, Privet, Horse Chestnut, and Cut-leaved Walnut. The only Pinus that thrived was Pinus austriaca. Of weeping trees the Elm is the best; and Lime, with Birch, Beech, and Laburnum did moderately.

3. Smoke will kill almost everything in time, but its effects are most speedy on all the Conifere as stated before, on Poplars, especially the Black and Ontario, Box, and common and Portugal Laurels. These are killed by smoke in a few years, depending much on circumstances—generally in five years, or by that time they are such miserable objects that they cannot be longer tolerated.

4. The effects of smoke are soonest perceivable on trees that have been growing a number of years. Young trees are more vigorous, and so make stronger growths in a shorter time than old, and this much earlier in the season, and so are able to withstand smoke better. Though young trees grow for a year or two without any marked effects from smoke, yet the early fall of the leaf caused by the pores of the leaves becoming closed, or nearly so, with smoke and dust, hinders the ripening of the wood; the points of the shoots die back in consequence, the plant or tree yearly presents a number of dead twigs, and gradually dies.

5. The effluvia from gas are death to vegetation. It is attempting an impossibility to try to make trees grow near gasworks, especially if effluvia offensive to man be emitted. Trees and shrubs suffering from gas have the leaves browned at the ends, and they become smaller each year; the branches are continually dying off, especially at the points, and spray shoots spring from their trunks.]

GRAFTING MASTIC.

In Dubreuil's "Training and Pruning Fruit Trees," translated by Wardle, mention is made of a mastic for grafting, made by M. L'Homme Lefort, Abbeville, near Paris, which is applied in a liquid state without heat. Can you tell me where this is to be procured?—A CONSTANT SUBSCRIBER.

[We applied for information to the Rev. T. Bréchant, and he replies—"I am happy to be able to send you my old master, Dubreuil's, capital mastic for grafting.

In 100 parts weight.	
Black pitch	28 parts.
Burgundy pitch	28 "
Yellow wax	16 "
Soot	14 "
Yellow ochre	14 "
100	

Heat gently. Apply with a brush.

"The cold mastic is the invention of M. L'Homme Lefort, of Abbeville, near Paris; but it is a patent article, and I cannot say anything of its composition. But he can get it from the inventor, or even from M. André Leroy, of Angers, whose clerk understands English."]

GISHURST COMPOUND.

THE strongest ingredient in Gishurst compound is sulphur in a soluble, and, therefore, active form. This may be taken as a sufficient answer to its supposed poisonous qualities. I have often liberally anointed my own trees, and in so doing considerably sprinkled my hands without discomfort, except from the smell. I had fully hoped this last spring to have submitted to you a compound free from smell, but before doing so severely tested it on my own trees; but though in appearance and in freedom from smell it was all

that could be wished, it proved much less efficacious against both mildew and red spider than the old-fashioned Gishurst.

Does your able correspondent, Mr. Bréchant, grow American Apples in his orchard-houses? I do, and have several times had the trees attacked furiously by red spider: in each form, large and small, there was a complete colony of the pest. By applying Gishurst worked into a lather by rubbing a wetted painter's brush in the box, we, in each case, entirely got rid of the enemy.

How beautiful and good the orchard-house Cherries are this year! Ours had the blossom well thinned.—G. W., Gishurst Cottage.

LARGE WELLINGTONIAS.

In answer to your correspondent who asks what the dimensions of the largest Wellingtonias in England are, I send the following extract from one of your contemporaries, published in March, 1859:—

	Height.		Breadth.		Girth of Stem.	
	ft.	in.	ft.	in.	ft.	in.
Veitch's Nursery, Exeter	9	6	6	0	1	3
Ditto ditto	8	9	6	6	1	7
Uffculme Vicarage, Devon	7	10	6	0	1	4
Tortworth Court	7	9	6	1	1	0
Hillersden House, Devon	7	8	7	0	1	0
Compton, Cheshire	7	6	6	0	1	0
Waterer's Nursery, Bagshot	7	5	5	10	0	0
Fairlawn Park, Tunbridge	7	0	6	5	1	3½
Acton Green, Middlesex	6	9	4	9	1	0
Basing Park	5	10½	5	2	0	0
Backhouse's Nursery, York	5	9	5	0	0	0

The above were dimensions taken in September, 1858.

Mr. Veitch, of Chelsea, writing in February, 1863, informs me that the dimensions of the two largest Wellingtonias at Exeter (probably the same as those mentioned above), were at that time as follows:—

No. 1. Height, 19 feet 9 inches; width from tip to tip, 10 feet 10 inches; girth of stem, 3 feet; previous year's growth between 2½ and 3 feet.

No. 2. Height, 18 feet; width, 12 feet 4 inches; girth of stem, 3 feet 8 inches.

In March of the present year another contemporary says that a tree in Mr. Waterer's nursery, Bagshot (perhaps the tree above mentioned), is now 18 feet 6 inches high; diameter of branches, 14 feet; circumference of stem, 3 feet 8 inches. Two years ago the leader was broken by the wind, had this not happened the tree would have been quite 18 inches higher.

The tree at Fairlawn, the height of which is given in your paper last week, was planted in 1856, being then 10½ inches high. In February, 1863, it was 16 feet high. Another tree at Fairlawn grew 37 inches in 1859.

Mr. J. Duncan informs me that the tree at Basing Park, struck from a cutting, was 14 feet 3 inches high in February, 1863.

A tree at Highnam Court, near Gloucester, was 15 inches high when planted in 1855. In November, 1862, it was 12 feet high.—(Proceedings R. H. Soc., July, 1863, p. 306.)

Owners of fine specimens of Conifers should send the dimensions for publication.—CHARLES PALMER, Manchester.

As you referred to the Wellingtonia here (Fairlawn, Tonbridge), it may interest some of your readers to know the exact amount of growth in each year. Ten inches and a quarter when planted, April 5th, 1856; 1 foot 11 inches, Christmas, 1856; 4 feet 10 inches, ditto, 1857; 7 feet 1 inch, ditto, 1858; 9 feet 8 inches, ditto, 1859; 11 feet 9 inches, ditto, 1860; 14 feet, ditto, 1861; 16 feet 3 inches, ditto, 1862.

It is now 18 feet high; the diameter of the branches is 12 feet 6 inches; and the circumference of the stem 4 feet 9 inches. My second best Wellingtonia is 14 feet 2 inches high; diameter of branches 10 feet 9 inches; and girth of stem, 2 feet 11 inches.—J. RIDGWAY.

CUT AND UNCUT POTATOES.

A FEW years ago I tried several experiments to determine whether whole or cut Potatoes would yield the best. I had planted whole Potatoes, but many said that cut Potatoes are better. My experiments satisfied me that whole Potatoes

are best in all cases. I give the result of one experiment. The variety used was Jackson White.

The Potatoes were carefully selected and weighed when planted, the produce dug when ripe, and weighed. The manure was spread on; plaster applied in the hill, 3 bushels to the acre. A few rows of each kind were planted through the piece, and the calculation made for an acre of each kind.

One acre planted with large uncut Potatoes, 58 bushels to the acre, yielded at the rate of 377 bushels to the acre; one acre planted with middling-sized Potatoes, 29 bushels to the acre, 333 bushels. One acre planted with cut Potatoes, 29 bushels to the acre, yielded 249 bushels. One acre planted with small whole Potatoes, 9 bushels to the acre, yielded 244 bushels.—N. B. K. LOWELL.—(*Boston Cultivator.*)

GARDENING AT BRISBANE.

I HAVE a small garden in front of my house, and the Brisbane River in front of that, a road passing along the bank. In this garden, of about 1½ acre, I have planted out about eighty standard and ten espalier trees, each tree being a different sort of fruit. It is simply an experimental garden. I could have at least treble the fruit from the same space occupied as an orchard. There are also 500 or 600 Grape Vines on espaliers in rows between the trees on the side of a schistose hill. Some of these are grafted sorts, worked on the Isabella stock, which grows as strongly as anything could possibly do here.

To give you an idea of its vigour, after pruning I have cut up some of the Isabella canes into about 18-inch lengths, and pushed them into the ground as marks to show where I had grafted some stocks underground with small scions, and within seven months these sticks have ripened one or two bunches of Grapes. Of course, the bunches were small.

Some of the sorts I grafted on this stock were Snow's Muscat Hamburg, the Frontignans, White Muscat of Alexandria, Malaga Muscatel, Santa Paula, Belas Blanco, Blanquette, Trentham Black, Golden Cornichon, and West's St. Peter's; and I shall, if spared, graft this season on the same sort of stock as an experiment, Champion Hamburg, Mill Hill Hamburg, Lady Downe's, Marchioness of Hastings, Barbarossa, and Trebbiano.

I cannot this season give you any reliable results from this grafting as to quality, quantity, &c., of fruit, and as to growth of scions, but will do so as soon as I can. I should like to try the same sort on two or three different stocks to see the various results; but I am afraid I shall not have room enough. I should like to get the old Syrian to try it as a stock as well as for fruit.

I have seven different sorts of Apples fruited, one Chinese Pear, several sorts of Oranges, Guavas, Loquats, Grapes, &c. The Plums and Cherries blossom but do not keep their fruit. Some of the Plums will set their fruit and grow to the size of a pea, and then it turns yellow and drops. I was thinking of trying to rear some in pots on Mr. Rivers's plan. The English Peaches also grow rank enough to wood but not to fruit, while the Chinese Peaches acquire a permanent weeping-willow fashion of growth from the weight of their produce.

Besides the above-mentioned garden I have another of small extent, of good alluvial soil, on the banks of a small creek at the other end of my allotment of land. This is devoted almost entirely to the Musas (Plantains). I have about two hundred stools all in fruit. The sorts are—*Musa maculata*, *Dacca*, *Cavendishii*, *textilis*, and four other edible sorts of which I never heard the names. We call them Green *Dacca*, Sugar, South Sea Island, and Tahitian.

Working men here can, as a rule, if they choose soon have a home of their own, where, with a little "unpie" or house to begin with, they may by the labour of their spare hours "sit under their own Vine and Fig tree," and may have their little plots of ground full of Bananas, Grapes, and Pine Apples. These three grow with scarcely any trouble and produce abundantly, as also do the early Peaches and Mandarin Oranges. This is no romance but matter of fact.

One thing has operated very strongly against fruit-growing here, and that is the difficulty—nay, almost impossibility, of getting fruit trees true to name from the nurseries in the colonies; not that it is at all times their fault,

for they are in many cases compelled to trust in a great measure to their men, who are so continually changing their places that they do not take such pains to keep the various sorts distinct as they should. If I am fortunate, I shall not only endeavour to bring out new sorts, but also all the old reliable kinds of fruit.—J. C.

P.S.—On looking over the foregoing I see that I have omitted to state the rapid growth of scions grafted on the Isabella Vine. Within four months after the starting of the buds on the scion the scions have swelled to quite 4 inches in circumference, and filled a trellis 6 feet high and 10 feet long. They do not get more than three months rest in our mild winter, sometimes not that. We have frosts at night occasionally from the end of May to the middle of August, but as a rule they are only light hoar frosts. Of course, we have exceptional seasons, such as last winter (June to August, 1863), which was very mild; whilst during the previous one (1862), we had two or three such sharp frosts as to kill some Guavas, *Passiflora ligularis*, &c., to the ground.

In four seasons out of the fifteen years I have been in the colony we have had severe hailstorms in October, which are most disastrous, cutting the young shoots of the Vine and knocking off the fruit to such an extent that the ground presents the appearance of a green carpet, and the Vines themselves look as if some person had been pruning them with a reaping-hook, so that it is not all fair weather; yet the Vines put out fresh shoots carrying new bunches, and in a week or two, unless a repetition of the dose is experienced, the disaster is in a fair way of being repaired.

ENTOMOLOGICAL SOCIETY.

THE Entomological Society's meeting on the 2nd May was presided over by F. P. Pascoe, Esq., F.L.S., when a variety of donations from the Royal and Linnæan Societies, and the Natural History Societies of Geneva, Stettin, Munich, &c., were announced, and thanks ordered to be given for the same.

A specimen of a British Moth, *Hydrilla palustris* (of which a unique specimen captured by Mr. Downing, the Secretary of the Society, was only previously known), was exhibited by Mr. Scholfield, taken in Guy Fen, Cambridgeshire, on the 29th of May, 1862.

Captain Cox exhibited a series of drawings of the caterpillars of British Lepidoptera executed by Mrs. Cox, and explained his systematic classification of these creatures, formed on their size, colour, form, and clothing, or the character of the spines with which they are armed. Also a number of living specimens of the caterpillar of a Moth, probably *Aglossa pinguinalis*, which infested a large bin of bran in his stable to such an extent as to render the bran nearly useless, forming cylindrical burrows of silk in the material.

Mr. A. R. Wallace exhibited a series of species of Butterflies of the genera *Papilio*, *Eronia*, and *Picris*, captured by himself in Celebes, an island of great geographical peculiarity, lying in the very heart of the Eastern Archipelago, with the view of showing the variations of form produced by change in the geographical distribution of the individuals. Not only were the specimens of certain species larger in Celebes and Amboyna than those taken in the East Indies, but the latter were furnished with larger tails to the hind wings, which appendages were smaller in the island specimens, and became obsolete or were only represented by a tooth in those of New Holland and New Guinea. But it was in the form of the fore wings that the modification of form was most remarkable in the Celebes insects; since out of sixteen species of the genus *Papilio* found there, all, with the exception of a single species, had the fore wings much more falcate in form, the fore margin being more strongly united and the extremity of the wing more pointed. Mr. Wallace endeavoured to explain this modification of form by supposing that the insects had been subject to external conditions dissimilar to those to which the Indian individuals had been accustomed, and that some physical change had occurred in Celebes but not in the adjacent islands. He was inclined to think that this peculiar form of wings allowed more rapid flight and gave greater facility in twisting or turning sud-

denly, which would thus enable the insects more easily to escape from their enemies and pursuers, the birds. He then applied the Darwinian theory to these facts, and insisted that thus the arched-winged individuals would have the best chance of surviving, the less favoured forms would be gradually killed off; the offspring of the survivors would for the most part resemble, and some few would excel, their parents in the possession of the advantageous shape; and "natural selection" through successive generations would lead to the gradual and regular increase of the peculiarity.

Professor Westwood opposed these views, contending from analogy with our English insects that the peculiar form of wings in question did not indicate any corresponding increased powers of flight; whereas such increased powers would necessarily be manifested did they exist in the increased size of the wing-muscles, and of the thorax to which they are attached, in illustration of which he exhibited a box of Butterflies containing nine of the rarest species of the genus *Charaxes*, the thorax and wing-muscles of which were very large, and the flight of these insects extremely strong. Amongst the species exhibited were several fine species, unique in this country, brought from the Zambesi by the Rev. H. Rowley, belonging to the Oxford Museum.

Mr. Newman and several other entomologists present also objected to Mr. Wallace's assumptions and arguments.

Captain Hutton communicated an important paper "On the Reversion and Restoration of the Silkworm." The

author has been engaged for several years past in India in making experiments on the common Silkworm, *Bombyx Mori*, with the view of restoring the worms to a healthy constitution and renovated condition, considering that the immense losses to which they are subject by muscadine and other diseases in the great silk establishments in France and Italy (which has necessitated the introduction of other species of Silkworms in order to supply their place), have been caused by constant interbreeding, want of sufficient light and ventilation, too high a temperature, and inducing debilitation and degeneracy in the stock. This was testified by the very pale colour of the worms—a character, however, which was in the highest request by the silk-breeders, who invariably rejected the dark grey or blackish brindled worms—the "*vers tigrés*" or "*vers zébrés*" of the French, which according to Captain Hutton was the normal and more healthy condition of the larvæ, proving an attempt on the part of Nature to revert to the original colours and characteristics of the species. The author then explained the steps he had taken to raise a stock of these healthy dark-coloured worms, and advised the silk-grower gradually to extirpate from his stock his present sickly pale-coloured individuals. The paper, as will be perceived, has a high value, not only in a practical point of view, but also in a physiological one, as controverting some of the Darwinian theories, and showing that Nature will, where possible, revert to the original condition of species.

A TRELLIS WITH GRAPE VINES TRAINED AT AN ANGLE OF 45°.

THE Vines are planted 3 feet apart, in the same way as for other modes of training, and but one cane allowed to grow the first year. In the fall the Vines are cut off to about 4 feet, and laid down and covered with earth—4 or 5 inches deep is usually sufficient. The next spring remove the earth and straighten up the Vine. Build the trellis in the same manner as for low-trained Vines with two arms—that is,

4 feet high, and 3 feet between the bars. The woodcut shows the system in the progressive stages. The Vine on the left shows the one strong cane at full length; the next, the Vine after it has been pruned, and the single upright bearing cane; the third Vine is as it appears complete at the end of the third year; the fourth Vine (*d*) shows the same pruned and laid down ready for covering.

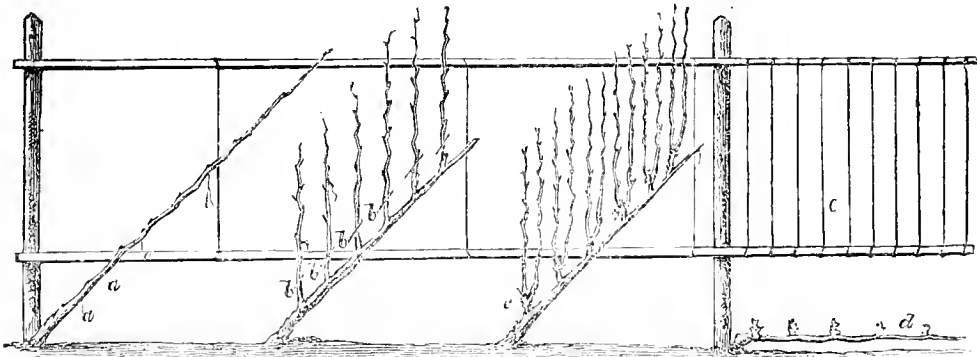

If good strong Vines are planted the system can be brought to completion the third season; but strong and vigorous canes must be obtained in all cases before commencing the training. The Vines are trained at an angle of 45°, and the bearing canes being perpendicular, they consequently make the same angle with the Vine that the Vine does with the ground.

This is the highest or greatest angle to which Vines can be carried without giving the upper shoots on the arms so much advantage over the lower ones, that there will be no certainty of the lower ones pushing into growth without bending or otherwise distorting the canes.

We will suppose that at the end of the first season we have a Vine as shown at the left of the engraving. It is then laid into position as seen: we then cut it off at the point where it crosses the perpendicular wire, leaving it an inch or two beyond it, so that it can be securely tied. The cane when cut off will be about 4½ feet long. It may now be laid down by the side of the trellis and covered with earth. In the spring take up the Vine and tie it to the trellis; and to be sure of getting the correct angle let the point

where the cane crosses the lower bar, and the point where it is tied to the upright wire, be both equal distances from the base of the wire. The Vine should be made as straight as possible, so that the sap shall not be checked in its flow. If it is not disposed to be straight a lath should be nailed on, reaching, at the proper angle, from the lower to the upper bar, and the Vine tied to it. When the buds start select five or six for the upright canes, the same as when the arms are trained horizontally.

The first upright may start a few inches below the lower bar, as shown in the engraving, or the bar may be placed 6 inches above the ground, provided that the soil about the base of the Vine be covered with mulching to keep the fruit clean. Each of the uprights will produce fruit; but unless the Vine is very strong a portion of it should be removed.

The flow of the sap will sometimes cause the upper shoots to grow a little faster than the lower ones; if so, pinch off the ends as soon as the fifth leaf is formed on them, and leave the lower canes until they have eight or nine leaves. The growth of the canes will usually be very regular when the Vines are laid in straight, and at the angle named.

At the end of the second year the bearing canes should be pruned to two buds: the cross lines at *b*, in the cut, show the point where to cut off.

As the Vines are to be protected, there is no necessity for leaving an extra bud to be cut off in spring, as recommended for unprotected Vines. In localities where it is necessary to protect Vines, the warm weather usually comes on so rapidly after it commences that it would not do to prune the Vines after they are uncovered.

The next season two canes are produced from the two buds, and in the fall the cane which starts from the upper bud of the two is removed, cutting through the spur as previously shown, and the other cane cut back to two buds; the cross line at *c*, in the engraving, shows the point at which it should be removed. Upon the right hand of the figure, and over the Vine that is laid down, the trellis is shown as it appears with all the perpendicular wires (*e*).—(*Boston Cultivator*.)

OBTAINING SUPERIOR PANSIES.

IN order to insure good blooms of Heartsease is it necessary to have young plants every year? and when is the best time to take cuttings of them for early spring flowering?—A YOUNG GARDENER.

[Young Pansy plants are most to be depended on for fine blooms. Cuttings may be taken off in August for fine plants next season, and struck in sandy soil in a shady place. Old plants divided into little bits now, will also make fine flowering plants early next spring, lifting them with good balls in the winter or spring.]

FLAVOUR OF FRUIT UNDER GLASS.

MR. ABBEY has undertaken a very difficult task, when he attempts to prove that those who have succeeded in growing as fine fruit under glass as others upon walls, ought not to have done so "for physiological reasons." One fact is held to be worth all the *à priori* reasons that the cleverest heads can adduce; and facts it seems are, unfortunately for Mr. Abbey's argument, against it. Of these let others speak. But his physiological reasons are, as a little reflection will show, so palpably based upon an error, and one of some importance in the culture of fruit trees, that they ought not to pass unnoticed.

Orchard-house fruit is said to be inferior in flavour, because it has not so much light or so much heat as that on a tree grown against a wall. I am surprised that a gardener of eminence should observe so slightly. Mr. Abbey does not seem to have realised that a wall casts a shadow. Has he never reflected, on seeing the shoots of his wall trees springing forth at an angle from the wall, why it is that they take this oblique direction, instead of growing upwards without swerving, as shoots do in orchard-houses and everywhere else?

He must often have noticed the pallid hue on one side of the Apricot he has plucked from the wall. Has it never occurred to him that this sickly colour is owing to something besides the absence of that sunshine which embrowns and enriches the other side? If he had, he would have learnt that a wall casts a very considerable shadow even on its sunny side, though there is no outline to define it. We cannot cease to wonder at the statement. What! a tree surrounded by glass on all sides does not enjoy so much light as one shut off by a wall from half the vault of heaven! Does Mr. Abbey imagine that light proceeds only in direct rays from the sun—that there is no refraction? If it were so, the Morello Cherries on his east wall would be in darkness after midday. But whatever the store of light be that falls on those Cherries on the east wall, flavours, and ripens them, of so much is the Apricot tree growing on the west side of the same wall deprived by the bricks that intervene.

So much for a tree against a wall having more light than one grown under glass. As to the other "physiological reason" that "the heat is intercepted by the glass," I can only say for myself that I would much rather be outside than inside a glass house on the broiling days we have had this May; and Mr. Abbey in the hurry of his argument has quite forgotten that he would too.

It will be of service to the science of orchard-house culture to have all its failures advanced against it; but it will require weapons with much more pith and substance in them than Mr. Abbey wields in his last paper, I will not say to demolish it, but to touch it.—WYTESIDE.

WORK FOR THE WEEK.

KITCHEN GARDEN.

IF former directions have been carried out, this department will now present many agreeable features. Continual hoeing, forking, and surface-stirring, together with a favourable season, have told well upon the crops, which are abundant and vigorous. All these operations must be diligently persevered in. The advantages derivable therefrom are manifold: weeds are extirpated, slugs disturbed and destroyed, moisture retained at a time when it is most needed, and a healthy action kept up between the roots and the atmosphere, which last will be the principal cause of the success which follows these operations. Trenching vacant ground must be prosecuted where required, and if manure is wanted on the ground about to be planted it is best to lay it on the top after it is trenched, and then fork it in. Let all green refuse be removed from every part, and either dug in or taken to a charheap. Keep all the advancing crops in a vigorous growing state by timely applications of water in dry weather. Watering should never be done by dribbles, here a little and there a little, but every crop thoroughly soaked; the practice of giving little drops every day cannot be too much avoided. A thorough watering once a-week will do more good than the same amount of water distributed through each day. Plant-out the forwardest Brussels Sprouts, Green Savoys, and Buda Kale; if the weather keep dry the holes had better be puddled. Plant, also, Cauliflowers for succession. *Beans, Broad*, a sowing of Early Mazagan in an exposed situation, made now, will be useful by-and-by. *Beet, Red*, thin-out to the proper distance at once, as also Parsnips, Scorzonera, and Salsafy. *Carrots*, continue the gradual thinning, as also Onions as they may be required for use. *Cucumbers*, those on ridges and banks to have plenty of water, and liquid manure occasionally. *Dwarf Kidney Beans*, a few more of a dwarf sort may be sown for a succession. *Peas*, sow Knight's Marrow and Early Frame for succession. These are benefited by a slight soaking in water previous to sowing, and also by pouring water upon them after they are laid in the drills, but not after they are covered. Advancing crops will be benefited by applications of liquid manure, not too strong, twice a-week. See that the ground is kept stirred about them. *Scarlet Runners* to have the earth well loosened about them, a little earth drawn up to the stems, and then staked at once. Salading of all sorts is now in great request; look well to successional sowings, and see that they all have copious supplies of water to induce crispness and coolness.

FRUIT GARDEN.

The recent hot weather has brought out the insect tribe in abundance, and they must be met with timely remedies. Fruit trees on walls will be benefited by a powerful syringing; whether infested by insects or not, this always does good. Thin-out the young wood on wall trees to the exact quantity required for bearing next year, and nail or otherwise lay it in carefully, taking especial care that the tender shoots are not bruised, you will thus avoid one fertile source of canker. Pinch off the points of the young shoots of Fig trees when they have made five or six joints. By this means you will secure more stocky and fruitful wood for the next crop than if left to grow on. Where practicable the Strawberry ground should be thoroughly soaked with water, without which the fruit will be small.

FLOWER GARDEN.

During the continuance of the present dry weather frequent waterings must be given, not only to the recently transplanted trees and shrubs, but likewise to the bedded plants, annuals, &c. Mulching where practicable should be adopted, as well as damping the foliage of newly-planted things every evening. Peg down those plants required to cover the ground as they advance, and loosen the surface of the beds and borders, which should afterwards be neatly raked over. Carnations, Picotees, and herbaceous plants,

with the taller-growing bedding plants, should be staked and tied up to prevent injury from wind. Hollyhocks, Phloxes, Delphiniums, Asters, &c., if not already done should have the shoots thinned out before being tied up, to prevent an appearance of overcrowding as well as to improve the size of the flowers. When showery weather occurs let the Box-edgings be clipped. London Pride, Thrift, Daisies, &c., used for edgings should each year, or once in two years, be taken up, divided, and replanted when the blooming is over. Roses now require watching to prevent the ravages of the Rose-maggot, a daily look over is the only preventive. Wash with the engine to dislodge the green fly. Water freely and mulch the surface around the roots. Pinks will now require attention, the pods of those which have a tendency to burst should have a small ligature passed around them. Continue to propagate Pansies, and mark all seedlings having good or singular properties. Mulch Dahlias to prevent evaporation. This will save much watering and be at the same time very serviceable to the young plants.

GREENHOUSE AND CONSERVATORY.

The principal part of the greenhouse plants may now be safely transferred to an out-of-door situation. Select, if possible, a shady situation, or at least one where they would be protected from the midday sun. At the same time it is no less necessary that the roots should have a similar protection, for nothing can be more injurious to the greater number of plants than exposing the pots in which they grow to the force of a broiling sun, for the least inattention to watering is likely to prove fatal to the plants, more particularly to hardwooded kinds. Out of doors they may be plunged in ashes or have the space between the pots filled with moss; and those plants in the house which have their pots most exposed should have them inserted in one a size larger, filling the space between the two with moss, sawdust, &c. This will prevent excessive evaporation through the sides of the pot from the soil containing the roots, and will save many plants from being lost during very hot weather.

STOVE.

The plants in this house should be closely watched, particularly those with large soft leaves, to guard against the red spider, which the present dry weather is encouraging. Syringe frequently to keep them in check. Achimenes, Gesneras, Gloxinias, &c., as they begin to show for bloom should be removed to more airy quarters, keeping them, however, partially shaded for a time, but afterwards they may be exposed to a larger share of light. Achimenes must be carefully attended to with water while growing.

PITS AND FRAMES.

Hardwooded plants in these structures will now enjoy a more moderate temperature than they possibly could obtain in houses, especially in pits turned to the north, which will prove a good place for some of the tribes in very hot weather. Let regular waterings be applied. W. KEANE.

DOINGS OF THE LAST WEEK.

KITCHEN GARDEN.

Peas out of doors now in abundance, and plants very strong and blooming freely, which we attribute to a soaking of sewage water given a fortnight ago. But for having plenty in the orchard-house we would have had less vigour in these early out-door Peas and earlier gatherings, from stopping the points of all the shoots and keeping the roots rather dry, until a great many pods were set. Peas are induced to swell early, just like Beans, by nipping out the points of the shoots when a number of blooms have opened on each. In the case of the Pea, however, that is not the plan for getting heavy continuous crops. In fact with no stopping, close picking—that is, never allowing pods to remain with Peas more than half swelled to ripening, and plenty of watering, Peas sown on well trenched rich ground will continue a long time in bearing. One pod on a shoot left to ripen will exhaust the energies of the plant more than half a dozen pods carefully nipped off when the Peas inside are not half swelled, but in that soft pulpy state in which they are now generally required at gentlemen's tables. This reminds us that there is a little art in gathering Peas. Some gatherers in their roughness in pulling off the pods leave desolation, in the shape of broken and rootless stems,

behind them. Those who have stout nails may nip the stalk of the pod between the nails of the thumb and finger; but by far the simplest and best way is to use the point of a sharp knife for cutting the stem of the pod. This is the quickest mode of gathering, and never hurts the stem of the Pea. The same rule as above of close gathering applies more to *Dwarf Kidney Beans* and *Scarlet Runners* than even to Peas. We sow in successions necessarily, because we are apt to neglect the close gathering, never allowing a pod to seed. But for this, one sowing might do for the season, a matter of importance to those with little ground, to whom the buying of a few seeds is no object. We have frequently gathered from plants of *Dwarf Kidney Beans* in March and April, planted them out of doors in May, at first with a little protection, and then fully exposed, and, close-gathered, the same plants continued to produce freely until cut down by frost in the end of October. During the summer the plants had several good waterings with manure water, and were top-dressed once or twice with rotten dung. A deal of trouble, you say, for a very little benefit. Well, perhaps too much trouble for those who have their quarters in fallow for winter crops, and who scarcely know how to fill their acres of ground; but still a matter of some importance to those who can only appropriate some dozen or twenty square yards to any one thing.

We have often admired the fine crops of *Dwarf Kidney Beans* and *Scarlet Runners* in the little gardens of artisans and mechanics in London and the immediate suburbs, and more especially the earliness with which they got fine dishes of Runners from sowing them thickly in pots and boxes inside of the windows of their homes and their workshops, and then transplanting them about the beginning of May. At that time the temperature of London is considerably in advance of the surrounding country, from the gas and the fires being kept on, even in the sitting-rooms. When younger and travelling about a little more, even if half asleep on the top of a coach, we used to know when we were near London, in winter and spring, by the increase of the temperature. Then these Beans are just the things for summer crops in town gardens, as the increased temperature they do not mind, if they can obtain moisture to supply the evaporation from the foliage, and they flourish best at a season when London and our great towns are freest from the smoke and the blacks, as people are glad to dispense with all fires in their houses, except the kitchen one, and the gas itself is reduced to a minimum. Oh! the happy hours we have passed, and the pleasurable advantages we have gained in some of these gardens some 20 yards long, and not half as much in width, with their superb Rhubarb, the little plot of flowers that furnished a bouquet for the parlour; the nice bed of Cabbages, planted early in spring because the soot was too much for them in winter, planted thickly, too, about a foot apart, cut on the slope, and the young growth encouraged by all the slopes of the house, so as to yield a good supply up to the middle of November; and then these fine Runners twining each round its separate thread, and these threads connected at top with a stronger cord reaching from the second-floor window to the boundary wall. Some may smile at the word advantages, but a veteran will not do so. We do not deny that we have learned much in the gardens of a noble duke, or of an honourable gentleman, and some of the lessons we have learned ourselves we have tried to make of general advantage to others. If ever a complaint has reached us as to describing places and their contents, it has been to the effect that we can see clearly enough at home, but that when we go from home we use a magnifying glass for all that is beautiful, and shut our eyes to all that is defective or under the mark. Well, we hope we shall not live to have our eye dim and closed to the perceptions of the beautiful and the commendable. We hope never to know the day when we shall go round a place and see nothing to admire. It is difficult to know what some people give themselves the trouble of visiting places for, except getting a deeper incrustation of self-importance and self-esteem. Visiting gardens and shows we value most of all, because it always shatters our self-esteem.

Well, we value the privilege of seeing a large, well-managed garden, but we must say we have rarely gone into the smallest garden without learning something. We did learn much from the artisan gardener friends of the metropolis and other

towns, and chiefly as to making the most of small pieces of ground. Some of these have now left us; others are mostly scattered, some in Van Dieman's Land, others in Australia, some in Canada, and others in America. In almost every case they carried their gardening tastes with them. One pitched his tent outside of Melbourne, grew vegetables, and made money by wheeling them into the town and selling them. In their case now, the making the very most of a little piece of ground is of less importance, as where they have gone ground is much more easily obtained than the labour power to work it. As an act of gratitude for favours received, however, we would wish to say something for the benefit of their successors, gleaned from the experience of our old friends, and that is, in almost every case they lost valuable produce by not picking their Beans and Scarlet Runners close enough. They used to boast of the quarts of seeds of Runners they had saved—seeds which were of little or no use to them, as a quart would pretty well furnish them with all they needed, and would not cost them much to purchase, whilst for every quart of seed saved they lost nearly a bushel of succulent pods as nourishing food. The saving of seed, in such circumstances of little room, is often the reverse of a gain.

General work very much of a routine character. Sowing Turnips and Radishes, Spinach, Lettuces, and Cauliflower for a late crop; pricking out lots of winter stuff; watering Lettuces, watering and slightly shading Turnips; sowing Peas and Dwarf Kidney Beans; and sowing Salsafy and Scorzonera, and a piece of Carrots, which somehow generally yield nice young roots in the autumn, which for many purposes answer better than the larger roots from seeds sown in April or earlier. Watered the early *Cauliflower*, now producing as fast as it can be used, with sewage water; and to save watering earthed-up the second and third crops, and covered the ground several inches thick with short grass from the mowing machine. We have no Cauliflower now, except the two last plantings, that is not protected by a covering of grass or of litter over the ground, and this keeps plenty of moisture about the roots to supply the evaporation from the foliage in these warm days. The Lettuces planted now are placed on the north side of a raised bank, or in shady places, to prevent the necessity of much watering.

For the same purpose successions of *Turnips* are placed on the north side of such a bank, by sowing only a few yards at a time, and the sowing now to succeed the previous one as soon as the seedlings appear boldly. We rarely want young Turnips all the summer, and as rarely have any too old for use to remove. There is no comparison as to quality between Turnips 2 and 3 inches in diameter, and those 6 or more inches across. The larger Turnips are no advantage even to the cottager, as they take so much more room. It is better to thin them more sparingly, use them younger, and sow oftener. We have tasted Peaches and fine-looking Melons that were insipid when compared with such a young Turnip. The only secrets for their rich sweetness, are deep stirred ground, rich sweet manure, and help from the water pail in dry weather.

We have sorrowfully noticed the disappointment, especially at country shows, when huge old Turnips from cottagers were passed over, and the prize given to a neat little bunch, the Turnips individually not half the size. The fact was the judges not only knew which were best, but they also knew that more produce of the smaller-sized ones could be obtained from the same piece of ground. When produce is shown for size, of course that is a different affair, and size will carry the day; but in all other cases quality will be considered before mere bulk. Thus at some of our country shows, some cottagers are sadly put out because their great lumping Potatoes with numerous deepset eyes are passed over, and an oval broad Potato, with scarcely an eye discernible takes the place of honour. The judges know two things—first, that the quality of the latter is likely to be the best; and, secondly, that in paring or preparing for cooking there will be little or no waste, which there always is in deep-eyed lumping Potatoes. The best thing with all such is to cook them carefully with their jackets on—ah! but the "carefully!" how few can turn out a real cooked Potato without a bit of waste at the outsides, and without a home at the centre.

Water for all growing vegetables in summer is important, and every kind of *slops* from the house is valuable if not

presented to the vegetables too strong or too fresh. A place to ferment in is therefore valuable. How often have we seen a bed of Cabbages starving for want of liquid nourishment, and yet gallons and barrels of scapsuds polluting the sides of the highways. We trust the days are nearly gone when the steaming midden and the filthy puddle must be crossed before you could enter a cottage homestead. Dirt is a grand thing in its right place; but such matters should be at the farthest point from the cottage, and earth or other means should be used to keep away all noxious exhalations. A keen mechanic amateur has lately been telling us how he means to secure not only the slops, but all the water spareable from his cottage for his garden. He has some brickbats too old to use for building, and with these he has bottomed and sided a hole that will hold from a dozen to eighteen pots or pails of water; and to make it watertight he proposes cementing all round the bricks. We fear that the cement will cost more than he contemplates; and then we hope the place will hold water better than we expect it will, as we have some experience of what a single crack will do. Many cannot get brickbats, and yet if clay is handy they may soon make a waterproof receptacle with puddled clay, and then prevent its cracking by turfing it over. A very cheap water-holding receptacle is thus formed: Dig out a hole, say 3½ to 4 feet deep; make it 3 feet square at the bottom and 5 feet square at the top, so as to give a good slope for the sides, which with the bottom and the sides are to be beaten smooth. Then carry home some six or eight gallons of tar from the nearest gasworks, which you may obtain for a penny a-gallon. Plaster the sides and the bottom all over; and then throw over it, and beat it slightly in, a little fine gravel or road-drift. This at first will taint the water, but if made in the autumn it will be sweet enough for anything before spring. A wattled hurdle or anything of that sort laid across the mouth, especially for the first winter, will prevent all cracking. In fact, such easy-made waterproof walls will pretty well stand as much frost as a cemented brick tank. In either case, if full of water there would be little danger of a crack. This is the cheapest and readiest plan we know of for making a hold-water receptacle for watering vegetables.

An old barrel sunk in the ground is also useful for such a water-receptacle. In fact they are what we use for different manure waters. Some time ago we wished to have a tank built in different divisions for this purpose. However, it ended in the wishing. Not to be beaten, we collected some old barrels that had been used for various out-door purposes for a quarter of a century, and through most of which you could see daylight between every stave. They seemed fitted for nothing but a bonfire. These were first thrown into a pond for the staves to swell; then a large deep trench was dug out, so as to hold four of these old barrels in a row close to a tank. We did nothing in the way of tarring the insides, as we did not like to taint the water, or to wait until the smell of the tar went off; but we packed the clay and stiff soil about the sides, and allowed tar to trickle down an inch or more in width all round the barrels and finally covered the ground all round the tops of the barrels with a thin coating of tar and a thin coating of gravel; it is now as hard as metal almost. We believe when the staves are thoroughly decayed, which they will not be just yet, as the barrels are nearly always kept full, and that preserves them, that then the surrounding soil will keep the water as well as it does now. On filling the barrels we lost a little water for the first week, but none since. In these we brew soot, lime, sheepdung, cowdung, and other varieties of liquid manure; but they answer no better for a cottager than a tar-sided pit or hole. The barrels above ground were of no use except for fuel. They are easier covered over than a large hole.

FRUIT GARDEN.

Much the same as last week. Had nice gatherings of Cherries from the orchard-house. Looked after caterpillars and black fly on Cherries out of doors. Used for the latter a little quassia water, which we like because it leaves no filth behind it. It may be used very strong, and yet be as clear as pure water. Out of doors we have finished putting some short grass round all our trees, not because we like it best, but because being rather hard driven one barrowing would do, instead of two for short litter or straw. We should like

to give them another soaking with sewage water, or the liquid manure from the farm. The latter is the stuff, when there has not been much rain to make it poor.

ORNAMENTAL DEPARTMENT.

Here out of doors we suffered a little by the frost of Saturday the 4th inst. What rather surprised us, few things planted out in beds suffered, whilst strong plants in vases of Geraniums, and some 3½ feet above the ground, suffered very much, the stems being blackened and the leaves whitened. We shall let them remain and see if they will break again, as it is no joke to plant such things twice. We presume their solitariness had something to do with the calamity that thus befel them. Almost everything in beds is doing well, except the *Amaranthus melancholicus ruber*, which in many places, though partially protected, is considerably injured, but yet not so much so as not to recover. We think we deserve this: it is more our fault than the fault of the plant, as last season we resolved not to plant it out this season until the middle of June; but the warm days of May made us give up our wise intentions. Several days have been taken up in securing by twigs the plants turned out and growing, as without such security we might expect the contents of beds to be careering through the park. But with such twigs amongst them the strongest wind seems to have little power over them. The only thing else besides the *Amaranthus*, and the large Scarlet Geraniums in vases that suffered from the frost in the beginning of the month, were the first large leaves of Dwarf Kidney Beans in the kitchen garden, and there seemed to be a few spots on the Potato leaves. Most of the plants in the flower garden are now growing freely. The weather being uncertain, we are unwilling to give them much water at the root, as that would only cool the soil. We prefer, when necessary, giving only a little, and following soon after with the Dutch hoe, so as to leave a rough dry surface. This is not so essential with Geraniums, for which as yet the ground cannot be too hot; but it is of importance in the case of *Calceolarias* and *Verbenas*, which do not like too much warmth in the soil. We have been engaged making up deficiencies in beds and masses of *Verbenas* and *Calceolarias*, and as for them moisture at the bottom is more important than vastly increased heat, we have cleaned the beds with the hoe, watered them all over, and then covered with a slight dressing of dry riddled old Mushroom-dung, and on that pegged down the shoots of the *Verbenas*, using as pegs pieces about 7 inches long of Larch twigs, bent or cracked in the middle. We will follow with *Calceolarias*, twigging them up, and then giving a little of this top-dressing to keep the roots cool. The virtues of this surfacing, what little is left, will also be washed in by the rains. To this late striking, and hardy treatment before planting-out, we attribute the fact that our *Calceolarias* generally do well. In very hot days, when the plants seemed to droop a little, we gave them a dash from the garden engine over-head, knowing the roots had moisture enough about them. Pot plants as in previous weeks.

Near the end of last week's gossip, the word "seeds" should be "sides." The sentence should be, "These washed in a similar manner gave whitish little shingles for sides." The paths are formed of black shingle in the centre, and white shingle on each side of it, both placed above the old tile flooring. Such shingle holds and parts gradually with moisture for a long time.—E. F.

COVENT GARDEN MARKET.—JUNE 11.

The supply of all kinds of produce both home and foreign is very good and the demand is brisk. Consignments from France now include Plums and Apricots, in addition to Artichokes, Tomatoes, Peas, &c. French Cherries, however, are getting over, but their place will be taken in a day or two by those of English growth. Pines and bot-house Grapes are plentiful and very good. Peaches and Nectarines are sufficient for the demand, and of good Melons there is also a fair supply. As Peas have come in Asparagus is now much cheaper.

FRUIT.

	s.	d.	s.	d.		s.	d.	s.	d.	
Apples..... ½ sieve	0	0	0	0	Melons	each	4	0	10	0
Apricots.....doz.	0	0	0	0	Nectarines		10	0	20	0
Cherries	1	0	2	0	Oranges	100	10	0	16	0
Figs	12	0	20	0	Peaches	doz.	18	0	3	0
Filberts & Nuts 100 lbs.	0	0	0	0	Pears	bush.	0	0	0	0
Gooseb. Green ½ sieve	2	0	4	0	dessert.....doz.		0	0	0	0
Grapes, Hothouse.....lb.	6	0	12	0	Pine Apples.....lb.	6	0	10	0	0
Muscats	8	0	14	0	Strawberries ..punnet	1	0	2	0	0
Lemons	4	0	10	0	Walnuts.....bush.	14	0	20	0	0

VEGETABLES.

	s.	d.	s.	d.		s.	d.	s.	d.	
Asparagus	3	0	0	0	Lettuce.....score	1	0	2	0	
Beans	0	0	0	0	Mushrooms	bottle	1	0	2	0
Kidney	100	2	0	0	Must. & Cress, punnet		0	2	0	4
Beet, Red.....doz.	1	0	3	0	Onions	bushel	7	0	12	0
Broccoli	0	0	0	0	pickling	quart	0	6	0	8
Cabbage	doz.	0	9	1	Parsley	½ sieve	1	0	2	0
Carrots	bunch	0	6	8	Parsnips	doz.	0	0	1	6
New		0	9	1	Peas.....quart	1	0	2	0	
Culiflower	doz.	4	0	6	Potatoes.....lb.	8	0	12	0	
Celery	bunch	1	6	2	New	sack	0	4	0	8
Cheumbers	score	0	6	1	Radishes doz. bunches		0	6	0	9
Endive	score	1	3	2	Turnips		0	6	1	0
Fennel	bunch	0	3	0	Rhubarb		0	4	0	6
Garlic and Shallots, lb.	0	8	0	0	Sea-kale	basket	0	0	0	0
Herbs	bunch	0	3	0	Sprach.....sieve	1	0	2	0	
Horseradish	bundle	1	6	4	Turnips	bunch	0	6	0	9
Leeks.....bunch	0	6	1	0	New		0	0	0	0

TO CORRESPONDENTS.

* * * We request that no one will write privately to the departmental writers of the "Journal of Horticulture, Cottage Gardener, and Country Gentleman." By so doing they are subjected to unjustifiable trouble and expense. All communications should therefore be addressed solely to *The Editors of the Journal of Horticulture, &c., 171, Fleet Street, London, E.C.*

We also request that correspondents will not mix up on the same sheet questions relating to Gardening and those on Poultry and Bee subjects, if they expect to get them answered promptly and conveniently, but write them on separate communications. Also never to send more than two or three questions at once.

N.B.—Many questions must remain unanswered until next week.

NEW ZEALAND.—"J. S." wishes to be informed whether New Zealand is a desirable colony for a gardener to emigrate to. We have no reliable information, and shall be obliged by any one who has such information sending us a reply.

STRAWBERRIES UNFRUITFUL (*A Disappointed Amateur*).—We fear your plants have been put in late, and have not had time to do more than grow, instead of perfecting their growth and becoming fruitful. We have some that were planted late (September), and they are unfruitful like yours; but a plantation made in August is bearing well, and the fruit will be ripe in a few days. We advise you to keep the plants, and have the runners cut off as they present themselves, unless you want more plants, and thus admit light to the plants, and sun and air will do what is necessary to insure a good crop another year. They should have a clear space around them every way, as, when they are crowded, they grow weak, and are poor and barren.

HEDGE BY A WALL (*A Subscriber*).—Thorns will do very well as you propose; but nothing makes a hedge so quickly, and is so good a shelter, as Beech, which you say does not answer with you. Hornbeam makes a quick-growing hedge, but is not so good for shelter as Beech. The latter, we think, must have been neglected as to water, and been planted in a poor dry soil. If the ground is dry water twice a week in dry weather, and if poor and stony, take the plants up in autumn, and, after replacing the old soil with some of a good rich nature, replant them, and we think you will find Beech is anything but a bad grower. If you like to have Thorns you will find it better to plant Sweet Briar with them than Beech. You may transplant large Thorns, if you like, 6 feet high, and make standards of them, but they will not succeed so well as younger plants. Thorns will not grow more than 1 foot in a year, and we have known Beech hedges push 2 feet in a season, but not the first year. Your plants must become established, let them be what they may, before they will shoot much in a year.

SEWING CEDAR AND JUNIPER (*A Reader*).—Sow the seeds in any light good soil, and cover them with soil to the depth of half an inch. The Cedars had best be sown in a cold frame, either in a pan or in the soil of the bed. The lights may be kept close until the plants appear, keeping the soil always moist, but not wet; but afterwards air should be given daily by taking off the lights, putting them on only in wet weather, and to abide the seedlings from a snow and severe frost. The soil should at all times be kept moist, but it is desirable not to water until the soil becomes dry, then a good watering should be given. The Junipers may be sown in the open ground, and be watered only in dry weather. The seeds will germinate in about six weeks, more or less, according to their age and the temperature. If they do not come up let them remain, for they do not all germinate alike, and so come up at various times. The Cedars will germinate much sooner if placed in a hotbed, and when up they can be hardened-off by degrees.

ROSE AND VINE LEAVES (*T. T. A Subscriber*).—The "blight" on the Rose leaves we believe to be caused by the soil being too poor and too dry. If horse-droppings, 2 inches in depth, be put on the surface over a space of 18 inches round each Rose stem, and water be given plentifully every day during dry weather, the leaves, we think, will cease to curl and fall. The "eruption" on the back of the Vine leaves is a symptom of vigour rather than disease. It will not injure the crop.

LAYING OUT A GARDEN (*Garston*).—To do what you require would need a small volume to be written, and then we might do you little service. We presume that your plan is drawn to a scale, and when your prominent points are settled by rod and line, you will have to work out the details.

SKELETON LEAVES (*A. E.*).—We do not know the process. We shall be obliged by information.

STOVE AND GREENHOUSE PLANTS (J. Clayton).—Flowering stove plants—*Clerodendron Marshalli*, *Cyrtoceras reflexum*, *Dipladenia splendens*, *Rondeletia speciosa major*, *Vinca ocellata*, and *Ixora coccinea superba*. Variegated and fine-foliaged stove plants—*Pandanus elegantissimus*, *Sansevieria javanica*, *Draecena terminalis*, *Croton picta*, *C. angustifolia*, and *Aloasia metallica*. Flowering greenhouse plants—*Crowea saligna*, *Erythrina cristagalli*, *Kalosanthes coccinea superba*, *Lesehenaultia formosa*, *Phimacoma prolifera* *Barnesii*, and *Statiche brasiliensis*. Variegated or fine-foliaged plants—*Yucca filamentosa variegata*, *Adelaster albivenis*, *Lomatia ferruginea*, *Pinecactia glauca*, *Cordiline indivisa*, and *Yucca filifera*. Ferns—*Adiantum cucurbitum*, *Cheilanthes lencigera*, *Pteris scaberula*, *Drymaria bullata*, *Thamnopteris australis*, and *Gymnogramma Wetenhalliana*. Lycopods—*Selaginella Martensii*, *atroviridis*, *Lyallii*, *umbrosa*, *Wildenovi*, and *ecesia*. We have given you the names of more than you requested, in order that you may select such as you think most likely to suit you on inspection, or that may be obtainable of the size you require.

SOWING TRAPAZIUM TRICOLOR AND T. JARRATTI (A Subscriber).—Sow the seed when ripe in equal parts of sandy peat and light loam, providing good drainage. Cover lightly with fine soil, water sparingly, but keep the soil moderately moist, and place in a mild hotbed (75° to 80°). When fairly up remove to the greenhouse, and place in a light airy situation. The seedlings will need but little water, yet they must have it when necessary, or they will go prematurely to rest. Whenever, therefore, the soil appears to need water give enough to run through the pot, and let the soil become dry before any is again given. When the seedlings are sufficiently large to handle pot them singly in small pots, and grow on until the foliage begins to turn yellow, then gradually withhold water, and treat them afterwards like established plants.

STRIKING DOUBLE PETUNIA CUTTINGS (Durham).—Take from 3 to 4 inches of the points of the growing shoots, cut them transversely immediately below the lowest leaf or joint, remove the two lowest leaves, and insert round the edges of a pot, and up to the lowest leaf left, so that they stand clear of each other. The pot should be well drained and filled with a compost of loam and leaf mould, with an equal quantity of silver sand added. Give a gentle watering and place in a Cucurbit-frame or hotbed, keeping them moist, but not wet, and shaded from sun. They will root in about twenty-one days.

WILD FLOWERS OF GREAT BRITAIN (J. C. A.).—The fault is either with your bookseller or his London agent. All the back Numbers can be had from our office. It may be worth your while to send us your address.

MARANTA—DRAECENA—SELAGINELLA LEAVES BECOME BROWN (W. H. Michael).—The leaves enclosed appear to have been browned by syringing them heavily in the evening, which causes water to drip off the points of the leaves, or to rest upon them until the sun gets powerful in the morning and scorches them. On the *Draecena* leaves we noticed marks of thrips having been there, and we therefore recommend you to fill the house with tobacco smoke, employing the strongest shag tobacco some calm night when the foliage is dry. Shade the next day and keep the house moist. To prevent the discoloration of the leaves in future make a size of milk and lime, and with this paint the inside of the glass, putting it on in the beginning of May and washing it off in September, which will prevent the sun killing the *Selaginella*, and browning the leaves of the others. Keep the atmosphere at all times moist; but do not seek to secure this by heavy syringings at any time, a gentle bedewing of every available surface, as walls, paths, flues, &c., being far preferable. This bedewing should take place twice daily, and this with a gentle syringing overhead with water of the same temperature as the house in the evening in summer, but so early that the plants will get dry before dark, will keep them in health.

BOOK (A Young Gardener and Subscriber).—As you have already the "Cottage Gardener's Dictionary," and "Thompson's Gardener's Assistant," and your employer wishes to give you "a good useful book on plants," we recommend London's "Encyclopedia of Plants," it contains descriptions and drawings of the chief species in each genus. (J. L. C.)—The "Garden Manual," which you can have free by post from our office for twenty postage stamps, will give you all the information which you require.

CONSERVATORY ON A NORTH ASPECT (An Old Country Subscriber).—This place is unsuitable for plants to grow in, though it would do very well for them when in bloom; but you must have some other house to which you can remove them after flowering, in order to make and perfect their growth. For our part we should delight in having such a house not for a conservatory, but a fernery, in which Ferns would flourish and be interesting at all seasons. You could have hardy Ferns of the better kinds which would do without fire heat, and need only a glass roof, or greenhouse Ferns, which would only require fire heat in severe weather. Or you might devote the house to fine-foliaged and variegated plants, the majority of which, however, require a stove temperature, which is undesirable near drawing-rooms. We do not wish to discourage your taste for flowering plants, but we feel bound to say, if you decide on having them they will not flower sufficiently to please you.

PEACHES MILDEWED (S. B.).—The fruit is stained and cracked by the mildew fungus. It is too late to apply any remedy now, but next year whilst the trees are in blossom we recommend flowers of sulphur to be applied plentifully about the border of the house, and as soon as the fruit is set to dust the sulphur thoroughly over the whole tree. Letting it remain on for a week and then syringing. Repeating the treatment if any symptom of mildew is detected. To check the propagation of the fungus we should now dust the borders with sulphur, and paint the stems and branches with it made into a cream with a little soft soap and clay.

MARKET-GARDENING (G. I.).—The work you mention can be had free by post from our office if you enclose nineteen penny postage stamps with your direction.

ORCHARD-HOUSE FAR NORTH (Blink Bonny).—We have no fear that the orchard-house will not succeed. One cause of failure, when no artificial heat is used, is allowing the plants to become too forward early in the year. The great thing in such a cold exposed place is to retard the opening of the blossom. For a lean-to 8 feet high at the back, and 12 feet in width, we should not like the front to be more than from 2½ to 3 feet. If you raise the wall to 9 feet, then the front may range from 3½ to 4 feet. You will have ample ventilation according to your plan; but we would prefer glass at the top to boards so wide as 18 inches. We find we can do pretty well with not much more than half of your proposed ventilation. For a house 30 feet long the openings above the two doorways will be a great safety-valve. However, it is well to err on the safe side.

CUCUMBERS (J. Mackenzie, M.D.).—We see nothing wrong with your house or management, except that you have no means of heating the soil. We think this is the key to your failures. If you could place one row of piping now employed for top heat 2 feet below the surface of the border, and cover them with rubble 9 inches deep, and then place 1 foot of soil upon the rubble, and a three-inch dressing of short littery manure when the plants commence fruiting, we think your failures would all disappear, if the plants were duly attended to, and thrips and red spider kept down. Two four-inch pipes are sufficient for top heat unless the house exceeds 9 feet wide, when two all round are requisite. If, however, Cucumbers are not needed in winter, then two rows of pipes for top heat will do very well for a house 12 feet wide. Try this and you will succeed in future if the other points in their cultivation are attended to. As you have Vines in the same house you will only need a pipe on one side for bottom heat for the Cucumbers, whilst the roots of the Vines would be confined in the border opposite. Another year commence the Vines with a temperature of 45° for a fortnight, afterwards let it be 50° at night, and give air at 70°, and shut up early, continuing the temperature until the Vines are fairly in leaf, then augment the temperature to 55° by night, giving air whenever the temperature rises to 75°. When the Vines are in flower let the temperature be 60° at night, giving air at 75° as before, syringing the Vines twice daily with soft water of the same temperature as the house, and pursue this treatment until the Grapes change colour, then discontinue the syringing, and if the Cucumbers perish owing to the dry heat let them, for it is better to make sure of the Grapes than to have them spoiled for the sake of the Cucumbers. The latter will not do in the house until the heat averages 60° by night. We think the Vines are brought on too quickly, and that this causes the leaves to wilt. We may just add, that it would be much better to do away with either the Vines or Cucumbers. We should say the latter; you could easily build a small pit for them, and then devote your house to Vines alone, or to Cucumbers as you think proper.

VARIOUS (T. D. G.).—*Phlox Drummondii* usually grows 1 to 1½ feet high, and the rays are various—rose, white with rose eye, shaded purple, &c. Pinch the laterals back to the lowest leaf next the main shoot; but what reason have you to stop the shoots at this early season? We presume the Peach trees are trained to walls, and, if so, they ought not to have been stopped; but if they are in pots or trained as standard, bush, or pyramid trees, then they should be stopped at the fourth leaf, and at every leaf after that. Mulching the trees now would be useful, especially if a good watering were given before the mulching was put on. Cut the Pear shoots back now to four eyes or leaves, and when they push again pinch them back to one leaf. We should think you leave the Peach tree shoots too long at the winter pruning, and that we think is the cause of your having fruit at the extremities of the shoots only. Train a shoot from the base of each spur, and in winter prune away the long useless fruit-shoot of this year, and train the young shoot in its place, shortening it in winter to 9 inches, cutting always at or a little above a wood bud.

VINE LEAVES SCORCHED (A Constant Reader).—We think the scalded appearance of the leaf enclosed is attributable to applying sulphur to the hot-water pipes whilst they were too hot. The reason of its affecting the *Muscata* of Alexandria most may be due to its leaves being younger and more tender than the others. If you could bear the hand on the pipes for a length of time without causing pain, no harm would result from applying the sulphur wet. We know of no remedy for scorched leaves, except to leave them as they are and to encourage the laterals, and when these have grown considerably stop them to the last leaf of each, at the same time retaining the scorched leaves if there be a bit of green anywhere upon them, but if completely burnt they are useless and may be removed. The Grapes may yet ripen if you encourage the laterals and retain the scorched leaves; never heed appearances in emergencies like this.

GERANIUMS FROM EYES (Idem).—Every eye with a leaf may be made into a plant, whereas with a cutting it is necessary to have two eyes or joints. Propagating from leaves is inserting the footstalk of the leaf in soil, and pegging the leaf on the surface of the pot. Now is the time to do this sort of work, but there are very few plants that can be propagated in this way.

ROSES WITH GREEN CENTRES (A. E. N.).—We know of no other cure for this than moving the trees in November, and planting them again in fresh compost, removing a quantity of the old. We think it is occasioned by the roots being fed to excess with manure. Try moving them next November, prune the roots a little, replant in some strong rich turfy loam, and mulch round the trees with a little half-decayed manure. Avoid planting them deep, do not cover the main roots with more than 6 inches of soil.

TREATMENT OF SEEDLING CYCLAMENS (E. T.).—Turn them out of the pots, and plant them out with the balls entire in a warm situation in the garden, and let them remain there until the last week in August or beginning of September. Then take them up, and pot each separately in small pots, double the diameter of the corms, in a compost of light turfy loam and leaf mould in equal parts, with a free admixture of silver sand. Provide good drainage, and pot so that the corms will be half inserted elevated above the surface of the soil, or the corm itself be half inserted in the soil and half above it. Water gently, and place on a light airy shelf in the greenhouse, water moderately during the winter. Continue this process for a year or two, increasing the size of the pots as the corms increase in diameter, and they will bloom about the third year from the seed.

DELARGONIUMS IN A WINDOW (T. R.).—The best thing you can do with your *Delargoniums* in a window is to water them with clean water until the pot is crammed with roots and the flower-buds show, and then use weak manure water. Perhaps the safest for you to use would be superphosphate of lime. Small prepared casks of this and other manures may be obtained from our office at 2s. 6d. each. Two ounces to a gallon of water will be strong enough. An easy way of applying it is to take as much as would lie on a sixpence and scatter it over a six-inch pot. Pour the water on it from a rose. In a week you may repeat the dose. A first-rats homely manure water is thus made: Half a peck of soot beat up into a thick paste, then mixed with half a pound of lime, and all mingled with twenty gallons of water. In a day or two it will be as clear and bright as brandy. On the last mixing in the same vessel half the quantity will do. Giving rich nourishment before you have plenty of buds will encourage leaves rather than flower-trusses.

POTATO (James Jackson).—It is decidedly wrong to call it "a bulb." In correct botanical language it is "a tuber"—that is, a fleshy knob connected by a fibre to the stem of the plant.

YOUNG CUCUMBERS WITHERING (H. W. W.).—We cannot be sure of the cause. Most probably the roots have descended to the horsedung and are too warm. Try what boring some holes in the bed and pouring cold water into them will do. If the one plant does so well take cuttings from it, and when they are struck plant them where the faulty plant now is.

FLOWER-GARDEN PLANTING (G. Gallowsay).—The great thing in such groups is to satisfy yourself. We can hardly advise, as you do not tell us whether you have other plants or not. Your centre bed you propose to plant with three or four flowers, and this is how we would do it—centre, Perilla; second ring, Yellow Calceolaria; third, Scarlet Geranium; fourth, Lobelia. If the Scarlet Geraniums were strong, and the Calceolarias dwarf, we would put the Geraniums in the centre, then Perilla, then the yellow, followed by the blue. The other six beds are planted each with a separate flower, as Asters, Stocks, Petunias, Verbenas, Tom Thumb Nasturtiums, and Gazania, and no doubt the beds will look well. We would prefer raising the beds, as Asters with stocks round, and the Tropæolum with Gazania round it.

SELECTION OF PEAS (South Hants).—What you say of tall Peas is very true, they do require trouble in staking, &c; but then, if sown a good distance apart, what crops such kinds as Ne Plus Ultra, British Queen, Glory of England, and Knight's Tall Marrow do produce! Then ground alters the habit of Peas so much. Veitch's Perfection, a rather tall Pea in many places, seldom gets above $3\frac{1}{2}$ feet with us; and, though a grand Pea, has never produced with us very abundantly. We have Sangster's podding freely, not quite 3 feet high; and we have the same kind, the first crop, a mass of pods, and from $5\frac{1}{2}$ to 6 feet in height, and by no means stopped in growth yet. We have not tried Eugénie; but Advance, we think, will support your criterion of a good Pea, and 3 feet in height. We have no doubt that Knight's Dwarf Marrows, white and green, though old Peas, are good ones, and will suit your purpose; and so will Hair's Dwarf Mammoth, a splendid Pea when well nourished. Harrison's Perfection is also a good sturdy Pea. In fact, unless much superior, the adding of novelties only confuses; and many years ago we proved that a number, some fine kinds of early Peas, might have come out of the same sack of seeds.

FRUIT OF THE PYREAS JAPONICA.—"A Constant Reader" wishes to know if this fruit can be rendered a pleasant eatable. He says he has been told that it makes a good pickle.

ORCHARD-HOUSES IN THE NORTH.—"E. S." wishes to know the age of the trees so productive in an orchard-house as mentioned by "A YOUNG AMATEUR," at page 420.

NAMES OF INSECTS (Zusticus).—Your Peach leaves are curled by the attacks of Aphis persicae and the effect of the weather; but the former have been nearly destroyed by the maggot-like larvae of the aphid-feeding flies (Syrphus sp.), several of which were in the box (G. F.).—The Vine leaves and stem are evidently gnawed by the Weevil Otiorhynchus notatus. Search for them with a light after dark. The insects on the Picea nobilis and Nordmanniana are the Aphis Picee or Piniphila.—W.

NAMES OF PLANTS (Robert).—1, not recognised; 2, Claytonia sibirica probably, but greatly crushed; 3, Polygala vulgaris; 4, Orobis vernus. (J. R. M.).—1, Polygala Dalmaisiana; 2, Abutilon striatum, or one of its varieties. (W. N.).—1, Hemerocallis flava; 2, Geranium sanguineum. (G. S.).—All but 6 are forms of Cystopteris fragilis; 6, not recognised in its immature state; 3 and 5, appear to be C. f. dentata. (A Lady).—We do not recognise from the leaf sent of your Adelaide plant. Send us a flower as well as a leaf. (R. Spencer).—Actæa spicata. (M. B.).—There are no numbers to your plants. They are—Phalangium Liliago, Cheiranthus ochroleucus, and Polemonium coruleum. The other looks like a Cerastium, but is not determinable. (S. S.).—Eunymus europæus.

POULTRY, BEE, and HOUSEHOLD CHRONICLE.

BRAHMA POOTRA PRIZES AT BIRMINGHAM.

WHEN an injustice demands redress, men of the nineteenth century seek sympathy and help from the press, and we of the poultry world naturally appeal in such a case to the powerful aid of your columns. Let me, then, call your attention to the very remarkable schedule of prizes issued by the Birmingham officials for their forthcoming show of poultry. The proverb, so familiar to us through the genius of a living writer, "It is never too late to mend," was in no case more applicable than it is to a timely change in the Birmingham prize list. Your readers will, doubtless, remember the able arguments, supported by a careful analysis of our leading shows, by which your correspondent "Y. B. A. Z." and others proved the necessity for meeting the just and growing claims of the Brahma fowl to additional classes and prizes at any future shows.

Mr. Houghton, the able Secretary of the Alexandra Park Show, has shown his appreciation of what is just and right, by giving separate classes to Dark and Light Brahmas; and Mr. Jennison, the public-spirited manager of the Manchester Show, has given encouragement to hope that he will do the same.

What will be thought by your readers of the claims of Birmingham to take the lead of English poultry shows, when, in contrast to the good sense of the gentleman I have named, the Birmingham officials propose to offer to Brahma Pootra fowls, of all ages and colours, only £15 10s., divided into eight prizes? On the other hand, they give to Polish fowls £40 10s., divided into twenty-one prizes!

To make the want of wisdom of this proceeding more pal-

pable, let me mention that last year there were at Birmingham in all forty-seven pens of Polish fowl and thirty-four of Brahmas, although the money offered to the latter (£13) was just one-third of that offered to the former (£39). Again, for Malay and Crève Cœur fowls, which last year mustered together sixteen pens less than the Brahmas, is offered this year the sum of £20, or £4 10s. more than is given to the latter.

These facts speak for themselves, and point unmistakably to the division of the Brahma class into Lights and Darks—an act of justice long delayed, but more than ever necessary now.

In conclusion, without reminding the Birmingham managers of the painful discussions which followed their last Show, and which, from what I have since heard from poultry breeders, I know to have alienated the affection of many from the so-called "Mother of shows"—without raking up the ashes of the past, I would only ask, Has Birmingham any popularity to spare? Can she afford to halt, to cling blindly to the past, while other shows are advancing? Is she alone to refuse to listen to the just claims of rising varieties? Will she, in short, with all her old glories as the mother of shows, allow it to be said of her youngest daughter, Alexandra Park—

"O matre pulchrâ filia pulchrior?"

—BRAHMA POOTRA.

NORTH HANTS AGRICULTURAL SOCIETY'S POULTRY SHOW.

THIS was held at Basingstoke on the 4th instant. The following prizes were awarded:—

DORKING.—First, Mrs. Pettatt, Micheldever. Second, J. K. Fowler, Aylesbury. Commended, Miss M. A. Terry, Dummer; Mrs. Pettatt; C. Cook, New Shoreham, Sussex; A. F. M. Druce, Barchclere, Reading.

COCHIN.—First, F. Pittis, jun., Newport, Isle of Wight. Second, J. K. Fowler. Commended, Rev. J. De la S. Simmonds, Chilcomb Rectory, Winchester.

GAME.—First, G. W. Ranwell, Portsea. Second, W. Pares, Ockbrook, Derby.

POLAND.—First, Mrs. Pettatt. Second, T. P. Edwards, Lyndhurst. Highly Commended, T. P. Edwards.

SPANISH.—First, Rev. J. De la S. Simmonds, Winchester. Second, J. K. Fowler.

HAMBURGERS.—First, Mrs. Pettatt. Second, F. Pittis, jun. Highly Commended, Mrs. Pettatt; J. Hunter. Commended, Mrs. Frederick, Shawford House.

BRAHMA POOTRA.—First, Mrs. M. Seamons, Hartwell. Second, J. Pares, Chertsey. Highly Commended, J. Hinton, Hinton, Bath.

VARIETY CLASS.—First and Second, Mrs. Pettatt. Commended, Mrs. Frederick; J. K. Fowler.

DUCKS.—First and Highly Commended, Mrs. M. Seamons. Second, M. Demitt, Basingstoke.

TURKEYS.—First, Captain R. P. Warren, Basingstoke. Second, S. H. Terry, Basingstoke.

JUDGE: Mr. J. Baily, Mount Street, Grosvenor Square, London.

DISEASES OF FOWLS—ROUP OR SWELLED HEAD.

THE diseases and fatal maladies of fowls are difficult to trace to their cause, and still more difficult to cure by application of any remedy: and of all diseases, real or presumed, to which our domestic fowls are subjected, the most frequent is the roup or swelled head. There is no disease to which poultry are subject from which we suffer more than from the roup or swelled head, which we consider one and the same. It is a very common and troublesome disease, and often proves fatal. All fowls are peculiarly liable to it. It generally originates in changes of weather and variations of temperature; and when the malady becomes confirmed, with running at the nostrils, and other well-known symptoms, they are termed roup. It affects fowls of all ages, and is either acute or chronic, beginning sometimes suddenly and sometimes gradually, as the result of neglected colds, stormy weather, or damp lodgings. The symptoms of fowls are identical with those so familiar in the human subject—viz., a watery or sticky discharge from the nostrils, and a slight swelling of the eyelids. In most cases the face is swollen at the sides, and the disease has the appearance, or seems to run on to true roup.

The most prominent symptoms, however, of roup are at

first identical with those of severe catarrh, as difficult and noisy breathing, a cough, a kind of rattling in the throat, beginning with what is termed gapes. There is considerable discharge of fetid matter from the nostrils, not unlike the glanders in horses; at first thin and limpid, but it soon loses its transparent character, becoming more or less opaque, and of a very peculiar and offensive odour; froth appears in the inner corner of the eye, the lids swell, and in some cases the eyeball is entirely concealed; the nostrils are closed by the discharge drying around them, and the eyelids are agglutinated together; the diseased secretion accumulating within the sides of the face frequently swells it to an extreme degree; and the bird, unable to see or feed, suffers from great depression and sinks rapidly.

As secondary symptoms, the appetite is all but gone, except for drink; the crop feels hard to the touch, and the feathers are staring, ruffled, and without a healthy gloss. The fowl sits moping and wasting in corners, always apparently in great pain. In this stage of the disease it is supposed to be infectious; and whether so or not, it is certainly proper, for cleanliness' sake if nothing else, to separate the diseased from the healthy ones to prevent the disorder from spreading through the yard.

As fowls habitually breathe through the nose, the mouth being kept closed, it follows that there is, even in the early stages, some difficulty of breathing, and a distension of the loose skin below the under jaw may often be noticed. The frothy matter appearing at the corner of the eyes results from the same cause—the air stopped in its passage through the nose, passes up the tear-duct, and produces the appearance of bubbles.

With respect to the communication of this disease, our experience proves that it is exceedingly contagious. It is, we are inclined to think, frequently communicated by fowls drinking out of the same vessel, as the discharge from the nostrils of the sick birds contaminates the water as it drinks.

Treatment.—In general we should say kill a fowl at once, unless it is valuable, as the risk of its contaminating the whole yard is great. At all events, let it be removed from the yard at once. Combined with every remedy, cleanliness is indispensable as the first, the last, without which all others are vain, and more than vain, as they may be pernicious by feeding, instead of starving, the disease.

Warm dry lodging and nutritious food are the first essentials to recovery; in addition, the frequent removal of the dried discharge from and around the eyes and nose, by bathing the nostrils with warm Castile soapsuds as often as necessary, and the swollen eyes with warm milk and water. In the way of internal medicine we find that nearly equal numbers recover under various modes of treatment. For all putrid affections take finely pulverised fresh burnt charcoal and new yeast, of each three parts; pulverised sulphur two parts; flour one part; water, quantity sufficient, mix well and make into boluses the size of a hazel nut, and give one three times a-day. Cleanliness is no less necessary than warmth, and it will sometimes be desirable to bathe the eyes and nostrils with warm milk and water or suds, as convenient.

“When fowls are infected with roup,” says Dr. Bennett, “they ought to be kept warm, and have plenty of water and scalded bran, or other light food.” When chronic change of food and air is advisable, Richardson gives the following formula:—“Powdered gentian and ginger each one part, Epsom salts one and a half, and flowers of sulphur one-half part, to be made up with butter, and given every morning.”

Mr. Giles, who is excellent authority, having had more than forty years' practice among the feathered tribes, says:—“My method with the roup, or swelled head—by the way is caused by a cold—is as follows: As soon as discovered, if in warm weather, remove the infected ones to some well-ventilated apartment, or yard; if in winter, to some warm place; then give a dessert-spoonful of castor oil; wash their heads with warm Castile soapsuds, and let them remain until next morning fasting. Scald for them Indian meal, adding 2½ ozs. of Epsom salts for ten hens, or in proportion for a less or larger number; give it warm, and repeat the dose in a day or two, if they do not recover.”

“But facts are better than words,” says Boswell, and we have the following case: A cock, about four or five

months old, apparently turned out by some one to die, came astray, and was in the last stage of roup. The discharge from his mouth and nostrils was very considerable, and extremely pungent and fetid, while his eyes appeared to be affected with inflammation. The roup, it may be stated, was quite prevalent at the time, and a very fine cock had perished in a corner hard by, of cold and hunger, from not being able to eat. The roupish cock was placed by the fireside, his mouth and nostrils washed with warm water and soap, which caused him to expectorate and sneeze off a quantity of the offensive obstructing matter. His eyes were washed with warm milk and water, and the head gently rubbed with a dry cloth. As he could not see to eat, he was put into a coop with a warm bed of hay to squat on. Some hours afterwards his head was again washed, and as there was much intermittent fever, though the cold stage prevailed, a stimulant plan was adopted. Long pellets were formed of barley meal, flour, mustard, and grated ginger, with which he was crammed several times a-day, his head bathed, and warmth attended to. He had milkwarm water, sweetened with molasses, to drink, for the purpose of counteracting the too heating qualities of the stimulants. The fireside always seemed to invigorate him; yet he still breathed with difficulty, and gasped, and had a rattling in his throat. In three days the stimulants, warmth, and cleanliness improved him so much that he began to see a little, and in a week his sight was nearly perfect. A little mustard was still given him in his water, and then some flowers of sulphur. He had also a pinch of calomel in some dough. He was gradually brought so as to season him to the cold, and in a month was in high health and spirits. Having moulted late, he caught a cold on the first frost, and suffered a relapse, having cough, gaping, ruffled feathers, and aguish shaking. Warm lodging and occasionally a lounge by the fireside proved a speedy remedy without medicine.—(Country Gentleman, American.)

EGGS HATCHED AFTER BEING CHILLED.

ACCIDENTALLY my eye has fallen on your Journal of last year, page 482, “Eggs Sat upon and then Chilled,” and you may like the following:—Referring to the inquiry at page 482 of June 30 last year, “Eggs Sat upon and then Chilled,” I have just had a brood of Duck's eggs hatched by a hen. After one hen had sat on them nine or ten days, she forsook them, which, having observed, I took them up and kept them some hours in a warm flannel before the fire till I could procure another hen, which has now brought out the young ones. The eggs had become almost cold before I perceived they were forsaken.—V. C.

AN ARTIFICIAL SWARM DESERTING ITS HIVE.

LAST week I made my first attempt at creating an artificial swarm; and though I was quite successful in some respects the consequences have not been at all satisfactory, and I should feel much obliged if any of your readers would tell me what mistake I have made. On the 12th ult. I drove a swarm out of a hive, which I will call A, into one of Neighbour's cottage-hives, which I will call B. I put B in place of A, and A in place of another strong stock which I will call C. The swarm in B, which was very large, appeared to rest and work well until the 14th, when they all rose out of the hive and showed every symptom of swarming, but finally returned, and hung outside the hive all the rest of the day and night following. On the 15th out they all came and settled on a hedge. I hived them into the same hive, and put glasses over them, and gave them air underneath. On the 14th I also repeated exactly the same operation with three hives, which I will call D, E, and F. About two hours after I had done so, and soon after the swarm in B had taken its first flight and returned, I found a queen and about twenty of her subjects on a clod of earth near my hives. Thinking I might have lost her in my operation that morning, I put her to the mouth of E, where she entered, and no fighting followed. But what appears to me the worst consequence of my driving is, that the stocks C and F, which I removed, are extremely weakened

by the loss of all the workers which were out at the time, and the bees in F are killing the drones as fast as they can. I should feel much obliged if any one would tell me whether I may expect C and F to swarm at all this season without driving, and also what I ought to do in the event of my driven swarms leaving their new abodes again.—T. H. L.

[The only mistake which you appear to have made was in giving the derelict queen to E, whereas in all probability she belonged to the vagrant swarm which had deserted B. This mistake is, however, serious enough, and, supposing the bees to remain in their hive, should be remedied without delay, either by supplying them with a sealed royal cell, or, better still, another fertile queen, or by adding a small swarm. Although we have never found it so, your narrative shows that artificial, like natural swarms, may occasionally take a dislike to and desert the hive in which they are placed. In all such cases we indulge their whim by hiving them in another hive, and keep a sharp look-out for the queen, which is liable to fall to the ground and be lost during these erratic vagaries. This is very likely to be the case when an artificial swarm quits its hive, since the queen, having been taken unawares, is generally too full of eggs to fly with facility, whilst her loss is irremediable by the bees themselves. A natural swarm in such a case would probably return to the parent hive, and depart again in a few days under a young queen; but an artificial swarm has no such resource, owing to their original dwelling being placed beyond their ken and abandoned to the possession of strangers. The removed stocks will rapidly recover their strength, but it is impossible to say whether they will or will not swarm naturally. The one which has killed its drones is less likely to do so than the others.]

ARTIFICIAL SWARMING.

I HAVE been waiting for a leisure moment to add my mite of information to what has been written in your columns on the subject of artificial swarming, although nothing need be added to Mr. Woodbury's and Mr. Fox's exposition of the art; still, as the multitude of witnesses establishes a fact beyond controversy, it will not come amiss if I bear my testimony anew to the excellence of Langstroth's plan. "PHILISCUS," in his recent communication, shows that some risk of failure attends the use of the "second stock-hive," and he instances a case of removal of a hive which was attended with disastrous consequences. Such, however, are very rare exceptions, if I may judge by my own experience. They will, however, be likely to happen when the stock to be removed has little sealed brood, or where the great majority of the bees are strong on the wing—as, for instance, in a hive which had recently swarmed, and before the young queen's brood has approached maturity; but where there is plenty of sealed brood and young bees coming out of their cells every day there is no risk of injury, and no hive should be used for the purpose which is not in this condition. Let "PHILISCUS" only try Mr. Woodbury's plan with proper precautions, and he will not care to adopt any other.

It will sometimes happen that the apiarian is spared the trouble of driving out his swarm, as in two out of three cases of artificial swarms which I have made this year on Langstroth's plan. In these instances the hives selected out of which to make swarms had a small super over them, into which the bees had worked comb and the queen had ascended to breed. Fortunately in each case the queen was caught in the super; so all that had to be done was to remove the lower box full of brood, and substitute an empty box in its place. The box of brood containing the majority of the bees was put aside under a bush in the garden for twenty-four hours, by the end of which time it was almost empty of bees, which had left it one by one to rejoin their queen. Nothing remained, therefore, but to remove the "second stock-hive," and put the box of brood in its place. Mr. Lowe will object to this plan as endangering the young brood. I can assure him from long experience that there is nothing to be afraid of; a mass of brood in a strong hive does not get so easily chilled. Of course in cold weather the box should be well covered up.

I have hitherto been very successful this year with my various bee operations. At the beginning of the season,

and even so late as the beginning of May, matters looked unpromising, as will be gathered from the following description of my apiary.

BEE-HOUSE.

A. No queen, bees dwindling away. B. Very weak even on the 15th of May. Pure Italian queen bred by me late in 1863. C. Very strong. Pure Italian queen had from Mr. Woodbury in 1862.

D. Fairly strong. Hybrid Italian from Mr. Woodbury in 1861. E. Weak in April. English bees. Now strong. F. Weak in April. Pure Italian queen bred by me in 1863. Now very strong.

UNDER COVER.

G. Very weak early in May. Pure Italian bred by me in 1863. Now strong.

GARDEN.

H. Very weak in end of April. English queen bred by me in 1863. Now strong. I. Improved straw hive. English bees. Very strong.

All is changed now, and prosperity reigns in my apiary once more. Out of C I drove the whole population on the 6th of May into a box three parts full of clean empty comb. After some hours' delay D was removed to A's place, and C shifted to D's stand. Swarm C set to work vigorously, and filled everything with honey and brood by the 15th, on which day the Italian queen was seen in the super laying eggs. As above stated, another artificial swarm was made out of C by substituting an empty box for that under the super. This, being full of brood, was made to change places with E, which in its turn was put in place of B. As to B, finding that it had a breeding queen—one of my pure Italians bred late last year, and that some of her offspring were well marked, I was loth to destroy her. I therefore made a swarm, if it may be so called, out of I by simply removing I to another stand (now K), and putting B in its place. This was done on the 19th, so far as I can judge with perfect success, as this swarm equally with all the other bees are working well. Piping was heard in D (late C) on the 21st, and a fine swarm issued from it on the 23rd. This of course, as also the hive from which it issued, has a pure Italian queen. The swarm was hived into one of my Tasmanian-boxes, and is located on the stand lettered L. My apiary, therefore, within four weeks of almost despair, may be described as follows:—

BEE-HOUSE.

A. Hybrid Italian queen 1861. Very rich and strong. B. English queen. Hive increasing in population and rich in honey. C. Pure Italian queen. Very promiscuous and active. Twice swarmed this year.

D. Young pure Italian queen 1864. Well-peopled and rich in honey. E. Three royal cells visible, sealed up. Pure Italians. Strong in numbers, and rich in honey. F. Very rich and strong. Pure Italian queen 1863. Working in super.

UNDER COVER.

G. Doing well. Pure Italian queen 1863.

GARDEN.

H. English queen 1863. Strong. Breeding fast. I. Active and promising. Pure Italian queen 1863.

K. English bees. Artificial swarm. Doing well. L. Pure Italian 1864. Swarmed May 23rd. Tasmanian-hive.

—B. & W.

DO YOUNG QUEENS BREED DRONES?

WILL Mr. Woodbury, or some other of your correspondents, favour the readers of THE JOURNAL OF HORTICULTURE with his views and experience regarding young queens proving the prolific mothers of both drones and workers before being more than three or four months old?

In the year 1861 all my hives threw top swarms before the end of June. On the 5th of July following, at half-past 8 A.M. hive A threw a fourth cast, and about an hour afterwards hive B threw a second cast. These two casts were united, and made an excellent swarm, its prosperity being augmented on unfavourable days by a liberal supply of left-over-season honey.

On the 7th of August I expelled the bees from the hive,

which was a common straw one, and found in it drone and worker brood in all stages, many of the drones, according to the entry in my note-book, being "nearly perfected in the cells."

I had then, as I believed, and as I believe still, strong presumptive proof of the statement that second casts, as well as first casts, will, under favourable circumstances, throw virgin swarms.

At page 116 of Dr. Bevan's work, first edition, it is said: "Bosc, the French Consul in Carolina, has stated that he had eleven swarms in one season from a single stock; and that each of those swarms, during the same season, threw off the same number of secondary ones." In the "Naturalists' Library," page 75, when speaking of Huber, the writer says: "He asserts that, before a queen commences her great laying of male eggs, she must be eleven months old; but he acknowledges that a queen hatched in spring will, perhaps, lay fifty or sixty eggs of drones in whole during the course of the ensuing summer. We know this to be true from our own experience; and also, as the usual consequence of this appearance of male eggs, that the bees commence building royal cells—the queen lays in them, and swarming takes place. . . . How are we to explain the fact of two or three score of these male eggs making their appearance before the mother bee is six weeks old?"

I may add that, although I have only adduced one instance in proof of the capability of a young queen laying the eggs of drones and workers within six weeks of her birth, it is not because I do not know of more.

I have observed, on various occasions the union of two or three after-casts exhibit the same phenomena, but I never saw swarms result. In a favourable season an overflowing population, I am persuaded, is all that is needed to enable and induce casts, whether second or third, to give off swarms; but I shall be glad to hear what others have to say.—R. S.

TRANSFERRING BEES.

I HAVE some common straw hives from which I wish to transfer the bees to box-hives, some time before the end of the season. I have box-hives full of comb ready for them. When would be the best time to drive them so as to sacrifice the smallest amount of brood and leave them time to lay in sufficient honey for their winter consumption?—Loose Box.

[Tenant your boxes at once with artificial swarms from your common hives in the manner recommended by Mr. Woodbury, in page 323. Three weeks after this operation drive all the bees from the old hives and unite them to the swarms. No brood will then be sacrificed.]

FOUL BROOD, AND WHAT HAS BEEN WRITTEN ABOUT IT.

(Concluded from page 374.)

It will be perceived from the brief sketch* given in No. 164 of the apiarian career of "The Silesian Bee-friend," as Dzierson delights to call himself, that he has had no small experience of foul brood. I need, therefore, make no apology for inserting at length his description of, and mode of treating, this terrible disease:—

"Beyond all comparison and incontestably the greatest misfortune that can afflict the bee-keeper is foul brood, which, as its name implies, does not affect adult bees but only the brood, which dies and putrefies partly in the larva and partly, also, in the nymphoid stage. The worst of this malady is, that not only is the diseased brood lost, but the brood-cells become infected and unfit for further breeding. Not only does the evil extend within the same hive to a larger and larger number of cells, but by infection also to a larger and larger number of stocks in the same apiary, and in its vicinity if effectual measures are not immediately adopted for its removal. Even the hives themselves become for a long time (although not for ever), unfit for use owing

to the morbid matter by which they are contaminated. It is an infallible sign of foul brood when, in isolated cells amongst healthy brood, some dead larvæ or nymphs are found which have collapsed and changed into a gelatinous or viscous substance, and afterwards dried into a grey, brown, or black crust at the bottom, or on the lower sides of the cells. If the major part of the cells be in this state, infection must have occurred some time ago, and the evil has already made great progress. Should the combs be fixtures the disease may be known by the unpleasant smell, similar to that of putrid meat or glue, which issues from the entrance: a foul-breeding stock generally ventilating very much. As the bees try to remove single larvæ which have not yet wholly putrefied, these will sometimes be found on the floor-board of a diseased stock. The bees also endeavour partially to remove the black crust which forms from the foul matter, and, therefore, dark particles, or, perhaps, entire linings are found on the floor-board, and these when rubbed between the fingers emit the same unpleasant smell. When other stocks are industriously comb-building in spring, foul-breeding stocks make no attempt to do so, or if they do, it is only when they remain tolerably strong and unusually good pasture occurs. If the combs are examined the brood is nowhere found regularly sealed, but stands more or less singly. If a piece of brood-comb is cut or broken off, and matter such as is above described be found therein, it is convincing evidence of the presence of foul brood.

"This disease is of two kinds, one mild and curable, the other pestilential and incurable; both, however, are infectious. The curable type manifests itself in this manner—most die in the unsealed stage, whilst the larvæ are curled up at the bottom of the cells: these putrefy and dry into a grey crust which is easily loosened. The brood which survives until it is sealed mostly comes to perfection, and it is only as an exception that one meets with some isolated sealed cells which contain foul brood.

"Quite different is it with virulent foul brood. In this case the larvæ generally survive until they have extended themselves, have been sealed, and have begun to change into nymphs. The foul matter, therefore, is not found at the bottom, but on the lower side of the cell. It is of a brownish colour, clammy and viscous, and, owing to the warmth of the hive and a small opening made in the sunken cell-cover, it soon dries into a firm black crust, which the bees are not able to remove, and which is only got rid of, if the stock be strong, by completely gnawing down the polluted cells and making new ones.

"This dangerous disease is readily introduced by infected honey either given to the bees or brought by them from foul-breeding stocks. If this takes place at a time when brood exists in the hive the disease is pretty certain to break out, although not perhaps immediately. It is only in the autumn, when breeding has ceased, that we may, in case of need, use honey from diseased stocks for breeding,* without, however, inserting the combs, since the morbid matter would but too readily inoculate the stock if such combs were allowed to remain in it until the spring. Although we have instances in which one colony in a twin stock† has been foul-breeding to a degree, whilst the other remained perfectly healthy, it is certain that the disease may be communicated from one hive to another by mere contiguity. Even the apiarian himself may readily transmit it when operating on a healthy stock, without having thoroughly cleansed his hands after having been similarly employed on a foul-breeding one. As a means of avoiding this evil we shall find the advantage of two distinct apiaries, since we cannot more surely withdraw healthy stocks from the danger of infection than by removing them and keeping them at a distance from the diseased ones.

"The treatment of diseased stocks must vary according to the virulence of the malady, and the season at which it manifests itself or happens to be discovered. The curable type, which may appear spontaneously in certain conditions of pasturage, especially when the bees gather from the bilberry and pine trees, sometimes also disappears of itself. The bee-keeper, however, must not rely upon this. It may,

* Here I venture entirely to differ from my distinguished contemporary, being strongly of opinion that under no circumstances whatever should such honey be given to bees.

† A twin stock is a double hive inhabited by two distinct colonies of bees.

* From Mr. Langstroth's work on the Hive and Honey Bee.

on the other hand, spread more and more, until the stocks are destroyed. In order immediately to put a stop to the mischief, the queen should be removed as soon as a few foul cells are perceived. In spring and early summer she may be advantageously employed in making an artificial swarm. If workers from healthy hives are added to her we may be certain of forming a healthy colony; but if workers from her own or other foul-breeding stocks were given to her we should be compelled to put the swarm in an intermediate-hive or a sieve, and keep it there from twenty-four to forty-eight hours before introducing it to its permanent domicile, within which, also, the queen must be confined for a few days in a queen-cage, until the bees have consumed and used for comb-building all the honey which they took with them from the parent hive.

"As no breeding takes place in a stock deprived of its queen, and no brood can therefore die and putrefy until a young queen has been reared, become impregnated, and commenced egg-laying, the bees, when tolerably strong, will have had time entirely to clear the brood-nest. They may be assisted in this by shortening the combs until they are able completely to cover them. The new generation will then usually prosper, and the stock be found to be cured. This end will be obtained with greater certainty if all the combs be cut out as soon as the brood has hatched, and the whole stock of bees be then driven into a new hive.

"If we can advantageously make use of the young queen, the risk of the reappearance of the disease may be more certainly obviated by removing her when she has become fertile and pretty well filled the brood nest with eggs. Altogether we cannot make a more profitable use of foul-breeding stocks than by employing them to raise fertile queens to make artificial swarms with, or to assist queenless stocks. It must, however, be remembered that they do not always succeed in rearing a young queen from the brood of their original sovereign, since all the royal cells may easily become foul, and they must then be assisted either by inserting a healthy queen-cell from another stock, or by giving them a young queen. In this way diseased stocks may produce a greater profit than equally strong healthy ones. They rear several queens in the course of the summer, and may also collect some pounds of honey. The bee-keeper who has foul brood in his apiary will be able to make good use of the queens, as he must set to work to make young colonies, in order to be able in the autumn to destroy every stock that is not perfectly healthy, since it would be foolish to winter colonies of which even the slightest suspicion is entertained, when hundreds and thousands of healthy stocks are destroyed by brimstone in the autumn for the sake of their honey. It would be especially inexcusable to winter a stock which suffers from virulent foul brood (as is unfortunately often the case in countries where klotz-hives* are kept), merely because the stock was formerly a good one. Even in spring such a stock should be immediately destroyed, but in such a manner that other bees do not taste of its honey, since in this way they may easily carry home the disease. Burn the hive out with straw, so that other bees may not become infected by licking up the honey which remains, or gnawing off the propolis and conveying it to their own hives. Even after having done this, the infected dwelling is not yet fit for use; it must be exposed to the air for two years if one would be secure against the reappearance of the disease. Although it may be possible, we have as yet no certain proof that fumigation with brimstone destroys the morbid matter, as is asserted by Hübner. Even boiling a hive in a large brewer's copper has proved ineffectual, since after drying, when a swarm of bees was hived in it, foul brood again appeared. The evil being, therefore, of so obstinate a character, we may readily know what to think of the remedies prescribed in many bee-books. By such means the mild, but never the virulent form of foul brood, might at most be cured. Where the latter exists, the only question is as to how the owner of the diseased stock may get rid of the disease with the least possible loss. First, we may in this case also make use of the queen, which, if the whole stock is not at once destroyed, should be removed as soon as possible. If, however, the bees deprived of their queen should have removed all impurity

* Klotz-hives are formed out of the hollow trunks of trees.

before a young queen has hatched and become impregnated, we must not think we have obtained a healthy stock. The evil would soon reappear, and worse than before, because the poisonous matter has probably so much the more permeated the food which has in the meantime been stored up for the brood. We must hasten, therefore, to remove the queen as soon as she has become fertile, and after a time again insert a royal cell, or cut out all the combs, and use the honey for any purpose but feeding bees.

"If we desire to restore the stock to health, it must be subjected to similar treatment to that already described, but for a longer time. After it has been kept confined during two or three days in a well-ventilated box or hive, it may be allowed to enter a new hive, within which the queen must still be confined for some time in a queen-cage, partly to delay breeding, and partly to prevent the bees deserting the hive, which such a stock is very prone to do. It is, however, not advisable to insert a brood-comb or even empty combs, because the bees must not deposit the food which they may still possess in the cells, but convert the whole of it into wax as far as possible. Notwithstanding all this, the stock may eventually desert the hive, or foul brood may reappear, so that all the time and trouble devoted to its cure may be lost. Better, therefore, make short work of it. Take the contents of the diseased hives and make as much money of them as possible, and with it buy healthy stocks. As it is easier to avoid the disease than to get rid of it after it has broken out, be cautious in buying foreign honey, especially for spring feeding. Instead of buying American honey, or honey in casks, rather use sugar or malt syrup entirely for feeding. Sugar-candy is at all events the best, grape sugar the cheapest, substitute for honey after bad years."

The subject of foul brood in all its phases having been thus completely exhausted by the most eminent apiarist of the age, it would be presumption in me to do more than state that the correctness of his reasoning, and the conclusions at which he has arrived, have been fully demonstrated by the experience of—A DEVONSHIRE BEE-KEEPER.

BEEs FED ON UNBOILED SYRUP.

It appears to me that in many cases foul brood is produced by feeding bees with honey which has been taken from diseased hives. Permit me to state that I have now an excellent stock from which I last year took about 16 lbs. of honey (by super-hiving), which in September, 1862, was given to me as not worth burning, and I do not think the hive then contained a single pound of honey. I, however, fed the bees plentifully on moist sugar dissolved in cold water, letting the water absorb as much as possible of the sugar and the surplus fall to the bottom, leaving a clear thick substance very similar in appearance to good fresh-drained honey. This I gave the bees in shallow dishes covered with thin sheets of perforated cork. The result is as stated at the commencement of my letter.—SOUTH DEVON.

THE FEMALE BIRD ACQUIRING THE COCK BIRD'S PLUMAGE.—The circumstance of an old female bird assuming the plumage of the cock bird is not a rare occurrence. I have known a Peahen acquire the plumage of the Peacock less the tail, a Duck that of the drake, a hen Bantam that of the cock. I have never heard or known an instance of the male bird acquiring that of the female.—G. G.

OUR LETTER BOX.

POULTRY KEEPING (A. B.).—If you enclose seven penny postage stamps with your direction you can have "The Poultry Book" free by post from our office. You will find in it all you require.

BEEs AFTER HIVING (F. L.).—The small cluster of bees on the ground contained the queen, and was probably joined afterwards by the little lot in the small hive. The proper course would have been to have at once placed this liliputian colony in the old stock's place, retaining the latter to a new situation. This, however, must not now be done, lest the young queen in taking her wedding flight should return to the accustomed spot, and be put to death, but a small swarm should be added as soon as possible. The second swarm will probably be unusually large.

WEEKLY CALENDAR.

Day of M th	Day of Week.	JUNE 21—27, 1864.	Average Temperature near London.			Rain in last 37 years.	Sun Rises.	Sun Sets.	Moon Rises.	Moon Sets.	Moon's Age.	Clock before Sun.	Day of Year.
			Day.	Night.	Mean.	Days.	m. h.	m. h.	m. h.	m. h.	m. s.		
21	Tu	Q. VIC. PROC., 1837. Longest Day.	73.8	50.9	62.3	16	44 af 3	18 af 8	19 9	36 5	17	1 30	173
22	W	Sun's declination 23° 27' N.	73.4	49.4	61.4	16	45 3	19 8	53 9	53 6	18	1 43	174
23	Th	Wheat flowers.	72.1	47.2	59.6	15	45 3	19 8	24 10	13 8	19	1 56	175
24	F	MIDSUMMER DAY.	73.7	49.2	61.4	14	45 3	19 8	49 10	34 9	20	2 8	176
25	S	Crested Hair Grass flowers.	72.5	49.8	61.2	19	46 3	19 8	14 11	53 10	21	2 21	177
26	SUN	5 SUNDAY AFTER TRINITY.	73.5	50.2	61.9	18	46 3	19 8	40 11	after.	☾	2 34	178
27	M	Hemlock flowers.	71.9	47.9	59.9	22	47 3	19 8	mozn.	27 1	23	2 48	179

From observations taken near London during the last thirty-seven years, the average day temperature of the week is 73.07, and its night temperature 49.2°. The greatest heat was 93° on the 22nd, 1846; and the lowest cold, 35°, on the 23rd, 1851. The greatest fall of rain was 0.80 inch.

GROWING MUSHROOMS.

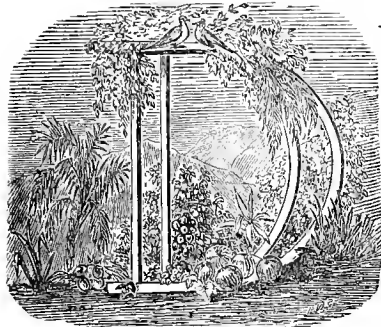

URING the Horticultural Meeting at Brussels, the exhibition at which was so ably described in one of your late Numbers, it was stated in one of the Committees that it was desirable to encourage the growth of Mushrooms as is now done in Eng-

land, where they are very easily propagated by "coffee grounds" and by "the ashes of the roots of Hazel."

It was also mentioned that in England three kinds are principally cultivated, one of which is extensively produced upon "thin Poplar boards kept continually moist."

I should be glad if any of your correspondents could give information as to the method employed to grow Mushrooms artificially, and particularly as to the systems to adopt with coffee grounds and Poplar boards.—CONSTANT READER, *Brussels*.

[We can only come to the conclusion that a "CONSTANT READER" at Brussels must have skipped over the many articles on Mushroom culture in this serial, or he never would have come to the same conclusion as the dreamers at Brussels seem to have arrived at—that we manage to obtain a supply from coffee grounds, roots of Hazel, and the watering of Poplar boards! A good friend of ours was so keenly set on philosophical experiment that he became a little affected in his mind from trying and believing he would succeed in producing vital organisms from certain combinations of mere matter. The coffee-grounds theory would have helped wonderfully amid his disappointments. We assured him that if from his ground flints, shells, chalk, granite, and all the rest of it, he succeeded in forming one living creature, however small, we did believe that he would live long enough to fashion and mould an elephant buoyant and instinct with life. If we can grow Mushrooms from ashes and on boards without any rudimentary organism in the shape of seed or roots, then we may also be able with the same means to grow an Oak or a Palm.

Like will only produce its like after its kind, be it a Fungus or a Pine Apple. Once get the seed, or what is tantamount to a seed there, and careful management may secure some produce even under the most unpromising circumstances.

No doubt Mushrooms might be grown on the materials referred to, but as most of the Fungus tribe have some favourite material for their spores (seeds) or spawn, the produce from such boards that came without artificial planting would be more likely to be poisonous than edible.

The Brussels Committee no doubt were misled by the directions for making artificial Mushroom spawn by old authors, recommending getting soil from the bottom of a hedge, and pieces of old decayed wood to mix with it. Now we object to all such combinations, because all such places and bits of wood are apt to be the receptacles of the seeds and spawn of spurious Fungi instead of the true *Agaricus campestris*, and spawn thus made is apt to produce more Mushrooms than the edible one.

Our correspondent gives us also credit for cultivating more kinds than we do. In this respect we are far behind our continental neighbours. There are many slight varieties of the *Agaricus campestris*, but that is the only one that is generally cultivated. It grows most freely with us naturally in old pastures in August and September. It is known by its pleasant odour, its white or brownish-white top, and the pink colour of the gills beneath. When very young these gills are of a light pink, when half or more grown the pink becomes deeper, and as the Mushroom grows older the gills or laminae turn to a dark coffee-ground colour, when they are only fit for catsup. Other Fungi resemble the true Mushroom at this stage, but then they are smooth and slimy to the touch, and emit a disagreeable instead of a pleasant odour. These last, too, are mostly found near to or under trees, whilst the true Mushroom is mostly found on the open pasture. The true Mushroom will also be found under trees wherever the position is otherwise favourable; but in such circumstances it is never so safe as when gathered in the open pasturage.

Between the laminae or gills of the Mushrooms myriads of spores or seeds are produced, far too small to be distinguished except by a powerful glass. These are scattered widely like other small light seeds, and though many are lost, some, fortunately, get bedded in what by natural selection suits them best. We have never used the fact beneficially, except by soaking old Mushrooms in water, and then watering the Mushroom-beds with it. We thought that the beds were thus invigorated, but then we merely thought so.

Like most Fungi, the Mushroom delights in rich, decaying, organised materials—as the dung of the horse, the sheep, the deer, and the cow. The first seems to be the greatest favourite, especially when the horse is fed on oats and hay. The same rule holds as respects the others as to hard food. The seed or plant of the Mushroom thrives in cording chiefly after it is dry. Though we cannot see the spores or seeds we know they have been present by the underground plant, roots, or spawn, white thread-like substances penetrating and running through the whole of the material, and of itself distinguished from other spawn something similar in appearance by its sweet Mushroom odour.

It is by this spawn that British gardeners generally cultivate the Mushroom. To find it at first you must take up the ground where Mushrooms naturally grow, and either plant or preserve it for future use. The larger the white thread-like roots, the more exhausted will they have become. If the individual threads are smaller! **an**

the finest hair, they are just in the position for yielding Mushroom-beds, and also for saving in a dry place for years. A good place for obtaining this spawn is a mill-track, under cover, where the mill is driven by horses. The droppings of the horses are thus generally scattered, and become caked by the horses' feet, and we have often thus found large cakes of beautiful spawn. Another plan for easily getting spawn is to place two or three bushels of droppings from a horse fed on dry food in a dry place, and so loosely piled that they do not heat much, for that would destroy the spores and spawn. Often in about three weeks or a month spawn will be found running through the little heap.

So likely is this to be the case, that we have had good Mushroom-beds without any artificial spawning whatever. A layer of littery horse-droppings some 5 inches thick, and dry rather than wet, was spread over a hard bottom, and beaten, and a little common soil sprinkled over it. In eight days 3 inches more was added, and thus we went on until we had 15 inches deep, when we covered with 1½ inch of soil, and beat well. This bed never was hotter than 80°, and it became a mass of spawn throughout, and produced abundantly. To make sure in culture, however, we generally make up a bed to give the suitable rich receptacle, and then spawn it all over the surface with spawn artificially made, produced at first from natural sources, but now a common subject of commerce.

Last season we detailed the whole process of making it. We will shortly describe one mode. Obtain two parts of horse-droppings rather fresh, one part of cowdung in the same state, and half a part of road-scrappings or other loam. Work all up together with as little water as may be, so as to leave the mass like tough dough. Then use a mould, say 9 inches long, 2 inches deep, and 4 or 6 inches wide, and make the heap into so many bricks, and lay them down to dry, making two round holes in each brick, but not quite through. Turn the bricks several times until they are pretty dry, and then insert a little bit of spawn which you have proved into each of these holes firmly, and cover with a piece of moist cowdung. Then make a slight hotbed, and build these spawned bricks over it in an open manner, like a pigeon-holed wall, and cover all over with litter. Care must be taken that the heat inside is rarely above from 85° to 90° Fahr. The spawn will soon begin to run in the bricks, and must be frequently examined to see that it does not run too much. When the bricks are permeated all through then remove them carefully to a dry airy place, where they will keep good for years, and be always ready for spawning a bed. In using this spawn we generally put a piece about the size of a walnut to every 8 inches square. When a quick return is wanted we place the pieces thicker; but if thicker and the return quicker, the Mushrooms come too thick and are soon over. In making beds we use almost any material that will give richness and a little heat, often stubble and dry litter made sweet and reduced by partial decomposition; but the best of all are horse-droppings and the other droppings mentioned, when rather in a dry state so as not to heat violently.

We forgot to say that in making spawn we do not mind letting the materials have a good heat before mixing them, as that destroys all spawn and spores of spurious Fungi, but does not incapacitate the heap, when blended as recommended, from receiving and propagating the right spawn.

The places in which to grow Mushrooms are endless, and the modes of doing so are innumerable, being varied according to circumstances. The circumstances under which they flourish best naturally will give the key note to the science of management. In the extreme heat of summer it is rarely we can gather Mushrooms in the field. They are most abundant in the autumn months, when the temperature ranges from 55° to 65°, and when the ground may be at 70° or upwards at a few inches from the surface. This teaches us that the spawn when running will enjoy a temperature which the top of the Mushroom will not long endure.

We thus in artificial culture give a little more heat to the bed than we give to the atmosphere of the house. Even under these conditions in very dry weather the Mushrooms will scarcely show, but will long remain of a very small size. If a warm rain comes they will grow as if by magic. The fact is, they had grown a little before, but the influences were against them. If the rain continues long they will

produce abundantly for a short time, but then the spawn will speedily exhaust itself.

From these facts we may deduce the following rules for culture:—

1st. The spawn must be kept dry, but not thoroughly desiccated. If damp should get at it so as to encourage the small threads to run, and produce Mushroom on the brick, the chances are that the brick, or piece of spawn, will do little good in the bed.

2nd. The bed should be chiefly formed of rich sweet material, as the droppings referred to. It should be beaten firmly, watched, and spawned when the temperature is about 80°. The bed, after the spawn has run, may range from 60° to 70° and even 75°. If lower there will not be enough impetus to production. If much above 80°, and especially when from 90° to 100°, the spawn is destroyed. Most beginners are unsuccessful at first from over-heat. Then the materials should be somewhat dry rather than wet. The spawn dislikes to run in a very wet medium, and soon exhausts itself. The material should not be very dry, or the Mushrooms will be poor. A moist atmosphere is their delight; this is obtained out of doors by a moist covering of the beds, and in-doors by keeping floors and walls, &c., moist. The top temperature is best when it ranges from 55° to 60°; a few degrees more may be given when gatherings are wanted in a hurry.

3rd. On these premises the most difficult time for producing plenty of Mushrooms is during the months of June and July. At most other times we may leave well alone, or add to the natural heat. Then in general we must try and diminish it by growing in cellars, in thatched roofed sheds, or in double-roofed houses to moderate the heat. We generally grow Mushrooms under a shed in summer, and in a close house facing the north in winter, and where we can use artificial heat.

These minutiae as to heat and the material considered, it matters little about the size of beds, whether 3½ or 4 feet across and 1 foot or 3 feet in thickness, further than this, that the larger the bed the longer it should bear. To keep up a regular succession we prefer small beds. One of the best beds we ever had out of doors was thus improvised: A trench was dug out a foot deep, filled with rough horse-droppings and litter partly dried and well trodden, which made it about 10 inches thick. There being no chance of overheating, it was spawned, covered with 2 inches of garden soil, well beaten, and a little hay sprinkled over it, and a straw hurdle so propped over it as to keep out the fierceness of the July sun and heavy rains. In six weeks it yielded an abundant supply. The best bed we had out of doors in autumn, winter, and spring was thus formed: A space 4 feet wide was marked out for the bed, which was made of about one part of dung mellowed and sweet enough for a hotbed; and the other three parts consisted of old dryish material from the linings of beds. These were well blended, broken, and shaken, and built in the shape of a hipped roof. When well beaten at the sides it was 3½ feet wide at bottom and 3½ feet in height perpendicularly to the top of the ridge. The dryness and oldness of most of the materials prevented anything like violent heating. We felt the trial-sticks stuck in the bed every day; and when as hot as new milk and rather on the decline, we spawned it regularly all over, inserting pieces about the size of walnuts, 8 inches apart and about 1 inch below the sloping sides, and beat the sides again all over. We watched several days, and found the heat very steady. We then covered the ridged mound all over with about 1½ inch of rather stiff soil, obtained by taking the lower spit of the garden. This was kneaded well to the bed, levelled all over, watered, and then beaten smooth with a clean spade. The trial of the sticks for several days showed that the heat was declining; in fact, the covering of earth kept out the air and its oxygen, and prevented farther decomposition. A little litter was therefore thrown over the bed to prevent its being lowered in temperature too much. In eight days the temperature rose above 80°, telling us that the spawn was at work; and we reduced the covering a little, and only added to it and secured with mats and hurdles as the weather got colder. We never had better gatherings; but we daresay in cold weather at Christmas there was 18 to 24 inches of litter over it, and a covering of snow besides. There is less

trouble in winter in growing in sheds and houses. Our beds in sheds in summer are flattish, about 16 inches deep. In beds or on shelves in winter they are about 12 inches deep; and as soon as one bit is spawned and earthed we commence getting the manure for another, and rarely miss a crop.

We have grown in all places—floors of houses, boxes, pots, &c., but in every case the above are the essentials to success. The chief general errors are using material too wet or too dry, too cold or too hot, especially the latter; and employing spawn that from being damp or overheated at first has lost its powers. When the spawn is permeated by white lines as large as good sewing-thread it is rather far gone. We like to see the lines fine and slender as gossamer down. We have had spawn sent us at 6s. per bushel just worth its weight as manure—not a Mushroom would ever have come from it. It was new, too, it was afterwards explained. We procured some three-year-old quite up to the mark, but which the possessor had for two years considered useless. Generally, however, our great firms send it out first-rate. If they did not do so gardeners would all have to make their own, and for a small quantity there is just as much nicety required as for waggon-loads, and that would be an evil in these division-of-labour days. Generally, however, we like to save a lot of our own making.

Our good friend will now perceive that, however simple Mushroom-growing is, it does require a little more attention than pitching out coffee grounds and watering Poplar boards!—R. F.]

CHERRIES UNDER GLASS.

I COMMENCED gathering Cherries fully ripe on May 27th. The variety, the Early Purple Guigne, is the finest early Cherry known—old, but not at all common. They are now (June 10), very large, black, dead ripe, and most rich and delicious. The trees from which I have gathered these fruit are some of them growing in the ground and some in pots. They are equally good. The former are grafted on the Mahaleb stock, which is the best stock for trees under glass, as they do not grow so vigorously as those grafted on the common stock. A few days after the ripening of the Early Purple Guigne the Belle d'Orleans, a remarkably sweet Cherry, but not so piquant as the Guigne, commenced to ripen; and now the Empress Eugénie, a sort of early Duke, giving very large fruit not quite so sweet as the May Duke, are ripe, as are the Knight's Early Black and Werder's Early Black. May Dukes and Archdukes are fast ripening. These will be followed by the Bigarreaus, early and late; and then come the very late sorts, such as the Rival, Late Guigne, and Late Duke, keeping up a succession of ripe Cherries till the end of August and even later. I may be peculiar in my taste; but I confess that, although at this moment I have ripe Peaches, Grapes, and Figs, I find more pleasure in my Cherry-houses, and more satisfaction in eating Cherries "ripe and rich," than I do in other kinds of fruit. I never visit these houses without wishing that every good garden, whether north or south, could have one. Without them here a ripe Cherry would never come to the dessert; for the birds are so rapacious, that no sooner does a Cherry commence to colour than it is stripped from the tree. Nets are but of little avail unless double or triple, for they tear them open with their claws. This is one reason why I have resorted to Cherry-houses for ripe Cherries. Another, still more powerful, is the uncertainty of our ripening weather; so that often a fine crop of Cherries is entirely destroyed by a heavy storm of rain, which washes out all their richness.

Cherries may be grown in large and lofty houses, either planted in the borders and cultivated as pyramids, or half-standards, their shoots pinched-in; but I confess to liking a Cherry-house pure and simple, so that I can always carry the key in my pocket, and go in for a Cherry feast every morning if I please.

When cultivated with other orchard-house trees the early sorts of Cherries ripen long before other kinds of fruit, and are so very tempting that fingers cannot be kept off; so I devote two houses, each 20 feet by 14, to Cherries only, opening the ventilators for the summer as soon as the early Cherries commence to ripen, and covering the apertures

with double netting, which remains on till the last Cherries are gathered.

The most eligible kind of house for Cherry-culture for moderate-sized families is the span-roofed, 5 feet high at the sides and 10 feet to the ridge, and say 20, 30, or 40 feet long at pleasure. If it is merely for culture and not for ornament its sides may be of three-quarter-inch boards, with a shutter 1 foot wide on hinges opening downwards, 2 feet from the ground. This is all the ventilation required.

All the varieties of the Duke class, if grafted on the Mahaleb, may be planted in the borders and grown as pyramids, their young shoots regularly pinched-in to three leaves all the summer; but the vigorous-growing varieties of the Guigne and Bigarreau class should be grown in thirteen or fifteen-inch pots, and pinched-in as directed above. They soon form vigorous and most fruitful trees, beautiful when in blossom, and more beautiful when covered with ripe fruit from head to foot as mine are now. If trees of the last-mentioned class are planted out they form large trees, and are most difficult to keep under control, as they are generally grafted on the common Cherry-stock. By-and-by this will be remedied, for by double-grafting the Bigarreau Cherries on sorts that succeed well on the Mahaleb, a more compact and fruitful tree is formed. This method of fruit-tree culture is at present in its infancy; but it is likely to be most beneficial when fully understood by fruit-tree cultivators, who, by the way, are not particularly prompt in adopting a new idea, at least as far as my experience has gone.

One feels regret that Mr. Abbey has given us rather a low idea of the capabilities of the gardeners in his neighbourhood. They ought to be able to conquer all the difficulties of the position. By ripening good Grapes in January with the aid of fire heat only, Mr. Thomson has taught us to look doubtfully on our present laws of vegetable physiology, as far as regards the influence of light in ripening fruit. Why then should not the Bradford gardeners supply the tables of their employers with all our popular fruits in abundance? They have cheap glass and cheap coals, why then should they not by the aid of Cherry-houses, with a small amount of artificial heat, produce ripe Cherries abundantly in May and June? I hope to hear ere long that Mr. Abbey has taken the matter seriously in hand, and that complaints of not being able to grow abundance of fruit in a cloudy smoky atmosphere, will be things of the past. A gardener is not worth his salt unless he can, to a certain extent, conquer a difficulty, and that of a cloudy smoky atmosphere ought to yield to artificial heat and skill.

I have a strong hope that Mr. Abbey, in lieu of writing from home about the failures in fruit-culture at home, will visit, say, Nottingham and its neighbourhood towards the end of the present summer, or Liverpool, or some other place in the north where orchard-houses flourish. If he visit the first-named place, and it is not a long journey from Bradford, I am sure my friend Mr. Pearson will show him not only his own houses but those of his neighbours. Mr. Abbey can then and there go into the calculations as to the number of fruit that can be grown in a given space.

A few weeks since I was much struck with the abundance of fruit on some Peach and Nectarine trees in the house of a friend in Sussex. These trees are bushes and half-standards planted in the borders, the house heated by four-inch hot-water pipes, so as to ripen the fruit in June.

The gardener, who has the privilege of sending the surplus fruit to market, gave me the following account of the produce of a few of the trees last season (1863). I ought to mention that they are planted from 6 to 7 and 8 feet apart.

One dwarf bush of the Royal George Peach gave thirteen dozen of fine fruit. These made in Covent Garden Market from 8s. to 9s. per dozen, or say £5 4s. the tree, though its branches are about 3 feet in diameter. A standard tree of the same kind of Peach gave fifteen dozen, making the same price per dozen, or £6 for the tree. A dwarf bush of the Violette Hâtive Nectarine gave twelve dozen of fruit, which made the same price, or £4 16s. the tree. Many others were pointed out to me that had produced large numbers of fruit, but I think it unnecessary to burden your pages with too many details. I may, however, mention that a considerable sum of money was realised by the fruit of this house; and I ought also to mention, that unless Peaches and Nectarines

are taken to Covent Garden Market while the London season is in full blow, they are scarcely worth the trouble of gathering and sending.—THOS. RIVERS.

MY ORCHARD-HOUSE.—No. 3.

THE high temperature of May has been followed by a remarkably cold June, during which period orchard-houses have been most useful, chiefly in raising the average night heat. Out of doors many Peach trees show signs of distress. Intense heat with a deficiency of moisture in the soil, followed abruptly by unusually cold nights, will prejudice this year's crop more or less. All this we escape who put our faith in the shelter of glass. Nor can the advocates of heated walls find much to praise at such times. The trees not being at rest but, on the contrary, in extreme vigour from the stimulating May sun, must suffer in their foliage. Looking over my orchard-house trees I remark a case in point. We had a fine midseason Peach tree occupying one of our best walls, which, for many successive years, had, about this time, been so mildewed and blistered that it had been twice cut down. Last season it was condemned, and dug up a mere stump, hardly any roots and fewer branches remaining. It was planted in the house as an experiment, and this year every leaf is perfectly healthy, and it bears for the first time for, perhaps, ten years. What would this very tree have looked like after the abrupt changes of temperature of the last three weeks?

Of late the top ventilators have been open all night when not too rainy or windy, and this seems to have done good. The front ventilators are, of course, still closed during the night, but opened very early in the morning. We do not open everything at one time, and we find apertures to leeward of the prevailing winds very serviceable.

This fortnightly manual of orchard-house work being discussed; a certain number of questions from correspondents having been sent in containing matters of such importance as the formation of fruit-spurs, the absence of sufficient foliage among these, the proper pruning during this season of the secondary summer shoots, and such like, it will be necessary to go somewhat farther back to answer them. To take the Peach first, because it is the standard of excellence, and the test of all orchard-houses—it is one of the finest of fruits, and one of the easiest to cultivate under glass. Not to enlarge or confuse, let us suppose that the earlier stages of growth have been passed through fairly, and the tree brought into bearing. This will meet the case supposed by "J. W." The buds nearest the base of any of the branches will naturally have transformed themselves, without artificial aid, into a group of fruit-buds with a leaf-bud, at least, among them. These are termed in France *bouquets*, and the term expresses well their appearance. They are easily recognised, are very short, and close to the branch, and generally at the lower side. Being thus situated the sap does not greatly accumulate at these points, but passes vigorously upwards, forming triple buds and gross wood shoots whenever intercepted. As whatever shoots are placed at the under portions of branches receive a much less amount of stimulating influence than those growing on the upper parts, it is easy to understand that a natural fruit-spur like those described above should, after bearing once, easily dry up. If to this tendency to disappear be added any further cause for weakness whole portions of branches, of potted trees especially, might become bare in one or two seasons. Any attack of the numerous insects which infest the Peach would, by destroying the solitary leaves among the blossoms, hasten the ruin. It would be sufficient to smoke the trees, especially when in bloom, with hot tobacco smoke only once to destroy all future chance of fruit from these weak spurs.

One great cause of failure is allowing the extremities of the branches to become too strong, and thereby attract too much sap into these parts; and this is, I think, the prevalent defect of amateur pruning. As these natural fruit-spurs are most valuable, and produce the finest fruits, besides being models to us who practise close summer pruning, it is very necessary to restrain any rampant luxuriance of growth upwards.

There are other reasons for the loss of these fruit-spurs,

such as neglect of watering, which is sure to tell on them, forgetting to renew the top soil when exhausted, taking too heavy a crop from the trees during the first years, &c.; but overcrowding the trees is one of the usual causes. If the trees in pots be badly grown—that is, without allowing ample space for the sun heat and air to circulate within and around them, and if a certain number of trees are placed in these conditions, then these fruit-spurs, having by nature very few leaves, growing naturally in shaded portions, and at the under sides of branches, receiving less sap thereby, must easily perish and dry up.

It is not so easy to understand want of foliage on the other classes of shoots which grow on the Peach. Generally one hears of disbudding—that is, removing superfluous shoots and leaves; and sometimes in the orchard-house we cut away leaves to allow specimen fruits to have more of the sun.

Having disposed of these, let us briefly consider other kinds of shoots: for though, under the present style of pruning to three or four leaves, we have no need to think too much about what the shoot is, yet, for the benefit of others, I shall go through all of them. If my amateur friends will only look closely they will soon see what class of shoot they operate upon. Buds placed higher up in the "mother branches" receive more sap, but not so much as the rest near the extremities. A pleasant class to prune is that which, about 6 or 8 inches long, has fruit-buds neatly placed along it, and two or three convenient tiny wood-buds at the base. This class I always pinch to four well-developed and well-coloured leaves in the summer pruning, so that it has no time to reach 8 inches, which it would do under the old system. Pinched-in it only makes 3 or 4 inches of a first-rate bearing shoot. It will not grow very much more, being near the main stem; but the second growths (which the extreme bud only will make) will, after growing to four good-sized but not so well coloured leaves, be pinched in to two leaves. This class of shoot is not likely to make third growths, and, at the winter pruning, there will appear at least two groups of triple buds to cut down to; for the second group is not needed now.

Under glass it should be an object to multiply the number of shoots, because we are not obliged, as in out-door pruning, to cut away forerights, or shoots growing awkwardly behind the branches: therefore, on the original shoot, which is now become a short spur, we have obtained two or three or even four shoots, so that after selecting which of these are to bear next year, and leaving them long enough for this, the others are cut down closely to one or two eyes near to the spur to furnish new wood in succession. In the case of the class of shoots I am speaking of you will get a choice of triple buds to cut down to having plenty of foliage among them.

It may be well to mention that, out of doors, these shoots should be only pinched-in once when well grown and sturdy, and not before midsummer generally, and cut down to 4 inches above a triple bud in the winter. But I must not go too much beyond orchard-house work, and shall reserve the other classes of Peach shoots for another paper, as also answers to questions on summer laterals, or *anticipés* as the French call them.

In answer to "E. A.," the most valuable early Peach is Early York. My largest early Peach is Crawford's Early. The earliest Peach from Montreuil in the Paris market is Early Grosse Mignonne; but Early York and Canary were ripe with me one fortnight in advance of Montreuil. Indeed, I saw last year in Paris no Peaches whatever on the 30th of July but Algerian. These were fine and good, but not numerous. I went over M. Lepere's gardens, and none had been sent to market by him; while in my own orchard-house fine Peaches had been ripe from the 15th of July, and would have competed with any from Algiers.—T. COLLINGS BÉHAUT, *Richmond House, Guernsey.*

CLEMATIS FORTUNEI.

I THANK YOU for your reply to my inquiry in the notice to correspondents, No. 167, and regret that I cannot answer more correctly the question you ask about the Clematis Fortunei. It is growing on one of the columns of a colonnade, in an exposed situation, erected about five years ago,

and may have been planted at that time with many other climbing plants; but I cannot find it in the list of the plants supplied to me then, nor do I remember having ordered a plant of the name from any nurseryman since. Three or four years ago, however, I received some plants direct from China, and I believe two or three were planted against the colonnade. This, therefore, may be one of them. It bloomed for the first time last year, and the flower then was better than the one I sent you, being perfectly globular. Will you further oblige me by stating in your next Number in what work I can find a description of the Clematis Fortunei?—R. J. G., *The Mount, Bishopstoke, near Winchester.*

[This is in answer to a request we made when naming the specimen of the Clematis sent to us, and affords only one of probably very many instances of new plants unknowingly introduced by private individuals. A coloured drawing and description are in vol. ii., page 169, of the "Florist and Pomologist."]

THE ROYAL HORTICULTURAL SOCIETY'S FLORAL COMMITTEE.

THIS meeting was held at South Kensington on the 14th inst. There was an unusually large and magnificent display of flowers.

Mr. Turner kindly sent a fine collection of his Pelargoniums to illustrate a lecture to be given on that day on this popular flower by W. Wilson Saunders, Esq.

Mr. Bull, Chelsea, sent several specimens for examination, consisting of *Echeveria pulverulenta*, a well-known plant; Pelargonium Achilles of the Scarlet section, of an unusually intense bright orange scarlet colour, but deficient in form of flower—second-class certificate; *Pleione Schilleriana*, a beautiful little Orchid, with delicately mottled greenish white flowers—first-class certificate; *Dracæna spectabilis*; *Imantophyllum striatum pictum*, which had received a first-class certificate at the last meeting; and a very beautiful collection of seedling Scarlet Pelargoniums exhibited in a basket of moss.

Mr. Hally, Blackheath, sent Pelargonium Venus, very bright orange scarlet, with a fine white centre, zonate foliage, flower of excellent form—first-class certificate; and Pelargonium Sirius, variegated foliage; a very good variety, but not differing from many known kinds.

From Mr. Wescott, Dulwich House, came *Gloxinia Carlotta Patti*, of no remarkable quality; and from Messrs. E. G. Henderson, Wellington Road, six new varieties of their superb variegated seedling Scarlet Pelargoniums. They were all equally good, but scarcely better than Mrs. Pollock, and but little differing in the foliage, although they are said to be of stronger and better habit. One called Capt. Meade, with highly-coloured zonate foliage, of dwarf habit, had a first-class certificate. Capt. Peploe, Mrs. J. Maxwell Hutton, Benyon de Beauvoir, Mrs. Longfield, Mrs. Dumaresque, Stella Variegata, with yellow variegations. There are several sports of this Nosegay, but this appeared distinct from its yellow variegation. Mrs. Dumaresque and Mrs. Longfield, much resembled Mrs. Milford in the colour of the foliage and dark reddish brown zones.

Messrs. Henderson were awarded a special certificate for their valuable and interesting collection, which contained, besides the seedlings sent for examination, specimens of Sunset, Mrs. Pollock, Italia Unita, and Lucy Grieve; Phlox Louise Grelli, a very pretty variety of Phlox Radowitzki, with bright carmine stripes.

Mr. Booth, Ball's Pond, exhibited Pelargonium Phoenix Variegatum, flowers resembling Phoenix—an inferior show variety, having its foliage so cupped and crumpled as to represent a blighted form of the foliage of the Scarlet section. There was nothing to recommend it but its miserable deformity.

Mr. Turner, Slough, exhibited several very beautiful seedling Pelargoniums. Among the Fancy varieties, Silver Mantle, pale rose shaded with lighter rose, good truss, excellent, compact, dwarf, and robust habit, had a second class certificate; Dreadnought was dark rosy purple, thin truss, flowers rough; Blair Athol, a darker shade of Dreadnought, truss thin, flowers wanting in smoothness; Edgar,

dark maroon, white eye, the darkest shade of colour in this section, flowers smooth and circular, medium truss—this received a second-class certificate. Mrs. Dooling received a second-class certificate at the last meeting. The Rover, light mulberry crimson with light eye, smooth petals, of excellent form, and good habit, was awarded a first-class certificate. In the Show varieties, Mr. Turner had Leonidas, a crimson-scarlet spotted variety; Publicola, dark upper petals, light eye, lower rosy carmine, white eye, flower rather rough—second-class certificate; British Sailor, awarded a second-class certificate at the last meeting; Profusion, ditto; and John Hoyle, the seedling Pelargonium of the year, which had a first-class certificate at the last Meeting. Mary Hoyle, also from Mr. Turner, was a very fine and beautiful flower of the softest shade of salmon rose, good truss, fine substance and size, upper petals deeply blotched with maroon, clear white centre, altogether a most striking flower though a little deficient in form—a second-class certificate was awarded for this. The High Admiral from the same exhibitor was similar to British Sailor, but inferior both in colour and form. A special certificate was awarded Mr. Turner for his magnificent collection of Pelargoniums.

From the Rev. R. H. Charsley, Offley Road, Oxford, came *Verbena Una*. One truss only was sent; it is a promising variety, and was requested to be seen again. Three trusses or specimens are required of all cut flowers for examination.

Mr. Smith, Hornsey Road, sent Pelargonium Glory, light orange scarlet, zonate foliage, flower of great substance and good form; to be seen again. Mr. Smith had Pelargoniums Roi d'Italie and Herald of Spring for comparison with his seedling; the colour of Glory is decidedly brighter than either of these. It is very desirable that Mr. Smith's example should be followed by other exhibitors. It would save the Committee much trouble, and give greater satisfaction to exhibitors, if plants of older and known sorts were sent to compare with what are supposed to be new and improvements.

The novelties in seedlings, and the numerous imported varieties of the Scarlet section of Pelargoniums introduced last season, encourage the expectation that the prizes offered on the 6th of July next will induce a great competition. We have reason to hope that most of the growers of this beautiful flower will bring collections, and there will be little doubt of the success of this new feature in our great exhibitions. The public will have the opportunity of judging for themselves of the beauty and value of this class of plants, which, with care and little attention will render the greenhouse and conservatory gay from the present time until November. Many of the delicate-coloured flowers never display their beauty when planted out of doors; the slightest protection is all that is required, and we feel certain that no one will be disappointed if he gives them the simple yet necessary attention they require.

THE ROYAL BOTANIC SOCIETY'S SHOW.

JUNE 11TH.

(Concluded from page 430.)

Roses.—The only collections of Roses in pots came from Mr. W. Paul, who had a first prize, and Mr. Terry. Caroline de Sansal, Paul Perras, Lælia, La Reine, Coupe d'Hébé, and Baronne Prevost were fine plants and in very good bloom. Of cut blooms Mr. Turner, Messrs. Paul & Son, and Mr. Mitchell, of Piltown Nurseries, contributed splendid boxes, both in the Class for three trusses of twenty-five varieties and in that for single blooms, and in each they received prizes in the order in which they are named. In the Amateurs' Class, Mr. Exall, gardener to J. Hollingworth, Esq., Maidstone, was first with an excellent collection; Mr. Morris, Caversham Park, Reading, second; and Mr. Terry, third. Messrs. Paul & Son also had a box of Lord Clyde, the rich, red, full blooms of which were thus seen to great advantage.

MISCELLANEOUS.—Messrs. Dobson & Son exhibited several very showy varieties of herbaceous Calceolarias; Mr. Hooper, Bath, Pinks and Pansies, the latter being also shown by Messrs. Downie, Fergie, and House. From Mr. Salter and Messrs. Paul came stands of Peonies, large and very showy; from Mr. Young, Caladiums; and from Mr. Williams, Amarylises. Plant cases and window baskets were shown by

Messrs. Barr & Sugden, and neatly-filled hanging-baskets by Messrs. A. Henderson & Co., and Young.

New plants were exhibited in considerable numbers, most of them, however, have been already frequently noticed in these columns in other reports. Messrs. Jackson, of Kingston, sent a female plant of *Strangeria paradoxa*, and a beautiful variety of *Anaetochilus petala* with very distinct but delicate golden reticulations on a bright green ground. From Mr. Findlay, of the Manchester Botanic Garden, came a variety of *Alocasia*, with leaves about 20 inches long and not much less across, but inferior to *metallica*. Messrs. Veitch sent *Lilium auratum*, the large flowers of which perfumed the air to a great distance; the East Indian *Kaempferia Roscoana* with a single white flower rising from between two orbiculate leaves, dark brown variegated with whitish green; *Cattleya Wagneri* with white flowers; *Dracaena Cooperi*, and *Eranthemum tuberculatum*. Mr. Williams had *Dendrobium Parishii*, *Imantophyllum borbonicum*, *Dracaena Ehrenbergi*, and a fine variety of *Cattleya amethystoglossa*. Mr. Bull contributed *Caladium Van den Hecke*, a variegated *Polygonatum*, *Rhododendron tubulatum* with white flowers, *Pleione Schilleriana*, and other new plants. From Mr. Watson, St. Albans, came a flowering plant of *Astelia bivittata* and *Gleichenia Cunninghamii*. Lastly, there were numerous seedlings, of which *Pelargoniums* The Rover, from Mr. Turner; *The Rival*, Duke of Cambridge, and *Sensation* from Messrs. Dobson & Sons; *The Clown* from Mr. Windsor, and *Fairy* from Mr. Holland, had first-class certificates. Messrs. Smith, of Dulwich, sent some large-flowering seedling *Lobelias*, several of which had certificates. Mr. W. Paul had his splendid new *Rose Princess of Wales*, for which he had a first-class certificate; and a like award was made to Messrs. Downie, Laird, & Laing for *Pansies* John M'Nab and *Nethercote*.

FRUIT.

The show of Fruit, though not extensive, was very good as regards quality. A score of Pines were shown. Mr. Bailey, of Shardeloes, had a first prize for a *Providence* of 7½ lbs.; Mr. Smith, gardener to J. Walker, Esq., Calderstone, Liverpool, a second for one of 7 lbs. Of Queens, Mr. Floud, Aberdeen, sent two fine fruit, the weights of which were not stated, one of which took the first prize; and Mr. F. Chitty, Uplands, Birmingham, was second with a good fruit of the same kind. From Mr. Taylor, gardener to M. Ingram, Esq., Temple Newsam, Leeds, came a *Smooth-leaved Cayenne* of 4½ lbs.; from Mr. Young, of Highgate, one of the same kind from a crown grown without bottom heat, and the plant one year and eight months old. Mr. Floud sent a large *Prickly Cayenne*, but it was unripe.

Of Grapes about forty-eight dishes were shown, *Black Hamburgs*, of course, predominating, and almost without exception the bunches were well grown and of good size, and the berries large and well coloured. For this variety Mr. Hill, Keele Hall, took the first prize with three very fine bunches weighing 9 lbs. 3 ozs.; Mr. Meredith was second with large bunches. Very good bunches were also contributed by Messrs. Powell, Miller, Petch, Henderson, McKay, Wallis, and others. Mr. Hill, and Mr. Meads, gardener to R. Currie, Esq., Farnborough, each sent bunches of *Black Prince*, and of such even merit that it was impossible to decide which exhibition was the better. Mr. Hill's three bunches weighed 8 lbs. 10 ozs., Mr. Meads' 8½ lbs.; in both cases they were of nearly equal size, and the berries were equally well coloured. The only way of getting over the difficulty was awarding equal first prizes to both exhibitors, which was done. Mr. Pottle had a second prize, and Mr. Allport, Dodington Park, a third for the same kind. Of *White Grapes*, nineteen dishes were shown. Mr. Hill exhibited *Buckland Sweetwater*, the three bunches being perfectly ripe and weighing 5 lbs. Mr. Hill was first for *Muscadines*; Mr. M. Henderson second; and Mr. Young third with good bunches of *Buckland Sweetwater* from 11-inch pots. Mr. Meads, and Mr. Drewitt, Denbies, had good *Chasselas Musqué* and not cracked. With *Muscats*, Mr. Turner was first, the bunches and berries large, but wanting that fine amber colour which characterises the perfect ripening of this variety. Mr. Clements also sent large bunches but green. Mr. Meads exhibited *Trentham Black* in good condition; and Mr. Miller, gardener to Lord Craven, had fine bunches of *Golden Hamburg*.

Of Melons there was a good show, both in the Green and Scarlet-fleshed classes. *Golden Perfection* and *Scarlet Gem* were the principal kinds, but there were also numerous hybrids. In Green-fleshed Mr. Meredith was first with *Hybrid Cashmere*, Mr. Bailey second, Mr. Ruffett third. In Scarlet-fleshed Mr. Simmonds, Mickleham, was first.

In Peaches Mr. Allen, Hopwood Park, Lancashire, was first with *Royal George* fine; Mr. Petch second, with *Barrington*; and Mr. Ruffett, gardener to Lord Palmerston, had third for *Galande* highly coloured; *Royal George*, from Mr. Lynn, Hedsor, was likewise well coloured. The other exhibitions in this class chiefly consisted of *Royal George* and were very good, as also were the *Nectarines*. These principally consisted of *Elruge*. Mr. Allen, gardener to J. B. Glegg, Esq., Withington Hall, was first, Mr. Lynn second.

Of Cherries, some very good dishes were shown. Mr. Henderson, Trentham, had excellent *Black Tartarian*, for which he had a first prize; and Mr. Beck was second with *Black Eagle*. Elton, from Mr. Eastone, was first in the *White* class; and Mr. Lynn had a third prize for *Belle de Choisy*, remarkable for its transparent skin, showing the mottled amber flesh beneath.

In Strawberries Mr. Smith, Twickenham, was, as usual, first, with *Sir Charles Napier* and *British Queen* very large; Mr. Pottle was second with the latter kind and *Rifleman*. Mr. Turner exhibited *Sir Joseph Paxton*, a promising seedling resembling *President* in appearance, and said to be almost equal to *Keens' Seedling* in earliness. Some very good *White Marseilles* Figs came from Mr. Pottle; *Lee's Perpetual* from Mr. Ruffett; and small miscellaneous collections from Messrs. Pottle, Masters, and Petch.

APHIS-KILLING.

TILL very recently Mr. Fish has forgotten to name the best of all Aphis-killers, and even now he only alludes to it as "quassia water." When I have been reading his various remedies for Aphis-killing—such as tobacco water, fumigation, &c., I have always "mentally ejaculated," as the lady novelists used to write—Why does he not use quassia and soft soap? The receipt for making this most useful of compounds has made its appearance more than once in your columns, but a good thing cannot be too well known. Boil 4 ozs. of quassia chips in a gallon of soft water for ten minutes, and while cooling dissolve in it 4 ozs. soft soap, use it with a brush or syringe, or by dipping the shoots in it. This is the best summer Aphis-killer known, and rarely fails to kill all that come in contact with it, besides which it is not offensive like nasty tobacco water or tobacco smoke. After all our killers, Aphides are odd little fellows—sometimes almost invulnerable, at other times easily destroyed. Last season the *Blue Plum Aphis* was most abundant here, and yielded up his life only after a hard quassia fight. The tribe was very numerous, and cost me 1 cwt. of quassia chips in decoctions before it gave way. The *Cherry Aphis*, on the contrary, gave way without difficulty, and, although often difficult to destroy, his life was so embittered that he quitted it. The *Peach Aphis*—its summer green-coated enemy—not the brown Aphis of winter—is easily killed by the quassia compound, as are also the *Rose Aphis*, the *green Aphis* of the *Apple* and *Crab*, and, in short, all that I have met with.

I am, however, much interested in Aphis warfare, from observing how in different seasons they differ in strength and tenacity of life. About three years since the *Blue Plum Aphis* defied all his enemies; the strongest Gishurst, the most powerful tobacco water were applied in vain. He sucked and lived, and sucked again till the shoots were dry and sapless. One of my Aphis-executioners has just told me that the *Black Cherry Aphis* is hard to kill this season; he says that the large, fat, black fellows kick up their heels when the shoot is merely dipped, and stand on their heads for a short time till the liquid runs off them, they then settle down to their sucking work with their minds slightly embittered; and that although the young ones die at once, the copulent ones increase and multiply rapidly. It is only with the brush that they can be dislodged. Without doubt the quassia decoction is particularly well adapted for a summer dressing for all the species of Aphis but one, and that

one of the most pernicious, the *Aphis lanigera*, or the Woolly Apple Aphis; for this the Gishurst 8 or 10 ozs. to the gallon of soft water is the only sure cure, using a brush in applying it and avoiding the leaves. For a dressing for old trees or old walls in December it is invaluable, and entirely does away with the necessity of using those offensive ugly paints of clay, soot, sulphur, and urine so often recommended, as it kills eggs, and grubs, and all other plagues in embryo. If the cultivator wishes to give the bark of his trees a clean and healthy appearance in winter, the least offensive paint and the most efficacious is one made with two-thirds of unslaked or freshly slaked lime and one-third soot: every shoot and bud may be covered with this lead-coloured paint, which is soon washed off by the heavy rains of winter, leaving the bark beautifully clean and bright.

Mr. Fish often alludes to a "small brown beetle" which infests his trees in winter. Some weeks since I sent you a shoot of a Peach tree covered with them. You pronounced them to be the "winter form of the *Aphis persicæ*." I am inclined to doubt this, for this brown aphid which seems to delight in sucking the bare shoots of Peach trees under glass in the autumn and winter months, if allowed to remain on the trees during the summer never changes its form. It is most certainly an *Aphis* and not a beetle, and is easily killed with the quassia compound.—T. R.

FAIRLAWN.

(Concluded from page 433.)

THE *Rhododendrons* already named are only a small part of the collection of this charming tribe of plants at Fairlawn, and are only given as an example of what were in flower at one time. *Rhododendrons*, however, were not the only plants cultivated there, for in the border more especially set apart for them were some good specimens of *Camellias*; one a Double White, and another a Double Red, had been both gay with flowers, while the often much-neglected *Daphne cneorum* was well represented. Along the front some other popular plants were also allowed a place, the principal, however, being *Rhododendrons*. In other parts of the grounds choice shrubs and *Pinuses* were scattered about in various directions, and near the mansion a fine plant of *Desfontainia spinosa* was pointed out to me. It was upwards of 3 feet high, proportionately bushy, had flowered well for some years, and seemed in excellent health. As a companion to it was *Skimmia japonica*, broader but, perhaps, not so high, and in point of health and beauty equally good. In another place was *Prunus triloba* in beautiful flower, and an Oak was pointed out to me under the name of *Quercus bambuseifolia* which was said to have leaves upwards of 10 inches long, but being deciduous I did not see them fully developed.

Having taken a cursory view of some of the plants in the dressed ground, I next proceeded to some subordinate shrubberies, where, amongst others, were fine plants of *Benthamia fragifera* as large as *Lilacs*, and apparently doing as well. The hedge to the shrubbery also deserves attention, being composed of *Maclura aurantiaca*, or what is called the Osage Orange, a plant formidable enough in spines; and in summer its dense green foliage looks well, but it is questionable whether it will ever be so far acclimatised as to ripen the tips of its shoots, which, like those of *Fuchsias*, die back each year. Not having time to examine all, I proceeded to the park, where, scattered about in various directions, were some magnificent specimens of *Pinus* fully exposed to the winds in all directions, and only fenced in from the cattle in the ordinary way. Amongst others so placed I noticed the following as being remarkable:

Cupressus Lawsoniana.—Nine feet high, dense and bushy, a fine object; and when it flowers in spring, I am told that after the scales of the buds are thrown off the inflorescence is of a pretty reddish brown, adding considerably to its beauty.

Picea Nordmanniana.—Upwards of 9 feet high, its foliage presenting that height and breadth which renders this species so remarkable, besides being so gracefully incurved. As this species has not been long known in England, I should think this must be one of the finest specimens of it in this country, and by its healthy appearance it is evidently destined to become one of our most ornamental trees.

Cupressus Lobbi.—This graceful Fern-like tree is certainly not so much planted as it deserves to be, as few trees promise to produce an effect sooner than it does. I omitted to take the dimensions of the one at Fairlawn; but I find that one we have at Linton has grown 9 feet in two years.

Cedrus deodara robusta.—A specimen of this, about 9 feet high and proportionately bushy, presented that long and deep green foliage which distinguishes it from the parent variety, and, so far as appearance goes, the name seems very appropriate, for it does look the picture of a sturdy robust grower. There were many fine specimens of *Deodars*, differing in various ways from each other, and some approaching this one in character.

Wellingtonia gigantea.—Planted in the park with an open iron fence around it. This tree is 17 feet 11 inches high, of as close and symmetrical form as could be desired, being feathered to the ground, and, in fact, a perfect cone in shape; and, to show its sturdiness, I understand the circumference of the bole near the ground was upwards of 4 feet. The situation was rather exposed to high winds; nevertheless, it appeared highly probable that this fine tree would brave it all and go on prospering, and, judging from its present appearance, there seems no reason to question the belief of those who predict that it will one day overtop all our indigenous as well as imported trees.

Having extended this article beyond the proper limits, I must omit the many other fine plants to which my attention was drawn: but while in the park Mr. Dean, the intelligent gardener, pointed out an Ash tree that was said to produce *Mistletoe*. Some other interesting specimens also deserved notice, amongst which I must not omit mentioning a fine plantation of the common Yew, which some former proprietor of Fairlawn had planted many years ago as a wilderness. This plantation of several acres formed the terminus to the *Rhododendron*-border at its northern end; and to show how well the ground was adapted to the growth of the tree, there were comparatively few which had not stems as straight as *Spruce Firs* for 30 or 40 feet. I do not recollect of ever seeing so many trees presenting a condition so distinct from that in which the Yew is usually found. The boles, however, instead of being circular, were irregularly fluted or grooved, showing the true character of the Yew. They were in excellent health, a fringe or beard of green twigs covering the boles from bottom to top, the latter spreading out in the usual way when there was room for it to do so.

Through the kindness of Mr. Dean I also had a look into the glass structures, but had little time to note down much of what I saw there. In the conservatory near the house was a fine plant of *Cantua dependens*, 6 feet or more high, and in full flower. *Brachycome Drummondii* was also good; and at the end of a plant-house that was not in any way heated, was a fine specimen of *Solfaterre Rose*, blooming richly, and showing that however well this class of *Roses* may be made to succeed out of doors, they are nevertheless much superior when grown under glass. A double-flowering Peach was also pointed out to me as having been very fine, while some good plants of *Camellias*, *Acacias*, *Azaleas*, &c., gave the whole a gay appearance, reflecting great credit on Mr. Dean, to whom, as well as to his employer, I was indebted for one of the pleasantest visits I ever paid. Although I have of necessity omitted much that ought to have been noticed, I fear I can only offer an apology for doing so; and to the general reader I can confidently say, that a visit to Fairlawn to see the *Rhododendrons* and other shrubs and trees of interest, will well repay the little trouble of a journey.—J. ROSSON.

NEW FRONTIGNAN GRAPES.

Among the French there are a great many forms of what they call Muscat Grapes, but which are known by us as Frontignans—that is, those varieties having round berries in contradistinction to those that are oval, like the White and Black Muscats of Alexandria. Many of those varieties of Frontignan are scarcely distinguishable from the sorts with which we have been long familiar, and many of them are so much inferior as to be scarcely worthy of notice; but there are some that are decided improvements, and improvements of so great excellence as to force them on our notice.

We have received from Mr. Rivers, of Sawbridgeworth, three varieties that appear to us to call for special remark as possessing properties of this kind. They have been imported from abroad, and as they have only now fruited for the first time in this country we take the earliest opportunity of making our readers acquainted with them.

EARLY SMYRNA FRONTIGNAN.—This variety is evidently a form of the White Frontignan, which ripens as early as the Royal Muscadine. The bunch and berries are not so large as those of the old White Frontignan; but the bunches are well set, about 6 or 7 inches long, not shouldered, cylindrical. Berries about the size of those of Royal Muscadine, of a fine rich amber colour when fully ripe, and sometimes dotted over with minute rose-coloured dots. The flesh is melting, very juicy, and with a fine brisk muscat flavour in which is a distinct trace of orange-flower-water aroma. This is a sort well worth cultivating, and it may possibly succeed out of doors. As it does not belong to the Chasselas Musqué class it shows no trace of cracking in the berries.

SALOMON'S FRONTIGNAN is about a fortnight later in ripening than the Early Smyrna, and it also is a form of the White Frontignan, and therefore not liable to the same objection as the Chasselas Musqué is subject to. The bunch is of good size, being from 8 to 9 inches long, tapering, beautifully symmetrical, and not shouldered. The berries are the size of those of well-grown White Frontignan, round, and regular in their size. The flesh is firm and crackling, like that of the White Muscat of Alexandria, of a delicious sprightly muscat flavour.

PRIMAVERIS FRONTIGNAN.—This belongs to the Chasselas Musqué race, and differs from its type in being if anything a little earlier. It has hitherto been regarded as synonymous with that variety, and will require to be further proved before a sufficiently correct judgment can be formed of it.

CHOICE OF GRAPES.

So much difference of opinion is expressed about the new Vines lately brought into notice, that the remark is often made, "It is not safe to plant any but the old and proved varieties." It really is a great responsibility to recommend an assortment of Vines for a new house, and the subject cannot be too much discussed, nor too carefully considered.

After all, much depends on individual taste, and I will give my ideas on the subject, hoping to elicit the opinion of others.

I consider good Vines as of two classes—those which have a very decided flavour, and those which are merely sweet. Of the latter class the Black Hamburg is, without question, the best; so much so, that I would plant nearly half the Vines in an ordinary house with this variety, and for the same reason I would discard nearly all the merely sweet White Grapes.

If any person observes the selection of Grapes made at the dessert table, it will be found that those who like sweet Grapes generally choose the Black Hamburgs, and those who prefer a more decided flavour take White Grapes, and if they are not Muscats or Frontignans the persons so choosing are disappointed.

The only White Grapes I would plant for my own eating would be Muscat of Alexandria or one of its varieties, the White Frontignan, and, if the situation were dry, the Chasselas Musqué, and, perhaps, the Royal Muscadine as a very early and hardy Grape.

Of Black Grapes other than Black Hamburg, I would plant Muscat Hamburg—in my opinion the finest-flavoured Grape in cultivation. I have heard it called a tender kind—that is, a bad setter and liable to shank, but if grafted on the Black Hamburg it sets as well as the variety on which it is grafted, and all tendency to shank is removed, besides which the bunches and berries are greatly enlarged. I think it has only one fault—it will not hang long after being ripe without losing its peculiar flavour, and then becoming merely a sweet Grape; but for some time after it is ripe it is most delicious, being as juicy as the Black Hamburg with a decidedly Muscat flavour.

For variety I should like one Purple Constantia for its peculiar flavour, which resembles the Frontignan with just a taste of the Black Currant; one Trentham Black, a

thin-skinned, early, and delicious Grape which will not keep long after it is ripe; one Grizzly Frontignan, a general favourite but apt to shank; and several Lady Downe's Seedling and Black Alicante, the best of the late-keeping Black Grapes.

For an ordinary vinery containing—say, thirty Vines, I would select 11 Black Hamburgs, 4 Muscats to be planted at the warmest end of the house, 3 Muscat Hamburgs, 2 White Frontignans, 1 Grizzly Frontignan, 1 Purple Constantia, 3 Lady Downe's, 1 Chasselas Musqué, 1 Trentham Black, 2 Black Alicante, and 1 Royal Muscadine.

Of course, other kinds have their admirers, but these would be my choice. For a late house, where Muscats are the principal kinds intended to be grown, and where a strong heat will be required, I believe Barbarossa is one of the best Black Grapes both as to quality and keeping; but to have it in perfection it requires quite as much heat or more than the Muscat of Alexandria, and, as generally grown, it is hardly eatable. It is, therefore, scarcely to be recommended for an ordinary vinery, though its noble bunches render it a favourite with many.

Then, as to Trebbiano, White Nice, Old Tokay, White Portugal, and such kinds, they always remind me of a saying I once heard: "Oh, they are capital sorts to give away." Golden Hamburg and Ingram's Prolific Muscat are such bad growers that even if better Grapes they would soon go out of cultivation.

As to the varieties of Muscat of Alexandria, I believe that with the exception of the Canon Hall Muscat, it really signifies very little which variety is planted, not that they are identical, but that no one could identify the bunches if five or six kinds were mixed on a dish, and that it would take a very clever man to name with certainty most of the varieties of Muscat if the name of any plant were lost.—
J. R. PEARSON, *Chilwell*.

A PLEA FOR WILD PLANTS.

I AM glad to see that notice is taken by many of your readers of the more rare or remarkable of our British plants, not that I by any means advise that publicity be given to the whereabouts of exceedingly rare species, so as to incite the avarice and cupidity of some persons, but to show to the admirers of such things that more localities than one exist where such and such plants are to be had. Latterly I have been sorry to observe that most of the interest taken in home plants has centered on Ferns, not that I object to their claim to all the attention they get, but I should like a share to be bestowed on other British plants. There are several native plants far from common, and some of them, as the British Orchids, may doubtless present us with varieties in form if they be closely looked into the same as Ferns do, and varieties of the latter are often dignified with terms giving them all the importance of distinct species. What can be more pretty than our ordinary Meadow Orchis? while *O. maculata* is also showy as a plant, the leaf far exceeding that of any Begonia our hot-houses contain. Then the exceedingly rare *Cypripedium calceolus* is second to none of its genus for beauty, while amongst plants not generally met with is the lowly *Linnaea borealis*.

I believe, also, that one of the Irises is common enough; and in some districts the pretty *Saxifraga oppositifolia* is found, but I never was fortunate enough to come across it. There is, however, one of our most beautiful marsh plants, not by any means well known amongst gardeners—*Menyanthes trifoliata*, the beautiful fringed flowers of which would adorn and give importance to any exotic; while in its neighbourhood may possibly be found *Parnassia palustris*, *Drosera rotundifolia*, *Narthecium ossifragum*, a *Hydrocotyle*, *Comarum palustre*, and some other plants.

I remember travelling several miles to obtain the *Menyanthes* in flower, and did not regret the journey: for, with the exception of the white Water Lily, I am not acquainted with any British plant so pretty. My purpose is not to extend the list of interesting native plants, but to call the attention of young gardeners to them; and though the above is a meagre list of but a few of the worthies our country possesses, they may form a nucleus to which may be added what more our enterprising explorers may record. To the

young student, I may add, there is no more health-securing occupation than a good long ramble after wild plants, and to be rewarded with the discovery of a plant not previously known to the searcher is an intellectual enjoyment not to be undervalued.—W. R. R.

PORTRAITS OF PLANTS, FLOWERS, AND FRUITS.

ECHEMEA DISTICHANTHA (Two-rowed-flowered EcheMEA).—*Nat. ord.*, Bromeliaceæ. *Linn.*, Hexandria Monogynia. Native of St. Paul, South Brazil. Flowers scarlet and purple.—(*Bot. Mag.*, t. 5447.)

TRICHINIUM MANGLIESII (Mr. Mangles's Trichinium).—*Nat. ord.*, Amaranthaceæ. *Linn.*, Pentandria Monogynia. Native of Swan River, imported by Mr. Thompson, Ipswich. Flowers lilac. "At present treated as a greenhouse plant, but probably may be grown as a summer annual, as many Australian and South African plants."—(*Ibid.*, t. 5448.)

CATTELEYA LINDLEYANA (Dr. Lindley's Cattleya).—*Nat. ord.*, Orchidaceæ. *Linn.*, Gynandria Monandria. Native of Bahia. Flowered in September. Flowers white, tinged, spotted, and lined with rose-colour.—(*Ibid.*, t. 5449.)

THIBAUDIA SARCANTHA (Fleshy-flowered Thibaudia).—*Nat. ord.*, Vacciniæ. *Linn.*, Decandria Monogynia. "A most charming Vacciniaceous plant." Native of New Grenada. Imported by Mr. Bateman. Flowers scarlet and green.—(*Ibid.*, t. 5450.)

DENDROBIUM FARMERI var. *AUREO-FLAVA* (Mr. Farmer's Golden-yellow Dendrobium).—*Nat. ord.*, Orchidaceæ. *Linn.*, Gynandria Monandria. Native of Moulmein.—(*Ibid.*, t. 5451.)

DESMODIUM SKINNERI var. *ALBO-LINEATA* (Mr. Skinner's White-lined Desmodium).—*Nat. ord.*, Leguminosæ. *Linn.*, Diadelphia Decandria. Native of Guatemala. A pretty stove climber. Flowers purple. Leaves white line down the centre.—(*Ibid.*, t. 5452.)

TULIPS, EARLY.—Exhibited by Messrs. Cutbush & Son. *Proserpine*, rich rose; *Keizerkroon*, yellow and red. *Roi Pepin*, white, flaked with crimson.—(*Floral Mag.*, pl. 197.)

ROSE Madame Victor Verdier.—Sent out by M. Eugène Verdier, *Jils aisé*, of Paris. Very great depth in shape, though of dark crimson, very usual.—(*Ibid.*, pl. 198.)

LAPAGERIA ALBA.—Introduced by Messrs. Veitch, from their collector in Chili, Mr. Pearce. Differs only from *L. rosea* in the colour of its flowers, which are ivory-white.—(*Ibid.*, pl. 199.)

CINERARIAS.—Raised by Messrs. F. & A. Smith, Dulwich. *Flower of the Day*, violet; *Rembrandt*, mulberry; *Eliza*, crimson, and broad white band.—(*Ibid.*, pl. 200.)

PELARGONIUM Diadem.—"One of the best and most characteristic of the flowers of 1863." Raised by Mr. Hoyle, Reading. Lower petals rosy purple; upper petals dark maroon, with rosy purple edge. It is in the possession of Mr. Turner, Slough.—(*Florist and Pomologist*, iii., 121.)

FURZE VERSUS GOOSEBERRY CATERPILLARS.

WILL you inquire of Mr. Peaks Banton whether he is certain that no other material besides the Furze was used by his man for the destruction of the caterpillars in his garden?

The Furze in full bloom, once renewed, has lain in the centre of my Gooseberry bushes for the last six or eight weeks, and with that and other appliances I have not yet been able to get rid of the caterpillars. I have seen the young larvæ eating with perfect impunity the leaves of the Gooseberry branches on which the Furze was resting.—R. SANDERS, *The Manse, Tunndergath*.

HAVING had ample opportunity of testing the efficacy, or otherwise, of the above, I beg to record its total failure. I placed a bunch of blooming Furze in each of my Gooseberry trees, both attacked and unattacked with caterpillars, and have now to use my crop in the green state, there being no leaves left to protect the fruit.

Query.—May not the destruction of caterpillars in the garden of the Vicar of Duston be attributed to the cold and

frosty nights which, I understand, have been prevalent in the counties to the north and east of our own?—H. JEWEL, M.D., *St. Austell, Cornwall*.

I HAVE tried Furze for the Gooseberry caterpillar, and find it has no effect whatever, either in preventing or destroying them. It is, moreover, no novelty here. I am credibly informed that the Broom and Furze have been used upwards of fifty years ago, but to no effect. I have just been trying the solution of soft soap and soda, and find it an effectual remedy.—A LANARKSHIRE BEE-KEEPER.

CLIMATE AFFECTED BY THE DESTRUCTION OF TREES.

THE idea is often advanced that our seasons have changed, The weather is not now as it was forty or fifty years ago, when good Peaches were grown in all parts of our country except in portions of some of our most northern States; and south of New York they attained the highest state of perfection. But within the last fifteen or twenty years, in some sections where they once flourished they cannot now be grown at all; and even further south, where trees were often met with in perfect health thirty or forty years old, now the crop is extremely uncertain, and the trees scarcely survive ten years. The same influences that have so seriously affected the Peach have also proved injurious to other fruits, and even farm crops have in some degree suffered from the same cause. The question then arises—What has caused these meteorological changes? Undoubtedly it may be traced to the general removal of the native forests over a wide extent of our country. In early times thousands of acres of timber were destroyed in the process of clearing land for agricultural purposes. In later years a more thorough clearing has been caused by the great demand arising for fuel to supply the numerous railroads that traverse the country in every direction. The widespread clearing of the timber has not only affected the temperature of the atmosphere, but it is the direct cause of the sudden changes that mark the seasons in later years. Nor is the effect confined to the colder portions of the year. Summer showers are less frequent, and many of the mountain streams are either dried up or much reduced in size. No general remedy can be devised for these changes; yet in many localities means may be employed for the partial protection of orchards, gardens, and dwellings from the effects of the severest winter winds. This may be done, where the nature of the surroundings will admit, by planting belts or groves of trees on the most exposed sides of the homestead. These may be often rendered both ornamental and useful.—(*Albany Country Gentleman*.)

DO BEES PREY UPON FRUIT?

At a recent meeting of the Cincinnati (Ohio) Horticultural Society this subject was debated at some length with regard to Grapes, some denouncing the unfortunate bees, wishing them exterminated within a circuit of ten miles of the city, and talking of getting up an "indignation meeting," to see what could be done in the way of compelling their removal from the neighbourhood; whilst others defended them on the ground that hive bees never made the first attack, and that it was only after the fruit had been punctured by wasps or other insects that bees came and sucked the sweet juice from the openings thus made. We believe the latter to be the true state of the case. In England it is only in very bad honey seasons that bees will meddle with fruit. During all our experience we never but once saw fruit juice stored in honeycombs, and this only in a few cells of a single hive.

SANDRINGHAM GARDENS.—We hear that the erection and heating of the extensive ranges of houses in the gardens at Sandringham, the property of H.R.H. the Prince of Wales, has been entrusted to Mr. James Gray, the eminent horticultural builder, of Danvers Street, Chelsea.

DROPMORE.

WITHIN an easy walk of Cliveden is Dropmore, the seat of Lady Grenville, which has long been celebrated for its flower garden and extensive pinetum. The grounds altogether extend over 600 acres, about 50 of which are occupied by lawns, flower gardens, and shrubberies; and with the very limited amount of labour which Mr. Frost, the able and very intelligent gardener, has at command, the excellent keeping of the whole is marvellous. Although the situation is not so commanding as that of Cliveden, yet from some parts of the grounds fine views can be obtained—especially from an artificial mound, which commands views, over a wooded country, of Windsor Castle and Forest, Surrey, and the Hampshire hills; whilst at its base is a valley planted with Rhododendrons, Azaleas, and Kalmias, beyond which are dense masses of trees.

The chief feature in spring is the bulb garden in front of the house, represented beneath, which when in full bloom is most gorgeous. Here bedding Tulips are largely employed and with great success; and contrary to the experience of most gardeners, they are not thrown aside after the bloom is over, but are preserved from year to year, and sometimes afford a second bloom better than the first. It must be remembered, however, that the beds are well prepared by trenching and manuring, that the leaves are allowed to die down before the bulbs are taken up; and that when taken up they are thoroughly dried and ripened before being stored away. This year the beds were planted as follows:—

Some idea may be formed of the immense number of bulbs annually planted in this garden from the fact, that each of the circles 2 and 3 contained no less than two thousand bulbs; and the effect of the whole when in the height of bloom can be more easily imagined than described.

A flower garden in front of the aviary, consisting chiefly of rectangular beds having the corners cut out in segments of a circle, was also gay with Double Red, *Oculus Solis*, and other Tulips.

Passing through the rockery, planted with hardy Ferns and Alpines, and turning into a walk bordered with Azaleas, which would soon be in bloom, we entered a flower garden, the beds in which were being prepared for bedding plants. Mr. Frost's practice with these is to plant out early in May, and protect the more tender ones with laurel boughs stuck in the beds. Behind these beds were scalloped borders filled with herbaceous plants, *Præonies*, and *Roses*, edged with *Crocuses* and *Dogs'-tooth Violets*.

In the intervals between the beds along the sides of the walks were porcelain and artificial stone vases, which in summer are filled with *Scarlet Geraniums*, &c. A square adjoining this garden was a gorgeous mass of *Ghent Azaleas* of various colours.

In another part of the ground, on a lawn amid stately trees, were some round beds planted with standard *Fuchsias* with stems 8 or 10 feet high; and some of them, Mr. Frost considers, will have heads from 6 to 8 feet in diameter by the end of the season. They are wintered in a greenhouse, and planted out in spring in the beds, which are previously filled with a depth of from 3 to 4 feet of prepared soil. This part of the grounds is known as "The Beeches;" and in

summer, when the *Fuchsias* and bedding plants are in bloom, it must be delightful to view the flowers from the shaded spots beneath the trees. These, however, must cause some trouble to Mr. Frost in keeping the grass and beds in the excellent order which they presented. Several rustic baskets of various designs, not overloaded with ornament, as is too often the case, but of simple designs and common materials, are also met with here and there among the trees, and in summer are filled with bedding plants. At the extremity of this portion of the ground are beds of *Primroses* in front of shrubs and under trees, and they afford in spring a splendid bloom of various colours from white to purple.

The pinetum at Dropmore first commenced in the end of the last century, is very extensive, and is noted for the remarkably fine specimens which it contains. Being of irregular outline, and additions being constantly made to the collection, it is difficult to estimate how much ground it actually occupies. The extent of what may be strictly regarded as the pinetum is about 5 acres; but connecting this with other parts of the ground are belts and plantations, as well as single specimens by the sides of walks and drives. One of these, called The Cedar Drive, is alone some 600 yards in length, winding between fine Cedars of Lebanon, averaging 65 feet high. These were planted about sixty years ago.

The large *Araucaria imbricata*, probably the noblest specimen anywhere to be met with in Europe, is now 45 feet

high and perfect in every branch. An *Abies Douglasii*, 80 feet high, was likewise a magnificent object. Of the other Conifers, the following are the heights of some of the tallest—viz., *Cedrus Libani*, 68 feet, *C. deodara*, 49 feet 10 inches; *Abies Morinda*, 30 feet 8 inches, *A. Pinsapo*, 25 ft. 2 ins., *Abies Menziesii*, 36 feet 8 inches; *Picea cephalonica*, 30 feet 8 inches, *P. Nordmanniana*, 19 feet 9 inches; *Pinus Laricio*, 63 feet 6 inches, *P. Cembra*, 44 feet 9 inches, *P. Lambertiana*, 31 feet

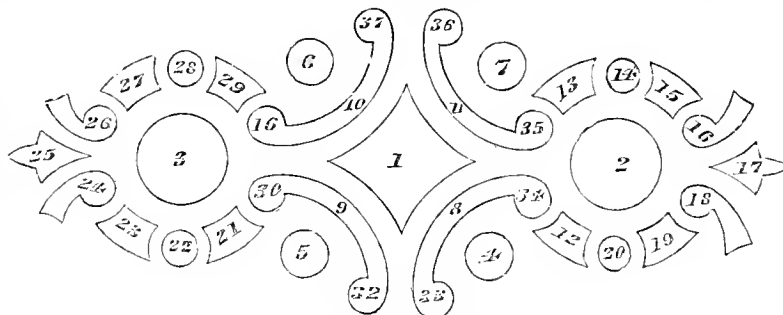

- 1, Jonquils.
- 2, *Oculus Solis* Tulip.
- 3, Double Red Tulip.
- 4, 5, Mixed Tulips.
- 6, 7, Mixed Hyacinths.
- 8, 9, 10, 11, Herbaceous plants.
- 12, Clarimond Tulip.
- 13, Goldfinch Tulip.
- 14, Golden Prince Tulip.
- 15, *Narcissus poeticus*.
- 16, Duc Van Thol Tulip.
- 17, Large Yellow Tulip.
- 18, Red Tournesol.
- 19, Jonquils.
- 20, Mixed Hyacinths.
- 21, *Oculus Solis* Tulip.

- 22, Mixed Tulips.
- 23, Jonquils.
- 24, 25, Mixed Single Tulips.
- 26, Single Purple Tulips.
- 27, 4-Seasons Roses.
- 28, Mixed Hyacinth.
- 29, *Oculus Solis* Tulip.
- 30, Violet Purple Tulip.
- 31, adjoining 1, but by an error of the engraver marked 16, *Oenothera macrocarpa*.
- 32, Double Copper-coloured Tulips.
- 33, Double Red Tulips.
- 34, Single Van Thol Tulips.
- 35, Double Van Thol Tulips.
- 36, Double Yellow Tulip.
- 37, Mixed Tulips.

6 inches, *P. excelsa*, 58 feet 8 inches, *P. ponderosa*, 56 feet 7 inches; *Wellingtonia gigantea*, 13 feet high, with a stem 3 feet in circumference at the base. This tree was planted in made soil, of which no less than fifty loads were required to fill the hole, the natural ground being very gravelly and bad.

In other parts of the grounds similar precautions are taken by Mr. Frost, the gravel lying from 6 to 8 inches from the surface; and were it not for the care which is taken with the older specimens in keeping the roots near the surface and in good soil, many of them would soon die off.

There are many other things at Dropmore worthy of notice, but which our hasty visit did not permit of our seeing, and we can only add that no one could be more kind and willing to communicate information than Mr. Frost.

[The noble owner of Dropmore—the last of the Pitts—is now no more. Through life she had been an enthusiastic lover of horticulture, and her last appearance in public was in connection with her favourite pursuit. "On Monday last," the 13th instant, says the *Times*, "there died a lady whose life had been so prolonged, and whose career had been so much associated with long bygone events that, though

cheerful and active, in the full enjoyment of all her faculties, and with a keen interest in passing events, her existence seemed almost an anachronism. Anne Grenville, only daughter of the first Lord Camelford, and sister and co-heir of that half-mad son of whom we read in the memoirs of Lady Hester Stanhope, born in London in 1772, and married

twenty years later to Lord Grenville, died also in London—ninety-two years afterwards—last Monday. Her last appearance in public was at the Botanic Society's Exhibition, on Saturday the 11th, when she seemed to be in her accustomed health and spirits. She was taken ill the same night, and only survived till Monday."]

CONSTRUCTION OF A VINERY.

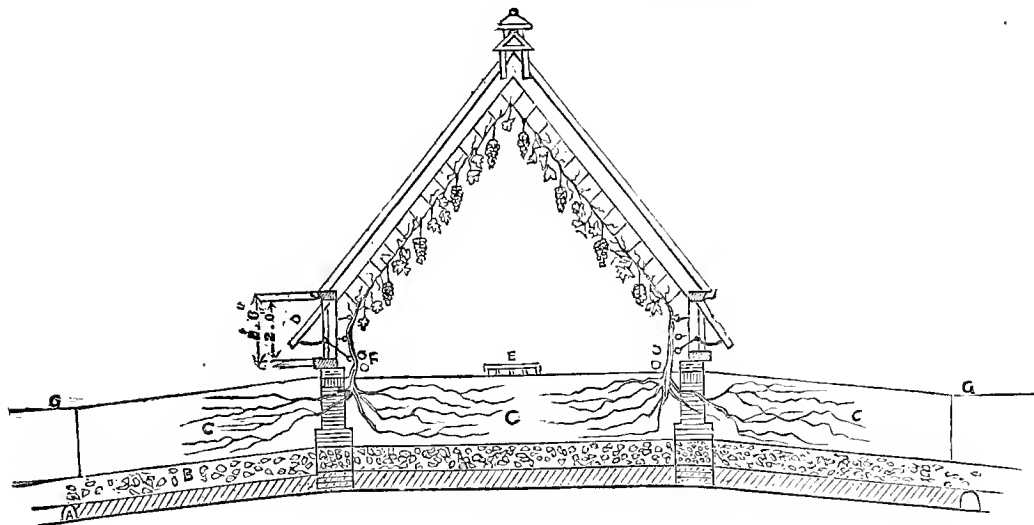

Section.

- A, A drain.
- B, Broken stones for drainage, 1 foot deep, resting on concrete.
- C, Vine-border, showing roots, 2 1/2 feet deep.

- D, Opening lights, 2 feet of an opening.
- E, Path.
- F, Hot-water pipes, flow and return.
- G, Ground level.

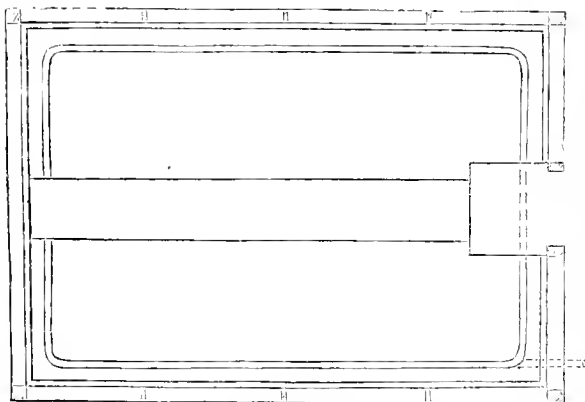

Ground Plan.

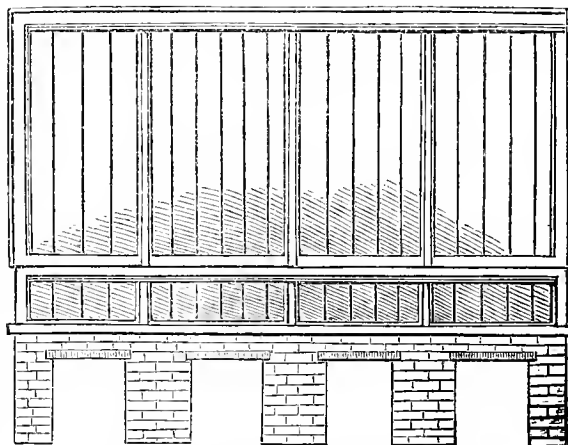

Side Elevation, showing the openings for roots.

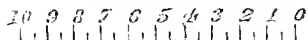

Scale of Feet.

This plan represents a span-roofed vinery, the dimensions of which will be found suitable for the generality of amateur growers. Its length admits of six Vines at a little more than 3 feet apart, which space is not by any means more than is necessary to do Vines anything like justice as to room. The span-roofed is what we regard as the best form for vineries in all cases, except that of very early forcing, when a lean-to facing direct south is preferable. The span-roofed house running north and south gets the sun early in the morning and late in the afternoon, while at all periods there is a greater diffusion of light, and Vines under such circumstances always make finer foliage and wood, and, as a consequence, bear finer Grapes than in a lean-to which loses

the morning and evening sun enjoyed by the span-roofed structure.

The house, of which a plan is given, to bring it quickly into full bearing should have six Vines planted on each side, and afterwards should there be any desire for such, one of the sets may be trained down the other side.

The lowest part of the surface of the border is shown at the same level as that of the ground, but in damp localities and in heavy cold subsoils it is well to keep it at least a foot higher, which, of course, necessitates the brickwork being higher; and cross drains should run from the centre of the house to the main drains A.

The side ventilation is effected by a rod and quadrant, and

the capping on the top is raised in much the same manner for top ventilation.

For Muscats it will be well to have three rows of pipes along each side instead of two, as shown in the plan.

The wires to which the Vines are trained should not be nearer the glass than 16 inches.—D. T.

WORK FOR THE WEEK.

KITCHEN GARDEN.

Now is a good time to apply salt to Asparagus and Seakale-beds, about a pound to a square yard is sufficient. It is of little use to lay it on after the plants have done growing, particularly when the soil is at all inclined to be cold and stiff. Stimulants applied now will enable the roots to lay up a good store of organised matter for another season, and, therefore, in addition to salt, occasional applications of liquid manure should be supplied if possible. The effect of such treatment will be perceived in the autumn by the plants retaining their green colour much longer than others not so treated, and in the spring by increased size and productiveness, evidently showing that the longer the functions of the plant can be preserved by the application of stimulants, the greater the amount of matter stored up for the ensuing season. *Celery*, the trenches for the main crops should now be prepared. For this purpose the spaces between the rows of Peas are very suitable; the shade from the Peas will be very useful to the Celery in its earliest stages, and they will be entirely removed by the time they are likely to be injurious. The planting out of Broccoli, Winter Greens, Kales, Cabbages, Cauliflowers, and Cape Broccoli must be vigorously prosecuted, and every vacant space should now be well filled up. Let liquid manure be in continual request. *Dwarf Kidney Beans*, another sowing may be got in for succession, and advancing crops both of these and Scarlet Runners should be well thinned out. Keep the soil about them well forked-up and pulverised. Experience goes far to prove that the fork is much the best instrument that can be used amongst all wide-apart crops. *Lettuce*, continue to make occasional sowings of the White Silesian for stewing, and the Paris Cos, Bath Cos, and Green Cos for salads. *Peas*, continue to top them and also Broad Beans as they advance, and keep them well gathered as they become fit for the table. Make another sowing of Peas. The Early Frame is the best sort for this and the next sowing, after which time there is but little chance of their coming to perfection. *Tomatoes*, see that they are well thinned out and nailed to the walls. *Turnips*, keep them thinned out and watered when needful.

FLOWER GARDEN.

Let order and neatness prevail here. Be most diligent in attention to small things, remembering that much depends on the minute details being well looked after. In most places there are vistas, which show some object in the distance, or openings through which glimpses of the surrounding country can be obtained; such are at this season of the year easily obstructed by luxuriant branches; therefore, attention should be paid to the regulation of these, not by an indiscriminate and formal topping, but by skilful manipulations, that Nature may be predominant in the scene. See that a goodly number of Pansies are put in. Ranunculuses, Tulips, Hyacinths, &c., should now be taken up, and after they are dried stored away in some dry room. Get the beds prepared as speedily as possible.

FRUIT GARDEN.

Strawberries will now require timely applications of water according to the state of the weather, and the fruit must be protected from birds. The nailing-in of the young wood of wall trees must be continually followed up. The breastwood of Pears should now be broken off within a few joints of the base, carefully retaining the leaves. Now is the best time to thin out the young canes of Raspberries. Pinch out the tops of the young shoots of Figs, and thin the fruit if too thick. As soon as the Grapes on the open walls are set they should be well thinned, it amply repays the extra trouble.

GREENHOUSE AND CONSERVATORY.

Many of the popular beauties here being at this period of a somewhat ephemeral character, means must be constantly

resorted to in order to insure a continual succession of gaiety until the frost sets in, when the gap will be filled by Chinese Chrysanthemums, the Camellia, the Chinese Primrose, and several other midwinter flowers. The latter, of course, constitute a division of business by themselves, and lead the way to the forced flowers of returning spring. Those who keep a sharp eye on such matters will always take care to have a surplus stock on hand after the massing is completed. Such stock should be most ample—not less but more than is wanted, in order to provide against gaps in the flower garden, and to supply the various in-door demands. Everything remaining in store-pots of the spring propagation should be potted-off forthwith, and placed on or plunged in ashes in a sheltered spot—sheltered I mean from the winds. Balsams, Cockscombs, and other tender annuals for succession should receive their last shift before they become potbound; and plenty of the Achimenes family should be potted-off, some in large masses. A lot of the best scarlet Pelargoniums should be selected for flowering next winter. These should be grown rapidly and frequently stopped. Towards August they will become rather potbound; they must not, however, be shifted, but merely hardened in a very exposed situation until the end of September, in order to get them sturdy and very short-jointed. A light and warm shelf near the glass will thus make them objects of great interest all the ensuing winter. Many of the Chinese Azaleas, indeed most of them, are now quite out of bloom. Place them, as formerly directed, in a close place, and promote their growth by all possible means. Those that require shifting should have it without delay. The foliage of Azaleas frequently drops off for want of moisture at this season; syringe them in the afternoons. Remove all the young plants of Heaths into pits or frames: if they face the north they will want but little shading. Place the plants on the bottom of coal ashes, and supply them liberally with water. As many of the specimens which flower freely are apt to go off without giving warning, pay particular attention in watering that the ball is quite moist through. This tribe of plants suffers more at this season for want of an abundant supply of water than from all other causes combined. Many of them from long confinement under glass, succeeded by hot and dry weather, suffer extensively from mildew. When this is perceived sulphur the wall, and place them in the open air under a wall, or, better, behind a hedge in a north aspect. In a few days the sulphur may be syringed off, first laying the pot on its side, and then plying the syringe in all directions.

STOVE.

This will now be a good time to increase many of the valuable sorts of stove plants, they being now in a free-growing state; take off short and rather firm shoots, plant them in sand in bottom heat under a hand-glass, and most of them will root in a few days. Frequent syringings, accompanied with moist floors and other surfaces, will be needful with the ordinary stock. With regard to Orchids some little moderation is necessary, especially when the weather takes a sudden change from a sunny to a cloudy condition. Some of the Orchids will now require a little assistance in the way of topping-up, and a watchful eye must be kept as to insects.

PITS AND FRAMES.

Hardwooded plants in these structures will now enjoy a more moderate temperature than they possibly could obtain in houses, especially in pits turned to the north, which will prove a good place for some of the tribes in very hot weather. Let regular waterings be applied. W. KEANE.

DOINGS OF THE LAST WEEK.

KITCHEN GARDEN.

THANKS to the compositors and printers who read so well our rambling notes, written at this season in great haste, that there are so few errors needing future correction. The transposition of a single word, page 422, near the bottom of the first column, has brought us several letters, some of inquiry, others full of bantering rillery which we can enjoy as well as anybody in its right place. The expression as printed is, "Planted out Beet, some under glass." The word "some" should be "sown," and that will clear up all

the mystery. The Beet planted separately 6 inches apart in the row and 12 inches from row to row, is doing well. It is the Pine-Apple kind; if a larger sort we would have given more room. Huge Beet is very well at a show, but we find most cooks and butlers prefer it when not more than from 1½ to 1¾ inch in diameter. Before our last notice was read, we had gathered nice Broad Beans, and now our supply consists of these Broad Beans, Peas, Dwarf Kidney Beans, Mushrooms, Potatoes, Cauliflowers, Spinach, Turnips, Onions, Cabbage, &c.

The chief work in the kitchen garden has been staking Peas and Scarlet Runners, sowing successions of Turnips, Lettuces, Cauliflower, &c., watering Cauliflower, and after forking and hoeing by the sides of rows of Cauliflower and Peas, covering over the ground with short grass to keep the moisture in, and watering wherever we could spare the liquid, and where the appearance of the leaves under a bright sun told that a watering would be desirable. This summer watering will always be reduced to the lowest minimum if deep stirring before planting or sowing, and surface-stirring afterwards, are attended to. In fact, the scuffling the surface with a hoe is just the next best thing for keeping moisture in, to covering the surface with mats, litter, or short grass. We object a little to the latter, because after a shower or two it becomes as close and nearly as impervious to air as a covering of stout felt; and a heavy shower instead of going regularly through it, is apt to run along it as if on a duck's back until it finds an opening to get through. Most advantages have some little disadvantage. The advantage of thus surfacing the ground where crops are growing, and there is but little water to give them, is no slight one, and the disadvantage may be easily counter-balanced by forking over the surface-covering or mulching.

We have had some fine refreshing thunder showers during the week, a great help to luxuriant vegetables like Peas, Cauliflowers, and such fruits as Strawberries; but still there was a necessity for watering many things, as on pulling up the stumps of cut Cauliflowers we found the roots dry. These little matters just become the mileposts, as it were, to our journey of action. The thoughtful man notices, and draws his practical inference. The haphazard man notices too, but draws no practical inference. We were long ago somewhat staggered at noticing that when fine early Celery had bolted, the roots and the soil about it were almost as dry as they could be, without being roasted over a fire. This led us to think of the natural habits of the Celery, and to a course of culture by which the roots would not get dried up, and which prevented the throwing-up of the flower-stem. For years we have scarcely had a single run head of early Celery. The simple plan has frequently been referred to, it chiefly consists in securing moisture at the roots to fully compensate for evaporation from the large foliage.

WATERING.

The whole question of watering is, as yet, but dimly understood, and many a painful is put on that is much worse than wasted material and wasted time. Our friend, Mr. Robson, hit one nail right on the head last week, when in speaking about late Peas, he advised watering them in dull weather when rain was falling, or expected to fall. He knew right well, that if water was put on in a bright, hot, sunny day, a good part would soon pass into the atmosphere again, at the expense, too, of greatly cooling the ground round the roots, for evaporation of moisture always cools the body from which the vapour comes. After some of the showers lately, the vapour visibly rose from the ground, reminding us of the steam from the boilers in a wash-house.

We have many times been next to sneered at by would-be-wise people, but who in reality have not enough of wisdom to know that they are very ignorant, because we have been at the water-cart in a dull day, or even when a little rain was falling. We gave a good drop of sewage water to our Cauliflower and some Strawberries, before the thunder showers came, and we find that even yet we have not enough to swell-off the heavy crops. The plants received the full benefit of such a watering because it permeated the ground round the roots, instead of being raised by bright sun at once into the atmosphere. In such a dull or drizzling day, too, the ground is not cooled by evaporation as wet ground is cooled by a fierce sun. In the one case the

ground resembles a bottle of wine brought out of a good cellar, and which is right as to temperature to unsophisticated tastes. In the other case, the ground resembles a bottle of wine with a worsted stocking drawn over it, set in the sun, and the stocking kept moist. Continue the process and you may almost freeze the wine. Experiments with thermometers in the ground showed much the same results, so that the practice of watering on a dull day is not so much deduced from theory, as the theory itself is based on practical experiment, and that is the only theory worth talking about.

We have also had the laugh raised against us for watering on a hot sunny day, and we confess in this case with much more force, more especially when the critics could see the watering, but might not know that our getting the water might wholly depend on having it then or not having it at all. We would water a plant at any time and at any hour rather than allow it to die for the want of it; and when forced to anything like a general watering in a hot sunny day, we would take the precautions that the roots should have as much of the moisture and the air as little of it as possible. For this purpose we would stir the surface-soil about the plant that the liquid might enter freely; and then as soon as convenient stir it again, and cause some of the dry soil to cover the moist, so as to arrest evaporation and the coldness produced by it. Thus done there is not so much wrong in watering in a warm sunny day, but the labour in doing it properly and so as to make the best use of the water is increased.

It may be well to add two or three notes as to watering. First, as to the things that chiefly need watering in gardens. We have frequently alluded to the mode of watering tender plants and things in pots; here we confine ourselves to things tolerably hardy and growing in the open garden. And the first line of demarcation we draw is this, that watering is chiefly needed for all things that are planted out. Most crops that are sown are injured oftener than they are benefited by continuous drizzling waterings. Who would think of watering a Wheat field in a warm summer? Many a watering is given to Onion and Carrot beds in cottage gardens to the injury of the crop. Knowing this well, and being short of water, we would sow Cauliflower, Lettuces, &c., in their places at once; but as we are also short of ground we generally transplant, and thus need repeated waterings. Deep-stirred good ground will generally bring to perfection any annual crop without much help from the water-pail. It is true we frequently help our Peas a little; but they would need less if, in addition to good culture, we did not less or more rob and stifle them with necessary crops between them. For instance: we are now mulching the Peas with strong Spinach beginning to run, but that Spinach so far robbed the Peas and deprived them of a due amount of air. With plenty of room, deep stirring, and sufficient moisture to the seeds and soil when sown, we may rest pretty well independent of the water-pail. When we exhaust the ground by severe cropping we must then keep up the balance by watering. It is true there is a great difference in this respect as to soils heavy and light; but the first we can keep open, and the second we can compress, and still keep the moisture in by a loose surface frequently stirred.

Then, second, as to the mode, when watering is wanted. Here there is only one great rule for plants in general—*Give enough of water to reach every root, and give no more watering until it is required.* The continuous drizzle system ruins thousands of pot plants, and is just as injurious if persevered in to vegetables and flower-beds. A good soaking when wanted, and stirring the surface afterwards to keep the moisture in, or at least to render evaporation of moisture very gradual, would be worth a score of these continuous every-day or every-evening shower-baths. Of course we make an exception as respects newly-planted things where the mere refreshing of the foliage will often be of more importance than deluging the soil with water. Of that we shall speak presently. We are now treating of plants that would be the better of watering, and the mode of administering it; and we want to save the labour, and the disappointment too, of many of our amateur friends by telling them candidly that much of their frequent sprinkling overhead of the culinary and flower plants in their beds is worse than labour thrown away. We

have frequently noticed plants taken from the same place and planted under similar circumstances, and in one case they would be as thriving as thriving could be, and in the other case they would be miserable-looking, the crust of the earth being pretty well as hard as pavement, and produced by the great labour of almost continuous surface-waterings.

Let us try in a word to explain the cause. Sow a seed or get a plant established in well-stirred soil, and however dry the surface, the more powerful the sun the greater will be the amount of moisture raised from thousands of yards beneath the roots of the plants, the roots having the benefit of that moisture as it passes them and is discharged into the atmosphere to form part of the future showers that will refresh the earth, and which will generally come in dull weather. This would form one reason against frequent indiscriminate rose-sprinklings as being so far not called for; but they are not only useless for established plants, but they are worse than useless, because actually injurious, and from two causes. First, by mere surface-sprinklings surface rootlets are encouraged, which are burned up and withered as the surface moisture that encouraged them is dried up; and secondly, these surface-sprinklings confine the evaporation to the surface, and thus break the connecting link of the capillary action which would have brought moisture to the roots from greater depths. The sprinkling does not reach the body of the roots, and it stops the rising even of vapour from depths beneath them, so that the roots are deprived of moisture both from above and beneath, and they fall into much the same state as many a row of early-earthened Celery does when done after the general approved fashion, the stems running, and the earth about the roots being as dry as if it had been baked in an oven.

Thirdly, the watering of tender things turned out of doors must be regulated by other considerations so long as cold forms an element to be guarded against. Here one of the first elements of success is having the ground warm, and great drenchings, unless with water considerably heated, and the surface stirred and rendered dry, will ever cool the soil by evaporation. In such cases the less water the plants have at the roots, so long as they have enough to keep them growing, the better will it be for them, and the faster they will grow. We have seen bedding plants flooded at an early period, which we should not think of doing had we ever so much water at command. A very little at the roots, that had been well warmed by the sun's rays, would be better in such circumstances than a great quantity, because the greater the quantity the more the ground would be cooled by evaporation. Hence a cold rain in the end of May, or the beginning of June, in such circumstances is only a little better than a severe frost, and is to be guarded against accordingly. Hence, also, when plants are damp enough at the roots, and yet the leaves flag under a powerful sun, it is often better to moisten the foliage by a slight sprinkling to arrest evaporation, instead of deluging the roots or soaking the surface soil. Even if the sun shines this sprinkling of the foliage will do no harm, and it wonderfully refreshes the foliage, and is quite a different thing from watering the surface of the ground. The little that may fall on the surface of the ground from such a damping of the foliage is quickly raised about the plants in the shape of a refreshing vapour, a very different effect being produced from what takes place when a bed is sprinkled over regularly from one-eighth to half an inch deep. We know that frequently more good is done in this way by a few pailfuls of water from a syringe or garden engine, than from many given at the roots when they cannot appropriate it. In such cases of transplanting, or potting, sudden changes from dull to bright days demand more in the way of evaporation from the foliage than the roots, though moist enough, can at once supply; and the arresting or modifying of the evaporation, either by sprinkling the foliage, or, better still, where practicable, shading for a time, gives the plants a better chance, in all respects, than deluging the roots with cold water.

FRUIT GARDEN.

Here let us note, that the word "trees" in the third line from the bottom of the second column, page 439, should be "Strawberries." All will then be clear, and the short grass between them will appear appropriate. In general, we prefer litter or straw to this grass, but we wished to save a second

wheeling. The grass used was not very short, and did better on that account. When very short it is apt to stick to the Strawberries, and to become mouldy in wet weather. Clean straw, perhaps, is the best, but it costs something. For general purposes well-shaken litter from a stable answers admirably if put on *in time*, so that some showers may wash away all taint before the Strawberries ripen. Tan is good used in a similar way. Some mode should be employed to keep the fruit clean. Last year in a fine garden with plenty of litter at command, we noticed a nice dish of Strawberries drying, all of which had been carefully washed from earth before they could be sent to table. Were we a lady or gentleman, we would insist in addition to this care of keeping the fruit clean, that the Strawberries should be nipped over by the stalk with clean hands, the berry never touched, and the fruit sent to table in the basket in which they were gathered, or simply turned out at once on a plate, and sent without mauling them about by the fingers. We have seen many a beautiful artistically piled-up dish of Strawberries, and we know pretty well the process by which the piling is accomplished. Were we more partial to fruit than we are, we would sooner go without than partake of berries from such a dish. Slates and tiles close to the rows we have frequently used, chiefly for promoting earliness. In very hot weather the berries were apt to be scorched, or to get ripe on one side before the other was fully matured. When none of these modes are comestable for the cottager or the amateur, the fruit may be kept clean by stout little sticks being placed a yard apart on each side of the row, and a string run along them to keep the fruit-trusses up, or slightly bent over the string. If Strawberries are worth growing they are worth keeping free from grit. Who would eat them if they knew they had been covered with earth, and then washed in a pail before they were sent to table?

For some of the reasons stated, there is no wonder that fastidious persons would rather pick for themselves. This is one of the advantages that the cottager, the amateur, and the possessor of a small garden may ever possess. The proprietors of large gardens and their friends can scarcely use the same freedom, unless with the knowledge of, and in the places appointed by the gardener. The breaking of this rule has led to much unnecessary unpleasantness. The gardener wishes his best to go to table, but this is next to impossible, where anything like liberty hall, as to fruit, is the common practice among visitors and children. It will insensibly lower a felt responsibility in the case of the superintendent, and a feeling of honour and honesty among the assistants. When we once made a complaint on this subject there were some indignant statements, that they had never been interfered with in any garden before. In all such cases if the gardener said or looked nothing, we know pretty well what he thought. What sort of a managed house would it be, when each and every one could go at any time, and all times, to the larder, and cut and carve as they liked, or make as free during the day in the pantry with the wines and liquors intended for the dinner-table? Much the same effect would be produced in a large garden. Wherever there is responsibility, there must in the same ratio be the power to regulate and arrange, or responsibility will soon expire for want of sustenance.

ORNAMENTAL DEPARTMENT.

Among lots of work with beds, proceeded with finishing our walks farthest from the house in the pleasure grounds. These walks have not been broken for many years. Every year after cutting the edges they get a good sweep, chiefly to remove any dark fine incrustation from the surface. We then sprinkle them slightly over with salt, throw on a slight sprinkling of fine siftings from gravel, pull the back of a rake over it firmly, and roll it down. This rolling prevents the smaller particles being washed down in a heavy rain, so as to leave a rough surface. It also secures the salt from being washed away. It becomes blended with the old surface and the new sprinkling after the first rain. The walks are swept over with a light broom, which causes the slight sprinkling of siftings to be placed more regularly, so as to give the whole a fresh appearance. The roller follows the broom, and the walks then are generally firm and smooth for the season. We know of no other plan so economical. —R. F.

COVENT GARDEN MARKET.—JUNE 18.

The supply is heavy, quality good, prices moderate, and trade brisk. Imports from abroad are kept up, and now include Brussels and Moorpark Apricots, and Plums. Peaches, Nectarines, and hothouse Grapes, are sufficient for the demand; Strawberries plentiful and good.

FRUIT.

	s.	d.	s.	d.		s.	d.	s.	d.
Apples.....	1/2	0	10	0	Melons.....	4	0	10	0
Apricots.....	1	0	3	0	Nectarines.....	10	0	20	0
Cherries.....	1	0	2	0	Oranges.....	100	10	36	0
Figs.....	12	0	20	0	Peaches.....	18	0	16	0
Filberts & Nuts 100 lbs.	0	0	0	0	Pears.....	0	0	0	0
Gooseb. Green 1/2 sieve	2	0	4	0	dessert.....	0	0	0	0
Grapes, Hothouse.....	6	0	10	0	Pine Apples.....	6	0	10	0
Muscats.....	8	0	14	0	Strawberries.....	0	6	1	6
Lemons.....	100	4	0	10	Walnuts.....	14	0	20	0

VEGETABLES.

	s.	d.	s.	d.		s.	d.	s.	d.
Asparagus.....	3	0	10	0	Lettuce.....	0	9	10	3
Beans Broad.....	3	0	0	0	Mushrooms.....	1	0	2	0
Kidney.....	2	0	0	0	Must. & Cress, punnet	0	2	0	4
Beet, Red.....	1	0	3	0	Onions.....	7	0	12	0
Broccoli.....	0	0	0	0	pickling.....	0	6	0	8
Cabbage.....	0	9	1	6	Parsley.....	1	0	2	0
Carrots.....	0	6	0	8	Parsnips.....	0	9	1	6
New.....	0	9	1	6	Peas.....	0	6	1	6
Cauliflower.....	4	0	6	0	Potatoes.....	8	0	12	0
Celery.....	1	6	2	0	New.....	0	4	0	8
Cucumbers.....	0	6	1	0	Radishes doz. bunches	0	6	0	9
Endive.....	1	3	2	6	Turnip.....	0	6	1	0
Fennel.....	0	3	0	0	Rhubarb.....	0	4	0	6
Garlic and Shallots, 1h.	0	8	0	0	Sea-kale.....	0	0	0	0
Herbs.....	0	3	0	0	Spinach.....	1	0	2	0
Horseradish.....	1	6	4	0	Turnips.....	0	6	0	9
Leeks.....	0	4	0	6					

TRADE CATALOGUES RECEIVED.

Cutbush & Son, Highgate.—General Catalogue for 1864-5.
F. & A. Smith, Dulwich.—Catalogue of New and Rare Plants.

TO CORRESPONDENTS.

We request that no one will write privately to the departmental writers of the "Journal of Horticulture, Cottage Gardener, and Country Gentleman." By so doing they are subjected to unjustifiable trouble and expense. All communications should therefore be addressed solely to *The Editors of the Journal of Horticulture, &c.*, 171, Fleet Street, London, E.C.

We also request that correspondents will not mix up on the same sheet questions relating to Gardening and those on Poultry and Bee subjects, if they expect to get them answered promptly and conveniently, but write them on separate communications. Also never to send more than two or three questions at once.

N.B.—Many questions must remain unanswered until next week.

CALCEOLARIAS (Worcestershire).—The flowers were all shrivelled. They seem of average size and quality—the larger and more globular they can be obtained the better. If excellent in other qualities that with flowers 4 1/2 inches round must be very good.

DESTROYING RED SPIDER (T. G.).—Your solution of gum seems to be efficacious, and, as you say, "The spiders and eggs are fast in the stocks," and if, as you also state, the film of paste peels off in a few days, bringing with it both the eggs and insects, at a cost of not more than a farthing for each tree, we think it a valuable remedy. Dr. Hogg's "Fruit Manual" can be had free by post from our office for 3s. 8d. in postage stamps.

IMPORTATION OF FRUIT TREES (Moorpark).—There is no duty on trees imported from France. We cannot tell what the cost per cwt. would be from Angers to London.

DISEASE ON GLOXINIAS, &c. (J. N.).—The gangrene is probably caused by the plants being exposed to too much moisture, with too little air and too little warmth.

PRIMULAS (B. H.).—We think there is but little difference in the strain of seed possessed by our best growers, and you would be safe in obtaining it from any of the eminent florists who advertise in our columns.

TABLE DECORATIONS AT THE ROYAL HORTICULTURAL SOCIETY'S SNOW (A Regular Subscriber).—I only noticed those table decorations which had been noticed by the Judges, it being—unless there is something peculiarly remarkable—hardly possible, in a limited time, and with a knowledge that a limited space is at your disposal, to do more. I did see the stands to which allusion is made, but I cannot say that they struck me as being in good taste: the ice especially seemed to me a departure from that purity of design which should characterize such objects. My taste is, perhaps, a severe one; but additions of this kind, of whatever composed, seem to me unpleasing. I would not call such a taste vulgar, but I would call it incorrect. It seemed to me on a par with the white lace of Lady Emily Peel's. Tastes differ materially; but mine, in this respect, was borne out by the fair Judges, whose remarks on the subject are not unworthy of consideration by all who wish to compete in this field.—D., Deal.

CUCUMBERS SHRIVELLING-UP (B.).—You would see an answer in last week's Number on the same subject. Too much heat at the roots, want of heat at the roots, want of air, and hungry poor soil, will produce the result; but you seem to have attended to all that. We would say, Lower the night temperature, with air, to 60° and 65°, and give more air during the day. We think very likely the roots have got into the hot dung—if so, pour down some cold water through holes made in the bed.

VINE LEAVES INJURED (Z. G.).—We found three live red spiders, but they were white, because not old enough to be red. We also found lots of their webs, and, though not sure, we think there were marks where trips had been. On the point of the small shoot we think there were also traces of mildew. The Grapes colouring is against you. We would proceed thus:—On every open part of the wall of the house we would paint with flowers of sulphur and lime, when the heating medium was cold, if hot-water pipes, all over; if a flue, commencing at 5 or 6 feet from the furnace. We would paint them over with flowers of sulphur, and use a good fire at night, with a close house, taking care, however, that the sulphur is not heated above 160° or 170° at the very most. If this does not start or settle the pests, along with plenty of moisture in the house, and reduced air during the day, you will have no remedy except carefully sponging or brushing the back of the leaves with soap water, or size water, neither of them at all strong.

LARDIZABALA AND RHYNCOSPERMUM (M. A.).—The *Lardizabala bitemata* is an evergreen creeper from Chili, that flourishes pretty well against a wall, but requires strength and age before it produces finely its racemes of purple flowers. The *Rhyncospermum jasmimoides* requires a little more heat, when making and ripening its wood, than a cool conservatory, where little heat is given. As your plant has lived three years, we think you will succeed in getting it to produce its sweet blossoms, if you encourage growth in the first part of the summer, and give all the sun and air possible in the autumn, and no more water than will keep the leaves from flagging. Next spring you will most likely be rewarded with blooming shoots from the well-ripened buds. The *Ceanothus dentatus* is a pretty compact shrub; but for elegance and beauty none can bear the honours from azureus. It is more tender than *dentatus*.

STRAWBERRIES (E. S.).—You are forward with Strawberries, getting them out of doors on the 20th of May. We could do no more than barely keep up, in this exposed part of Hertfordshire, on this the 17th of June, though plenty are swelling fast. We had not a good dish of the Black Prince sooner than a week since. Sir Harry is a good force; it yields larger fruit but not so many of them as Keens' Seedling. We do not think it quite so good in flavour as Keens', but it is firmer, and packs better for a journey. It may be considered an extra large kind of Keens'.

ELEVATING MELONS ABOVE THE SOIL (J. R. P.).—Most likely there will be something about Melon culture in "Doings of the Last Week." Meanwhile we reply to your questions. First, we disapprove of elevating the fruit of Melons on flower-pots—that is, above the foliage—because it is so far contrary to nature. We like to rest them on a tile or a reversed flower-pot saucer, to guard them from the damp soil of which you speak; but that is a different affair. Secondly, we have no faith in your theory that the higher the fruit is placed above the bine, the greater the amount of sap attracted towards it. We hold an opinion nearly the reverse. The analogy you trace between the best bunches of Grapes at the top of a Vine, and these elevated Melons, would only afford comparison if the bunches at the end of the Vines farthest from the roots were elevated above the foliage close to the glass, instead of hanging beneath the leaves. On the other hand, we believe that Melons swell faster if suspended beneath the foliage.

WEEDY LAWN (Subscriber Wellknow).—We have no remedy except picking the weeds up by the roots. This is best done in autumn or early spring. The roots do not run deep. It is of no use cutting them, as every fleshy piece left will grow. During summer the leaves of this kind of Plantain are but little seen. Anything that would kill them would kill the grass; and any that are accidentally cut might have a pinch of salt carefully dropped on the cut part, and that will destroy them; but carefully rooting-out is the only effectual remedy.

HEATING GREENHOUSE AND BATH-ROOM (A Young Gardener, Rochdale).—Neither of the plans you propose will answer. The descending so much below the boiler as the moving power is fatal, otherwise either plan would do. We can only suggest two modes—the first, to carry the pipes across the back garden, in an elevated trough 6 feet from the ground, supported by pillars, which may be made ornamental by creepers; or, secondly, to sink the boiler 5 feet 2 inches, or say 6 feet, as then the boiler would be lower than the pipes, under the soil in the back garden. Either plan will do; and you may heat separately, or from the cistern in the bath-room.

NUMBER OF PEACHES A TREE CAN MATURE (H. P. D.).—We have found that one Peach to every square foot of surface of wall or trellis covered by the tree, is a sufficient crop if the tree be expected to yield a crop annually. When more are taken it is at the expense of the future prosperity of the tree; and though a young vigorous tree may produce for a few years double the quantity named, yet such will cause in the tree an early "old age," and a tendency to produce fruit which is small and poor because there is not strength in the tree, but an impaired over-taxed constitution. According to the rule of one fruit to a square foot, you have fifty fruit too many on your Peach tree; but as your tree is young and healthy we would not further thin them, unless you like to try a nice little experiment, which is to thin one half or side of the tree to one fruit to every square foot, leaving the other side of the tree as it is, and when they ripen weigh the fruit from one side and also that from the other, making entries of the same, comparing the appearance and flavour of the fruit, and you will have solved a problem for yourself, and done what no other person has done—at least he have he has kept it to himself. We will thank you for the results if you try this simple experiment, and also for notes of how that half the tree fares in future, presuming you pursue the same treatment with it for a series of years, pruning and otherwise treating it the same as the other, except as to the quantity of fruit allowed to remain upon it—that is, one fruit to every square foot, leaving as many as you think proper on the other side. Presuming your Nectarine tree to be the same size, you have again too many upon it, as upon the Peach, by some fifty fruit, three Nectarines to two square feet being the proper quantity to allow. The same applies to the Apricot. Fruit of all kinds is better thinned; and you will find that if you reduce your Gooseberries, Currants, &c., to half their number, you will obtain much finer flavoured, more pulpy, and consequently, better and heavier fruit.

HEATING BY DUNG (*Amaranthus*).—A pit is the usual and best mode of applying the heat so obtained. If you send seven penny postage stamps to our office, with your direction, and order "Heating," by Mr. Fish, a manual will be sent you free by post, which contains plans and directions for making such pits.

VINERY (*A Subscriber*).—We see nothing wrong with your plan; and as it is intended to force the Vines your border could not be better than inside the house. It is much better to have the roots inside than in an outside border. Your proposed mode of training one Vine up and another down, and planting them in the centre of the house, is the same as that recommended by Sanders in his book on the Vine, and no doubt will enable you to obtain speedier results, or a full crop in a shorter time than if the Vines were planted in front, and you had only one instead of two Vines to depend upon; otherwise we prefer planting the Vines in front and training only one Vine up each rafter. By all means have one horse solely devoted to Maseats, as your results will be much more satisfactory than if they were grown along with harrier kinds. Your other arrangements are good.

AMERICAN BLIGHT (*H. J. B.*).—A mixture of equal parts linseed oil and spirit of turpentine, worked thoroughly with a brush into the patches where these insects appear on the Apple trees, will vanquish them if persisted with.

FLAVOUR OF FRUIT UNDER GLASS (*An Amateur*).—They will make themselves intelligible.

HOUSE SEWAGE (*Bert*).—As it is solely excrementitious it should be mixed with at least seven measures of water to one measure of the sewage. For Cabbages and other large-leaved kitchen-garden crops four measures to one would be enough.

BOTANICAL WORK (*A Young Gardener*).—Hogg's "Vegetable Kingdom" will suit you. It can be had free by post from our office for 5s. 8d. The caterpillars probably had gone into the earth to change to the chrysalis state.

NAME OF LETTUCE (*M.*).—It is the White Cabbage Lettuce.

NAMES OF PLANTS (*A Lady Subscriber*).—1, *Pteris tremula*; 2, *Asplenium bulbiferum*; 3, *Pteris longifolia*. (*W. Sutton*).—*Polystichum capense*. *Lactaria opaea*, we think, was sent out either in 1863 or at the close of 1862. (*E. Bell*).—*Habrohamnus fasciculatus*. (*John W. Boyd*).—1, *Atyrium Filix-femina*; 2, *Lactaria dilatata collina*; 3, *Doodia media*.

POULTRY, BEE, and HOUSEHOLD CHRONICLE.

DORKING CHICKENS DYING.

How true the saying, "We cannot all do all things!" I hope I am not so proud as to fancy myself capable of doing everything; but I did flatter myself I could rear poultry. This year, however, I have had a pretty good lesson to the contrary, my inability showing itself, not in the matter of bringing poultry to perfection, but of simply keeping Dorking chickens alive. Having been usually very successful in raising poultry, and being a great admirer of the Dorking fowl (let his friends write him up, as rearers of other poultry seem to me to try to depreciate the Dorking breed; I can say there is none to compare to it). At the last Birmingham Show I bought a handsome Dorking cock to change and improve my breed. When the spring of this year came, and my hens were sitting, I was, of course, full of hope. The chickens of my new bird were to do wonders, and win half the prizes in England. Well, my first hatch took place on the 8th of March, and a good one for the time of year. Nice early birds these, thought I to myself. How well they will look at the Birmingham Show with first prize over their heads. (And mind you I am not a novice.) What care was taken of them I will leave my readers to imagine. What hopes they raised I will not venture to express. However, these hopes were all doomed to be disappointed. The chickens and all succeeding broods did well, very well, until they were about ten days or a fortnight old; they then ceased growing, wings drooped, their piteous chirp began, and in a few days they were all dead. Since that first hatch fifty-three chickens, save four, have gone the way of their brothers, and after all my care and trouble I have only, as I said, four chickens alive, and these small and poor for their age. I have tried every means I could think of for saving their lives, have put their coops on gravel, on earth, on boards, on stones, have moved them well away from the other poultry, and fed them on bread, rice, potatoes, barleymeal, and wheat, but all to no purpose, die they determined to, and a die they made of it. Can you, or any of the many readers of your Journal, tell me what to do in order to stop the plague, for so I call it?

The ground, I daresay, I shall be advised is tainted; if so, what is the remedy? My poultry have a boundless range, and can go for miles if they so please, still they are very fond of hanging about home and seeing what scraps may be picked up. Last year I killed ninety odd of fowls and Ducks, buying the Ducks' eggs, and sitting my own eggs from nine hens, so that you see I am not a new, nor altogether un-

skilful rearer of poultry, especially of the Dorking fowl; at least, in years past.—A. K. C.

[Very many of our readers will sympathise with this correspondent, and some of them we hope will send us the results of their experience. Even the details of failures will be acceptable, for they are instructive warnings.]

BATH AND WEST OF ENGLAND AGRICULTURAL SOCIETY'S POULTRY EXHIBITION.

THE Bath and West of England Society's has now for a number of years in succession ranked among the first of our out-of-door poultry exhibitions, and it gives us great pleasure to announce to those of our readers who were unable to attend last week's Meeting, that not only did the entries on that occasion exceed those of last year by at least fifty pens, but also that the quality of both the poultry and Pigeons was fully sustained.

The arrangements, under two large tents, of this extensive Show were so perfect as to well merit the good opinions of all those who take an interest in such meetings, and to encourage our first-class breeders to consign with increased confidence their best specimens in years to come. The fact was, that everything that could be done was done to render effective and successful the poultry division of the Bath and West of England Society's Show. For several days preceding that announced for the opening of this Exhibition to public view the weather proved most unpromising, the rain falling in almost continuous showers, and the barometer being gravely watched by many in anxious hope to herald to other friends equally anxious the first signs of amendment, and up to quite late on Sunday evening all parties evidently hoped against conviction. Happily, however, better luck was in store than anticipated. The early morn of the opening day, Monday, was as bright and clear as the most ardent well-wisher could desire, a brilliant sunshine ensued, and faces gloomy enough the previous evening now bespoke only confidence and pleasure. The grounds selected by the Committee, on Clifton Downs, were of that character that not a symptom of the previous heavy rains was visible, the site is one of the most picturesque character, and everything passed off most satisfactorily. Under so happy and so unexpected a change we believe the Show of this year will have been the most numerously attended of any attached to this long-established Society. A principal reason of the public interest always excited among poultry-breeders by the Meeting of the Bath and West of England Poultry Show, is the liberal prizes offered by the Society, and, perhaps, even still more so, as at this Show the custom is to exhibit for the first time the early products of our principal poultry-yards. At this Meeting, consequently, breeders anxiously look forward to the amount of competition they are likely to have to contend with throughout the season, and really good and early chickens exhibited under the protection of only moderate prices rarely return unsold, thus rendering them not only remunerative to those parties who originally bred them, but as frequently a legitimate source of abundant profit to those who made this early investment.

We naturally expected a first-rate display of *Spanish* fowls, and were not disappointed. The old birds were well shown considering the time of year; but it was the chickens of this variety that formed one of the most commendable features of the whole Show. Five most excellent and early pens of chickens constituted this class, and not a single pen among them passed without high commendation.

The *Dorkings*, whether Coloured or White, were first-rate ones, Viscountess Holmesdale exhibiting strongly from her ladyship's renowned stock of Coloured most successfully, not only taking most of the principal general prizes, but, also, having the silver cup for the best cock of any variety in the single sweepstakes cock classes, awarded to the grand old rosey-combed Grey that took premier position at Birmingham last season. If it so happens that this gigantic specimen moults kindly, and appearances favour strongly the supposition, the coming season will, doubtless, add many more to his already long list of triumphs. We must in justice speak in terms of the highest approval of the display of White Dorkings, particularly the chickens. We cannot advise too strongly, however, to breeders the necessity of

paying a little more attention to avoiding irregular and deformed combs.

Cochins were excellent, both old and young ones, the Partridge-coloured especially so; and here a long familiar name again turns up successfully—the Rev. G. F. Hodson exhibiting specimens of so great merit that competition was confined to very narrow limits. White *Cochins* were also numerous and unusually good, and reference to the appended prize list will convince our readers that the competition here was all that could be desired.

To most visitors the *Game* classes have unusual attractions, and certainly it appears as though Mr. Fletcher of Stone-cloth had studiously reserved all his forces to insure a triumph on this occasion, for to recount this gentleman's successes is very closely to reproduce the prize list itself so far as the *Game* classes are concerned, we consequently must refer our readers to the list for information on this head. It must not be supposed that the classes were small, or that first-rate birds were rarities, the reverse being evident even at a glance; but the great secret of success in these classes of Mr. Fletcher's yard is the wonderful condition in which his pens are invariably sent to the show-yard. We much question whether any *Game*-exhibitor ever before took so wholesale an amount of prizes at once as did this gentleman on this occasion.

Hamburgs of every variety, and *Polands* also, were exceedingly well shown, but space prevents our entering into peculiarities.

It is long since so good an Any-other-variety class came before the public, and a most varied one it also proved to be.

The *Brahmas* here had their only opening, and for both quality and numbers they would alone have formed a very heavy class. It occurred to many that it would be prudent in future years to substitute a *Brahma* class in the lieu of the present one for *Malays*, of which there were but three entries. Many other excellent breeds were also shown in this extra class; but we were sorry to find deception resorted to by an exhibitor of White Spanish, the consequence being a disqualified card, stating, as a reason, "The cock's tail made up." This general reparation of the cock's tail was ingeniously conceived, but manipulated in a bungling manner. The annoyance on discovery, and consequent public exposure, should be entertained in all its bearings prior to running so great a risk, and certainly the guilty ones when discovered have only themselves to blame for their most unenviable position.

We must now draw a very brief attention to the Cup pen of Grey *Game Bantams*, birds of extraordinary merit, and also to as good *Black Bantams* as could be well desired.

The more useful classes of *Turkeys*, *Geese*, and *Ducks*, were also first-rate throughout, and were evidently one of the most popular portions of this excellent show.

SPANISH.—First, J. R. Rodhard, Wrington. Second, Viscountess Holmesdale, Linton Park. Third, F. Crook, Forest Hill. Highly Commended, Mrs. Hargreaves, Reading; Mrs. Grenville, Glastonbury. Commended, R. Tovey, Highworth.

DORINGS (Coloured).—First and Third, Viscountess Holmesdale, Linton Park. Second, J. K. Fowler. Highly Commended, Mrs. Fookes, Blandford. Commended, C. Smith; P. Hillersdon.

DORINGS (White).—First, J. Clift, Surrey. Second and Third, Rev. G. F. Hodson. Highly Commended, T. P. Edwards, Haats. Commended, Mrs. Fookes, Blandford.

COCHIN-CHINA (Coloured).—First, Rev. G. F. Hodson. Second, C. T. Bishop, Nottingham. Third, H. Yardley, Birmingham. Highly Commended, J. Stephens, Walsall; W. Bowly; Mrs. Fookes; T. Stretch, Lancashire. Commended, J. K. Fowler, Aylesbury.

COCHIN-CHINA (White).—First, Mrs. Hargreaves, Reading. Second, R. Chase, Third, G. Lamb, Wolverhampton. Highly Commended, F. W. Zurhorst, Dublin; W. Dawson, Yorkshire.

GAME (White and Piles).—First and Third, J. Fletcher, Manchester. Second, S. Matthew. Commended, Rev. G. S. Cruwys, Tiverton.

GAME (Black-breasted and other Reds).—First, and Cup, and Second, J. Fletcher, Manchester. Third, H. Adney, Devon. Highly Commended, H. Beldon; J. B. Chnuce. Commended, R. Cozens; T. Burgess, Salop.

GAME (Duckwings and other Greys and Blues).—First, J. Fletcher. Second, J. B. Chnuce, Coalbrookdale. Third, M. Billing. Highly Commended, W. T. Everard, Leicester; R. Goodwyn; S. Matthew.

MALAYS.—First and Third, J. J. Fox, Devizes. Second, Rev. A. G. Brooke, Salop.

HAMBURG (Golden-pencilled).—First, H. Beldon, Yorkshire. Second, T. H. Ashton, Tamworth. Third, J. E. Powers. Highly Commended, Rev. R. Roy, Worcester. Commended, H. Pickles, jun.

HAMBURG (Silver-pencilled).—First, E. Yardley, Sheffield. Second, Viscountess Holmesdale. Third, A. Nicholson, Sheffield. Highly Commended, H. Beldon.

HAMBURG (Golden-spangled).—First, T. Davies, Birmingham. Second, N. Marlor, Manchester. Third, H. Beldon, Yorkshire.

HAMBURG (Silver-spangled).—First, H. Beldon. Second, Rev. H.

Dudley, Gloucester. Third, T. Davies. Commended, G. Whitcombe; J. Logan, Mon.; C. Pease, Darlington.

POLANDS (Black with white crests).—First and Highly Commended, T. P. Edwards, Lyndhurst. Second, H. Beldon, Yorkshire.

POLANDS (Gold and Silver).—First, H. Beldon. Second, C. Pease, Darlington. Highly Commended, J. Hinton, Bath.

ANY OTHER VARIETY.—First, J. Hinton, Bath. Second, P. P. Cother (Phasant Malays). Third, C. Pease, Darlington. Extra Third, R. H. Nicholas. Highly Commended, E. Pigeon, Devon (Brahmas); Mrs. Hargreaves (Brahmas); H. Beldon, Yorkshire; H. Lenorth, Barastaple; W. Dawson, Yorkshire. Commended, E. Pigeon; Mrs. Hargreaves, Reading.

SPANISH CHICKENS.—First, H. Lane, Bristol. Second, J. R. Rodhard, Wrington. Highly Commended, D. Parsley, Bristol; Rev. T. R. Brownrigg.

DORRING CHICKENS.—First, Rev. G. F. Hodson. Second, Miss Wilcox, Bristol. Highly Commended, Mrs. Grenville, Glastonbury.

GAME CHICKENS.—First, T. Everard, Leicester. Second, H. Adney, Devon. Commended, J. Fletcher, Manchester; W. J. Pope.

COCHIN-CHINA CHICKENS.—First, Rev. G. F. Hodson. Second, R. Chase, Birmingham. Highly Commended, M. Bowly, Worcester; Viscountess Holmesdale, Linton Park, Kent; G. Lamb, Wolverhampton. Commended, H. Bates, Birmingham.

SWEPESTAKES.

GAME.—First, J. Fletcher, Manchester. Second, S. Malthew, Stowmarket. Third, M. Billing, jun., Birmingham. Highly Commended, J. Fletcher; Rev. G. S. Cruwys; J. E. Rodhard, Wrington. Commended, J. B. Chnuce.

SPANISH.—First, Second, and Third, J. R. Rodhard, Wrington.

DORRING.—First and Silver Cup for the best cock of any variety in the sweepstakes for Single Cocks, Viscountess Holmesdale, Linton Park, Kent. Second, Rev. M. Amplett, Evesham. Third, H. Lingwood, Needham Market, Suffolk. Commended, C. Smith, Salisbury.

COCHIN-CHINA.—First and Highly Commended, J. Stephens, Walsall. Second, H. Bates, Birmingham. Third, J. K. Fowler, Aylesbury.

GAME BANTAMS.—First, H. Bates. Second, S. Lang, jun., Bristol. Third, Hon. F. Dutton, North Leach.

BANTAMS (Gold-laced).—First, Rev. G. F. Hodson. Second, Rev. G. S. Cruwys, Tiverton. Highly Commended, E. Jones, Clifton. Commended, Viscountess Holmesdale.

BANTAMS (Silver-laced).—First, Rev. G. S. Cruwys, Tiverton. Second, R. Chase, Birmingham. Highly Commended, E. Jones, Clifton.

BANTAMS (Black or White).—First, T. Davies. Second, Miss Charlton. Highly Commended, Rev. P. W. Storey, Daventry. Commended, Rev. G. S. Cruwys, Tiverton.

BANTAMS (Any variety).—First and Silver Cup for best pen of Bantams, W. S. Forrest, Kent. Second, Mrs. Pookes, Blandford. Highly Commended, J. Gray, Somerset. Commended, S. Lang, Bristol; E. Pigeon, Devon; Hon. F. Dutton.

DUCKS (Aylesbury).—First and Second, J. K. Fowler, Aylesbury.

DUCKS (Rouen).—First, Cup, Second, and Highly Commended, J. R. Rodhard, Wrington.

DUCKS (Any variety).—First, T. H. D. Bayley, Biggleswade. Second, J. K. Fowler.

GEESE.—First, J. K. Fowler. Second, J. Logan. Commended, Mrs. Herbert, Worcester.

TURKEYS.—First, J. K. Fowler, Aylesbury. Second, J. Edwards. Highly Commended, Miss Milward, Bristol. Commended, Mrs. Grenville, Glastonbury; Rev. J. Warren, Devon.

GUINEA FOWLS.—First, Miss S. H. Northcote, Exeter. Second, H. Adney, Devon.

Among the *Pigeon* amateurs every possible effort was strained to win the silver cup liberally offered by the Committee to the most successful winner of first and second *Pigeon* prizes, independent of the money awards. The very keenest competition we have seen for many years past ensued, scarcely a class being otherwise than a show in itself. Mr. Peter Eden, of Salford, was ultimately and most meritoriously, after careful deliberation, declared the successful one. This gentleman's birds were excellently shown, and many exhibitors of *Pigeons* seemed so thoroughly taken by surprise as to scarcely believe the evidence of even their own eyesight when examining the *Owls*, *Short-faced Tumblers*, *Almonds*, and several other varieties he exhibited. Mr. Stevens, of Barnstaple, was the nearest competitor with birds of extraordinary merit.

Our attention was attracted to a good deal of passing merriment going on among visitors at the tailpiece of the *Pigeon* show by the exhibition of a "*Pigeon fancier*," rather than a *Pigeon*, catalogued as a "*Wild Hawk*." It proved to be a *Buzzard*; and though its presence caused much attention among the visitors, its wild and untired efforts to be an absentee proved the pleasure of the thing was all on one side.

CARRIERS.—First, P. Eden, Salford. Second, J. Smith, Walsall. Highly Commended, F. G. Stevens, Barnstaple. (A very good class.)

ALMOND TUMBLERS.—First and second, P. Eden, Salford.

TUMBLERS (Any variety).—First and second, P. Eden, Salford. Highly Commended, H. Yardley, Birmingham. Commended, F. Else.

POWTRES (Variety).—First, E. Pigeon, Devon. Second, P. Eden. Highly Commended, F. G. Stevens, Barnstaple; R. Fulton, Deptford. (A very good class.)

RUNTS.—First, F. G. Stevens. Second, E. Pigeon.

JACOBS.—First, C. Bulpin, Bridgwater. Second, F. G. Stevens.

FANTAILS.—First, F. Else, Bayswater. Second, H. Yardley. Highly Commended, A. Pintoleite, Manchester; H. Yardley.

OWLS.—First and second, P. Eden. Highly Commended, F. G. Stevens, Barnstaple; H. Yardley. (A very good class.)

TRUMPETERS.—First and Second, F. G. Stevens, Barnstaple. Highly Commended, C. Bulbin, Bridgewater.

BARDS.—First and Highly Commended, F. G. Stevens. Second, P. Eden. **TURBITS**.—First, F. G. Stevens, Barnstaple. Second, H. Yardley, Birmingham. Highly Commended, E. Pigeon, Devon; F. Key, Yorkshire. (A very good class.)

NUVS.—First, F. Key, Beverley. Second, C. Bulbin. **DRAGONS**.—First, F. G. Stevens, Barnstaple. Second, H. Yardley, Birmingham. Highly Commended, F. G. Stevens; M. E. Jobling. **ARCHANGELS**.—First, H. Yardley, Birmingham. Second, F. G. Stevens. **ANY NEW AND DISTINCT VARIETY**.—First and Second, H. Yardley, Birmingham. Highly Commended, A. Heath. Commended, E. Pigeon; C. Bulbin. (A very good class.)

The Silver Cup for Pigeons to Mr. Eden, of Cross Lane, Salford.

Charles Ballance, Esq., of Mount Terrace, Taunton, and Edward Hewitt, Esq., of Sparkbrook, Birmingham, were the arbitrators of poultry; Harrison Weir, Esq., of Peckham, London, officiating among the Pigeons.

THORNE EXHIBITION OF POULTRY AND PIGEONS.

ALTHOUGH the simultaneous holding of the Bath and West of England Society's Show most probably was this year a drawback to the number of entries that were made for the Thorne Meeting, we announce with pleasure that more pens were exhibited at the latter show than on previous occasions; and that for quality in the classes generally, throughout the whole affair, even the most fastidious amateur could scarcely wish for better.

The grounds of Makin Durham, Esq., on which the Show takes place, as stated on the catalogue issued by the Thorne Committee, are "beautiful;" and the strenuous exertions of the Committee to make them subservient to the purposes of a show-yard stand beyond exception. Now on this point it is really one of those matters that to see is to believe; for without doing so not one in a thousand of our readers could imagine the amount of labour voluntarily rendered by the promoters of this Show to make each division not only effective for the purposes to which it is assigned, but also to add elegance and beauty to the whole. With attractions so great—the Thorne Fair to boot, and bands to enliven—a company filling the grounds to repletion is always to be depended on.

This day is always kept as a happy festival by the residents of Thorne; country cousins throng the households of most of the principal inhabitants, and all the joys attendant on annual re-union and friendship abound on every hand. Nor do the good effects of the Show manifest themselves exclusively within the precincts of the show-grounds. A general spirit of emulation seems, on the contrary, to pervade all classes to make due provision for this annual meeting. For weeks and months beforehand, painting, papering, and so forth, add much to the business of some classes, irrespective of the greatly increased amount of general retail trade throughout the town during the actual show-day. These good effects are not unseen by the inhabitants of Thorne, and consequently few, if any, withhold the helping hand to forward the success of the undertaking.

The Society possesses, most luckily for itself, and to the great pleasure of all connected with it, a really model Secretary in Mr. Joseph Richardson. Its members and the inhabitants generally all seem well aware of this fact, and, acting on the good old-fashioned principle of rewarding merit where merit is so justly due, subsequently to last year's meeting a subscription was entered into as an acknowledgment of this gentleman's services. About £180 was the result collected; and at the Show this year, under a tent provided expressly for the purpose, was displayed one of the handsomest and best-earned testimonials it has ever as yet been our privilege to view in connection with poultry-culture. A tea-tray bearing an appropriate inscription, and weighing over 80 ozs., is a principal feature; a silver teapot, a coffee-pot, sugar-basin, teapot-stand, and cream-ewer are among the et-ceteras, all being of sterling silver. We will merely add our hearty hope that the Thorne Committee may yet for many long years enjoy the supervision of their excellent Secretary, and that in time yet to come, this valued spontaneous gift may urge its then possessors to hold on in the same good rules of action and straightforwardness as their predecessor.

In the general adornment of the grounds, grottoes and

ferneries seem to be quite the order of the day. These alone are quite worthy the trouble of a visit. But as our subject is chiefly as to the poultry and Pigeons we must digress no farther.

The *Spanish* classes were very good, but moulting (as expected), had temporarily robbed them of much of their attractions to those visitors not well versed in the peculiar traits of character for which Spanish fowls are most noticeable.

In *Cochin-China* fowls the Partridge-coloured ones left behind all competition, and proved such as would be most welcome to even our largest poultry shows.

In *Dorkings* the Show at Thorne was deficient, and to add to the shortcoming, decidedly the best pen contained a hen that in transit had been so severely injured as to be unable to stand. Now, speaking of this useful breed, we may just call attention to a brood of White Dorking chickens, simply exhibited as extra stock, but worthily highly commended by the Judge. They were all one batch of about a week or nine days old, and comprised eighteen very hearty and apparently very purely bred chickens. When agitated by the first sudden playing of the band, the poor old hen seemed scarcely able to keep all her large family in order, but on the restoration of quietude herself and youngsters were evidently an object of general interest.

It was supposed (but most erroneously as it proved), that all the great guns in the *Game* classes would be domiciled at the Bath and West of England Show, to the prejudice of their classes at Thorne. On the contrary, the attainment of the Thorne Game fowls' silver cups was the most closely disputed of any in the Exhibition; and when it is known that Messrs. Adams, Hepworth, Julian, Robinson, Fletcher, Sunderland, Helliwell, Boys, Challoner, and a few others of like stamp, had all striven to secure these trophies to the utmost, it will be obvious that so keen a competition is seen but once in many years. The result was, the prizes were very widely sown—so much so, that none of the competitors could obtain much mastery. There were, consequently, no wholesale sweeps, but the interest of the Show was proportionately increased. Mr. James Fletcher took the cup for the best pair of Game fowls, any colour (Brown Reds), pressed so closely by Messrs. Challoner and Julian, that the appointment of a second prize was a truly difficult one, each of the latter gentlemen rejoicing in the exhibition of as good pens of Black Reds as could be well wished for. It was a neck-and-neck race, as may be supposed by Mr. Julian's pen receiving at the hands of the Judge the unusual distinction of very high commendation. Mr. Challoner took precedence in the Single Game Cock Class with a most splendid and highly-conditioned cock (a Brown Red), thus securing that silver cup, but not without being closely pressed by a whole host of cocks, whose merits at most of our shows would lead to certain success.

The third silver cup given to Game *Bantams* of any colour was closely competed for by Mr. Crossland and Mr. Maples, whose birds even at a glance threw out any, however distantly, approaching competition. Both pens were Black-breasted Reds, and such as amateurs of only a few years past would have considered quite unattainable. Both were gems, but the extraordinary diminutiveness of Mr. Crossland's pen drew the balance favourably. This pen shown in the very high condition they now are, is certainly one of the greatest triumphs of Game-Bantam breeding we ever met with.

The *Polands* were a good class, all colours competing together. In this class we regretted to find a disqualified card affixed to a pen of Black *Polands*, on the grounds of "the cock's tail being dyed, and a hen's legs coloured." It is quite necessary in these days, when amateurs know so well and so universally that such malpractices are strictly forbidden by general rule, and consequently inadmissible, that disqualification and exposure should ensue wherever discovery takes place. It is, no doubt, true they may sometimes pass muster, as did this selfsame pen of birds so recently as the Beverley Show, when thus got up so carefully to meet the characteristics required. At Thorne these *Polands*, unfortunately for their success, stood out in full sunshine, and the deception was visible at a first glance; at Beverley a somewhat confused light from the back of the pen placed these fowls out of the reach of discovery unless they had

been taken from the pen, which with Poland fowls is not customary. It would be well if owners, prior to resorting to these deceptive practices, would really well weigh the consequences in case of discovery against the ill-gotten gains resulting from an occasional want of exposure and detection. We need scarcely say the name of Mr. Carter, of Upperthong, revelled in the most notoriety of any amateur in the catalogue, and jibes and jests were consequently general. Among others, a facetious old gentleman of Thorne observed, "The certain way to put down such trickery would be, if a corner of such newspapers as are considered the oracles of the poultry world could be devoted, under the general heading of 'Painters and Decorators,' to the insertion of names and with brief particulars in all such cases. Public ridicule," he continued, "would prove a far greater restraint than all other appliances put together, however systematically arranged and justly demanded."

This Show contained one of the best general collections of *Red Caps* ever made public. They are the especial favourites of this locality; and to those parties who keep fowls simply for the production of eggs, none certainly can exceed them, as they lay at most seasons, and severity of weather seems scarcely to affect them at all.

A most singular feature of the Show was, that although an especial class for *Aylesbury Ducks* was given, it did not produce a single entry. To fill one of the pens devoted to this class a pair of excellent Chinese Silver Pheasants were sent, but, of course, they could only secure the attention of visitors as extra stock.

Although the weather the evening before the meeting was doleful enough, when taken in connection with an out-of-door show, the morning broke finely, and the day proved good till about one; a very severe shower then did a palpable injury to the receipts at the doors, but on its cessation the grounds were again well filled with a highly respectable company, so much so that the admittance money amounted to upwards of £141 in the one day.

SPANISH.—First, J. Siddall, Halifax. Second, W. Cannan, Bradford Committed, J. Holmes, Hotham; Messrs Burch & Boulter, Sheffield.

COCHIN-CHINA.—First, E. Smith, Middleton, near Manchester. Second, J. Wright, Woodbridge. Committed, W. Massey, Gedney.

DORKING.—First, M. Durham, Thorne. Second, C. Addy, Epworth. Committed, C. Addy; E. Smith, Middleton.

GAME (White and Piles).—First and Highly Committed, H. Adams, Beverley. Second, J. Sunderland, jun., Halifax.

GAME (Black-breasted and other Reds).—First, J. Sunderland, jun. Second, J. Hepworth, Bearswood Green. Committed, Messrs. Sales & Bentley; Crowle; W. Pickering, Crowle; H. Adams, Beverley; J. Hodgkinson, Hull; G. Helliwell, Walkley.

GAME (Duckwings and other Greys and Blues).—First and Second, H. Adams, Beverley. Highly Committed, Master G. Cocking, Crowle; G. Helliwell, Walkley.

GAME (Any breed).—Silver Cup and First, J. Fletcher, Manchester. Second, C. Chaloner, Worksop. Very Highly Committed, H. M. Julian, Beverley. Highly Committed, W. J. Cope, Barnsley; J. Holme, Knowsley; H. Adams, Beverley; J. Robinson, Ulverston. Committed, H. Hewitt, Alhmalme; H. Adams; J. T. Stoker, Darlington.

GAME (Single Cock, Any breed).—Silver Cup and First, C. Chaloner, Worksop. Second, — Boys, Beverley. Highly Committed, Messrs. Sales and Bentley; Crowle; H. Adams, Beverley; J. Sunderland, jun.; H. M. Julian, Beverley. Committed, G. Helliwell, Walkley.

POLAND (Any variety).—First, W. Cannan, Bradford. Second, W. Silvester, Sheffield.

HAMBURGERS (Silver-spangled).—First, W. Cannan. Second, H. Pancroft, Sheffield. Highly Committed, H. Carter, Upperthong. Committed, G. Scott, Hull.

HAMBURGERS (Golden-spangled).—First, Messrs. Burch & Boulton, Sheffield. Second, W. Cannan. Committed, G. Holmes, Great Driffield.

HAMBURGERS (Silver-pencilled).—First, H. Pickles, jun., Early. Second, G. Holmes, Great Driffield. Highly Committed, W. Cannan.

HAMBURGERS (Golden-pencilled).—First, S. Smith, Northowram, Halifax. Second and Highly Committed, Messrs. Froggatt & Harrop, Walkley. Highly Committed, W. Cannan.

FARMYARD CROSS.—First, W. Cannan (Black). Second, E. Smith, Middleton (Sultans). Highly Committed, C. Marsdin, jun, Thorne; H. Lucy, Hedden Bridge; Messrs. Froggatt & Harrop. Committed, C. Addy, Epworth; J. Wright, Woodbridge.

GAME BANTAMS (Any breed).—Silver Cup, J. Crossland, jun., Wakefield. Second, G. Maples, jun., Wavertree, Liverpool. Highly Committed, Hon. F. C. H. Hawke, Womersley Park; G. Maples, jun. Committed, R. M. Stark, Hull; W. Wood, Walkley.

BANTAMS (Silver or Golden-laced).—First, W. Cannan, Bradford. Second, E. Smith, Middleton. Highly Committed, R. M. Stark. Committed, W. Cannan; W. Massey, Gedney.

BANTAMS (Black, White, or Any-coloured).—First, G. Helliwell, Walkley. Second and Highly Committed, W. Cannan (Black).

COCK (Any breed).—First, W. Cannan. Second, R. M. Stark. Highly Committed, Hon. W. Eden, Cantley; G. Helliwell; G. Drinkell, Burton Stather; E. Smith, Middleton (Cochin); — Bailey, Sheffield. Committed, Hon. F. C. H. Hawke.

TWO HENS (Any breed).—First, Messrs. Sales & Bentley, Crowle. Second, Messrs. Burch & Boulter, Sheffield. Highly Committed, Hon. W. Eden; W. Burton, Doncaster; J. Holmes, Hotham; W. Cannan; W. Massey;

Godney. Committed, J. Gibson, Hatfield; R. M. Stark; W. Meens, Doncaster.

CHICKENS (Any pure breed).—First, W. Cannan. Second, G. Helliwell.

EXTRA STOCK.

HEN AND CHICKENS (White Dorkings).—Highly Committed, M. Darham Thorne.

GUINEA FOWLS.—First, H. Merkin, Driffield. Second and Highly Committed, Hon. F. C. H. Hawke.

TURKEYS.—First, W. Cannan. Second, R. J. Bentley, Finningley Park. Highly Committed, Hon. F. C. H. Hawke; R. J. Bentley. Committed, — Brown, Seawby Hall.

GEESSE.—First, Hon. F. C. H. Hawke. Second, Miss Norwood, Fox Gate. *Gibbs.*—First and Second, Hon. F. C. H. Hawke. Highly Committed, E. T. Whaley.

DUCKS (Any breed).—First, W. Cannan. Second, Mrs. Ledger, Bentley Highly Committed, J. Byrom, Hazlehead.

The classes of *Pigeons* were scarcely so extensively filled as on former occasions, but though deficient in numbers, the quality was excellent. We much regretted to notice a pen of the best white Powters we have seen for a long time, were shown so excessively "roupy," that the hen, at least, ought not to have been admitted into the show pens at all. In common justice to others, proprietors of such birds should not send them to exhibitions, for it is impossible to suggest any disease as being ultimately more fatal, or more speedily infectious.

CARRIERS.—W. Young, Howden. Second, W. Massey, Gedney. Highly Committed, H. Yardley, Birmingham.

CROPPERS.—H. Brown, Walkley. Second, J. C. Taylor, Middlesborough.

TUMBLERS.—First, R. Gravil, Thorne. Second, Mrs. M. Brown, Seawby Hall. Highly Committed and Committed, G. J. Lowther, Doncaster. Committed, H. Yardley, Birmingham.

JACOBS.—First, T. Ellington, Woodmanser. Second, I. T. Stoker, Darlington. Highly Committed, H. Yardley, Birmingham.

NUNS.—First, I. C. Taylor, Middlesborough. Second, H. Sunshall, Gedney.

TRUMPETERS.—First, F. Key, Beverley. Second, W. Young, Howden. Committed, C. Addy, Epworth.

TURBETS.—First, H. Yardley, Birmingham. Second, H. Sunshall, Gedney Committed, E. Holding, Beverley; H. Brown, Walkley.

FANTAILS.—First, I. C. Taylor, Middlesborough. Second, T. Ellington, Woodmanser. Committed, F. Key, Beverley; C. Addy.

OWLS.—First, H. Yardley, Birmingham. Second, C. Addy, Epworth.

BARBS.—First, W. Massey. Second, F. Key. Highly Committed, H. Yardley.

Edward Hewitt, Esq., of Eden Cottage, Sparkbrook, officiated as sole Judge.

CHILLED EGGS.

ALLOW me to drop a word or two to my brother poultry-keepers on a small scale by way of encouragement. I have had a hen serve me the most capricious tricks with a sitting of eggs I ever knew. On the 10th of May I had a hen brought me wanting to sit, so I put her on some common eggs, and twenty-four hours afterwards put some Silver-pencilled Hamburgs' under and some Dorkings' eggs. She took to them very fairly, and sat till Sunday, when I gave her a chance of an extended run, an opportunity she embraced by being off from eight till two, six hours. Having caught her, I kept her on the whole of that week, and on Sunday again she was off for six hours. Well, I gave up all hopes of my birds. I turned her off, and tried for two days to break her from sitting. However, I put another hen on the eggs, to settle her, on the Monday, May 23rd. Determining to destroy the whole sitting, on the 25th I commenced breaking them, and found a live bird in the first. That stopped me, so I tried the wild bird again, and she took to them for a few hours, and left them for another part of the hayloft for more than twelve hours. Determined to give them a trial I sent them away, eight of them, to a friend who had some more sitting hens than myself, and three days after the time was up I got six good strong birds out of my eight eggs, the two that missed were Dorkings. I have never met with such a case, nor have any of my poultry friends.—BERT.

TROUBLES OF A FOULTRY-YARD.

"A FARMER'S WIFE" will be extremely obliged by advice how to treat her young Turkeys. A more healthy flock, to all appearance, from one to two months old, it would, she believes, be impossible to find. Still she has had three or four droop and die; they have seemed as well as ever, perhaps, when turned out in the morning, and by midday have

looked very dull, and in a few more hours have been dead. Will you tell her what to give them?

She has, also, some very fine Aylesbury Ducks, hatched last June from eggs purchased from one of the most fortunate exhibitors. Her stock consists of six Ducks and two Drakes, and she has only had about forty eggs from them. There is an odd Goose goes in the same house, would she eat the eggs?

[The transition from health to sickness and death is so rapid, that it can only be attributed to the operation of something the birds pick up and eat. When the weather is as changeable as it has been of late, Turkeys feel it more than any other poultry, and stimulants are the only treatment for them. We have always found ale the best and the easiest to administer, because they eat bread readily that has been soaked in it. It is very bad for them to be out on damp grass, or very early in the morning when there is frost. They follow each other closely, and we have had mornings cold and frosty enough of late to kill the sickly birds of a brood. Meal, made of oats and peas or beans, ground together, and mixed with milk, is very good food for them; and if onion tops are chopped with it, so much the better. When a Turkey is drooping, nothing but stimulants will save it. We should think it likely the Goose ate the Ducks' eggs. It is a bad plan to allow Ducks and Geese to roost together.]

PIGEONS DISEASED.

A CORRESPONDENT, "PARVO," complains of a swelling on the joint of a Pigeon's wing. I believe it arises from a blow, though it may also be partly constitutional; and it is generally stated that hens will not breed when so affected. I have cured them by means of a seaton, thus—take a sharp needle with double cotton and pass it through the skin over the joint, tie the ends, making a loop, keep the wound open by moving the thread every day until the sore discharges, after which the swelling will subside, then the thread may be cut and drawn out, and all will heal well. I have sometimes put the thread through both above and below the joint. The object is to cause it to discharge; perhaps a little blister ointment might hasten the cure.

I had a young hen Air Tumbler strangely affected last year. She was a first-rate tumbler. One day I noticed she refused to rise with the flight; next day she seemed unable to use her wings; she wasted away and was long ill, and I could do nothing for her. After some considerable time the disease went to the head, the eyes swelled and discharged, as also the nostrils, but with it she gradually improved in bodily health, and regained the use of her wings, but her eyes were weak for months. I hated them frequently with lotion. She is now well, though the eyelids are rather distorted, but she has not yet laid, and though she flies well she does not tumble so much as formerly. Can any one give me any information respecting this disease?

I have had much experience in Pigeon-keeping, and have generally enjoyed immunity from diseases, but since I have been here (Dallington, Sussex), several diseases have appeared among my Pigeons that I cannot account for. Two years ago all the young Pigeons of one breed pined away and died as in a decline. I never saw the disease before, and after losing a great many, I saved two by cod liver oil.

This year some of my old birds are dying off, and I cannot account for the attack, nor yet cure the disease; it seems to be a diarrhoea that takes them off in two or three days. Can any one assist me to a remedy?—B. P. BRENT.

SUPERING SWARMS.

I NOTICED in your Journal a short time ago a recommendation to put on a super directly a swarm was hived, the swarm first filling the super with comb, and the queen depositing her eggs in the same, which were all hatched out in the space of three weeks or so; and then the super was filled with honey, which after a short time might be removed. Supposing I put a super on a swarm three weeks after it is hived, in what time might I expect it to be full, the weather being fine and the time it was put on June 8th?—DUMPLING.

[The recommendation to which you refer was not made

in our columns, nor have we ever tried it, but it may be a good one for all that; and as it is described by you with sufficient correctness, we hope some of our readers will submit it to the test of experiment and acquaint us with the result. The probable time occupied by a swarm in filling a super depends upon too many unknown and uncertain contingencies—the size of the super itself, the strength of the swarm, and the fecundity of its queen, the nature of the locality, the character of the coming season, &c.—to admit of a satisfactory reply.]

OUR LETTER BOX.

EVERLEY SHOW (*An Eye-witness*).—We are quite sure that the judgments were honestly given; and we should have implicit confidence in the decisions of the Judges who made the awards. There was an oversight, and a prize given to a pen of Pouter's which had been dyed, but the right exposure of the fraud was made at the Thorne Exhibition, as will be seen in our columns to-day.

POULTRY IN CELLARS (*J. M. O.*).—Either Cochins, or Brabmas, or Spanish fowls would do in a cellar if perfectly dry, airy, and light; but they would not do so well as they would if they had sun. Chickens could not be reared in a cellar.

HEN BECOME BLIND (*Old Subscriber*).—We cannot think the excessive laying would produce blindness, but the system may have been weakened by it.

REARING PEA-FOWLS (*Subscriber*).—Pea-chicks must be kept dry and tolerably warm. They should be fed on ground oats mixed with milk, bruised hempseed, chopped egg, and cooked meat chopped fine. They should have beer to drink at first, and bread and beer is good food for them. The hen should be shut up for six or seven weeks, and the chicks should not run about in the morning till the grass is dry. Barley meal and leek or onion tops chopped and mixed make good food.

CROWS AND RATS DESTROYERS OF CHICKENS (*Idem*).—Rooks do not kill and eat chickens, Crows do, and if they have once taken to a brood they will kill all unless they are themselves killed. We know to our cost how difficult it is to get rid of rats. We have found ferrets the most effectual method of killing them. They may be very much stopped if their holes as fast as they make them are filled with large loose gravel stones, and small heaps of the same put over them. When they move one, another falls in its place. If the plan of getting rid of them for 2s. 6d. is anything like one advertised at 5s. it involves a fortnight's labour, considerable expense, and spoiling half the doors and wainscots of a house.

ROOPY BANTAM (*J. F. T.*).—Put the Bantam cock somewhere by himself. Give a dose of a tablespoonful of castor oil, and feed two hours afterwards with stale bread steeped in strong old ale. Wash the mouth, eyes, and nostrils with cold water and vinegar. If he continues so weak, you must feed entirely on bread and ale, except when varied with some chopped egg.

PAINT POISONOUS FOR POULTRY (*Subscriber*).—Paint is deadly when taken internally by poultry. The only treatment we know of is castor oil given freely, and an adult Turkey would take two tablespoonfuls. We have known Turkeys lay as many as forty eggs without sitting.

CROWING AN ANNOYANCE (*A Constant Reader*).—We do not consider your neighbour could prosecute you criminally, nor is it clear that he has a legal remedy; but as the crowing of your Brahma Pouter annoys your neighbour, would it not be well to remove the poultry-house to a distance?

CHITTEPRAT (*G. H.*).—It is an old local name for the Silver-pencilled Hamburg. It is probably a corruption of the Anglo-Saxon—*Gween*, a chicken, and *prate*, ornamented—referring to its pencilled feathers.

TURTLE DOVES' EGGS UNPRODUCTIVE (*S. P.*).—It is not uncommon for added eggs to dry up in warm weather, which arises from the evaporation that takes place through the shell during incubation. I conclude "S. P." means the Collared Turtle Doves, commonly kept in cages, and not the Wild ones. The Turtle Doves, the summer visitants to our woods. But why the eggs are unproductive it is impossible for me to divine without knowing more particulars. I can only suggest a remedy by asking a few questions—Are the hens properly mated? otherwise the eggs cannot be fertile, though two hens will sometimes pair and lay. Are the Doves too nearly related? or are the cocks old and crippled? Lastly, have they proper food, materials for nesting, and convenient places for incubation? or are the cocks too fat? Any one of these circumstances may render the eggs useless.—B. P. BRENT.

PIGEON WITH DISEASED EYES (*A. M.*).—It is almost impossible, from your account, to say what is the matter with your Pigeon's eyes. Has it been pecked? You can try bathing the eyes with warm water, and anoint them with some aloe, as Turner's cerate.

CARRIER PIGEONS NOT FEEDING THEIR YOUNG (*K. K. F.*).—This most likely proceeds from the old birds being too highly fed. A good plan would be to keep a few pairs of Dragons, or other good feeding Pigeons, as nurses.

DESTROYING RATS (*Idem*).—For the destruction of rats I would call attention to Mr. Brailsford's wire traps, which I have heard highly spoken of. When the present colony has been captured let all be made secure against fresh arrivals.—B. P. BRENT.

BEE PARASITE (*A Lanarkshire Bee-keeper*).—What you send is a part of the skin of an Acarna, but of what species we are unable to determine. We should be obliged by your sending us a bee, either living or dead, with these parasites adhering to it.

LONDON MARKETS.—JUNE 20.

POULTRY.

There has been a good demand for poultry the last month, and although the supply has steadily increased, yet it has not been equal to the average of previous seasons. Prices have been consequently maintained.

	s. d.	s. d.		s. d.	s. d.
Fowls	3 6	4 0	Pheasants	0 0	0 0
Smaller do.	2 6	3 0	Guinea Fowls	0 0	0 0
Chickens	1 9	2 0	Rabbits	1 4	1 5
Goats	5 6	6 0	Wild do.	0 8	0 9
Ducklings	2 6	3 0	Pigeons	0 8	0 9

WEEKLY CALENDAR.

Day of M th	Day of Week.	JUNE 28—JULY 4, 1864.	Average Temperature near London.			Rain in last 37 years.	Sun Rises.	Sun Sets.	Moon Rises.	Moon Sets.	Moon's Age.	Clock before Sun.	Day of Year.
			Day.	Night.	Mean.	Days.	m. h.	m. h.	m. h.	m. h.	24	m. s	
28	Tu	CORONATION OF Q. VICTORIA, 1838.	73.3	49.6	61.5	15	47 af 3	19 af 8	7 0	40 2	24	2 58	180
29	W	St. PETER.	72.8	48.8	60.3	10	48 3	19 8	37 0	55 3	25	3 10	181
30	Th	Meadow Foxtail Grass ripe.	72.7	48.7	60.2	12	48 3	18 8	12 1	53 4	26	3 22	182
1	F	PRINCESS ALICE MARRIED, 1862.	72.1	51.9	62.0	18	49 3	18 8	54 1	58 5	27	3 34	183
2	S	Lime tree flowers.	73.2	51.7	62.5	13	50 3	18 8	41 2	59 6	28	3 45	184
3	SUN	5 SUNDAY AFTER TRINITY.	74.1	51.0	62.5	16	51 3	17 8	36 3	33 7	29	3 56	185
4	M	Corn Sow Thistle flowers.	75.8	50.7	63.2	13	51 3	17 8	35 4	9 8	☉	4 7	186

From observations taken near London during the last thirty-seven years, the average day temperature of the week is 73.4°, and its night temperature 50.3°. The greatest heat was 91° on the 30th, 1862; and the lowest cold, 31°, on the 28th, 1862. The greatest fall of rain was 1.15 inch.

MISAPPLICATION OF FLOWERS.



COMMONLY enough it occurs that where public taste sets in favour of any one article, some injudicious friends of that article do it considerable harm by advocating its claim to an extent not warranted by its merit. Many new and useful plants have been blighted in public opinion by too much having been said in favour of them by some indiscreet admirer, where-

as a true and unprejudiced narrative of their worth might have retained them an honourable place.

It may appear unkind to check the unbounded admiration of certain enthusiasts, yet it sometimes happens that by their laudations they do the article more harm than good; looking at only one side of the picture they forget to point out any defect it may have, or, in their zeal to advocate its cause, cannot see any, and, consequently, thrust forward their favourite for a purpose it is not suited for, and the public being disappointed, will not give it credit for what it really possesses.

Until the last three or four years each succeeding season ushered in a number of new bedding plants, which, after trial, passed into neglect, the character given of them not being fulfilled in their growth and appearance. Perhaps one good feature in this is that old and tried good kinds are the more thought of when new ones have failed. But there are other cases in which the ardent admirers of the beautiful threaten to do harm to their cause as well as in their advocacy of new plants or varieties of them, and that is in no less a matter than the almost universal purposes to which flowers are now put—purposes which, I fear, must tend to create that indifference if not dislike to them which all interested in their culture must deplore.

Although it is next to heresy to breathe a syllable against flowers, nevertheless they are sometimes introduced where their presence can hardly be otherwise than inconvenient, if not an absolute nuisance. For instance: some kind visitor will intrude a bundle of strong-scented flowers into a sick-room, or, perhaps, a bedroom, while the sitting and other rooms are so profusely garnished with flowers that the legitimate fittings there are disregarded. It is certainly not my purpose to say much against the dinner-table being ornamented with tasteful displays of flowers, but a too great profusion must be contrary to good taste; and some of the contrivances adopted to exhibit the flowers partake so much of the toy character, that I should predict that they are likely to have a very short reign. In fact, the design for this class of ornament is only yet in its infancy, and no doubt when

it settles down into something like a channel that will accord itself with other things, we shall look back on the present period, and wonder at the monstrosities that are now countenanced.

Not very long ago at a table of some pretensions I noticed every dish and object had flowers or foliage stuck upon it. Even the hot viands emitted their steam against fast-fading blooms of exotics, while stands for plants were scattered with a profuse hand over the centre and side-tables.

Now, though this is unquestionably the age for embellishment, some discretion must be exercised in its use; for assuredly ornament too profusely employed ceases to deserve the name. Flowers, fruit, and foliage are all pleasing objects to look at, but they are not to be tolerated when out of place; and when every mantelpiece, bookshelf, table, and other such places is crowded with flowers, the eye becomes tired of the monotony, and all delight in their presence is lost. Flowers are also sometimes placed where existing things tend to destroy their effect—as, for instance, where a stand of cut flowers is placed against a wall that is covered with a paper of a high-coloured floral pattern, the real contending against the sham. But let us leave this department, and, emboldened by our attack on flowers where misplaced, let us pry into another quarter where they are at the present moment exceedingly popular, and see if good taste, utility, and the other conditions that govern all prudent measures will assign them a place there.

Pardon me, ye ladies, to whom all lovers of flowers look for support and encouragement, if one of the purposes you put them to should meet with undue censure; for I confess I intend to be rather severe, and when I say I mean to attack no less a feature in your pet arrangements than the bouquets you so fondly caress, I fear I am bringing a frown upon myself which I by no means invite. Perhaps I may be too much of a utilitarian, and look at things only with a view to what useful services they are likely to perform; if so, my attack on hand-bouquets must only be taken for what it is worth; but I certainly aim at something better than mere condemnation, I should like the thing reformed. Let us take an example, and an ordinary one.

For a lady of rank prepared for a ball one of the requisites of the present day is a bouquet in the shape of the shield of Achilles, and nearly as large. This bouquet is made as symmetrical as if it were cast in a mould, and as stiff and formal as if it were formed of earthenware or cast iron. Its bulky proportions give quite sufficient employment to one hand to hold it; and though sometimes the courtesies of a partner may be agreeably called into play in holding it for a time, it nevertheless requires almost as much nursing as a baby. If laid on a seat it certainly may not occupy so much room as the lady herself, but will take up quite as much as her partner, and it is an endless source of concern and anxiety, and finally, perhaps, occasions some little disaster to the dress by being attached to the side for security; or perchance getting upon the floor, an accident of another kind is the result. All these things and many others are of every-

day occurrence where huge hand-bouquets form portions of ladies' ball equipments; and what compensation do they offer for the discomfort? The odour of the flowers may be urged in their favour; but very often such bouquets are made more for appearance than for the scent, in fact, that of some flowers so used is disagreeable rather than otherwise. That they are of gay colours is also urged as a recommendation, but so also are very often the dresses of the fair ones who carry them; and it rarely happens indeed that any regard is paid to the contrast between the dress and the bouquet, so long as the latter is formed of rare and costly flowers.

In thus complaining of bouquets as they are formed at the present time, I by no means find fault with them on all occasions. A neat bouquet, not too large and unwieldy, may be a fitting, perhaps necessary, accompaniment to a lady in a carriage or when going to a levée; but for a ball, could not a few sprigs be neatly fastened to some prominent portion of a lady's dress, so as not to inconvenience the wearer? The little knot in a gentleman's button-hole affords a very good example, and looks well; and that ladies should go somewhat further is excusable enough, but the excess so often run into is inexcusable, as the discordant elements the bouquets are composed of, and the highly artificial form they assume, give them all the appearance of being made of some of the various compositions that imitations are so cleverly carried out in. Assuming flowers to be real, would not a tittle of those now used in the making of a fashionable bouquet effect the same object? and would not the effect be better?

Much more might be said against the use of flowers for purposes to which they are so incongruously applied; and beautiful as they are in most cases, I would warn their greatest admirers not to use them in too great numbers in places where they are not wanted, or where the conditions of other things seem to call for something else instead; for by so doing they disgust rather than please the discriminating eye of true taste, and instead of extending the patronage of floral display they diminish it; for, as before said, ornament too profusely applied ceases to deserve the name. Let the best friends of Flora, therefore, beware that in introducing flowers everywhere they do not sacrifice good taste. By a judicious disposal of a less quantity they alike cultivate a higher and purer taste, and perpetuate the love of floriculture.—W. R. R.

ROYAL HORTICULTURAL SOCIETY.

THE follies which have been perpetrated at the Kensington Garden during the past week are so palpable, so offensive to good taste, and so totally incompatible with the objects for which the gardens of the Society were founded, that no vituperation with which such mountebankery could be castigated would be in excess of what all the horticultural Fellows feel. We are in no degree surprised at such follies, and we have warned our readers more than once what might be expected from the present management.

CULTIVATION OF THE PINE APPLE.

(Continued from page 429.)

WHEN a greater number of fruit begins to ripen at any given time than is necessary to supply the demand, it is in many instances desirable that a portion of them should be retarded to form a succession of fruit in good condition. This is easily effected by removing them to a cooler situation as soon as they begin to colour. I have frequently placed them in a vinery where the Grapes have ripened, and where fire heat has been left off and a free circulation of air allowed. In such a place they ripen gradually, and I find Pines so ripened generally excellent in flavour. The cool dry atmosphere of the vinery and the shade of the Vines are good retarding conditions; and where a compartment cannot be spared for the purpose, this is as good a way of retarding Pine Apples as any that I have tried. Fruit may be cut before they are quite ripe, and, laid in a dry fruit-room, they will keep for weeks; but probably the better way is not to detach the fruit from the plant, but to remove plant and fruit to some cool shady place. These observations, of course, apply to summer fruit.

When the fruit is all cut from a pit or houseful of plants the suckers should be carefully attended to. The dry condition of soil and atmosphere which is necessary to good flavour in the fruit is not favourable to the well-being of the suckers: consequently I have frequently removed and potted the suckers immediately the fruit began to colour, and when more air and a dry condition became necessary for its quality. Sometimes, however, the suckers are but small by the time the fruit is ripe, and in such cases it is advisable to leave them till the fruit is cut. Then the soil should have a good watering, and the moisture in the atmosphere be increased till the suckers have made further growth.

The practice of allowing suckers to lie in a cool dry place, and detached from the parent plant, with the object of drying them, is one for which I never could understand a good reason, and I cannot perceive what good end is gained by it. On the contrary, in my opinion the practice is injurious to the progress of the young plants, and is, consequently, attended, to say the least of it, with a loss of time.

Where a regular supply of fruit has to be kept up nearly all the year round from a limited number of plants it is not advisable to pot too many suckers at any one time. The best way to keep up a supply is to pot smaller quantities at more frequent intervals. It is, however, desirable to pot the greatest number about the month of August, when all the early batch of fruit is generally cut. In this case it is best not to select all the suckers of the strongest character, but rather to have about equal proportions of two sizes. These can be so managed and arranged as to give a supply of ripe fruit in the case of Queens from June to October of their fruiting year.

These remarks and those of my preceding paper have reference to summer and early autumn-fruiting Queens. For winter and spring Pines I always endeavour to start a quantity at two different times from the middle of July till the middle of September. For this purpose the best sorts are the true variety of the Smooth-leaved Cayenne and the Black Jamaica. The former is a noble Pine, being unsurpassed for appearance and long keeping after it is ripe, and it is juicy and well-flavoured. The latter is a more highly flavoured Pine, but not so sure a starter, nor nearly so handsome.

To have sets of these in a fit state to start at the periods named, the earliest of the two should be shifted into their fruiting-pots in the previous summer, kept growing till the end of October, and afterwards kept comparatively cool till the middle of April; then by increased top and bottom heat, with moisture in proportion, they will start into fruit in July. In cases where the plants are forward a portion of this lot will start in May without making a growth; but where there are plenty of other summer varieties it is not desirable that they should, for their fruit is never so fine as that yielded by those which first make a growth and then show fruit. To have a succession to these for late winter and early spring fruit, those that have been wintered in eight-inch pots and shifted in March come in the best. For this purpose, especially, I have never found any Pine equal to the Smooth-leaved Cayenne, and from plants of it so managed we have here had very fine fruit in the spring months as well as throughout the winter. Those expected to start late for spring fruit should now (June the 13th) be growing freely, and when they have well filled their pots there is little fear of getting them to start after being kept a little more freely aired and cool for a few weeks.

There is nothing peculiar in the treatment needed for these varieties. They probably require more moisture at the root than is good for the different varieties of the Queen. The Cayenne is also more impatient of bright sun early in the season than any variety I know, and especially so in cases where the plants have been kept growing late in autumn. Rather than allow the foliage to become browned shade should be applied in early summer; with a moist atmosphere and shade the browning can easily be done away with when it may occur.

There is a spurious variety of Cayenne which has been identified with the true, and in consequence the latter has in some instances been condemned. The two are very much alike in fruit, but have this great distinction, that the one commences to rot as soon as ripe, and is in other respects

worthless, while the other can be kept six weeks after it is quite ripe, and is juicy and rich. The best variety is broader and more recurved in leaf than the other, has always a few spines at the points and base of the leaves, and will not produce one sucker for six that the spurious variety does.

It is not my intention to balance the merits of the planting-out and the pot-systems. Doubtless both have their recommendations, and can be carried out with success, even with very commonplace appliances. Although I have given a good deal of attention to the planting-out system I have not adopted it—not that I suppose that as fine fruit is not to be regularly produced by it, facts prove otherwise; but with the accommodation at command, I have never been able to see how I could so fully and regularly keep up a supply of Pines as when they are in pots, and, as a consequence, available at all times for being moved, and removed either to force forward or retard fruit, as the case may demand. Neither do I conceive it necessary or desirable to have finer fruit than eleven-inch pots can be made to produce. It is not the size of pot nor the unlimited range that the open bed allows, that are the principal points of good Pine-culture.

There is, however, a simplicity about the best system of open-bed cultivation which induces me to give a short outline of the very best practice on that system. The sucker-pits are prepared by putting about 2 feet of Oak leaves (where fermenting materials are used for bottom heat) into them, and treading these as firmly as possible, and over the leaves is placed about 4 inches of fresh loam. The suckers are then planted in rows pretty close together, at the same time so as not to be crowded. This applies to the lot of suckers put in in August. They are then sprinkled overhead and kept close, and at a temperature of 70° to 80°; they are shaded during hot sunshine, and sprinkled overhead two or three times a-week till they are rooted, when they are exposed to light and more air—in short, treated in other respects the same as potted plants. Sufficient water is given at the root after they are rooted just to moisten the soil about their roots. By the following March the roots will have run nearly all over the bed, and then they are transplanted into the succession-pits, where a foot of loam is provided for them. In transplanting them they are lifted with their roots as entire as possible. They are planted about 2 feet apart each way, and when the operation is completed they get a good watering to settle the soil about them. In the month of August they are ready to be moved into their fruiting quarters, when careful transplanting must be carried out.

This system can, of course, be modified by any one conversant with the nature and wants of the Pine Apple, and is an admirable method, especially where immense quantities of plants are grown. But it is my opinion that for rapid and certain fruiting, and under many circumstances, as where a regular supply is required from a small amount of accommodation, the comparatively small-pot system is the best.

D. THOMSON.

MY GROUND VINERIES.

I HAVE four of these most interesting structures now in full work; they are each 14 feet long, in two seven-foot lengths, placed on bricks, and paved with slates, exactly as given in your figure in No. 28. In one there is a Trentham Black, in the others two Black Hamburgs and a Buckland Sweetwater. On the four Vines are now two hundred bunches of bloom, and their fruit set, I shall, of course, remove more than half of these. What gratifies me more than anything is the vigour and health of these Vines, every spur shows from one to three bunches, and every leaf and shoot is perfect.

The Vines are planted at the north-east end of each vinery. The ground was trenched 2 feet in depth, and manure well mixed with the soil. No other preparation was made; but it must be confessed that the soil is highly favourable—a calcareous sandy loam, very deep. The Trentham Black has made such a vigorous shoot that it has run into its neighbour, and is 21 feet long. I can now see that a vigorous-growing Vine may be made to occupy four lengths—28 feet, or even more, so that the produce of one Vine may be, as Dominic Samson would have said, prodigious.

When I look at my productive healthy Vines I cannot

help wishing that every suburban garden with a southern aspect, however small, had one of these ground vineries in it. No syringing, no watering is required. The Vines lying on the slates on the earth have, I imagine, the advantage of constant radiation of moisture from the earth: hence their immunity from that Vine pest the red spider.

The cares attendant on these structures are thinning the fruit and stopping the shoots, the latter fortnightly through the summer.

Any of your readers interested in Vine-culture—and who is not?—is most welcome to view my ground vineries.—THOS. RIVERS.

THE ALEXANDRA PARK HORTICULTURAL SHOW.

THIS took place on the 22nd and 23rd inst.; and the display, as was to be expected from £700 being offered in prizes, was varied, extensive, and good. The floral portion of the Exhibition was held in four large tents communicating with each other, and in these turf banks were raised to serve as stages, after the manner adopted at the Regent's Park. In one respect the Show differed from other great London shows, and that was the arrangement of the plants. These instead of being kept together according to their classes, Stove and Greenhouse Plants along with Stove and Greenhouse Plants, Ferns along with Ferns, Roses along with Roses, were arranged to produce an effect. The intermixture of the flowering with the ornamental-foliaged plants took away that monotonous appearance which generally exists when each class of plants is shown by itself. This was a feature peculiar to the Show, and which, though it considerably increased the labours of the Judges and reporters, was well worthy of the attention of those having the arrangement of horticultural exhibitions. There can be no doubt that the brilliant colours of the splendid specimen plants which are brought to our great shows, would be shown off to greater advantage if there were a judicious intermixture of foliage; while, on the other hand, the plants of which the principal attribute is the ornamental character of their foliage, would be lighted up by the brilliant hues of their neighbours. This mode of arrangement was, we believe, principally carried out by Mr. Williams, of Holloway; and though the limited amount of time which elapsed between the arrival of the plants and that of the Judges did not permit of his making it so perfect as he wished, still it was an improvement for which he deserves great credit.

STOVE AND GREENHOUSE PLANTS.—Many of the leading exhibitors of these did not make their appearance, and the specimen plants of several of those who did had lost somewhat of their beauty; still they made a good display. Unfortunately there were only three classes—namely, one for twelves from amateurs, another for eights from nurserymen, and a third for collections effectively arranged. Thus many who would have been competitors were, doubtless, shut out. The plants exhibited were little different as regards kinds from those noticed in previous reports. Allamandas were represented by cathartica, grandiflora, and Schotti, with their showy yellow flowers in good condition; of Ixoras, Pimeleas, Phœnocomas, Apelexes, and Ericas there were several very good plants. Mr. Fraser had a very fine plant of Dipladenia crassinoda, a red-flowered twiner, which is seen less frequently than it deserves. From Mr. Rhodes came Hoya Paxtoni, with very pretty wax-like rose and white flowers, but from not being placed at a sufficient height above the eye their beauty was lost. Dracophyllum gracile, from Mr. Williams, was very fine, the pure white of the flowers contrasting very well with the pure green of the foliage. The violet purple Statice profusa from the same, was also very ornamental. Prizes were awarded as follows:—For twelves, Mr. Chilman, first; Mr. Peed, second; Mr. Baines, Bowden, third. For eights, Mr. Fraser, first; Messrs. Lee, second; Mr. Williams, third; Mr. Cutbush, Barnet, fourth. For sixes Mr. Baines, first; Mr. Chilman, second. For the most effectively-arranged collection, Mr. Williams, first; Messrs. A. Henderson, second; Messrs. Lee, third.

FINE-FOLIAGED PLANTS made an extensive and fine display, the specimens exhibited being mostly large, and in excellent condition. Among the most noticeable were Alocasia me-

tallica, *Latania borbonica*, *Gleichenia hecistophylla*, *Dracæna indivisa*, and *Yucca quadricolor*, from Mr. Williams. Messrs. Lee again exhibited their fine plants of *Neottopteris australasica*, *Cordyline indivisa*, *Rhopala corcovadense*, and *Oreopanax dactylifolium*. *Anthurium leuconeurum*, and the large-leaved variegated *Alocasia macrorrhiza*, *Cyathea Smithii*, and *Aralia Sieboldi*, were a few of the finest of those from Messrs. A. Henderson. Mr. Williams had the first prize; Messrs. Lee the second; Messrs. A. Henderson the third. In the Amateurs' Class, a splendid *Gleichenia spelunca*, 5 feet across, was shown by Mr. Baines, gardener to H. Micholl, Esq., Bowden, Cheshire; also a very large plant of *Croton longifolium*, a fine *Theophrasta imperialis*, and *Rhopala*. *Musa Cavendishii* came from Mr. Donald, Leyton, and being ornamental, from its broad foliage, as well as useful for its fruit, might be more grown than it is. The crimson, white, and lucid green *Caladium Wightii* was also shown by the same exhibitor. A fine plant of *Blechnum brasiliense* and two very good *Caladiums* came from Mr. Young, Highgate; and Mr. Taylor, gardener to J. Yates, Esq., of the same place, exhibited a neat plant of *Cissus discolor*, a large *Rhopala*, *Cycas revoluta*, and *Encephalartos latifrons*. Mr. Baines was first; Mr. Taylor, second; Mr. Donald, third; and Mr. Young, fourth.

FERNS.—Remarkable among these were the tree Ferns from Mr. Williams and Messrs. Lee, which were placed in a circular tent among the flowering plants to take away the flatness which would otherwise have been apparent, and their wide-spreading graceful fronds had an excellent effect. They consisted of *Alsophila australis*, *Cyathea serra* and *australis*, and *Dicksonia antarctica*, from Mr. Williams, and a similar collection from Messrs. Lee. From Mr. Williams came a collection of twelve exotic Ferns, among which were fine plants of *Cibotium princeps* and *Schiedei*, *Cyathea grandis* and *Todea africana*. Good collections were likewise shown by Messrs. Young, Taylor, and Holland. Of Lycopods, some excellent pans were sent by Mr. Young; and of hardy British Ferns, Mr. Williams exhibited a collection of thirty distinct forms. The prizes awarded were—For tree Ferns, Mr. Williams, first; Messrs. Lee, second. For twelve exotic kinds, Mr. Williams, first; Mr. Woolley, second; Messrs. A. Henderson, third. For ten, Mr. Young, first; Mr. Taylor, second; Mr. Holland, third. For hardy British Ferns, Mr. Williams first. For Lycopods, Mr. Young first.

ORCHIDS though not very numerous were in tolerable condition, but not so fresh as at previous shows. Some good examples of *Lælia purpurata*, *Cattleyas Mossiæ* and *superba*, *Vandas*, *Ærides Fieldingi*, *Cypripedium barbatum* and varieties, also *Hookeri*, *Orchis foliosa*, and the showy *Sobralia macrantha*, were shown. *Maxillaria tenuifolia* was bearing a profusion of its red and yellowish flowers, and there was also *Cirrhea fusco-lutea* with dingy yellowish green flowers, from Mr. Woolley. For fifteen, Mr. Wilson, Enfield, was first; Mr. Peed, second; Mr. Baines, third. For eight, Mr. Williams, first; Mr. Woolley, second; Mr. Rhodes, third. For six, Mr. Woolley, first; Mr. Wheeler, second; Mr. Chilman, third.

HEATHS AND AZALEAS.—Of the former some very good plants were exhibited, such as *Ventricosa magna* and *Bothwelliana*, *Aitonia turgida*, *obovata*, *Candolleana*, *Savilleana*, &c. For ten Mr. Rhodes had the prize. For eight Mr. Peed was first; Mr. Wheeler, second; Mr. Chilman, third. For six, Mr. Wheeler, first; Mr. Cutbush, second; Mr. Rhodes, third. From Azaleas it was too late to expect much, but Mr. Turner and Mr. Peed had still some good plants. In the Amateurs' Class Mr. Peed was first, Mr. Penny second.

MISCELLANEOUS AND NEW PLANTS.—Hanging-baskets variously filled were sent by Messrs. A. Henderson, Williams, Earley, and Cutbush; garden vases of terra cotta by Messrs. Henderson; of artificial stone by Messrs. Cutbush and Mr. Willhaus. Messrs. Barr & Sugden again exhibited their plant-cases, which have already received commendatory notice in previous reports, also rustic window-boxes. New plants were the same as seen at previous shows. Certificates were awarded to Messrs. Veitch for *Gymnogramma Pearcei*, their new *Lomaria*, *Dracæna Cooperi*, and *Lilium auratum*; to Mr. Fraser for *Dracæna stricta*; to Mr. Williams for *Anæctochilus petala superba*, *Zamia Lehmanni*, *Cattleya amethystoglossa*, *Lamatophyllum borbon-*

icum, *Agave Schidigera*, his fine variegated New Zealand Flax, *Phalænopsis grandiflora aurea*, *Sphærogyne latifolia*, *Lomaria zamæfolia*, and *Yucca albo-spica*; and to Mr. Townsend, Hornsey, for three varieties of *Clematis lanuginosa*. From Mr. Baines, of Bowden, came very fine examples of *Anæctochilus Lowii* and *xanthophyllus*, the curious *Dionea muscipula* or Venus's Flytrap, and fine plants of *Sarracenia purpurea*, *flava*, and *variolaris*. Mr. Findlay, of the Manchester Botanic Garden, again exhibited his large-leaved *Alocasia*; it looked much better than when seen at the Regent's Park, and was awarded a certificate.

FRUIT.

The show of Fruit, though much less extensive than was expected from the number of entries which were made, was nevertheless very good. The first prize for a collection was taken by Mr. A. Henderson, of Trentham, with two Pines, a Melon, Figs, Royal George Peaches, *Violette Hâtive* Nectarines, and *Bigarreau de Hollande* Cherries; Mr. Dawson, gardener to Earl Cowper, Panshanger, was second; Mr. Turner, Slough, third.

PINES.—Though but few were shown these were generally very good. For four fruits, two of a sort, Mr. Young, gardener to Crawshaw Bailey, Esq., Cyfarthfa Castle, took the first prize with two large Providence and two fine Queens; Mr. Penny was second in the same class with Ripley, and Moscow Queen, very well ripened; and Mr. A. Henderson third, with Smooth-leaved Cayenne and Ripley Queen. In the class for Providence, Mr. Young was first with a large and fine fruit; and Mr. Smith, Calderstone, second with one weighing 8½ lbs. In Queens, Mr. Young was first with a fine fruit; Mr. Grant, second; and Mr. Rochford, Page Green, third. We may here call attention to the fact, that with hardly an exception the weight of the fruit exhibited was not, as it ought to have been, stated; and thus a guide is not afforded as to the merits of the productions as compared with those of previous years. This fault is not peculiar to the Alexandra Park Show, but exists to a greater or less extent at all.

GRAPES.—The great attraction of the fruit show was the Grapes, and especially the Black Hamburgs from Mr. Meredith, and the Black Prince from Mr. Hill. For three dishes of distinct varieties, Mr. Meredith was first with Trentham Black, Black Hamburg, and Victoria Hamburg, and these, it is almost unnecessary to say, were remarkably fine. Mr. Embery was second; and Mr. A. Fowler, Castle Kennedy, third, with Golden Hamburg, Wilmot's Dutch Hamburg, and Champion Hamburg, also very fine. In Black Hamburgs Mr. Meredith was again first with bunches such as he usually exhibits, and that is the best praise; Mr. Hyde, Waltham Cross, and Mr. Sawkins, were equal second; their bunches being also very fine, as, indeed, were most of those exhibited, and particularly those from Mr. Fowler and Mr. Turner. For Black Prince, Mr. Hill had the first prize in the Any variety class. Some excellent boxes of Black Hamburgs were likewise shown by Messrs. Meredith, Woolley, Henderson, and Rochford; and Pope's Hamburg by Mr. Fowler. In Muscats, Mr. Turner was first, and Mr. Hayes, Oak Hill, second, with fine bunches. Of other white kinds, some fine bunches of Golden Hamburgs came from Mr. Fowler, Buckland Sweetwater from Mr. Hill, and good Chasselas Musqué from Mr. Bland, Hendon. For the best-flavoured black Grape of any kind, Messrs. Meredith, Weir, and Wallis, were respectively first, second, and third with Black Hamburgs. In addition to the above, the new Duchess of Buccleuch was shown by Mr. W. Thomson; the bunch, 1 lb. in weight, had been produced by a pot Vine started in January, and was considered by the Judges to have a fine Frontignan flavour. Collections of Grapes, with particulars of cultivation, were exhibited by Mr. A. Henderson, who was first, and Mr. Meredith who was second, with seventeen kinds; also by Messrs. Lane. Mr. Henderson's were Golden Hamburg, West St. Peter's, Chavoush, Buckland Sweetwater, Frankenthal, Muscat and Victoria Hamburg, Pope's Hamburg, Mill Hill Hamburg, Chaptal, Black Prince, Muscat Hâtif de Saumur, Royal Muscadine, and Foster's Seedling. Mr. Meredith had of kinds not already named, Black Hamburg, Muscat of Alexandria, Bowood Muscat, Amber Cluster, White Frontignan, Purple Constantia, Trentham Black, Lady Downe's,

and Dutch Hamburg. It may be interesting to know how Mr. Meredith succeeds in producing such fine black Grapes, we therefore subjoin the mode of treatment which he adopted with those shown in this collection. The Black Hamburgs were "cut from a Vine planted in June, 1857, whilst the Vines were in a growing state. The bottom of the border is concreted; on this there is about 1 foot of rubble, and on the top of the rubble and concrete is placed the composition for transplanting in, which consists of brown turfy loam three parts, and bone dust, oyster shells, and brick rubbish one part, all well mixed together. The depth of the border is from 2 feet 6 inches to 2 feet 9 inches, and the width 16 feet. All the Black Hamburg varieties were grown in a span-roofed house, and started at Christmas. They were kept at a temperature of 50° at night, and 55° to 60° in the day, with a little air on the top-lights, and at the end of the first month I allowed the temperature to rise both day and night 5° higher in sunny weather. The temperature was allowed to rise in the daytime to from 65° to 90°, taking care to have plenty of moisture in the atmosphere. At the end of the second month the house was kept at from 65° to 70° at night, and from 75° to 90° in the day, with air according to circumstances."

PEACHES AND NECTARINES were generally of large size and well ripened. In the class for Peaches, two dishes, Mr. Ford was first with *Violette Hâtive* and *Early Newington*; Mr. Allen, Withington Hall, second with *Noblesse* and *Bellegarde*; Mr. Sage, Ashridge, third with *Royal George* and *Violette Hâtive*, Mr. Hill taking an equal third. All of the above were fine. In single dishes, Mr. Ford was first with *Early Newington*; Mr. Brown, Fawsley Park, second with *Noblesse*; and Mr. McLellan, Barnet, third with *Royal George*. Some very good examples of the above kinds were also shown by other exhibitors. Of Nectarines, the principal kinds shown were *Elrue* and *Violette Hâtive*. For two dishes, Mr. Allen was first, Mr. Masters second, Mr. Dawson and Mr. Hill third. In single dishes, Mr. Brown, Fawsley, was first with finely-coloured *Violette Hâtive*.

MISCELLANEOUS.—Melons were rather numerous. In Green-fleshed kinds, Mr. Sawkins was first with *Marquis of Ailsa*; Mr. Meredith second with his *Hybrid Cashmere*. Windsor Prize from Mr. Martin was first in the Scarlet-fleshed class. Of Cherries, *Elton*, *May Duke*, and *Black Tartarian* were shown in good condition, the last-named, from Mr. Henderson, being very fine. In Strawberries, *Empress Eugénie*, *Sir C. Napier*, and *Admiral Dundas* from Mr. Kaile, were first; *Marguerite*, *Oscar*, and *President* from Mr. Turner, second. Some good dishes of *Brown Turkey Figs* were also shown, Apples in good preservation by Mr. Earley, *Rabley Cucumber* by Mr. Monro, Orchard-house trees by Mr. Fraser and Messrs. Lane, the latter also having Vines in pots loaded with fine bunches.

FLORISTS' FLOWERS.

NOTWITHSTANDING that the Brighton Show was held on the same day, and that Rugby had held her first great gathering in honour of the queen of flowers the day before, there was a goodly muster of florists and a goodly display of their productions. *Pelargoniums*, although not numerous, were in good condition; and cut *Roses* were very fine, affording a proof of what I believe to be the fact, that the *Rose* this season is in admirable condition, the flowers being most of them true to character, as was naturally to be expected at this advanced season. *Pot Roses* were past their prime; while in other florist's flowers, such as *Pinks*, *Carnations*, and *Pansies*, some very creditable stands were staged. Nothing could have been more liberal than the scale of prizes; and notwithstanding that the ground is quite new, I have very little doubt that ultimately the *Alexandra Park Show* will be one of the most popular of our metropolitan shows.

The cut *Roses* exhibited by Messrs. Paul & Son, W. Paul, and Turner were very fine indeed, and their freshness and beauty attracted many admirers. In the Class for fifty single blooms Messrs. Paul & Son were first with a stand which contained some wonderfully fine examples of the following among others:—*La Brillante*, *Vicomte Vigier*, *Triomphe de Rennes* (very fine), *François Lacharme*, *Alphonse Damaizin*, *Baron Gonnella* (a wonderful bloom), *Devoniensis* (very fine), *Madame Valembourg*, *Madame Vidot*, *Lord Clyde*

(very fine), *Narcisse*, *Souvenir d'un Ami*, *Comtesse de Chabillant*, and *Hamlet*. In Mr. C. Turner's, which was second, were *Souvenir de Comte Cavour* (very fine), *Maurice Bernhardt* (excellent), *Souvenir de la Malmaison*, *Cloth of Gold* (fine), *Baron de Rothschild* (good), *Niphetos*, *Celine Forestier*, and *Olivier Delhomme*. Mr. Wm. Paul was third, and had good blooms of *Triomphe de Caen*, *Triomphe d'Amiens*, *Catherine Guillot*, *Virginal*, *Le Rhone*, *Maurice Bernhardt*, *Madame Furtado*, *Beauty of Waltham*, &c.

In the Class of 24's, three trusses of each variety, Messrs. Paul & Son were again first with *Madame Knorr*, *Lord Clyde* (most excellent), *Gloire de Dijon*, *John Hopper* (very fine), *Madame Boutin* (open at the eye), *Mdlle. Bonnaire*, *Caroline de Sansal*, *Baron Adolphe de Rothschild*, *La Ville de St. Denis*, *Celine Forestier*, *Catherine Guillot*, *Prince Camille de Rohan* (very dark), *Madame Caillat* (very fine), *Maurice Bernhardt*, *Souvenir de Beranger*, *Olivier Delhomme*, *Triomphe de Rennes* (very fine), and *Amiral Gravina*. Mr. Wm. Paul was second. His flowers were *Caroline de Sansal*, *Oderic Vital*, *Turenne*, *Senateur Vaisse*, *Madame Hector Jacquin*, *Duc de Rohan* (very fine), *Duchesse d'Orleans*, *Madame Boll*, *Le Rhone*, *Catherine Guillot*, *Comte de Nanteuil*, *Maréchal Vaillant* (good), *Gloire de Vitry*, *Charles Lefebvre* (excellent), *Virginal*, *La Brillante*, *Victor Verdier*, *Général Jacqueminot*, and *Beauty of Waltham*. Mr. Turner was third, and amongst his blooms were good examples of *Vicomte Vigier*, *Louis XIV.*, *François Lacharme*, *Madame Bravy*, and *Souvenir de Comte Cavour*.

The *Amateurs' Roses* looked, generally speaking, poor after the above brilliant specimens, but contained some fine blooms. There is but little use in detailing the lists of names. I would, therefore, only mention those flowers which strike me as good. In the *Rev. V. Knox Child's*, who took first prize, were good flowers of *Cloth of Gold*, *Paul Ricaut*, *Gloire de Dijon*, *Anna de Diesbach*, *Senateur Vaisse*, and *Souvenir de la Malmaison*. Mr. Sawkins, gardener to G. Brassey, Esq., was second. His best flowers were *Senateur Vaisse*, *Louis XIV.*, *Prince Camille de Rohan*, *Madame Vidot*, *John Hopper*, and *Madame Crapelet*. Mr. Moffat was third. *Senateur Vaisse*, *Anna de Diesbach*, *Louise de Savoie*, and *Celine Forestier* were his best flowers.

Mr. Corp, of *Salisbury*, was first in 18's. The most noticeable of his flowers were *Senateur Vaisse*, *Mdlle. Bonnaire*, *Celine Forestier*, *Charles Lefebvre*, *Madame Knorr*, *Charles Lawson*, and *La Brillante*. Mr. A. Moffat was second with *Senateur Vaisse*, *Isabella Gray* (good), *Celine Forestier*, *Gloire de Dijon*, and *Comtesse de Chabillant*.

Roses in pots were shown by Mr. W. Paul amongst *Nurserymen*, and Mr. Terry amongst *Amateurs*. Mr. Paul's consisted of *Juno*, *Homer*, *Paul Ricaut*, *Souvenir d'un Ami*, *Lalia*, *Jules Margottin*, *Comtesse de Barbantanne*, *Lord Raglan*, *Paul Perras*, *Madame Damaizin*, *Marquise de Foucauld*, and *Madame Willermot*, and were good considering the advanced season.

Messrs. Paul & Son had a collection of 18 new *Roses* in pots; amongst them *Le Rhone*, *Alba Rosea*, *Baron de Rothschild*, *Alfred de Rougemont*, *Paul Delameilleray* were good, but I hope to see more of these in the boxes of new *Roses* at the *Crystal Palace*.

The exhibition of *Pelargoniums* was small, only one exhibitor showing in each Class—Mr. Fraser in large varieties and *Fancies*; and Mr. Wiggins, gardener to W. Beck, Esq., amongst *Amateurs*. Mr. Fraser's comprised good plants of *Mer Polaire* (a French variety), *Rosa Bonheur*, *Lillie*, *Sir C. Campbell*, *Lord Clyde*, *Norma*, *Fairest of the Fair*, *Osiris*, and *Sanspareil*. Mr. Wiggins had *Leviathan*, *Mira*, *Lord Clyde* (a good plant), *Rembrandt*, and *Lady Taunton*.

Mr. Fraser's *Fancies* were *Musjid*, *Celestial*, *Delicatum*, *Sarah Turner*, *Madame Rougière*, *Cloth of Silver*, *Hebe*, and *Undine*.

Several good stands of *Pinks* were shown, Mr. Turner's, however, far exceeding in size and beauty any of the others exhibited. These were the *Rev. George Jeans*, *Lizzie*, *Bertram*, *Dr. Maclean*, *Devise*, *Excellent*, *Mrs. Norman*, *Elcho*, *Blondin*, *Beauty of Bath*, *Picturata*, &c. These flowers were marvels of cultivation, and were greatly admired. Mr. Hooper, of Bath, was second.

Mr. Turner had also a fine stand of *Carnations*, amongst them *Favourite*, *Flora's Garland*, (a fine old flower, still

unsurpassed), Mayor of Nottingham, Rose of Spain, Rose of Castille, Miss Eaton, Squire Town, &c.

Several stands of Pansies were also exhibited, the best being that of Messrs. Downie, Laird, & Laing, which contained some splendid blooms. Amongst them were Mary Lamb, Countess of Rosslyn, Ladyburn Beauty, Lady Lucy Dundas, Prince of Wales, Le Roi, Eclat, Wm. Spier, Cherub. Nothing could have been smoother and more beautiful in texture than these were. Mr. Hooper, of Bath, was second.

Amongst the objects of interest were some varieties of Verbenas hybridised with *Verbena venosa*, raised by Mr. Wills, gardener, Tarporley, which are the forerunners of a new race, more hardy and enduring than those we now have.

In Table Decorations there were not many competitors. Mrs. James Cutbush was first. Her centre piece was perfect: it consisted of a glass dish with rod, and a small dish at top with four pendants. The bottom dish contained Grapes in the centre, White Water Lilies all round, and an outside border of bright Roses; a Pine Apple was in the centre of the top, and Maiden-hair Ferns interspersed amongst the flowers. The side stages were not so effective; but I think that the same excellent taste which arranged the first could be well able to get rid of the poverty of the side stands. Miss Williams was second with a nice set of Miss March's stands; and Mr. Hill, of Highgate, third.

In Hanging Baskets Mr. Cutbush was first, Mr. A. Henderson, of Pine-Apple Place, second, and Mr. Williams, of Holloway, third. These were all tastefully arranged with Fuchsias, Caladiums, Calceolarias, Geraniums, and other ornamental plants. In Three Vases Mr. Cutbush was again first, and Mr. Williams second. Both were well arranged, and reflected credit on the taste of the exhibitors; in fact a great impulse has been given to decorative art in all ways; and there is no reason why, with all the powers at our command, we should not equal our neighbours across the water.—D., Deal.

CRYSTAL PALACE ROSE SHOW.—JUNE 25.

SUBJOINED is a list of the principal prizes awarded, and a full report of the Exhibition will be given in our next issue. Classes 1 to 6 inclusive were for growers for sale, and in these the competition was very close. The Amateurs' Classes were not so well filled as we have seen in previous years as regards numbers.

In Class 1, ninety-six varieties, one truss of each, Messrs. Paul & Son were first; Mr. Mitchell, Piltown Nurseries, Maresfield, second; Mr. W. Paul, third; Mr. Cant, Colchester, fourth; and Mr. Keynes, Salisbury, fifth.

In Class 2, forty-eight varieties, three trusses of each, Mr. Cant was first; Mr. Turner, second; Messrs. Paul & Son, third; Mr. W. Paul, fourth; and Mr. Keynes, fifth.

In Class 3, twenty-four varieties, three trusses of each, Mr. Turner was first; Messrs. Paul & Son, second; Mr. J. Fraser, Lea Bridge, third; Mr. Keynes, fourth; and Mr. Cant, fifth.

In Class 4, one truss of twenty-four varieties, Mr. Keynes was first; Mr. Turner, second; Mr. Stacey, Great Dunmow, third; Mr. Walker, Thame, fourth; and Mr. Clarke, Brixton Hill, fifth.

In Class 5, twelve varieties, one truss of each, Mr. Keynes was first; Mr. Turner, second; Mr. Walker, third; Mr. Gosling, fourth; and Mr. Stacey, fifth.

In Class 6, thirty-six varieties, one truss of each, Mr. Hedge, Reed Hall, Colchester, was first; Mr. Ingle, gardener to C. Round, Esq., Colchester, second; Mr. A. Moffatt, gardener to Viscount Maynard, Dunmow, third; Mr. Worthington, Caversham Priory, Reading, fourth; and Mr. Exell, gardener to J. Hollingworth, Esq., Maidstone, fifth.

In Class 7, twenty-four varieties, one truss of each, Mr. Hedge was first; Mr. Evans, gardener to C. Newdegate, Esq., M.P., Nuneaton, second; Mr. Moffatt, third; Mr. Mould, Marlborough, fourth; and Mr. Exell, fifth.

In Class 8, eighteen varieties, one truss of each, Mr. Hedge was first; Mr. Plester, second; the Rev. H. Dombrain, Deal, third; the Rev. V. Child, Little Easton, fourth; and Mr. Marcham, Hanwell, fifth.

In Class 9, twelve varieties, one truss of each, Mr. Hedge

was first; Mr. R. B. Postans, Brentwood, second; Mr. Brown, Elmton Hall, third; Mr. Wright, Twickenham, fourth.

Class 10 was for the best collection of new Roses of 1862 and 1863. Here Mr. W. Paul was first; Mr. Keynes, second; and Messrs. Paul & Son, third.

Class 11 was thirty trusses in a vase or ornamental stand for table decoration. Mr. Ingle, gardener to C. Round, Esq., Colchester, was first; Mr. Hedge, second; Mr. G. Marlew, Cromwell House, Mortlake, third.

For Roses in pots, Mr. W. Paul had the first prize for those in pots exceeding 8 inches in diameter, and second prize for a collection in eight-inch pots; Messrs. Paul & Son being first, and Mr. Turner third.

ORCHARD-HOUSES.

I HAVE neglected answering Mr. Abbey's letter of May 24th, because he appeared to doubt my statement that 2700 Peaches and Nectarines were produced in an unheated orchard-house, the whereabouts of this house being left, he says, to the imagination. Now, if he will refer to your last year's volume, he will see the name and address was given, and the fact stated that a chess club was invited by the owner to a Peach feast. This account was written when most of the fruit was on the trees. Before answering Mr. Abbey's letter I was anxious to see the gentleman and ask his permission to give the size of the house, and also if I were right as to the number. Well, for Mr. Abbey's satisfaction, I have to state that the house is at Lenton near Nottingham, the owner is M. Brown, Esq., that the house is 55 feet by 15, and that the number was correctly given. Though I was not amongst the number of gentlemen who took the trouble to count them I did help to eat them, and never saw or tasted better. Mr. Brown kindly permits me to say he will be most happy to let Mr. Abbey see for himself this year, and hopes to show him as good a crop.

I really do not think it necessary to say much in reply to the rest of the letter, but I may say I never had to refer a failure to bad tools; men who have made good work with inferior tools are not precluded from getting better. My first house was 60 feet by 20, and it gave me the ambition to build one 90 feet by 30. I only wish it were twice as large. "My Hints" do not exhibit any traces of being written by one who had never grown a tree in a pot." This is complimentary, but not to the point. My remark was that when "our house was first erected, we had no man on the grounds who had ever grown a fruit tree in a pot, and yet we had a good crop of Peaches and Nectarines the first year." The "Hints" were written after some years of success.

With regard to the physiological argument it is quite beyond my comprehension. "Light is the great agent in the maturation of fruit." "Glass diminishes light." "Heat is to be diminished in sunless weather"—*ergo*, Peaches cannot be so good in a glass house as out of doors. I cannot see the application of this, for it would appear to me to point rather to the conclusion that artificial heat ought not to be given to plants under glass. We do not build orchard-houses to increase the light but to retain the heat (very rarely sufficient to ripen Peaches on open walls), and also to protect the trees in winter and spring.

Well, after all, we ought to rejoice that Mr. Abbey has made one step in advance. We are now asked to assent to the proposition that an unheated wall covered with glass is better than an unheated orchard-house—in other words, that a lean-to orchard-house is better than a span-roofed orchard-house, which, if the latter be one such as Mr. Abbey built with boarded sides and sunk paths, I have great pleasure in admitting, but this is a very different affair from his advocacy of uncovered heated walls.

There is an old saying that

"A man convinced against his will
Is of the same opinion still,"

which, like a great many old sayings, is only partially true. A man beaten in an argument may, perhaps, not admit it, but when the subject is next discussed he will probably change his ground if not his side. We have got Mr. Abbey to covering his Peaches with glass, though according to his argument they must be bad, the light being diminished, and if he puts artificial heat into such a house he will only make

matters worse; but let us hope for the best, and trust his Peach trees will not be so ungrateful.

In conclusion, if he will pay me a visit he shall taste how glass has injured my fruit by its deleterious shade.—J. R. PEARSON, *Chilwell*.

PRINCESS OF WALES STRAWBERRY.

LAST year I sent you a box of the fruit of my seedling Strawberry Princess of Wales, which was damaged in the transit; I now send a few fruit of it packed in leaves trusting they will arrive safely, and I should be obliged for your opinion in THE JOURNAL OF HORTICULTURE. It is much earlier than any other variety. Last year I gathered from the open border on the 22nd of May, this year on the 24th of May.—B. W. KNIGHT.

[Judging from the fruit received, this is a variety of large size, and cockscomb shape very much corrugated. The colour is bright red uniformly all over, there being no green points; the seeds are pretty deeply imbedded. The flesh is solid, tinged with orange red, very tender and juicy, the juice having a rich sprightly pine flavour. It appears to belong to the British Queen race, though higher in colour than that variety. Perhaps a not incorrect description might be to say it is between British Queen and Sir Charles Napier.

It is a remarkable coincidence that at the same time we received the fruit of Princess of Wales from Mr. Knight, we also received from Messrs. James Carter & Co. specimens of a sort raised by Mr. John S. Hedderly, of Swinton, Nottinghamshire, which is so similar as not to be distinguishable. Mr. Hedderly also sent a scape full of fruit, and from that we may judge that his is a most abundant bearer. He further states that his produces a second and a later crop, so late that it would require protection to ripen it. These two should be grown together to ascertain wherein they really do differ.—H.]

NOTES FROM PARIS, 1864.

ROSES.

THE thunderstorm that burst over Paris on Monday the 13th inst. considerably deranged my plans and wishes with regard to reporting on Roses. I had planned that day for my visit to Bourg-la-Reine; but when I saw the rain literally coming down in sheets of water, I felt that not only for that day was my journey at an end, but that even if it cleared up the Roses would be considerably damaged, and there is no place so conveniently situated as my excellent friend M. Margottin's for seeing Roses near Paris. M. Charles Verdier's nurseries are at Vitry, M. Eugène Verdier's at Brie, M. Leveque's outside of Paris somewhere, but Margottin's you can easily reach in a quarter of an hour by train; besides, I regard him as the best Rose-grower and the best judge of Roses that I have met with in France. I know nothing of the Lyons men; but Guillot and Lacharme ought to be men worth knowing, as they have given us some notable flowers, and without at all depreciating those that I do know Roses have been Margottin's almost-sole study for these thirty or forty years. He knows their history, their parentage, the year of their birth, and speaks of them as one to whom they are not merely acquaintances but intimates.

Probably the first question which the lover of Roses would put is, Is there anything new of great merit? As far as the Paris growers are concerned I should say there are some good Roses, but I am not sure that there is anything of transcendent merit. Margottin has one to send out, and perhaps two, but this is uncertain; Charles Verdier, two of his own raising; Leveque, two; and Eugène Verdier, six; but of this more anon. I saw also some of the Roses of last season in good condition. There is not that difference in time of bloom in Paris and the south of England that I imagined; at least this has to be noted, that in nurseries where the bloom is mostly from young stock, and the plants have been cut back very much, the bloom is considerably later than in older plants. The roseries at St. Germain in the fine old Palace grounds, which are very extensive, were

in full bloom and presented a grand appearance; so were the Roses in the Tuileries and other public gardens; so were the older plants in M. E. Verdier's Paris garden; but in Margottin's, where they were nearly all young and vigorous plants, the bloom was not much more forward than in my own garden. But this year the weather was so much cooler than usual, that on dining with an English friend on the 11th we had a fire in the drawing-room in the evening, so that in ordinary seasons they would have been in full bloom. I should say, however, than from the 15th to the 20th of June is about the best time to see Roses in Paris.

There is another fact which I have ascertained by my visits—namely, that we are much better able to arrive at the merits of new Roses—I mean those of the previous season—in England than they are in France, and so all the growers whom I have met with said. The many prizes which are offered for new Roses, and the more enterprising character of our large growers for sale, together with their greater amount of means, which allows of their having plants without continually cutting from them for stock, enables them to do this. A French Rose-grower obtains a few of each new variety, and his main object is to propagate. Hence they are continually cut—cut for grafting, cut for budding, cut for plants on their own roots, and thus no fair opportunity of judging of their merits is given. An English Rose-grower for sale, on the other hand, keeps one or more of his imported plants for the purpose of growing blooms for the stands of new Roses for which prizes are offered. Of this I am perfectly certain, as, indeed, all the best growers stated to me, that we cannot until the second season judge of Roses here. How many persons, like myself, were disappointed in John Hopper last year; but this year what a Rose it is! I have a bloom now before me out of my own garden which measures 4 inches across, full, and beautiful in colour, and splendidly built up—in fact a perfect gem; and it is a great comfort to me who have recommended this as the best English Rose raised since Devonensis, that it is as highly thought of across the water as it is here, both the Verdiers and Margottin speaking of it in the highest terms.

I am glad to say that the conviction is forcing itself upon French growers that we are overdone with Roses of the Jacqueminot race, and that what is wanted is more of novelty. Formerly, before the advent of the Général, Roses of the crimson and red shade were few in number; but since his introduction, and the fact of his seeding so freely, we have been inundated with them. And it may well be asked whether we can get anything to beat that magnificent Rose Charles Lefebvre. I am tolerably certain I have not seen any of last year that will do so, and nothing of the forthcoming Roses will, I fancy. While on this point I may mention having seen at Leveque's some very fine blooms of a Rose let out by him last year—Madame Derreulx Douvillé, which is, I think an acquisition. It is a tender Rose, with an inclination on the edge of the petals to a lighter shade approaching white. It is of a good shade of colour, and has novelty to recommend it.

As these few notes are written towards the close of the week, and I can therefore only claim a small space, I must defer some further remarks on "Rose lore" until next week.—D., *Deal*.

TODMORDEN BOTANICAL SOCIETY.—Monthly meeting, Monday, June 6th—the President, Mr. Stansfield, in the chair. Mr. T. W. Stott, of Todmorden, was elected a member. The table was strewed with quite a multitude of specimens of the rarer plants in flower at this season, as well exotic as British. Amongst the latter was the interesting Fly Orchis (*Ophrys muscifera*), recently collected by the President and Vice-President while on the Ingleton excursion. The same journey yielded the beautiful and much-prized British Orchid *Cypripedium calceolus*, so seldom found wild in this part of Yorkshire, and other interesting flowering plants peculiar to the limestone. Among Ferns, several good varieties of the Hart's-tongue Fern were met with, including *Scolopendrium vulgare*, *vars. fissum*, *Malcomsoni*, *multifidum*, and *variabile*. *Hypnum giganteum* and several other notable cryptogams were likewise found. Mr. Nowell gave a highly interesting

account of the late excursion, not by any means confining himself to a bare record of "finds," but dwelling in humorous language on the incidents and accidents (often amusing) attending the journey. Visits to out-of-the-way nooks, where the "old ways" prevail, are refreshing enough. Mr. Nowell spoke of gathering *Hypnum giganteum* remarkably fine. Work voted in: "The Naturalist," a Yorkshire periodical recently established, and published at Huddersfield fortnightly.

CULTIVATION OF THE MELON.

PROBABLY more has been written on the culture of the Melon than on that of any other fruit, and yet no two persons recommend or follow the same system. Abercrombie, in the last century, goes into the cultivation of the Melon on dung hotbeds with a minuteness that certainly is fatiguing, and others since his time have laboured much to elucidate the subject; yet there still remains much information to be wished for as to the culture of this fruit by those who do not follow gardening as a profession, and who have not, therefore, had the benefit of regular instruction by those who have grown the Melon all their lives. There are some, however, such as "PATELIN," who need no instruction, and are able of themselves to do without the assistance of others. It is not to enlighten these, nor because I have anything specific to recommend, that I at present undertake to put on paper a few notes on the cultivation of this delicious and highly-perfumed fruit, but because I hope that the subject will prove interesting to the readers of this Journal generally, and useful to many who have not had opportunities of obtaining a practical knowledge of Melon culture.

Melons were formerly in greater repute than at the present time, and it was not uncommon to see more than one market gardener near London with three or four hundred lights of Melons. Now, however, but few are grown for the market, except it be early in the season, the chief supply of this fruit being imported; but such fruit is in no wise equal to that grown at home, the flavour being little better than that of a Gourd—in fact, I consider the large yellow Gourd (of which I once had one 117 lbs. in weight, and 8 feet 1 inch in circumference), kept in a Pine-stove or other dry warm place, cut and eaten like a Melon, quite equal to the very best of the imported Melons, or those huge pumpkin-like insipid kinds of our own growth.

The Melon came originally to this country from the West Indies (Jamaica), and was cultivated here as long since as 1570. It is an annual trailer, or rather climber if supports are provided for the tendrils to cling to. It is raised, also, occasionally from cuttings, and such plants come into bearing much earlier than those raised from seed, but like all true annuals it cannot be perpetuated by cuttings from year to year, for every time cuttings are taken the plants raised are weaker, and gradually die out. I have tried this mode of treatment, and have succeeded in keeping the plants over the winter, but the result obtained was most unsatisfactory; had I succeeded, my intention was to obtain fruit much earlier than it can be had from seed, and to keep the stock of a particular kind pure. This I have found next to impossible to do from seed, as from the seed of a Melon I have had fruit no more like the original than a Kidney Bean resembles a Windsor Broad Bean. The only kinds that I have found come true to name, and these not always, are the old Egyptian, the Beechwood, and the Early Cantaloupe. Most of the others, though true to name when first received, had the flowers so impregnated by insects with the pollen of other kinds that scarcely a seed in a whole Melon produced a plant yielding fruit the same as the parent, or it may be that plants much cross-bred are liable to sport, even though not impregnated with the pollen of another kind. Those who wish to keep the stock of any kind pure for a length of time must take care to prevent cross-impregnation being effected by natural agents, and protect the flower by enclosing it in a thin gauze bag, and set the bloom artificially. I am not quite certain that this care will keep the kind true; in fact, I know it will not do so for a lengthened period.

Of the many different modes of cultivating Melons on dung hotbeds in frames or pits, in pits with tanks for bottom heat, and hot-water pipes for top heat, and in houses with top and bottom heat supplied through hot-water pipes,

I propose to treat separately, and as the first-named is the oldest, and most generally adopted system even at the present time, I will take it first.

MELONS IN FRAMES.

DUNG-HEATED BED—BED FOR SEEDLINGS.—Where dung is at hand, appearances not studied, or the Melon-ground separated by a hedge from the remainder of the garden, I am confident that there is no better mode of supplying the heat than an ordinary dung-bed. Stable-manure, fresh, if possible, or such as is not old and done fermenting, should be in readiness a fortnight before it is wanted for making the hotbed, and it should be turned over every four days for a fortnight, shaking it each time and mixing it well together, putting the outside inside, and sprinkling it with water where it is heated too much or dry. If it is very strawy, watering or wetting it with liquid manure containing a large percentage of urine will much improve the heating qualities of the dung. This having been done three or four times the materials will be equally mixed throughout, and be in a fit state for piling up to form a hotbed. Having marked out a space 1 foot wider all round than the frame, put a thin layer of the hot dung on the place, shaking it well and evenly over the area, and beat it down with the fork, but do not tread it, for that is apt to make the heat rise unevenly. Continue to place layer upon layer in the same manner, doing it neatly, and keeping the sides perpendicular and firm until the required height has been reached. This height depends on the time of year; if the bed is for a one-light box to raise plants for planting out it should be 3 feet 6 inches high for sowings in February, 3 feet for those in March, and 2 feet 6 inches for those later in the season. For beds to receive the plants sown in February the height should be 4½ feet, in April 4 feet, and afterwards 3½ feet. These beds should be prepared in the same way as that for raising the plants, and the time to commence preparing the dung for the fruiting-beds is when the seed is sown; and if turned over frequently for a fortnight and then formed into a bed, it will be in proper order to receive the plants by the time they are ready for planting out, or a month after sowing, more or less according to the weather. When the bed is made put on the frame and lights, and thrust a stick into the bed from the outside, far enough in to reach the centre; in about a week or so draw this out, and ascertain the condition of the bed as regards heat by tightly clasp the end of the stick in the left hand, and if the heat be not more than the hand can bear place a couple of inches of soil over the bed inside the frame; as this is only to prevent too much heat and steam rising it is immaterial what kind it be, only it should be in a moderately dry condition. If, on the other hand, the heat is greater than the hand can bear, and the steam within the bed strong, draw down the lights a little to allow the steam to pass off, and defer sowing the seed or placing soil on the bed until such time as the heat is reduced to the proper pitch, which may readily be ascertained by daily examination of the proof or watch stick. If this be considered an undesirable mode of testing the heat, a surer and more cleanly method is to have a thermometer with the bulb 1 foot below the surface, and when this reads from 90° to 100° there is no danger, and the seeds may safely be sown and placed in the frame, plunging the pots to one-half their depth at first, but when the heat declines to 85° or 90° they may be plunged to the rim.

SOILING.—The soil in which the seeds are sown may consist of any rich, strong loam. Three or four seeds should be placed round a 60-sized pot, covered lightly with soil, especially if the seed is old, and afterwards kept moist with water of the same temperature as the frame. The time of sowing depends on what time the fruit is wanted to be ripe. If seed be sown in February, fruit may be expected in the latter part of May, or from that to the middle of June; if in March, the fruit will be ripe in July and beginning of August; if in April, fruit may be expected in the end of August and beginning of September; and if in May, in September and the beginning of October, supposing in each case the seed to be sown in the beginning of the month. The age of the seed also exerts a great influence on the time of ripening, growth, and fruitfulness of the plants. New seed produces the strongest plants, but for general purposes it is preferable to sow seed two or three years old. For very early

sowings I like old seed; but, generally speaking, I prefer the seed three years old, as the plants come strong; and though they do not fruit so soon as those from older seed, yet they are more capable of enduring hardships, and generally make a good growth before they show fruit, which is desirable to insure this being fine.

SEEDLINGS.—The seeds being sown, we will say, in the first week in February, three in a small pot, either in a Cucumber-frame already at work, or in a one-light box provided on purpose, and having a bottom heat of from 85° to 90°, and a top heat of from 75° to 85° when the seed is sown, the seedlings will be up in a week. Water should be given very sparingly, as the moist heat and steam of the bed is almost enough for them at this early stage; but should the soil become dry, a little tepid water must be supplied them in the middle of the day, so that the opening of the frame may not expose the plants to cold air. During sunshine a little fresh air should be admitted by tilting the back of the lights, but not so as to reduce the temperature within the frame, nor must air be left on too long. It should be given early with the ascending sun, and the frame shut up with sufficient sun heat to maintain the temperature at a maximum for a considerable part of the afternoon. At all times advantage should be taken of a fine day and mild weather to admit fresh air, even if it be but for an hour, for strong, healthy, short-jointed plants are thus insured; whilst a close, moist atmosphere causes unhealthy growth and long-jointed plants, which never afford fruit of any value.

MAINTAINING THE HEAT.—When the night temperature falls below 70°, a covering of mats should be placed over the frame, one thickness at first, but two or more after the heat is reduced considerably, varying in thickness according to the mildness or severity of the weather. On mild nights without frost one mat, on frosty nights two mats, and on severe frosty nights three mats, will in most cases be sufficient covering. The bed should be lined after it has been made a week by placing some hot dung round the sides of the frame; and this lining should be covered with some long straw litter, so that heavy rains will be to a certain extent kept out, and a uniform heat maintained. The lining will need renewing every week or ten days during the early part of the year, but later in the season every ten days or a fortnight will be sufficient. Care must be taken after applying the linings not to allow the covering material to hang over or upon them, for the heat if at all rank will in that case pass into the frame, and destroy the plants. It is also important to put on the covering in such a way that it cannot be blown off, and in the afternoon before the heat is much reduced, so as to maintain a brisk growing heat during the night, and to remove it in the morning by eight o'clock, earlier or later, according to the time of year and the weather. In dull but mild weather the covering should be put on rather later, and taken off sooner; but in cold weather it should be put on soon, and taken off late in the morning, for the greater amount of light will elaborate the juices of the plants, whilst in dull weather a longer continuance of a diminished light is required for the assimilation of the food absorbed.

REPORTING THE SEEDLINGS.—Due care being taken in keeping up the proper temperature by renewing the linings when necessary, and having the plants strong and short jointed, by keeping them near the glass and duly supplied with water and fresh air, they should be potted when showing their rough leaves into 48's, placing them as low as possible in the pot, so that the stems may be buried deeper in the soil than they were before, and that new roots may be emitted from them freely, adding materially to the health and vigour of the plants. When these have made two rough leaves pinch out the hearts and transfer the plants into 24's, potting them both at this and the previous potting with their balls entire, which does not check the plants half so much as the usual practice of sowing thickly in a pot, and then potting the plants two or three in a pot.

BED FOR FRUITING.—By the time the plants are ready for stopping, a quantity of dung properly moistened and repeatedly turned over and mixed, should be in readiness, in order to make up a bed for a two-light or three-light frame. The bed should be made of the height, size, &c., already named, and it will be ready in about ten days to receive the plants. At the time it is made the lights and frame should be put on; and after the frame has been on a week the heat

should be ascertained, and if there is no sign of the dung heating too violently, the frame should be taken off, and the surface levelled by adding some fresh, yet sweetened dung. This done replace the frame, and put a brick under each corner; and at this period of the year the frame should be so placed that the lights may slope rapidly towards the south, that as many of the sun's rays as possible may pass into the frame, owing to the glass being nearly at right angles with the direct rays of the sun. If flat a large proportion of the sun's rays would be reflected, and drip, so baneful to the Melon at any time, would be considerably increased. Later in the season the inclination of the glass to the south is not of so much importance, an angle of 45° being the proper pitch after April, whilst 35° is preferable earlier in the season.

About ten days or a fortnight after the bed is made it will be in proper order for soiling; but as dung does not at all times heat alike, it is well to have an eye to the proving-stick, and by drawing this out daily and putting the hand to it, the heat may be determined. The proper heat is when the hand can clasp the stick comfortably, or when the heat is under 120°; but without some experience this mode of ascertaining the temperature is very unsatisfactory, and it is much better to employ a thermometer. If the readings of a thermometer with its bulb 1 foot within the bed are from 90° to 100°, the soil may safely be put on. It should not be deeper than 3 inches on the bed, nor less than 2 inches, and in the centre of each light half a barrowful of compost should be placed. This should be in a moderately dry condition, yet moist enough for the healthy ramification of roots through it. These mounds should be in the form of a cone with the top hollowed like the crater of a volcano, and twenty-four hours after they are made they will be ready to receive the plants. But to guard against accident before planting, light a candle, place it inside the frame, and cover up the frame with mats, and if the candle burn until consumed, the plants will not suffer from the vapour; but if it burn but a short time they will soon perish in an atmosphere so surcharged with obnoxious gases. Placing a candle in a frame without covering the lights is no test at all, for the laps of the glass admit sufficient air for combustion; and though the plants might exist in the frame whilst it remained uncovered, yet immediately the lights were covered they would make no progress, even if they existed, until the atmosphere became more sweet.—G. ABBEY.

(To be continued.)

SKELETONISING LEAVES.

I AM glad to find some one besides myself wishing for information about skeleton leaves, and I have no doubt we shall obtain some through the medium of your Journal. I have written to several publishers to try to obtain a work on the art, but could not meet with one.

The most perfect group of skeleton leaves I have seen was done in the following manner:—The leaves when the fibres are strongest must be put in rain water and exposed to the sun and air until they putrefy and the fleshy part will come from the fibres. The vessel must be filled up as the water evaporates. When the leaves are putrefied lay them on a white plate filled with clean water, then take off the green part. I did mine with a small brush such as house-painters use, but it must be used very gently or it will break the fibres. When they are perfectly clean they are ready for bleaching, which I think is the most difficult part. They must be put in chloride of lime and water and left in until they are as white as ivory, when they are so tender that you can scarcely touch them. When they are sufficiently bleached they must be removed from the chloride of lime and water and well washed in pure water. This must be very well done or the lime will not be removed and they will look as if they have been whitewashed, and will turn yellow in a very little time. I find the easiest way of removing them out of the lime water is by floating them on a piece of stiff note paper. I do not know the proper quantity of chloride of lime to put to the water. I put a tablespoonful of the powder, not the liquid, to a pint of water, but I do not think that is right. This method is a very slow one and requires a very large amount of patience, and I hope some one can inform me of a more expeditious mode.

The leaves of any hardwooded plant or tree will skeletonise except those which contain tannin—such as the Oak, which will not putrefy, and prevents all others it is put with from doing so. Ferns are prepared for bleaching by ironing them with a “warm” iron until all the sap is taken from them; they must be placed between two pieces of paper.—
NIL DESPERANDUM.

HEATING BY GAS.

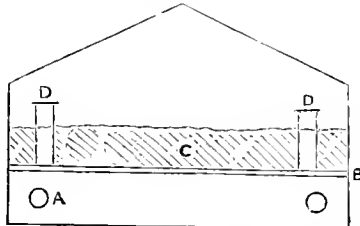

A, Pipe. B, Boards. C, Soil. D, D, Tubes with covers to increase top heat if necessary.

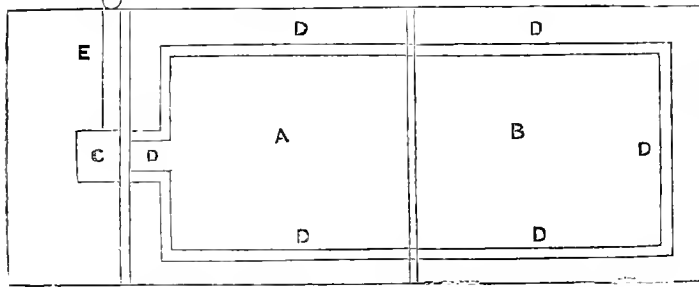

A, Warmer division. B, Cooler division. C, Tank. D, Pipes. E, Pipe to carry off products of combustion.

BUNSEN'S BURNER. HEIGHT 6 INCHES.

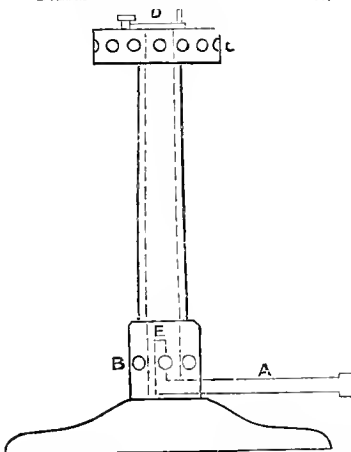

A, Gas-pipe, the jet issuing at E. B, Holes to admit excess of air. C, Apertures in the circular rim at which the gas is lighted. D, Circular lid or plate which is slid on one side when it is preferred to light the gas at the top. When the plate D closes the aperture at the top, the flame issues from the holes C in a crown, as beneath. When it is left open the flame rises in a straight jet of pale blue.

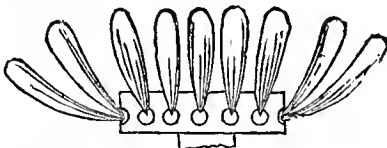

I BEG to forward particulars of the little gas-heated structure to which I referred at page 419. The length of the

house is 17 feet 6 inches, breadth 7 feet 6 inches, divided into three compartments by brickwork, the end one just large enough to hold a small open hot-water tank about 18 inches square, from which a single set of three-inch pipes runs round the whole length of the frame.

These pipes are rigged up out of “oddments” which happened to be handy. The tank is set on a little brick chamber containing the gas-burner attached by an india-rubber tube, and a zinc pipe serves to carry off the products of combustion.

The pipes are boarded over with rough two-inch boards, on which there is from 9 inches to 1 foot of soil, so that the heat is almost entirely confined to the bottom. Each compartment is provided, however, with two wooden tubes, 6 inches square, communicating between the space below the boards and the air above the soil, these being covered by wooden caps, by the removal of which more or less heat may be allowed to rise up to the surface. With a small burner consuming about 80 feet of gas in twenty-four hours (value 3d.), the temperature under the platform and also that of the soil is 80° and 75° in the two divisions respectively, and the use of a larger burner raises these figures to 119° and 100°.

Bunsen's burner is simply a contrivance by which the gas is mixed with an excess of air before it is burned so as to insure perfect combustion. It gives only a pale blue flame but intense heat. I subjoin a sketch. Were the heat applied direct by a flue or pipe instead of by hot water the economy would be far greater, and I am about to heat a small Fern-house in that manner. I will let you know the result when fully tested. For an amateur the convenience of turning on the gas in a winter's night and feeling safe till morning is immense. I hope this hint may be useful to some of your correspondents.—A. W. WILLS, Birmingham.

A PLEA FOR A COMPROMISE.

HERE we are at last in the flush of early summer! Jack Frost, pelted with Roses from the lap of June, has retired to his summer quarters in Kamschatka. He no longer scribbles on our window-panes or nips the tops of our Heliotropes and Scarlet Runners. Oceans of tender green leaves bask in the wealth of sunlight. Hedgerows, thick enough to hide birds' nests, are wreathed with Honeysuckle and Dog Rose, and mingle their odours with Meadow Sweet and new-mown hay. Everything exults in the glory of early summer but our gardens. Yes! judge for yourself sir, what can be seen save the green turf and geo-something devices inscribed thereon? Not even clinkers add their charm to the parterre—terra cotta, potted Apple trees, or even young salmon-hatchers fail to enliven the scene. Here and there it is true tiny bits of scarlet and gamboge serve to indicate the nature of the coming feast. But May, June, and July, are virtually a part of our long dreary winter. What then? Well, there are, here and there, gardens worth seeing, even in summer time—cottage gardens embowered in Roses and Honeysuckles, and the luxuriant life of new-born leaves, Lilies and Hydrangeas, Larkspurs and Stocks, Pinks, Pansies, Peonies, and a host of other beauties. Which of our boasted show gardens, with all the help that science and art can afford, vies successfully with the cottage garden in summer time? But “wait,” says the gardener, “till August (cool, certainly—wait till the bloom of summer is brushed off in the heat of the dog days, till autumn dews descend), and then see.” Well, what is our reward? Why in many cases a monstrous advertisement—a sensation garden—thousands of Scarlet Geraniums massed together in one bed between dowdy Perillas and yellow Calceolarias, hundreds of yards of ribbon-borders, pincushion-beds, and all the millinery of the establishment. In our friend the cottager's garden we have still bedding plants, but they come as valuable auxiliaries, not to supplant their honest, sturdy, and yet beautiful cousins; not as an invading army ruthlessly expelling the conquered, but as friendly volunteers standing sentry while the regulars are on furlough. Why should not such a compromise result in

our show gardens? None deny the force and beauty of colour in bedding plants; but why should they, dog-in-the-manger-like, banish entirely plants, many of them certainly more beautiful than themselves?

There are difficulties, I allow, in the management and arrangement of such mixed flower-borders; difficulties in arranging for seasons, habits, heights, and colours; but surely such provisions are a part of the legitimate functions of the intelligent gardener. There are numbers of herbaceous plants whose graceful and striking foliage and flowers are just what is required to break and distribute masses of colour, give an agreeable relief to the eye, and be sufficiently attractive to reward a close inspection. No one dreams of lingering for a moment over beds of scarlet and yellow—the (literally) imposing view of the flower gardens of great establishments to be gazed at only from the drawing-room or the terrace.

I may, if agreeable, trouble you with some further remarks on form and colour. Your obedient servant, as may be observed from his crude observations, is an amateur, but not of sensation gardens.—T. W., Harrow.

COLLETIA BICTONIENSIS.

This singular Cactus-looking shrub, which is really *Colletia cruciata*, seems not to be much known, neither am I aware that it has ever flowered. Its foliage is exceedingly scanty; but its odd-looking stems, when cut in section form a perfect cross, and are at right angles and in line with each other all over the plant. The stems are also



armed at intervals with short sharp spines, which, with the rigidity of the plant in other respects, must make it a formidable object in its native country, where it attains a tolerable size. Here it seems perfectly hardy, but its growth is slow. A plant we had some years prior to the

severe winter of 1860-61 remained unprotected every winter, but having occasion to remove it in the autumn before that memorable frost we lost it. Can any of your readers give me any further information about it? I may add that we have since obtained another plant, which has been out for the last two years without sustaining injury. Has it any affinity to the Coniferae tribe? as a shoot from near the base of the plant has all the appearance of a Juniper, but there is no bulge to indicate it has ever been worked; and yet the Furze-like appearance of this shoot differs so much from other portions of the plant that I can hardly bring myself to the belief that it is part of it. If any of your readers have had any experience with it I should feel obliged by their reporting upon it.—W. R. R.

RAISING BEDDING PLANTS WITHOUT ARTIFICIAL HEAT.

MANY gardeners and professional horticulturists will doubtless smile when they read this article, and find in it how unthought and rough are the means employed in what to them is a matter of more careful consideration—namely, propagating and keeping a few hundred bedding plants for the summer flower garden. What is about to be stated has no pretensions to novelty or originality; the keeping the stock through the winter is simply the application of a known fact to a purpose. Plants endure a low temperature much better when in a dry than in a moist or damp situation: hence it often happens that shrubs and even trees considered to be hardy, are killed by our winters if they are placed where damp generates, while others of the same species remain perfectly uninjured if planted in a well-drained soil. This principle is general: in countries near the tropics where rain seldom falls, or only falls at certain periods, it is known that the temperature during the dry season will sometimes fall (caused by the absence of clouds to counteract the rapid radiation) as low as 33° or 34° in the night without any visible effect on vegetation.

Without entering into any discussion on the acclimatisation of plants, I may state my belief that some plants naturally requiring a more even temperature than our variable climate affords, do, in the course of time, become to some extent inured to it with the aid of slight protection in severe weather. The Verbena is an instance of this; some of the varieties I have here have not had any artificial heat applied to their propagation or preservation for several years. They appear to be able to bear more neglect and to endure greater hardships than others, or even the same kinds differently treated. I am strengthened in this assertion by the opinion of one of the most intelligent of our gardeners in this neighbourhood.

One of the most important items to an amateur horticulturist is time, if he has to do his own work himself, otherwise, strictly speaking, he would scarcely be an amateur; if that is limited his case at best is a difficult one—such, however, is mine.

My mode of procedure with regard to bedding plants is this:—

I begin to propagate as soon as the plants can furnish cuttings without being disfigured by mutilation, this can be done from the middle of July. Beginning with Geraniums, I put from eight to ten cuttings in a six-inch pot, filled with the usual compost, give them a sufficient watering, place the pot on a tile or piece of board, to prevent the ingress of worms, and cover them with an empty pot of the same size. The covering of the cuttings is an essential point, no other accommodation being at hand, and they being obliged to remain out of doors; it is also more efficacious than putting them in the frame, which has a battened bottom, and which therefore renders the striking a necessity. If this be done soon enough, while the season is warm, the rooting of the cuttings is a certainty, and long before winter comes on the new plants will be well established. I proceed in like manner with Verbenas, excepting that I use five-inch pots, not that they are better, nor, perhaps, so good, but because I have many of them at hand. I put from seven to nine cuttings in a pot, being careful to select such as are not likely to have bloom on them; they strike very readily, and become well rooted during the autumn. Calceolarias and

Gazania splendens treated in the same way will also prove very tractable. As soon as it is apparent that the cuttings are taking root the covering pots are removed in the evening, provided the weather is not indicative of heavy rain, and replaced in the morning, otherwise the force of the sun would be too great for the young plants. This covering and uncovering is continued as long as may be considered necessary, and till the plants will bear complete exposure day and night. Last summer I also used four-inch pots for *Verbenas*, putting four cuttings in a pot. Of fifty pots of them I had thirty-six with all four in good health when put out, ten had three, and the other four two.

The stock is left out of doors fully exposed in all weathers, and watered when necessary till the middle or end of October, when the pots are placed in a brick frame. This frame has its sides only a single brick in thickness, but I find it useful to bank it up all round with coal ashes. The bottom is also covered with ashes firmly beaten down, and then battened about 3 inches above the surface of the ground. After the plants are housed in this frame they have to put up with a deal of neglect till the spring, the shortness of the days rendering it impossible for me to bestow the attention they require. Unless the weather during the latter part of autumn and early winter is mild, with days of sunshine, they do not receive a drop of water for months—that is, till the return of spring makes it necessary. Once or twice during that time the surface of the soil is stirred with the blade of a blunt knife, decayed leaves picked off, and every day when there is no frost or rain the lights which cover the frame are removed, leaving the plants as fully exposed as possible; but they are carefully closed in case of wet or fog, the greatest antagonist. In severe weather the lights of the frame are covered with Russian mats, doubling them according to the severity of the frost. This is the trying time for the *Geraniums*. It would be better for them to be removed into the house if circumstances permitted; but to bring them into a warm close room to be presently replaced in a cold frame is more destructive than letting them remain.

It would, probably, be much better if the plants could be potted singly in small pots in March. They would then be in better condition to bed out in May, and afford a fuller display of flowers earlier in the summer. Should these hints be followed by any of your readers, it will be decidedly better for them to do so. As I am situated it is impossible for want of time, nor do I require the bloom to make any effectual show till the end of July, about which time the first bloom of the *Roses* has gone off. As it is they remain in the pots from the moment of propagation till finally planted out, and a rough time they have of it. Let them be kept dry and not exposed to the severest weather—the covering of the glass lights and mats will do—and they live and afterwards flourish.

Of the kinds mentioned in page 419, *Verbenas* *Defiance*, *Lord Raglan*, the white and blush varieties, *Géant des Batailles*, and *Coronet* are the hardiest, with the pretty striped kind called *Impératrice Elizabeth*. Those varieties with conspicuous eyes I have had but little to do with, thinking them not so effective for massing. *Purple King* is more difficult to manage; damp weather will make havoc among the stock, however dry one may succeed in keeping the pots. I therefore put in about half as many more cuttings as I want plants. From fifty cuttings put in last August, I have had thirty-two plants to form a bed this summer—enough for the size. I intend to try *Foxhunter*, *Lord Craven*, and *Boule de Neige*. *Dundas* and *Ariosto* succeed tolerably; *Mrs. Holford*, *General Simpson*, *Firefly*, and *Lord Elgin*, are too tender, they may in time get hardened. Of *Calceolarias*, *Aurea floribunda* is first-rate, and will bear more neglect than any plant of the kind that I am acquainted with. *Amplexicaulis* is also good. Of *Geraniums*, *Tom Thumb* and *Zampa* are among the easiest to manage. I tried some of the variegated sorts some few years ago, but failed. They ought to have further trial, but I have no plants to cut from at present.

The frosts at the end of May, and on the morning of the 1st of June, had no effect on the plants mentioned in the former article; and since writing that they are fast pushing into bloom, and in a few weeks will afford the display sought for.—ADOLPHUS H. KENT, *Blechingley, Surrey*.

THE EDINBURGH BOTANICAL SOCIETY.

TWENTY-EIGHTH SESSION—EIGHTH MEETING.

The Society met on Thursday, 12th May, at the Royal Botanic Garden—Professor Balfour, President, in the chair.

The following communications were read:—

I. *Notice of Botanical Excursions in Autumn, 1863*. By Professor Balfour.—Professor Balfour gave an account of an excursion to Clova with a party of eighteen in August, 1863, and enumerated the chief plants gathered, illustrating the communication by specimens both in a living and a dried state. He also gave an account of excursions last autumn to Ben Lawers, Meal Ghyrly, Benane, Stuckachrone, and Ben Voirlich, and noticed the principal plants collected. On Benane he found *Draba rupestris*.

II. *Notice of the Principal Plants Growing in the Botanic Garden, Brisbane, Queensland*. Communicated by Mr. John Sadler.—The chief plants referred to in this communication, as being successfully cultivated in the Botanic Garden, Brisbane, were—*Aracaria Bidwilli*, *Orange*, *Mango*, *Bougainvillea spectabilis*, *Thunbergia laurifolia*, *T. Harrisii*, *Azalea*, *Camellia*, *Strawberry Tree of Ireland* (*Arbutus unedo*), *Franciscea*, *English Oak* (*Quercus robur*), *Holly* (*Ilex aquifolium*), *Bamboo*, *Olive*, *Fig*, *Magnolia*, *Rice-paper plant*, *Roses*, *Cacti*, *Banana*, *Logwood*, *Jaca*, *Teak*, *Tamarind*, *Cinnamon*, *Privet*, *Sugar Cane*, *Coffee*, *Tea*, *Tobacco*, *Ginger*, *Cinchona calisaya*, *Cotton*, *Paraguay Tea*, *Allspice*, *Arrow-root*, *Indigo*, *Gamboge*, *American Sarsaparilla*. In connection with the garden there is a good botanical library and museum.

III. *Letter from Mr. J. M'Kay, dated Madras, 28th January, 1864, to Mr. M'Nab*.—Mr. M'Kay gave an account of his journey from Southampton to Madras, noting particularly what he saw in Ceylon, and concludes:—"On the 14th of January I went to the top of the highest hill in southern India, called Dodabetta Peak. It is 8500 feet above the level of the sea. There are a small Strawberry and a large scarlet *Rhododendron* growing plentifully on the very top of the peak."

IV. *Notice of the First Horticultural Show at Petermaritzburg, Natal*. By Mr. G. M. Lowe.—The city of Petermaritzburg was taken by surprise when it was announced that a horticultural show would take place for the first time on the 21st of January. From one o'clock to five the room was crowded. In fruit, the first prizes for Pears, Apples, Peaches, &c., and an extra one for Grapes, were taken by Mr. Pistorius. Mr. M'Ken gained the first prize for Pine Apples, one of which (a large Queen Pine), was exceedingly fine; he also exhibited some specimens of tropical produce, such as the Mango, Allspice Tree, Cinnamon, &c. A sprig from the Mocha Coffee Tree, covered with berries, attracted a good share of notice, while the perfume from a Musk Melon lying near was of the most tempting nature. Some very fine Oranges and Lemons, grown in the city, were exhibited. Some Raspberries were also shown. The President showed some most tempting-looking Nectarines, and Mr. Holliday exhibited Apples and Pears produced on the same tree.

In Vegetables, the show certainly did credit to all parties, and proved most satisfactorily the capability of the soil of equalling the productions of our native land in most varieties of those table luxuries. Cornwall itself could not have shown a finer lot of Potatoes than the basket of Cornish Kidneys, for which Mr. Bale obtained a special prize; while the Cabbages, Carrots, and round Potatoes left nothing but cheapness to be desired. Dr. Mann showed some very fine Tomatoes and vegetables.

In Flowers, the show was deficient, probably owing to the shortness of the notice given of the intended exhibition. The Dahlias were a principal feature in the flower department, and the Fuchsias and double Balsams were very good.

At the close of the Exhibition a sale took place, when the Grapes fetched something like 4s. per lb., Pears 1s. 3d. each.

The following is a list of the principal fruits, flowers, and vegetables:—

FRUITS.—Grapes, Apples, Pears, Nectarines, Peaches, Bananas and Plantains, Pine Apples, Raspberries, Mangoes, Custard Apple, Rose Apple, Melon, Water Melon, Apricots, Oranges, and Lemons.

FLOWERS.—Fuchsias, Balsams, Hydrangeas, Dahlias, *Verbenas*, *Phlox Drummondii*, *Petunias*, miscellaneous plants, and wild flowers.

VEGETABLES.—Rhubarb, Peas, Beet, Cucumbers, Cabbages, Potatoes, Carrots, French Beans, Onions, Vegetable Marrow, Gourds, Radishes, Celery, Tomatoes, *Doliches sinensis*, fibre and spice plants, Coffee, fruit of *Zamia*, and *Latakia* Tobacco.

V. *Notice of a New Variety of Athyrium Filix-femina.* By Mr. John Sadler.—Mr. Sadler exhibited a living plant of a remarkably beautiful variety of the common Lady Fern (*Athyrium Filix-femina*), which had been collected by Mr. James Cosh, in 1862, by a roadside in Stirlingshire. In the spring of last year, Mr. S. had sown spores taken from the plant, some of which had germinated, but as yet exhibited none of their parent's peculiarity. A specimen had been transmitted to Mr. Moore, Chelsea Botanic Garden, who pronounced it an undescribed variety, and as the queen amongst Lady Ferns, and proposed it should be called *Victoria*. The fronds are from 10 to 18 inches in length, and crested at the apex. The pinnae are also crested, but instead of being single, as in all the other varieties, they leave the rachis in pairs, and at such an angle that each alternate pair overlap each other, so as to give a beautiful plaited appearance to the whole frond. The author was indebted to Mr. John Dawson and Mr. Paterson for specimens of the plant.

VI. *Notice of Additions to the Cryptogamic Flora of Edinburgh.* By Mr. J. Sadler.—These additions were as follow:—*Jungermannia hyalina*, *J. raparia*, *J. cordifolia*, *J. pilacea*, *J. setiformis*, *J. furcata* var. *æruginea*, *Tortula aloides*, *Grimmia orbicularis* var.—(*Scottish Gardener*.)

JOHN POWELL STRAWBERRY.

We have received from Mr. Powell, of the Royal Gardens at Frogmore, a box of a seedling Strawberry raised by Mr. Ingram, which, from its symmetry, distinctive character, colour, and general good properties, must become a standard variety. The fruit is large, long ovate, in shape not unlike Myatt's Eleanor, and not varying in any way towards a cockscomb shape. The seeds are small, and very slightly if at all embedded. The skin is bright red, somewhat between a Sir Charles Napier and Keens' Seedling, and coloured equally all over. It has a long, but not slender, glossy neck, which is quite covered with the segments of the calyx. The flesh is solid and firm, pale-coloured, very juicy, and with a sprightly, sweet, and pine-flavoured juice. It is a first-rate Strawberry.

GOOSEBERRY CATERPILLAR.

SOME time back one of your correspondents recommended Broad Beans to be planted near the Gooseberry bushes to prevent the caterpillar's ravages. As it was to be done without expense, I had three Beans planted with each bush. We have been annoyed by this pest yearly, this year we are without one of them. I do not mean to say they have been the preventive, but state the fact for the benefit or information of your readers.—W. S.

I OBSERVE in your last two issues letters relating to yellow Furze bushes as a remedy for the caterpillars on Gooseberry trees. Allow me to name another remedy which has been tried by myself and others, and found completely successful. Take 1 lb. of crushed or powdered alum to four gallons of water. Syringe the trees well on the first appearance of the grub two or three times.—H. J. BUNNY.

FURZE v. GOOSEBERRY CATERPILLARS—WHITE BEET.

I AM sorry I cannot give any more information to your correspondents, or any solution of the apparent enigma respecting the Furze in Gooseberry bushes. I merely tried the remedy at your request, and gave the result as required.

The caterpillars have again appeared, and the Furze has been again applied, but, as it was almost out of bloom, with but partial success.

Would you kindly tell me how to manage the large White

Beet, so as to grow it for "Chards?" I have sown some, and the plants are about 6 inches high. Does it require blanching or tying-up in any way?—P. B.

[The evidence relative to the efficacy of the Furze is contradictory, but preponderates against its being remedial. We fear that where the caterpillars disappeared, leaving dried skins on the leaves after the Furze was introduced, they had only cast their skins and descended into the earth to change into their chrysalis form.]

Have the White Beet supplied plentifully with water and liquid manure. The leafstalks are all the more tender if earthed-up like Celery.]

WORK FOR THE WEEK.

KITCHEN GARDEN.

Broccoli, let there be no delay in getting out a good breadth of White and Purple Cape, also Cauliflower and Grange's Early White Broccoli, which, if true, is invaluable in the autumn. Trench-up and fill with these kinds of crops every space as the early crops go off; not one vacant space or corner should now be left uncropped. *Cucumbers*, see that these and Vegetable Marrows do not want for liquid manure and water. Peg-down the bines as they advance, and attend to stopping. Break-down the leaves over the most forward *Cauliflowers*, and keep up a good supply of stimulants. *Dwarf Kidney Beans*, thin, earth-up, and stop advancing crops, and sow the latest successional crop. *Endive*, a full sowing may now be got in for the main crop; and if any were sown in May they had better be thinned out, and the thinnings transplanted. Early sowing of *Endive* is not recommended, because the varieties of Lettuces are much superior for every purpose for which *Endive* can be required at this season. The Small Green-curved is the hardiest for winter use; but for the autumn crop the Large Green-curved is a splendid *Endive* planted in very rich soil at 2 feet apart. This sort will not bear severe frost, nor does it keep in store so well as the Small Green-curved, and, therefore, for all late purposes the latter should only be sown. The large-leaved *Batavian Endive* is also a useful variety. Where *Chicory* is in request for salads, now is the proper time to sow it. *Herbs*, take the first opportunity as soon as the various kinds are sufficiently advanced to cut a portion for drying; the best time is as soon as the blossoms are expanded, because they then contain most of their aromatic principles. They must be cut perfectly dry, and dried quickly in the shade. *Lettuce*, tie-up for blanching, and make successional sowings; the same of *Radishes*, and other salads. *Spinach*, keep up the sowings of this. *Scarlet Runners*, make the last sowing, and give those advancing a little assistance in training them up the stakes. Persevere in hoeing and forking up the surface of the soil in every department.

FRUIT GARDEN.

The season being what may be considered a very growing one, there is the greater necessity for diligence in keeping all young wood properly nailed to the walls to guard against the effects of high winds. Gooseberries and Currants trained against north walls should have the leaders nailed in, and all the side offshoots spurred down to within a few joints of the base. Peaches and Nectarines, and, indeed, wall trees in general, will be greatly benefited by occasional strong syringings, whether infested with aphides or not, because, independent of washing away all filth, which of itself is a good thing, it disturbs and routs out woodlice, earwigs, and other vermin, which are sure to congregate amongst the shreds and at the back of the shoots, and which, if left undisturbed, will commit sad ravages by-and-by. Strawberries are now abundantly repaying those who have bestowed a reasonable amount of care in their cultivation, without which no good results can ever accrue. Let them be well gathered as they become ripe, as if left on they retard the swelling and ripening of those remaining. Continue the thinning of Grapes, and keep the growth judiciously stopped.

FLOWER GARDEN.

Advantage should be taken of the present showery weather to fill up all the empty beds; also to plant-out Geraniums, Asters, Ten-week Stocks, Marigolds, and other annuals to fill-up all the empty spaces in the flower-borders. Continues

to peg-down all the plants that require it. Support and regulate the shoots of climbers. Stake and tie-up all tall-growing plants. Prick-out biennials into nursery-beds. Now that the bedding-stock is fairly cleared off and growing freely in its summer quarters, there will be more space and time to attend to the propagation of favourite hardy plants; and no time should be lost in getting in a good supply of cuttings of such things as it may be thought desirable to increase, for the propagation of the bedding-out stock next season will soon require attention. Tulips should now be taken out of the ground; when allowed to remain too long it acts prejudicially on them. Auriculas will often at this season of the year be attacked with the aphid or green fly, remove them with a camel-hair brush, keep the plants in the shade, and occasionally water them. Disbud those sorts of Carnations and Picotees that generally produce small flowers to one bud, if the variety is of strong habit two buds may be left for blooming.

GREENHOUSE AND CONSERVATORY.

The Camellias and Azaleas for early flowering will have set their buds, and should be removed to a sheltered shady situation out of doors, for if kept in heat they will be apt to make a second growth, which must be avoided. Give every possible attention to plants for autumn and early winter flowering, as *Lilium lancifolium*, *Chrysanthemums*, *Salvia splendens*, *Globe Amaranths*, tree Carnations, Scarlet Geraniums, *Cinerarias*, *Gesneras*, *Begonias*, *Euphorbias*, &c. Let these have plenty of pot room, good rich compost, a moist atmosphere, and plenty of space for the perfect development of their foliage, regulating the temperature according to the nature of the plant, and they will make very rapid progress; but we have nothing that surpasses the *Epacris*, the winter-blooming *Ericas*, and the *Cytisuses*, and these should not be overlooked in the crowd of suitables. Many of the showy specimens of superior stove plants should be removed to these structures at this period, provided they are coming into blossom. The large *Clerodendrons*, *Ixoras*, *Stephanotis*, *Pergularias*, *Gardenias*, *Plumbagos*, *Jasminums*, *Erythrinas*, &c., are of this class. These, when highly cultivated, begin at this season to press on their weaker neighbours; and their beauty will, moreover, be longer preserved if they are slightly retarded. A greater depth of colour also will be produced in a moderate temperature. Look well to the training of trellis climbers whether in pots or out, and frequently stop the points of growing young stock. Encourage backward plants of *Orchids* with plenty of heat and moisture while that can be done safely. See that the plants on blocks and in baskets are properly supplied with moisture at the roots. To prevent any mistake in this matter carefully examine every plant at least once a-week, and immerse any found to be dry in tepid water until the material about the roots shall have become well soaked. Such stove plants as may have been removed to these houses while in bloom should be placed in heat again as soon as their beauty is over, in order to permit the young wood to get ripened before the short days set in. Where stove and greenhouse plants afford suitable cuttings propagation may still be pursued, as, generally speaking, it can be practised with greater success in the early than the latter part of the year. It should be remembered that the propagation of most plants is facilitated by the employment of bottom heat. It will be necessary frequently to look over greenhouse plants plunged out of doors, and check the havoc of worms and the robbery of weeds, and to attend to their security from high winds.

W. KEANE.

DOINGS OF THE LAST WEEK.

KITCHEN GARDEN.

VERY much the same as last week. Sowing Peas, chiefly *Advancer* and *Knight's Dwarf Marrow*, and will follow with earlier kinds, as *Dickson's Favourite*. Preparing beds for *Celery*, and in planting put some branches across to moderate the force of the sun's rays. Years ago we cultivated more *Celery* than we do now, and then we followed rather a uniform plan of having early *Potatoes*, *Lettuce*, *Celery*, and *Peas* on the same ground. The trenches were dug out in winter—say 4 feet wide, and from four to five-foot-wide spaces between them. If dung with a little heat was put in the

wide trench, we used it for the second early *Potatoes* with a little protection, and *Lettuces* among them, or a bed for themselves alone. Then having dug the intervals between the trenches, and thrown the soil some 15 inches out of the trenches upon them, we sowed a row of *Peas* for the second and third crops on the top of the ridges, and these were staked and coming into bearing before the *Celery* was planted out, and thus gave it the shade it so much desiderates, the sun shining fully on it only for a short time each day. We never obtained first-class *Peas* and first-rate *Celery* by a more economical process, the *Lettuces*, *Potatoes*, &c., being removed from the trenches before the *Celery* was fit to go out. We have not followed this plan much of late, because independently of our earth-pits, we have used all our *Celery*-trenches or most of them for bedding plants, and with such limited space between the trenches the *Peas* would have been in our way in giving and removing protection. The branches across the bed are, however, but a poor substitute for *Peas*. We have heard surprise expressed, that *Peas* on the top of a ridge should do so well, but the depth of stirred soil which secured moisture and also made sure that there should never be too much of it, were the only secrets of success. In elevating flower-beds into cones, we have uniformly found that when the plants took freely they needed no more water than plants on the level, provided the soil was previously deeply stirred. We are often surprised that the bed-system of growing *Celery*—that is, having three to four and five rows instead of one is not more followed in small gardens. In a commercial establishment where *Celery* was largely in demand, every day from autumn to spring, and where the smallness of the garden was a ground of grumbling complaint, the single lines of *Celery* were from 5 to 6 feet apart. On the bed-system from three to four rows could have been had instead of one, and the labour of earthing-up would be also diminished, and more especially if a dwarf kind were used. It is rarely that more than 12 inches of *Celery* ever go to table, and hence we see little use in banking-up strong-growing kinds until the plants are from 3½ to 4 feet in height. The most bulky *Celery* is also anything but the sweetest, and the larger it is in diameter it is all the worse to keep. We used to pride ourselves in growing it very large in diameter of plant, but we found it was a ruinous system, as when water penetrated into the heart it could not escape again, but became tainted and produced decay there. Middle-sized crisp *Celery* is now our aim. Hoeing, stirring, and weed-destroying were our principal work, except placing some short grass round the frames of *Cucumbers* to keep the heat uniform, and pricking out more winter stuff, as we have not a spare yard to plant as yet, but must wait until early *Peas* and *Potatoes* are removed. The rains are causing the *Peas* to bear profusely.

FRUIT GARDEN.

To explain one reason why so many of our friends complain of their *Strawberries* being failures, we may mention that we have a few rows that bloomed well, but are now scantily supplied with fruit. The plants are rising their fourth year, contrary to our general custom, which is to remove them earlier; but the chief cause of the comparative failure is, that they had not moisture enough when in bloom. Other beds that did have moisture enough are producing in armfuls. A few pailfuls of water on a little piece of *Strawberries* in a small garden, when the weather is very dry, when they come into bloom, often makes all the difference between a heavy crop and little or no crop. The mulching afterwards also keeps the roots cool and moist. With all these attentions, however, a correspondent tells us that for six years, and after three plantings in that time, he has scarcely had any fruit from that fruitful kind, the *Keens' Seedling*. It comes out, however, that he used his own runners, which under the circumstances was imprudent, as when *Strawberry* plants are barren they are apt to transmit that property to their runners. In all small gardens, therefore, it would be wise to mark all barren plants, and take no runners from them. We have marked barren plants of such late kinds as the *Elton*, and for three years had no gatherings from them, though the plants on each side were prolific enough. But for the time it would take in getting and preparing plants, a good many experiments would lead us to prefer the second runner instead of the first, as having a

decided tendency to be the most fruitful, whilst the first has as decided a tendency to be the most vigorous and luxuriant plant. Perhaps we should state the matter more correctly by saying the second plant on the runner.

Planted-out a good many Strawberries, as we could get at them, from pots in which they had been grown under glass. Nipped the shoots of Pears, Apples, Plums, &c., out of doors. Protected Strawberries and Raspberries with nets. Went over Peaches and Nectarines on walls. Gave another thinning to fruit in orchard-house, leaving a good many more than one to a foot, and picked fruit in Peach-house and Fig-house to prevent them falling, as they will keep better for use when not dead ripe when pulled, especially Peaches. In general, Figs should be used as gathered. Gave a final watering to back of Peach-house, and a good soaking with manure water to the back of the orchard-house, where the fruit, thickly set, are swelling fast. Cherries in pots have been pictures, and have come in very useful. Perhaps the most useful is the Empress Eugénie, superior in flavour, size, and earliness to the May Dukes. Plums are also a heavy crop in pots coming on, and we fear that we ought to have thinned them more. The Nectarines and Peaches in pots we have thinned liberally, and have had little trouble with insects of any kind as yet. Kept thinning at late Grapes; and where the Grapes are ripe and ripening, will get every plant out into late houses as soon as possible, where the damp will do no harm, but rather be of an advantage. In forward houses we leave a little air on all night, especially at the top. When growing and swelling we give but little air, even at the top, but that little is given early, so that there shall be no confined moist air in the house. We have as yet scarcely given a bit of front air. So much for the necessity of circulation. We have no fear of a vitiated atmosphere, with the sun shining on the glass, and a little air on to prevent the vapour being turned into scorching steam. We like the sun to do the heating work instead of the coal-heap, and an extra rise of 10° from sun, with a little air on early, will do good instead of harm. It is the high night temperature that weakens. As far as we recollect, our vineries last year did not have a sash or ventilator opened in front until autumn, to keep the ripe fruit. But for a long time there was a little air at top night and day, and that little was increased in very warm days. Very likely we would give more air, especially at night, were we near a coal pit. There can be no question, however, that we have as much waste from using fuel to do what the sun would often do. In looking over the accounts last year of a well-known public establishment, nothing surprised us so much as the fuel and manure bill. They were not in separate items, but we could hardly think the latter could be in anything like proportion to the former, as the place altogether is not large. The united bill for fuel and manure cost as much as some largish private establishments cost altogether. Of course, coals vary much in price, and they are generally about the highest in the metropolis. In the coal districts good coals can be obtained for less than half what we have to pay for them, and a fire always burning is there of less consequence.

We feel obliged to Mr. Rivers for mentioning the mode of making quassia water last week. We have alluded to it more times than seems to have met his eye; but we are indebted to him for our attention being first directed toward it. We have used it several times this season, and with good effect, but mostly in a clear liquid form and without anything in it, and thus it is more cleanly than when mixed with soap, &c. There is also a great deal of truth in what Mr. Rivers says about different insects being easily killed at one time, and taking much more trouble at other times. We have proved this over and over again, and hence arises the necessity of caution as to the strength of the destructive agency used, as in this respect plants are very like insects, as what will not hurt them at one time will seriously injure them at another. Plants that have previously been partially shaded will not stand the same amount of smoking and washing that plants will do when exposed previously to sunlight and air. With all this, however, there are facts about the greater difficulty of destroying insects at one time than at another time by using the same means for which we cannot account. All these point to the necessity of getting rid of the first insects that appear. When generation after generation have deposited their myriads of

eggs, or brought forth their myriads of viviparous young, the task is next to hopeless, and if you succeed the plant must be greatly injured. The brown beetle aphid, to which Mr. Rivers alludes, beats all that we have met with for fecundity. Take a fat fellow in summer, and squeeze it gently, and it will emit as many or more young ones in a string than you could count on a large rope of onions. This did trouble us a good deal last year; but in the orchard-houses we have seen little of it this season, and if a bit was seen it was attacked at once. In smoking or washing it is best not to use too strong doses at first. As frequently stated, a man would often correct the evil with the fingers and a syringe in the time he was getting some destructive agency ready. We think as a clean wash or liquid for dipping infested shoots in, quassia liquid will be likely to be much in demand, will that demand increase or lower the price? At present it is rather expensive when purchased in small quantities at country chemists. What may its price be when sold wholesale—that is, by the pound or cwt.? It is supposed to be the wood of the Quassia amara, a strong-growing tropical tree, all of which is bitter, and, it is commonly said, used largely instead of Hops. Some authors, however, say that the chips of other bitter woods are used instead of the Quassia. The Quassia chips we have obtained have a very bitter taste, and they may be boiled over and over again before the bitter virtues are extracted. As a wash it is the cleanest thing we have met with, as, if you put nothing else in, the liquid will be clear as the crystal spring. We may here state, in answer to some inquiries, that the best shag tobacco is the best manufacture of tobacco to use for smoking to kill insects. Several of our large commercial establishments use nothing else. Tobacco paper is generally so unequal in its strength that it demands much more care in using it.

ORNAMENTAL DEPARTMENT.

Removed a good portion of the Pelargoniums from the conservatory, and, to save time in moving, and also because we had little room elsewhere, clustered the Azaleas and Camellias at one end where we can keep closer and moister to encourage growth. The rest of the house will be filled chiefly with Fuchsias and Azaleas, and more air given, to be followed by fine-foliaged plants. We would have moved some of the Azaleas and Camellias beneath our Vines, but there is little room, and the roof is so covered, there would not be enough of light. In wet days and hours proceeded with potting greenhouse and stove plants, and pricking-off Cinerarias and Primulas for the winter. The forwardest of the latter have been potted separately. We will also report a few of the best and smallest of last year's plants. A month ago we had scarcely an empty pot of any kind. Now we have worked for several wet days in washing them up, and putting them away clean. Layering Strawberry runners, &c. A few days more when wet we can devote to getting twigs ready for the flower garden, as all the plants are not yet secured, and the wind has broken a few heavy-headed Calceolarias. We have got almost everything out except a row of Dahlias, and for that we want a dry day, so as not to make a mess. After showers weeded chickweed, &c., from flower-beds, as it is no use cutting it, and we have a good stock of it this season. We presume the seeds came in sandy soil from the sides of the highway. The beds are now filling fast, and will soon be very nice.

Our chief work, however, has been mowing the lawn farthest from the house. We always mow round the sides of the walks to prevent seeds from the grass falling upon them. In general we cut all our enclosed pleasure ground before the seeds of the grasses get near the ripening, and this helps to secure walks free from weeds. But it is generally the middle of June before we get all our pleasure-ground grass mown, and though we keep it pretty well afterwards we are not so particular with it as with the ground close to ribbon-borders and flower-beds. We were fortunate in getting the most of it dried and into a little stack in a couple of days. But for the bits of wood and Laurel and other leaves this hay would be valuable for anything. We value it chiefly as a store of protecting material in autumn, winter, and spring. A good armful of this nice soft hay has often been nearly as valuable as its weight in silver, and it is so handy to have it beside you and to use it when and how you like.

Here we may allude to a little matter, but which is still of importance. In making such grass into hay and taking it off, no common rakes would take it clean enough. The weather was so dry that it was no use attempting to sweep up the remains. Other work was gone on with until we should have a heavy dew or a little rain. There was rain on Wednesday, and so all the strength possible was employed on Thursday morning to sweep up the leavings, first taking in the width of two swathes with the long-handled broom, and brushing up the alleys thus made with the short birch brooms or common brooms. If this sweeping was not done we should lose much more than the time taken in doing so, as even if we rolled, the bits of dried grass that would be left without sweeping would soon take the edge off the sharpest scythe and help to clog up the knives of the mowing-machine. From this cause we have often seen men more distressed at the second mowing than at the first. Mere raking will not do for grass that is to be kept as a lawn.

Another thing we may mention. The lawn kept short near the mansion suffered somewhat this season from the great heat in May. There are brownish spots even now, and tufts of grass too soft for the mowing-machine to manage nicely. Instead of using the machine we will let it alone for eight days, and then give a slight touch over with the scythe so as not to touch the bottom at all, after which we hope the machine will do its work well. We noticed several places near the house where a series of parallelograms some 20 inches by 12 were quite parched up, and narrow green spaces between these squares. We puzzled our brains to account for this singular phenomenon, until we recollected that carpenters had been employed in removing the outside windows from the mansion, the windows being double in winter. They had laid the sashes flat on the grass before removing them, and the wonderful heat in May had burned up the grass below the glass, and the green spaces were the parts shaded by the sash-bars. There was and could be no intention of doing any harm, and the marks are already wearing out through the warm rains; but many an evil and many a misfortune occurs, not from anything like purpose or design, but merely from the want of any thinking at all about the matter.

What is said above of the fine silky grass which the mowing machine will not bite freely, will apply to two or three complaints, and a skiff with the scythe will make all right. Other complaints are the result of a lawn with deep moss. In that case the lawn must be consolidated by rolling, or the knives of the machine must be a little elevated to catch the grass above the moss. We are now beginning to have the prospect of mastering our work, instead of being mastered by it.—R. F.

COVENT GARDEN MARKET.—JUNE 25.

The supply and demand continue very good, especially as regards Pines, Grapes, Cherries, and Strawberries. Peas are also abundant.

FRUIT.

	a.	d.	s.	d.		s.	d.	s.	d.
Apples.....	½	sieve			Melons.....	each	4	0	10
Apricots.....	1	0	3	0	Nectarines.....		10	0	20
Cherries.....	1	0	2	0	Oranges.....	100	10	0	16
Plgs.....	12	0	20	0	Peaches.....	doz.	18	0	36
Filberts & Nuts 100 lbs.	0	0	0	0	Pears.....	bush.	0	0	0
Gooseberr. Green ¼ sieve	2	0	4	0	dessert.....	doz.	0	0	0
Grapes, Hothouse.....	6	0	10	0	Pine Apples.....	lb.	6	0	10
Muscats.....	8	0	14	0	Strawberries... punnet		0	6	1
Lemons.....	100	4	0	10	Walnuts.....	bush.	14	0	20

VEGETABLES.

	s.	d.	s.	d.		s.	d.	s.	d.
Asparagus.....	bundle	3	0	6	Lettuce.....	score	0	9	1
Beans Broad.....	½	sieve	3	0	Mushrooms.....	pottle	1	0	2
Kidney.....	100	1	0	1	Must. & Cress, punnet		0	2	4
Beet, Red.....	doz.	1	0	3	Onions.....	bushol	7	0	12
Broccoli.....	bundle	0	0	0	pickling.....	quart	0	6	8
Cabbage.....	doz.	0	2	1	Parsley.....	½	sieve	1	0
Carrots.....	bunch	0	6	0	Parsnips.....	doz.	0	9	1
New.....	0	9	1	6	Potatoes.....	quart	0	6	1
Canflower.....	doz.	2	0	4	Peas.....	sack	8	0	12
Celery.....	bundle	1	6	2	New.....	lb.	0	4	0
Cucumbers.....	each	0	6	1	Radishes doz. bunches		0	6	0
Endive.....	score	1	3	2	Turnip.....	0	6	1	0
Fennel.....	bunch	0	3	0	Rhubarb.....	0	4	0	6
Garlic and Shallots, lb.	0	8	0	0	Sea-kale.....	basket	0	0	0
Herbs.....	bunch	0	3	0	Spaich.....	sieve	1	0	2
Horse-radish... bundle	1	6	4	0	Turnips.....	bunch	0	6	0
Leeks.....	bunch	0	4	0					

TO CORRESPONDENTS.

** We request that no one will write privately to the departmental writers of the "Journal of Horticulture, Cottage Gardener, and Country Gentleman." By so doing they are subjected to unjustifiable trouble and expense. All communications should therefore be addressed solely to *The Editors of the Journal of Horticulture, &c., 171, Fleet Street, London, E.C.*

We also request that correspondents will not mix up on the same sheet questions relating to Gardening and those on Poultry and Bee subjects, if they expect to get them answered promptly and conveniently, but write them on separate communications. Also never to send more than two or three questions at once.

N.B.—Many questions must remain unanswered until next week.

ASPHALT GARDEN WALK (*Toby*).—We cannot estimate the cost. The following is the mode of making such walks:—"Take two parts of very dry lime-rubbish, and one part coal ashes, also very dry, and both sifted fine. In a dry place, on a dry day, mix them, and leave a hole in the middle of the heap, as bricklayers do when making mortar. Into this pour boiling-hot coal-tar; mix, and, when as stiff as mortar, put it 3 inches thick where the walk is to be. The ground should be dry, and beaten smooth. Sprinkle over it coarse sand; when cold, pass a light roller over it, and in a few days the walk will be solid and waterproof."

BOOK ON GARDENING (*Zeta Jota*).—You can have "The Garden Manual" for 1s. 8d., and "Mansres for the Many" for 4d., free by post, if you send postage stamps to those amounts with your direction to our office.

MILDEW ON ROSES (*A Constant Reader*).—Having no information as to your soil, culture, or the nature of the fungus, we can only reply that most probably your best remedy will be to manure the soil liberally, mulch over the roots, and water abundantly every evening during dry weather.

MUSSET'S HEATING APPARATUS (*A. F. W.*).—Not having had any experience in using this apparatus we cannot testify as to its merits. We will insert any reports that may be sent to us from those who have tried it.

FRUIT TREES IMPORTED FROM FRANCE (*Carbon*).—There is no reason that we know of why fruit trees grafted in France, and imported to this country, should not thrive as well as trees grafted here.

ORCHARD-HOUSES IN THE NORTH.—In reply to "E. S.," we beg to state that the trees of the orchard-house of the "YOUNG AMATEUR" are two and some three years old from the bud. He has now thinned the fruits to about a dozen or fifteen on each tree. "A YOUNG AMATEUR" has had May Duke Cherries ripe in perfection about a week in the same house.

IVY-LEAVED GERANIUMS (*Mrs. Chinery*).—One is the "Golden-edged," another the "Silver-edged," and the others are named according to the colour of their flowers—"Pink Ivy-leaved," and so on.

MILDEWED GRAPES (*E. M. W.*).—Fill a soup plate with flowers of sulphur. Plunge every bunch into the sulphur with air and light getting at the remaining shoots bearing fruit, but retain a growing shoot above the fruit, and keep the lateral shoots well stopped back. Do not on any account allow the young shoots to interfere with the large leaves, but cut them out or shorten back, as necessary. 3. Three fruits are ample on one plant. If you take more they will be small.

MILON CULTURE (*C. P.*).—1. Leave only one fruit on a shoot. 2. Cut out all small wiry shoots that interfere with air and light getting at the remaining shoots bearing fruit, but retain a growing shoot above the fruit, and keep the lateral shoots well stopped back. Do not on any account allow the young shoots to interfere with the large leaves, but cut them out or shorten back, as necessary. 3. Three fruits are ample on one plant. If you take more they will be small.

VINES NEWLY PLANTED, AND PEACHES AND NECTARINES UNDER THEM (*W. W.*).—We think your Vines have not good root-hold yet, but that they will improve shortly. Keep them well syringed, and the atmosphere of the house moist. You may grow a few Peaches and Nectarines in pots if the Vines are not nearer to one another than 4 feet. If you wish to grow them on a trellis the Vines ought not to be nearer than 6 feet. If nearer, in either case, it is useless attempting to grow Peaches under the Vines. Figs would do much better. In any way plants would do well; but without knowing which you would prefer, we can only hazard a reply as to what would suit you best. Peaches would not do to force the same as Vines in the same house, you would, therefore, be most pleased with plants. You could have Camellias, Azaleas, Pelargoniums, Cinerarias, Calceolarias,—say half a dozen of each of the two former sorts, one dozen of the two last—and *Cotonilla glauca*, *Cytisus racemosus*, *Chorozema cordata splendens*, *Clerodendron Bungei*, *Clivia nobilis*, *Cyclamen of sorts*, *Primulas*, *Erythrina crista-galli*, *Hibbertia dentata*, *Hovea Celsi*, *Hydrangea japonica variegata*, *Indigofera decora*, *Monochetum ephesurum*, *Nerium splendens*, *Polygala Dalmaisiana*, *Stachis brassicifolia*, *Swainsonia galegifolia*, *Tremandra ericoides*, and *Rhododendron jasminiflorum*, most of which would do well put outside in July, and taken in again in September. In summer you could make your house gay with annuals—*as Balsams*, *Thunbergia*, *Amaranthus melancholicus ruber*, *Coleus Verschaffelti*, *Gloxinias*, *Achimenes*, and variegated *Begonias*, which will all be out of the way or dormant in winter, and so making way for the winter-flowering plants.

VERBENA AND CALCEOLARIA LEAVES INJURED (*T. E. C.*).—Examine the beds after dark with a lantern, and you will most likely find your enemy at work. The leaves appear to be eaten by some vermin, which must infest the place in great numbers. Snails and slugs will eat them, so will caterpillars and earwigs. Cabbage leaves laid on the beds and examined in the morning will enable you to catch the former, and when caught, sweep them off the leaves into a flower-pot, and sprinkle a little salt over them. Caterpillars can only be removed by hand-picking. Earwigs may be trapped by cutting some Broad Bean stalks into lengths of 5 or 6 inches, and placing them horizontally on different parts of the beds. They should be examined every other day, or daily, and the earwigs blown out and destroyed.

GERANIUM CUTTINGS (Agnes).—All of the Geraniums employed for bedding out will strike freely in the open ground, the middle of July and beginning of August being a good time to put in the cuttings. We know of no better mode of growing bedding Geraniums than to pot now, one or more of the best plants of a sort, in a compost of rich turfy loam, with a free admixture of sand, providing good drainage, and giving a moderate shift, say from a six-inch into a nine-inch pot. Place in a shady yet light situation, and by the middle of July pinch out the points of those shoots growing irregularly, in order to form a bushy plant. In the beginning of August place the pots on boards or coal ashes in a sheltered situation, yet exposed to the sun, keeping the plants well supplied with water, and lightly sprinkled overhead with soft water. By the last week in September the plants will be coming generally into flower, and should then be removed to the greenhouse, where they will flower the greater part of the winter. Our correspondent says she has fine beds of James Odier and Pescatore Pelargoniums, continuing in bloom until November.

SHRUB FOR HEDGE (X. F. Z.).—As you wish for some rapid-growing shrub, you cannot have anything better than Evergreen Privet. After taking away the Laurels dig the ground at least a spit deep, removing at the same time the old stumps and roots of the Laurels. A dressing of manure will help the plants, if worked into the soil. Dig out a trench, and put in the plants any time in mild weather from October to March, placing them 6 inches asunder, and 1 foot at least from the wall, though 2 feet would be better. Water the plants well if a dry spring follow the planting, so as to give them a good start, and in July cut the hedge down to 1 foot, which will cause side shoots, trimming off the sides all irregular shoots at the same time, so as to make the hedge about 1 foot wide at bottom and tapering upwards. Go over the hedge again in the autumn, clipping off all loose straggling shoots, and pointing the ground neatly over, working in a dressing of any kind of vegetable refuse. The second year you will clip the hedge again in July gaining a foot in height this time; or, if you are very anxious about covering or hiding the wall, let the hedge grow to the required height without cutting off the top, only trimming the sides. When the hedge is of the required height it will need trimming in July with the shears, making it any height and width desired.

FERNS IN COCOA-NUT SHELLS (A Constant Reader).—*Nipholobolus pertuans*, *Drynaria Fortunii*, *Adiantum capillus-Veneris*, *Pleopeltis stigmatica*, *Drynaria pustulata*, *Microlepia nove-zealandica*, *Lomaria alpina*, *Adiantum setulosum*, *Davallia decora*, *D. pentaphylla*, *Asplenium flabellifolium*, and *Pleopeltis lycopodioides*. We do not know of any Ferns that will endure the dry atmosphere of drawing-rooms, such places being very unsuitable for them.

TULIPS—CERASTIUMS (A Subscriber).—The Tulips taken up, will bloom every year; there is no occasion for resting them. Our *Cerastium Biebersteini* stood the last winter, as well as *C. tomentosum*. Both make the neatest edgings when planted every year.

PLANTS FOR VERANDA HANGING-BASKETS (Wellknow).—For your baskets we would use *Linaria cymbalaria*, *Saxifraga sarmentosa*, hardy; *Hibbertia grossularifolia*; *Maurandya*, three or four colours; *Lophospermum scandens* and *Hendersonii*; *Tropaeolum* of kinds. These, grown in pots, may be set in the basket, and stuffed round with moss, and then pretty well allowed to dangle and festoon as they like. They will want a good deal of watering, which should be done in the evening, if the basket has no means of preventing drip. The *Maurandyas*, and the *Tropaeolums* or *Nasturtiums*, will perhaps cost the least trouble. Get the plants established before you suspend them.

FLOWER-GARDEN PLANTING (New Forest).—We think your proposed plan will look very well, and be nicely balanced. For Bijuou and Alma, we would use *Lobelia speciosa*; for Village Maid and Stella, *Paxtoniensis*. The tazza might be of mixed colours, so as to give a neutral tint. White Ivy-leaved Geraniums, with an edging hanging down of the *Verbena pulchella*, would answer very well. The *Verbenas* would require to be large plants before they were put out, so as to cover the rim of the tazza.

NAME OF ROSE (A Regular Subscriber, Sheffield).—We cannot identify it by the specimen sent.

NAME OF PLANT (P. S.).—*Selaginella Willdenovi*.

POULTRY, BEE, and HOUSEHOLD CHRONICLE.

NORTH HANTS POULTRY SHOW.

WE are behind with our report of this very pleasant Show, which supplies a want in our south-western district, and which, we think, is destined to become a great success. It seems to us to possess all the elements that have achieved the prosperity and renown of the Bath and West of England, Northamptonshire, and some others. There is to us a great charm in an agricultural meeting; there is freedom, and apparently an absence of care. It is a holiday for all, and every inhabitant of the village shares in the triumph of the ox, the horse, the sheep, or the fowls, that take the prize. Every one is beginning to find there is business in going there. Each succeeding year brings its addition. Steam machinery, hydropumps, choice seeds, Indian-rubber piping, all the rival ploughs. These added to a military band, and favoured by weather that left nothing to desire, made the grounds in which the Show was held a promenade. The Committee not only looks well on paper, but it is composed of men who work lustily in their several departments; and Mr. Downes is just what a Secretary should be.

The competing pens came from all parts, and we were glad to see the prizes were scattered about. The *Dorkings* formed a highly meritorious class. Mrs. Pettat's and Mr. Fowler's birds were excellent. Prizes seem to haunt certain

localities in certain classes for a time. Thus in our southern shows the *Cochin* classes have been to the Isle of Wight, and they so went in this case. We are told Mr. Pittis's pen had before taken prizes at Birmingham. We need hardly say the *Polands* were good, but Mrs. Pettat was hard run by Mr. Edwards, who took second prize. The *Game* were very good, and the prize birds deserved their honours. The cock in the second-prize pen had rather too much tail. Mr. Fowler could only take second in *Spanish*. There was but one class for *Hamburghs*. It was an excellent one. Mrs. Pettat's *Silver-spangled* were nearly perfect, and Mr. Pittis's *Golden-pencilled* were worthy competitors. The *Brahma Pootras* were very good, and Mrs. Seamons's birds would be a credit to any show. The prize for *Aylesburys* went to the same lady. There were excellent *Game Bantams*, and the usual oddities in the extra class. It was a good, pleasant, and well-conducted Show, and bids fair to become a large one.

DEATH OF DORKING CHICKENS.

I NOTICE the wail of "A. K. C." in your last Number, on the death of his Dorking chickens, and I have now to add my plaint to his. In May last I bought a sitting of eggs from the agent of Lady Holmesdale. Five birds were hatched; fine, healthy fellows. They thrived well till about a month old, and then began to droop, and die they would. At the same time I had thirty to forty young birds of the same age, also Dorkings, treated precisely in the same way, and on the same ground, all of which are healthy and doing well. In fact, I have lost fewer young birds this year than usual. The only way I can account for it is, that I fear the parent birds are too tenderly raised, being intended for exhibition.—Loose Box.

HEN ACQUIRING A COCK'S PLUMAGE.

SOME time since you had some remarks on the change of plumage in a fowl—viz., a hen assuming partly the feather of the cock. I think I can give the information that was required as to the cause of the change. It arises from injury sustained in the egg-passages, and if such a bird be killed the whole of the intestines will be found covered with yolk. I have opened many such with the late Mr. Yarrel. The change is very common among Pheasants, and arises always from the same cause.

A capon loses comb, gills, and sickle feathers, and if the operation be well performed, he directly assumes all the habits of a broody hen. Nothing pleases him so much as to be entrusted with a nest of eggs. Nearly all the chickens in Italy are hatched and reared by capons. When a *poularde* is made—which is done by removing the ovary—her comb, gills, and hackles grow at once; the first becomes erect; she crows; a semi-saddle grows, and she assumes all the habits of the cock.

DIARRHOEA IN PIGEONS.

HAVING profited by the experiences of Mr. B. P. Brent, I think it right, as far as it lies in my power, to return the benefit. I have watched in "our Journal," for some time past, expecting to see some poor unfortunate, who like myself, would be glad of any one's experience to help him out of his difficulty, but I little expected to find such a one to be "B. P. B." In the beginning of the season I lost one of my best birds of the complaint named by Mr. Brent. Soon after I noticed another bird going the same way, then I thought it was time to call in the doctor. I went to several fanciers, and they told me they had lost birds by the same means, but knew of no remedy. So I set to work myself, and at last hit on a plan which has with me proved effectual; even after birds have been so exhausted as to be unable to eat, I have cured them. The bird when affected mopes about, its feathers all roughened up, and voids nothing but slime. I take the invalid, put him in a separate pen, and give him the hardest tick beans I can get, and every day cram him with four or five pieces of old mortar. After the first day the dung will have a much harder appearance, and the bird will gradually get stronger

When the excrement assumes the healthy look of that which all birds in good health void, I turn him loose with the others, taking care to throw plenty of rice into the loft. I find 1 lb. of rice thrown into the birds now and then a good preventive of diarrhoea, a complaint which I find all birds in confinement subject to.

Living in a crowded neighbourhood, and having a great many birds, I find it best to keep them confined; but I have an hospital outside in which I put my invalids to recruit their health, and I find it a very good plan. I think if "B. P. B." tries my treatment he will find it effectual, and I should be glad to hear of his success.—CARRIER COCK.

P.S.—I forgot to say that should the bird be too weak to feed itself, I cram it with a few beans at the time mixed with old mortar.

THOUGHTS AT BATH AND WEST OF ENGLAND POULTRY SHOW.

A POULTRY show is a capital thing, especially if you can see it; but that must have been a puzzle for many visitors. It was, in fact, a moving mass through the tents. I do not often get the chance of a peep, and after the "Malay" storm that followed my "Dottings at Devizes," long since, I tread somewhat tremulously.

Spanish headed the list. These birds are, in many cases, now becoming blind, from the warty character of the white on the face. Instead of being a moderately smooth face, it has become a warty, puckered, coarse mass, which in several birds threatens to close the eyes. I noticed this chiefly in the single cock birds. No longer a Spanish breeder, I simply as an amateur regret that the character of face which the chickens have, with the bright intelligent eye, is not more retained in the adults. Some of these birds, I imagine, can only feed when looking round the corner. Some of the chickens of this breed were very forward and very promising.

It is hardly to be supposed that Dorkings can get much larger. There were some splendid birds. I especially noticed the single cock bird, and he was rose-combed.

Game formed a sight in themselves. Many birds, I should fancy, lost all chance, from the bad dubbing. In this respect Mr. Fletcher's birds were a picture. I should say the pincers had been used freely in many of the cock birds throughout these classes, and I will not deny that they looked the better for it. That, however, does not alter my opinion as to the justice.

Of Cochins there was a good show, and especially a large entry of Whites. Blacks appear to have passed away.

Hamburghs entered largely, and some very coarse combs were amongst them.

Polands and Malays were poor in numbers but good in quality. I think there was a White-crested Black cock there, which without trimming had no black feathers in his top-knot. Some of the hens were lovely.

In "Any other variety," half the entries (and I think, excepting the Game Reds, it was the largest class), was made up of Brahmas, without exception all dark birds. They headed the prize list, and I trust that so large an entry in this class will induce the Committee to offer another year the same liberal prizes to a separate class of Brahmas as they do to the other larger breeds. I am certain it would pay. As it was, the entries exceeded many of the entries in the regular classes, although there was the tolerable certainty that but one of the three prizes would go to Brahmas. Many of the other pens were deservedly highly commended, yet I think that the matching of the combs in several pens was somewhat too leniently treated by the judges. This is an oft-repeated tale, and it is time exhibitors fully understood it. Some La Fleche fowls were highly commended. They might almost terrify some small children. This pen was not in the best condition. A case of disqualification occurred in this class. In a pen of White Spanish, which I fancy have often appeared in the prize list, the cock's tail was said to be made. I would not take on myself to decide whether this was the fact or not. I am disposed to take the lenient view, and to suppose that the sickle feathers, being weak, had been tied about 4 inches from their insertion with cotton. It was evident to all, and this makes me take the

lenient view. I noticed several commended and highly commended pens in this class that had tapes tied round one leg, and wondered whether on that account they ought not rather to have been disqualified. Knowing the owner of one, I am quite certain in his case it was not intended as a hint to judges. There was a beautiful pen of Black Hamburgs in this class unnoticed. I thought them very handsome.

The classes for chickens had some promising birds that will be heard of again—to wit, the pen of Spanish, and that of Partridge Cochins.

Cannot the Committee afford to add another class to the chicken for "Any other variety?"

The Bantams were numerous, and some of them very good birds. I specially fancied the winning pen of Blacks, and a single Duckwing Game cock was everything that could be desired. Entries of Turkeys, Geese, and Ducks were scarce. Guinea Fowl mustered only three pens, although liberal prizes were offered. I heard to-day in a farm-yard where I was looking at some chicks of this breed, that in this case the parents had not paired. There was one cock to three hens, and only one unfertile egg.

The class for Malays, as I have already noticed, was but thinly represented, one reason being that Mr. C. Ballance, the breeder, *par excellence*, in the western counties, was one of the Judges. I could not help wishing that some of his birds had been there, "not for competition;" but a five days' actual show, and one day if not two before in pens and baskets is a trying ordeal.

The pens were roomy and good, and, as usual, I thought the birds too carefully attended to in the eating way. The proper method of giving water is not to allow the vessel to be ever under the feet of the inmates, it ought to be fastened some inches from the floor.

I saw only one thing besides in the arrangements which I did not like. There were a few empty, "not sent," pens. On the floor of these pens in several cases I noticed a handful or more of peas. Instantly it flashed across me, Were these placed there in anticipation of the occupants? Was this to be their first meal? If so it is a great mistake, and one which exhibitors would do well to represent to Committees. The first meal after a journey should be moderate and soft. It would also be a good plan in shows having the objectionable duration of the Bath and West of England, to strew the floors of the pens now and then with some small gravel.—Y. B. A. Z.

POULTRY CLUB'S SHOW.—We hear from good authority that it is proposed to hold a Poultry Exhibition at the Islington Agricultural Hall very shortly, under the auspices of the Poultry Club. We believe that the prizes will be high, and the date, as at present suggested, will be the 1st, 3rd, 4th, and 5th of next October. The Club will appoint the Judges. Among the Judges we rejoice to hear will be Mr. Hewitt; and as we know that he has consistently refused to be bound by the Poultry Club's rules, we conclude that the Club has found that the application of such rules is an impossibility. It is much more easy to make rules than to apply them without exception. The Judge must have his own discretion unfettered, and this being admitted, rules for judging are inoperative; they only say, Decide as we direct, unless you choose to decide otherwise.

ARTIFICIAL SWARMS.

On May 13th I had a swarm, and on the 25th I drove a swarm from the same hive. Many bees were left behind, but as the queen was seen with the driven bees the old hive was placed upon an unoccupied stand. On the 16th of June I again drove the same hive, neither seeing the queen nor quite expelling all the bees. This time I transposed, and as far as I can judge with success to the driven stock. Can I be sure that a queen had been raised in the twenty-two days between the two drivings, and can I expect the old hive will have brood from which to rear a queen? The last swarm seems very quiet and very numerous, and the bees in the old stock are working well. The transposed stock seems to have received a great shock, but being the swarm of the 13th of May, and young bees having been seen, it will, I hope, soon recover, though they have thrown out

many young bees apparently just issued from the comb.—
A VILLAGE DOCTOR.

[These operations appear to us a series of mistakes. It is only by sheer good luck that they can succeed, whilst the risk of failure is very great. The young queen which you saw on the 25th might or might not have been impregnated, but in either case would certainly have demolished every royal cell. If a virgin she will probably return to the old spot the first fine day, and leave the swarm to gradual extinction. If impregnated she is not likely to have commenced egg-laying, and then the same fate must await the old stock unless furnished with a queen or the means of raising one. The issue of after-swarms is best left to Nature.]

YOUNG QUEENS.

My first batch of Italian princesses was fecundated on Monday the 20th June. It was a glorious day, and I certainly never witnessed such a scene. The air was literally darkened by my Ligurian drones, which kept up a louder roar than that which ordinarily accompanies the issue of a swarm. During the afternoon I found the evidence of impregnation in five queens, one of which was rigidly imprisoned by her subjects until the evening, when the excitement continuing led me to fear a fatal result. I, therefore, took her from them, and, placing her in a queen-cage, returned her to the hive. When released the next morning, however, I had the pleasure of finding her well received. Two more were rendered fertile, and, I believe, on the same day, leaving but two in the apiary, who were "Ower young to marry yet."—A DEVONSHIRE BEE-KEEPER.

ARTIFICIAL SWARMS.

My present design in writing is to state the plan which I have adopted this year in making an artificial swarm, and to ask a question or two relative to the course which I have adopted.

During the warm weather in May, two of my stocks were in such a state that I daily expected them to swarm. The bees were extremely crowded, and hung out of the hives in large clusters; drones also were numerous. It happened that on certain days it was extremely inconvenient to me to be constantly on the watch for a swarm to issue. It happened also that a neighbour had her bees swarm in her absence, and the swarm was lost. These considerations induced me to try my hand at making an artificial swarm on the plan lately described by "A DEVONSHIRE BEE-KEEPER." And here I cannot but express my surprise at the difficulty which some persons (occasionally correspondents in your Journal), say that they find in accomplishing the feat of driving. For myself I can only say that I attempted it for the first time in my life last autumn, and succeeded without the slightest difficulty. Certainly I for one would never think of resorting to such means as fumigation for obtaining their honey in the season. But to proceed. I drove the greater part of the bees into a common straw hive, and then transferred them to a Woodbury bar-and-frame-hive; I let this hive stand where the old hive had been, and put the old hive in the place of a stock that seemed almost ready for swarming, and this latter I moved to a new position. In short, I endeavoured to follow the "DEVONSHIRE BEE-KEEPER'S" directions in all particulars, except that I did not drive into the Woodbury-hive the whole of the bees from the old stock. I have since been rather afraid that I did not drive enough, as in a few days the old stock sent out a large after-swarm which I secured safely.

My second attempt was made last week. The hive which in the former experiment I had moved from its original position had gone on well, and I thought that a swarm might issue any day. It happened that the hive was of a small size, and not in good condition. My desire, therefore, was to expel all the bees, and get the brood hatched by the inmates of some other hive. I therefore proceeded as follows:—Discreetly and warily, and not without some misgivings as to how far the bees would themselves approve of the operation, I inverted the hive, placed another over it, and drummed for a few minutes, according to the directions

for driving. All proceeded most satisfactorily, and on making an inspection I found that very few bees remained in their old habitation. This hive, however, I found to be full of brood in all stages. Having, therefore, placed the new-made swarm on the spot which the bees composing it had occupied in their old hive, it occurred to me that it would give additional strength to the new colony in the Woodbury-hive if I could induce them to hatch the brood remaining in the driven hive. I therefore opened the hole in the crown-board, and placed the hive with its combs at the top, at the same time stopping-up the entrance of this upper hive. Large masses of bees ascended into this hive, and seemed to almost fill it. I suppose, before long, they will hatch the brood out, and so strengthen themselves. When this is done I intend to take this hive away.

Now I should esteem it a great favour if you would inform me whether my operations, so far as I have described them, are likely to prove successful, and specially whether the Woodbury-hive bees are likely to hatch out the brood in the hive over them, and then to leave it.

I should like to ask one other question. I have one of Neighbour's cottage-hives extremely full of bees, and though they occupy three glass supers, they crowd about the entrance as if they could not find room inside. I should think they were going to swarm, as they have done in former years, were it not for the circumstance that they have lately been killing drones in large numbers. Can you give an idea as to what this slaughter of the drones at the present season is attributable to? and say whether it is a sign that no swarm from the hive is to be expected this year? I have no desire for this hive to swarm, but for the last two or three years it has done so in spite of all precautions to prevent it.—JONAS JACKSON.

[As we are indebted to you for a hearty laugh at the "auld world" superstitions, which it has pleased you to advocate, we have much pleasure in giving the required information.

Your operations thus far have evidently been perfectly successful. Entire failure would, of course, have resulted from not driving the whole of the bees had the queen remained behind; but as she was good enough to join in the partial exodus, there is nothing now to be regretted. The after-swarm was caused by the existence of royal cells in an advanced stage, and might have issued even if the hive had not only been comparatively depopulated, but also deprived of half its combs. The bees of the Woodbury-hive will certainly hatch out all the brood which has been consigned to their protection; but the query as to their leaving the upper hive tends to re-open the "super-posing" question which was debated at length in our pages some three years ago, and on which our opinion was controverted by one of our ablest and most esteemed correspondents. We believe, however, that the queen will ultimately adopt the lower hive as the breeding place, leaving the upper one filled with honey; but when this may take place it is difficult to say.

Drone-killing shows that the prosperity of the colony has received a check, owing doubtless to the late unfavourable weather. This check may prove but temporary, and the bees swarm after all, whilst on the other hand the swarming tendency may not be again developed this year.

In conclusion, we need not warn you sedulously to guard your bees from the baneful effects of the "evil eye;" whilst, on the other hand, even if your apiary should come to grief, we hope not to hear of your being "in trouble" through attempting to "draw blood" from, or to "swim," some harmless but antiquated crone whom in your wisdom you may conclude to have "overlooked" them.]

BEEES IN SUFFOLK.

My case has been nearly like to that of "T. H. L." I drove a swarm into one of Neighbour's improved cottage-hives, and the same day the bees deserted it. I captured them and put them into a straw hive with a flat top, and they do well. Yesterday I supered them, and to-day (17th June), the super is full of bees at work. For three years I have had no success with Neighbour's improved cottage-hives. In the glasses, though covered with flannel or green baize, the bees begin to work and then leave off. The

lower hoop swells by the wet and will no more fit the bottom board. After three years of trial I much prefer a straw hive with a flat top and a good hole for a super or for bottle-feeding. I prefer a straw super with a glass on one side and a wooden top.

I have one of Neighbour's observatory-hives in my study, and it has done well. The first year I took two glasses of honey, and to make room for the increasing stock I raised the glass hive on a hexagon of wood with glass windows. The observatory-hive with the hexagon below is full of bees and combs. Towards the end of May I put on a glass super, and when this was nearly filled I lifted it and placed one of Paine's straw supers between this and the observatory. On Monday, the 13th, I took off the straw super full of honey, and I placed another in its stead, and in this the bees are hard at work.

A Woodbury straw bar-frame hive into which I put three very small swarms last year has succeeded. It has thrown off two good swarms and also nearly filled the box-super with white combs and honey.—CAVENDISH.

[We should try a full-sized super on the improved cottage-hives instead of small glasses.]

DO YOUNG QUEENS BREED DRONES ?

I READILY respond to the request preferred by "R. S.," in page 444, by recording my views and the result of my experience with regard to queen bees proving prolific mothers of both drones and workers during the season in which they come into existence.

It may certainly be laid down as a general rule, that queens hatched during the current year do not breed many, even if they breed any, drones; and this not because they are incapable of so doing, but by reason, so to speak, of a certain inaptitude or unwillingness on their part to lay male eggs during the first few months of their life. I am well aware that this unreadiness or reluctance may be overcome, as in the instances to which "R. S." refers, by a combination of favourable circumstances leading to such a state of prosperity within the hive as to almost irresistibly impel the colony to make preparations for swarming; but it undoubtedly requires a much greater amount of this gentle but efficient pressure of prosperity to induce a very young queen to take the preliminary step of laying drone eggs than would be required in the case of a more experienced matron.

I first became acquainted with this fact by completely failing in the attempt to induce a young Italian queen to produce drones of that species of which at the time I stood so much in need, although I resorted to all the usual expedients to attain the desired end. I might have spared myself the trouble; and found afterwards that others were much better informed on this point than I was at that time.

Dzierzon states that young and fertile queens do not in his district either lay drone eggs or lead off swarms, although they do both in the neighbourhood of the Lüneburg heath, where the pasture is prolonged later into autumn.

The Baron von Berlepsch, who ranks second only to Dzierzon among the bee-keepers of Germany, also says, "I have never found—1st, That bees with a queen of the current year made many drone-combs; 2nd, That a queen of the current year laid many drone eggs; 3rd, That a queen of the current year led off a swarm." It was by pushing these observations to their logical extreme that, so late in the year as the 23rd of August, he succeeded in producing those drone eggs by means of which that distinguished naturalist Von Siebold, who visited him for the purpose, was enabled to demonstrate the fact of parthenogenesis in the honey bee by proving beyond all doubt that worker eggs are fecundated eggs, whilst those that will produce drones remain unfecundated. The grand secret of his success lay in selecting a very old queen: liberal feeding and inserting drone-combs in the brood-nest did the rest, and in two days a comb containing newly-laid drone eggs was placed on the naturalist's table.

I need not more than casually refer to what Huber has written on this subject. Distinguished naturalist and accurate and untiring observer though he was, he yet failed to obtain a complete insight into the true theory of reproduction in the honey bee. Believing as he did that the

eggs in the ovaries of the queen "occupy a situation corresponding to the principles that regulate her laying—the eggs of workers first and those of drones behind them," he lays it down as an axiom that "she lays the eggs of workers only during the first eleven months," although, as Dr. Dunbar says, he acknowledges that "a queen hatched in spring will perhaps lay fifty or sixty eggs of drones in whole during the course of the ensuing summer."

We, however, who in these later days have the advantage of being familiar with Dzierzon's great discovery of parthenogenesis, which, as has been said by the esteemed correspondent to whose inquiries I am now replying, so completely "explains the unexplainable," can have little difficulty in understanding why a recently-fecundated queen with an overflowing spermatheca may not readily be disposed to exercise her power of withholding from her eggs a portion of the contents of her teeming receptacle; whilst on the other hand an almost superannuated queen with a nearly exhausted spermatheca may readily lay unfecundated or drone eggs on very slight provocation.

Those rare cases yet remain to be considered in which young and perfectly fertile queens commence by laying drone eggs. Two such instances have come under my own observation. In the first, the queen laid worker and drone eggs promiscuously in worker cells, which when sealed over presented a singularly irregular appearance. In the second some hundreds of drone eggs only were methodically deposited in worker cells: these were nursed to maturity and then expelled by the bees. In both cases this abnormal drone-production soon came to an end, and the queens afterwards fulfilled their functions with perfect regularity.

Having thus afforded all the information in my power in reply to "R. S.," I hope that others among the able apiarian correspondents of THE JOURNAL OF HORTICULTURE will favour us with the results of their experience on this interesting point in the natural history of the honey bee.—A DEVONSHIRE BEE-KEEPER.

EXTRAORDINARY LIGURIAN SWARMS.

IN 1862 I was fortunate enough to obtain a Ligurian stock from "A DEVONSHIRE BEE-KEEPER," through Messrs. Neighbour & Son. Last year it threw a very strong swarm, though rather late; yet in the autumn it weighed 42 lbs. nett.

This year the cast of 1863 gave a swarm, on May 18th, of the great weight of 8 lbs. Yesterday I weighed the swarm, and found it 22 lbs. in weight; and, to my astonishment, I was awakened this morning (Monday, June 20th), at 7.45, by the sound of bees swarming. It turned out to be this swarm, of May last, casting a virgin swarm, weight over 5 lbs. Perhaps such an instance of the prolific character of the Italian bee may be worth recording in your pages.

I attribute the great weight of the May swarm to my having put a super on the stock-hive, after they had been hanging out some days. They set to work in it eagerly, but three days afterwards they swarmed, and it has been ever since deserted.—A NORTHUMBERLAND BEE-KEEPER, *Sheepwash*.

[A prime swarm weighing 8 lbs., and a maiden swarm of 5 lbs., so far surpass anything of the kind we have ever met with, that we should be glad to know if they are equally unparalleled in the experience of our correspondents. It may not be unnecessary to add that the swarms were weighed with so much care, as to preclude the possibility of mistake, whilst the veracity of "A NORTHUMBERLAND BEE-KEEPER" is beyond suspicion.]

OUR LETTER BOX.

EXCHANGE OF FOWLS (*W. S.*).—Such an exchange as you mention would be a fair one, if you met with a person wishing to exchange Schright Bantams for Dorkings. The Rev. J. G. A. Baker's strain is a very good one. If the Schrights were very good you would perhaps be expected to give a trifle beside the Dorkings. We advise you to advertise.

NAME OF BIRD (*Pio Nono*).—The bird you have we should say is not a Cardinal, but the Pope Grosbeak, which is a closely allied species and very similar in size and colour of the Cardinal, but has no crest.

SECOND SWARMS (*A. W., Darlington*).—These should be left to nature and not forced by driving.



